

# Service Manual

## Inverter Pair Wall Mounted Type G-Series



**[Applied Models]**

- Inverter Pair : Heat Pump

# **Inverter Pair Wall Mounted Type G-Series**

## **●Heat Pump**

### **Indoor Units**

**FTX50GV1B**

**FTX60GV1B**

**FTX71GV1B**

### **Outdoor Units**

**RX50G2V1B**

**RX60G2V1B**

**RX71GV1B**

1. Introduction .....	V
1.1 Safety Cautions .....	v
1.2 Used Icons .....	ix
<b>Part 1 List of Functions .....</b>	<b>1</b>
1. Functions.....	2
<b>Part 2 Specifications .....</b>	<b>3</b>
1. Specifications .....	4
<b>Part 3 Printed Circuit Board Connector Wiring Diagram .....</b>	<b>6</b>
1. Printed Circuit Board Connector Wiring Diagram.....	7
1.1 Indoor Unit.....	7
1.2 Outdoor Unit.....	9
<b>Part 4 Function and Control.....</b>	<b>12</b>
1. Main Functions.....	13
1.1 Frequency Principle.....	13
1.2 Airflow Direction Control.....	15
1.3 Fan Speed Control for Indoor Units.....	16
1.4 Program Dry Operation .....	17
1.5 Automatic Operation.....	18
1.6 Thermostat Control.....	19
1.7 NIGHT SET Mode .....	20
1.8 HOME LEAVE Operation .....	21
1.9 INTELLIGENT EYE Operation .....	22
1.10 Inverter POWERFUL Operation .....	23
1.11 Other Functions.....	24
2. Function of Thermistor .....	25
3. Control Specification .....	26
3.1 Mode Hierarchy .....	26
3.2 Frequency Control.....	27
3.3 Controls at Mode Changing / Start-up.....	29
3.4 Discharge Pipe Temperature Control.....	30
3.5 Input Current Control.....	31
3.6 Freeze-up Protection Control .....	32
3.7 Heating Peak-cut Control .....	32
3.8 Outdoor Fan Control.....	33
3.9 Liquid Compression Protection Function.....	33
3.10 Defrost Control .....	33
3.11 Electronic Expansion Valve Control .....	35
3.12 Malfunctions .....	38
3.13 Forced Operation Mode .....	39
<b>Part 5 Operation Manual .....</b>	<b>40</b>
1. System Configuration.....	41
2. Operation Manual.....	42
2.1 Remote Controller .....	42

2.2	AUTO · DRY · COOL · HEAT · FAN Operation .....	43
2.3	Adjusting the Airflow Direction .....	45
2.4	POWERFUL Operation .....	47
2.5	OUTDOOR UNIT QUIET Operation .....	48
2.6	HOME LEAVE Operation .....	49
2.7	INTELLIGENT EYE Operation .....	51
2.8	TIMER Operation .....	53

## **Part 6 Service Diagnosis..... 55**

1.	Caution for Diagnosis .....	56
1.1	Troubleshooting with LED .....	56
2.	Problem Symptoms and Measures .....	57
3.	Service Check Function .....	58
4.	Troubleshooting .....	61
4.1	Error Codes and Description .....	61
4.2	Indoor Unit PCB Abnormality .....	62
4.3	Freeze-up Protection Control or Heating Peak-cut Control .....	63
4.4	Fan Motor (DC Motor) or Related Abnormality .....	64
4.5	Thermistor or Related Abnormality (Indoor Unit) .....	66
4.6	Signal Transmission Error (between Indoor Unit and Outdoor Unit) .....	67
4.7	Unspecified Voltage (between Indoor Unit and Outdoor Unit) .....	69
4.8	Outdoor Unit PCB Abnormality .....	70
4.9	OL Activation (Compressor Overload) .....	71
4.10	Compressor Lock .....	72
4.11	DC Fan Lock .....	73
4.12	Input Overcurrent Detection .....	74
4.13	Four Way Valve Abnormality .....	75
4.14	Discharge Pipe Temperature Control .....	77
4.15	High Pressure Control in Cooling .....	78
4.16	Compressor System Sensor Abnormality .....	79
4.17	Position Sensor Abnormality .....	80
4.18	CT or Related Abnormality .....	82
4.19	Thermistor or Related Abnormality (Outdoor Unit) .....	84
4.20	Electrical Box Temperature Rise .....	86
4.21	Radiation Fin Temperature Rise .....	88
4.22	Output Overcurrent Detection .....	90
4.23	Refrigerant Shortage .....	92
4.24	Low-voltage Detection or Over-voltage Detection .....	94
4.25	Signal Transmission Error on Outdoor Unit PCB .....	95
5.	Check .....	96
5.1	How to Check .....	96

## **Part 7 Removal Procedure ..... 103**

1.	Indoor Unit .....	104
1.1	Removal of Air Filter / Front Panel .....	104
1.2	Removal of Front Grille .....	107
1.3	Removal of Horizontal Blades / Vertical Blades .....	109
1.4	Removal of Electrical Box / PCB / Swing Motor .....	111
1.5	Removal of Indoor Heat Exchanger .....	117
1.6	Removal of Fan Rotor / Fan Motor .....	120







---

2. Outdoor Unit - RX50/60G2V1B .....	122
2.1 Removal of Outer Panels .....	122
2.2 Removal of Fan Motor / Outdoor Fan.....	126
2.3 Removal of Electrical Box .....	130
2.4 Removal of PCB.....	134
2.5 Removal of Sound Blanket / Thermistors.....	137
2.6 Removal of Four Way Valve.....	139
2.7 Removal of Electronic Expansion Valve.....	140
2.8 Removal of Compressor.....	141
3. Outdoor Unit - RX71GV1B .....	144
3.1 Removal of Outer Panels .....	144
3.2 Removal of Electrical Box .....	159
3.3 Removal of PCB.....	163
3.4 Removal of Fan Motor.....	166
3.5 Removal of Coils / Thermistors .....	167
3.6 Removal of Sound Blanket.....	170
3.7 Removal of Compressor.....	173
<b>Part 8 Others .....</b>	<b>174</b>
1. Others .....	175
1.1 Trial Operation.....	175
1.2 Field Settings.....	176
1.3 Application of Silicon Grease to a Power Transistor and a Diode Bridge.....	177
<b>Part 9 Appendix.....</b>	<b>178</b>
1. Piping Diagrams.....	179
1.1 Indoor Unit.....	179
1.2 Outdoor Unit.....	180
2. Wiring Diagrams.....	181
2.1 Indoor Unit.....	181
2.2 Outdoor Unit.....	181







# 1. Introduction



## 1.1 Safety Cautions









### Cautions and Warnings

- Be sure to read the following safety cautions before conducting repair work.
- The caution items are classified into “ **Warning**” and “ **Caution**”. The “ **Warning**” items are especially important since they can lead to death or serious injury if they are not followed closely. The “ **Caution**” items can also lead to serious accidents under some conditions if they are not followed. Therefore, be sure to observe all the safety caution items described below.
- About the pictograms
  - △ This symbol indicates the item for which caution must be exercised.  
The pictogram shows the item to which attention must be paid.
  - This symbol indicates the prohibited action.  
The prohibited item or action is shown in the illustration or near the symbol.
  - This symbol indicates the action that must be taken, or the instruction.  
The instruction is shown in the illustration or near the symbol.
- After the repair work is complete, be sure to conduct a test operation to ensure that the equipment operates normally, and explain the cautions for operating the product to the customer.











### 1.1.1 Cautions Regarding Safety of Workers





 <b>Warning</b>	
<p>Be sure to disconnect the power cable plug from the plug socket before disassembling the equipment for repair. Working on the equipment that is connected to the power supply may cause an electrical shock. If it is necessary to supply power to the equipment to conduct the repair or inspecting the circuits, do not touch any electrically charged sections of the equipment.</p>	
<p>If the refrigerant gas is discharged during the repair work, do not touch the discharged refrigerant gas. The refrigerant gas may cause frostbite.</p>	
<p>When disconnecting the suction or discharge pipe of the compressor at the welded section, evacuate the refrigerant gas completely at a well-ventilated place first. If there is a gas remaining inside the compressor, the refrigerant gas or refrigerating machine oil discharges when the pipe is disconnected, and it may cause injury.</p>	
<p>If the refrigerant gas leaks during the repair work, ventilate the area. The refrigerant gas may generate toxic gases when it contacts flames.</p>	
<p>The step-up capacitor supplies high-voltage electricity to the electrical components of the outdoor unit. Be sure to discharge the capacitor completely before conducting repair work. A charged capacitor may cause an electrical shock.</p>	
<p>Do not start or stop the air conditioner operation by plugging or unplugging the power cable plug. Plugging or unplugging the power cable plug to operate the equipment may cause an electrical shock or fire.</p>	







 <b>Warning</b>	
Be sure to wear a safety helmet, gloves, and a safety belt when working at a high place (more than 2 m). Insufficient safety measures may cause a fall accident.	
In case of R-410A refrigerant models, be sure to use pipes, flare nuts and tools for the exclusive use of the R-410A refrigerant. The use of materials for R-22 refrigerant models may cause a serious accident such as a damage of refrigerant cycle as well as an equipment failure.	





 <b>Caution</b>	
Do not repair the electrical components with wet hands. Working on the equipment with wet hands may cause an electrical shock.	
Do not clean the air conditioner by splashing water. Washing the unit with water may cause an electrical shock.	
Be sure to provide the grounding when repairing the equipment in a humid or wet place, to avoid electrical shocks.	
Be sure to turn off the power switch and unplug the power cable when cleaning the equipment. The internal fan rotates at a high speed, and cause injury.	
Be sure to conduct repair work with appropriate tools. The use of inappropriate tools may cause injury.	
Be sure to check that the refrigerating cycle section has cooled down enough before conducting repair work. Working on the unit when the refrigerating cycle section is hot may cause burns.	
Use the welder in a well-ventilated place. Using the welder in an enclosed room may cause oxygen deficiency.	

## 1.1.2 Cautions Regarding Safety of Users

 <b>Warning</b>	
<p>Be sure to use parts listed in the service parts list of the applicable model and appropriate tools to conduct repair work. Never attempt to modify the equipment. The use of inappropriate parts or tools may cause an electrical shock, excessive heat generation or fire.</p>	
<p>If the power cable and lead wires have scratches or deteriorated, be sure to replace them. Damaged cable and wires may cause an electrical shock, excessive heat generation or fire.</p>	
<p>Do not use a joined power cable or extension cable, or share the same power outlet with other electrical appliances, since it may cause an electrical shock, excessive heat generation or fire.</p>	
<p>Be sure to use an exclusive power circuit for the equipment, and follow the local technical standards related to the electrical equipment, the internal wiring regulations, and the instruction manual for installation when conducting electrical work. Insufficient power circuit capacity and improper electrical work may cause an electrical shock or fire.</p>	
<p>Be sure to use the specified cable for wiring between the indoor and outdoor units. Make the connections securely and route the cable properly so that there is no force pulling the cable at the connection terminals. Improper connections may cause excessive heat generation or fire.</p>	
<p>When wiring between the indoor and outdoor units, make sure that the terminal cover does not lift off or dismount because of the cable. If the cover is not mounted properly, the terminal connection section may cause an electrical shock, excessive heat generation or fire.</p>	
<p>Do not damage or modify the power cable. Damaged or modified power cable may cause an electrical shock or fire. Placing heavy items on the power cable, and heating or pulling the power cable may damage the cable.</p>	
<p>Do not mix air or gas other than the specified refrigerant (R-410A / R-22) in the refrigerant system. If air enters the refrigerating system, an excessively high pressure results, causing equipment damage and injury.</p>	
<p>If the refrigerant gas leaks, be sure to locate the leaking point and repair it before charging the refrigerant. After charging refrigerant, make sure that there is no refrigerant leak. If the leaking point cannot be located and the repair work must be stopped, be sure to perform pump-down and close the service valve, to prevent the refrigerant gas from leaking into the room. The refrigerant gas itself is harmless, but it may generate toxic gases when it contacts flames, such as fan and other heaters, stoves and ranges.</p>	
<p>When relocating the equipment, make sure that the new installation site has sufficient strength to withstand the weight of the equipment. If the installation site does not have sufficient strength and if the installation work is not conducted securely, the equipment may fall and cause injury.</p>	





 <b>Warning</b>	
Check to make sure that the power cable plug is not dirty or loose, then insert the plug into a power outlet securely. If the plug has dust or loose connection, it may cause an electrical shock or fire.	
Be sure to install the product correctly by using the provided standard installation frame. Incorrect use of the installation frame and improper installation may cause the equipment to fall, resulting in injury.	For unitary type only 
Be sure to install the product securely in the installation frame mounted on the window frame. If the unit is not securely mounted, it may fall and cause injury.	For unitary type only 
When replacing the coin battery in the remote controller, be sure to disposed of the old battery to prevent children from swallowing it. If a child swallows the coin battery, see a doctor immediately.	

 <b>Caution</b>	
Installation of a leakage breaker is necessary in some cases depending on the conditions of the installation site, to prevent electrical shocks.	
Do not install the equipment in a place where there is a possibility of combustible gas leaks. If the combustible gas leaks and remains around the unit, it may cause a fire.	
Check to see if the parts and wires are mounted and connected properly, and if the connections at the soldered or crimped terminals are secure. Improper installation and connections may cause excessive heat generation, fire or an electrical shock.	
If the installation platform or frame has corroded, replace it. Corroded installation platform or frame may cause the unit to fall, resulting in injury.	
Check the grounding, and repair it if the equipment is not properly grounded. Improper grounding may cause an electrical shock.	

 <b>Caution</b>	
Be sure to measure the insulation resistance after the repair, and make sure that the resistance is 1 MΩ or higher. Faulty insulation may cause an electrical shock.	
Be sure to check the drainage of the indoor unit after the repair. Faulty drainage may cause the water to enter the room and wet the furniture and floor.	
Do not tilt the unit when removing it. The water inside the unit may spill and wet the furniture and floor.	
Be sure to install the packing and seal on the installation frame properly. If the packing and seal are not installed properly, water may enter the room and wet the furniture and floor.	For unitary type only  

## 1.2 Used Icons

Icons are used to attract the attention of the reader to specific information. The meaning of each icon is described in the table below:

Icon	Type of Information	Description
 Note:	Note	A “note” provides information that is not indispensable, but may nevertheless be valuable to the reader, such as tips and tricks.
 Caution	Caution	A “caution” is used when there is danger that the reader, through incorrect manipulation, may damage equipment, lose data, get an unexpected result or has to restart (part of) a procedure.
 Warning	Warning	A “warning” is used when there is danger of personal injury.
	Reference	A “reference” guides the reader to other places in this binder or in this manual, where he/she will find additional information on a specific topic.

# Part 1

# List of Functions

1. Functions.....2

# 1. Functions

Category	Functions	FTX50/60/71GV1B RX50/60G2V1B RX71GV1B	Category	Functions	FTX50/60/71GV1B RX50/60G2V1B RX71GV1B
Basic Function	Inverter (with Inverter Power Control)	○	Health & Clean	Air-Purifying Filter	—
	Operation Limit for Cooling (°CDB)	-10 ~46		Photocatalytic Deodorizing Filter	—
	Operation Limit for Heating (°CWB)	-15 ~18		Air-Purifying Filter with Photocatalytic Deodorizing Function	—
	PAM Control	○		Titanium Apatite Photocatalytic Air-Purifying Filter	○
Compressor	Oval Scroll Compressor	—	Air Filter (Prefilter)	○	
	Swing Compressor	○	Wipe-Clean Flat Panel	○	
	Rotary Compressor	—	Washable Grille	—	
	Reluctance DC Motor	○	Mold Proof Operation	—	
Comfortable Airflow	Power-Airflow Flap	—	Heating Dry Operation	—	
	Power-Airflow Dual Flaps	○	Good-Sleep Cooling Operation	—	
	Power-Airflow Diffuser	—	Timer	WEEKLY TIMER Operation	—
	Wide-Angle Louvers	○		24-Hour ON/OFF TIMER	○
	Vertical Auto-Swing (Up and Down)	○		NIGHT SET Mode	○
	Horizontal Auto-Swing (Right and Left)	○	Worry Free "Reliability & Durability"	Auto-Restart (after Power Failure)	○
	3-D Airflow	○		Self-Diagnosis (Digital, LED) Display	○
	COMFORT AIRFLOW Operation	—		Wiring Error Check	—
Comfort Control	Auto Fan Speed	○	Flexibility	Anti-Corrosion Treatment of Outdoor Heat Exchanger	○
	Indoor Unit Quiet Operation	○		Multi-Split / Split Type Compatible Indoor Unit	—
	NIGHT QUIET Mode (Automatic)	—		Flexible Voltage Correspondence	—
	OUTDOOR UNIT QUIET Operation (Manual)	○	High Ceiling Application	—	
	INTELLIGENT EYE Operation	○	Chargeless	10 m	
	Quick Warming Function (Preheating Operation)	○	Either Side Drain (Right or Left)	○	
	Hot-Start Function	○	Power Selection	—	
	Automatic Defrosting	○	Remote Control	5-Rooms Centralized Controller (Option)	○
Operation	Automatic Operation	○		Remote Control Adaptor (Normal Open Pulse Contact) (Option)	○
	Program Dry Operation	○		Remote Control Adaptor (Normal Open Contact) (Option)	○
	Fan Only	○	DIII-NET Compatible (Adaptor) (Option)	○	
Lifestyle Convenience	New POWERFUL Operation (Non-Inverter)	—	Remote Controller	Wireless	○
	Inverter POWERFUL Operation	○		Wired (Option)	○
	Priority-Room Setting	—			
	COOL / HEAT Mode Lock	—			
	HOME LEAVE Operation	○			
	ECONO Operation	—			
	Indoor Unit ON/OFF Button	○			
	Signal Receiving Sign	○			
	R / C with Back Light	—			
Temperature Display	—				

**Note:** ○ : Holding Functions  
 — : No Functions



# Part 2 Specifications

1. Specifications .....4

# 1. Specifications

50 Hz, 220 - 230 - 240 V

Model	Indoor Units		FTX50GV1B		FTX60GV1B	
	Outdoor Units		RX50G2V1B		RX60G2V1B	
			Cooling	Heating	Cooling	Heating
Capacity Rated (Min. ~ Max.)	kW		5.0 (1.7 ~ 6.0)	5.8 (1.7 ~ 7.7)	6.0 (1.7 ~ 6.7)	7.0 (1.7 ~ 8.0)
	Btu/h		17,100 (5,800 ~ 20,500)	19,800 (5,800 ~ 26,300)	20,500 (5,800 ~ 22,900)	23,900 (5,800 ~ 27,300)
	kcal/h		4,300 (1,460 ~ 5,160)	4,990 (1,460 ~ 6,620)	5,160 (1,460 ~ 5,760)	6,020 (1,460 ~ 6,880)
Running Current Rated	A		7.2 - 6.9 - 6.6	7.4 - 7.1 - 6.8	9.2 - 8.8 - 8.4	9.4 - 9.0 - 8.6
Power Consumption Rated (Min. ~ Max.)	W		1,550 (440 ~ 2,080)	1,600 (400 ~ 2,530)	1,990 (440 ~ 2,400)	2,040 (400 ~ 2,810)
Power Factor	%		97.9 - 97.7 - 97.9	98.3 - 98.0 - 98.0	98.3 - 98.3 - 98.7	98.6 - 98.6 - 98.8
COP Rated (Min. ~ Max.)	W/W		3.23 (3.86 ~ 2.88)	3.63 (4.25 ~ 3.04)	3.02 (3.86 ~ 2.79)	3.43 (4.25 ~ 2.85)
Piping Connections	Liquid	mm	φ 6.4		φ 6.4	
	Gas	mm	φ 12.7		φ 12.7	
	Drain	mm	φ 18.0		φ 18.0	
Heat Insulation			Both Liquid and Gas Pipes		Both Liquid and Gas Pipes	
Max. Interunit Piping Length	m		30		30	
Max. Interunit Height Difference	m		20		20	
Chargeless	m		10		10	
Amount of Additional Charge of Refrigerant	g/m		20		20	
<b>Indoor Unit</b>			<b>FTX50GV1B</b>		<b>FTX60GV1B</b>	
Front Panel Color			White		White	
Airflow Rate	m³/min (cfm)	H	14.7 (519)	16.1 (568)	16.2 (572)	17.4 (614)
		M	12.4 (438)	13.9 (491)	13.6 (480)	15.1 (533)
		L	10.3 (364)	11.5 (406)	11.4 (403)	12.7 (448)
		SL	9.5 (335)	10.2 (360)	10.2 (360)	11.4 (403)
Fan	Type	Cross Flow Fan		Cross Flow Fan		
	Motor Output	W	43		43	
	Speed	Steps	5 Steps, Quiet, Auto		5 Steps, Quiet, Auto	
Air Direction Control			Right, Left, Horizontal, Downward		Right, Left, Horizontal, Downward	
Air Filter			Removable / Washable / Mildew Proof		Removable / Washable / Mildew Proof	
Running Current (Rated)	A		0.16 - 0.15 - 0.15	0.17 - 0.16 - 0.16	0.19 - 0.18 - 0.17	0.21 - 0.20 - 0.19
Power Consumption (Rated)	W		34	36	40	45
Power Factor	%		96.6 - 98.6 - 94.4	96.3 - 97.8 - 93.8	95.7 - 96.6 - 98.0	97.4 - 97.8 - 98.7
Temperature Control			Microcomputer Control		Microcomputer Control	
Dimensions (H x W x D)	mm		290 x 1,050 x 238		290 x 1,050 x 238	
Packaged Dimensions (H x W x D)	mm		337 x 1,147 x 366		337 x 1,147 x 366	
Weight	kg		12		12	
Gross Weight	kg		17		17	
Operation Sound	H / M / L / SL	dBA	43 / 39 / 34 / 31	42 / 38 / 33 / 30	45 / 41 / 36 / 33	44 / 40 / 35 / 32
Sound Power		dBA	59	58	61	60
<b>Outdoor Unit</b>			<b>RX50G2V1B</b>		<b>RX60G2V1B</b>	
Casing Color			Ivory White		Ivory White	
Compressor	Type	Hermetically Sealed Swing Type		Hermetically Sealed Swing Type		
	Model	2YC36BXD		2YC36BXD		
Refrigerant	Type	FVC50K		FVC50K		
Oil	Charge	L	0.65		0.65	
Refrigerant	Type	R-410A		R-410A		
	Charge	kg	1.50		1.50	
Airflow Rate	m³/min (cfm)	HH	50.9 (1,797)	—	54.2 (1,914)	—
		H	48.9 (1,727)	45.0 (1,589)	50.9 (1,797)	46.3 (1,635)
		SL	41.7 (1,472)		42.4 (1,497)	
Fan	Type	Propeller		Propeller		
	Motor Output	W	53		53	
Running Current (Rated)	A		7.04 - 6.75 - 6.45	7.23 - 6.94 - 6.64	9.01 - 8.62 - 8.23	9.19 - 8.80 - 8.41
Power Consumption (Rated)	W		1,516	1,564	1,950	1,995
Power Factor	%		97.9 - 97.6 - 97.9	98.3 - 98.0 - 98.1	98.4 - 98.4 - 98.7	98.7 - 98.6 - 98.8
Starting Current	A		7.4		9.4	
Dimensions (H x W x D)	mm		735 x 825 x 300		735 x 825 x 300	
Packaged Dimensions (H x W x D)	mm		797 x 960 x 390		797 x 960 x 390	
Weight	kg		48		48	
Gross Weight	kg		53		53	
Operation Sound	H / SL	dBA	47 / 44	48 / 45	49 / 46	49 / 46
Sound Power	H	dBA	61	62	63	63
Drawing No.			3D066639A		3D066640A	

**Note:** ■ The data are based on the conditions shown in the table below.

Cooling	Heating	Piping Length
Indoor ; 27°CDB / 19°CWB Outdoor ; 35°CDB / 24°CWB	Indoor ; 20°CDB Outdoor ; 7°CDB / 6°CWB	5 m

Conversion Formulae
kcal/h = kW × 860 Btu/h = kW × 3412 cfm = m³/min × 35.3

50 Hz, 220 - 230 - 240V

Model	Indoor Units		FTX71GV1B	
	Outdoor Units		RX71GV1B	
			Cooling	Heating
Capacity Rated (Min. ~ Max.)	kW		7.1 (2.3 ~ 8.5)	8.2 (2.3 ~ 10.2)
	Btu/h		24,200 (7,800 ~ 29,000)	28,000 (7,800 ~ 34,800)
	kcal/h		6,110 (1,980 ~ 7,310)	7,050 (1,980 ~ 8,770)
Running Current Rated	A		10.8 - 10.4 - 9.9	11.7 - 11.2 - 10.7
Power Consumption Rated (Min. ~ Max.)	W		2,350 (570 ~ 3,200)	2,550 (520 ~ 3,820)
Power Factor	%		98.9 - 98.2 - 98.9	99.1 - 99.0 - 99.3
COP Rated (Min. ~ Max.)	W/W		3.02 (4.04 ~ 2.66)	3.22 (4.42 ~ 2.67)
Piping Connections	Liquid	mm	φ 6.4	
	Gas	mm	φ 15.9	
	Drain	mm	φ 18.0	
Heat Insulation			Both Liquid and Gas Pipes	
Max. Interunit Piping Length		m	30	
Max. Interunit Height Difference		m	20	
Chargeless		m	10	
Amount of Additional Charge of Refrigerant		g/m	20	
Indoor Unit			FTX71GV1B	
Front Panel Color			White	
Airflow Rate	m³/min (cfm)	H	17.4 (614)	19.7 (696)
		M	14.6 (516)	16.9 (597)
		L	11.6 (410)	14.3 (505)
		SL	10.6 (374)	12.7 (448)
Fan	Type		Cross Flow Fan	
	Motor Output	W	43	
	Speed	Steps	5 Steps, Quiet, Auto	
Air Direction Control			Right, Left, Horizontal, Downward	
Air Filter			Removable / Washable / Mildew Proof	
Running Current (Rated)	A		0.21 - 0.20 - 0.19	0.28 - 0.27 - 0.26
Power Consumption (Rated)	W		45	60
Power Factor	%		97.4 - 97.8 - 98.7	97.4 - 96.6 - 96.2
Temperature Control			Microcomputer Control	
Dimensions (H x W x D)		mm	290 x 1,050 x 238	
Packaged Dimensions (H x W x D)		mm	337 x 1,147 x 366	
Weight		kg	12	
Gross Weight		kg	17	
Operation Sound	H / M / L / SL	dBA	46 / 42 / 37 / 34	46 / 42 / 37 / 34
Sound Power		dBA	62	62
Outdoor Unit			RX71GV1B	
Casing Color			Ivory White	
Compressor	Type		Hermetically Sealed Swing Type	
	Model		2YC63BXD	
	Motor Output	W	1,920	
Refrigerant Oil	Type		FVC50K	
	Charge	L	0.75	
Refrigerant	Type		R-410A	
	Charge	kg	2.30	
Airflow Rate	m³/min (cfm)	HH	57.1 (2,016)	—
		H	54.5 (1,924)	46.0 (1,624)
		SL		46.0 (1,624)
Fan	Type		Propeller	
	Motor Output	W	66	
Running Current (Rated)	A		10.59 - 10.20 - 9.71	11.42 - 10.93 - 10.44
Power Consumption (Rated)	W		2,305	2,490
Power Factor	%		98.9 - 98.3 - 98.9	99.1 - 99.0 - 99.4
Starting Current			11.7	
Dimensions (H x W x D)		mm	770 x 900 x 320	
Packaged Dimensions (H x W x D)		mm	900 x 925 x 390	
Weight		kg	71	
Gross Weight		kg	79	
Operation Sound	H / SL	dBA	52 / 49	52 / 49
Sound Power	H	dBA	66	66
Drawing No.			3D066641	

**Note:** ■ The data are based on the conditions shown in the table below.

Cooling	Heating	Piping Length
Indoor ; 27°CDB / 19°CWB Outdoor ; 35°CDB / 24°CWB	Indoor ; 20°CDB Outdoor ; 7°CDB / 6°CWB	5 m

Conversion Formulae
kcal/h = kW x 860 Btu/h = kW x 3412 cfm = m³/min x 35.3

# Part 3 Printed Circuit Board Connector Wiring Diagram

1. Printed Circuit Board Connector Wiring Diagram.....	7
1.1 Indoor Unit.....	7
1.2 Outdoor Unit.....	9

# 1. Printed Circuit Board Connector Wiring Diagram

## 1.1 Indoor Unit

### Connectors and Other Parts

#### PCB (1): Control PCB

1) S1	Connector for DC fan motor
2) S6	Connector for swing motor (horizontal blades)
3) S8	Connector for swing motor (vertical blades)
4) S21	Connector for centralized control (HA)
5) S26	Connector for buzzer PCB
6) S28	Connector for signal receiver PCB
7) S32	Connector for indoor heat exchanger thermistor
8) S35	Connector for INTELLIGENT EYE sensor PCB
9) H1, H2, H3, FG	Connector for terminal board
10)JA	Address setting jumper
JB	Fan speed setting when compressor stops for thermostat OFF
JC	Power failure recovery function (auto-restart) * Refer to page 176 for detail.
11)LED A	LED for service monitor (green)
12)FU1	Fuse (3.15 A, 250 V)
13)V1	Varistor

#### PCB (2): Signal Receiver PCB

1) S29	Connector for control PCB
2) SW1 (S1W)	Forced operation ON/OFF button

#### PCB (3): Buzzer PCB

1) S27	Connector for control PCB
2) S38	Connector for display PCB
3) RTH1 (R1T)	Room temperature thermistor

#### PCB (4): Display PCB

1) S37	Connector for buzzer PCB
2) LED1 (H1P)	LED for operation (green)
3) LED2 (H2P)	LED for timer (yellow)
4) LED3 (H3P)	LED for HOME LEAVE operation (red)

#### PCB (5): INTELLIGENT EYE Sensor PCB

1) S36	Connector for control PCB
--------	---------------------------

PCB Detail

PCB (1): Control PCB

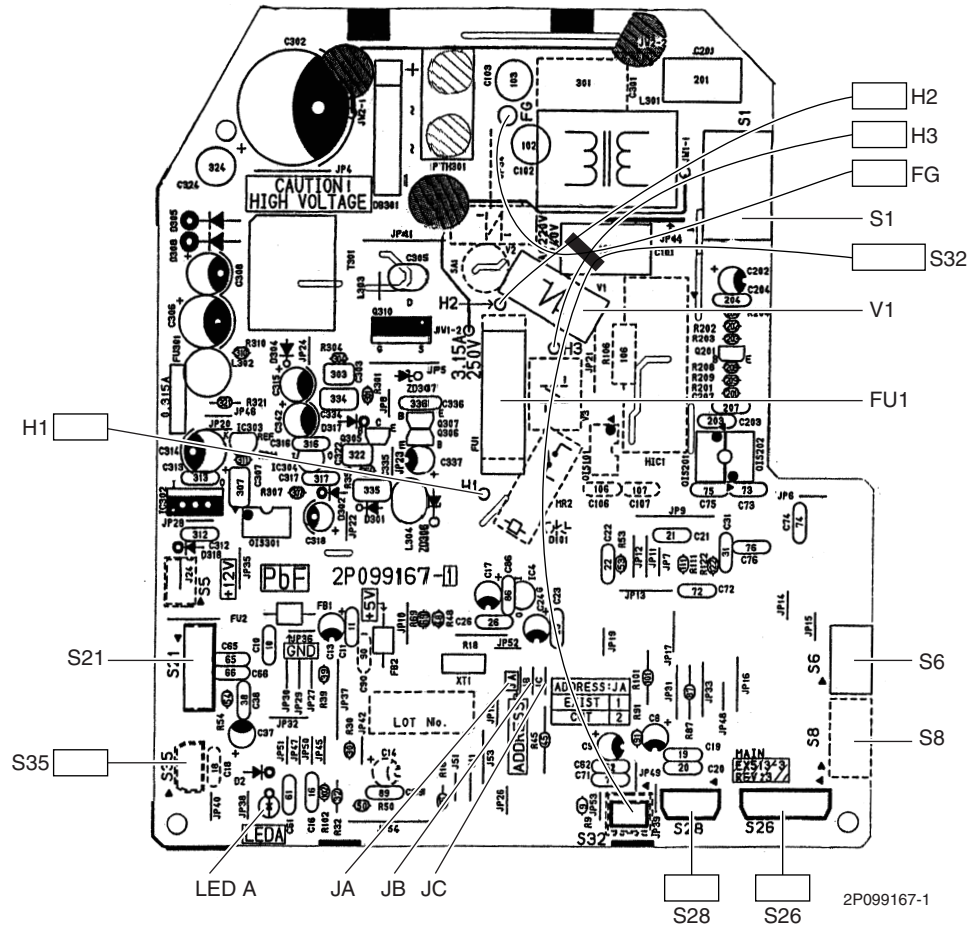

PCB (2): Signal Receiver PCB

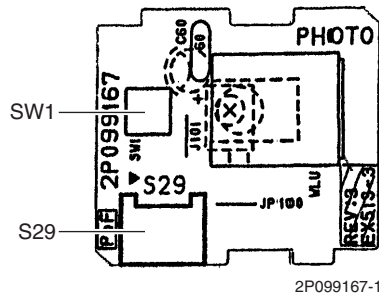

PCB (3): Buzzer PCB

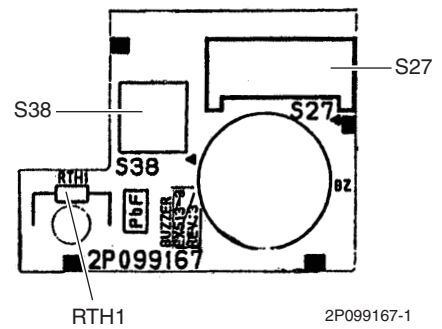

PCB (4): Display PCB

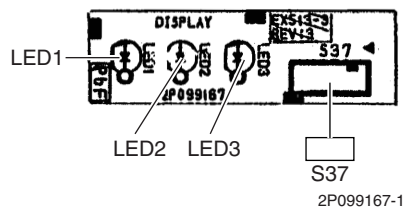

PCB (5): INTELLIGENT EYE Sensor PCB

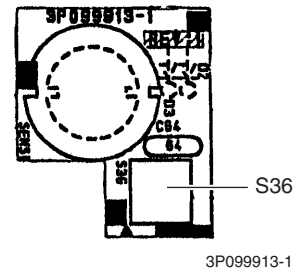

## 1.2 Outdoor Unit

### Connectors and Other Parts

#### PCB (1): Main PCB

1) S10	Connector for terminal board (indoor - outdoor transmission)
2) S20	Connector for electronic expansion valve coil
3) S40	Connector for overload protector
4) S51, S101	Connector for service monitor PCB
5) S70	Connector for fan motor
6) S80	Connector for four way valve coil
7) S90	Connector for thermistors (outdoor temperature, outdoor heat exchanger, discharge pipe)
8) AC1, AC2	Connector for terminal board (power supply)
9) HR1, HR2	Connector for reactor
10) E1, E2	Connector for earth
11) U, V, W	Connector for compressor
12) FU1	Fuse (30 A, 250 V)
13) FU2, FU3	Fuse (3.15 A, 250 V)
14) V2, V3, V5	Varistor
V6, V11	(for 50/60 model)
V9, V100	(for 71 model)

#### PCB (2): Service Monitor PCB

1) S52, S102	Connector for main PCB
2) LED A	LED for service monitor (green)
3) SW1	Forced operation ON/OFF button
4) SW4-C	Switch for improvement of defrost performance * Refer to page 176 for detail.





PCB (2): Service Monitor PCB

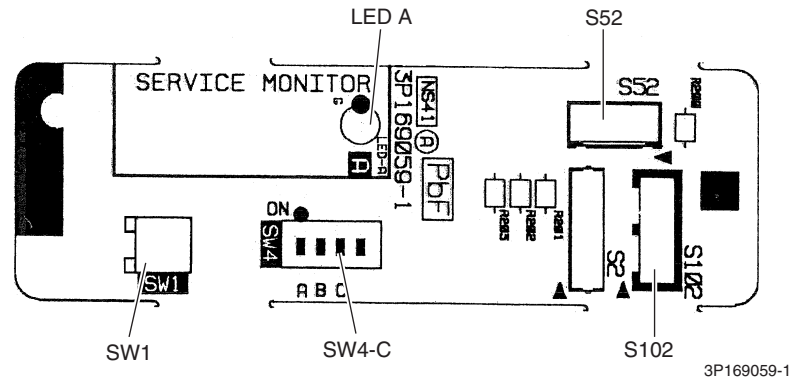

---

# Part 4

## Function and Control

1. Main Functions.....	13
1.1 Frequency Principle.....	13
1.2 Airflow Direction Control.....	15
1.3 Fan Speed Control for Indoor Units.....	16
1.4 Program Dry Operation .....	17
1.5 Automatic Operation.....	18
1.6 Thermostat Control.....	19
1.7 NIGHT SET Mode .....	20
1.8 HOME LEAVE Operation .....	21
1.9 INTELLIGENT EYE Operation .....	22
1.10 Inverter POWERFUL Operation .....	23
1.11 Other Functions.....	24
2. Function of Thermistor .....	25
3. Control Specification .....	26
3.1 Mode Hierarchy .....	26
3.2 Frequency Control.....	27
3.3 Controls at Mode Changing / Start-up.....	29
3.4 Discharge Pipe Temperature Control.....	30
3.5 Input Current Control.....	31
3.6 Freeze-up Protection Control .....	32
3.7 Heating Peak-cut Control .....	32
3.8 Outdoor Fan Control.....	33
3.9 Liquid Compression Protection Function.....	33
3.10 Defrost Control .....	33
3.11 Electronic Expansion Valve Control .....	35
3.12 Malfunctions .....	38
3.13 Forced Operation Mode .....	39

# 1. Main Functions

## 1.1 Frequency Principle

**Main Control Parameters**

The compressor is frequency-controlled during normal operation. The target frequency is set by the following 2 parameters coming from the operating indoor unit:

- The load condition of the operating indoor unit
- The difference between the room temperature and the target temperature

**Additional Control Parameters**

The target frequency is adapted by additional parameters in the following cases:

- Frequency restrictions
- Initial settings
- Forced cooling operation

**Inverter Principle**

To regulate the capacity, a frequency control is needed. The inverter makes it possible to vary the rotation speed of the compressor. The following table explains the conversion principle:

Phase	Description
1	The supplied AC power source is converted into the DC power source for the present.
2	The DC power source is reconverted into the three phase AC power source with variable frequency. <ul style="list-style-type: none"> <li>■ When the frequency increases, the rotation speed of the compressor increases resulting in an increased refrigerant circulation. This leads to a higher amount of the heat exchange per unit.</li> <li>■ When the frequency decreases, the rotation speed of the compressor decreases resulting in a decreased refrigerant circulation. This leads to a lower amount of the heat exchange per unit.</li> </ul>

**Drawing of Inverter**

The following drawing shows a schematic view of the inverter principle:

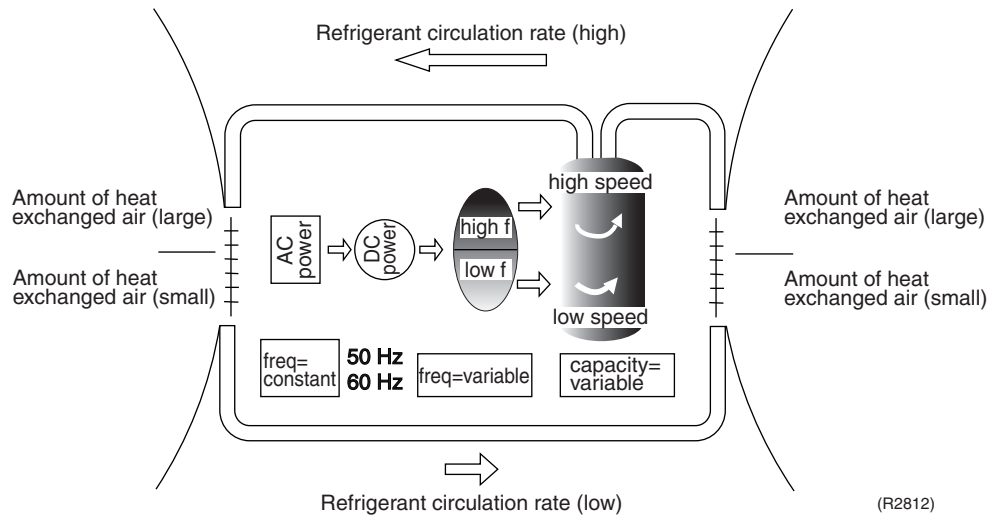

**Inverter Features**

The inverter provides the following features:

- The regulating capacity can be changed according to the changes in the outdoor temperature and cooling / heating load.
- Quick heating and quick cooling  
The compressor rotational speed is increased when starting the heating (or cooling). This enables to reach the set temperature quickly.
- Even during extreme cold weather, the high capacity is achieved. It is maintained even when the outdoor temperature is 2°C.
- Comfortable air conditioning  
A fine adjustment is integrated to keep the room temperature constant.
- Energy saving heating and cooling  
Once the set temperature is reached, the energy saving operation enables to maintain the room temperature at low power.

**Frequency Limits**

The following functions regulate the minimum and maximum frequency:

Frequency	Functions
Low	<ul style="list-style-type: none"> <li>■ Four way valve operation compensation. Refer to page 29.</li> </ul>
High	<ul style="list-style-type: none"> <li>■ Compressor protection function. Refer to page 30.</li> <li>■ Discharge pipe temperature control. Refer to page 30.</li> <li>■ Input current control. Refer to page 31.</li> <li>■ Freeze-up protection control. Refer to page 32.</li> <li>■ Heating peak-cut control. Refer to page 32.</li> <li>■ Defrost control. Refer to page 33.</li> </ul>

**Forced Cooling Operation**

Refer to "Forced operation mode" on page 39 for detail.

## 1.2 Airflow Direction Control

### Power-Airflow Dual Flaps

The large flaps send a large volume of air downwards to the floor. The flap provides an optimum control in cooling, dry, and heating mode.

#### Cooling / Dry Mode

During cooling or dry mode, the flap retracts into the indoor unit. Then, cool air can be blown far and pervaded all over the room.

#### Heating Mode

During heating mode, the large flap directs airflow downwards to spread the warm air to the entire room.

### Wide-Angle Louvers

The louvers, made of elastic synthetic resin, provide a wide range of airflow that guarantees a comfortable air distribution.

### Auto-Swing

The following table explains the auto-swing process for cooling, dry, heating, and fan :

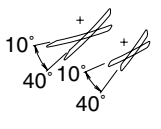
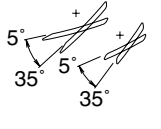
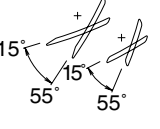
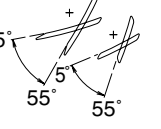
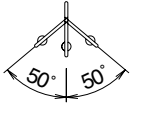
Vertical Swing (up and down)				Horizontal Swing (right and left)
Cooling	Dry	Heating	Fan	
				

### 3-D Airflow

Alternative repetition of vertical and horizontal swing motions enables uniform air-conditioning of the entire room. This function is effective for starting the air conditioner.

When the horizontal swing and vertical swing are both set to auto mode, the airflow becomes 3-D airflow and the horizontal swing and vertical swing motions are alternated. The order of swing motion is such that it turns counterclockwise, starting from the right upper point as viewed from the front side of the indoor unit.



## 1.3 Fan Speed Control for Indoor Units

### Outline



Phase control and fan speed control contains 9 steps: LLL, LL, SL, L, ML, M, MH, H, and HH. The airflow rate can be automatically controlled depending on the difference between the room temperature and the target temperature. This is done through phase control and Hall IC control.



For more information about Hall IC, refer to the troubleshooting for fan motor on page 64.

### Automatic Fan Speed Control

In automatic fan speed operation, the step "SL" is not available.

Step	Cooling	Heating
LLL	 (R11967)	 (R11379)
LL		
L		
ML		
M		
MH		
H		
HH (POWERFUL)		

 = The airflow rate is automatically controlled within this range when the FAN setting button is set to automatic.

#### <Cooling>

The following drawing explains the principle of fan speed control for cooling.

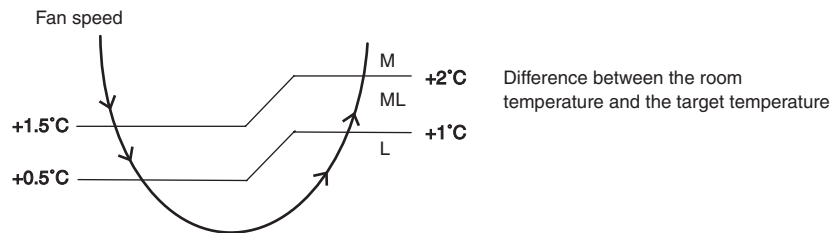

#### <Heating>

On heating mode, the fan speed is regulated according to the indoor heat exchanger temperature and the difference between the room temperature and the target temperature.



#### Note:

1. During POWERFUL operation, fan rotates at H tap + 90 rpm.
2. Fan stops during defrost operation.
3. In time of thermostat OFF, the fan rotates at the following speed.  
Cooling: The fan keeps rotating at the set tap.  
Heating: The fan keeps rotating at LLL tap.

## 1.4 Program Dry Operation

### Outline

Program dry operation removes humidity while preventing the room temperature from lowering. Since the microcomputer controls both the temperature and airflow rate, the temperature adjustment and fan adjustment buttons are inoperable in this mode.

### Detail

The microcomputer automatically sets the temperature and airflow rate. The difference between the room temperature at start-up and the target temperature is divided into two zones. Then, the unit operates in the dry mode with an appropriate capacity for each zone to maintain the temperature and humidity at a comfortable level.

Room temperature at start-up	Target temperature X	Thermostat OFF point Y	Thermostat ON point Z
24°C or more	Room temperature at start-up	$X - 2.5^{\circ}\text{C}$	$X - 0.5^{\circ}\text{C}$ or $Y + 0.5^{\circ}\text{C}$ (zone B) continues for 10 min.
23.5°C ⋮ 18°C		$X - 2.0^{\circ}\text{C}$	$X - 0.5^{\circ}\text{C}$ or $Y + 0.5^{\circ}\text{C}$ (zone B) continues for 10 min.
17.5°C ⋮		$X - 2.0^{\circ}\text{C}$	$X - 0.5^{\circ}\text{C} = 17.5^{\circ}\text{C}$ or $Y + 0.5^{\circ}\text{C}$ (zone B) continues for 10 min.

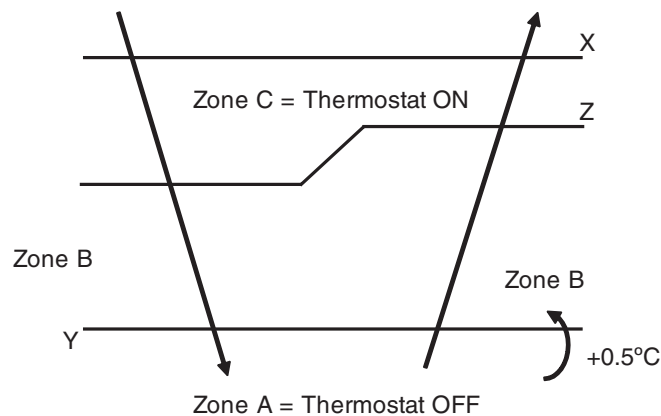

(R11581)

## 1.5 Automatic Operation

### Outline

#### Automatic Cooling / Heating Function

When the AUTO mode is selected with the remote controller, the microcomputer automatically determines the operation mode as cooling or heating according to the room temperature and the set temperature at start-up, and automatically operates in that mode.

The unit automatically switches the operation mode to maintain the room temperature at the set temperature.

### Detail

Tc: temperature set by remote controller  
 Tt: target temperature  
 Tr: room temperature  
 C: correction value

- The temperature set by remote controller (Tc) determines the target temperature (Tt).  
 (Tc = 18 ~ 30°C).
- The target temperature (Tt) is calculated as;  
 $Tt = Tc + C$   
 where C is the correction value.  
 $C = 0^{\circ}\text{C}$
- Thermostat ON/OFF point and mode switching point are as follows.  
 Tr means the room temperature.
  - Heating → Cooling switching point:  
 $Tr \geq Tt + 2.5^{\circ}\text{C}$
  - Cooling → Heating switching point:  
 $Tr < Tt - 2.5^{\circ}\text{C}$
  - Thermostat ON/OFF point is the same as the ON/OFF point of cooling or heating operation.
- During initial operation  
 $Tr \geq Tc$  : Cooling operation  
 $Tr < Tc$  : Heating operation

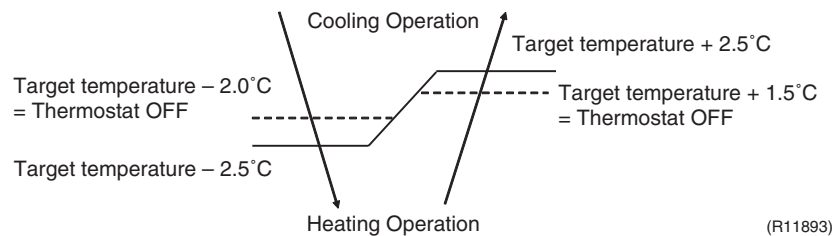

Ex: When the target temperature is 25°C

Cooling → 23°C: Thermostat OFF → 22°C: Switch to heating

Heating → 26.5°C: Thermostat OFF → 27.5°C: Switch to cooling



## 1.6 Thermostat Control

Thermostat control is based on the difference between the room temperature and the target temperature.

### Thermostat OFF Condition

- ♦ The temperature difference is in the zone A.

### Thermostat ON Condition

- ♦ The temperature difference returns to the zone C after being in the zone A.
- ♦ The system resumes from defrost control in any zones except A.
- ♦ The operation turns on in any zones except A.
- ♦ The monitoring time has passed while the temperature difference is in the zone B.  
(Cooling / Dry : 10 minutes, Heating : 10 seconds)

### Cooling / Dry

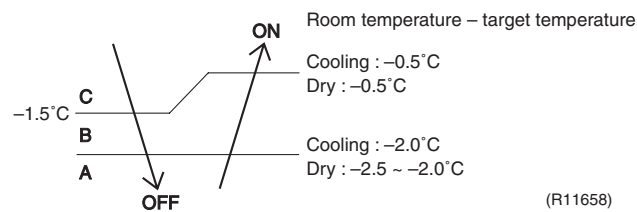

### Heating

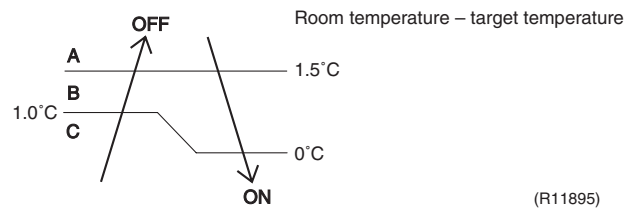

## 1.7 NIGHT SET Mode

### Outline

When the OFF timer is set, the NIGHT SET Mode is automatically activated. The NIGHT SET Mode keeps the airflow rate setting.

### Detail

The NIGHT SET Mode continues operation at the target temperature for the first one hour, then automatically raises the target temperature slightly in the case of cooling, or lowers it slightly in the case of heating. This prevents excessive cooling in summer and excessive heating in winter to ensure comfortable sleeping conditions, and also conserves electricity.

### Cooling

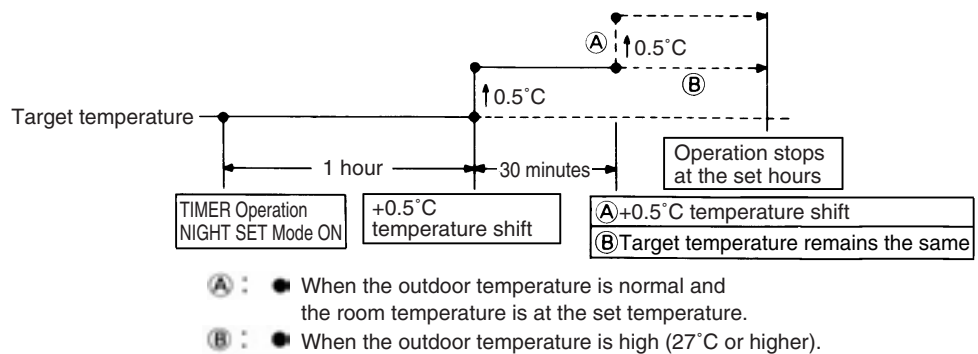

### Heating

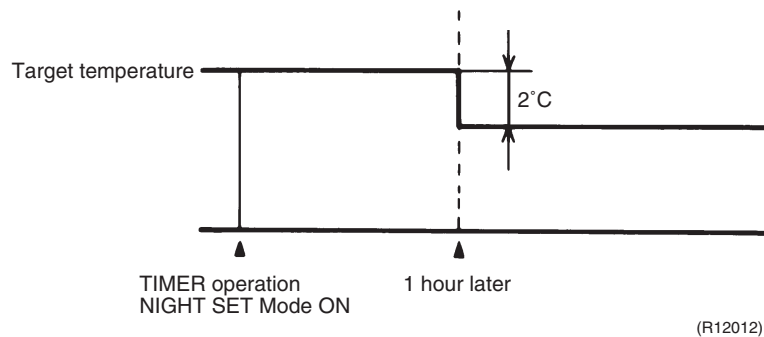

## 1.8 HOME LEAVE Operation

### Outline

HOME LEAVE operation is a function that allows you to record your favorite set temperature and airflow rate. You can start your favorite operation mode simply by pressing the [HOME LEAVE] button on the remote controller.

### Detail

#### 1. Start of Function

The function starts when the [HOME LEAVE] button is pressed in cooling mode, heating mode (including POWERFUL operation), or while the operation is stopped. If this button is pressed in POWERFUL operation, the POWERFUL operation is canceled and this function becomes effective.

- The [HOME LEAVE] button is ineffective in dry mode and fan mode.

#### 2. Details of Function

A mark representing HOME LEAVE is indicated on the display of the remote controller. The indoor unit is operated according to the set temperature and airflow rate for HOME LEAVE which were pre-set in the memory of the remote controller.

The LED (red) of indoor unit representing HOME LEAVE lights up. (It goes out when the operation is stopped.)

#### 3. End of Function

The function ends when the [HOME LEAVE] button is pressed again during HOME LEAVE operation or when the [POWERFUL] button is pressed.

<Cooling>



"HOME LEAVE operation"  
set temp.

Set temp.



(R11660)

<Heating>



"HOME LEAVE operation"  
set temp.

Set temp.



(R11661)

### Others

The set temperature and set airflow rate are memorized in the remote controller. When the remote controller is reset due to replacement of battery, it is necessary to set the temperature and airflow rate again for HOME LEAVE operation.

## 1.9 INTELLIGENT EYE Operation

### Outline

This is the function that detects existence of humans in the room by a human motion sensor (INTELLIGENT EYE) and reduces the capacity when there is nobody in the room in order to save electricity.

### Detail

#### 1. Detection method by INTELLIGENT EYE

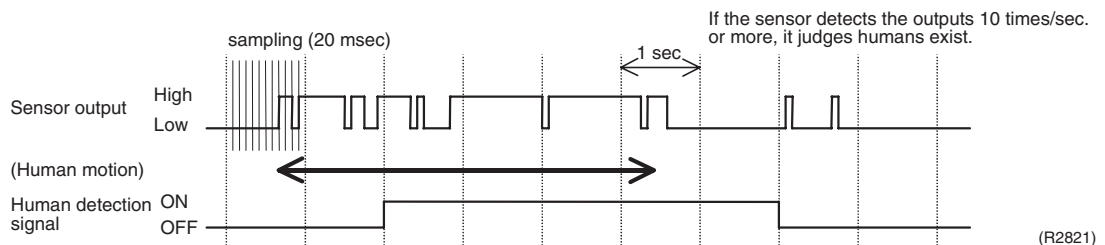

- This sensor detects human motion by receiving infrared rays and displays the pulse wave output.
- A microcomputer in an indoor unit carries out a sampling every 20 msec. and if it detects 10 cycles of the wave in one second in total (corresponding to 20 msec.  $\times$  10 = 200 msec.), it judges human is in the room as the motion signal is ON.

#### 2. The motions (for example: in cooling)

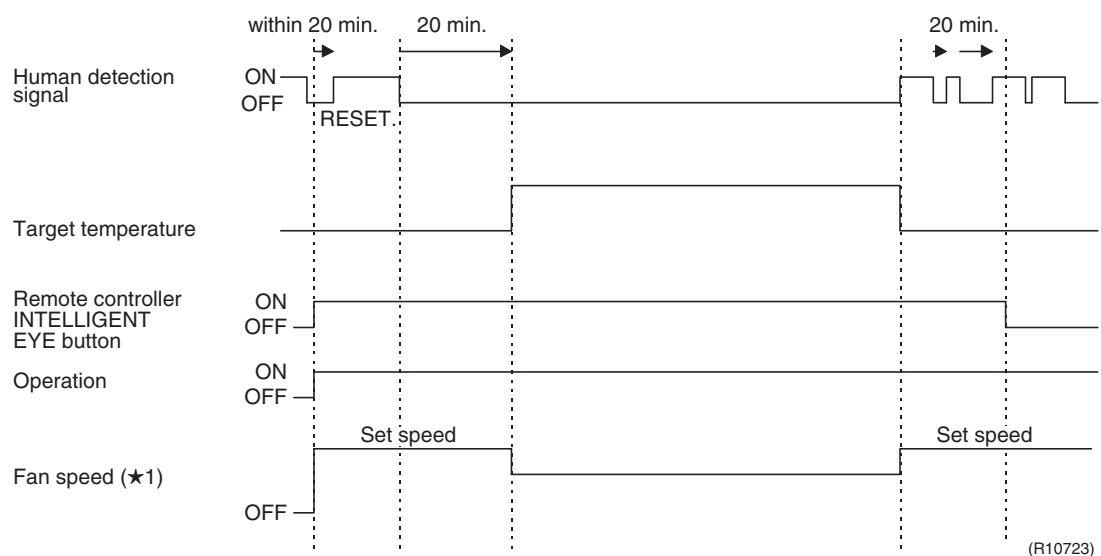

- When a microcomputer does not have a signal from the sensor in 20 minutes, it judges that nobody is in the room and operates the unit in temperature shifted from the target temperature. (Cooling : 2°C higher, Dry : 1°C higher, Heating : 2°C lower, Auto : according to the operation mode at that time.)

★1 In case of FAN mode, the fan speed reduces by 60 rpm.

### Others

- For dry operation, you cannot set the temperature with a remote controller, but internally the target temperature is shifted by 1°C.

## 1.10 Inverter POWERFUL Operation

### Outline

In order to exploit the cooling and heating capacity to full extent, operate the air conditioner by increasing the indoor fan rotating speed and the compressor frequency.

### Detail

When POWERFUL button is pressed, the fan speed and target temperature are converted to the following states for 20 minutes.

Operation mode	Fan speed	Target temperature
COOL	H tap + 90 rpm	18°C
DRY	Dry rotating speed + 90 rpm	Lowered by 2.5°C
HEAT	H tap + 90 rpm	32°C
FAN	H tap + 90 rpm	—
AUTO	Same as cooling / heating in POWERFUL operation	The target temperature is kept unchanged.

Ex.) : POWERFUL operation in cooling mode.

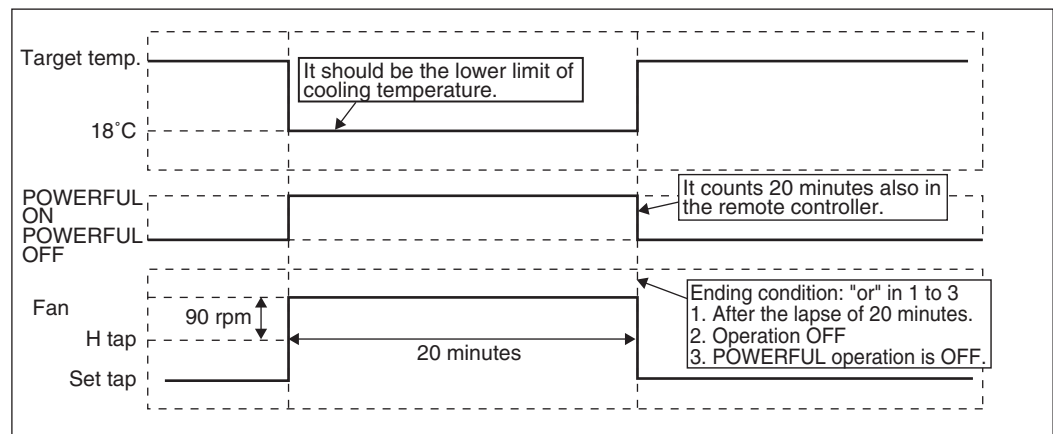

(R7096)

## 1.11 Other Functions

### 1.11.1 Hot-Start Function

In order to prevent the cold air blast that normally comes when heating operation is started, the temperature of the indoor heat exchanger is detected, and either the airflow is stopped or is made very weak thereby carrying out comfortable heating of the room.

\*The cold air blast is also prevented using a similar control when the defrosting operation is started or when the thermostat is turned ON.

### 1.11.2 Signal Receiving Sign

When the indoor unit receives a signal from the remote controller, the unit emits a signal receiving sound.

### 1.11.3 Indoor Unit ON/OFF Button

An ON/OFF button is provided on the display of the unit.

- Press this button once to start operation. Press once again to stop it.
- This button is useful when the remote controller is missing or the battery has run out.
- The operation mode refers to the following table.

Mode	Temperature setting	Airflow rate
AUTO	25°C	Automatic

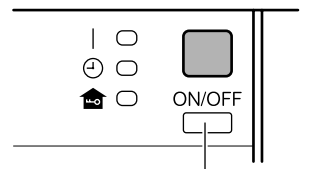

Indoor unit ON/OFF button

(R11968)

#### <Forced operation mode>

Forced operation mode can be started by pressing the ON/OFF button for 5 to 9 seconds while the unit is not operating.

Refer to "Forced operation mode" on page 39 for detail.



**Note:** When the ON/OFF button is pressed for 10 seconds or more, the forced operation is stopped.

### 1.11.4 Titanium Apatite Photocatalytic Air-Purifying Filter

This filter combines the Air-Purifying Filter and Titanium Apatite Photocatalytic Deodorizing Filter as a single highly effective filter. The filter traps microscopic particles, decompose odors and even deactivates bacteria and viruses. It lasts for 3 years without replacement if washed about once every 6 months.

### 1.11.5 Auto-restart Function

Even if a power failure (including one for just a moment) occurs during the operation, the operation restarts automatically when the power is restored in the same condition as before the power failure.



**Note:** It takes 3 minutes to restart the operation because the 3-minute standby function is activated.

## 2. Function of Thermistor

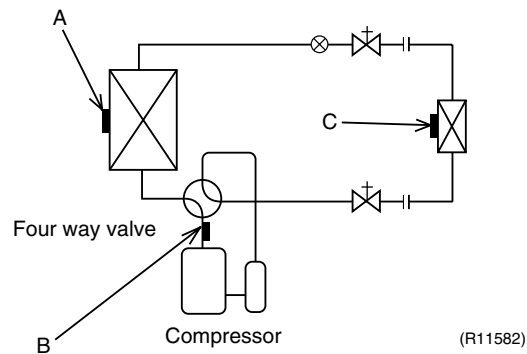

### A Outdoor Heat Exchanger Thermistor

1. The outdoor heat exchanger thermistor is used for controlling target discharge pipe temperature. The system sets the target discharge pipe temperature according to the outdoor and indoor heat exchanger temperature, and controls the electronic expansion valve opening so that the target discharge pipe temperature can be obtained.
2. In cooling operation, the outdoor heat exchanger thermistor is used for detecting disconnection of the discharge pipe thermistor. When the discharge pipe temperature becomes lower than the outdoor heat exchanger temperature, the discharge pipe thermistor is judged as disconnected.
3. In cooling operation, the outdoor heat exchanger thermistor is used for high pressure protection.

### B Discharge Pipe Thermistor

1. The discharge pipe thermistor is used for controlling discharge pipe temperature. If the discharge pipe temperature (used in place of the inner temperature of the compressor) rises abnormally, the operating frequency becomes lower or the operation halts.
2. The discharge pipe thermistor is used for detecting disconnection of the discharge pipe thermistor.

### C Indoor Heat Exchanger Thermistor

1. The indoor heat exchanger thermistor is used for controlling target discharge pipe temperature. The system sets the target discharge pipe temperature according to the outdoor and indoor heat exchanger temperature, and controls the electronic expansion valve opening so that the target discharge pipe temperature can be obtained.
2. In cooling operation, the indoor heat exchanger thermistor is used for freeze-up protection control. If the indoor heat exchanger temperature drops abnormally, the operating frequency becomes lower or the operation halts.
3. In heating operation, the indoor heat exchanger thermistor is used for detecting disconnection of the discharge pipe thermistor. When the discharge pipe temperature becomes lower than the indoor heat exchanger temperature, the discharge pipe thermistor is judged as disconnected.

## 3. Control Specification

### 3.1 Mode Hierarchy

**Outline** There are two modes; the one is the normal operation mode and the other is the forced operation mode for installation and providing service.

**Detail** There are following modes; stop, cooling (includes drying), heating (include defrosting)

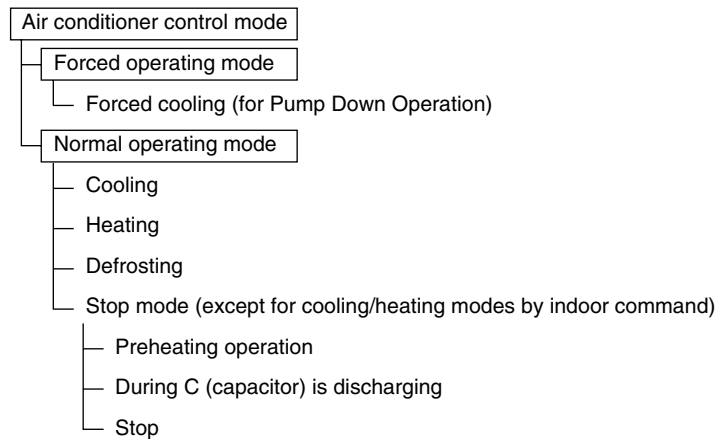

(R2829)



**Note:** Unless specified otherwise, an indoor dry operation command is regarded as cooling operation.



## 3.2 Frequency Control

### Outline

Frequency is determined according to the difference between the room temperature and the target temperature.

The function is explained as follows.

1. How to determine frequency
2. Frequency command from the indoor unit (Difference between the room temperature and the target temperature)
3. Frequency initial setting
4. PI control

When the shift of the frequency is less than zero ( $\Delta F < 0$ ) by PI control, the target frequency is used as the command frequency.

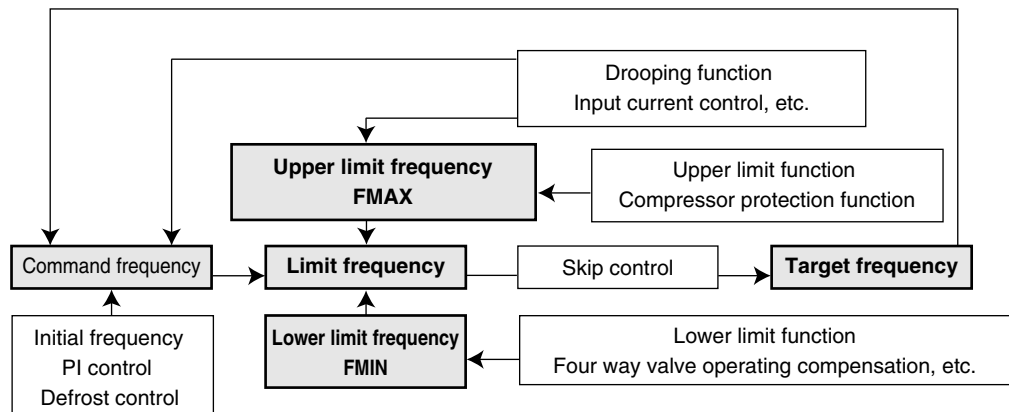

(R2831)

### Detail

#### How to Determine Frequency

The compressor's frequency is determined by taking the following steps.

##### 1. Determine command frequency

- ◆ Command frequency is determined in the following order of priority.
  1. Limiting defrost control time
  2. Forced cooling
  3. Indoor frequency command

##### 2. Determine upper limit frequency

- ◆ The minimum value is set as an upper limit frequency among the frequency upper limits of the following functions:  
Compressor protection, input current, discharge pipe temperature, heating peak-cut, freeze-up protection, defrost.

##### 3. Determine lower limit frequency

- ◆ The maximum value is set as a lower limit frequency among the frequency lower limits of the following functions:  
Four way valve operation compensation, draft prevention, pressure difference upkeep.

##### 4. Determine prohibited frequency

- ◆ There is a certain prohibited frequency such as a power supply frequency.

**Indoor Frequency Command ( $\Delta D$  signal)**

The difference between the room temperature and the target temperature is taken as the “ $\Delta D$  signal” and is used for frequency command.

Temperature difference (°C)	$\Delta D$ signal	Temperature difference (°C)	$\Delta D$ signal	Temperature difference (°C)	$\Delta D$ signal	Temperature difference (°C)	$\Delta D$ signal
-2.0	*Th OFF	0	4	2.0	8	4.0	C
-1.5	1	0.5	5	2.5	9	4.5	D
-1.0	2	1.0	6	3.0	A	5.0	E
-0.5	3	1.5	7	3.5	B	5.5	F

\*Th OFF = Thermostat OFF

**Frequency Initial Setting****<Outline>**

When starting the compressor, the frequency is initialized according to the  $\Delta D$  value and the Q value of the indoor unit.

Q value: Indoor unit output determined from indoor unit volume, airflow rate and other factors.

**PI Control (Determine Frequency Up / Down by  $\Delta D$  Signal)****1. P control**

The  $\Delta D$  value is calculated in each sampling time (20 seconds), and the frequency is adjusted according to its difference from the frequency previously calculated.

**2. I control**

If the operating frequency does not change for more than a certain fixed time, the frequency is adjusted according to the  $\Delta D$  value.

When the  $\Delta D$  value is small, the frequency is lowered.

When the  $\Delta D$  value is large, the frequency is increased.

**3. Frequency management when other controls are functioning**

- ◆ When frequency is drooping;  
Frequency management is carried out only when the frequency droops.
- ◆ For limiting lower limit  
Frequency management is carried out only when the frequency rises.

**4. Upper and lower limit of frequency by PI control**

The frequency upper and lower limits are set according to the command on indoor unit.

When the indoor or outdoor unit quiet operation command comes from the indoor unit, the upper limit frequency is lowered than the usual setting.

## 3.3 Controls at Mode Changing / Start-up

### 3.3.1 Preheating Operation

**Outline** The inverter operation in open phase starts with the conditions of the outdoor temperature, the discharge pipe temperature, and the radiation fin temperature (internal temperature of PM1).

**Detail** Outside temperature  $\geq 10^{\circ}\text{C}$  → Control A (preheating for normal state)  
Outside temperature  $< 10^{\circ}\text{C}$  → Control B (preheating of increased capacity)

#### Control A

- ◆ ON condition
  - Discharge pipe temperature  $< 6^{\circ}\text{C}$
  - Radiation fin temperature  $< 85^{\circ}\text{C}$
- ◆ OFF condition
  - Discharge pipe temperature  $> 8^{\circ}\text{C}$
  - Radiation fin temperature  $\geq 90^{\circ}\text{C}$

#### Control B

- ◆ ON condition
  - Discharge pipe temperature  $< 10.5^{\circ}\text{C}$
  - Radiation fin temperature  $< 85^{\circ}\text{C}$
- ◆ OFF condition
  - Discharge pipe temperature  $> 12^{\circ}\text{C}$
  - Radiation fin temperature  $\geq 90^{\circ}\text{C}$

### 3.3.2 Four Way Valve Switching

**Outline** In heating operation, current is conducted, and in cooling and defrosting, current is not conducted. In order to eliminate the switching sound when the heating is stopped, as the four way valve coil switches from ON to OFF, the OFF delay switch of the four way valve is carried out after the operation stopped.

**Detail** **OFF delay switch of four way valve:**  
The four way valve coil is energized for 150 seconds after the operation is stopped.

### 3.3.3 Four Way Valve Operation Compensation

**Outline** At the beginning of the operation as the four way valve is switched, the differential pressure to activate the four way valve is acquired by having output frequency which is more than a certain fixed frequency, for a certain fixed time.

**Detail** **Starting Conditions**

1. When starting compressor for heating.
2. When the operation mode changes to cooling from heating.
3. When starting compressor for defrosting or resetting.
4. When starting compressor for the first time after the reset with the power is ON.
5. When starting compressor for heating next to the suspension of defrosting.
6. When starting compressor next to the fault of switching over cooling / heating.

Set the lower limit frequency  $\text{A}$  Hz for  $\text{B}$  seconds with any conditions 1 through 6 above.

	$\text{A}$ (Hz)	$\text{B}$ (seconds)
50/60 class	48	70
71 class	28	70

### 3.3.4 3-minute Standby

Turning on the compressor is prohibited for 3 minutes after turning it off.  
(Except when defrosting.)

### 3.3.5 Compressor Protection Function

When turning the compressor from OFF to ON, the upper limit of frequency is set as follows.  
(The function is not activated when defrosting.)

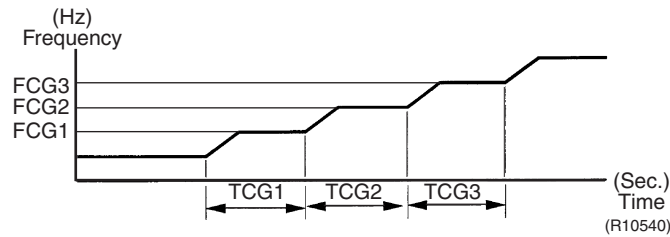

	50/60 class	71 class	Unit
FCG 1	55	55	Hz
FCG 2	70	65	
FCG 3	85	80	
TCG 1	120	120	seconds
TCG 2	200	200	
TCG 3	470	470	

## 3.4 Discharge Pipe Temperature Control

### Outline

The discharge pipe temperature is used as the internal temperature of the compressor. If the discharge pipe temperature rises above a certain level, the upper limit of frequency is set to keep this temperature from going up further.

### Detail

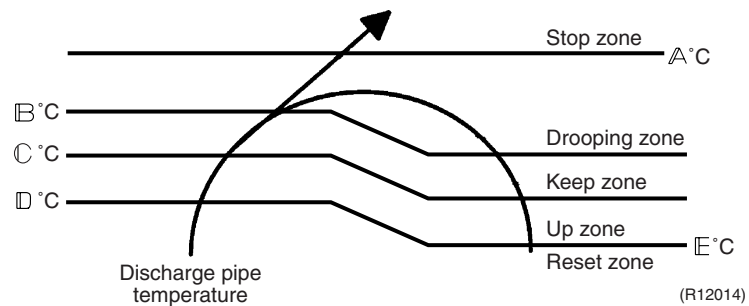

Zone	Control
Stop zone	When the temperature reaches the stop zone, the compressor stops.
Drooping zone	The timer starts, and the frequency is drooping.
Keep zone	The upper limit of frequency is kept.
Up zone	The upper limit of frequency is increased.
Reset zone	The upper limit of frequency is canceled.

	50/60 class	71 class
A (°C)	110	120
B (°C)	103	111
C (°C)	101.5	109
D (°C)	100	107
E (°C)	95	107

## 3.5 Input Current Control

### Outline

The microcomputer calculates the input current during the compressor is running, and sets the frequency upper limit from the input current.

In case of heat pump model, this control which is the upper limit control of the frequency takes priority to the lower limit of control of four way valve operation compensation.

### Detail

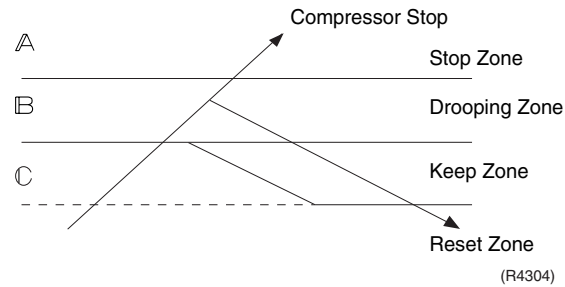

#### Frequency control in each zone

##### Stop zone

- ◆ After 2.5 seconds in this zone, the compressor is stopped.

##### Drooping zone

- ◆ The upper limit of the compressor frequency is defined as operation frequency – 2 Hz.
- ◆ After this, the output frequency is pulled down by 2 Hz every second until it reaches the keep zone.

##### Keep zone

- ◆ The present maximum frequency goes on.

##### Reset zone

- ◆ Limit of the frequency is canceled.

	50 class		60 class		71 class	
	Cooling	Heating	Cooling	Heating	Cooling	Heating
A (A)	20.0		20.0		20.0	
B (A)	10.0	15.0	12.0	16.0	17.0	18.75
C (A)	9.0	14.0	11.0	15.0	16.0	17.75

#### Limitation of current drooping and stop value according to the outdoor temperature

- ◆ The current droops when outdoor temperature becomes higher than a certain level (model by model).

### 3.6 Freeze-up Protection Control

**Outline** During cooling operation, the signal sent from the indoor unit controls the operating frequency limitation and prevents freezing of the indoor heat exchanger. (The signal from the indoor unit is divided into zones.)

**Detail** The operating frequency limitation is judged with the indoor heat exchanger temperature.

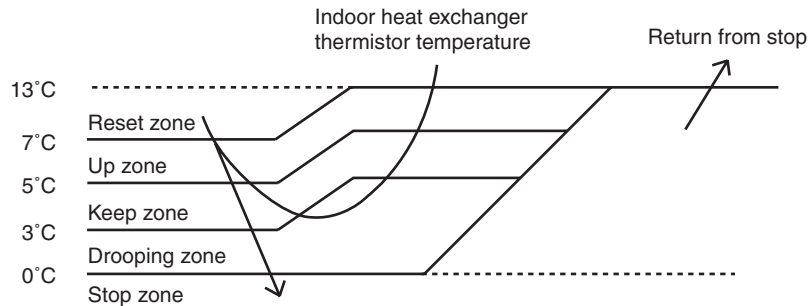

(R4561)

### 3.7 Heating Peak-cut Control

**Outline** During heating operation, the indoor heat exchanger temperature determines the frequency upper limit to prevent abnormal high pressure.

**Detail**

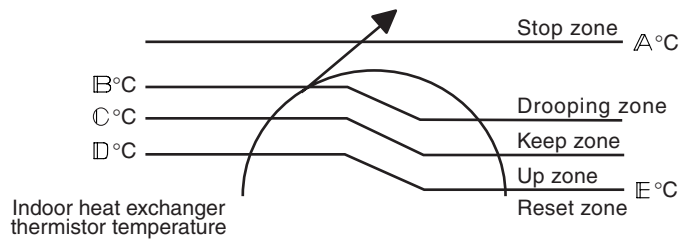

(R1380)

Zone	Control
Stop zone	When the temperature reaches the stop zone, the compressor stops.
Drooping zone	The timer starts, and the frequency is drooping.
Keep zone	The upper limit of frequency is kept.
Up zone	The upper limit of frequency is increased.
Reset zone	The upper limit of frequency is canceled.

A (°C)	65
B (°C)	56
C (°C)	55
D (°C)	53
E (°C)	51

## 3.8 Outdoor Fan Control

### 1. Fan OFF delay when stopped

The outdoor fan is turned OFF 60 seconds after the compressor stops.

### 2. Fan ON control to cool down the electrical box

The outdoor fan is turned ON when the electrical box temperature is high while the compressor is OFF.

### 3. Fan OFF control while defrosting

The outdoor fan is turned OFF while defrosting.

### 4. Fan ON/OFF control when operation starts/stops

The outdoor fan is turned ON when the operation starts. The outdoor fan is turned OFF when the operation stops.

### 5. Fan control while forced operation

The outdoor fan is controlled as well as normal operation while the forced operation.

### 6. Fan speed control while indoor/outdoor quiet operation

The rotation speed of the outdoor fan is reduced by the command of the indoor/outdoor quiet operation.

### 7. Fan control for POWERFUL operation

The rotation speed of the outdoor fan is increased while the POWERFUL operation.

### 8. Fan speed control for pressure difference upkeep

The rotation speed of the outdoor fan is controlled for keeping the pressure difference while cooling with low outdoor temperature.

- ◆ When the pressure difference is small, the rotation speed of the outdoor fan is reduced.
- ◆ When the pressure difference is large, the rotation speed of the outdoor fan is increased.

## 3.9 Liquid Compression Protection Function

### Outline

In order to obtain the dependability of the compressor, the compressor is stopped according to the outdoor temperature and temperature of the outdoor heat exchanger.

### Detail

- Operation stops depending on the outdoor temperature
- Compressor turns off under the conditions that the system is in cooling operation and outdoor temperature is below  $-12^{\circ}\text{C}$ .

## 3.10 Defrost Control

### Outline

Defrosting is carried out by the cooling cycle (reverse cycle). The defrosting time or outdoor heat exchanger temperature must be more than a certain value to finish.

### Detail

#### Conditions for Starting Defrost

- The starting conditions is determined with the outdoor temperature and the outdoor heat exchanger temperature.
- The system is in heating operation.
- The compressor operates for 6 minutes.
- 38 ~ 44 minutes of accumulated time pass since the start of the operation, or ending of the previous defrosting.

#### Conditions for Canceling Defrost

The judgment is made with outdoor heat exchanger temperature. ( $4^{\circ}\text{C} \sim 12^{\circ}\text{C}$ )

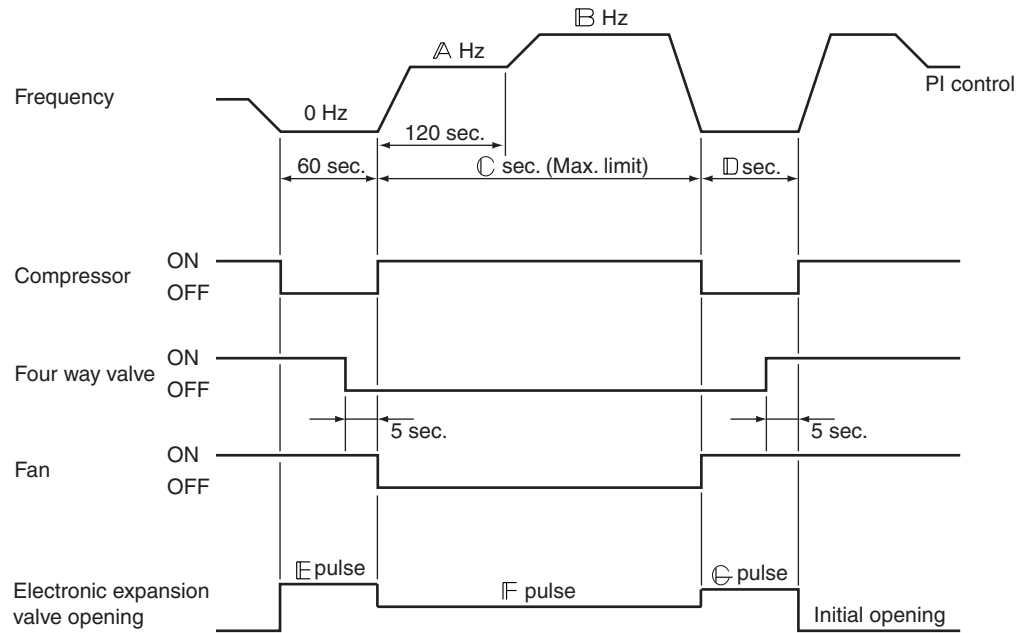

(R11969)

	50 class	60 class	71 class
A (Hz)	55	55	39
B (Hz)	90	90	62
C (seconds)	460	460	650
D (seconds)	30	50	60
E (pulse)	450	450	450
F (pulse)	450	450	350
G (pulse)	450	450	400



### 3.11 Electronic Expansion Valve Control

**Outline**

The following items are included in the electronic expansion valve control.

**Electronic expansion valve is fully closed**

1. Electronic expansion valve is fully closed when turning on the power.
2. Pressure equalizing control

**Open Control**

1. Electronic expansion valve control when starting operation
2. Electronic expansion valve control when frequency changed
3. Electronic expansion valve control for defrosting
4. Electronic expansion valve control when the discharge pipe temperature is abnormally high
5. Electronic expansion valve control when the discharge pipe thermistor is disconnected

**Feedback Control**

1. Discharge pipe temperature control

**Detail**

The followings are the examples of control which function in each mode by the electronic expansion valve control.

Operation pattern		Control when frequency changed	Control for abnormally high discharge pipe temperature	
When power is turned ON	○ : function × : not function			
↓		Fully closed when power is turned ON	×	×
Cooling operation		Open control when starting	×	○
↓		(Control of target discharge pipe temperature)	○	○
Stop		Pressure equalizing control	×	×
Heating operation		Open control when starting	×	○
↓		(Control of target discharge pipe temperature)	○	○
↓		(Defrost control)	×	×
Stop		Pressure equalizing control	×	×
Heating operation		Open control when starting	×	○
↓		Control of discharge pipe thermistor disconnection	↓	Continue
Stop		Pressure equalizing control	×	×

(R2833)

### 3.11.1 Fully Closing with Power ON

The electronic expansion valve is initialized when turning on the power. The opening position is set and the pressure equalization is developed.

### 3.11.2 Pressure Equalization Control

When the compressor is stopped, the pressure equalization control is activated. The electronic expansion valve opens, and develops the pressure equalization.

### 3.11.3 Opening Limit

#### Outline

A maximum and minimum opening of the electronic expansion valve are limited.

#### Detail

- A maximum electronic expansion valve opening :  $\Delta$  pulse
- A minimum electronic expansion valve opening :  $\text{B}$  pulse

	$\Delta$ (pulse)	$\text{B}$ (pulse)
50/60 class	480	54
71 class	450	75

The electronic expansion valve is fully closed when cooling is stopped and is opened with fixed opening during defrosting.

### 3.11.4 Starting Operation Control

The electronic expansion valve opening is controlled when the operation starts, and prevents the superheating or liquid compression.

### 3.11.5 High Discharge Pipe Temperature

When the compressor is operating, if the discharge pipe temperature exceeds a certain value, the electronic expansion valve opens and the refrigerant runs to the low pressure side. This procedure lowers the discharge pipe temperature.

### 3.11.6 Disconnection of the Discharge Pipe Thermistor

#### Outline

The disconnection of the discharge pipe thermistor is detected by comparing the discharge pipe temperature with the condensation temperature. If the discharge pipe thermistor is disconnected, the electronic expansion valve opens according to the outdoor temperature and the operation frequency, and operates for a specified time, and then stops.

After 3 minutes of waiting, the operation restarts and checks if the discharge pipe thermistor is disconnected. If the discharge pipe thermistor is disconnected, the system stops after operating for a specified time.

If the disconnection is detected 4 times in succession, then the system is shut down. When the compressor runs for 60 minutes without any error, the error counter is reset.

#### Detail

##### Detect Disconnection

When the starting control (cooling : 640 seconds, heating : 660 seconds) finishes, the following adjustment is made.

1. When the operation mode is cooling

When the following condition is fulfilled, the discharge pipe thermistor disconnection is ascertained.

Discharge pipe temperature + 6°C < outdoor heat exchanger temperature

2. When the operation mode is heating

When the following condition is fulfilled, the discharge pipe thermistor disconnection is ascertained.

Discharge pipe temperature + 6°C < indoor heat exchanger temperature

##### Adjustment when the thermistor is disconnected

When the disconnection is ascertained, the compressor continues operation for 9 minutes and then stops.

When the compressor stops repeatedly, the system is shut down.

### 3.11.7 Control when frequency is changed

When the target discharge pipe temperature control is active, if the target frequency is changed for a specified value in a certain time period, the target discharge pipe temperature control is canceled and the target opening of the electronic expansion valve is changed according to the shift.

### 3.11.8 Target Discharge Pipe Temperature Control

The target discharge pipe temperature is obtained from the indoor and outdoor heat exchanger temperature, and the electronic expansion valve opening is adjusted so that the actual discharge pipe temperature becomes close to the target discharge pipe temperature. (Indirect SH (superheating) control using the discharge pipe temperature)

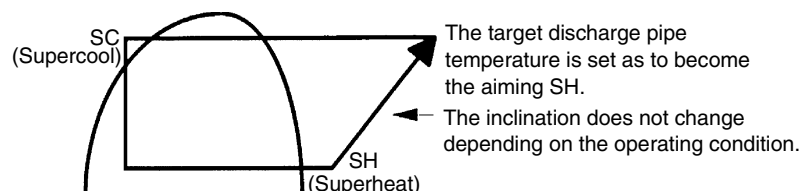

The electronic expansion valve opening and the target discharge pipe temperature are adjusted every 20 seconds. The target discharge pipe temperature is controlled by indoor heat exchanger temperature and outdoor heat exchanger temperature. The opening degree of the electronic expansion valve is controlled by followings.

- ◆ Target discharge pipe temperature
- ◆ Actual discharge pipe temperature
- ◆ Previous discharge pipe temperature

## 3.12 Malfunctions

### 3.12.1 Sensor Malfunction Detection

Sensor malfunction may occur in the thermistor.

#### Relating to Thermistor Malfunction

1. Outdoor heat exchanger thermistor
2. Discharge pipe thermistor
3. Radiation fin thermistor
4. Outdoor temperature thermistor

#### Relating to CT Malfunction

When the output frequency is more than  $\Delta$  Hz and the input current is below  $\text{B}$  A, it is judged as malfunction.

	$\Delta$ (Hz)	$\text{B}$ (A)
50/60 class	55	0.5
71 class	32	0.5

### 3.12.2 Detection of Overcurrent and Overload

#### Outline

An excessive output current is detected and, the OL temperature is observed to protect the compressor.

#### Detail

- If the OL (compressor head) temperature exceeds about 120°C (depending on the model), the system shuts down the compressor.
- If the inverter current exceeds 20 A, the system shuts down the compressor.

### 3.12.3 Refrigerant Shortage Control

#### Outline

#### I Detecting by power consumption

If the power consumption is below the specified value and the frequency is higher than the specified frequency, it is regarded as refrigerant shortage.

The power consumption is small comparing with that in the normal operation when refrigerant is insufficient, and refrigerant shortage is detected by checking a power consumption.

	$\Delta$ (Hz)
50/60 class	55
71 class	40

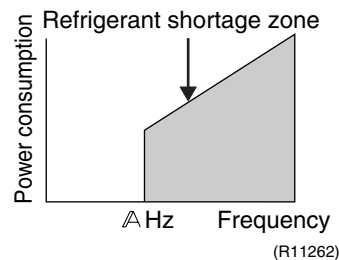

#### II Detecting by discharge pipe temperature

If the discharge pipe temperature is higher than the target discharge pipe temperature, and the electronic expansion valve is fully open for more than the specified time, it is regarded as refrigerant shortage.

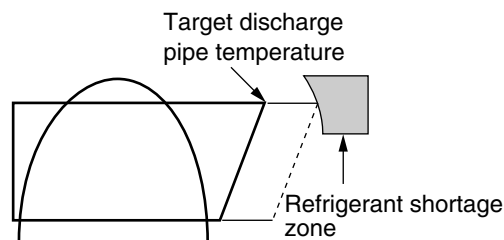

Refer to “Refrigerant shortage” on page 92 for detail.

## 3.13 Forced Operation Mode

**Outline** Forced operation mode includes only forced cooling.

### Detail

Item	Forced Cooling
Conditions	1) The outdoor unit is not abnormal and not in the 3-minute standby mode.
	2) The outdoor unit is not operating.
	The forced operation is allowed when the above both conditions are met.
Start	Press the forced operation ON/OFF button (SW1) on the indoor unit for 5 seconds.
Command frequency	50/60 class: 66 Hz 71 class: 31 Hz
End	1) Press the forced operation ON/OFF button (SW1) on the indoor unit again.
	2) Press the ON/OFF button on the remote controller.
	3) The operation ends automatically after 15 minutes.
Others	The protection functions are prior to all others in the forced operation.

---

# Part 5

# Operation Manual

1. System Configuration.....	41
2. Operation Manual.....	42
2.1 Remote Controller .....	42
2.2 AUTO · DRY · COOL · HEAT · FAN Operation .....	43
2.3 Adjusting the Airflow Direction.....	45
2.4 POWERFUL Operation .....	47
2.5 OUTDOOR UNIT QUIET Operation.....	48
2.6 HOME LEAVE Operation .....	49
2.7 INTELLIGENT EYE Operation .....	51
2.8 TIMER Operation .....	53

# 1. System Configuration

After the installation and test operation of the room air conditioner have been completed, it should be operated and handled as described below. Every user would like to know the correct method of operation of the room air conditioner, to check if it is capable of cooling (or heating) well, and to know a clever method of using it.

In order to meet this expectation of the users, giving sufficient explanations taking enough time can be said to reduce about 80% of the requests for servicing. However good the installation work is and however good the functions are, the customer may blame either the room air conditioner or its installation work because of improper handling. The installation work and handing over of the unit can only be considered to have been completed when its handling has been explained to the user without using technical terms but giving full knowledge of the equipment.

## 2. Operation Manual

### 2.1 Remote Controller

#### ■ Remote Controller

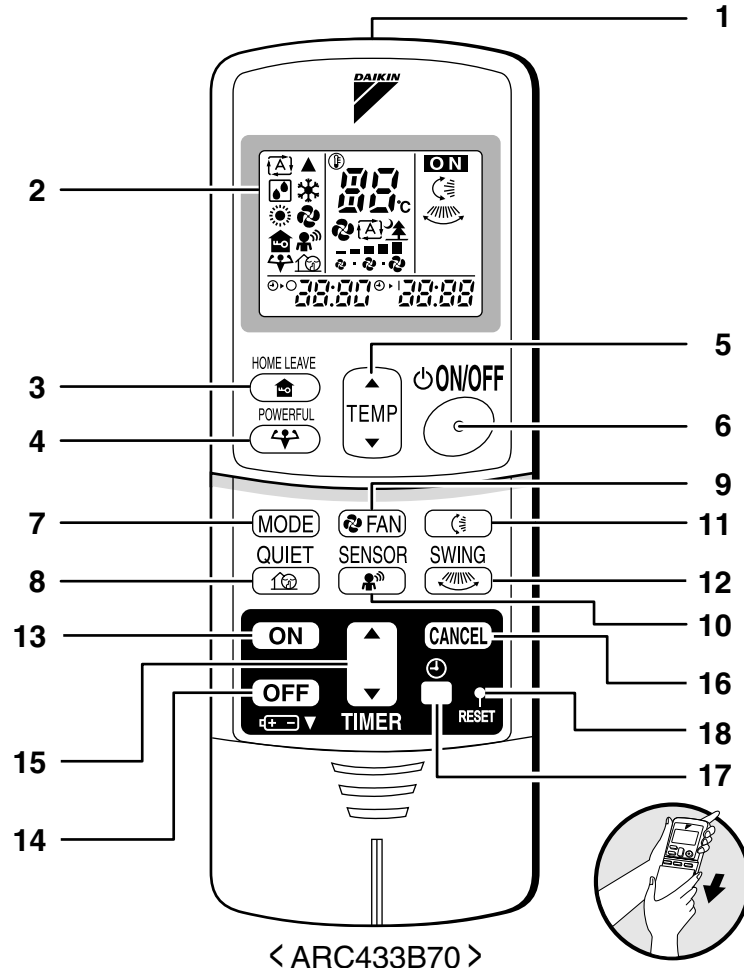

- |   |   |
|---|---|
| <p><b>1. Signal transmitter:</b></p> <ul style="list-style-type: none"> <li>• It sends signals to the indoor unit.</li> </ul> <p><b>2. Display:</b></p> <ul style="list-style-type: none"> <li>• It displays the current settings.<br/>(In this illustration, each section is shown with all its displays ON for the purpose of explanation.)</li> </ul> <p><b>3. HOME LEAVE button:</b></p> <p>HOME LEAVE operation (page 16.)</p> <p><b>4. POWERFUL button:</b></p> <p>POWERFUL operation (page 14.)</p> <p><b>5. TEMPERATURE adjustment buttons:</b></p> <ul style="list-style-type: none"> <li>• It changes the temperature setting.</li> </ul> <p><b>6. ON/OFF button:</b></p> <ul style="list-style-type: none"> <li>• Press this button once to start operation.<br/>Press once again to stop it.</li> </ul> <p><b>7. MODE selector button:</b></p> <ul style="list-style-type: none"> <li>• It selects the operation mode.<br/>(AUTO/DRY/COOL/HEAT/FAN) (page 10.)</li> </ul> | <p><b>8. QUIET button:</b> OUTDOOR UNIT QUIET operation (page 15.)</p> <p><b>9. FAN setting button:</b></p> <ul style="list-style-type: none"> <li>• It selects the air flow rate setting.</li> </ul> <p><b>10. SENSOR button:</b> INTELLIGENT EYE operation (page 18.)</p> <p><b>11. SWING button:</b> (page 12.)</p> <ul style="list-style-type: none"> <li>• Flap (Horizontal blade)</li> </ul> <p><b>12. SWING button:</b> (page 12.)</p> <ul style="list-style-type: none"> <li>• Louver (Vertical blades)</li> </ul> <p><b>13. ON TIMER button:</b> (page 21.)</p> <p><b>14. OFF TIMER button:</b> (page 20.)</p> <p><b>15. TIMER Setting button:</b></p> <ul style="list-style-type: none"> <li>• It changes the time setting.</li> </ul> <p><b>16. TIMER CANCEL button:</b></p> <ul style="list-style-type: none"> <li>• It cancels the timer setting.</li> </ul> <p><b>17. CLOCK button</b></p> <p><b>18. RESET button:</b></p> <ul style="list-style-type: none"> <li>• Restart the unit if it freezes.<br/>• Use a thin object to push.</li> </ul> |
|---|---|



## 2.2 AUTO · DRY · COOL · HEAT · FAN Operation

# AUTO · DRY · COOL · HEAT · FAN Operation

The air conditioner operates with the operation mode of your choice.

From the next time on, the air conditioner will operate with the same operation mode.

### ■ To start operation

#### 1. Press “MODE selector button” and select a operation mode.

- Each pressing of the button advances the mode setting in sequence.

: AUTO

: DRY

: COOL

: HEAT

: FAN

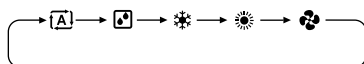

#### 2. Press “ON/OFF button”.

- The OPERATION lamp lights up.

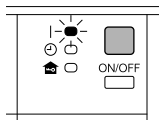

### ■ To stop operation

#### 3. Press “ON/OFF button” again.

- Then OPERATION lamp goes off.

### ■ To change the temperature setting



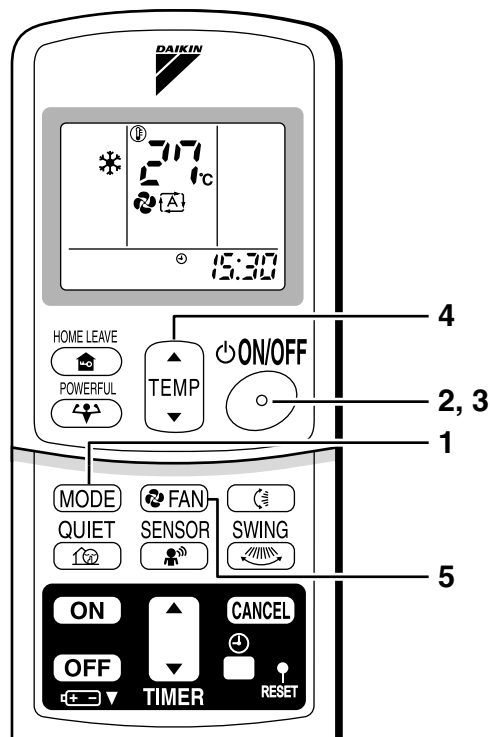

#### 4. Press “TEMPERATURE adjustment button”.

DRY or FAN mode	AUTO or COOL or HEAT mode
The temperature setting is not variable.	Press “▲” to raise the temperature and press “▼” to lower the temperature.
	Set to the temperature you like. 



## ■ To change the air flow rate setting

### 5. Press “FAN setting button”.

DRY mode	AUTO or HEAT or COOL or FAN mode
The air flow rate setting is not variable.	<p>Five levels of air flow rate setting from “” to “” plus “” “” are available.</p> 

- Indoor unit quiet operation

When the air flow is set to “”, the noise from the indoor unit will become quieter.

Use this when making the noise quieter.

The unit might lose capacity when the air flow rate is set to a weak level.

## NOTE

### ■ Note on HEAT operation

- Since this air conditioner heats the room by taking heat from outdoor air to indoors, the heating capacity becomes smaller in lower outdoor temperatures. If the heating effect is insufficient, it is recommended to use another heating appliance in combination with the air conditioner.
- The heat pump system heats the room by circulating hot air around all parts of the room. After the start of heating operation, it takes some time before the room gets warmer.
- In heating operation, frost may occur on the outdoor unit and lower the heating capacity. In that case, the system switches into defrosting operation to take away the frost.
- During defrosting operation, hot air does not flow out of indoor unit.

### ■ Note on COOL operation

- This air conditioner cools the room by blowing the hot air in the room outside, so if the outside temperature is high, performance drops.

### ■ Note on DRY operation

- The computer chip works to rid the room of humidity while maintaining the temperature as much as possible. It automatically controls temperature and fan strength, so manual adjustment of these functions is unavailable.

### ■ Note on AUTO operation

- In AUTO operation, the system selects a temperature setting and an appropriate operation mode (COOL or HEAT) based on the room temperature at the start of the operation.
- The system automatically reselects setting at a regular interval to bring the room temperature to user-setting level.
- If you do not like AUTO operation, you can manually select the operation mode and setting you like.

### ■ Note on air flow rate setting





- At smaller air flow rates, the cooling (heating) effect is also smaller.

## 2.3 Adjusting the Airflow Direction

# Adjusting the Air Flow Direction



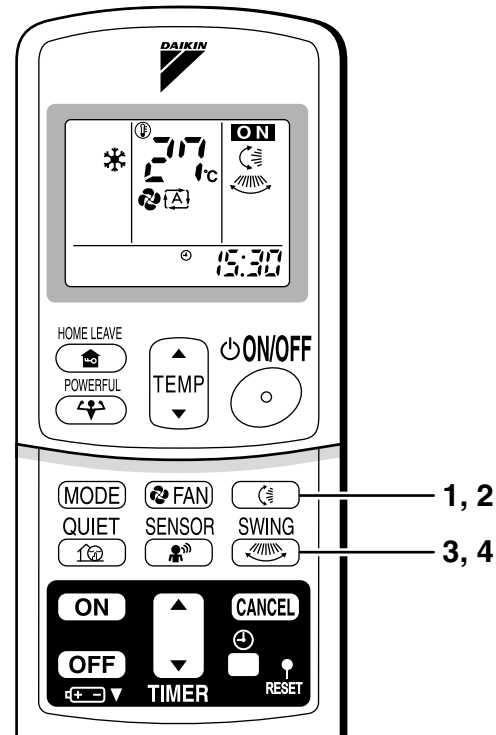

You can adjust the air flow direction to increase your comfort.

### ■ To adjust the horizontal blade (flap)





1. Press “SWING button ”.
  - “” is displayed on the LCD and the flaps will begin to swing.
2. When the flap has reached the desired position, press “SWING button ” once more.
  - The flap will stop moving.
  - “” disappears from the LCD.



### ■ To adjust the vertical blades (louvers)

3. Press “SWING button ”.
  4. When the louvers have reached the desired position, press the “SWING button ” once more.
- “” is displayed on the LCD.
  - The louvers will stop moving.
  - “” disappears from the LCD.

### ■ To 3-D Airflow

1. 3. Press the “SWING button ” and the “SWING button ”:  
the “” and “” display will light up and the flap and louvers will move in turn.

### ■ To cancel 3-D Airflow

2. 4. Press either the “SWING button ” or the “SWING button ”.

### Notes on louvers angles

- **ATTENTION**
  - Always use a remote controller to adjust the louvers angles. In side the air outlet, a fan is rotating at a high speed.

### Notes on flap angle

- When “SWING button” is selected, the flaps swinging range depends on the operation mode. (See the figure.)

#### Three-Dimensional (3-D) Airflow

- Using three-dimensional airflow circulates cold air, which tends to collected at the bottom of the room, and hot air, which tends to collect near the ceiling, throughout the room, preventing areas of cold and hot developing.

- **ATTENTION**
  - Always use a remote controller to adjust the flaps angle. If you attempt to move it forcibly with hand when it is swinging, the mechanism may be broken.
  - Be careful when adjusting the louvers. Inside the air outlet, fan is rotating at a high speed.

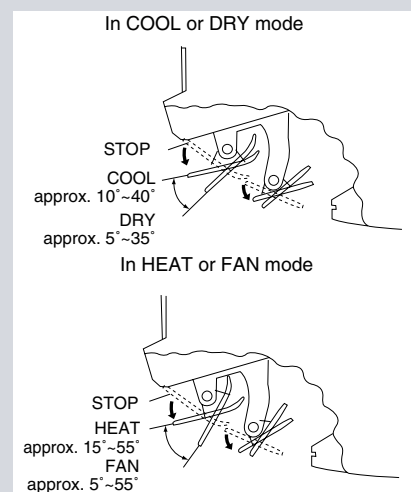

## 2.4 POWERFUL Operation

# POWERFUL Operation

POWERFUL operation quickly maximizes the cooling (heating) effect in any operation mode. You can get the maximum capacity.

### ■ To start POWERFUL operation

#### 1. Press “POWERFUL button”.

- POWERFUL operation ends in 20 minutes. Then the system automatically operates again with the settings which were used before POWERFUL operation.
- When using Powerful operation, there are some functions which are not available.
- “” is displayed on the LCD.

### ■ To cancel POWERFUL operation

#### 2. Press “POWERFUL button” again.

- “” disappears from the LCD.

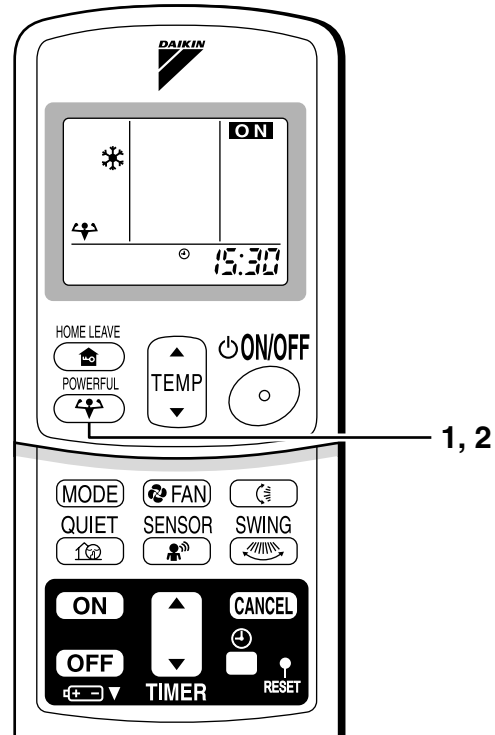

## NOTE

### ■ Notes on POWERFUL operation

- POWERFUL Operation cannot be used together with QUIET Operation. Priority is given to the function of whichever button is pressed last.
- POWERFUL Operation can only be set when the unit is running. Pressing the operation stop button causes the settings to be canceled, and the “” disappears from the LCD.
- **In COOL and HEAT mode**  
To maximize the cooling (heating) effect, the capacity of outdoor unit must be increased and the air flow rate be fixed to the maximum setting.  
The temperature and air flow settings are not variable.
- **In DRY mode**  
The temperature setting is lowered by 2.5°C and the air flow rate is slightly increased.
- **In FAN mode**  
The air flow rate is fixed to the maximum setting.

## 2.5 OUTDOOR UNIT QUIET Operation

# OUTDOOR UNIT QUIET Operation

OUTDOOR UNIT QUIET operation lowers the noise level of the outdoor unit by changing the frequency and fan speed on the outdoor unit. This function is convenient during night.

### ■ To start OUTDOOR UNIT QUIET operation

#### 1. Press “QUIET button”.

- “” is displayed on the LCD.

### ■ To cancel OUTDOOR UNIT QUIET operation

#### 2. Press “QUIET button” again.

- “” disappears from the LCD.

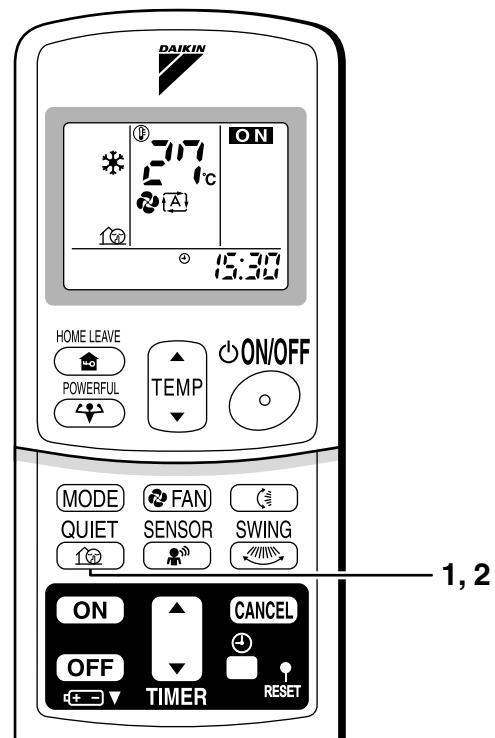

## NOTE

### ■ Note on OUTDOOR UNIT QUIET operation

- This function is available in COOL, HEAT, and AUTO modes. (This is not available in FAN and DRY mode.)
- POWERFUL operation and OUTDOOR UNIT QUIET operation cannot be used at the same time. Priority is given to the function of whichever button is pressed last.
- If operation is stopped using the remote controller or the main unit ON/OFF switch when using OUTDOOR UNIT QUIET operation, “” will remain on the remote controller display.

## 2.6 HOME LEAVE Operation

# HOME LEAVE Operation

HOME LEAVE operation is a function which allows you to record your preferred temperature and air flow rate settings.

### ■ To start HOME LEAVE operation

#### 1. Press “HOME LEAVE button”.

- “” is displayed on the LCD.
- The HOME LEAVE lamp lights up.

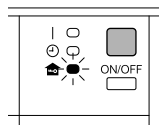

### ■ To cancel HOME LEAVE operation

#### 2. Press “HOME LEAVE button” again.



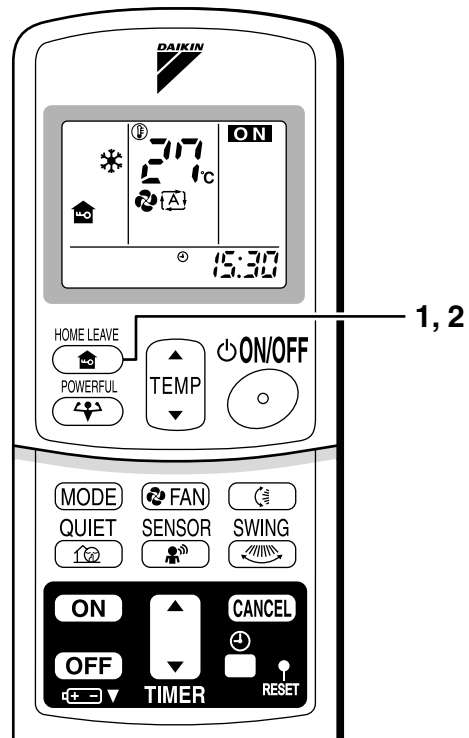



- “” disappears from the LCD.
- The HOME LEAVE lamp goes off.





### Before using HOME LEAVE operation.

#### ■ To set the temperature and air flow rate for HOME LEAVE operation

When using HOME LEAVE operation for the first time, please set the temperature and air flow rate for HOME LEAVE operation. Record your preferred temperature and air flow rate.

	Initial setting		Selectable range	
	temperature	Air flow rate	temperature	Air flow rate
Cooling	25°C	“  ”	18-32°C	5 step, “  ” and “  ”
Heating	25°C	“  ”	10-30°C	5 step, “  ” and “  ”

1. Press “HOME LEAVE button”. Make sure “” is displayed in the remote controller display.
2. Adjust the set temperature with “” or “” as you like.
3. Adjust the air flow rate with “FAN” setting button as you like.

Home leave operation will run with these settings the next time you use the unit. To change the recorded information, repeat steps 1 – 3.

## ■ What's the HOME LEAVE operation?

Is there a set temperature and air flow rate which is most comfortable, a set temperature and air flow rate which you use the most? HOME LEAVE operation is a function that allows you to record your favorite set temperature and air flow rate. You can start your favorite operation mode simply by pressing the HOME LEAVE button on the remote controller. This function is convenient in the following situations.

## ■ Useful in these cases

### 1. Use as an energy-saving mode.

Set the temperature 2-3°C higher (cooling) or lower (heating) than normal. Setting the fan strength to the lowest setting allows the unit to be used in energy-saving mode. Also convenient for use while you are out or sleeping.

#### • Every day before you leave the house...

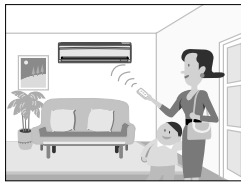

When you go out, push the "HOME LEAVE Operation" button, and the air conditioner will adjust capacity to reach the preset temperature for HOME LEAVE Operation.

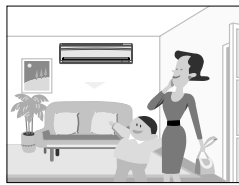

When you return, you will be welcomed by a comfortably air conditioned room.

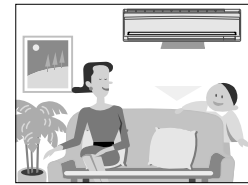

Push the "HOME LEAVE Operation" button again, and the air conditioner will adjust capacity to the set temperature for normal operation.

#### • Before bed...

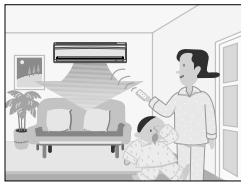

Set the unit to HOME LEAVE Operation before leaving the living room when going to bed.

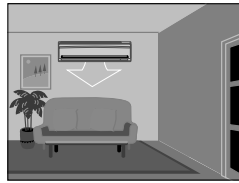

The unit will maintain the temperature in the room at a comfortable level while you sleep.

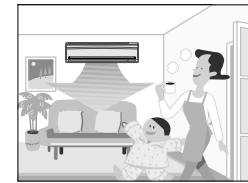

When you enter the living room in the morning, the temperature will be just right. Disengaging HOME LEAVE Operation will return the temperature to that set for normal operation. Even the coldest winters will pose no problem!

### 2. Use as a favorite mode.

Once you record the temperature and air flow rate settings you most often use, you can retrieve them by pressing HOME LEAVE button. You do not have to go through troublesome remote control operations.

## NOTE

- Once the temperature and air flow rate for HOME LEAVE operation are set, those settings will be used whenever HOME LEAVE operation is used in the future. To change these settings, please refer to the "Before using HOME LEAVE operation" section above.
- HOME LEAVE operation is only available in COOL and HEAT mode. Cannot be used in AUTO, DRY, and FAN mode.
- HOME LEAVE operation runs in accordance with the previous operation mode (COOL or HEAT) before using HOME LEAVE operation.
- HOME LEAVE operation and POWERFUL operation cannot be used at the same time. Last button that was pressed has priority.
- The operation mode cannot be changed while HOME LEAVE operation is being used.
- When operation is shut off during HOME LEAVE operation, using the remote controller or the indoor unit ON/OFF switch, "🏠" will remain on the remote controller display.



## 2.7 INTELLIGENT EYE Operation

# INTELLIGENT EYE Operation

“INTELLIGENT EYE” is the infrared sensor which detects the human movement.

### ■ To start INTELLIGENT EYE operation

1. Press “SENSOR button”.
  - “” is displayed on the LCD.

### ■ To cancel the INTELLIGENT EYE operation

2. Press “SENSOR button” again.
  - “” disappears from the LCD.

[EX.]

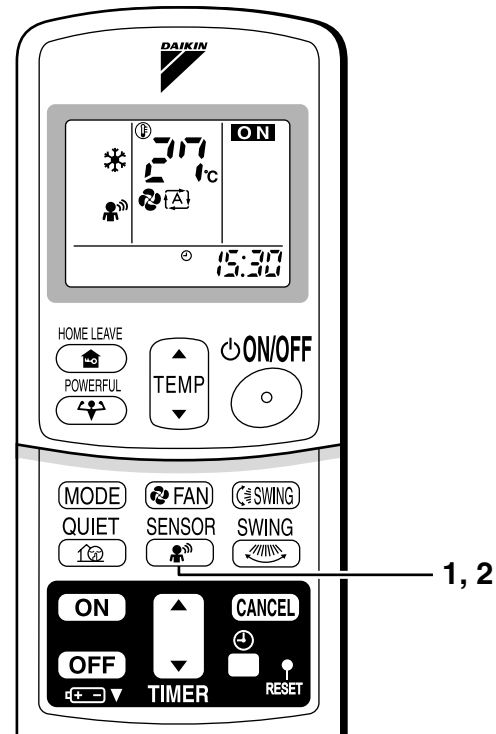
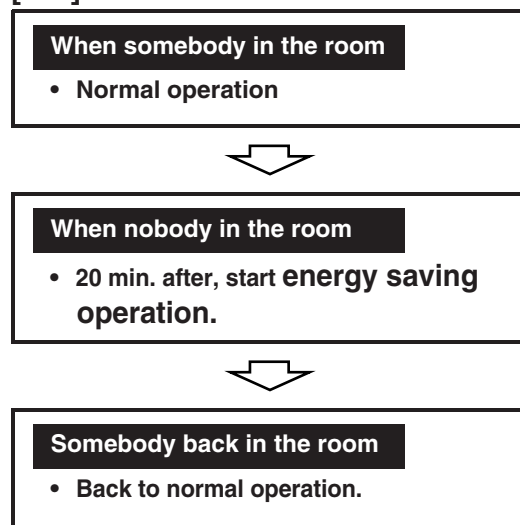

## “INTELLIGENT EYE” is useful for Energy Saving.

### ■ Energy saving operation

- Change the temperature  $-2^{\circ}\text{C}$  in heating /  $+2^{\circ}\text{C}$  in cooling /  $+1^{\circ}\text{C}$  in dry mode from set temperature.
- Decrease the air flow rate slightly in fan operation. (In FAN mode only)

## Notes on “INTELLIGENT EYE”

- Application range is as follows.

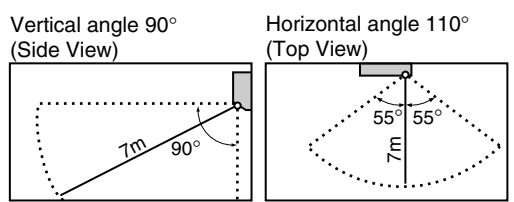

- Sensor may not detect moving objects further than 7m away. (Check the application range)
- Sensor detection sensitivity changes according to indoor unit location, the speed of passersby, temperature range, etc.
- The sensor also mistakenly detects pets, sunlight, fluttering curtains and light reflected off of mirrors as passersby.
- INTELLIGENT EYE operation will not go on during powerful operation.
- Night set mode (page 20.) will not go on during you use INTELLIGENT EYE operation.

## **!** CAUTION

- Do not place large objects near the sensor.  
Also keep heating units or humidifiers outside the sensor's detection area. This sensor can detect objects it shouldn't as well as not detect objects it should.
- Do not hit or violently push the INTELLIGENT EYE sensor. This can lead to damage and malfunction.

## 2.8 TIMER Operation

# TIMER Operation

Timer functions are useful for automatically switching the air conditioner on or off at night or in the morning. You can also use OFF TIMER and ON TIMER in combination.

### ■ To use OFF TIMER operation

- Check that the clock is correct.  
If not, set the clock to the present time.

#### 1. Press “OFF TIMER button”.

0:00 is displayed.

⊙-○ blinks.

#### 2. Press “TIMER Setting button” until the time setting reaches the point you like.

- Every pressing of either button increases or decreases the time setting by 10 minutes. Holding down either button changes the setting rapidly.

#### 3. Press “OFF TIMER button” again.

- The TIMER lamp lights up.

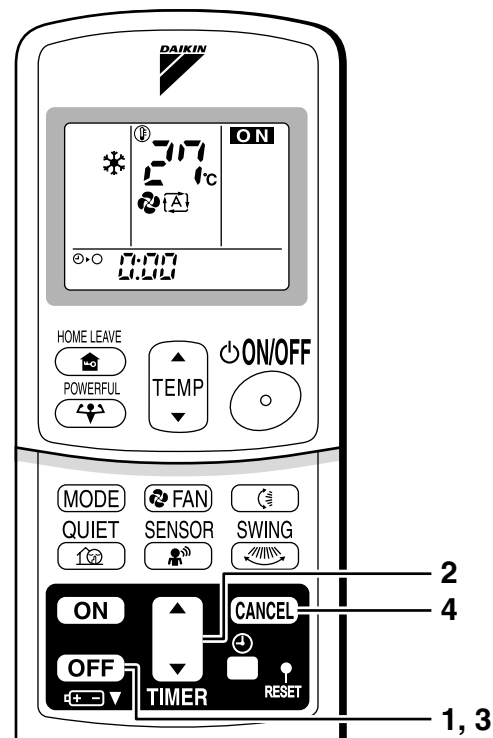
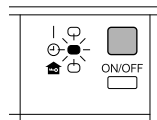

### ■ To cancel the OFF TIMER Operation

#### 4. Press “CANCEL button”.

- The TIMER lamp goes off.

## NOTE

- When TIMER is set, the present time is not displayed.
- Once you set ON, OFF TIMER, the time setting is kept in the memory. (The memory is canceled when remote controller batteries are replaced.)
- When operating the unit via the ON/OFF Timer, the actual length of operation may vary from the time entered by the user. (Maximum approx. 10 minutes)

#### ■ NIGHT SET MODE

When the OFF TIMER is set, the air conditioner automatically adjusts the temperature setting (0.5°C up in COOL, 2.0°C down in HEAT) to prevent excessive cooling (heating) for your pleasant sleep.

## ■ To use ON TIMER operation

- Check that the clock is correct. If not, set the clock to the present time.

### 1. Press “ON TIMER button”.

6:00 is displayed.

⊕-| blinks.

### 2. Press “TIMER Setting button” until the time setting reaches the point you like.

- Every pressing of either button increases or decreases the time setting by 10 minutes. Holding down either button changes the setting rapidly.

### 3. Press “ON TIMER button” again.

- The TIMER lamp lights up.

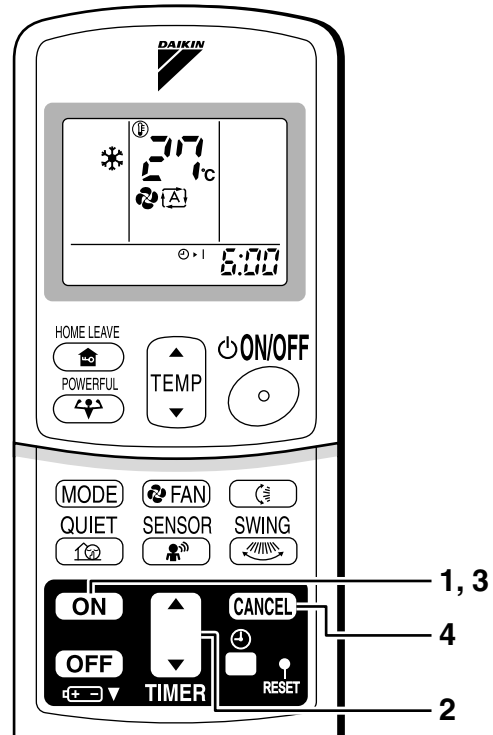
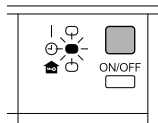

## ■ To cancel ON TIMER operation

### 4. Press “CANCEL button”.

- The TIMER lamp goes off.

## ■ To combine ON TIMER and OFF TIMER

- A sample setting for combining the two timers is shown below.

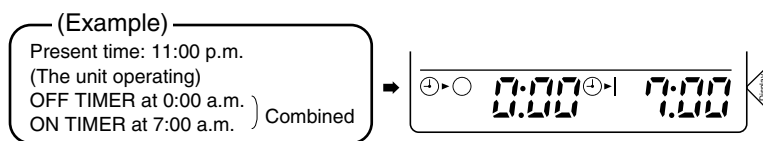

## ATTENTION

### ■ In the following cases, set the timer again.

- After a breaker has turned OFF.
- After a power failure.
- After replacing batteries in the remote controller.

# Part 6

## Service Diagnosis

1. Caution for Diagnosis.....	56
1.1 Troubleshooting with LED .....	56
2. Problem Symptoms and Measures .....	57
3. Service Check Function .....	58
4. Troubleshooting .....	61
4.1 Error Codes and Description .....	61
4.2 Indoor Unit PCB Abnormality .....	62
4.3 Freeze-up Protection Control or Heating Peak-cut Control.....	63
4.4 Fan Motor (DC Motor) or Related Abnormality.....	64
4.5 Thermistor or Related Abnormality (Indoor Unit).....	66
4.6 Signal Transmission Error (between Indoor Unit and Outdoor Unit) .....	67
4.7 Unspecified Voltage (between Indoor Unit and Outdoor Unit) .....	69
4.8 Outdoor Unit PCB Abnormality.....	70
4.9 OL Activation (Compressor Overload) .....	71
4.10 Compressor Lock .....	72
4.11 DC Fan Lock .....	73
4.12 Input Overcurrent Detection .....	74
4.13 Four Way Valve Abnormality .....	75
4.14 Discharge Pipe Temperature Control.....	77
4.15 High Pressure Control in Cooling .....	78
4.16 Compressor System Sensor Abnormality .....	79
4.17 Position Sensor Abnormality .....	80
4.18 CT or Related Abnormality .....	82
4.19 Thermistor or Related Abnormality (Outdoor Unit).....	84
4.20 Electrical Box Temperature Rise .....	86
4.21 Radiation Fin Temperature Rise .....	88
4.22 Output Overcurrent Detection .....	90
4.23 Refrigerant Shortage .....	92
4.24 Low-voltage Detection or Over-voltage Detection.....	94
4.25 Signal Transmission Error on Outdoor Unit PCB .....	95
5. Check .....	96
5.1 How to Check.....	96

# 1. Caution for Diagnosis

## 1.1 Troubleshooting with LED

### Indoor Unit

The operation lamp blinks when any of the following errors is detected.

1. When a protection device of the indoor or outdoor unit is activated or when the thermistor malfunctions.
  2. When a signal transmission error occurs between the indoor and outdoor units.
- In either case, conduct the diagnostic procedure described in the following pages.

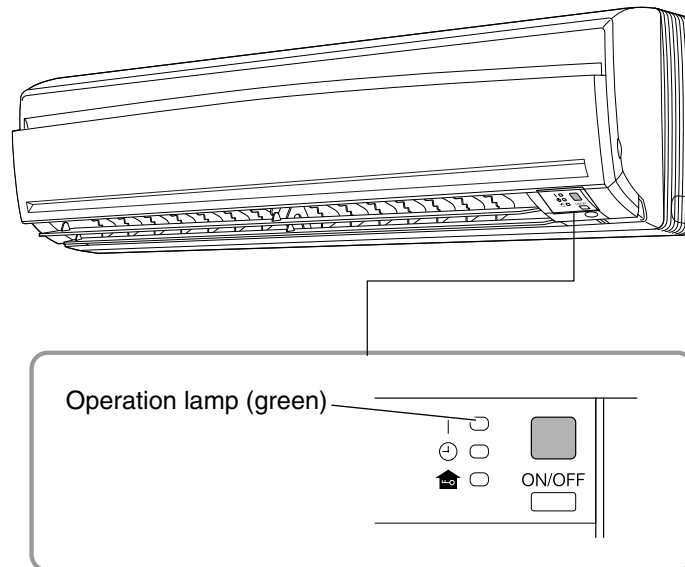

(R6332)

### Outdoor Unit

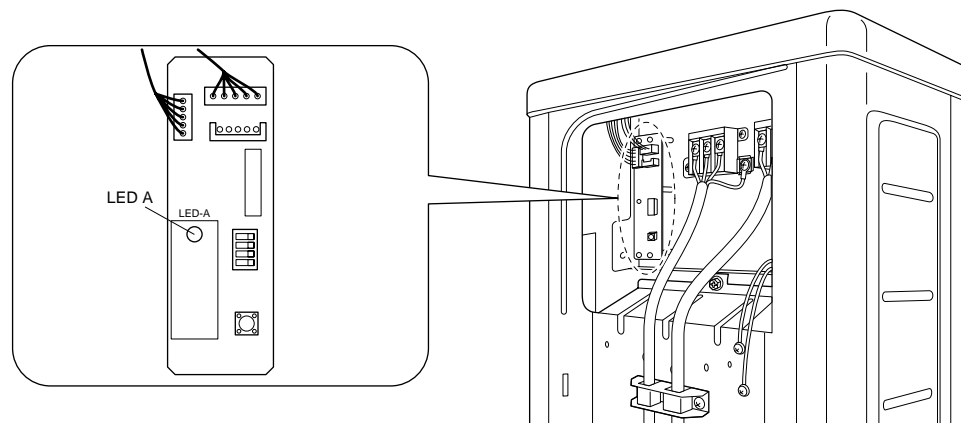

(R6980)

The outdoor unit has one green LED (LED A) on the PCB. When the LED A blinks, the microcomputer works in order.

## 2. Problem Symptoms and Measures

Symptom	Check Item	Details of Measure	Reference Page
The unit does not operate.	Check the power supply.	Check to make sure that the rated voltage is supplied.	—
	Check the type of the indoor units.	Check to make sure that the indoor unit type is compatible with the outdoor unit.	—
	Check the outdoor temperature.	Heating operation cannot be used when the outdoor temperature is 18°C or higher, and cooling operation cannot be used when the outdoor temperature is below -10°C.	—
	Diagnose with remote controller indication.	—	61
	Check the remote controller addresses.	Check to make sure that address settings for the remote controller and indoor unit are correct.	—
Operation sometimes stops.	Check the power supply.	A power failure of 2 to 10 cycles stops air conditioner operation. (Operation lamp OFF)	—
	Check the outdoor temperature.	Heating operation cannot be used when the outdoor temperature is 18°C or higher, and cooling operation cannot be used when the outdoor temperature is below -10°C.	—
	Diagnose with remote controller indication.	—	61
The unit operates but does not cool, or does not heat.	Check for wiring and piping errors in the connection between the indoor and outdoor units.	Conduct the wiring/piping error check described on the product diagnosis label.	—
	Check for thermistor detection errors.	Check to make sure that the thermistor is mounted securely.	—
	Check for faulty operation of the electronic expansion valve.	Conduct cooling operation, and check the temperature of the liquid pipe to see if the electronic expansion valve works.	—
	Diagnose with remote controller indication.	—	61
	Diagnose by service port pressure and operating current.	Check for refrigerant shortage.	92
Large operating noise and vibrations	Check the output voltage of the power module.	—	101
	Check the power module.	—	—
	Check the installation condition.	Check to make sure that the required spaces for installation (specified in the installation manual, etc.) are provided.	—

### 3. Service Check Function

**Check Method 1**

1. When the timer cancel button is held down for 5 seconds, “00” indication appears on the temperature display section.

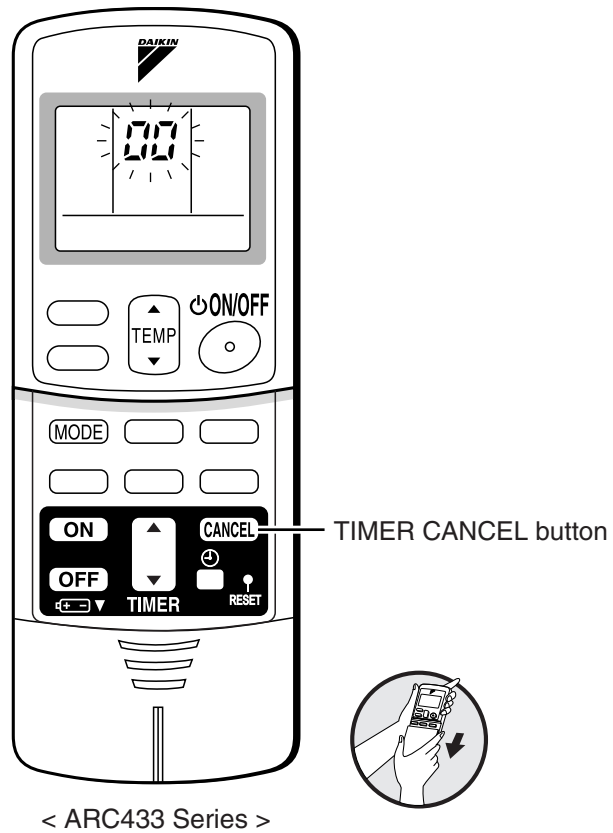

(R11506)

2. Press the timer cancel button repeatedly until a long beep sounds.

■ The code indication changes in the sequence shown below.

No.	Code	No.	Code	No.	Code
1	00	12	C7	23	H0
2	U4	13	H8	24	E1
3	F3	14	J3	25	P4
4	E6	15	R3	26	L3
5	L5	16	R1	27	L4
6	R6	17	C4	28	H6
7	E5	18	C5	29	H7
8	F6	19	H9	30	U2
9	C9	20	J6	31	U4
10	U0	21	U9	32	E9
11	E7	22	R5	33	R4



**Note:**

1. A short beep “pi” and two consecutive beeps “pi pi” indicate non-corresponding codes.
2. To return to the normal mode, hold the timer cancel button down for 5 seconds. When the remote controller is left untouched for 60 seconds, it also returns to the normal mode.



## Check Method 2

1. Press the center of the TEMP button and the MODE button at the same time.

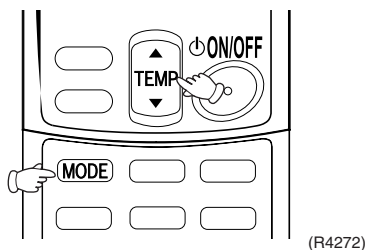

The figure of the ten's place blinks.

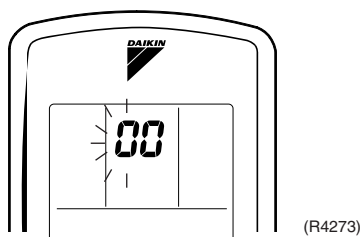

2. Press the TEMP▲ or ▼ button and change the figure until you hear the sound of “beep” or “pi pi”.

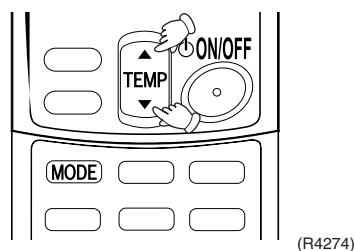

3. Diagnose by the sound.
  - ★“pi” : The figure of the ten's place does not accord with the error code.
  - ★“pi pi” : The figure of the ten's place accords with the error code but the one's not.
  - ★“beep” : The both figures of the ten's and one's place accord with the error code.
 (→See 7.)

4. Press the MODE button.

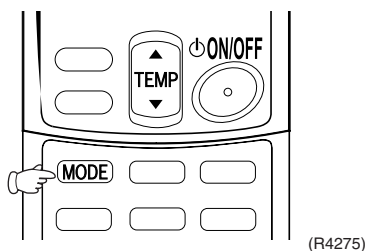

The figure of the one's place blinks.

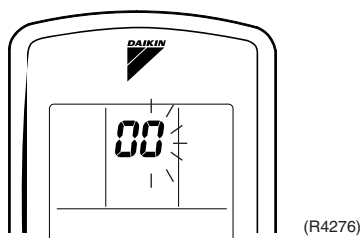

5. Press the TEMP▲ or ▼ button and change the figure until you hear the sound of “beep”.

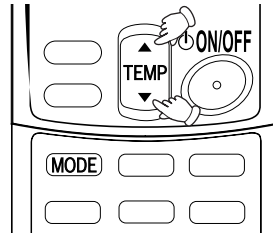

(R4277)

6. Diagnose by the sound.
- ★“pi” : The figure of the ten’s place does not accord with the error code.
  - ★“pi pi” : The figure of the ten’s place accords with the error code but the one’s not.
  - ★“beep” : The both figures of the ten’s and one’s place accord with the error code.

7. Determine the error code.

The figures indicated when you hear the “beep” sound are error code.  
(Error codes and description → Refer to page 61.)

8. Press the MODE button to exit from the diagnosis mode.

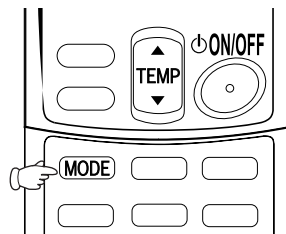

(R4278)

The display “ 7 - ” means the trial operation mode.  
(Refer to page 175 for trial operation.)

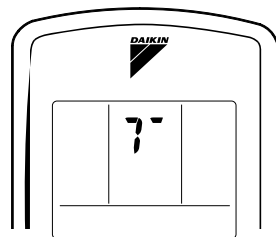

(R9669)

9. Press the ON/OFF button twice to return to the normal mode.

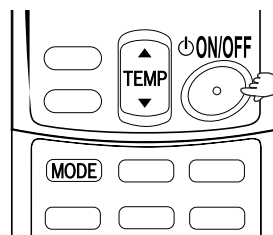

(R9670)



**Note:** When the remote controller is left untouched for 60 seconds, it returns to the normal mode.

## 4. Troubleshooting

### 4.1 Error Codes and Description

	Error Codes	Description	Reference Page
System	00	Normal	—
	U0★	Refrigerant shortage	92
	U2	Low-voltage detection or over-voltage detection	94
	U4	Signal transmission error (between indoor unit and outdoor unit)	67
	U8	Unspecified voltage (between indoor unit and outdoor unit)	69
Indoor Unit	P1	Indoor unit PCB abnormality	62
	P5	Freeze-up protection control or heating peak-cut control	63
	P6	Fan motor or related abnormality	64
	C4	Indoor heat exchanger thermistor or related abnormality	66
	C9	Room temperature thermistor or related abnormality	66
Outdoor Unit	E1	Outdoor unit PCB abnormality	70
	E5★	OL activation (compressor overload)	71
	E6★	Compressor lock	72
	E7	DC fan lock	73
	E8	Input overcurrent detection	74
	E9	Four way valve abnormality	75
	F3	Discharge pipe temperature control	77
	F6	High pressure control in cooling	78
	H0	Compressor system sensor abnormality	79
	H6	Position sensor abnormality	80
	H8	CT or related abnormality	82
	H9	Outdoor temperature thermistor or related abnormality	84
	J3	Discharge pipe thermistor or related abnormality	84
	J6	Outdoor heat exchanger thermistor or related abnormality	84
	L3	Electrical box temperature rise	86
	L4	Radiation fin temperature rise	88
	L5	Output overcurrent detection	90
	P4	Radiation fin thermistor or related abnormality	84
	U7	Signal transmission error (on outdoor unit PCB)	95

★: Displayed only when system-down occurs.

## 4.2 Indoor Unit PCB Abnormality

<b>Remote Controller Display</b>	E1
<b>Method of Malfunction Detection</b>	Evaluation of zero-cross detection of power supply by the indoor unit PCB.
<b>Malfunction Decision Conditions</b>	There is no zero-cross detection in approximately 10 seconds.
<b>Supposed Causes</b>	<ul style="list-style-type: none"> <li>■ Wrong models interconnected</li> <li>■ Defective indoor unit PCB</li> <li>■ Disconnection of connector</li> </ul>

### Troubleshooting

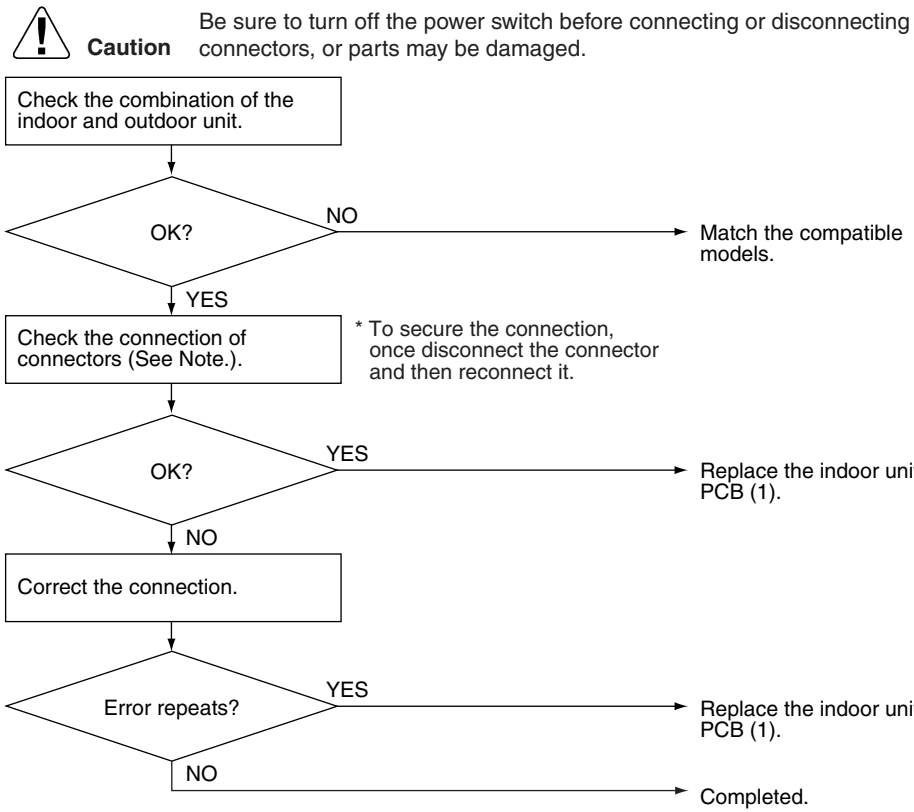

(R11704)

 **Note:** Check the following connector.

Model Type	Connector
Wall Mounted Type	Terminal board ~ Control PCB

### 4.3 Freeze-up Protection Control or Heating Peak-cut Control

Remote Controller Display



Method of Malfunction Detection

- Freeze-up protection control  
During cooling operation, the freeze-up protection control (operation halt) is activated according to the temperature detected by the indoor heat exchanger thermistor.
- Heating peak-cut control  
During heating operation, the temperature detected by the indoor heat exchanger thermistor is used for the heating peak-cut control (operation halt, outdoor fan stop, etc.)

Malfunction Decision Conditions

- Freeze-up protection control  
During cooling operation, the indoor heat exchanger temperature is below 0°C.
- Heating peak-cut control  
During heating operation, the indoor heat exchanger temperature is above 65°C.

Supposed Causes

- Short-circuited air
- Clogged air filter of the indoor unit
- Dust accumulation on the indoor heat exchanger
- Defective indoor heat exchanger thermistor
- Defective indoor unit PCB

Troubleshooting



Check No.06  
Refer to P.98



**Caution**

Be sure to turn off the power switch before connecting or disconnecting connectors, or parts may be damaged.

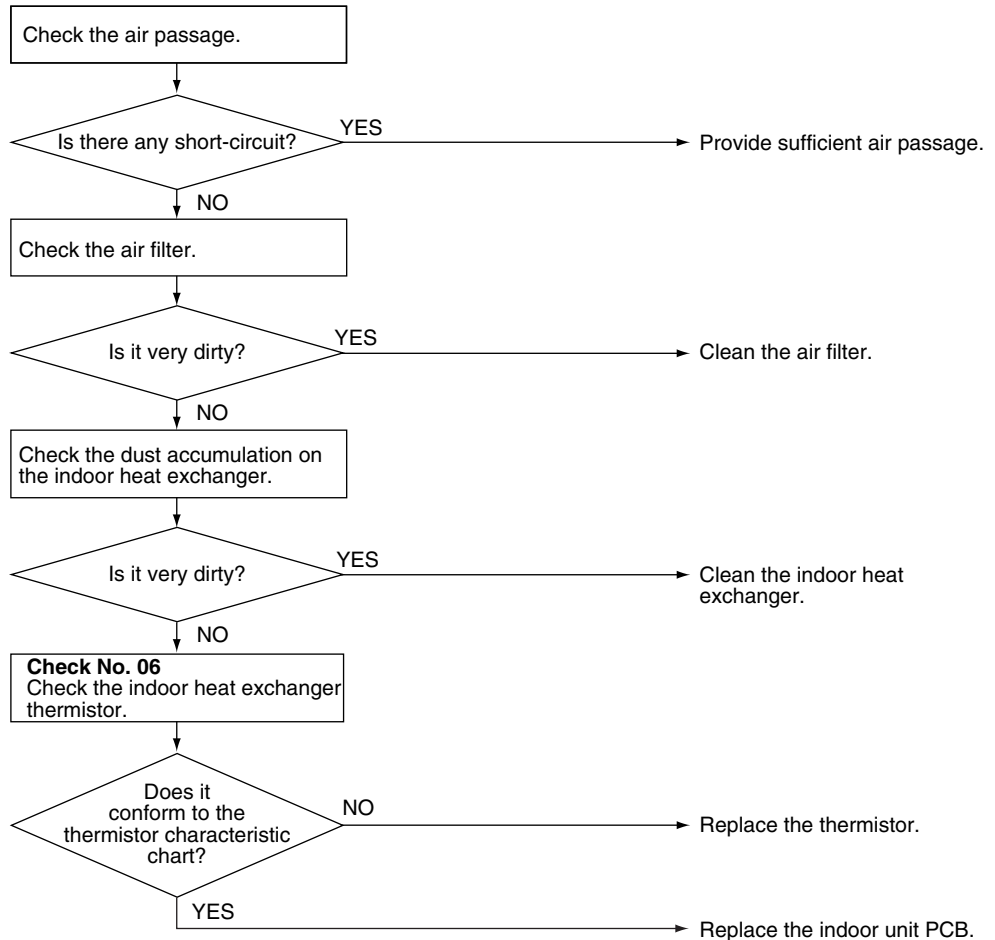

(R7131)

## 4.4 Fan Motor (DC Motor) or Related Abnormality

<p><b>Remote Controller Display</b></p>	
<p><b>Method of Malfunction Detection</b></p>	<p>The rotation speed detected by the Hall IC during fan motor operation is used to determine abnormal fan motor operation.</p>
<p><b>Malfunction Decision Conditions</b></p>	<p>The detected rotation speed does not reach the demanded rotation speed of the target tap, and is less than 50% of the maximum fan motor rotation speed.</p>
<p><b>Supposed Causes</b></p>	<ul style="list-style-type: none"> <li>■ Layer short inside the fan motor winding</li> <li>■ Breakage of wire inside the fan motor</li> <li>■ Breakage of the fan motor lead wires</li> <li>■ Defective capacitor of the fan motor</li> <li>■ Defective indoor unit PCB</li> </ul>

Troubleshooting

  
**Check No.01**  
**Refer to P.96**



**Caution**

Be sure to turn off the power switch before connecting or disconnecting connectors, or parts may be damaged.

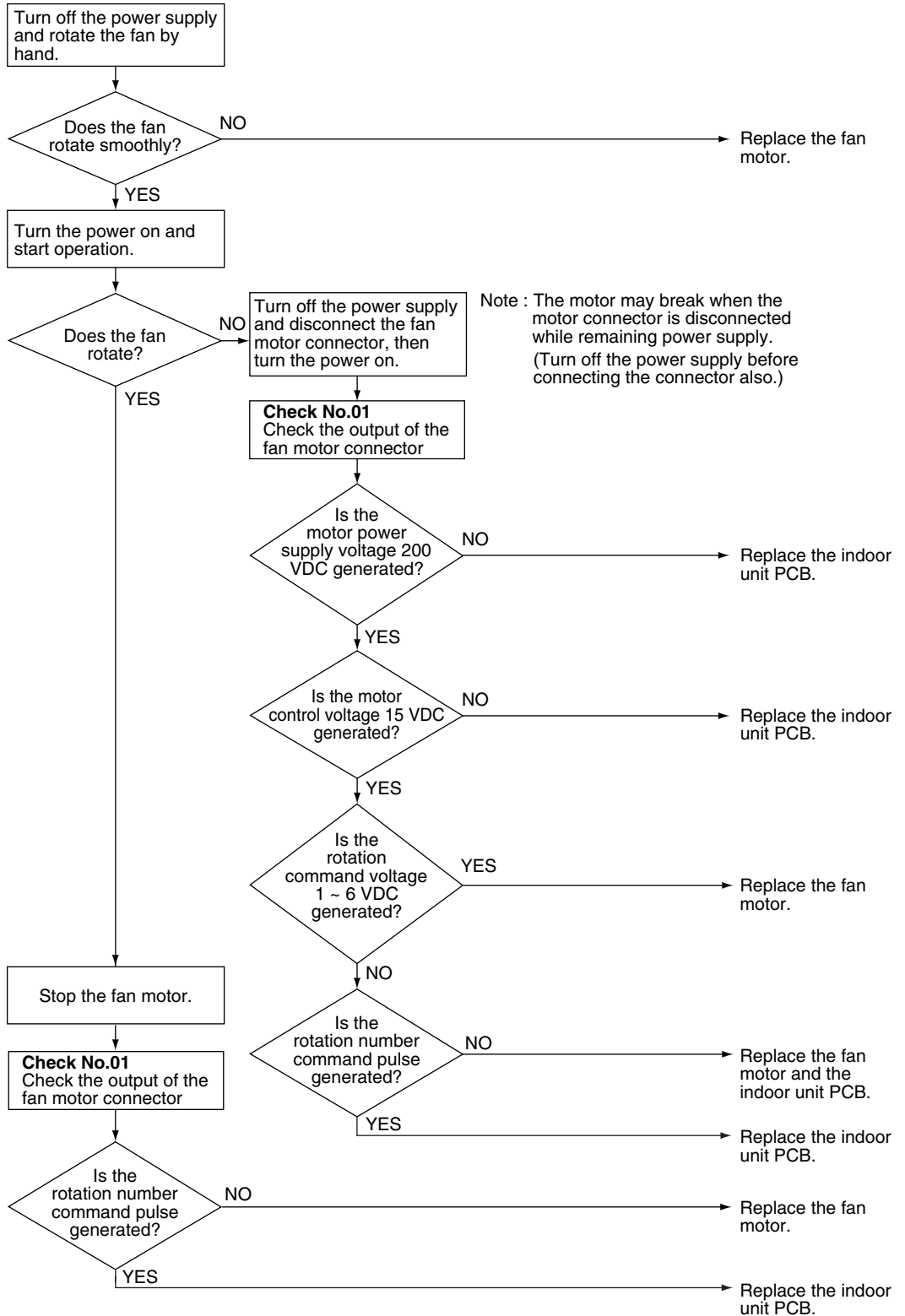

(R11970)

## 4.5 Thermistor or Related Abnormality (Indoor Unit)

<b>Remote Controller Display</b>	⌘4,⌘9
<b>Method of Malfunction Detection</b>	The temperatures detected by the thermistors determine thermistor errors.
<b>Malfunction Decision Conditions</b>	The thermistor input is more than 4.96 V or less than 0.04 V during compressor operation.
<b>Supposed Causes</b>	<ul style="list-style-type: none"> <li>■ Disconnection of connector</li> <li>■ Defective thermistor</li> <li>■ Defective indoor unit PCB</li> </ul>

### Troubleshooting

  
**Check No.06**  
**Refer to P.98**

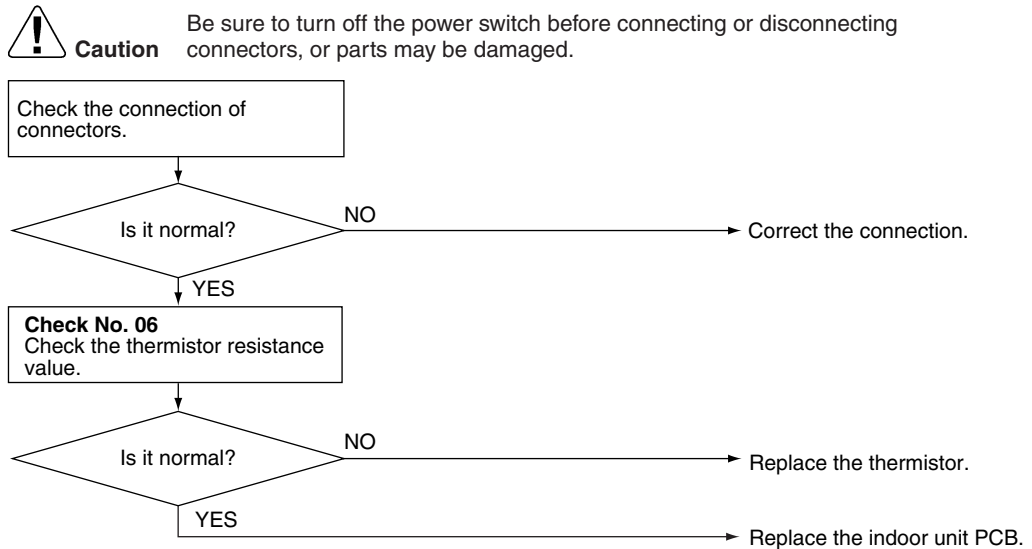

(R7134)

⌘4 : Indoor heat exchanger thermistor  
 ⌘9 : Room temperature thermistor



## 4.6 Signal Transmission Error (between Indoor Unit and Outdoor Unit)

**Remote  
Controller  
Display**



**Method of  
Malfunction  
Detection**

The data received from the outdoor unit is checked whether it is normal.

**Malfunction  
Decision  
Conditions**

The data sent from the outdoor unit cannot be received normally, or the content of the data is abnormal.

**Supposed  
Causes**

- Wiring error
- Breakage of the connection wires between the indoor and outdoor units (wire No. 3)
- Defective outdoor unit PCB
- Defective indoor unit PCB
- Disturbed power supply waveform

Troubleshooting



**Check No.10**  
Refer to P.100



**Caution** Be sure to turn off the power switch before connecting or disconnecting connectors, or parts may be damaged.

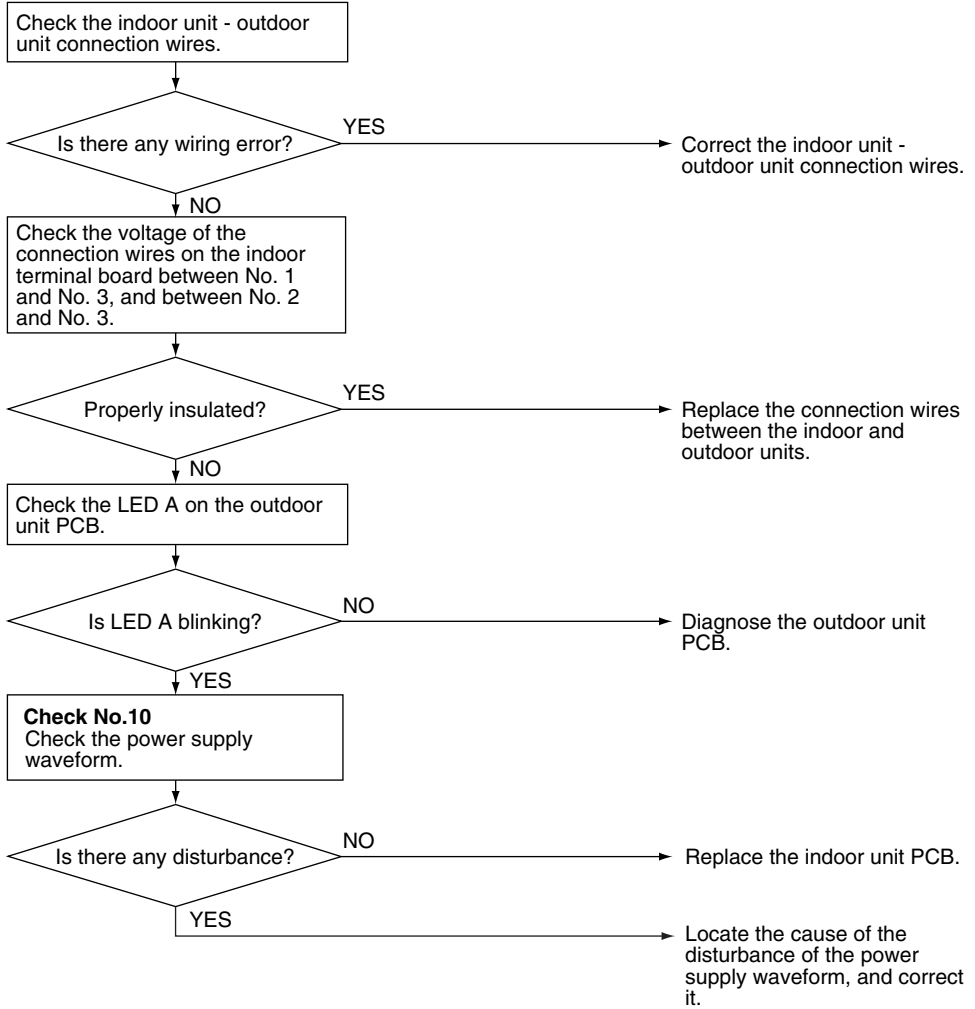

(R12028)

## 4.7 Unspecified Voltage (between Indoor Unit and Outdoor Unit)

Remote  
Controller  
Display

UR

Method of  
Malfunction  
Detection

The supply power is detected for its requirements (different from pair type and multi type) by the indoor / outdoor transmission signal.

Malfunction  
Decision  
Conditions

The pair type and multi type are interconnected.

Supposed  
Causes

- Wrong models interconnected
- Wrong wiring of connection wires
- Wrong indoor unit PCB or outdoor unit PCB mounted
- Defective indoor unit PCB
- Defective outdoor unit PCB

Troubleshooting

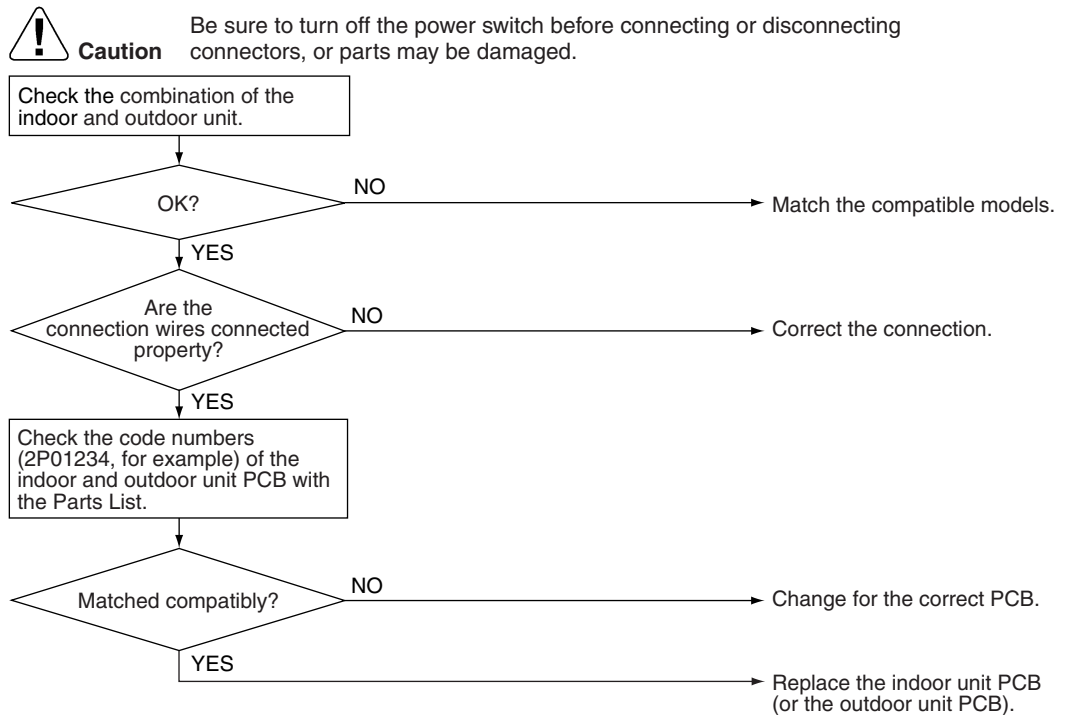

(R11707)

## 4.8 Outdoor Unit PCB Abnormality

Remote  
Controller  
Display

E I

Method of  
Malfunction  
Detection

- Detection within the program of the microcomputer

Malfunction  
Decision  
Conditions

- The program of the microcomputer is in abnormal running order.

Supposed  
Causes

- Defective outdoor unit PCB
- Noise
- Momentary fall of voltage
- Momentary power failure

### Troubleshooting

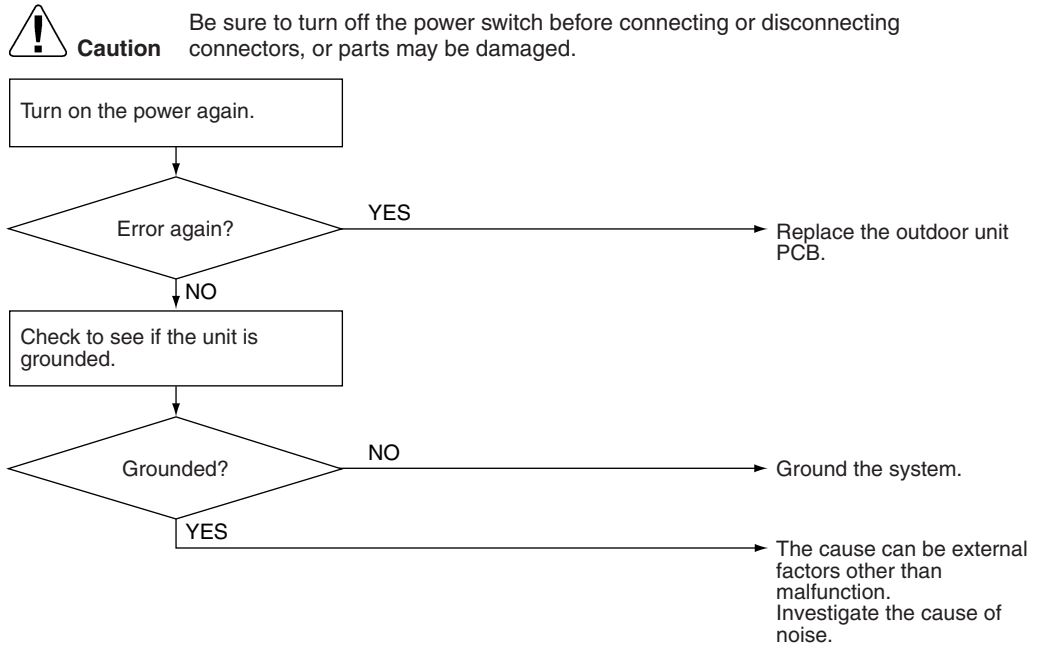





(R7183)

## 4.9 OL Activation (Compressor Overload)

Remote Controller Display	E5
Method of Malfunction Detection	A compressor overload is detected through compressor OL.
Malfunction Decision Conditions	<ul style="list-style-type: none"> <li>■ If the error repeats twice, the system is shut down.</li> <li>■ Reset condition: Continuous run for about 60 minutes without any other error</li> <li>* The operating temperature condition is not specified.</li> </ul>
Supposed Causes	<ul style="list-style-type: none"> <li>■ Defective discharge pipe thermistor</li> <li>■ Defective electronic expansion valve or coil</li> <li>■ Defective four way valve or coil</li> <li>■ Defective outdoor unit PCB</li> <li>■ Refrigerant shortage</li> <li>■ Water mixed in refrigerant</li> <li>■ Defective stop valve</li> </ul>

### Troubleshooting

-  **Check No.04**  
Refer to P.96
-  **Check No.05**  
Refer to P.97
-  **Check No.06**  
Refer to P.98
-  **Check No.11**  
Refer to P.100

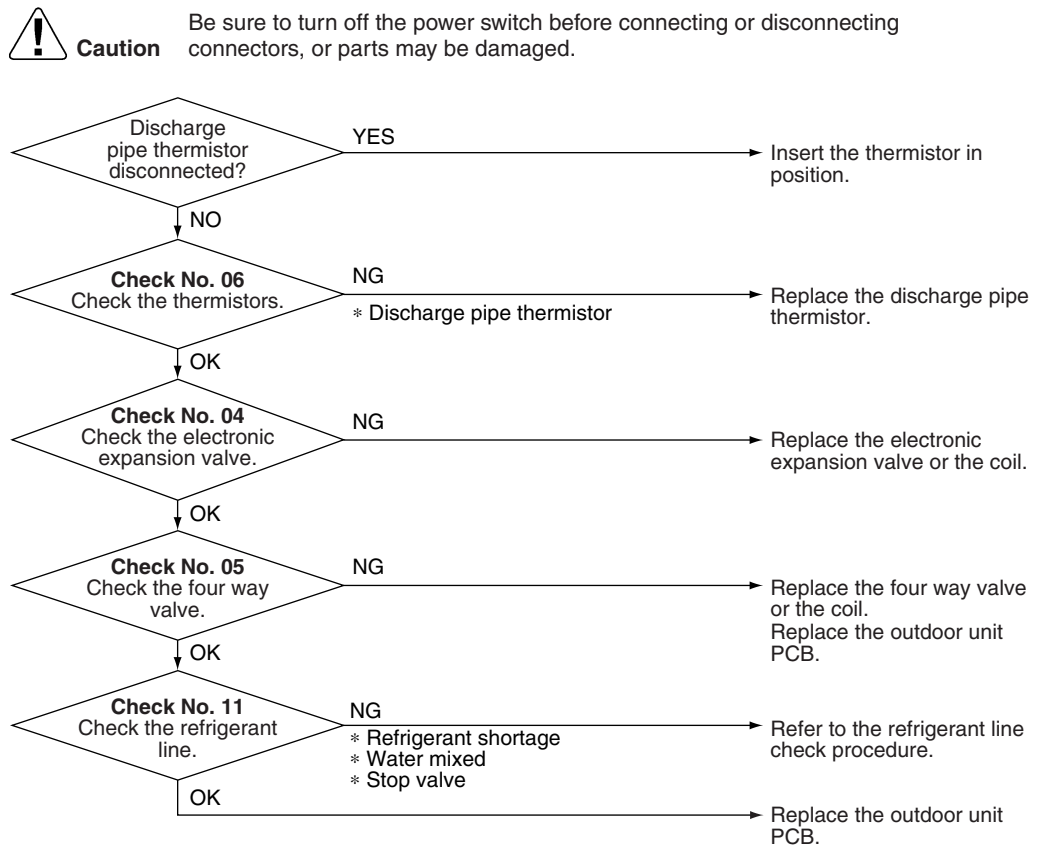

(R11971)

# 4.10 Compressor Lock

<p><b>Remote Controller Display</b></p> 	
<p><b>Method of Malfunction Detection</b></p>	<p>A compressor lock is detected by checking the compressor running condition through the position detection circuit.</p>
<p><b>Malfunction Decision Conditions</b></p>	<ul style="list-style-type: none"> <li>■ Judging from the current waveform generated when high-frequency voltage is applied to the compressor.</li> <li>■ If the error repeats 16 times, the system is shut down.</li> <li>■ Reset condition: Continuous run for about 5 minutes without any other error</li> </ul>
<p><b>Supposed Causes</b></p>	<ul style="list-style-type: none"> <li>■ Compressor locked</li> <li>■ Disconnection of compressor harness</li> </ul>

**Troubleshooting**

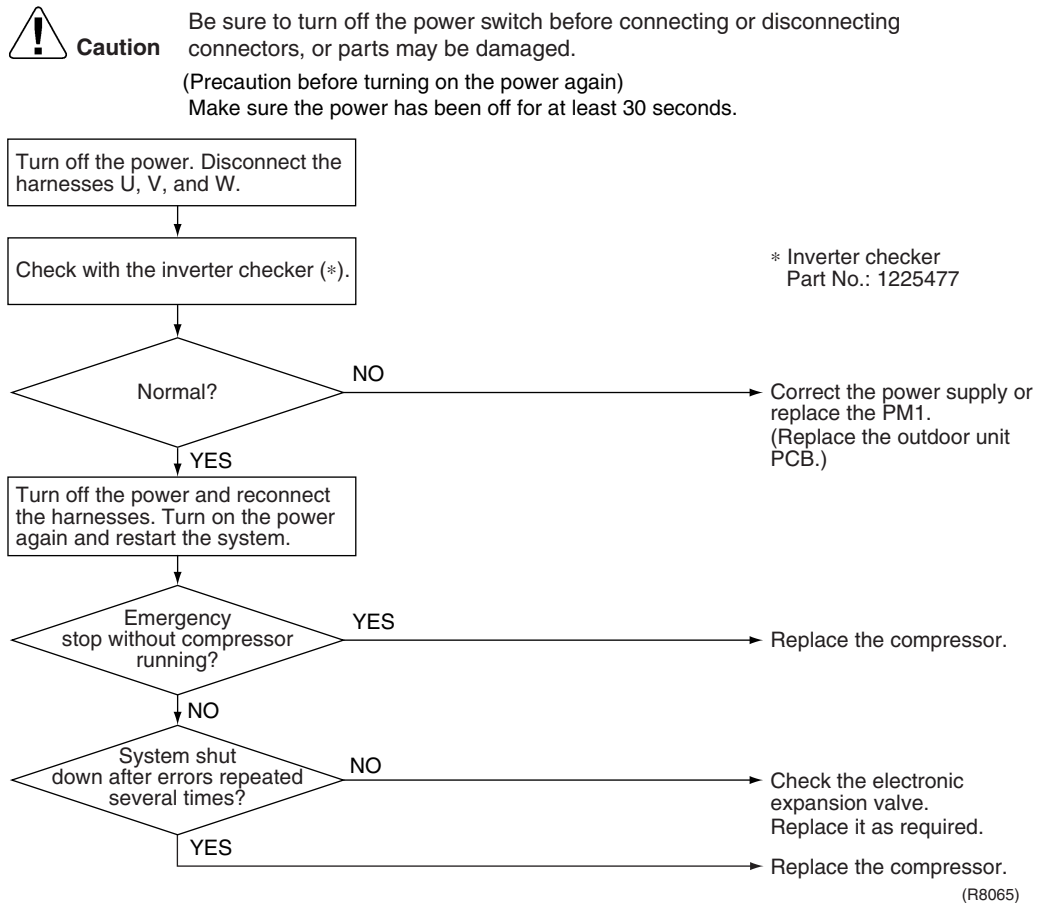

## 4.11 DC Fan Lock

Remote  
Controller  
Display

E7

Method of  
Malfunction  
Detection

An error is determined with the high-voltage fan motor rotation speed detected by the Hall IC.

Malfunction  
Decision  
Conditions

- The fan does not start in 30 seconds even when the fan motor is running.
- If the error repeats 16 times, the system is shut down.
- Reset condition: Continuous run for about 5 minutes without any other error

Supposed  
Causes

- Disconnection of the fan motor
- Foreign matters stuck in the fan
- Defective fan motor
- Defective outdoor unit PCB

### Troubleshooting

  
**Check No.15**  
Refer to P.102

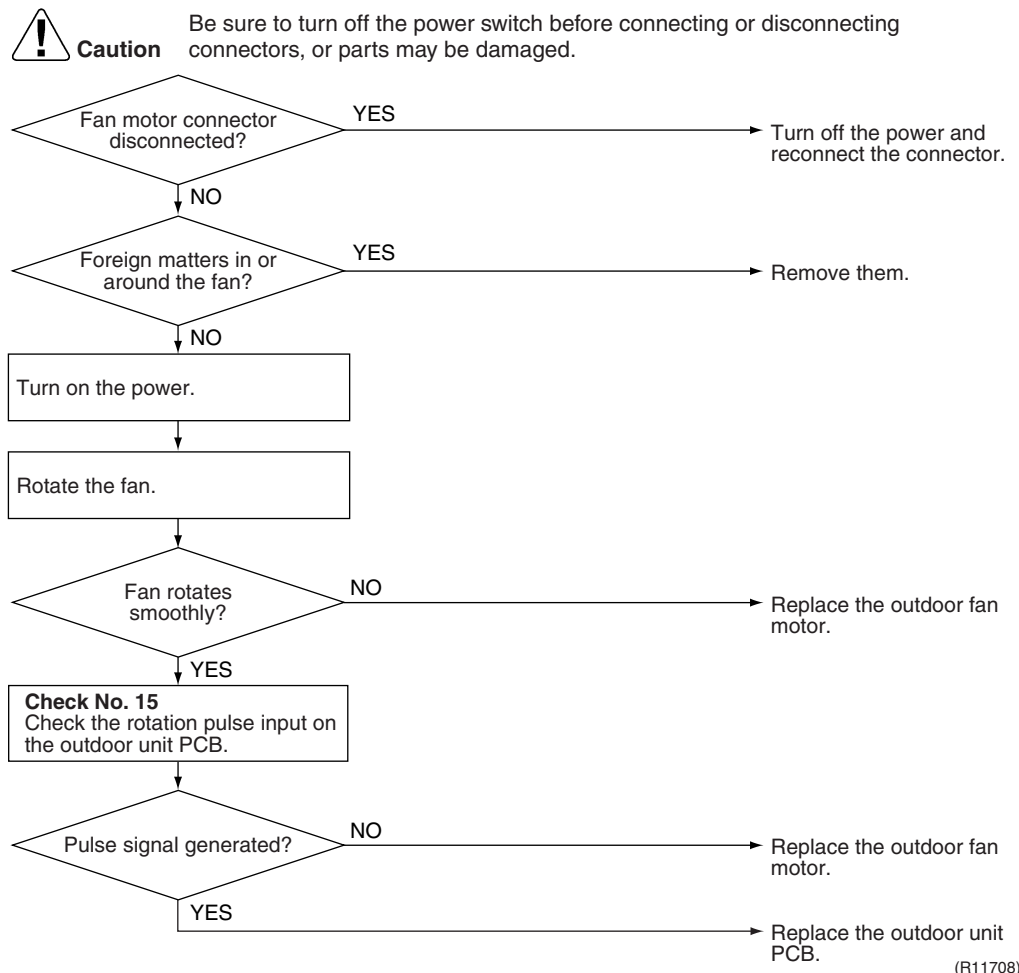

## 4.12 Input Overcurrent Detection

Remote Controller Display	
Method of Malfunction Detection	An input overcurrent is detected by checking the input current value being detected by CT with the compressor running.
Malfunction Decision Conditions	<ul style="list-style-type: none"> <li>■ The following CT input with the compressor running continues for 2.5 seconds. CT input : Above 20 A</li> </ul>
Supposed Causes	<ul style="list-style-type: none"> <li>■ Defective compressor</li> <li>■ Defective power module</li> <li>■ Defective outdoor unit PCB</li> <li>■ Short circuit</li> </ul>

### Troubleshooting

  
**Check No.07**  
**Refer to P.99**

  
**Check No.08**  
**Refer to P.99**

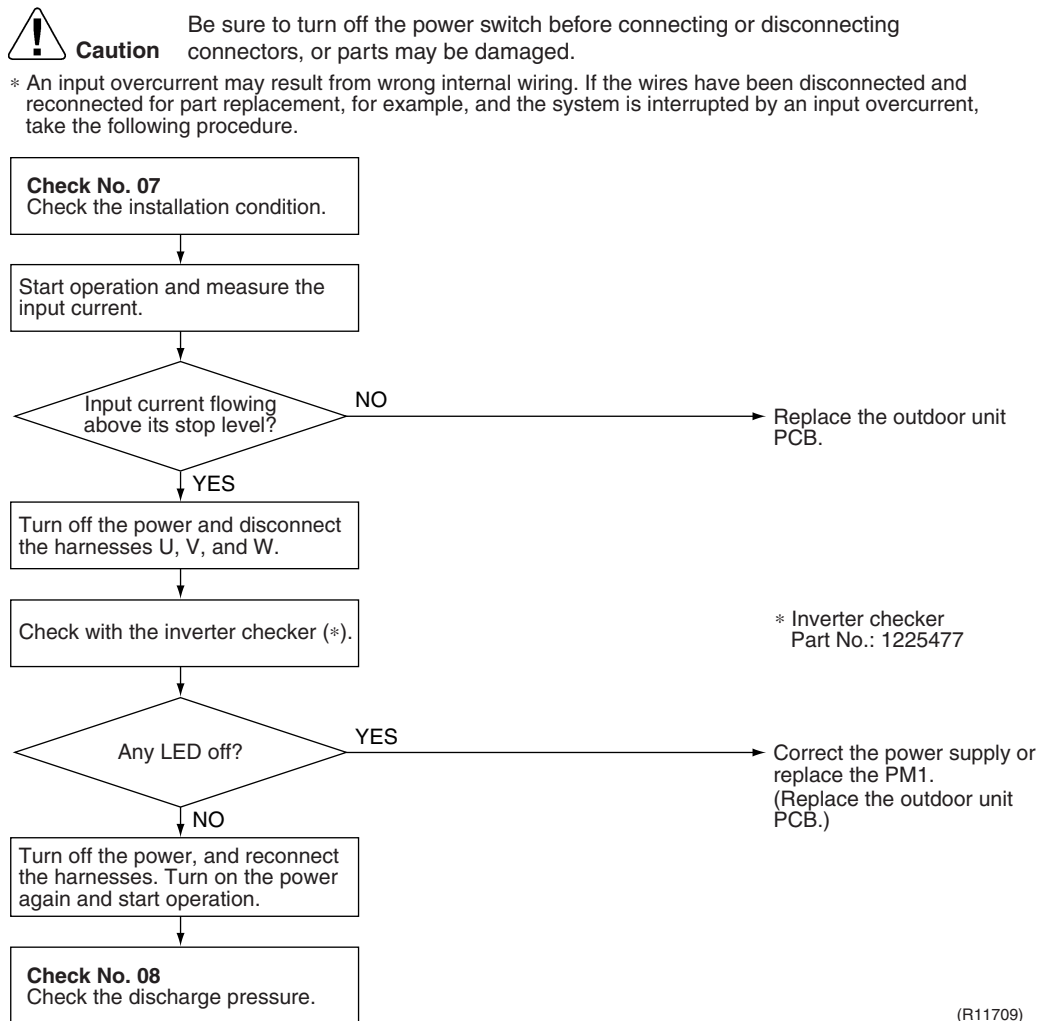



## 4.13 Four Way Valve Abnormality

Remote  
Controller  
Display

EA

Method of  
Malfunction  
Detection

The room temperature thermistor, the indoor heat exchanger thermistor, the outdoor temperature thermistor, and the outdoor heat exchanger thermistor are checked if they function within their normal ranges in each operation mode.

Malfunction  
Decision  
Conditions

- A following condition continues over 1 minute after operating for 10 minutes.
- Cooling / Dry  
(room temp. – indoor heat exchanger temp.) < –5°C
  - Heating  
(indoor heat exchanger temp. – room temp.) < –5°C
  - If the error repeats 5 times, the system is shut down.
  - Reset condition: Continuous run for about 60 minutes without any other error

Supposed  
Causes

- Disconnection of four way valve coil
- Defective four way valve coil or harness
- Defective four way valve
- Defective outdoor unit PCB
- Defective thermistor
- Refrigerant shortage
- Water mixed in refrigerant
- Defective stop valve

Troubleshooting

  
**Check No.05**  
 Refer to P.97

  
**Check No.06**  
 Refer to P.98

  
**Check No.11**  
 Refer to P.100



**Caution** Be sure to turn off the power switch before connecting or disconnecting connectors, or parts may be damaged.

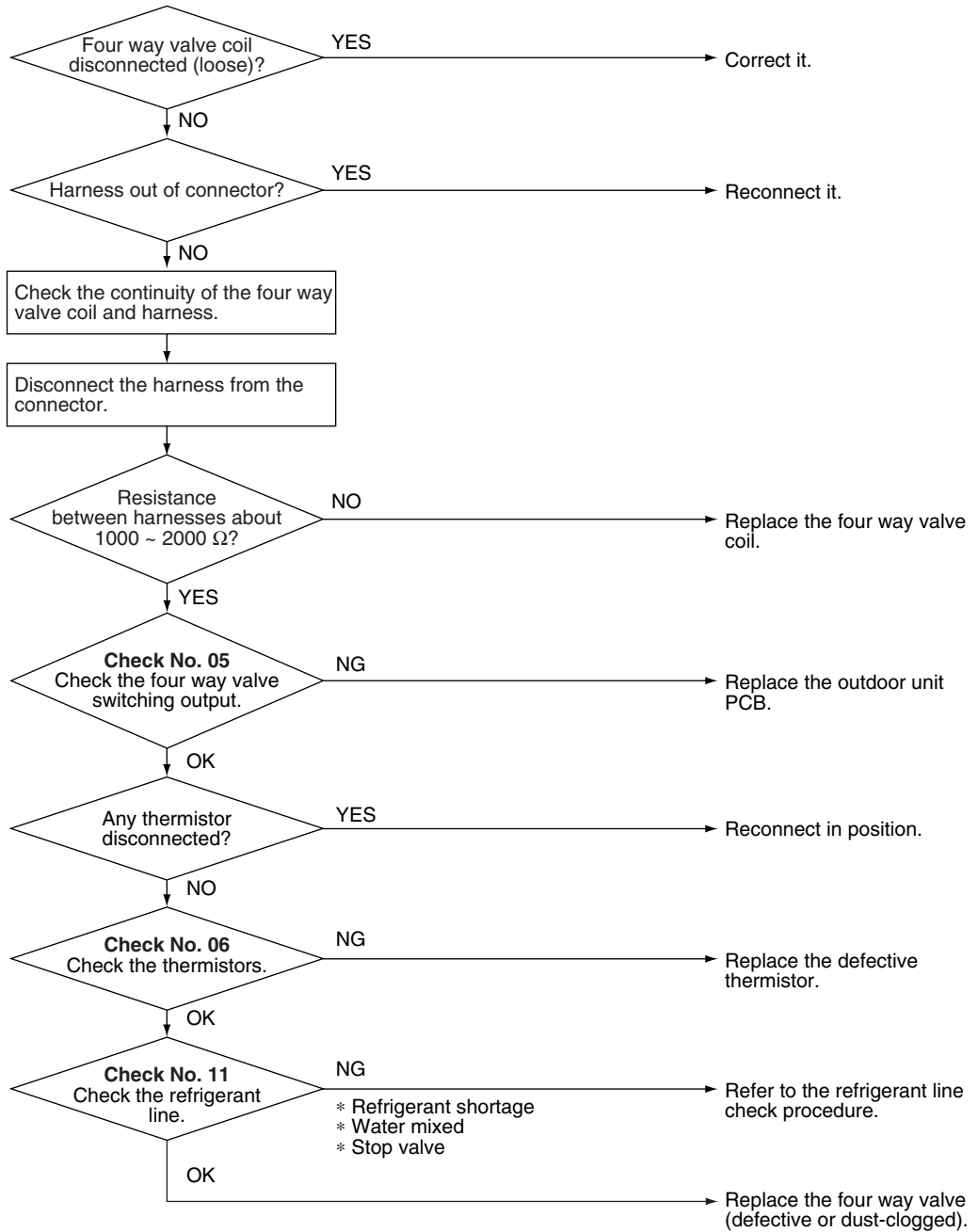



(R11710)

# 4.14 Discharge Pipe Temperature Control

<p><b>Remote Controller Display</b></p> 										
<p><b>Method of Malfunction Detection</b></p>	<p>An error is determined with the temperature detected by the discharge pipe thermistor.</p>									
<p><b>Malfunction Decision Conditions</b></p>	<ul style="list-style-type: none"> <li>■ If the temperature detected by the discharge pipe thermistor rises above <math>\Delta</math> °C, the compressor stops.</li> <li>■ The error is cleared when the temperature is dropped below <math>\text{B}</math> °C.</li> </ul> <table border="1" style="margin: 10px auto;"> <thead> <tr> <th></th> <th><math>\Delta</math> (°C)</th> <th><math>\text{B}</math> (°C)</th> </tr> </thead> <tbody> <tr> <td>50/60 class</td> <td>110</td> <td>95</td> </tr> <tr> <td>71 class</td> <td>120</td> <td>107</td> </tr> </tbody> </table> <ul style="list-style-type: none"> <li>■ If the error repeats 6 times, the system is shut down.</li> <li>■ Reset condition: Continuous run for about 60 minutes without any other error</li> </ul>		$\Delta$ (°C)	$\text{B}$ (°C)	50/60 class	110	95	71 class	120	107
	$\Delta$ (°C)	$\text{B}$ (°C)								
50/60 class	110	95								
71 class	120	107								
<p><b>Supposed Causes</b></p>	<ul style="list-style-type: none"> <li>■ Defective discharge pipe thermistor (Defective outdoor heat exchanger thermistor or outdoor temperature thermistor)</li> <li>■ Defective electronic expansion valve or coil</li> <li>■ Refrigerant shortage</li> <li>■ Defective four way valve</li> <li>■ Water mixed in refrigerant</li> <li>■ Defective stop valve</li> <li>■ Defective outdoor unit PCB</li> </ul>									

**Troubleshooting**

- 

**Check No.04**  
Refer to P.96
- 

**Check No.06**  
Refer to P.98
- 

**Check No.11**  
Refer to P.100

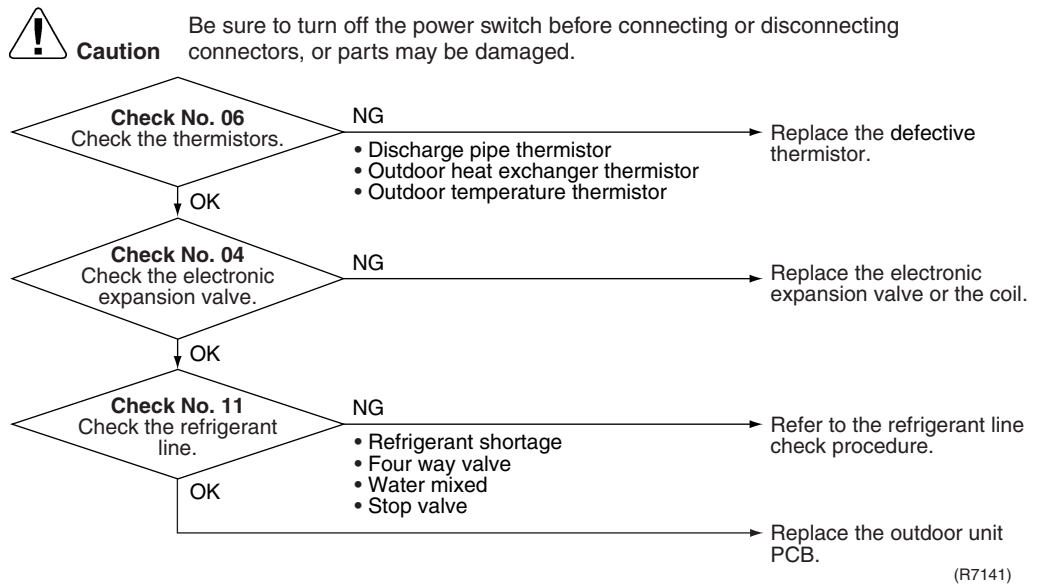

## 4.15 High Pressure Control in Cooling

Remote  
Controller  
Display



Method of  
Malfunction  
Detection

High-pressure control (operation half, frequency drop, etc.) is activated in cooling mode if the temperature sensed by the outdoor heat exchanger thermistor exceeds the limit.

Malfunction  
Decision  
Conditions

- The temperature sensed by the outdoor heat exchanger thermistor rises above about 60°C.
- The error is cleared when the temperature drops below about 50°C.

Supposed  
Causes

- The installation space is not large enough.
- Dirty outdoor heat exchanger
- Defective outdoor fan motor
- Defective stop valve
- Defective electronic expansion valve or coil
- Defective outdoor heat exchanger thermistor
- Defective outdoor unit PCB

### Troubleshooting

- Check No.04**  
Refer to P.96
- Check No.06**  
Refer to P.98
- Check No.07**  
Refer to P.99
- Check No.08**  
Refer to P.99
- Check No.09**  
Refer to P.100

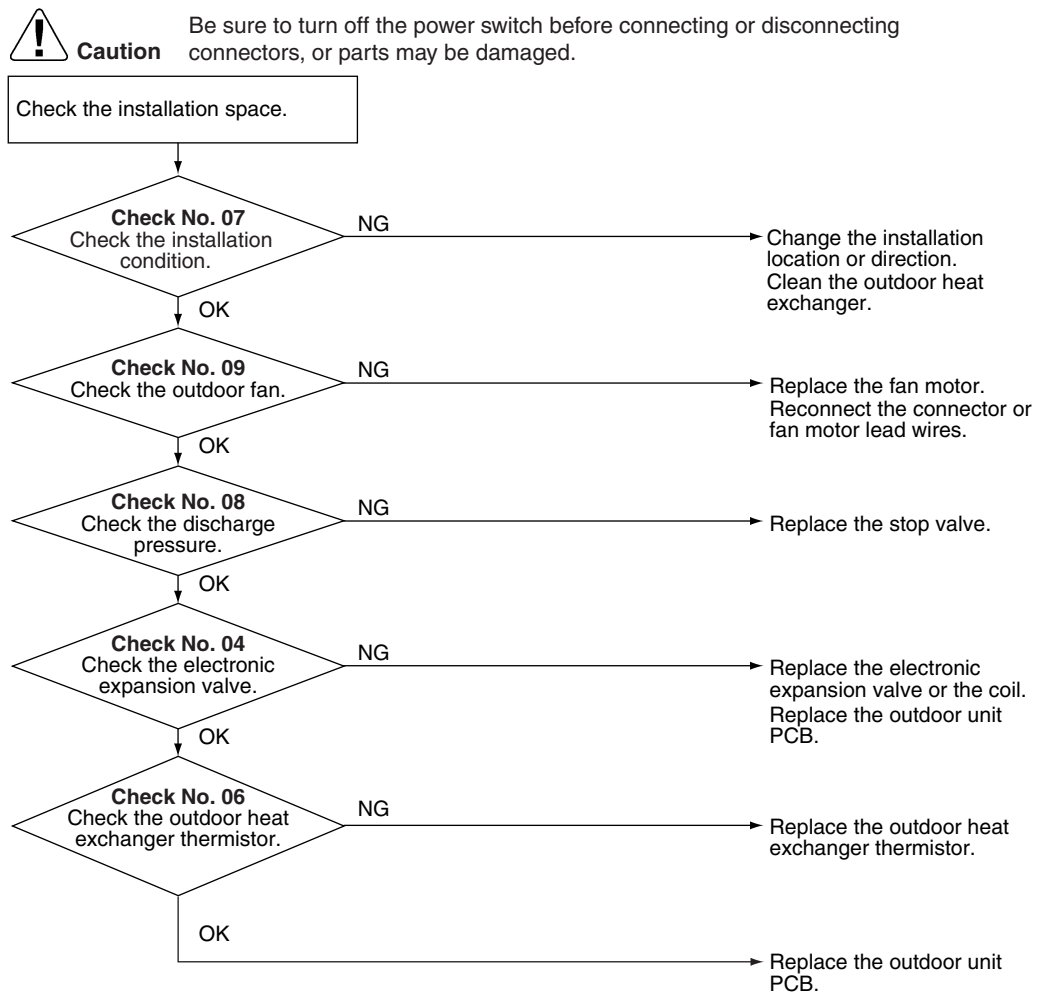

(R11897)

## 4.16 Compressor System Sensor Abnormality

Remote  
Controller  
Display



Method of  
Malfunction  
Detection

- The system checks the supply voltage and the DC voltage before the compressor starts.
- The system checks the compressor current right after the compressor starts.

Malfunction  
Decision  
Conditions

- The supply voltage and the DC voltage is obviously low or high.
- The compressor current does not run when the compressor starts.

Supposed  
Causes

- Disconnection of reactor
- Disconnection of compressor harness
- Defective outdoor unit PCB
- Defective compressor

### Troubleshooting

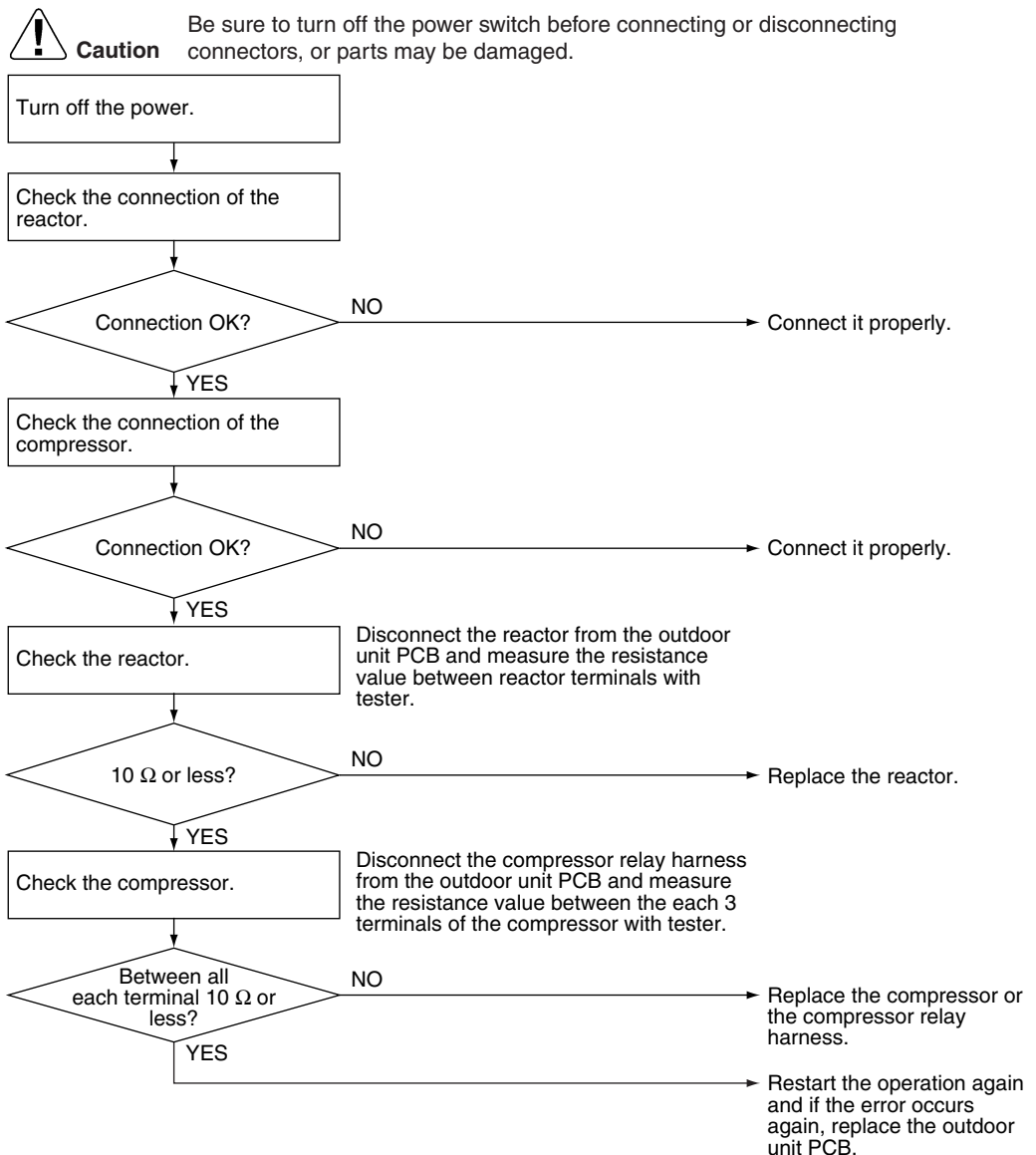

(R7174)

## 4.17 Position Sensor Abnormality

---

Remote  
Controller  
Display



Method of  
Malfunction  
Detection

A compressor start-up failure is detected by checking the compressor running condition through the position detection circuit.

---

Malfunction  
Decision  
Conditions

- If the error repeats 8 times, the system is shut down.
  - Reset condition: Continuous run for about 5 minutes without any other error
- 

Supposed  
Causes

- Disconnection of the compressor relay cable
- Defective compressor
- Defective outdoor unit PCB
- Start-up failure caused by the closed stop valve
- Input voltage out of specification

## Troubleshooting



**Caution** Be sure to turn off the power switch before connecting or disconnecting connectors, or parts may be damaged.

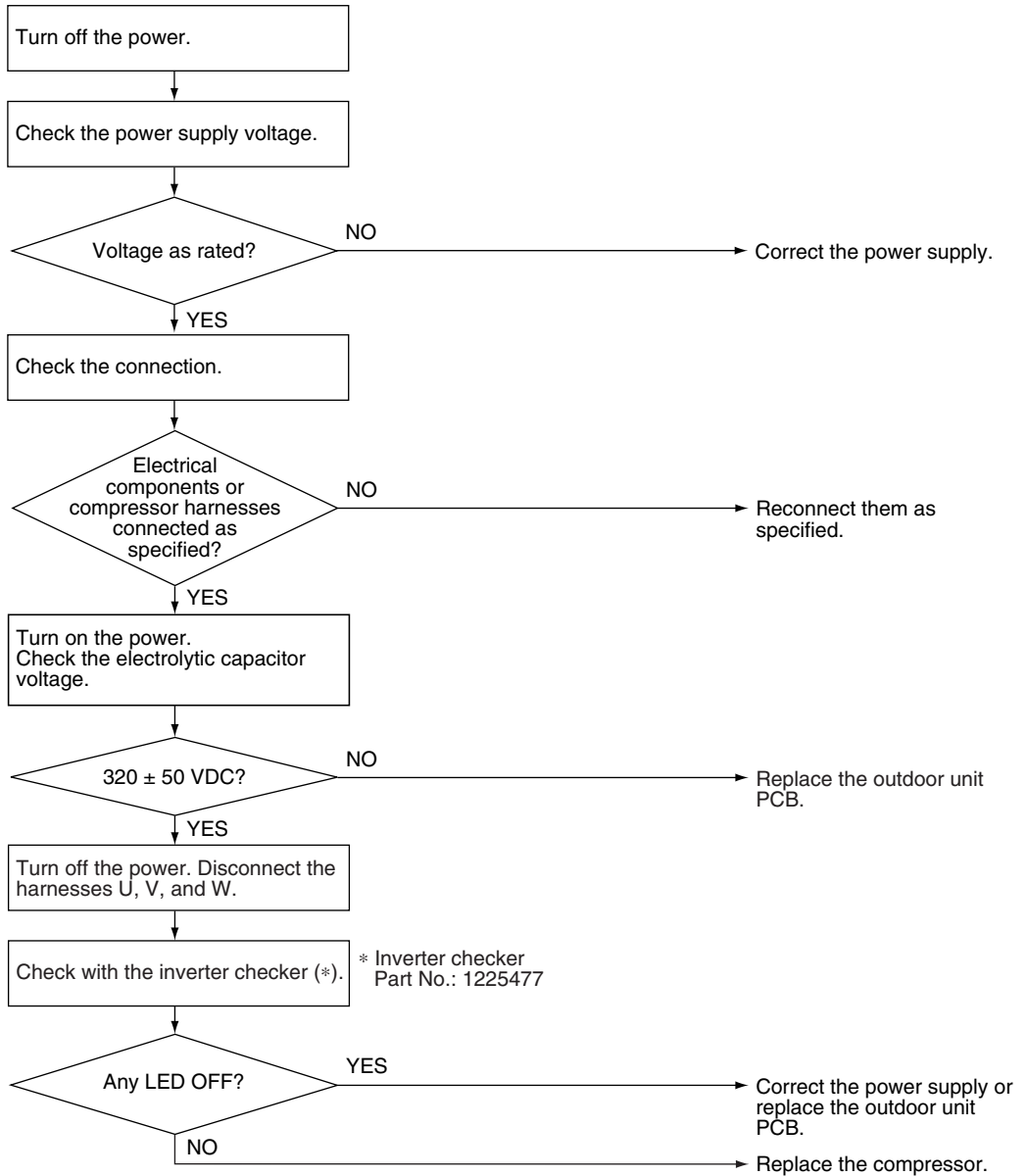

(R11471)

## 4.18 CT or Related Abnormality

Remote  
Controller  
Display



Method of  
Malfunction  
Detection

A CT or related error is detected by checking the compressor running frequency and CT-detected input current.

Malfunction  
Decision  
Conditions

- The compressor running frequency is more than  $\text{A}$  Hz, and the CT input current is below  $\text{B}$  A.

	$\text{A}$ (Hz)	$\text{B}$ (A)
50/60 class	55	0.5
71 class	32	0.5

- If the error repeats 4 times, the system is shut down.
- Reset condition: Continuous run for about 60 minutes without any other error

Supposed  
Causes

- Defective power module
- Breakage of wiring or disconnection
- Defective reactor
- Defective outdoor unit PCB



Troubleshooting



**Check No.12**  
Refer to P.101



**Caution** Be sure to turn off the power switch before connecting or disconnecting connectors, or parts may be damaged.

Turn off the power and turn it on again.

Start operation.

\* Running current as shown at right with relay cable 1 or 2?

YES → Replace the outdoor unit PCB.

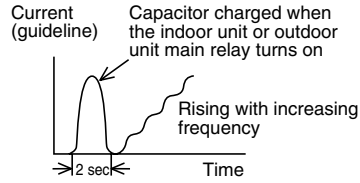

**Check No. 12**  
Check the capacitor voltage.

320 ± 50 VDC?

YES → Turn off the power. Disconnect the harnesses U, V, and W.

Measure the rectifier input voltage.

Check with the inverter checker (\*).  
\* Inverter checker Part No.: 1225477

Any LED OFF?

YES → Correct the power supply or replace the PM1. (Replace the outdoor unit PCB.)

Turn off the power and reconnect the harnesses. Then turn on the power again and restart operation.

Compressor running?

YES → Replace the outdoor unit PCB.

NO → Replace the compressor.

Voltage within the allowable range (Supply voltage ± 15%)?

YES → Replace the outdoor unit PCB.

NO → Check the supply voltage.

(R11134)

## 4.19 Thermistor or Related Abnormality (Outdoor Unit)

<p>Remote Controller Display</p>	<p>H9, U3, UE, P4</p>
<p>Method of Malfunction Detection</p>	<p>This type of error is detected by checking the thermistor input voltage to the microcomputer. A thermistor error is detected by checking the temperature sensed by each thermistor.</p>
<p>Malfunction Decision Conditions</p>	<ul style="list-style-type: none"> <li>■ The thermistor input voltage is above 4.96 V or below 0.04 V with the power on.</li> <li>■ U3 error is judged if the discharge pipe temperature is lower than the outdoor heat exchanger temperature.</li> </ul>
<p>Supposed Causes</p>	<ul style="list-style-type: none"> <li>■ Disconnection of the connector for the thermistor</li> <li>■ Defective thermistor</li> <li>■ Defective heat exchanger thermistor in the case of U3 error (outdoor heat exchanger thermistor in cooling operation, or indoor heat exchanger thermistor in heating operation)</li> <li>■ Defective outdoor unit PCB</li> <li>■ Defective indoor unit PCB</li> </ul>
<p>Troubleshooting</p>	<p><b>In case of "P4"</b></p> <p> <b>Caution</b> Be sure to turn off the power switch before connecting or disconnecting connectors, or parts may be damaged.</p> <p><b>Replace the outdoor unit PCB.</b></p> <p>P4 : Radiation fin thermistor</p>

## Troubleshooting

  
**Check No.06**  
 Refer to P.98

## In case of "H3" "J3" "J5"

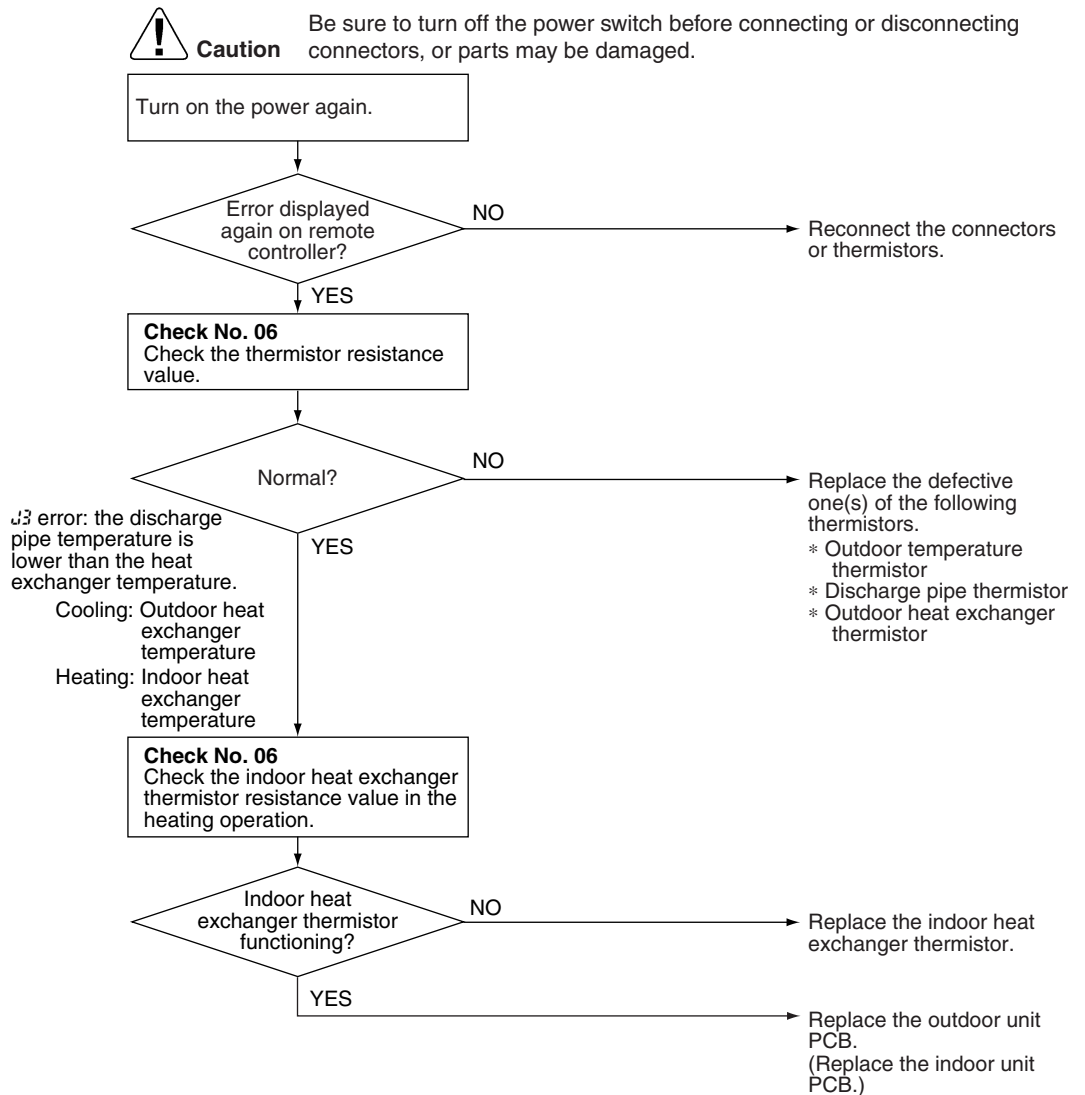

(R11905)

H3 : Outdoor temperature thermistor  
 J3 : Discharge pipe thermistor  
 J5 : Outdoor heat exchanger thermistor

## 4.20 Electrical Box Temperature Rise

Remote  
Controller  
Display



Method of  
Malfunction  
Detection

An electrical box temperature rise is detected by checking the radiation fin thermistor with the compressor off.

Malfunction  
Decision  
Conditions

- With the compressor off, the radiation fin temperature is above A °C.
- The error is cleared when the radiation fin temperature drops below B °C.
- To cool the electrical components, the outdoor fan starts when the radiation fin temperature rises above C °C and stops when it drops below B °C.

	50/60 class	71 class
A (°C)	95	100
B (°C)	80	70
C (°C)	85	85

Supposed  
Causes

- Defective outdoor fan motor
- Short circuit
- Defective radiation fin thermistor
- Disconnection of connector
- Defective outdoor unit PCB

Troubleshooting

 **Check No.07**  
Refer to P.99

 **Check No.09**  
Refer to P.100

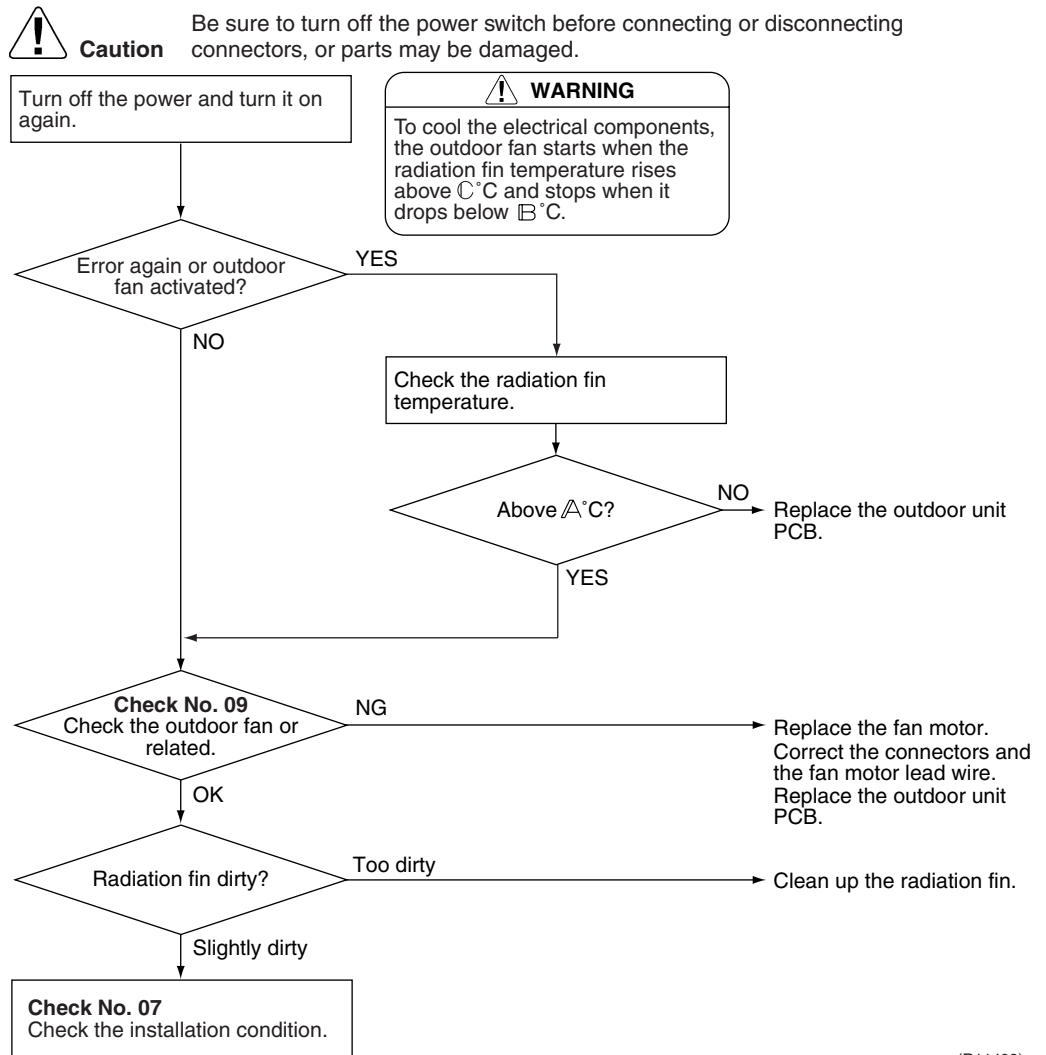

(R11409)

	50/60 class	71 class
A (°C)	95	100
B (°C)	80	70
C (°C)	85	85

## 4.21 Radiation Fin Temperature Rise

Remote  
Controller  
Display

L4

Method of  
Malfunction  
Detection

A radiation fin temperature rise is detected by checking the radiation fin temperature with the compressor on.

Malfunction  
Decision  
Conditions

- The radiation fin temperature with the compressor on is above A °C.
- The error is cleared when the radiation fin temperature drops below B °C.

	50/60 class	71 class
A (°C)	105	105
B (°C)	99	97

- If the error repeats, the system is shut down.
- Reset condition: Continuous run for about 60 minutes without any other error

Supposed  
Causes

- Defective outdoor fan motor
- Short circuit
- Defective radiation fin thermistor
- Disconnection of connector
- Defective outdoor unit PCB
- Silicon grease is not applied properly on the radiation fin after replacing the outdoor unit PCB.

Troubleshooting



**Check No.07**  
Refer to P.99



**Check No.09**  
Refer to P.100



**Caution** Be sure to turn off the power switch before connecting or disconnecting connectors, or parts may be damaged.

Turn off the power and turn it on again to start the system.

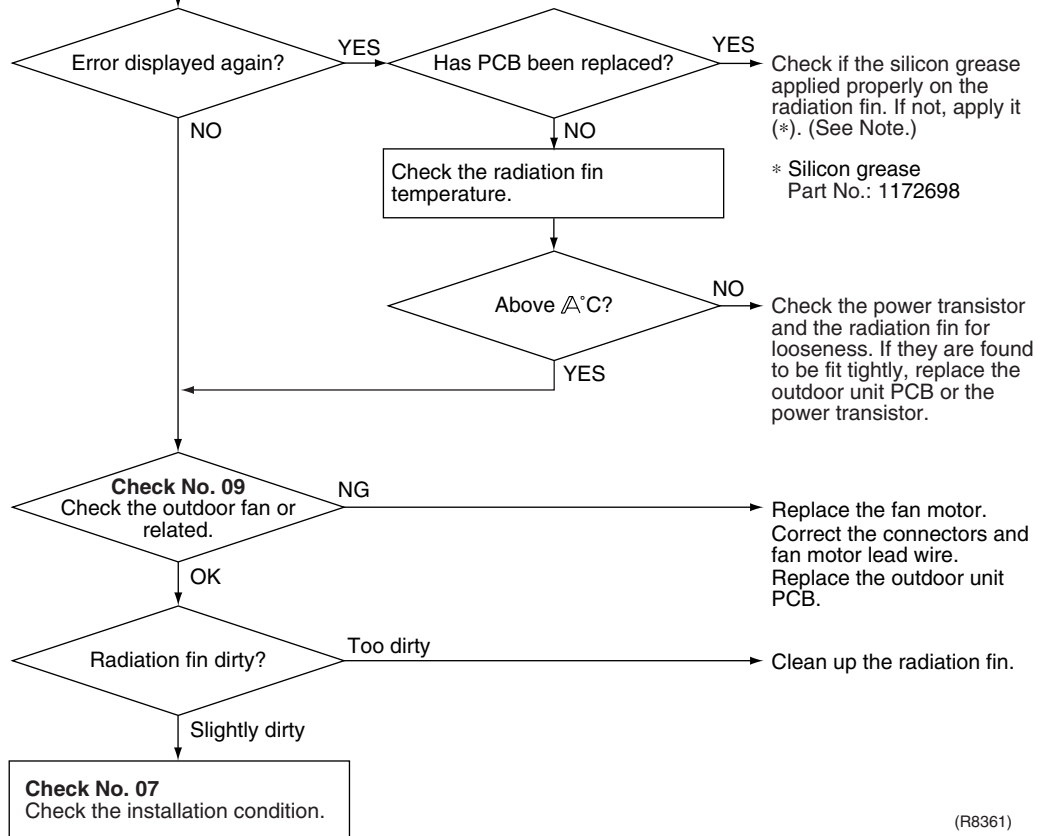

\* Silicon grease  
Part No.: 1172698

(R8361)

	50/60 class	71 class
Δ (°C)	105	105



**Note1:** Refer to “Application of silicon grease to a power transistor and a diode bridge” on page 177 for detail.

## 4.22 Output Overcurrent Detection

Remote  
Controller  
Display

LS

Method of  
Malfunction  
Detection

An output overcurrent is detected by checking the current that flows in the inverter DC section.

Malfunction  
Decision  
Conditions

- A position signal error occurs while the compressor is running.
- A speed error occurs while the compressor is running.
- An output overcurrent signal is fed from the output overcurrent detection circuit to the microcomputer.
- If the error repeats 16 times, the system is shut down.
- Reset condition: Continuous run for about 5 minutes without any other error

Supposed  
Causes

- Poor installation condition
- Closed stop valve
- Defective power module
- Wrong internal wiring
- Abnormal supply voltage
- Defective outdoor unit PCB
- Defective compressor



Troubleshooting



**Check No.07**  
Refer to P.99



**Check No.08**  
Refer to P.99



**Check No.13**  
Refer to P.101

**Caution** Be sure to turn off the power switch before connecting or disconnecting connectors, or parts may be damaged.

\* An output overcurrent signal may result from wrong internal wiring. If the wires have been disconnected and reconnected and the system is interrupted by an output overcurrent, take the following procedure.

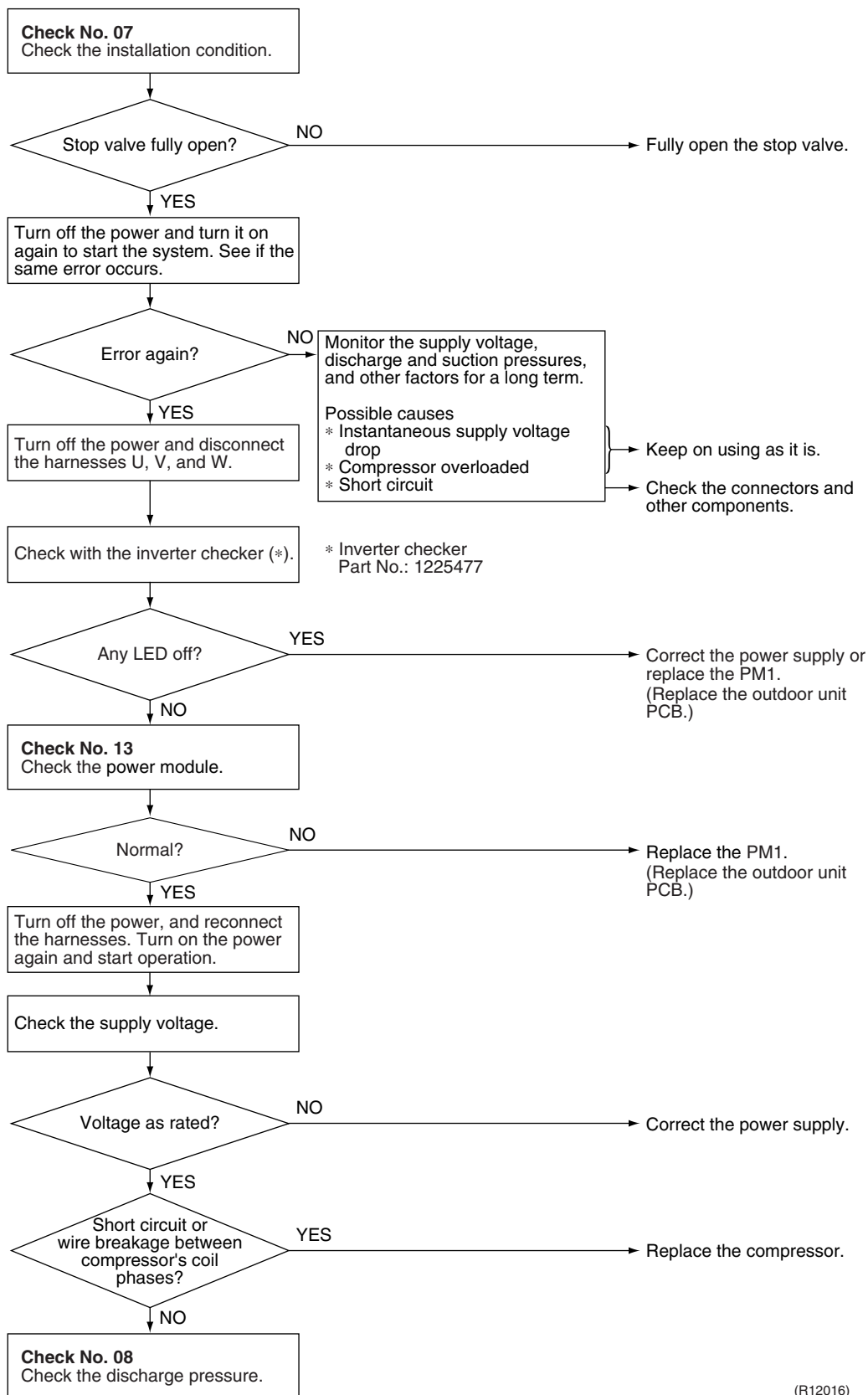

(R12016)

## 4.23 Refrigerant Shortage

Remote  
Controller  
Display



Method of  
Malfunction  
Detection

**Refrigerant shortage detection I:**

Refrigerant shortage is detected by checking the input current value and the compressor output frequency. If the refrigerant is short, the input current is smaller than the normal value.

**Refrigerant shortage detection II:**

Refrigerant shortage is detected by checking the discharge pipe temperature and the opening of the electronic expansion valve. If the refrigerant is short, the discharge pipe temperature tends to rise.

Malfunction  
Decision  
Conditions

**Refrigerant shortage detection I:**

The following conditions continue for 7 minutes.

- ◆ DC current  $\leq \text{A} \times \text{Output frequency} + \text{B}$
- ◆ Output frequency  $> \text{C}$

	A (-)	B (A)	C (Hz)
50/60 class	18/1000	0.7	55
71 class	27/1000	2.0	40

**Refrigerant shortage detection II:**

The following conditions continue for 80 seconds.

- ◆ Target opening of the electronic expansion valve  $\geq \text{D}$
- ◆ Discharge pipe temperature  $> \text{E} \times \text{target discharge pipe temperature} + \text{F}$

	D (pulse)	E (-)	F (°C)
50/60 class	480	255/256	Cooling: 20, Heating: 45
71 class	450	255/256	60

- If the error repeats 4 times, the system is shut down.
- Reset condition: Continuous run for about 60 minutes without any other error

Supposed  
Causes

- Disconnection of the discharge pipe thermistor, indoor or outdoor heat exchanger thermistor, room or outdoor temperature thermistor
- Closed stop valve
- Refrigerant shortage (refrigerant leakage)
- Poor compression performance of compressor
- Defective electronic expansion valve

Troubleshooting



**Check No.04**  
Refer to P.96



**Check No.06**  
Refer to P.98



**Caution**

Be sure to turn off the power switch before connecting or disconnecting connectors, or parts may be damaged.

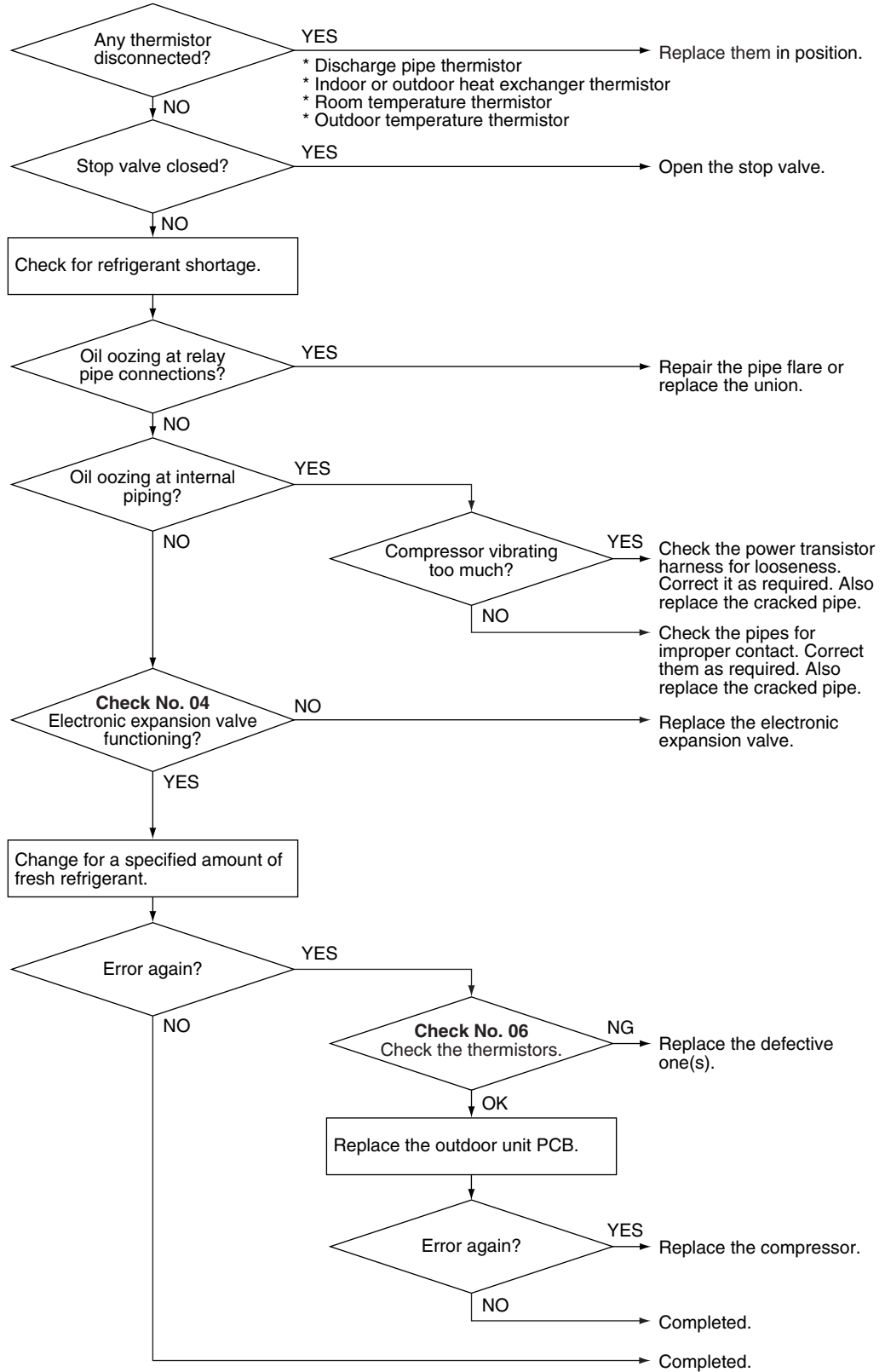

(R12027)

## 4.24 Low-voltage Detection or Over-voltage Detection

<p>Remote Controller Display</p>	<p>U2</p>
<p>Method of Malfunction Detection</p>	<p><b>Low-voltage detection:</b> An abnormal voltage drop is detected by the DC voltage detection circuit.</p> <p><b>Over-voltage detection:</b> An abnormal voltage rise is detected by the over-voltage detection circuit.</p>
<p>Malfunction Decision Conditions</p>	<p><b>Low-voltage detection:</b></p> <ul style="list-style-type: none"> <li>■ The voltage detected by the DC voltage detection circuit is below 150 V.</li> <li>■ If the error repeats 16 times, the system is shut down.</li> <li>■ Reset condition: Continuous run for about 60 minutes without any other error</li> </ul> <p><b>Over-voltage detection:</b></p> <ul style="list-style-type: none"> <li>■ An over-voltage signal is fed from the over-voltage detection circuit to the microcomputer.</li> <li>■ The compressor stops if the error occurs, and restarts automatically after 3-minute standby.</li> </ul>
<p>Supposed Causes</p>	<ul style="list-style-type: none"> <li>■ Supply voltage is not as specified.</li> <li>■ Defective DC voltage detection circuit</li> <li>■ Defective over-voltage detection circuit</li> <li>■ Defective PAM control part</li> <li>■ Layer short inside the fan motor winding</li> </ul>

### Troubleshooting

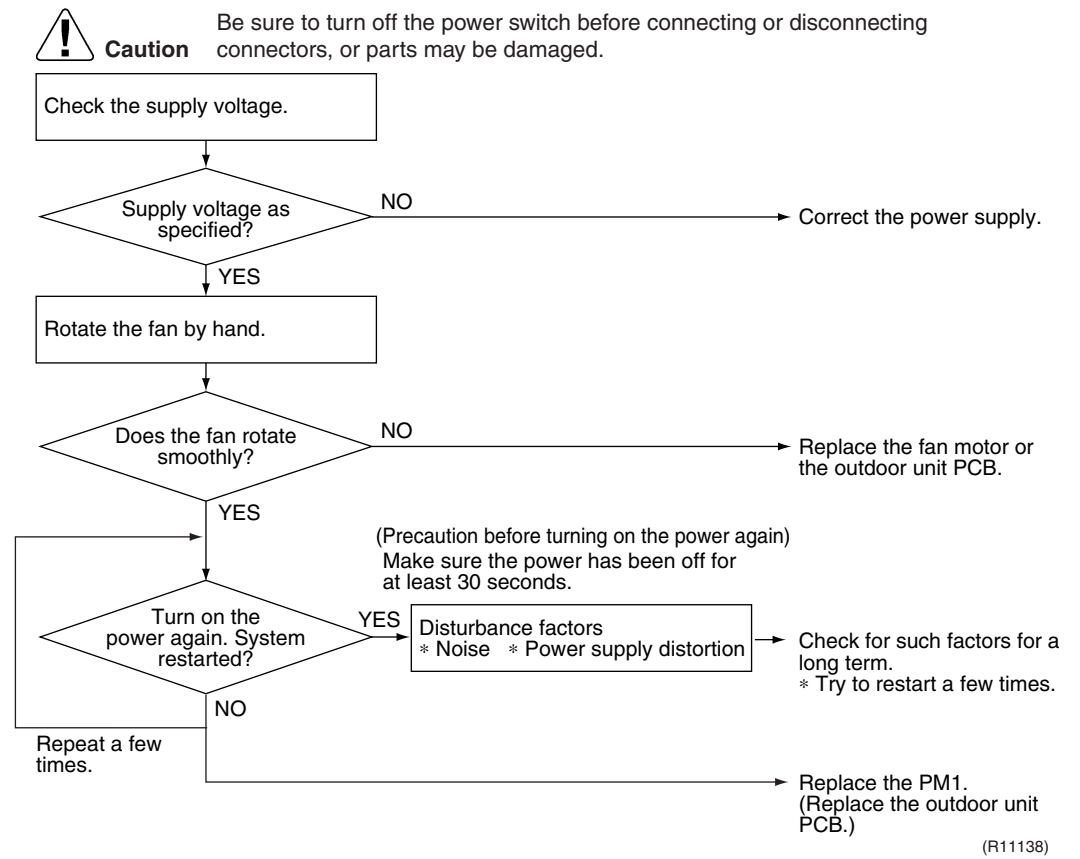

## 4.25 Signal Transmission Error on Outdoor Unit PCB

Remote  
Controller  
Display



Method of  
Malfunction  
Detection

Communication error between microcomputer mounted on the main microcomputer and PM1.

Malfunction  
Decision  
Conditions

- The abnormality is determined when the data sent from the PM1 can not be received for 9 seconds.
- The error counter is reset when the data from the PM1 can be successfully received.

Supposed  
Causes

- Defective outdoor unit PCB

Troubleshooting



**Caution**

Be sure to turn off the power switch before connecting or disconnecting connectors, or parts may be damaged.

Turn off the power and turn it on again.

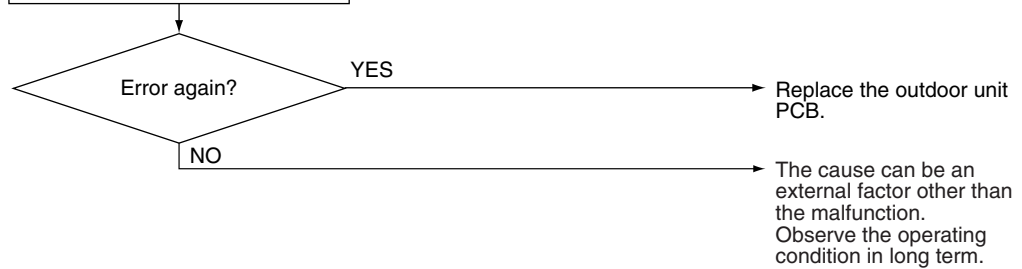

(R7185)

# 5. Check

## 5.1 How to Check

### 5.1.1 Fan Motor Connector Output Check

**Check No.01**

1. Check the connection of connector.
2. Check motor power supply voltage output (pins 4 - 7).
3. Check motor control voltage (pins 4 - 3).
4. Check rotation command voltage output (pins 4 - 2).
5. Check rotation pulse input (pins 4 - 1).

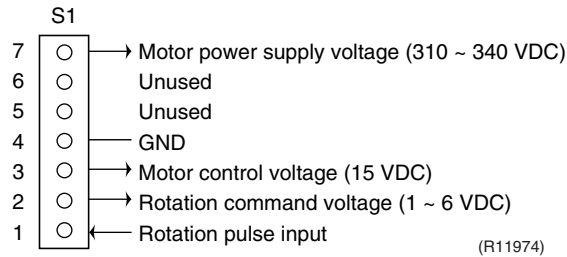

### 5.1.2 Electronic Expansion Valve Check

**Check No.04**

Conduct the followings to check the electronic expansion valve (EV).

1. Check to see if the EV connector is correctly connected to the PCB.
2. Turn the power off and on again, and check to see if the EV generate latching sound.
3. If the EV does not generate latching sound in the above step 2, disconnect the connector and check the continuity using a tester.
4. Check the continuity between the pins 1 - 6 and 3 - 6, and between the pins 2 - 5 and 4 - 5. If there is no continuity between the pins, the EV coil is faulty.

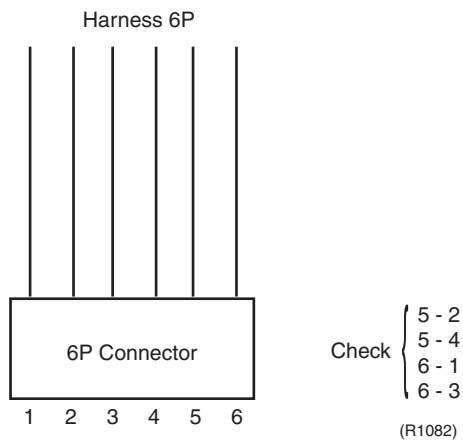

5. If the continuity is confirmed in the above step 3, the outdoor unit PCB is faulty.



**Note:** Please note that the latching sound varies depending on the valve type.

### 5.1.3 Four Way Valve Performance Check

#### Check No.05

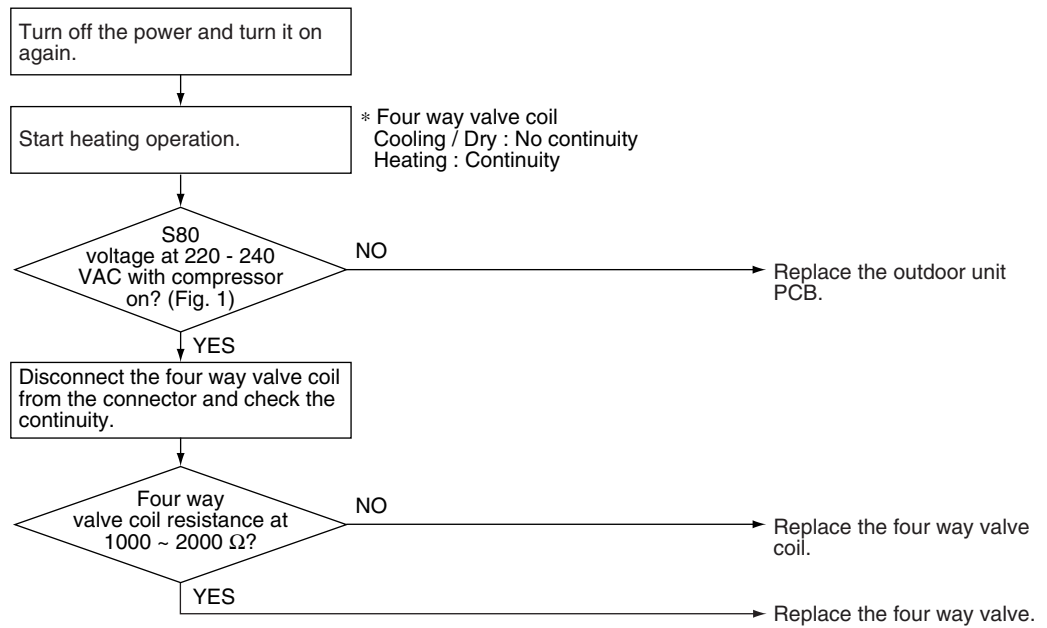

(R11903)

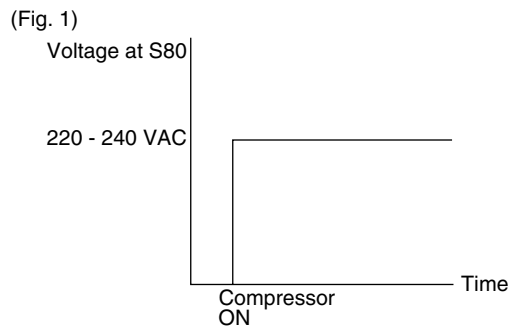

(R11904)

### 5.1.4 Thermistor Resistance Check

**Check No.06**

Disconnect the connectors of the thermistors from the PCB, and measure the resistance of each thermistor using tester.  
 The relationship between normal temperature and resistance is shown in the graph and the table below.

Temperature (°C)	Thermistor R25°C = 20 kΩ, B = 3950
-20	211.0 (kΩ)
-15	150.0
-10	116.5
-5	88.0
0	67.2
5	51.9
10	40.0
15	31.8
20	25.0
25	20.0
30	16.0
35	13.0
40	10.6
45	8.7
50	7.2

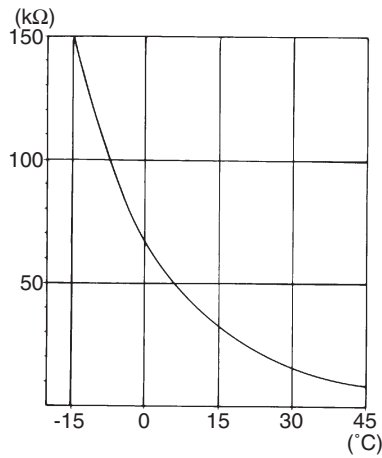

(R11905)

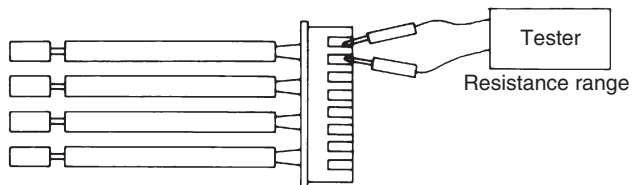

(R11906)

- For the models in which the thermistor is directly mounted on the PCB, disconnect the connector for the PCB and measure.

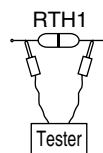

(R3460)



## 5.1.5 Installation Condition Check

### Check No.07

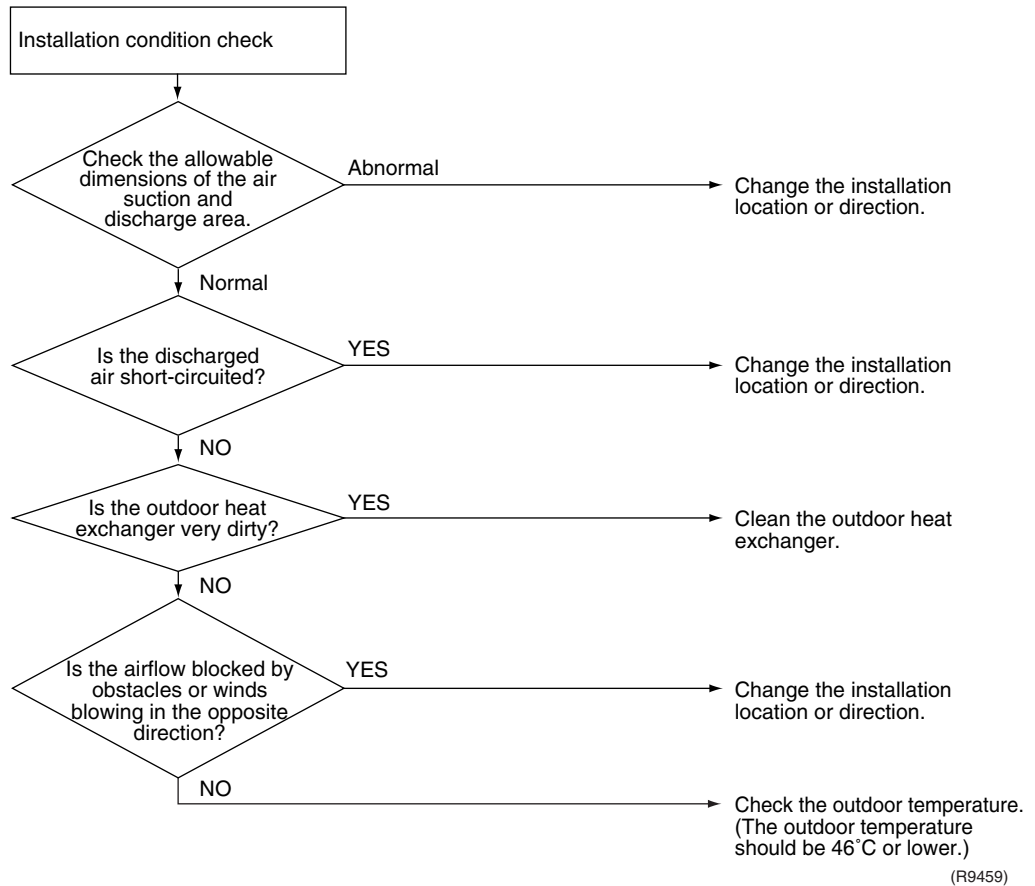

## 5.1.6 Discharge Pressure Check

### Check No.08

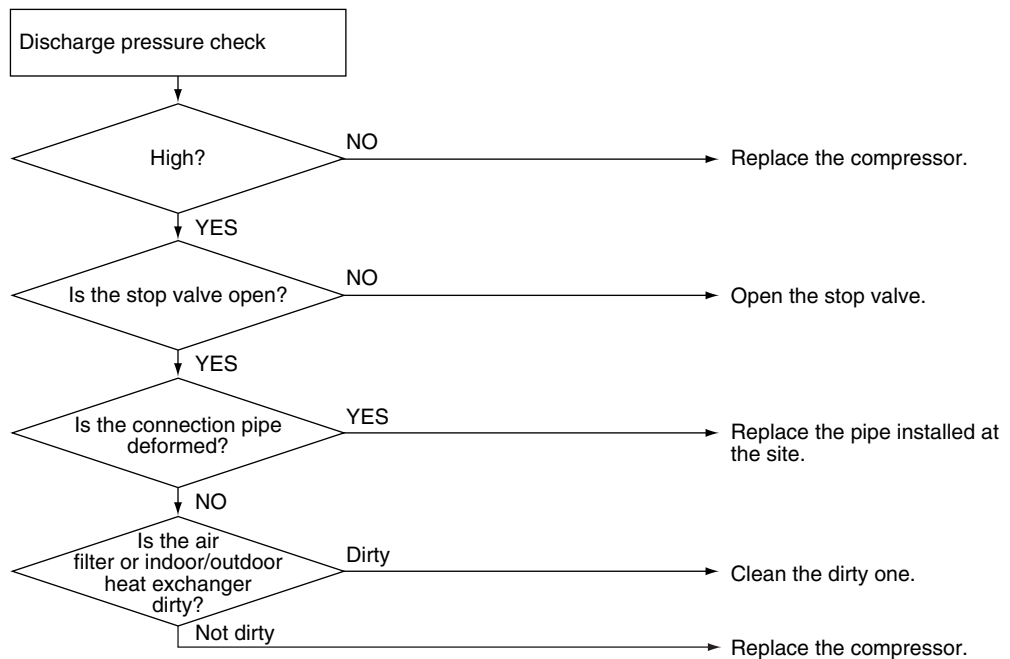

### 5.1.7 Outdoor Fan System Check

Check No.09

DC motor

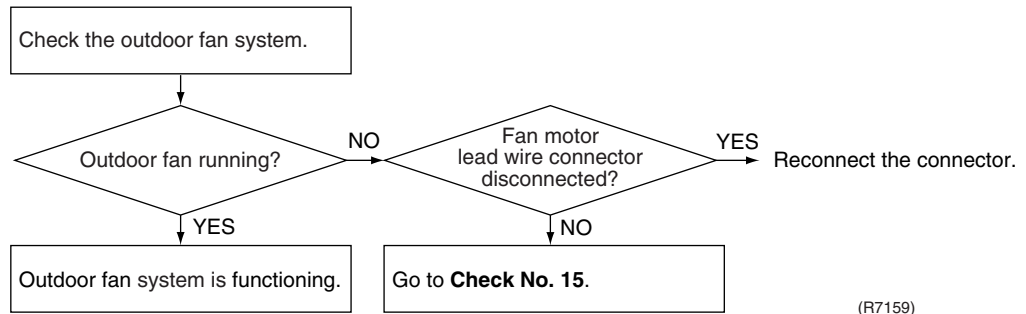

(R7159)

### 5.1.8 Power Supply Waveforms Check

Check No.10

Measure the power supply waveform between No.1 and No.2 on the terminal board, and check the waveform disturbance.

- Check to see if the power supply waveform is a sine wave. (Fig.1)
- Check to see if there is waveform disturbance near the zero cross. (sections circled in Fig.2)

Fig.1

Fig.2

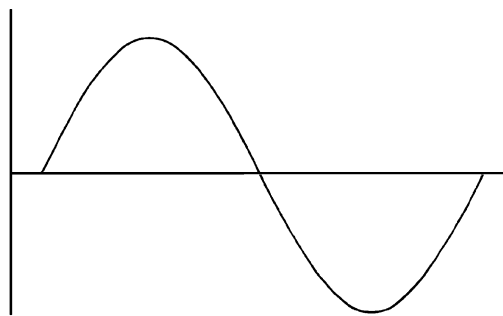

(R1736)

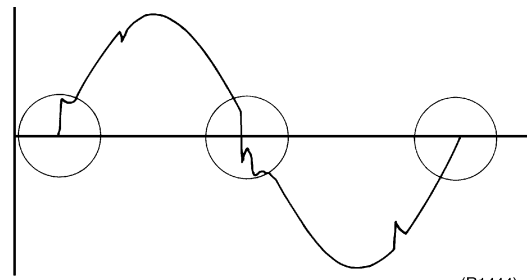

(R1444)

### 5.1.9 Inverter Units Refrigerant System Check

Check No.11

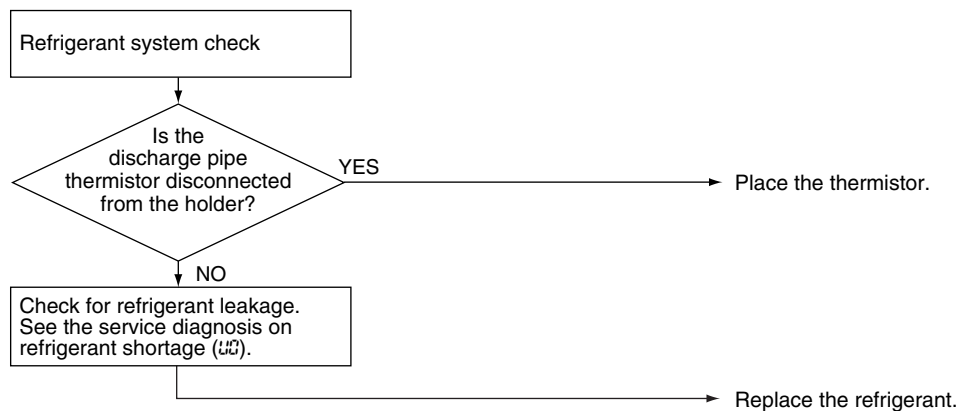

(R8380)

### 5.1.10 Capacitor Voltage Check

**Check No.12**

Before this check, be sure to check the main circuit for short circuit.  
 With the circuit breaker still on, measure the voltage according to the drawing of the model in question. Be careful never to touch any live parts.

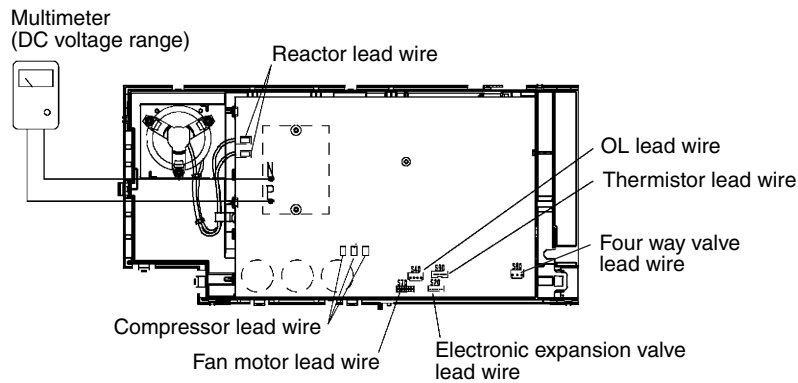

(R5222)

### 5.1.11 Power Module Check

**Check No.13**



**Note:** Check to make sure that the voltage between (+) and (-) of the diode bridge (DB1) is approx. 0 V before checking.

- Disconnect the compressor harness connector from the outdoor unit PCB. To disengage the connector, press the protrusion on the connector.
- Follow the procedure below to measure resistance between the terminals of the DB1 and the terminals of the compressor connector with a multi-tester. Evaluate the measurement results for a judgment.

Negative (-) terminal of tester (positive terminal (+) for digital tester)	DB1 (+)	UVW	DB1 (-)	UVW
Positive (+) terminal of tester (negative terminal (-) for digital tester)	UVW	DB1 (+)	UVW	DB1 (-)
Resistance in OK	several kΩ ~ several MΩ			
Resistance in NG	0 Ω or ∞			

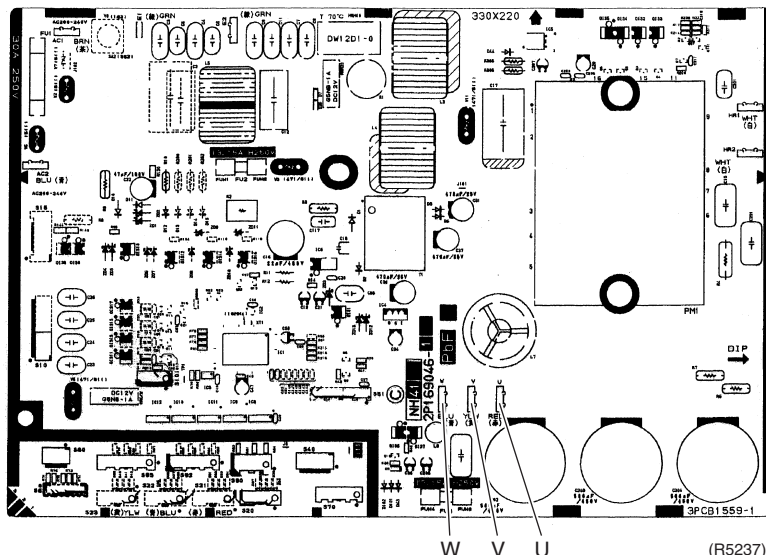

(R5237)

## 5.1.12 Rotation Pulse Input on the Outdoor Unit PCB Check

### Check No.15

<Outdoor fan motor>

Make sure that the voltage of  $320 \pm 30$  V is applied.

1. Set operation off and power off. Disconnect the connector S70.
2. Check that the voltage between the pins 4 - 7 is 320 VDC.
3. Check that the control voltage between the pins 3 - 4 is 15 VDC.
4. Check that the rotation command voltage between the pins 2 - 4 is 0 ~ 15 VDC.
5. Keep operation off and power off. Connect the connector S70.
6. Check whether 2 pulses (0 ~ 15 VDC) are output at the pins 1 - 4 when the fan motor is rotated 1 turn by hand.

When the fuse is melted, check the outdoor fan motor for proper function.

If NG in step 2 → Defective PCB → Replace the outdoor unit PCB.

If NG in step 4 → Defective Hall IC → Replace the outdoor fan motor.

If OK in both steps 2 and 4 → Replace the outdoor unit PCB.

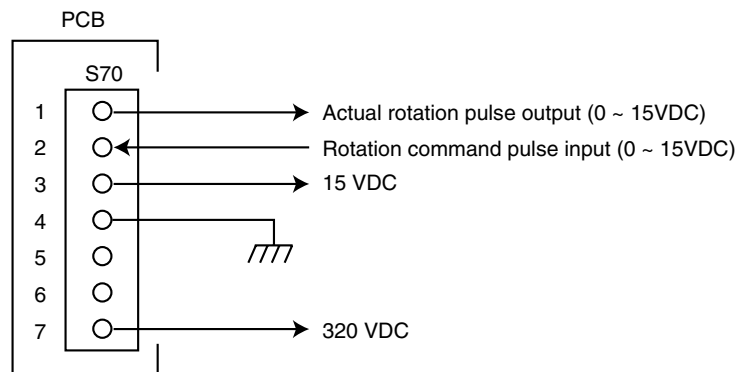

(R10811)

# Part 7

## Removal Procedure

1. Indoor Unit.....	104
1.1 Removal of Air Filter / Front Panel .....	104
1.2 Removal of Front Grille .....	107
1.3 Removal of Horizontal Blades / Vertical Blades .....	109
1.4 Removal of Electrical Box / PCB / Swing Motor .....	111
1.5 Removal of Indoor Heat Exchanger .....	117
1.6 Removal of Fan Rotor / Fan Motor.....	120
2. Outdoor Unit - RX50/60G2V1B .....	122
2.1 Removal of Outer Panels .....	122
2.2 Removal of Fan Motor / Outdoor Fan.....	126
2.3 Removal of Electrical Box .....	130
2.4 Removal of PCB.....	134
2.5 Removal of Sound Blanket / Thermistors.....	137
2.6 Removal of Four Way Valve.....	139
2.7 Removal of Electronic Expansion Valve.....	140
2.8 Removal of Compressor.....	141
3. Outdoor Unit - RX71GV1B .....	144
3.1 Removal of Outer Panels .....	144
3.2 Removal of Electrical Box .....	159
3.3 Removal of PCB.....	163
3.4 Removal of Fan Motor.....	166
3.5 Removal of Coils / Thermistors .....	167
3.6 Removal of Sound Blanket.....	170
3.7 Removal of Compressor.....	173

# 1. Indoor Unit

## 1.1 Removal of Air Filter / Front Panel

**Procedure**



**Warning**

Be sure to wait for 10 minutes or more after turning off all power supplies before disassembling work.

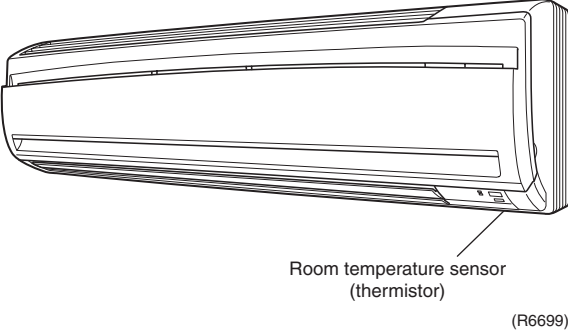
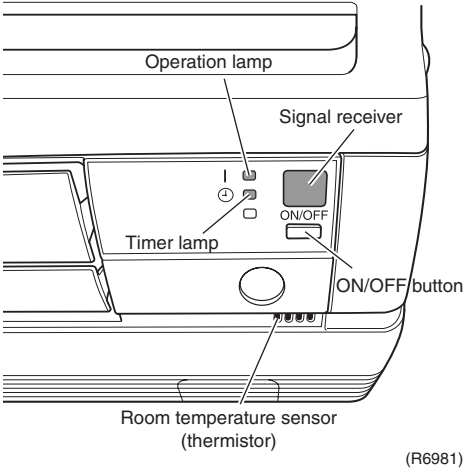
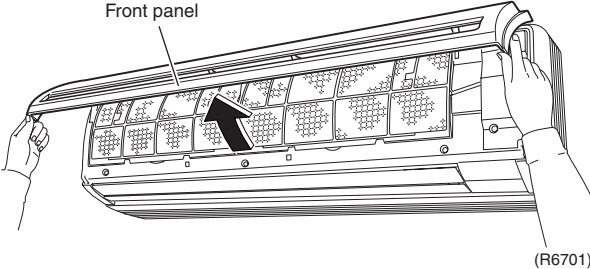
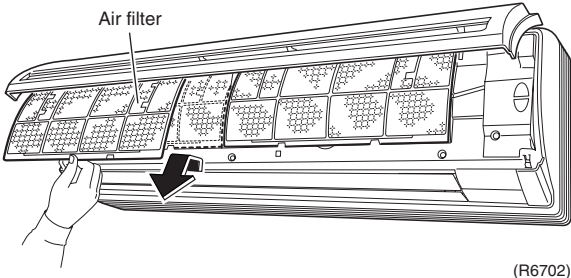
Step	Procedure	Points
	 	<ul style="list-style-type: none"> <li>■ When the signal receiver catches a signal from the remote controller, it produces beep sound and the operation lamp blinks.</li> </ul>
<p>1. Remove the air filters.</p> <p>1</p>	<p>Hold the both sides of the front panel and lift it until it stops with a click.</p>  <p>2</p> <p>Lift an air filter upwards slightly, and then pull it out downwards.</p> 	<ul style="list-style-type: none"> <li>■ The air filter is not marked for difference between the right and left sides.</li> <li>■ The air filter can be set easily by inserting it along the guides.</li> <li>■ Insert the air filter with the "FRONT" mark faced up.</li> <li>■ Be sure to insert the hooks (at 2 lower positions) when mounting the air filter.</li> </ul>

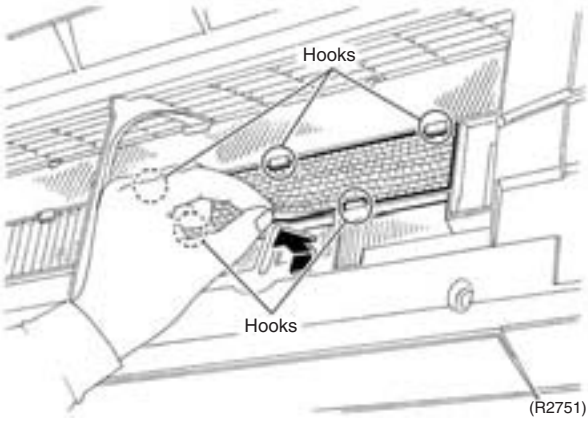
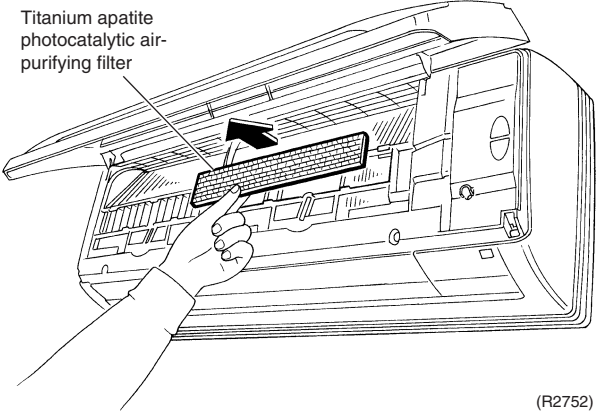
Step	Procedure	Points
2.	Remove the Titanium apatite photocatalytic air-purifying filter.	
1	<p>Push up the bottom of a Titanium apatite photocatalytic air-purifying filter to unfasten the hooks (2 on lower, 3 on upper) and take the filter out.</p>  <p style="text-align: right;">(R2751)</p>  <p style="text-align: right;">(R2752)</p>	<ul style="list-style-type: none"> <li>■ The right and left filters are interchangeable.</li> </ul>

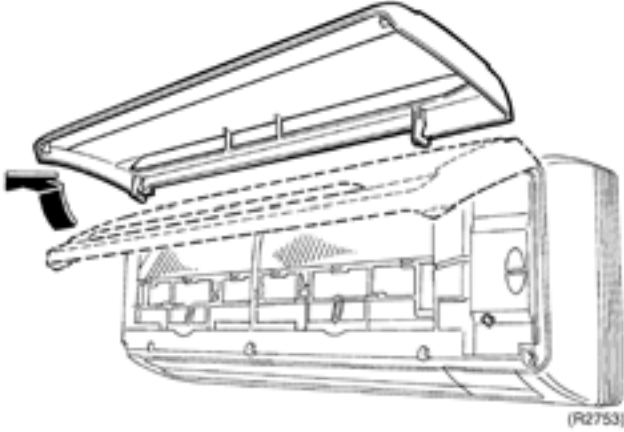
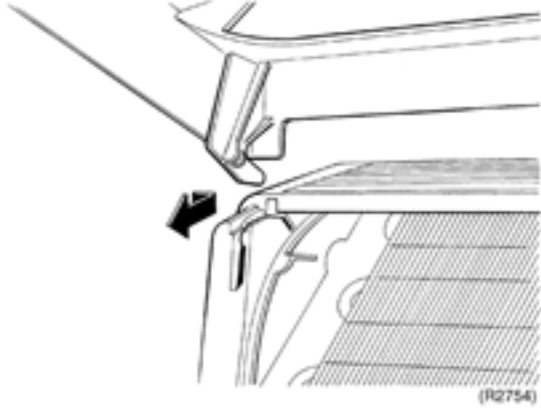
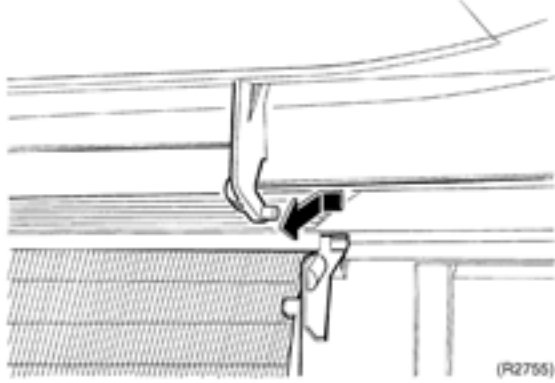
Step	Procedure	Points
<p>3. Remove the front panel.</p> <p>1</p>	<p>While opening the front panel further than it stops, release both the shafts and remove the front panel.</p>   	<ul style="list-style-type: none"> <li>■ Slide the front panel side to side to release each shaft.</li> <li>■ Align the right and left shafts with grooves in turn and insert them to the end when installing.</li> </ul>



# 1.2 Removal of Front Grille

**Procedure**

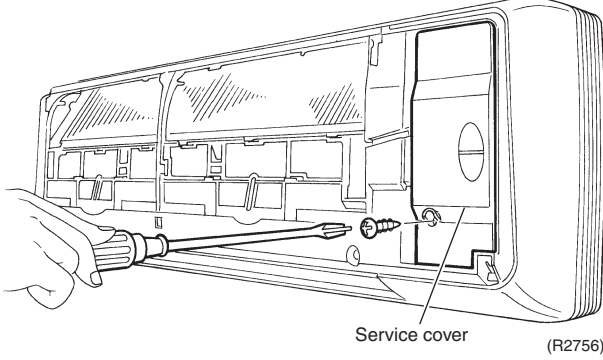
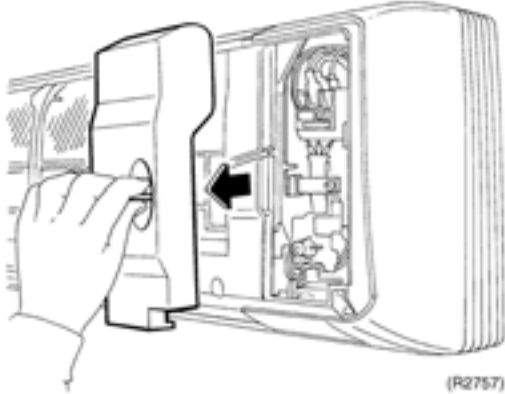
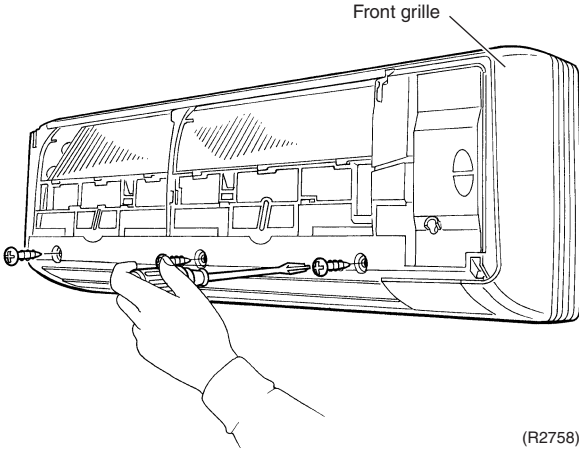

**Warning** Be sure to wait for 10 minutes or more after turning off all power supplies before disassembling work.

Step	Procedure	Points
<p>1. Remove the service cover.</p> <p>1 Remove the screw and remove the service cover.</p>	 <p>Service cover (R2756)</p>  <p>(R2757)</p>	<ul style="list-style-type: none"> <li>■ You can remove the front grille without detaching the service cover.</li> </ul>
<p>2. Remove the front grille.</p> <p>1 Remove the 3 screws of the front grille.</p>	 <p>Front grille (R2758)</p>	

Step	Procedure	Points
2	<p>Unfasten the 3 hooks on the top of the front grille.</p>	<ul style="list-style-type: none"> <li>■ Refer to the removal procedure in a reverse way when reassembling.</li> </ul>
3	<p>Pull the upper part of the front grille out and lift the lower part up, and then remove the front grille.</p>	<ul style="list-style-type: none"> <li>■ Make sure that all the 3 hooks are placed securely when reassembling.</li> </ul>

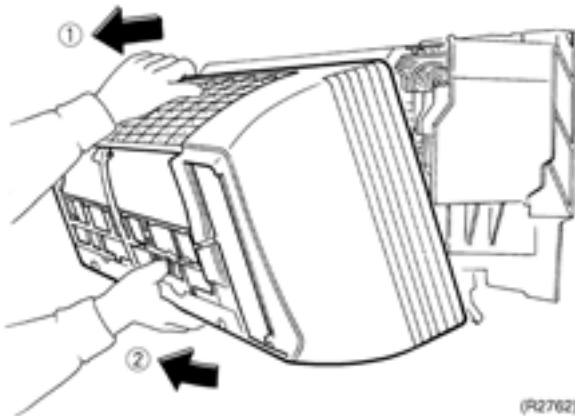
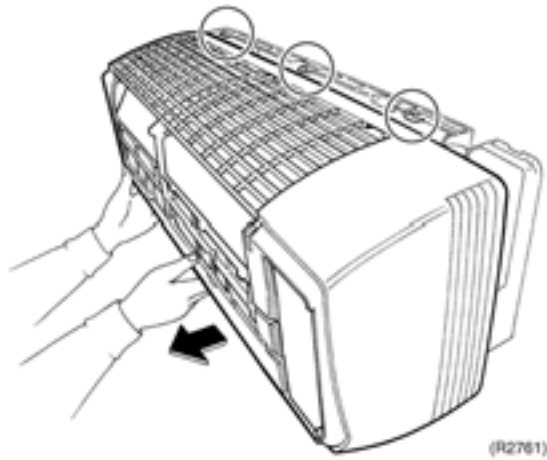
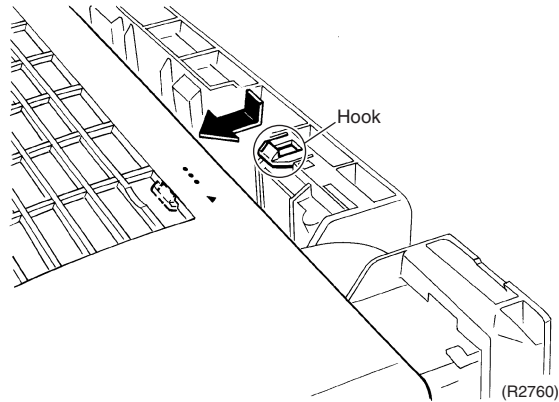
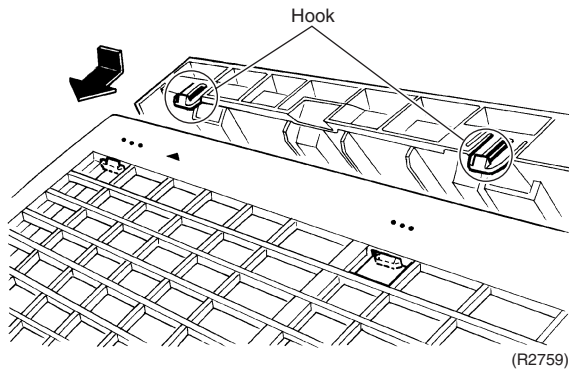

# 1.3 Removal of Horizontal Blades / Vertical Blades

**Procedure**



**Warning** Be sure to wait for 10 minutes or more after turning off all power supplies before disassembling work.

Step	Procedure	Points
1. Remove the horizontal blades.		
1	Open the horizontal blades.	
2	Release the left shaft of the horizontal blades.	
3	Bend the horizontal blades slightly and release the center shaft. Slide the horizontal blades to the left and release the right shaft.	
		<p>■ Installation procedure</p> <ol style="list-style-type: none"> <li>1. Since the key pattern hook is provided, rotate the blade and fit it to the right shaft first.</li> <li>2. Fit the blade to the center and left shafts.</li> </ol>

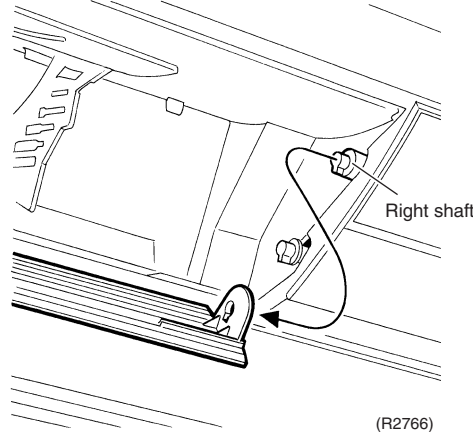
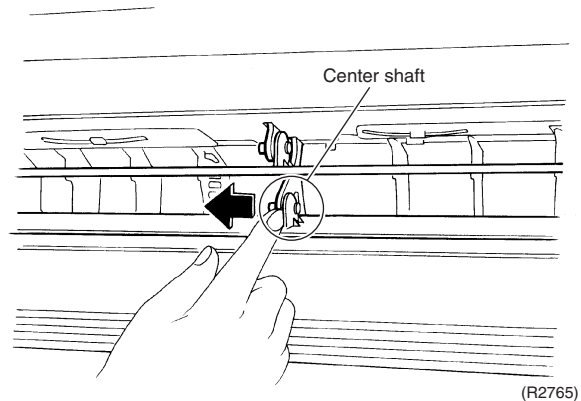
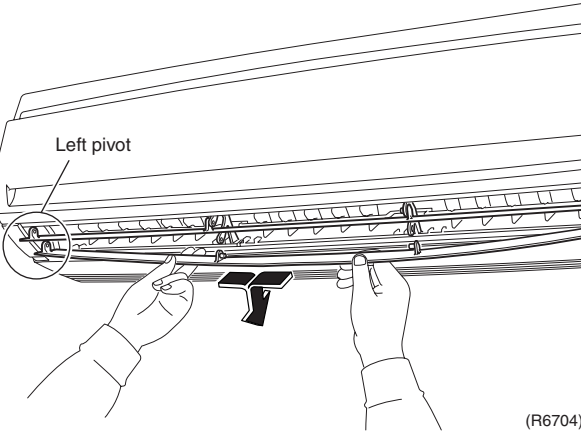
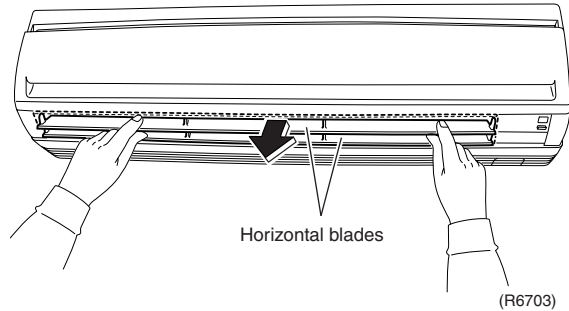

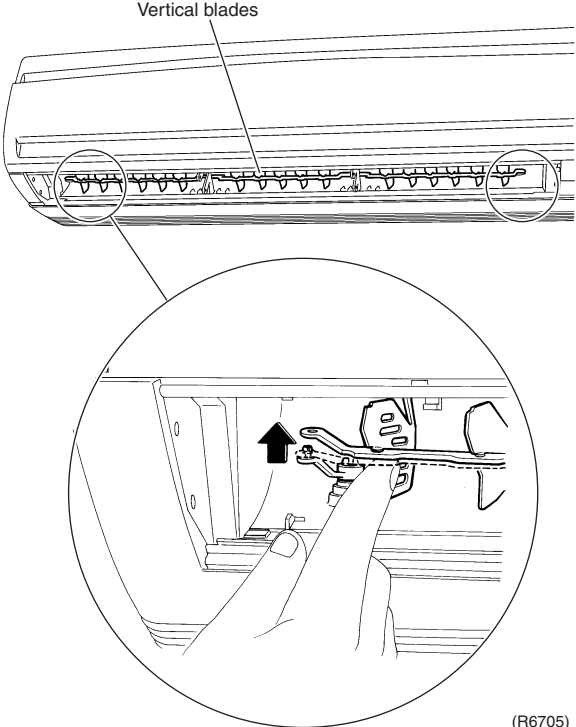
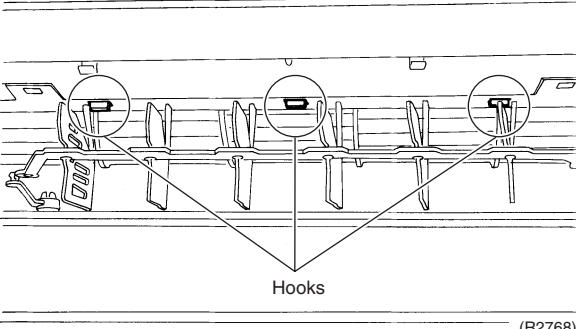
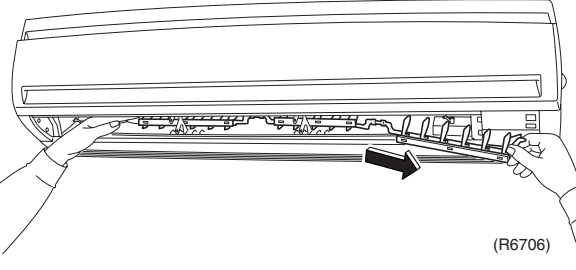
Step	Procedure	Points
2.	Remove the vertical blades.	<ul style="list-style-type: none"> <li>Remove the fan guards beforehand.</li> </ul>
1	<p>Release the right and left shafts.</p>  <p style="text-align: right;">(R6705)</p>	
2	<p>Unfasten the 3 hooks.</p>  <p style="text-align: right;">(R2768)</p>	
3	<p>Pull the vertical blades rightwards and remove them.</p>  <p style="text-align: right;">(R6706)</p>	

## 1.4 Removal of Electrical Box / PCB / Swing Motor

### Procedure



### Warning

Be sure to wait for 10 minutes or more after turning off all power supplies before disassembling work.

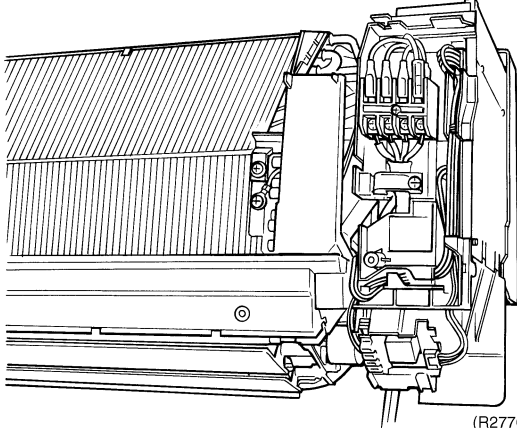
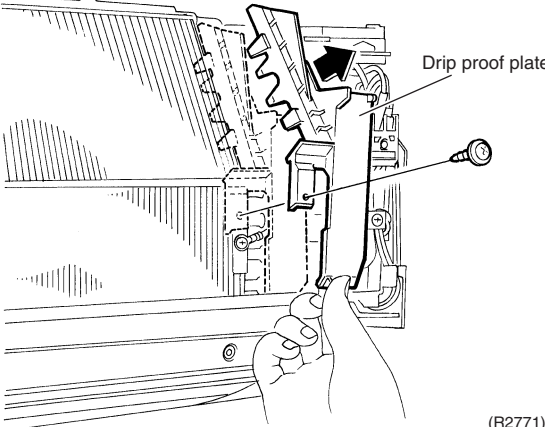
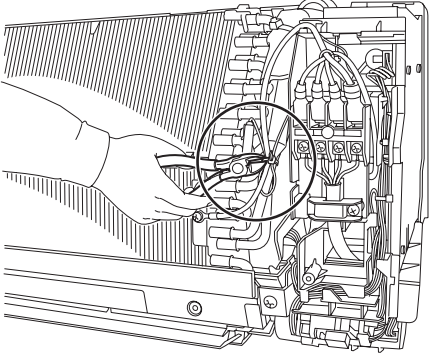
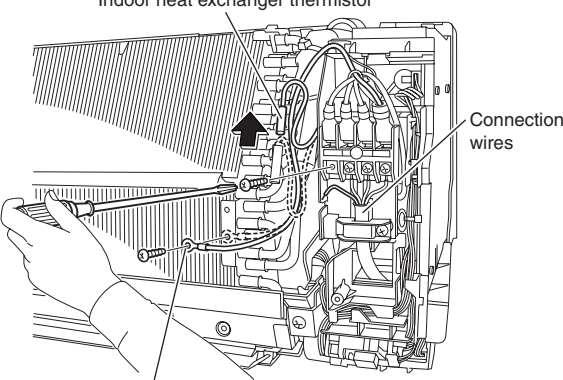
Step	Procedure	Procedure	Points
	Features	 <p style="text-align: right;">(R2770)</p>	<b>Preparation</b> <ul style="list-style-type: none"> <li>■ Remove the front grille according to the “Removal of Front Grille”.</li> </ul>
1. Remove the drip proof plate.  1        2	Remove the screw and remove the drip proof plate.        Cut the clamp.	 <p style="text-align: right;">(R2771)</p>  <p style="text-align: right;">(R6707)</p>	
2. Disconnect the harnesses.  1  2  3	Pull out the indoor heat exchanger thermistor.  Remove the screw of the earth.  Remove the screws of the connection wires.	 <p style="text-align: right;">(R12030)</p>	<ul style="list-style-type: none"> <li>■ Be careful not to lose the clip for the thermistor.</li> </ul>

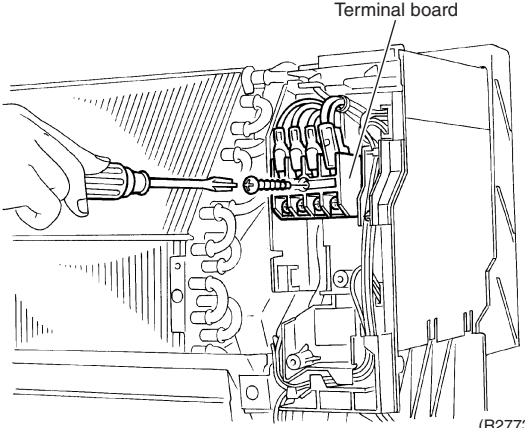
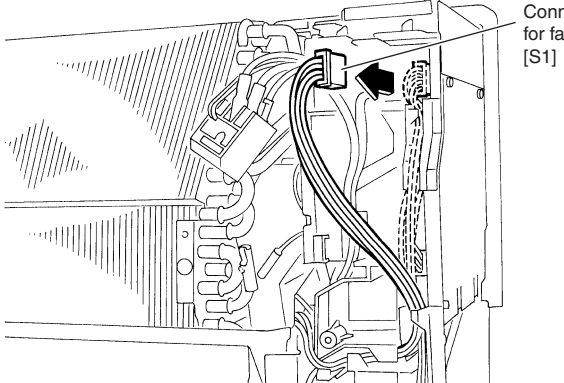
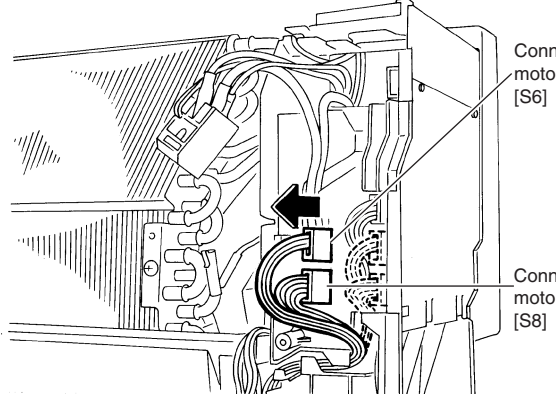
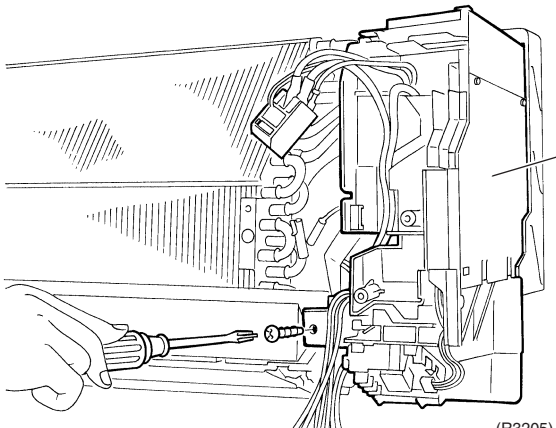
Step	Procedure	Points
3.	Remove the electrical box.	
1	Remove the screw and remove the terminal board. 	<ul style="list-style-type: none"> <li>■ You can remove the electrical box without detaching the terminal board.</li> <li>■ Screw: M4 × 30</li> </ul>
2	Disconnect the connector for fan motor [S1]. 	
3	Disconnect the connectors for swing motor [S6] [S8]. 	
4	Remove the screw of the electrical box. 	

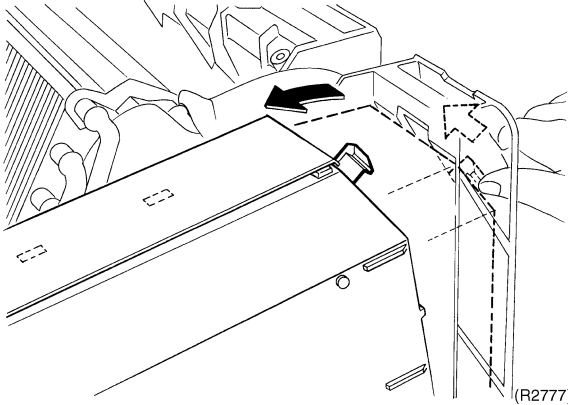
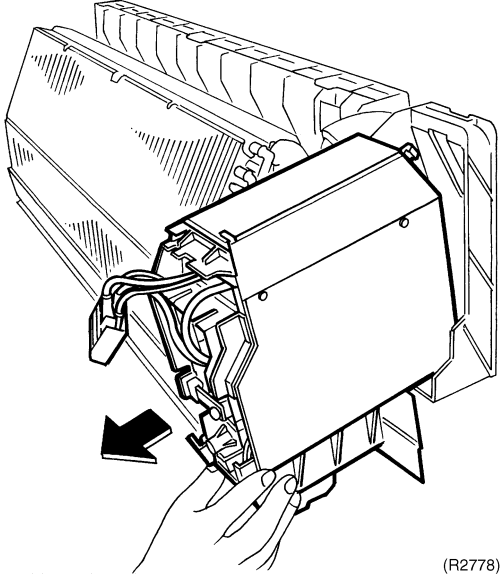
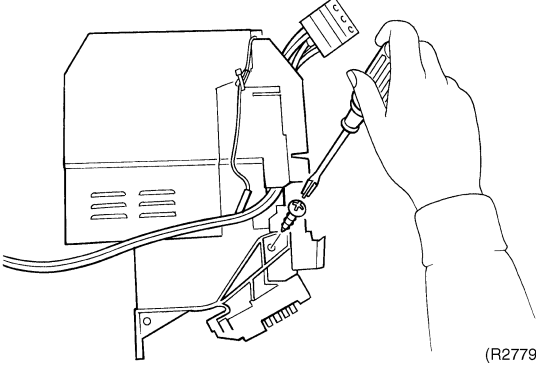
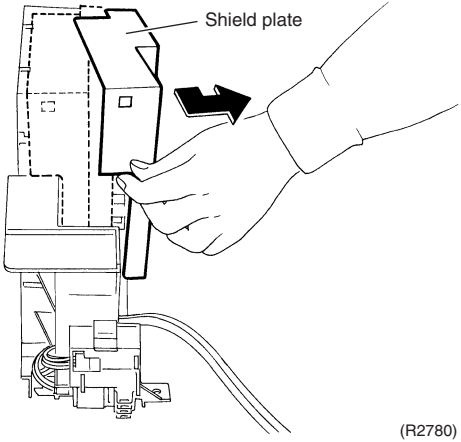
Step	Procedure	Points
5	<p>Dislocate the electrical box to the left and unfasten the back hook.</p>  <p>(R2777)</p>	<ul style="list-style-type: none"> <li>■ The electrical box has a hook on its back.</li> </ul>
6	<p>Pull the electrical box out.</p>  <p>(R2778)</p>	<ul style="list-style-type: none"> <li>■ Catch the back hook of the electrical box when reassembling.</li> </ul>
7	<p>Remove the screw on the electrical box.</p>  <p>(R2779)</p>	<ul style="list-style-type: none"> <li>■ Screw: M4 × 16</li> </ul>
8	<p>Push the shield plate up and unfasten the hook.</p>  <p>(R2780)</p>	



Step	Procedure	Points
9	<p>Press the signal receiver unit down and unfasten the hooks on the upper side, and then unfasten the hooks on the lower side.</p>	<ul style="list-style-type: none"> <li>■ Release the hooks on the upper side.</li> </ul>
10	<p>Cut the clamp.</p>	<ul style="list-style-type: none"> <li>■ Remove the signal receiver unit while pushing the hooks of connectors.</li> </ul>
11	<p>The signal receiver unit has 4 PCBs. Disconnect every connector from each PCB. Remove each PCB from the hooks.</p>	<ul style="list-style-type: none"> <li>■ Always spare clamps when mounting.</li> </ul>
12	<p>Cut the clamp.</p>	

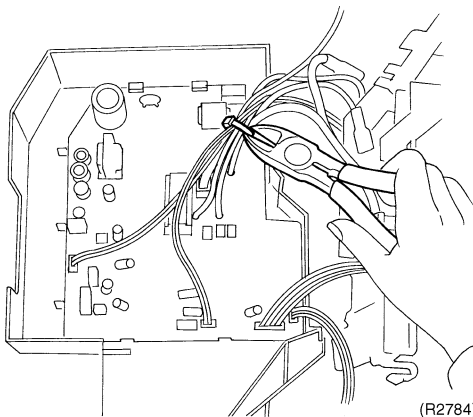
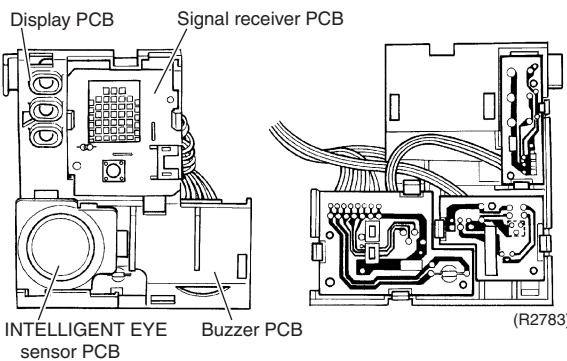
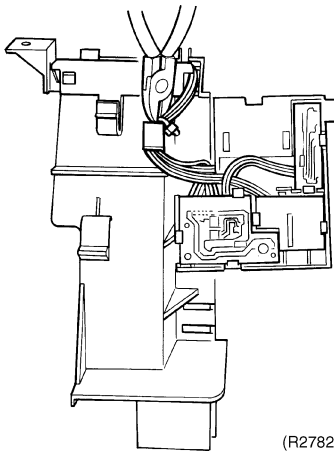
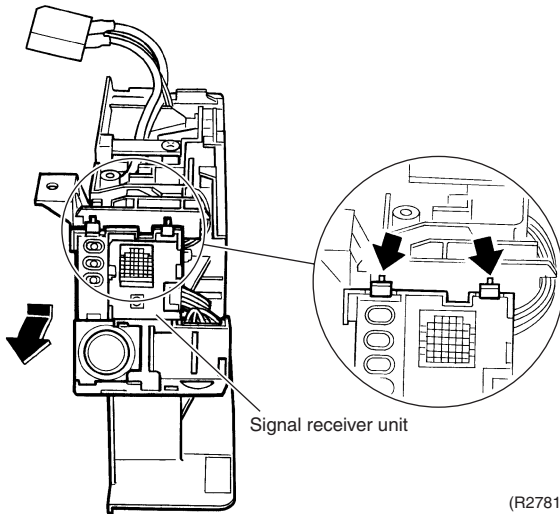

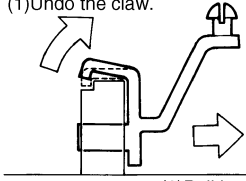
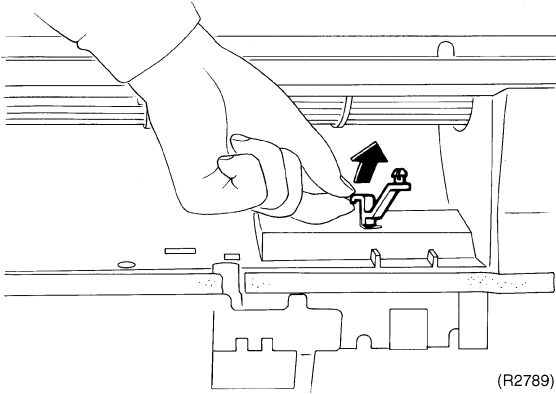
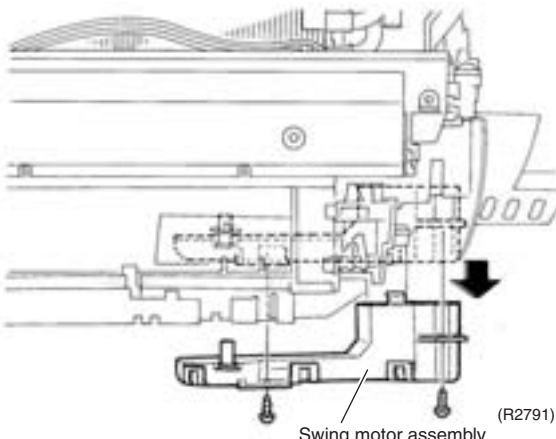
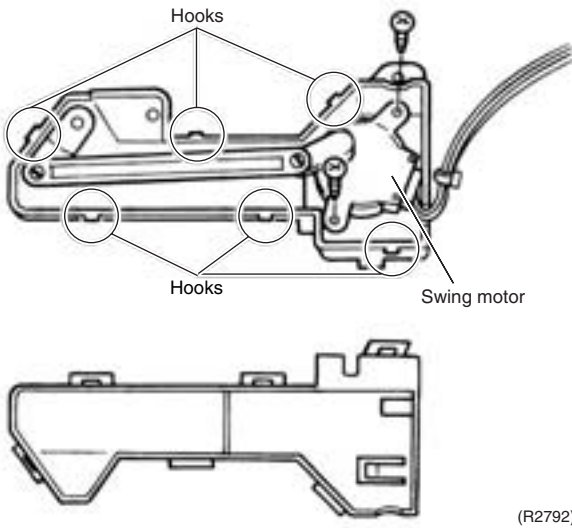

Step	Procedure	Points
<p>4. Remove the control PCB.</p> <p>1 Unfasten the 2 hooks on the lower side, and then the 2 hooks on the upper side. Remove the control PCB.</p> <p>2 Control PCB                      [S1]: fan motor                      [S6]: swing motor (horizontal blades)                      [S8]: swing motor (vertical blades)                      [S26]:buzzer PCB                      [S28]:signal receiver PCB                      [S32]:indoor heat exchanger thermistor                      [S35]:INTELLIGENT EYE sensor PCB</p>	<p>(R2785)</p> <p>(R2697)</p>	<p>■ See page 8 for detail.</p>
<p>5. Remove the swing motor for horizontal blades.</p> <p>1 Remove the screw of the swing motor.</p> <p>2 Remove the swing motor.</p>	<p>(R2787)</p> <p>(R2788)</p>	

Step	Procedure	Points
6.	Remove the swing motor for vertical blades.	
1	Release the swing shaft on the right side.	<p>■ Releasing the swing shaft</p> <p>(1) Undo the claw.</p>  <p>(2) Pull it out.</p> <p>(R2790)</p>
2	Remove the 2 screws and detach the swing motor assembly.	
3	Remove the 2 screws and remove the swing motor.	<p>■ The assembly has 6 hooks.</p>
	 <p>(R2789)</p>  <p>(R2791)</p> <p>Swing motor assembly</p>  <p>(R2792)</p>	

# 1.5 Removal of Indoor Heat Exchanger

**Procedure**



**Warning** Be sure to wait for 10 minutes or more after turning off all power supplies before disassembling work.

Step	Procedure	Points
1. Disconnect the refrigerant piping.		<p><b>Preparation</b></p> <ul style="list-style-type: none"> <li>Remove the electrical box according to the “Removal of Electrical Box / PCB / Swing Motor”.</li> </ul>
1	<p>Hold the indoor unit up with a piece of wood etc.</p>	<p><b>Caution</b> If the refrigerant leaks, repair the spot of leaking, then collect all refrigerant from the unit. After conducting vacuum drying, recharge proper amount of refrigerant.</p>
2	<p>Pull out the drain hose.</p>	<p><b>Caution</b> Do not contaminate any gas (including air) other than the specified refrigerant (R-410A) into refrigerant cycle. (Contaminating of air or other gas causes abnormal high pressure in refrigerating cycle, and this results in pipe breakage or personal injuries.)</p>
3	<p>Unscrew the flare nut for gas piping with 2 wrenches.</p>	<ul style="list-style-type: none"> <li>Pay attention so that the residual water in the drain does not make the floor wet.</li> <li>In case that a drain hose is buried inside a wall, remove it after the drain hose in the wall is pulled out.</li> <li>Use 2 wrenches to disconnect pipes.</li> <li>When disconnecting pipes, cover every nozzle with caps so as not to let dust and moisture in.</li> </ul>
4	<p>Unscrew the flare nut for liquid piping with 2 wrenches.</p>	

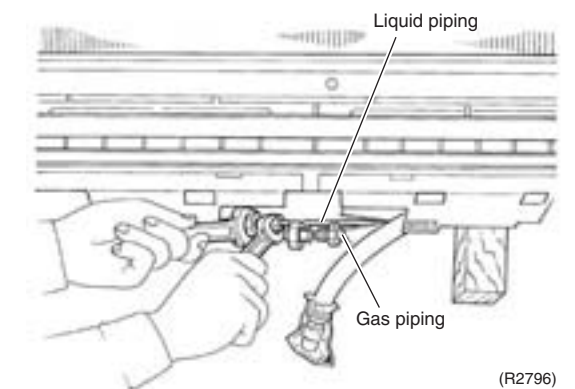
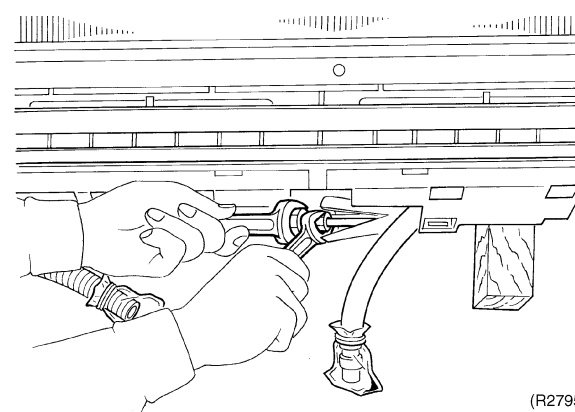
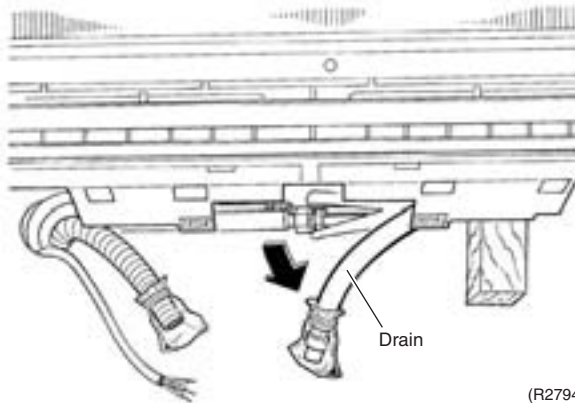
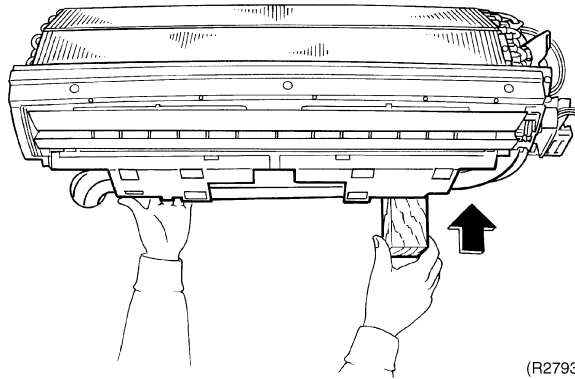

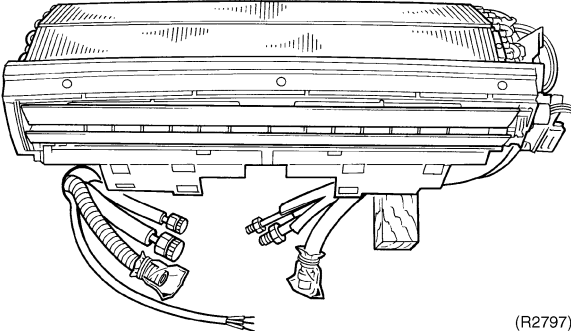
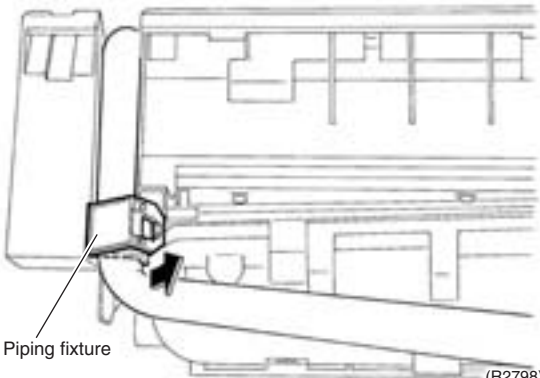
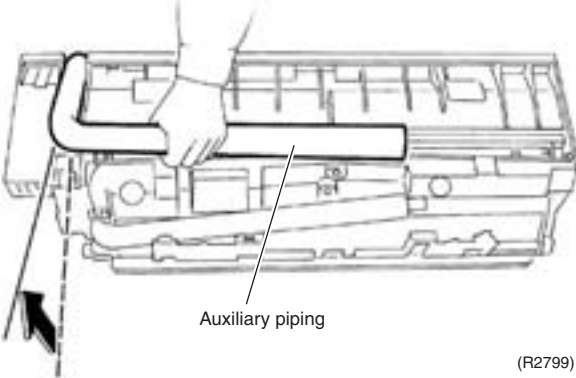
Step	Procedure	Points
2. Remove the indoor unit.	<p data-bbox="199 248 454 344">1 Detach the indoor unit from the installation plate.</p>  <p data-bbox="1011 607 1070 629">(R2797)</p>	
3. Remove the piping fixture.	<p data-bbox="199 678 454 808">1 Unfasten the hook on the upper side of the piping fixture on the back of the unit.</p>  <p data-bbox="512 1059 624 1081">Piping fixture</p> <p data-bbox="995 1088 1054 1111">(R2798)</p>	
4. Remove the indoor heat exchanger.	<p data-bbox="199 1189 454 1285">1 Widen the auxiliary piping to the extent of 10°~20°.</p>  <p data-bbox="687 1529 815 1552">Auxiliary piping</p> <p data-bbox="1011 1574 1070 1597">(R2799)</p>	<ul style="list-style-type: none"> <li data-bbox="1094 1189 1390 1223">■ At an angle of 10°~20°</li> </ul>

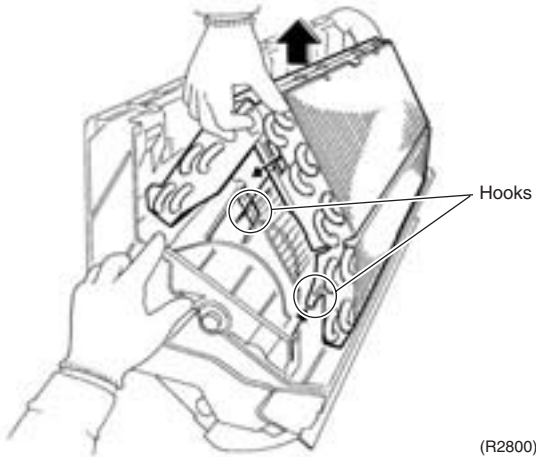
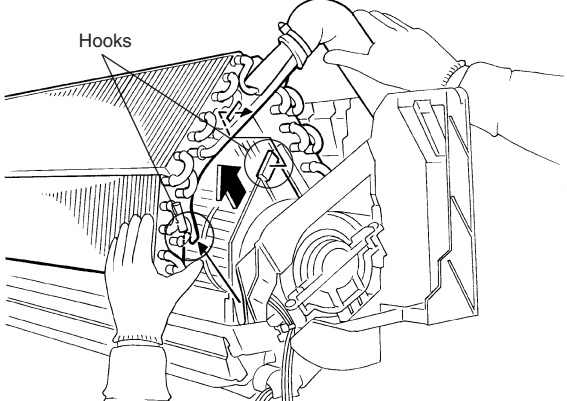
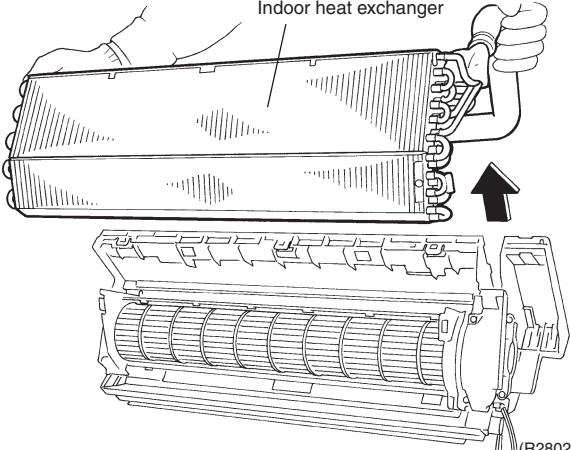
Step	Procedure	Procedure	Points
2	Unfasten the hooks on the left side.	 <p>(R2800)</p>	
3	Push the hooks on the right side and unfasten.	 <p>(R2801)</p>	
4	Pull the indoor heat exchanger to the front side and unfasten the hooks completely, and then lift it.	 <p>(R2802)</p>	<p><b>⚠ Caution</b>  <b>When removing or reinstalling the indoor heat exchanger, be sure to wear protective gloves or wrap the indoor heat exchanger with cloths. (The fins may cause injuries.)</b></p>

# 1.6 Removal of Fan Rotor / Fan Motor

**Procedure**



**Warning**

Be sure to wait for 10 minutes or more after turning off all power supplies before disassembling work.

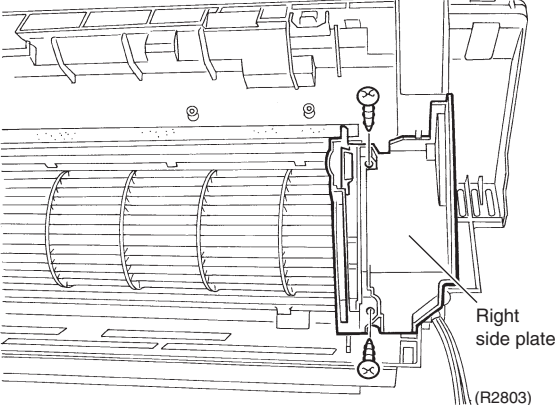
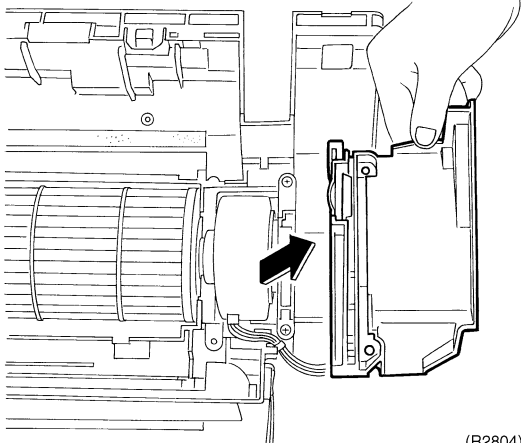
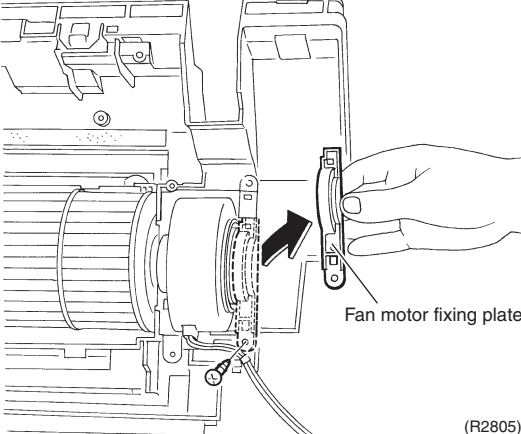
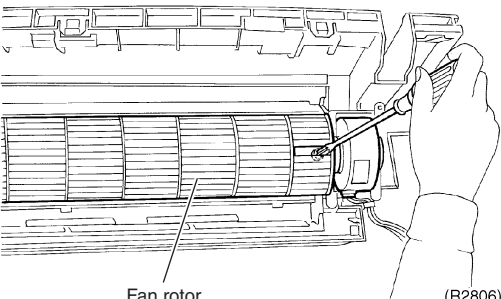
Step	Procedure	Points
<p>1. Remove the right side plate.</p> <p>1 Remove the 2 screws.</p> <p>2 Lift the right side plate and remove it.</p>	 	<ul style="list-style-type: none"> <li>■ You can remove the fan rotor without detaching the right side plate.</li> </ul>
<p>2. Remove the fan rotor.</p> <p>1 Remove the screw and remove the fan motor fixing plate.</p> <p>2 Remove the screw of the fan rotor.</p>	 	

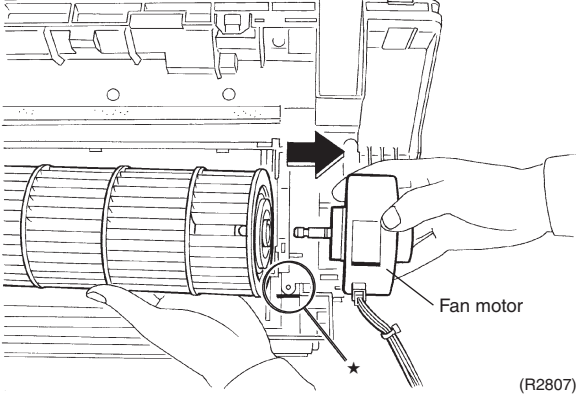
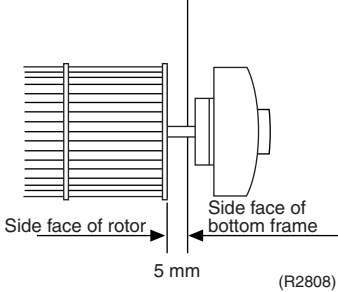
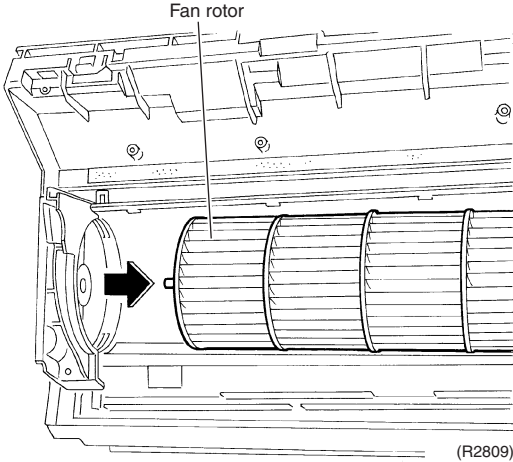
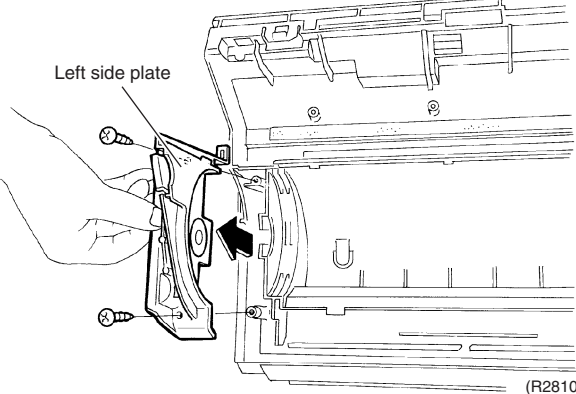
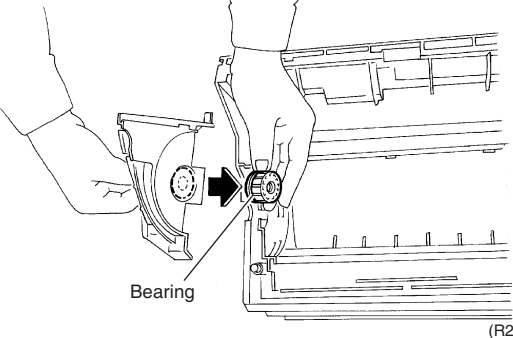
Step	Procedure	Points
<p>3. Remove the fan motor.</p> <p>1 Remove the fan motor.</p>	 <p>Fan motor</p> <p>(R2807)</p>	<p>■ When reassembling the fan motor and the fan rotor, provide as much as 5 mm of play between the side face of the rotor and the bottom frame.</p>  <p>Side face of rotor</p> <p>Side face of bottom frame</p> <p>5 mm</p> <p>(R2808)</p>
<p>4. Remove the bearing.</p> <p>1 Remove the fan rotor. The bearing is on the left side.</p> <p>2 Remove the 2 screws and remove the left side plate.</p> <p>3 The bearing is made of rubber. Push it inwards and remove it.</p>	 <p>Fan rotor</p> <p>(R2809)</p>  <p>Left side plate</p> <p>(R2810)</p>  <p>Bearing</p> <p>(R2811)</p>	



## 2. Outdoor Unit - RX50/60G2V1B

### 2.1 Removal of Outer Panels

**Procedure**

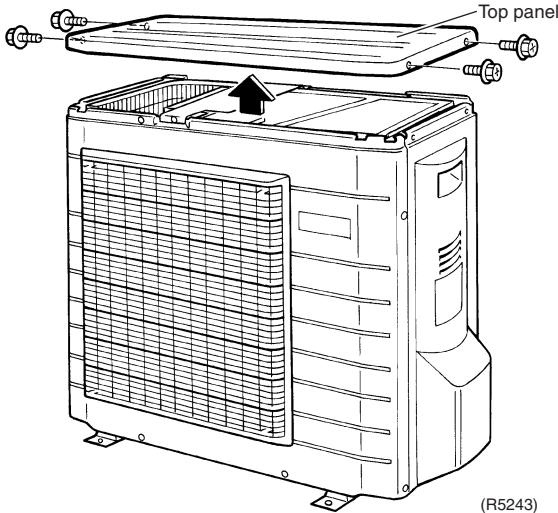
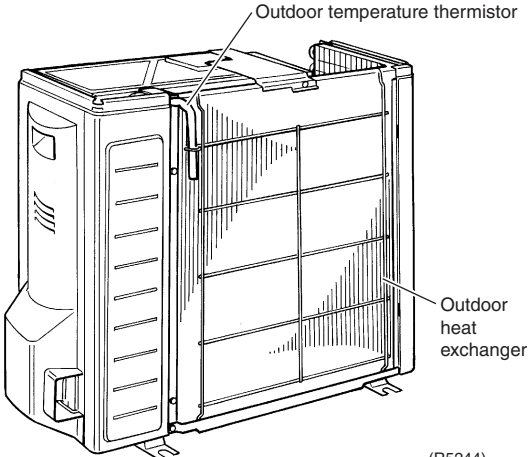
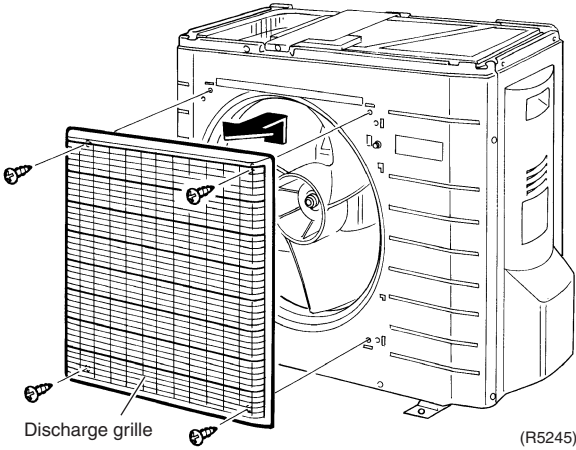

**Warning** Be sure to wait for 10 minutes or more after turning off all power supplies before disassembling work.

Step	Procedure	Points
1. Remove the panels and plates.		
1	<p>Remove the 4 screws and lift the top panel.</p>  <p>(R5243)</p>  <p>(R5244)</p>	<ul style="list-style-type: none"> <li>■ Take care not to cut your finger by the fins of the outdoor heat exchanger.</li> </ul>
2	<p>Remove the 4 screws and remove the discharge grille.</p>  <p>(R5245)</p>	

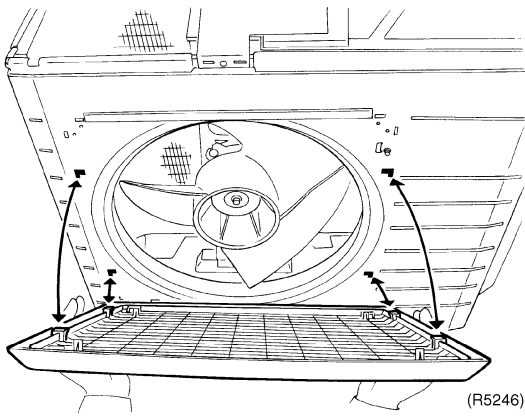
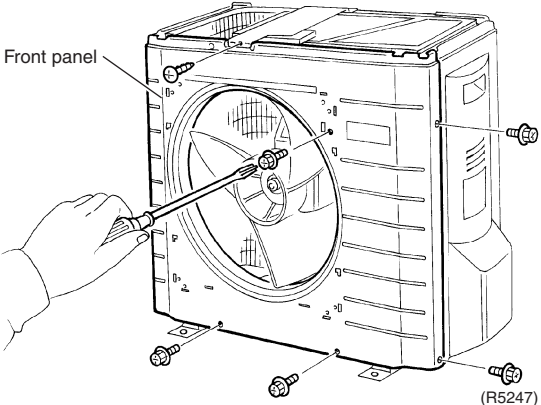
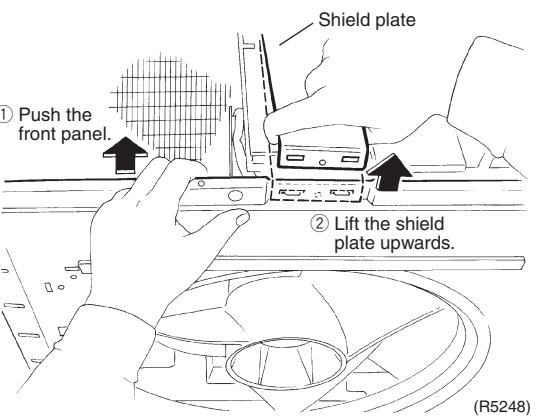

Step	Procedure	Points
3	Remove the 6 screws of the front panel.	 <p>(R5246)</p>
4	Push the front panel and unfasten the hooks. Lift the shield plate and remove it.	 <p>(R5247)</p>  <p>(R5248)</p>

Step	Procedure	Points
5	<p>Unfasten the left side hooks, and then the right side hook. Remove the front panel.</p>	<ul style="list-style-type: none"> <li>■ Lift the front panel while pushing the left side panel inwards.</li>   <li>■ Lift the front panel and unfasten the right side hook.</li>   <li>■ Fit the right side of the front panel first when installing.</li> </ul>

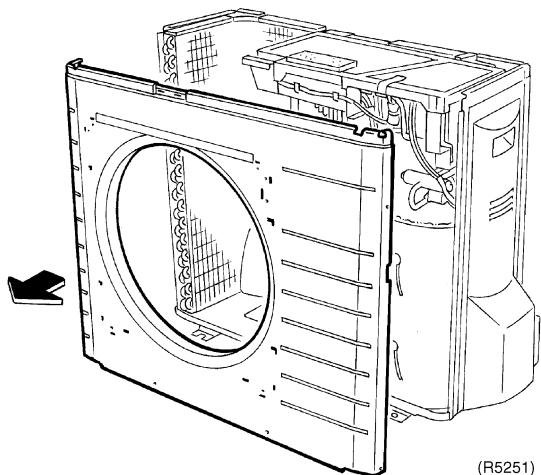
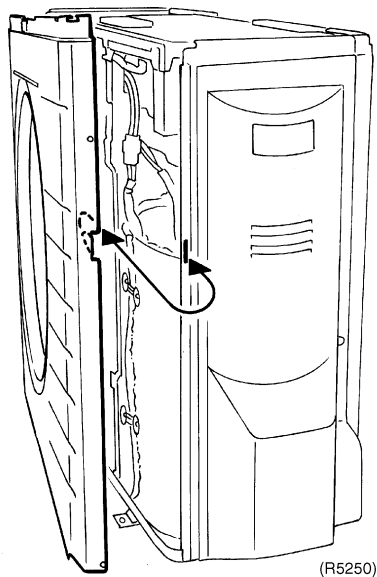
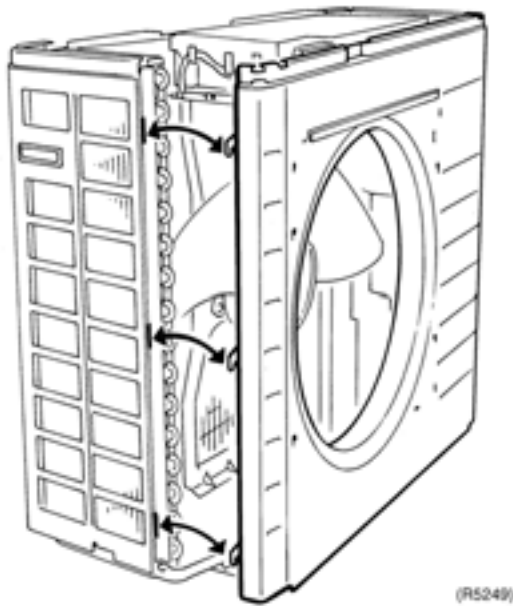

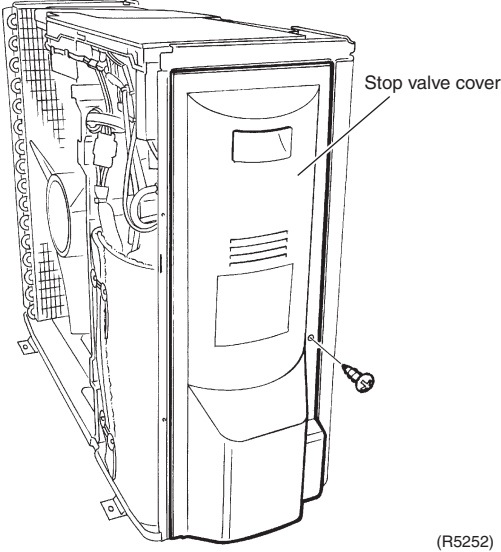
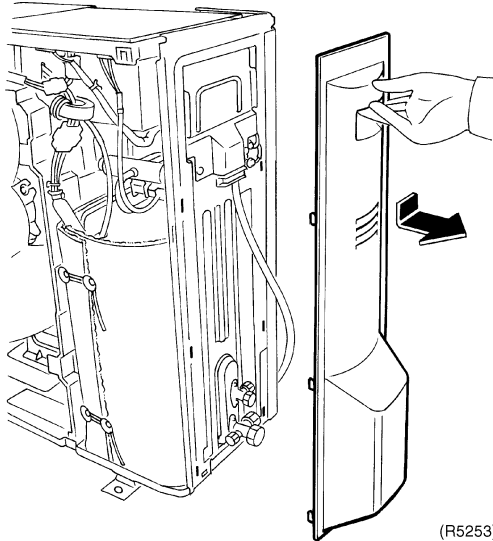
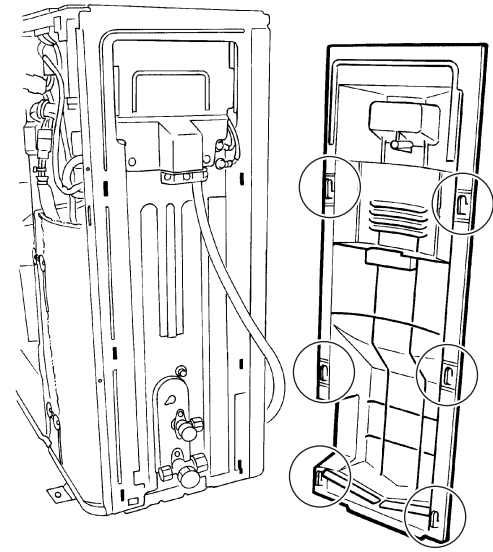
Step	Procedure	Points
2.	Remove the stop valve cover.	
1	Remove the screw of the stop valve cover.	
	 <p>(R5252)</p>	
2	Pull down the stop valve cover to unfasten the hooks and remove it.	
	 <p>(R5253)</p>  <p>(R5254)</p>	<p>■ The stop valve cover has 6 hooks.</p>

## 2.2 Removal of Fan Motor / Outdoor Fan

**Procedure**



**Warning** Be sure to wait for 10 minutes or more after turning off all power supplies before disassembling work.

Step	Procedure	Points
1. Remove the electrical box cover.		
1 Remove the screw of the shield plate.	<p>Shield plate</p> <p>(R5255)</p>	<ul style="list-style-type: none"> <li>■ Remove the top panel and the front panel according to the "Removal of Outer Panels".</li> <li>■ This procedure is not necessary to remove the outdoor fan only.</li> </ul>
2 Unfasten the 2 hooks and remove it.	<p>Hook</p> <p>(R12029)</p>	
3 Unfasten the 4 hooks of the electrical box cover and remove it.	<p>Electrical box cover</p> <p>(R5257)</p>	

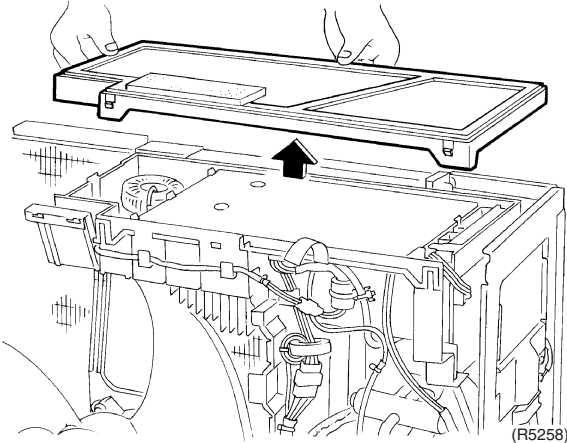
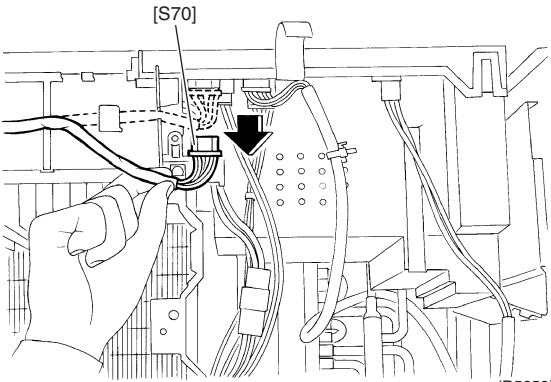
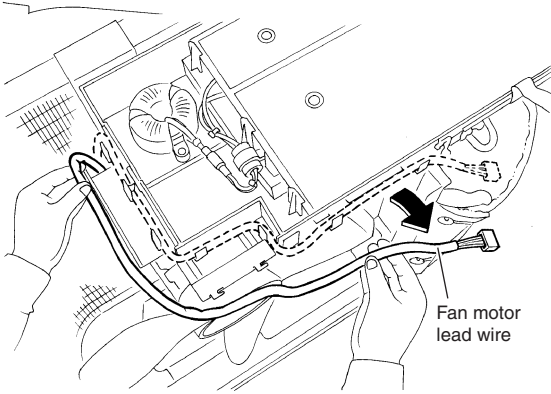
Step	Procedure	Points
	 <p style="text-align: right;">(R5258)</p>	
<p>2. Remove the fan motor.</p> <p>1</p> <p>2</p>	<p>1 Disconnect the connector for fan motor [S70].</p>  <p style="text-align: right;">(R5259)</p> <p>2 Release the fan motor lead wire from the 7 hooks.</p>  <p style="text-align: right;">(R5260)</p>	

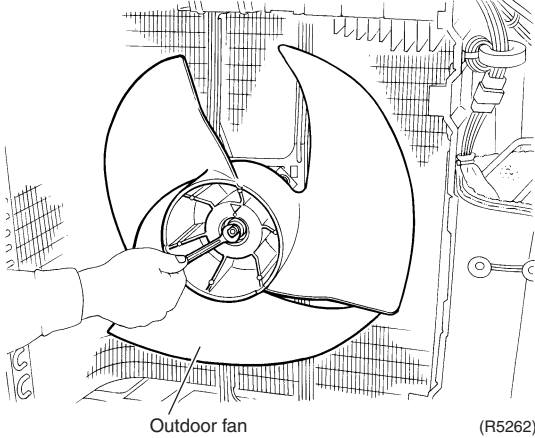
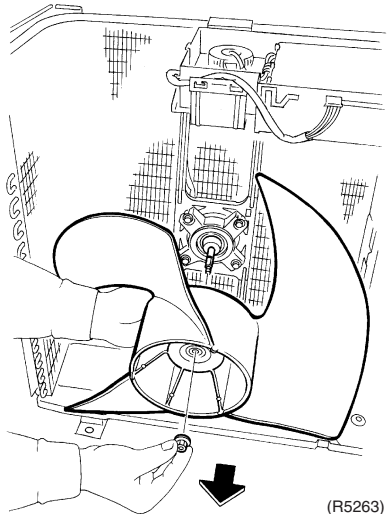
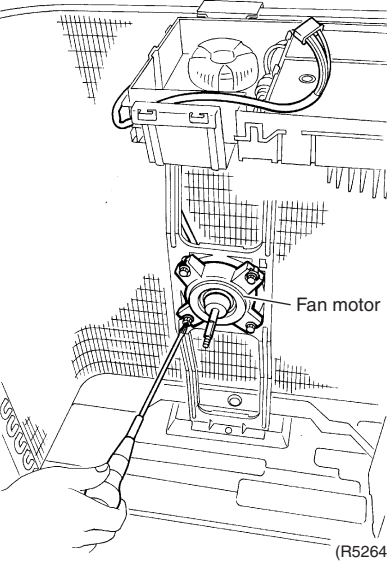
Step	Procedure	Points
3	<p>Unscrew the washer-fitted nut (M6) of the outdoor fan with a wrench.</p>	<p>■ Wrench size : 10 mm</p>
	 <p>Outdoor fan (R5262)</p>	<p>■ Align ▼ mark of the outdoor fan with D-cut section of the motor shaft when reassembling.</p>
4	<p>Remove the lower 2 screws from the fan motor first.</p>	
5	<p>Then, remove the upper 2 screws.</p>	<p>■ Be sure to remove the lower screws first. If the upper screws are removed first, the fan motor, the center of gravity of which is toward the front, may tilt down or fall, getting you injured.</p>
	 <p>(R5263)</p>	
	 <p>Fan motor (R5264)</p>	

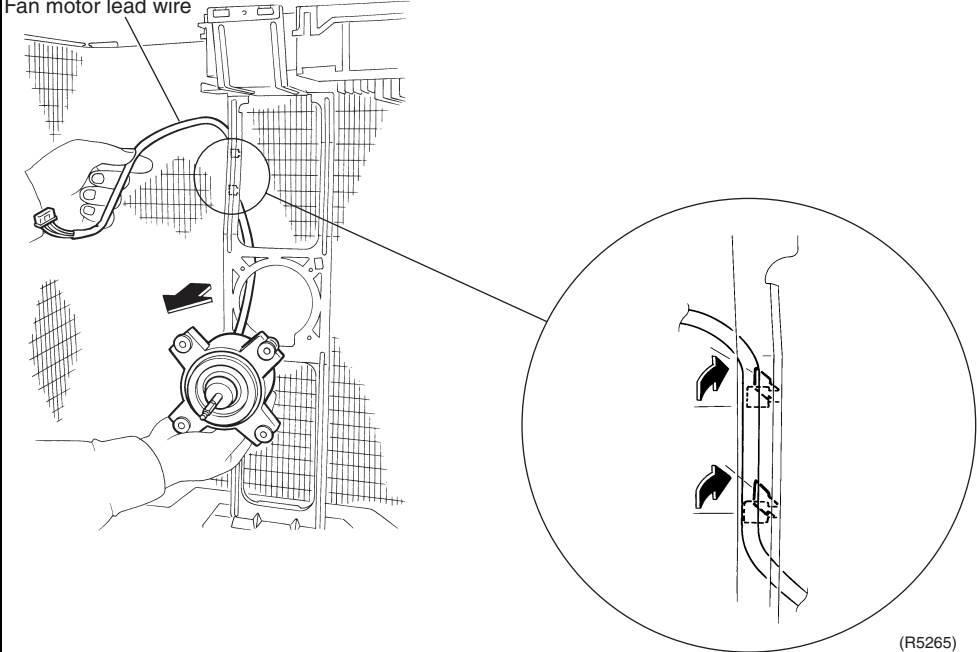
Step	Procedure	Points
6	<p data-bbox="199 217 454 342">Release the fan motor lead wire from the 2 hooks and pull the fan motor out.</p>  <p data-bbox="478 436 670 459">Fan motor lead wire</p> <p data-bbox="1380 1064 1444 1086">(R5265)</p>	<ul style="list-style-type: none"> <li data-bbox="1093 217 1457 376">■ Put the lead wire through the back of the fan motor when reassembling (so as not to be entangled with the outdoor fan).</li> </ul>

## 2.3 Removal of Electrical Box

**Procedure**

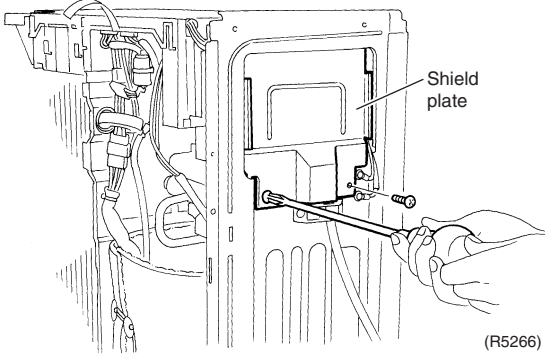
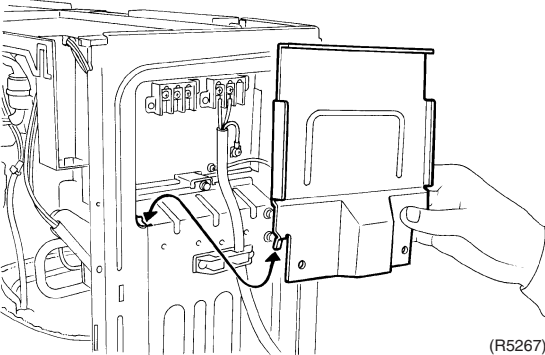
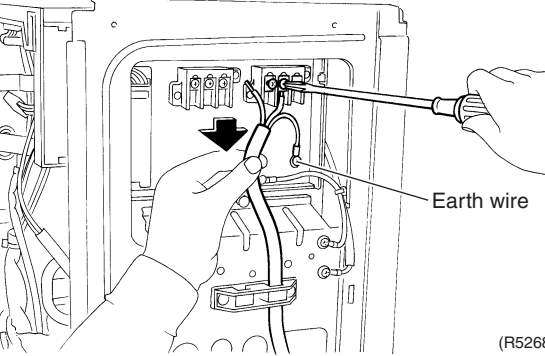

**Warning** Be sure to wait for 10 minutes or more after turning off all power supplies before disassembling work.

Step	Procedure	Points	
1. Remove the shield plate.			
1 Remove the 2 screws.	 <p style="text-align: right;">(R5266)</p>	<p>■ Remove the top panel and the front panel according to the "Removal of Outer Panels".</p>	
2 Slide the shield plate upward to unfasten the 1 hook on the bottom left, and then remove the shield plate.	 <p style="text-align: right;">(R5267)</p>		
3 Disconnect the 2 power supply cables and the 1 earth wire.	 <p style="text-align: right;">(R5268)</p>		

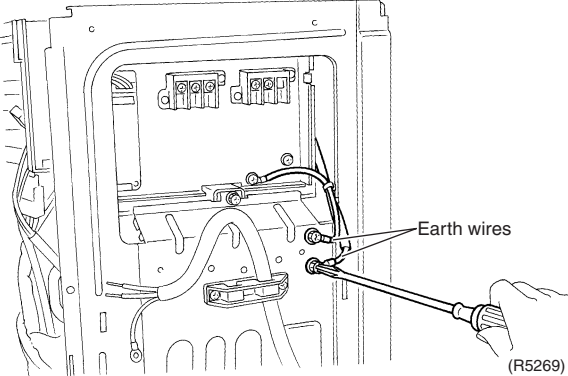
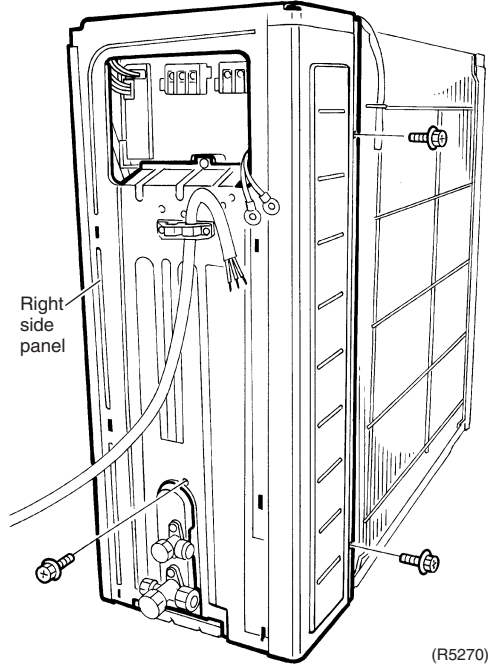
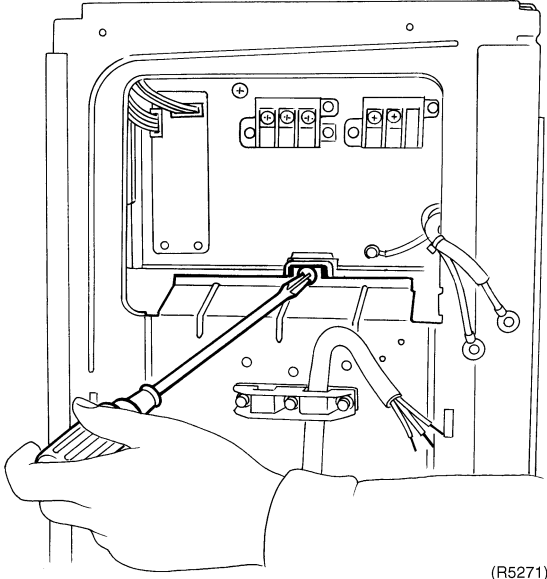

Step	Procedure	Points
4	Disconnect the 2 earth wires.	
	 <p>(R5269)</p>	
5	Remove the 3 screws of the right side panel.	
	 <p>(R5270)</p>	
6	Remove the screw of the electrical box.	
	 <p>(R5271)</p>	

Step	Procedure	Points
7	Unfasten the hooks and remove the right side panel.	■ Insert the 2 hooks of the lower part and the 1 hook of the upper back when reassembling the right side panel.
8	Disconnect the connectors of the front side. [S20]: electronic expansion valve coil [S40]: overload protector [S80]: four way valve coil [S90]: thermistors (outdoor temperature, outdoor heat exchanger, discharge pipe)	
9	Disconnect the relay connector for the compressor.	

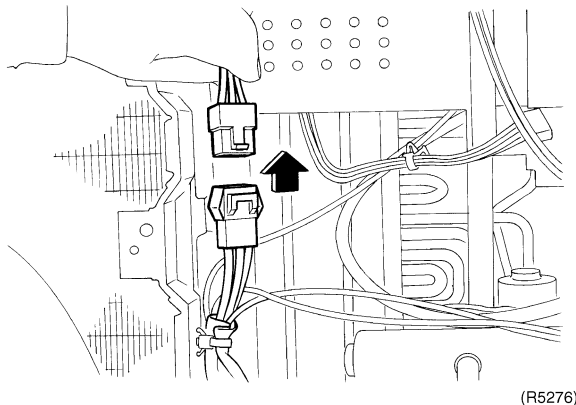
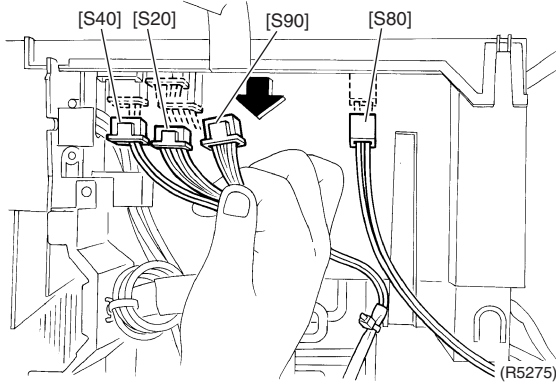
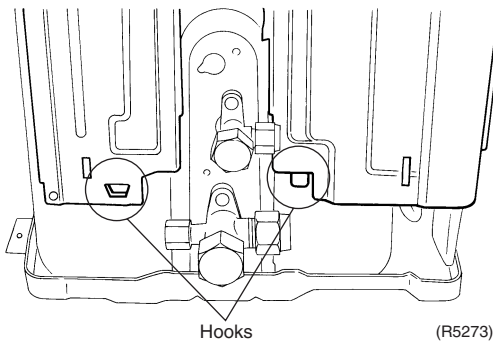
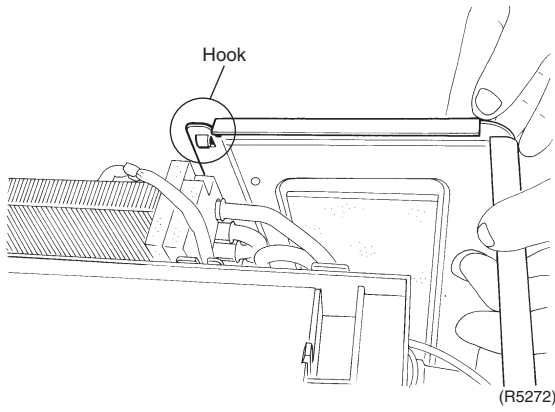

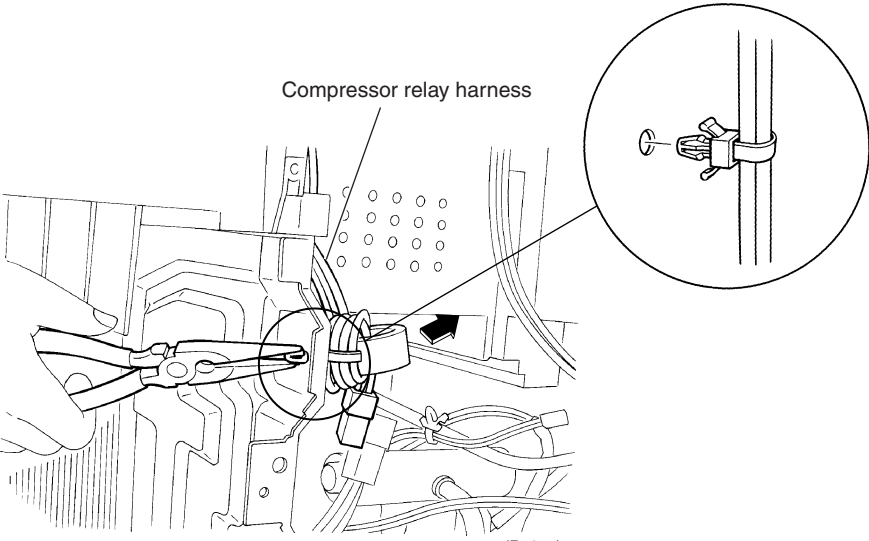
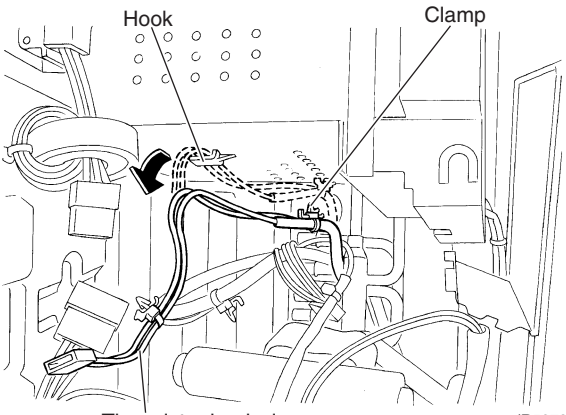
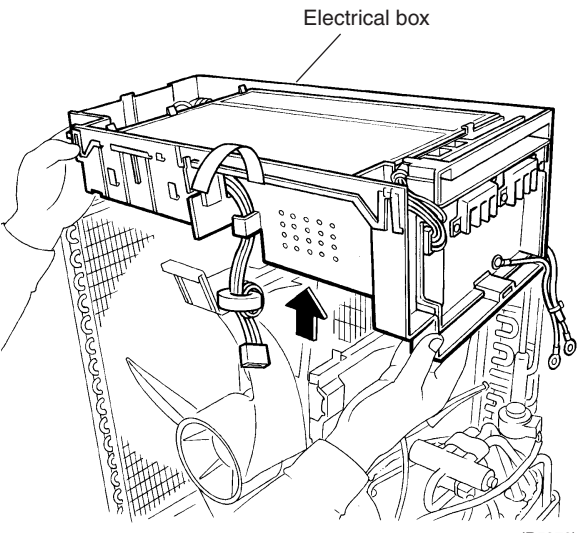
Step	Procedure	Points
10	Release the clamp of the compressor relay harness with pliers.	
11	Detach the clamp and release the thermistor lead wires from the hook.	
12	Lift the electrical box and remove it.	

## 2.4 Removal of PCB

**Procedure**

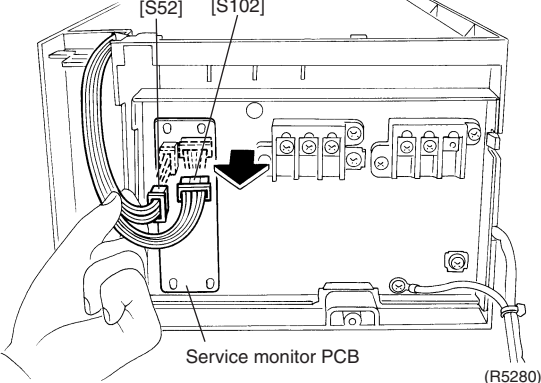
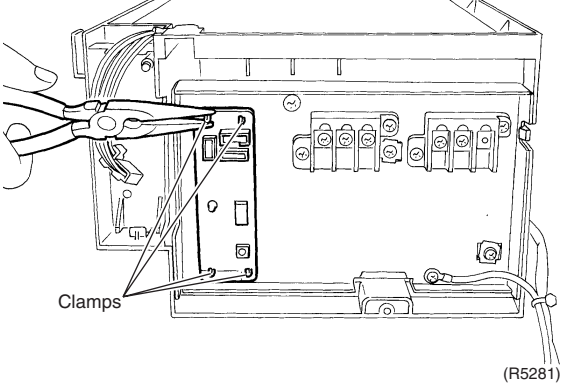
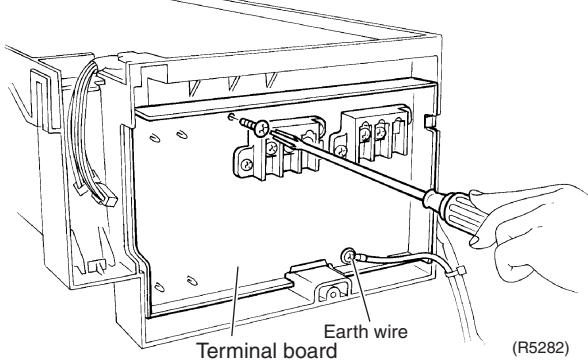

**Warning** Be sure to wait for 10 minutes or more after turning off all power supplies before disassembling work.

Step	Procedure	Points
<p>1. Remove the PCB.</p> <p>1 Disconnect the connectors from the service monitor PCB [S52] [S102].</p> <p>2 Detach the 4 clamps with pliers.</p> <p>3 Remove the screws of the terminal board and the earth wire.</p>	 <p>(R5280)</p>  <p>(R5281)</p>  <p>(R5282)</p>	<ul style="list-style-type: none"> <li>■ Remove the electrical box according to the "Removal of Electrical Box".</li> </ul>

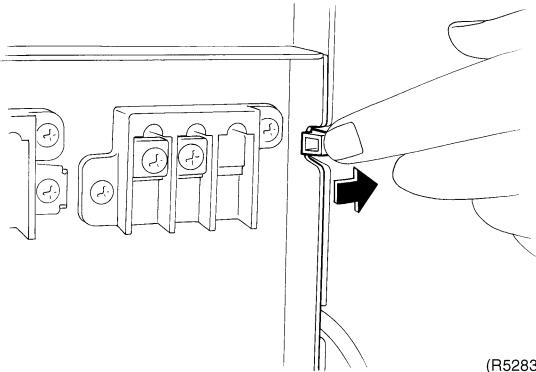
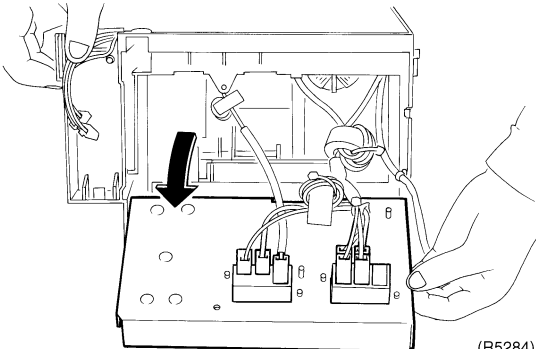
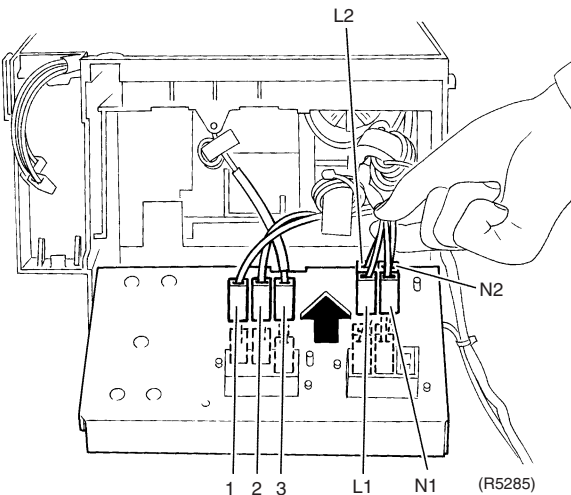
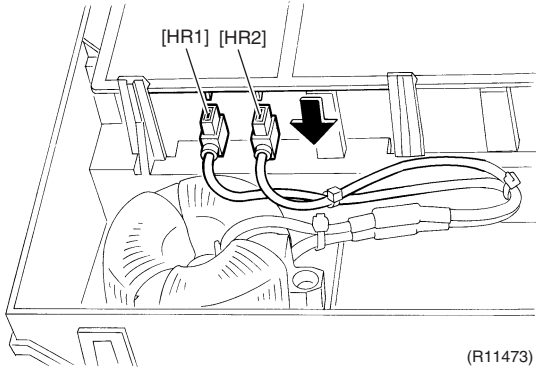
Step	Procedure	Points
4	<p>Unfasten the hook on the right.</p>  <p>(R5283)</p>	
5	<p>Open the terminal board.</p>  <p>(R5284)</p>	
6	<p>Disconnect the harnesses.</p>  <p>(R5285)</p>	<p>1: Black                  2: White                  3: Red                  L1: Black                  L2: Brown                  N1: White                  N2: Blue</p>
7	<p>Disconnect the 2 harnesses for the reactor [HR1] [HR2].</p>  <p>(R11473)</p>	

Step	Procedure	Points
8	Remove the 3 screws of the main PCB.	
9	Unfasten the 4 hooks.	
10	Lift up and remove the main PCB.	<ul style="list-style-type: none"> <li>■ See page 10 for detail of the main PCB.</li> </ul>

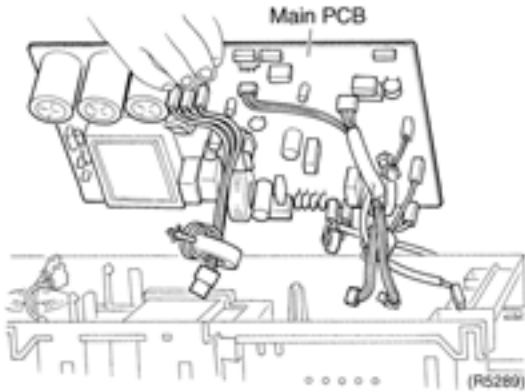
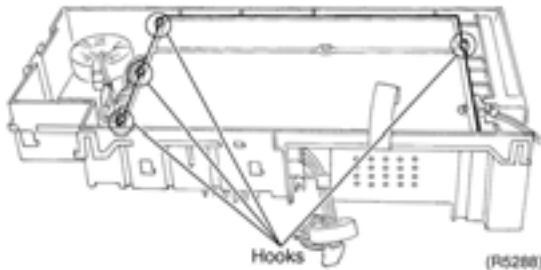
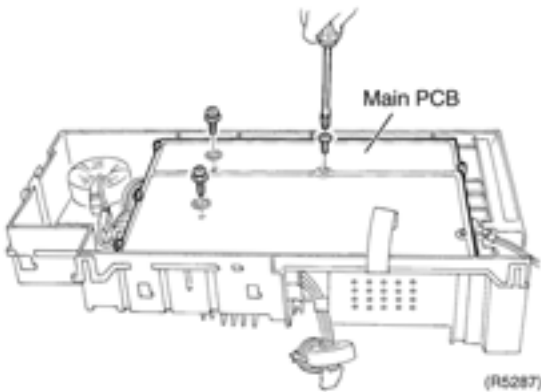

## 2.5 Removal of Sound Blanket / Thermistors

**Procedure**



**Warning** Be sure to wait for 10 minutes or more after turning off all power supplies before disassembling work.

Step	Procedure	Procedure	Points
1	Remove the sound blanket (back).		
2	Remove the sound blanket (outer).		<ul style="list-style-type: none"> <li>■ Since the piping ports on the sound blanket are torn easily, remove the blanket carefully.</li> </ul>
3	Remove the sound blanket (top upper).		

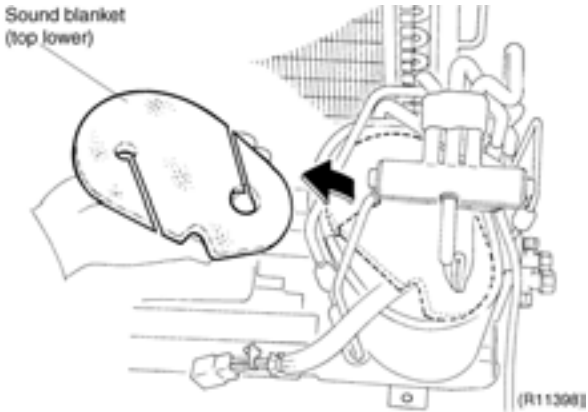
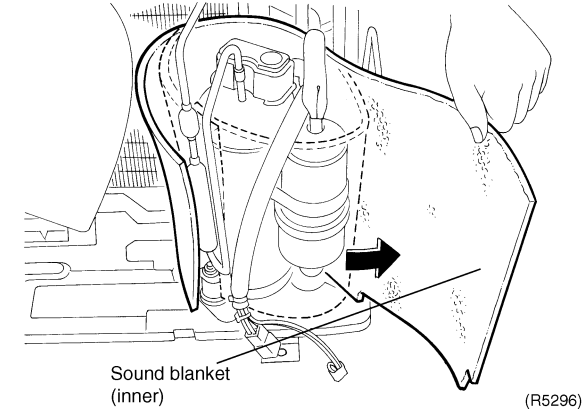
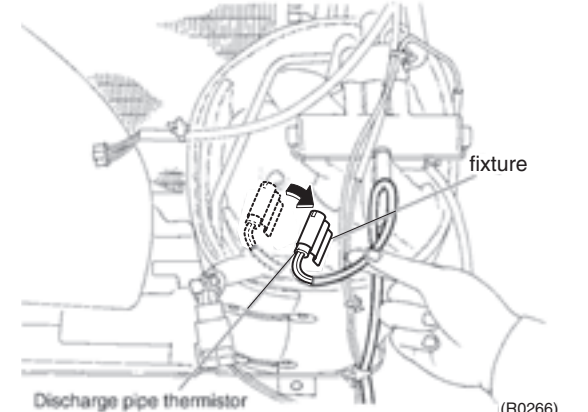
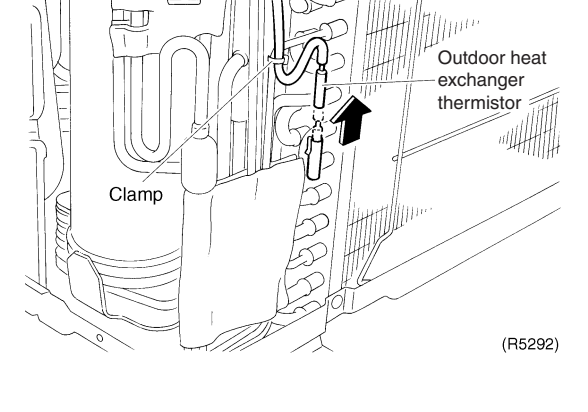
Step	Procedure	Points
4	<p>Remove the sound blanket (top lower).</p> 	
5	<p>Remove the sound blanket (inner).</p> 	<ul style="list-style-type: none"> <li>Since the piping ports on the sound blanket are torn easily, remove the blanket carefully.</li> </ul>
6	<p>Release the discharge pipe thermistor.</p> 	
7	<p>Cut the clamp. Pull out the outdoor heat exchanger thermistor.</p> 	<ul style="list-style-type: none"> <li>Always prepare spare clamps when reassembling.</li> </ul>



## 2.6 Removal of Four Way Valve

### Procedure

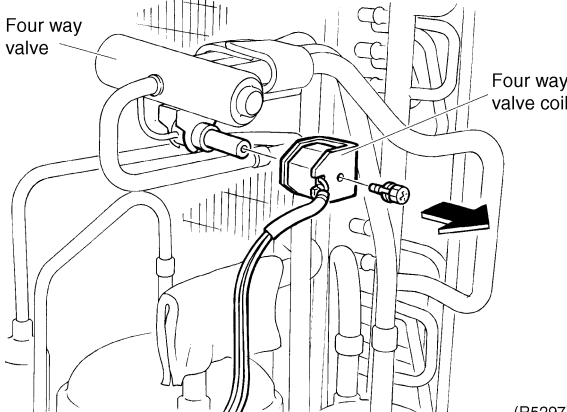
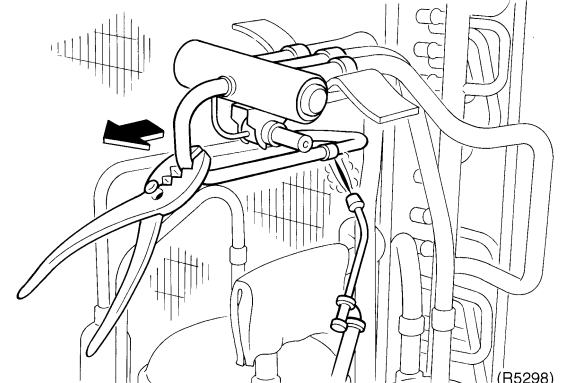
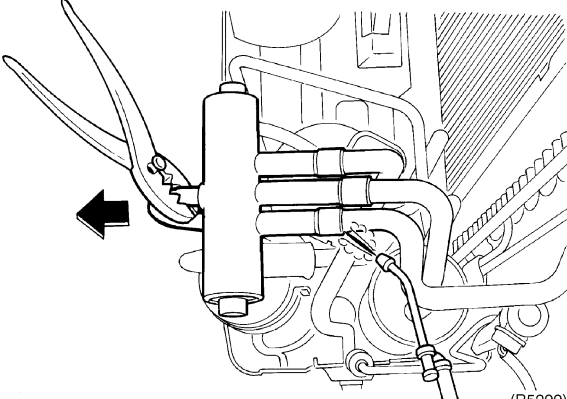

**Warning** Be sure to wait 10 minutes or more after turning off all power supplies before disassembling work.

Step	Procedure	Procedure	Points
1	Remove the screw of the four way valve coil.	 <p>(R5297)</p>	<ul style="list-style-type: none"> <li>■ Provide a protective sheet or a steel plate so that the brazing flame cannot influence peripheries.</li> <li>■ Be careful so as not to break the pipes by pressing it excessively by pliers when withdrawing it.</li> </ul> <p><b>Caution</b> Be careful about the four way valve, pipes and so on, which were heated up by a gas welding machine, so as not to get burnt your hands.</p>
2	Heat up the brazed part of the four way valve and disconnect.  ■ Be sure to apply nitrogen replacement when heating up the brazed part.	 <p>(R5298)</p>	<p><b>Cautions for restoration</b></p> <ol style="list-style-type: none"> <li>1. Restore the piping by non-oxidation brazing. Braze it quickly when no nitrogen gas can be used.</li> <li>2. It is required to prevent the carbonization of the oil inside the four way valve and the deterioration of the gaskets affected by heat. For the sake of this, wrap the four way valve with wet cloth and provide water so that the cloth does not dry and avoid excessive heating. (Keep below 120°C)</li> </ol> <p><b>In case of difficulty with gas brazing machine</b></p> <ol style="list-style-type: none"> <li>1. Disconnect the brazed part where is easy to disconnect and restore.</li> <li>2. Cut pipes on the main unit with a tube cutter in order to make it easy to disconnect.</li> </ol>
3	Heat up every brazed part in turn and disconnect.	 <p>(R5299)</p>	<p><b>Note:</b> Do not use a metal saw for cutting pipes by all means because the sawdust come into the circuit.</p>

## 2.7 Removal of Electronic Expansion Valve

**Procedure**

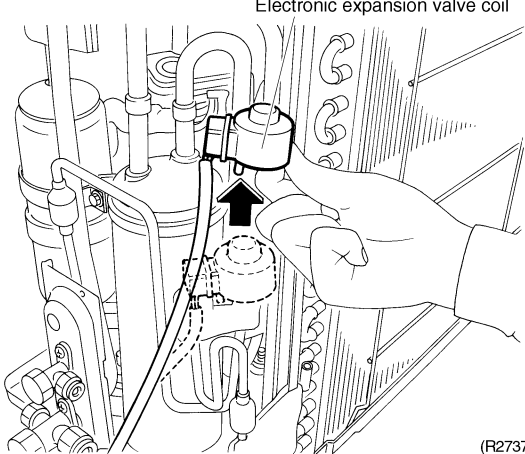
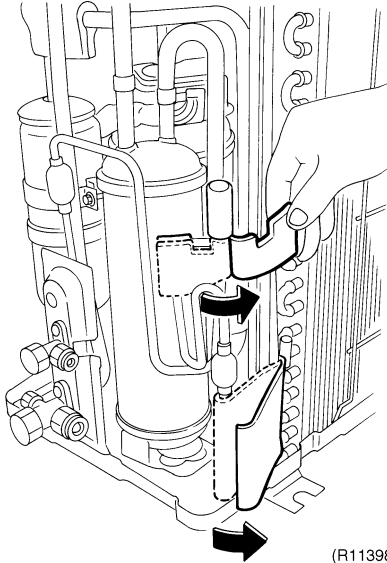
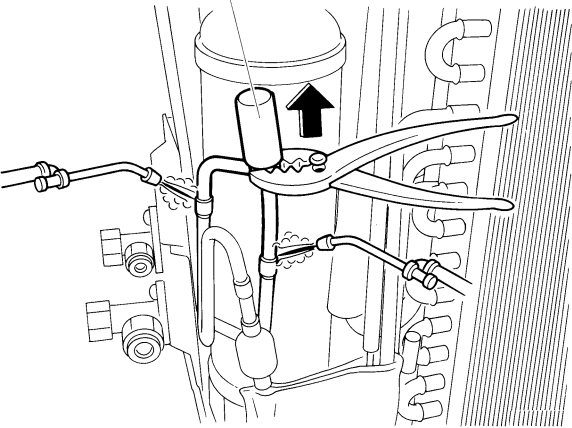

**Warning** Be sure to wait for 10 minutes or more after turning off all power supplies before disassembling work.

Step	Procedure	Points
1	Remove the electronic expansion valve coil.  <p style="text-align: right;">(R2737)</p>	
2	Remove the sheets of putty.  <p style="text-align: right;">(R11398)</p>	<ul style="list-style-type: none"> <li>■ Before working, make sure that the refrigerant is empty in the circuit.</li> <li>■ Be sure to apply nitrogen replacement when heating up the brazed part.</li> </ul>
3	Heat up the 2 brazed parts of the electronic expansion valve and disconnect.  <p style="text-align: right;">(R2739)</p>	<p><b>Caution</b> Be careful about the electronic expansion valve, pipes and so on, which were heated up by a gas welding machine, so as not to get burnt your hands.</p> <p><b>Warning</b> Ventilate when refrigerant leaks during the work. (If refrigerant contacts fire, it causes to arise toxic gas.)</p>

## 2.8 Removal of Compressor

**Procedure**

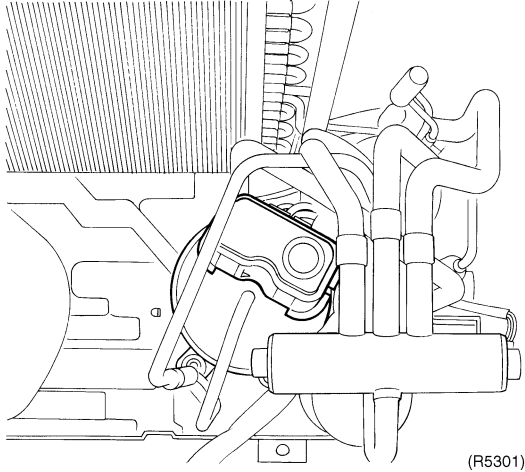
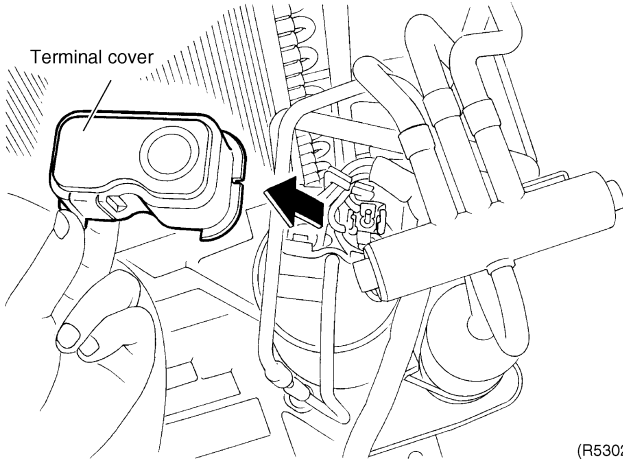
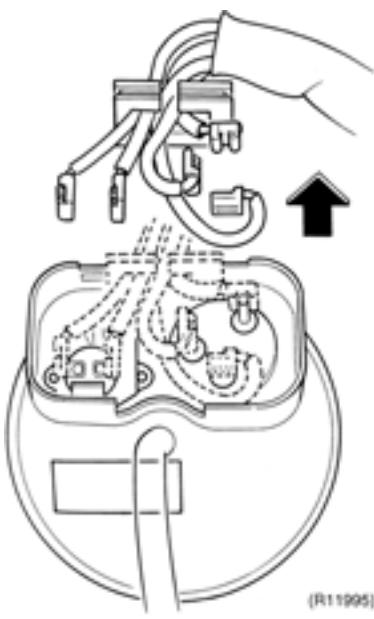

**Warning** Be sure to wait for 10 minutes or more after turning off all power supplies before disassembling work.

Step	Procedure	Procedure	Points
1	Remove the terminal cover.	 <p>(R5301)</p>  <p>Terminal cover</p> <p>(R5302)</p>	
2	Disconnect the lead wires of the compressor.	 <p>(R11995)</p>	

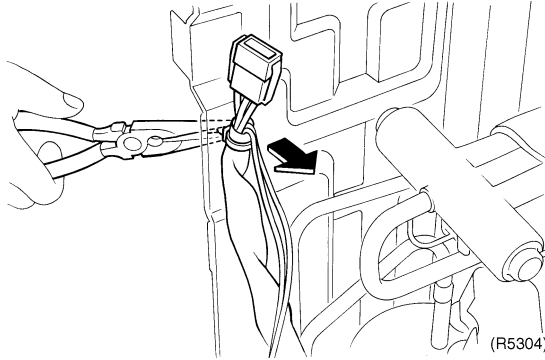
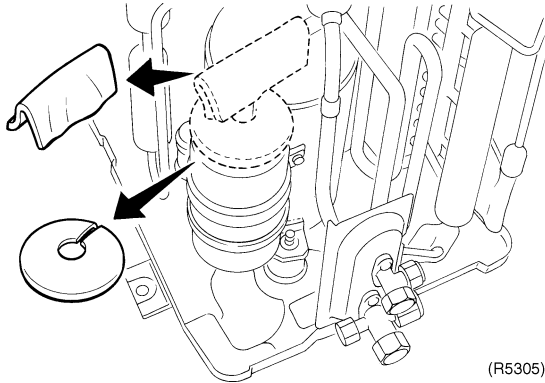
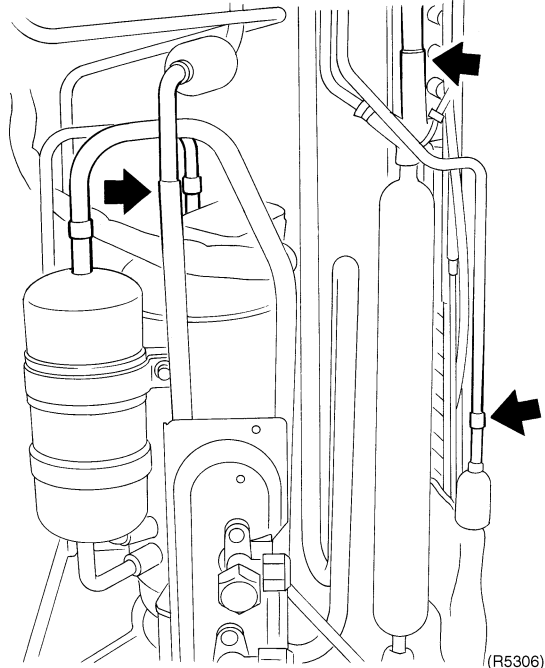
Step	Procedure	Points
3	<p>Release the clamp with pliers to detach the compressor lead wires.</p>  <p>(R5304)</p>	
4	<p>Remove the putty.</p> <ul style="list-style-type: none"> <li>■ Before working, make sure that the refrigerant is empty in the circuit.</li> <li>■ Be sure to apply nitrogen replacement when heating up the brazed part.</li> </ul>  <p>(R5305)</p>	
5	<p>Heat up the brazed parts indicated by the arrows.</p>  <p>(R5306)</p>	<p><b>Warning</b>  <b>Ventilate when refrigerant leaks during the work.</b>  <b>(If refrigerant contacts fire, it causes to arise toxic gas.)</b></p> <ul style="list-style-type: none"> <li>■ Provide a protective sheet or a steel plate so that the brazing flame cannot influence peripheries.</li> <li>■ Be careful so as not to burn the compressor terminals or the name plate.</li> <li>■ Be careful so as not to burn the heat exchanger fin.</li> </ul> <p><b>Warning</b>  <b>Since it may happen that refrigerant oil in the compressor catches fire, prepare wet cloth so as to extinguish fire immediately.</b></p>

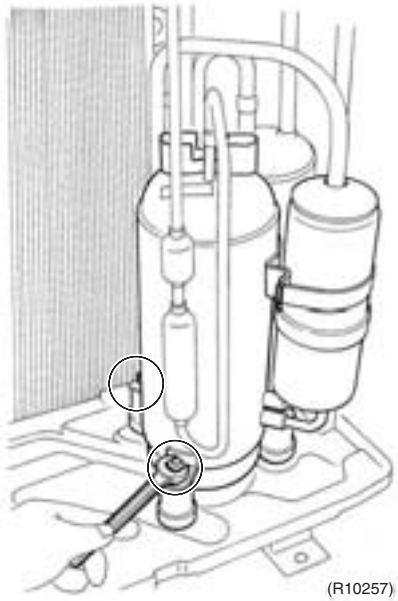
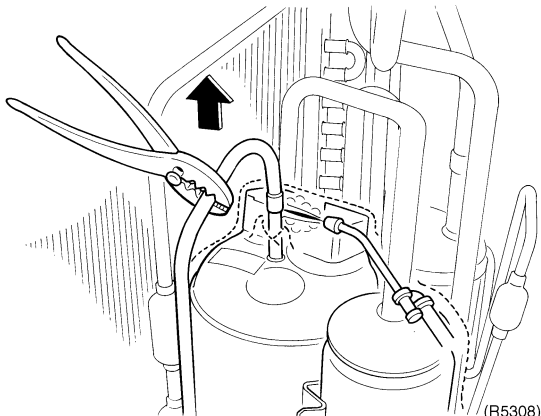
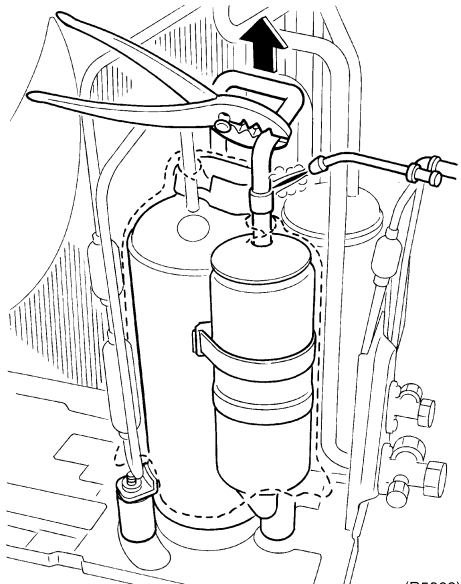
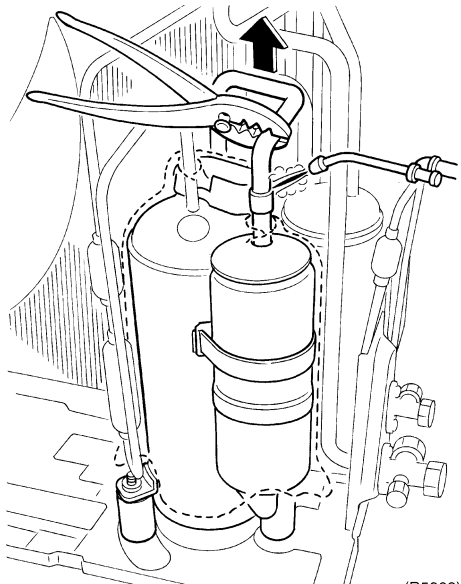
Step	Procedure	Procedure	Points
6	Remove the 2 nuts of the compressor.	 <p>(R10257)</p>	
7	Heat up the brazed part of the discharge side and disconnect. <ul style="list-style-type: none"> <li>■ Before working, make sure that the refrigerant is empty in the circuit.</li> <li>■ Be sure to apply nitrogen replacement when heating up the brazed part.</li> </ul>	 <p>(R5308)</p>	
8	Heat up the brazed part of the suction side and disconnect.	 <p>(R5309)</p>	
9	Lift the compressor up and remove it.	 <p>(R5309)</p>	

# 3. Outdoor Unit - RX71GV1B

## 3.1 Removal of Outer Panels

Procedure

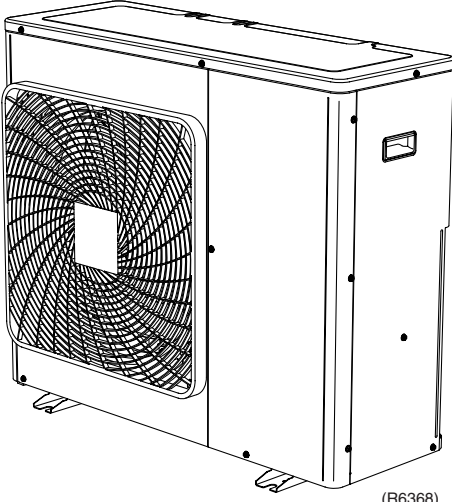
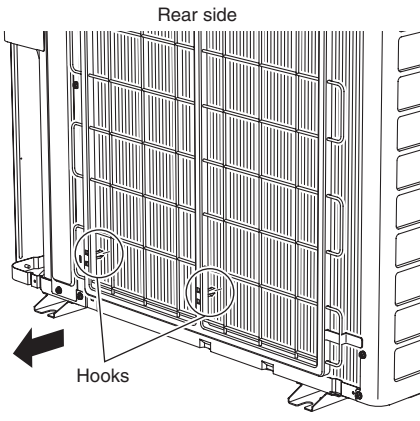
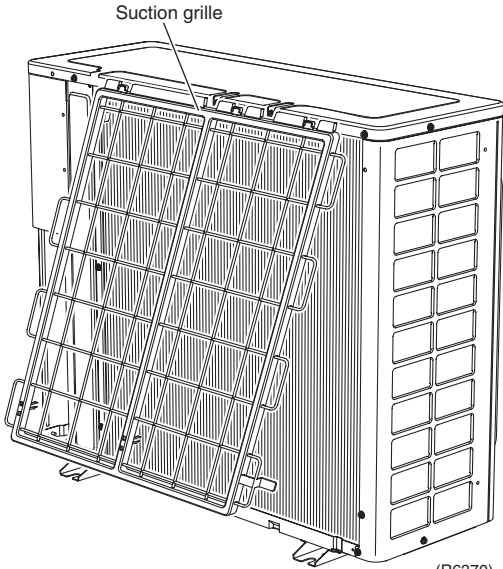

**Warning** Be sure to wait for 10 minutes or more after turning off all power supplies before disassembling work.

Step	Procedure	Points
1. External appearance	 <p>(R6368)</p>	
2. Remove the suction grille.	<p>1 Unfasten the 2 hooks at the bottom first.</p>  <p>Rear side</p> <p>Hooks</p> <p>(R6369)</p>  <p>Suction grille</p> <p>(R6370)</p>	<ul style="list-style-type: none"> <li>■ The hooks are secured in the clearances of the outdoor heat exchanger fins.</li> </ul>

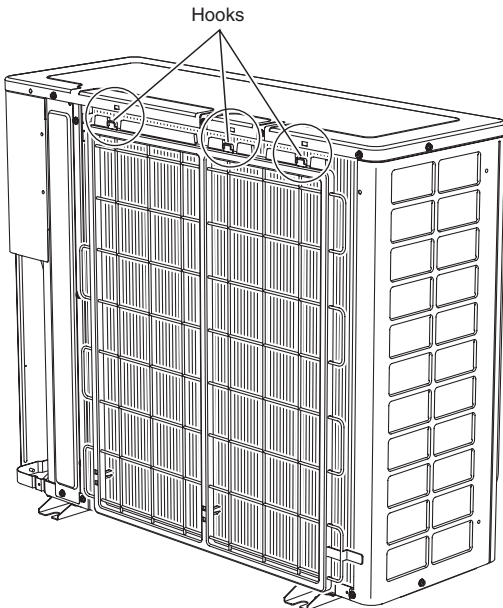
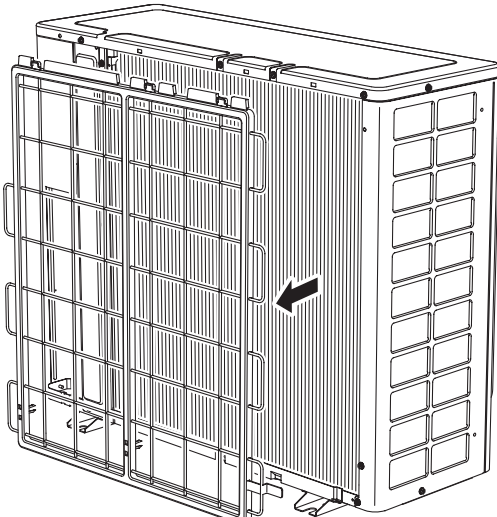
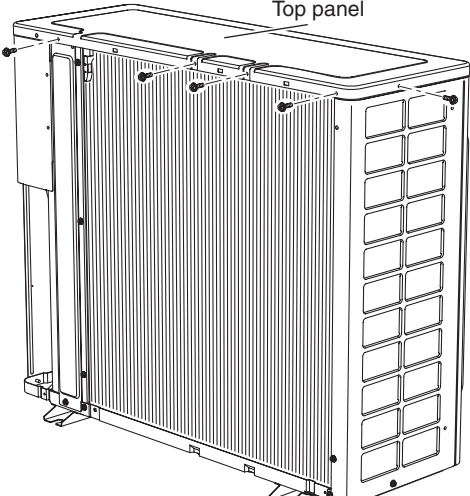
Step	Procedure	Points
2	<p>Slide the suction grille downward to unfasten the 3 top hooks.</p>  <p style="text-align: center;">Hooks</p> <p style="text-align: right;">(R6371)</p>	
3	<p>Remove the suction grille.</p>  <p style="text-align: right;">(R6372)</p>	
3.	<p>Remove the top panel.</p>	
1	<p>Remove the 4 screws on the back and the 1 screw on the left side.</p>  <p style="text-align: center;">Top panel</p> <p style="text-align: right;">(R6373)</p>	

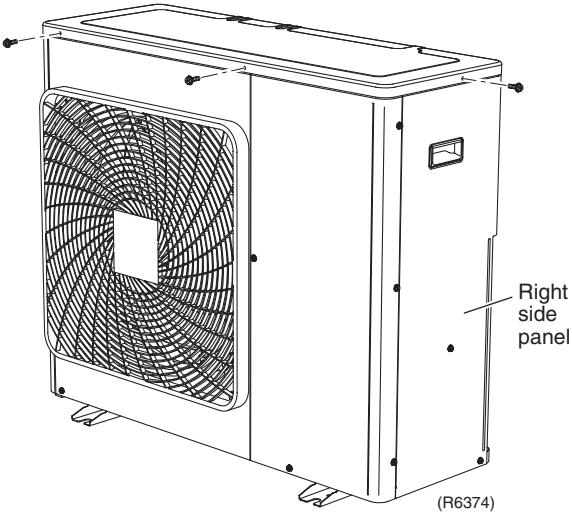
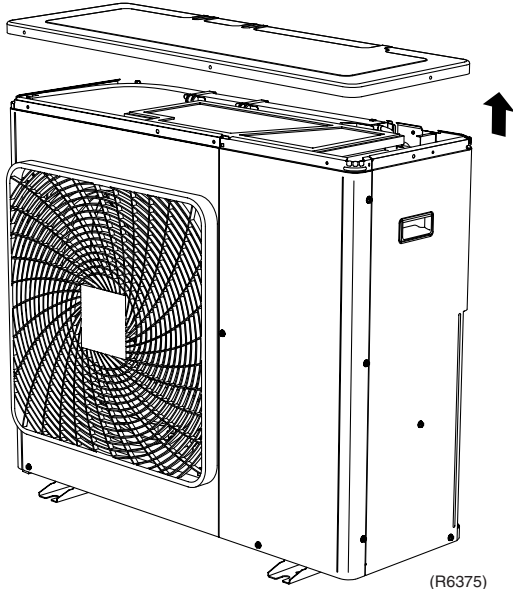
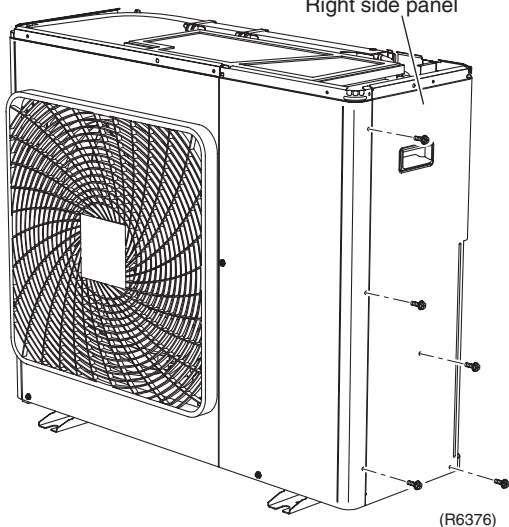
Step	Procedure	Points
<p>2</p>	<p>Remove the 2 screws on the front and the 1 screw on the right side panel.</p>  <p>Right side panel</p> <p>(R6374)</p>	
<p>3</p>	<p>Lift the top panel and remove it.</p>  <p>(R6375)</p>	
<p>4. Remove the right side panel.</p>	<p>1 Remove the 5 screws.</p>  <p>Right side panel</p> <p>(R6376)</p>	

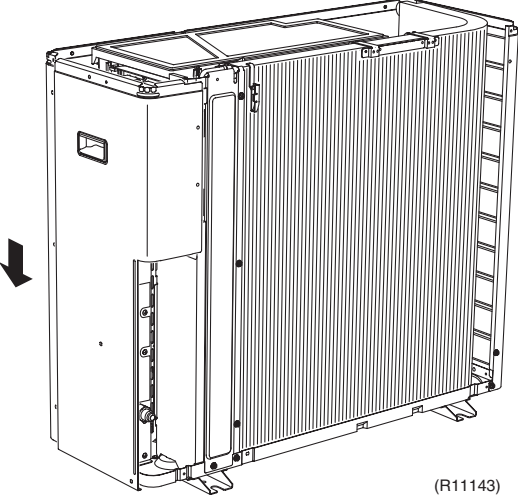
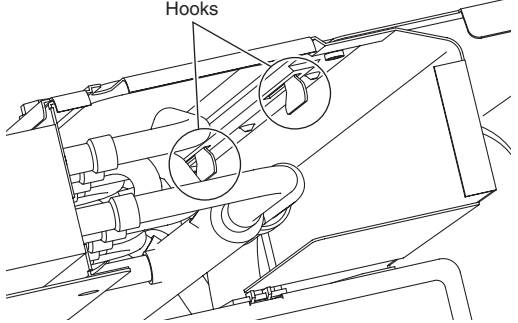
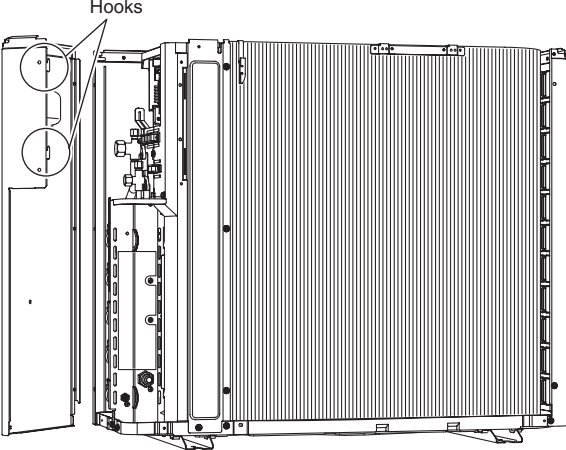

Step	Procedure	Points
<p>2</p>	<p>Slide the right side panel downward to unfasten the 2 hooks on the back side.</p>  <p>(R11143)</p>  <p>Hooks</p> <p>(R6378)</p>  <p>Hooks</p> <p>(R11144)</p>	

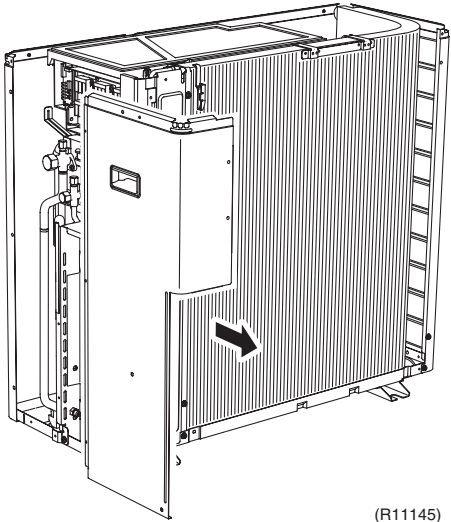
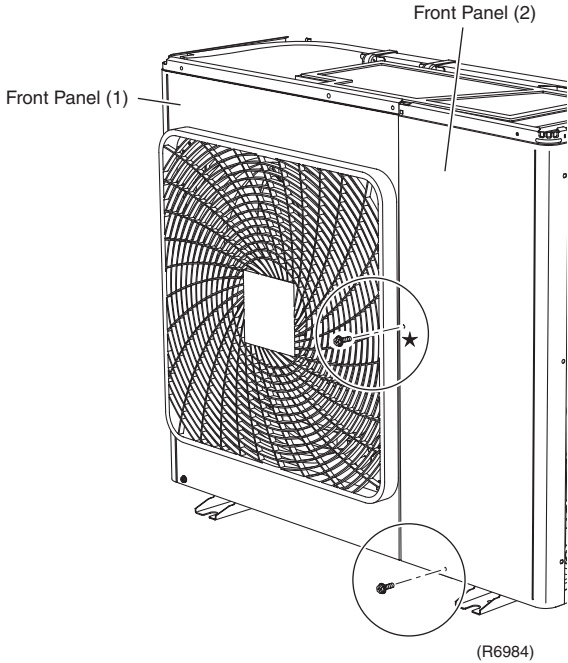
Step	Procedure	Points
3	Remove the right side panel.  <p>(R11145)</p>	
5.	Remove the front panel (2).	
1	Remove the 2 screws.  <p>Front Panel (1)</p> <p>Front Panel (2)</p> <p>★ This screw is M5(3) × 16</p> <p>(R6984)</p>	

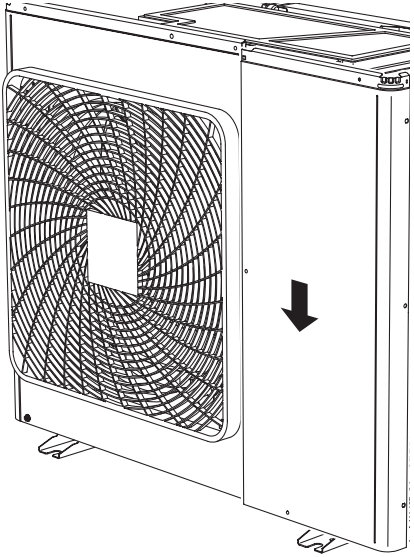
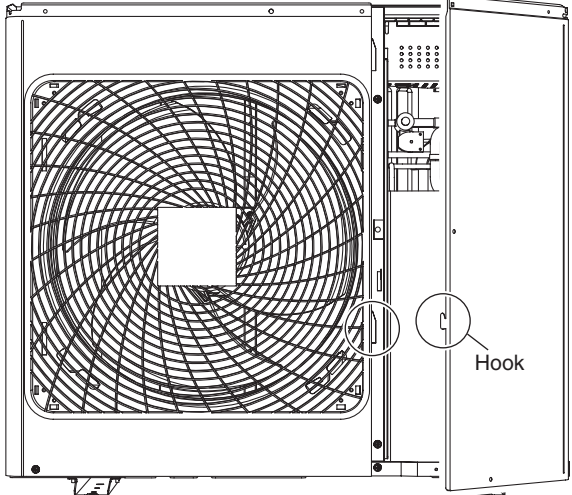
Step	Procedure	Points
2	Slide the front panel (2) downward to unfasten the hook.	 <p>(R6985)</p>
3	Remove the front panel (2).	 <p>(R6383)</p>

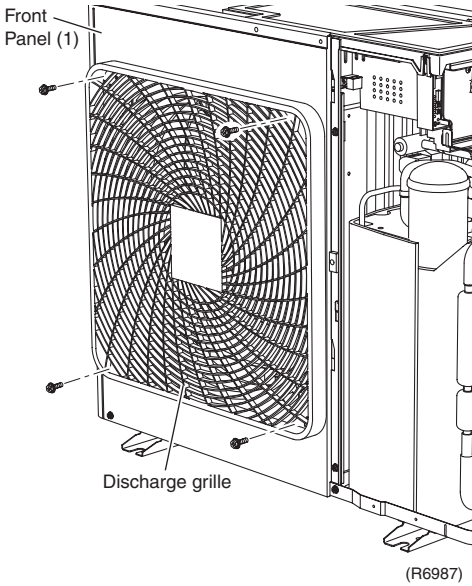
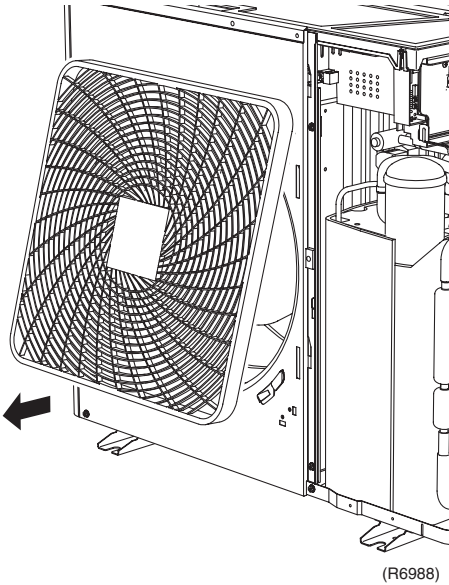
Step	Procedure	Points
6. Remove the front panel (1).		<p><b>Preparation</b></p> <ul style="list-style-type: none"> <li>Remove the discharge grille and the outdoor fan first to remove the front panel (1).</li> </ul>
1	<p>Remove the 4 screws on the discharge grille.</p>  <p>(R6987)</p>	
2	<p>Pull the bottom of the discharge grille toward yourself.</p>  <p>(R6988)</p>	

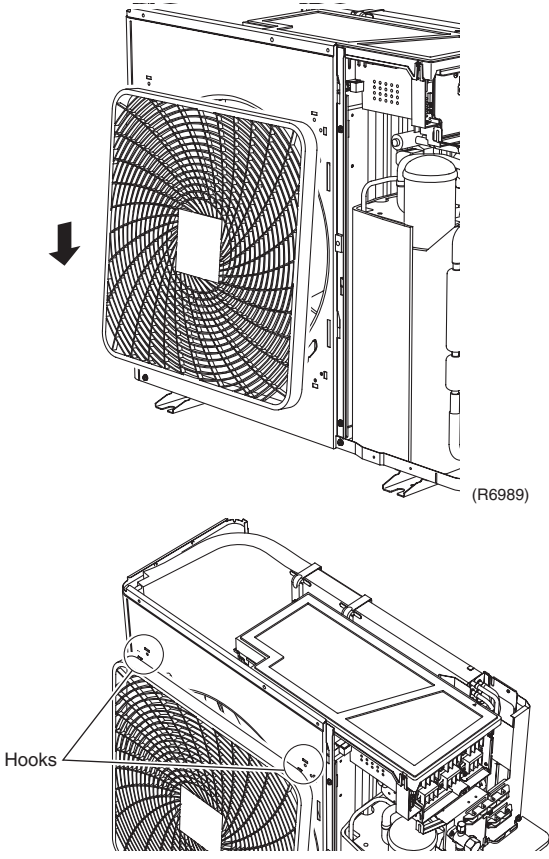
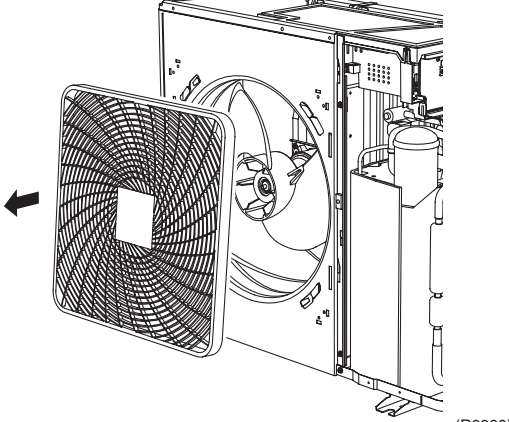
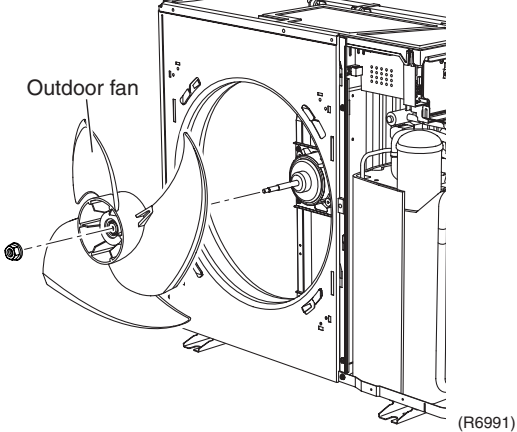
Step	Procedure	Procedure	Points
3	Slide the discharge grille downward to unfasten the 2 hooks at the top.	 <p>(R6989)</p> <p>(R6388)</p>	
4	Remove the discharge grille.	 <p>(R6990)</p>	
5	Remove the outdoor fan fixing nut (M8).	 <p>Outdoor fan</p> <p>(R6991)</p>	<p>■ Wrench size : 13 mm</p>

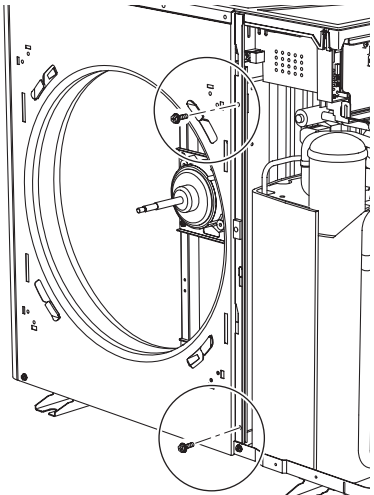
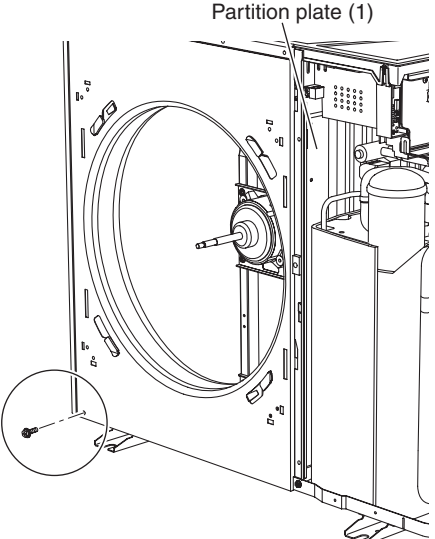
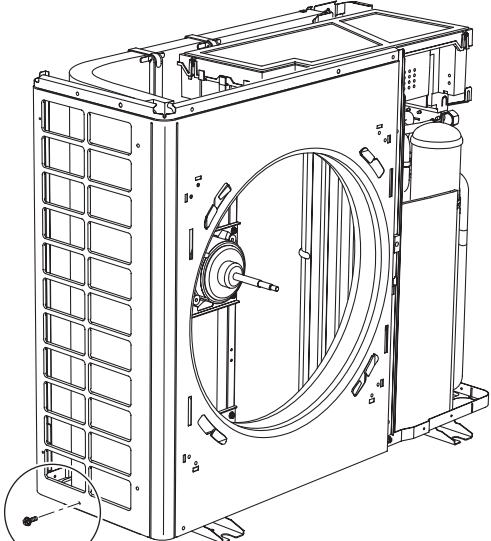
Step	Procedure	Points
6	<p>Remove the 2 screws on the partition plate (1).</p>  <p>(R6992)</p>	
7	<p>Remove the screw at the bottom left of the front.</p>  <p>Partition plate (1)</p> <p>(R6993)</p>	
8	<p>Remove the screw at the bottom of the left side.</p>  <p>(R6393)</p>	

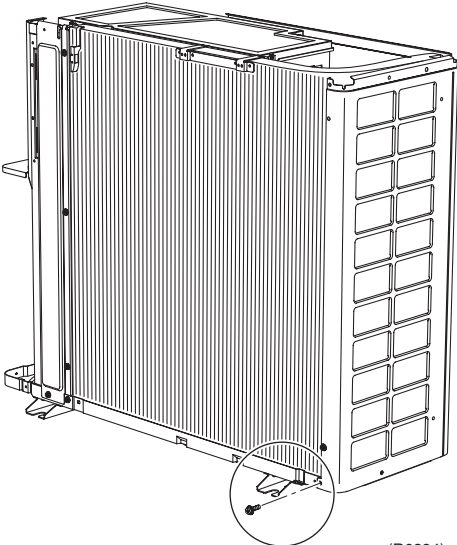
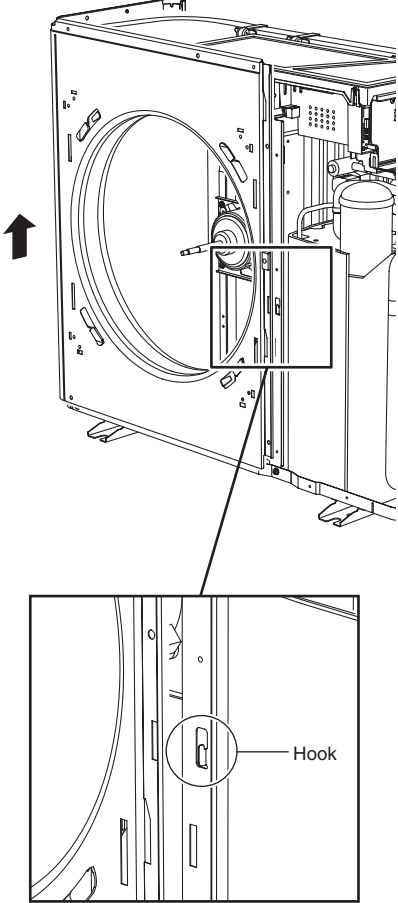
Step	Procedure	Points
9	<p>Remove the screw at the bottom of the back side.</p>  <p>(R6394)</p>	
10	<p>The front panel (1) has a hook on its front. Lift the front panel (1).</p>  <p>(R6994)</p>	

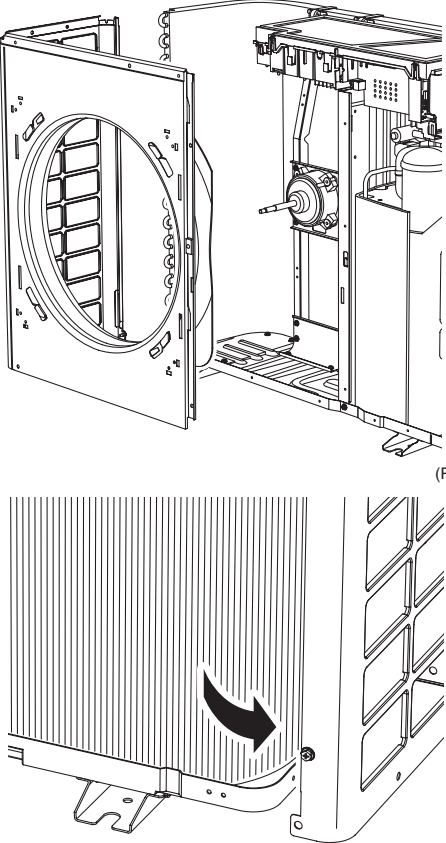
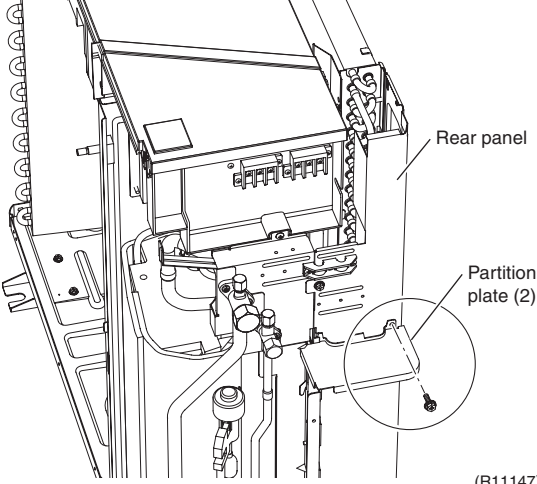
Step	Procedure	Points
<p>11</p>	<p>Remove the front panel (1).</p>  <p>(R11400)</p> <p>(R6995)</p>	<ul style="list-style-type: none"> <li>■ Be sure to detach the front panel (1) carefully so as not to deform.</li> </ul>
<p>7.</p>	<p>Remove the rear panel.</p> <p>1 Remove the screw on the partition plate (2).</p>  <p>(R11147)</p>	

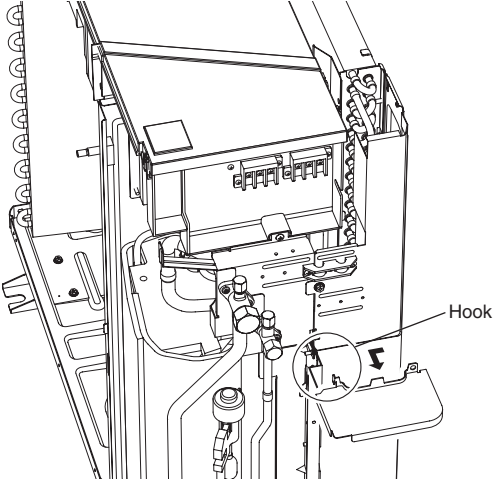
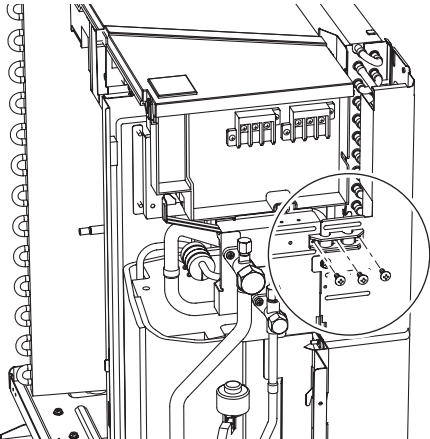
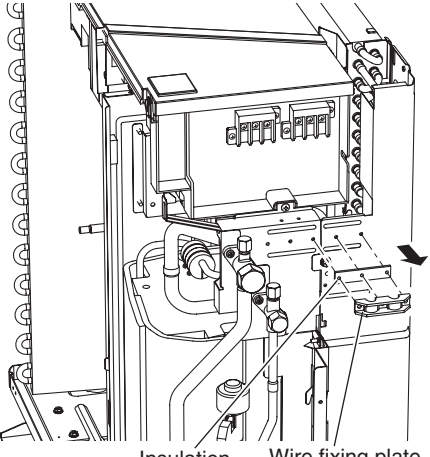

Step	Procedure	Points
2	<p>Slide the partition plate (2) to the left, and remove it.</p>  <p style="text-align: right;">Hook</p> <p style="text-align: right;">(R11148)</p>	
3	<p>Remove the 3 screws on the wire fixing plate.</p>  <p style="text-align: right;">(R11149)</p>	
4	<p>Remove the wire fixing plate and the insulation.</p>  <p style="text-align: right;">Insulation    Wire fixing plate</p> <p style="text-align: right;">(R11150)</p>	

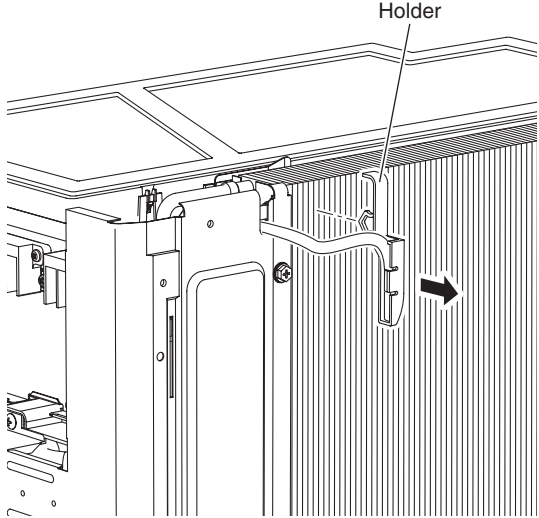
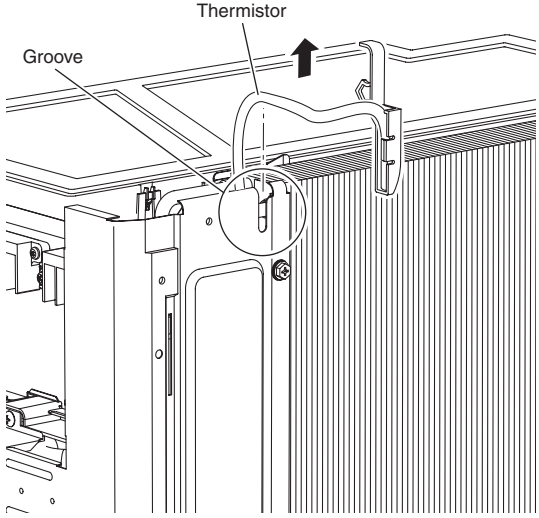
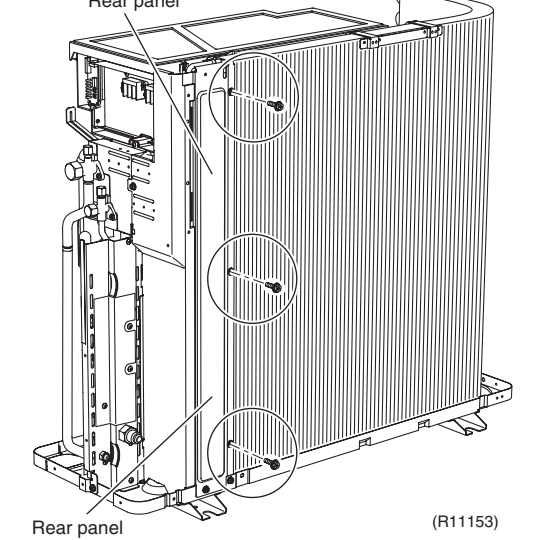
Step	Procedure	Points
5	Release the holder of the thermistor.	<ul style="list-style-type: none"> <li>■ The holder is secured in the clearances of the outdoor heat exchanger fins.</li> </ul>
	 <p style="text-align: right;">(R11151)</p>	
6	Release the thermistor wire from the groove.	
	 <p style="text-align: right;">(R11152)</p>	
7	Remove the 3 screws on the rear panel.	
	 <p style="text-align: right;">(R11153)</p>	

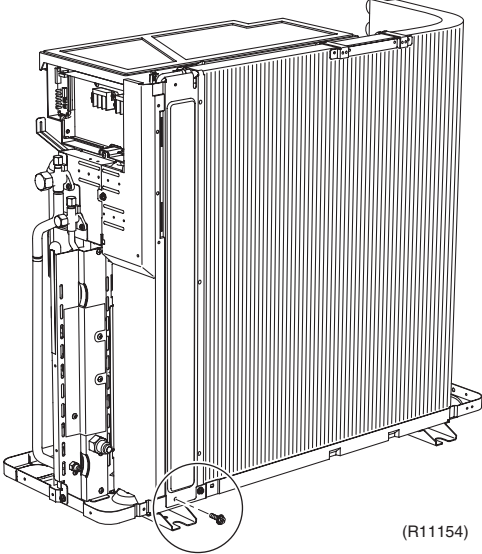
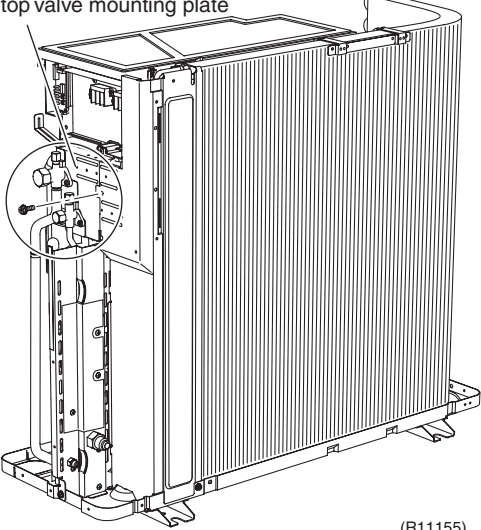
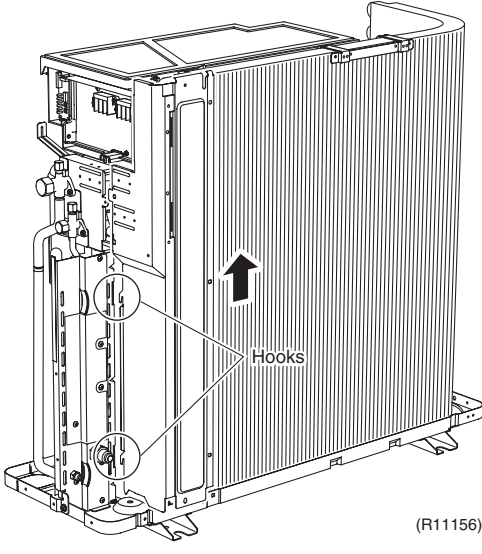
Step	Procedure	Procedure	Points
8	Remove the screw on the bottom frame.	 <p data-bbox="938 786 1007 808">(R11154)</p>	
9	Remove the screw on the stop valve mounting plate.	<p data-bbox="531 891 778 913">Stop valve mounting plate</p>  <p data-bbox="948 1413 1016 1435">(R11155)</p>	
10	Lift the rear panel upward to unfasten the 2 hooks.	 <p data-bbox="954 2018 1023 2040">(R11156)</p>	

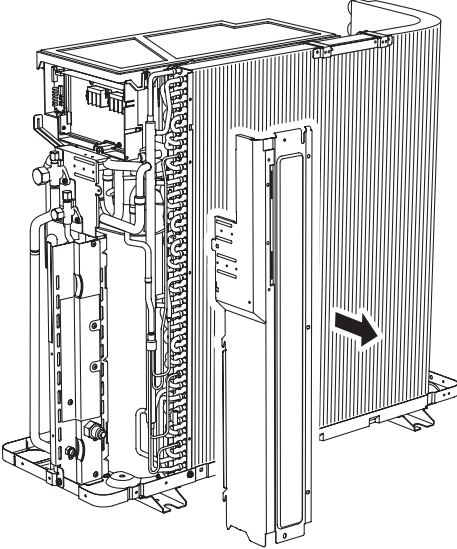
Step	Procedure	Points
11	<p data-bbox="201 219 469 255">Remove the rear panel.</p>  <p data-bbox="940 824 1011 851">(R11157)</p>	

## 3.2 Removal of Electrical Box

**Procedure**



**Warning** Be sure to wait for 10 minutes or more after turning off all power supplies before disassembling work.

Step	Procedure	Procedure	Points
1	Remove the screw on the stop valve mounting plate.	<p style="text-align: center;">(R7005)</p>	
2	Remove the screw on the partition plate (1).	<p style="text-align: center;">(R9467)</p>	
3	Remove the 2 screws to detach the earth wires.	<p style="text-align: center;">(R11158)</p>	

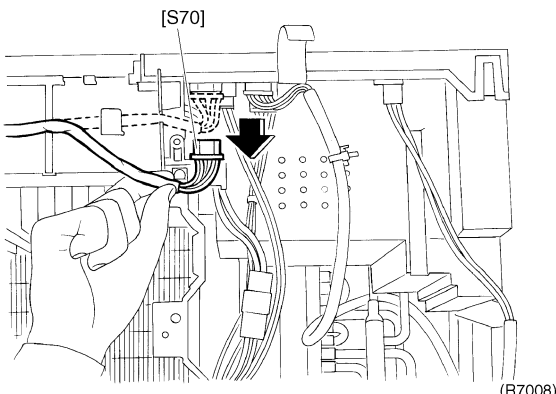
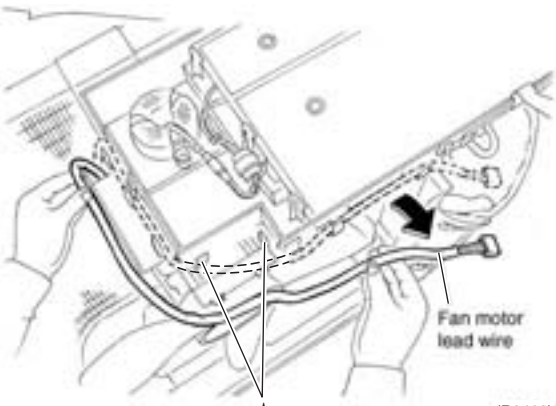
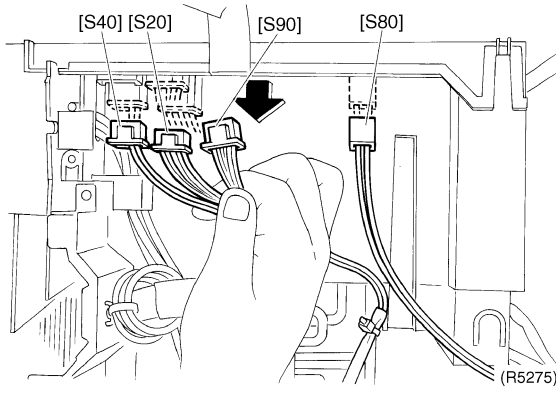
Step	Procedure	Procedure	Points
4	Disconnect the connector for fan motor [S70].		
5	Release the fan motor lead wire from the 5 hooks.		★: When reassembling, do not use these 2 hooks.
6	Disconnect the connectors of the front side. [S20]: electronic expansion valve coil [S40]: overload protector (OL) [S80]: four way valve coil [S90]: thermistors (outdoor temperature, outdoor heat exchanger, discharge pipe)		

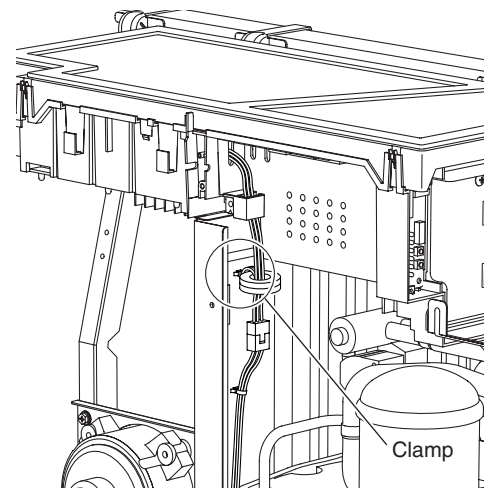
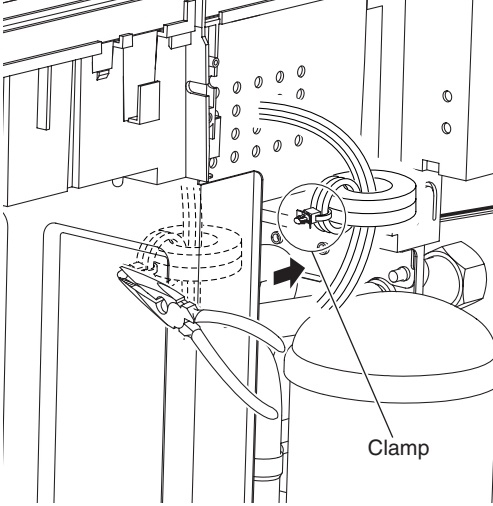
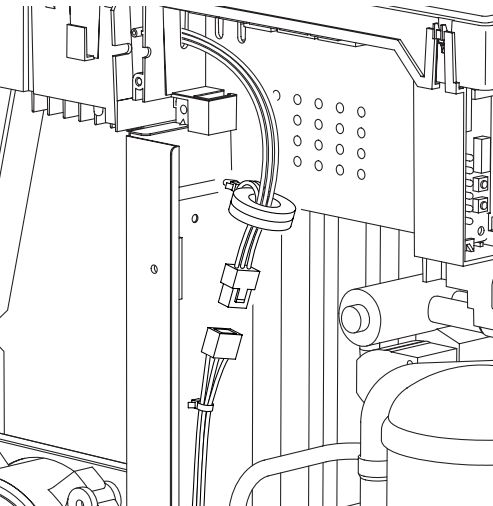
Step	Procedure	Procedure	Points
7	The compressor lead wire is fixed on the partition plate (1) with a clamp.	 <p>(R6422)</p>	
8	Use pliers to pull out the clamp and release the compressor lead wire.	 <p>(R6423)</p>	
9	Disconnect the relay connector of the compressor.	 <p>(R6469)</p>	

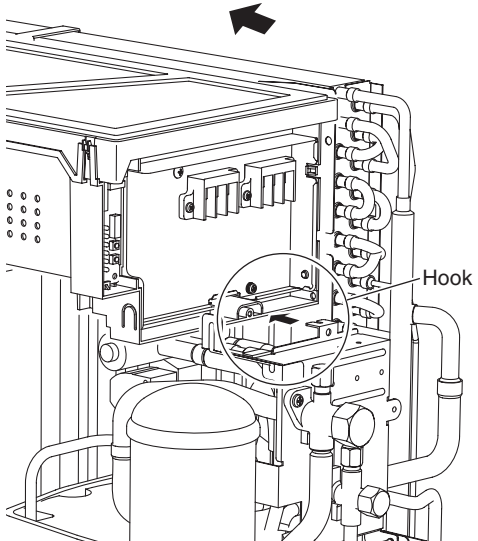
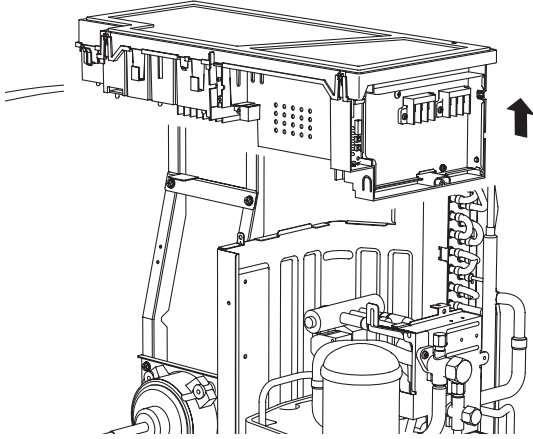
Step	Procedure	Points
10	<p>Slide the electrical box leftward to unfasten the hook on the right side of the box.</p>  <p>(R7009)</p>	
11	<p>Lift up the electrical box and remove it.</p>  <p>(R7010)</p>	



### 3.3 Removal of PCB

#### Procedure

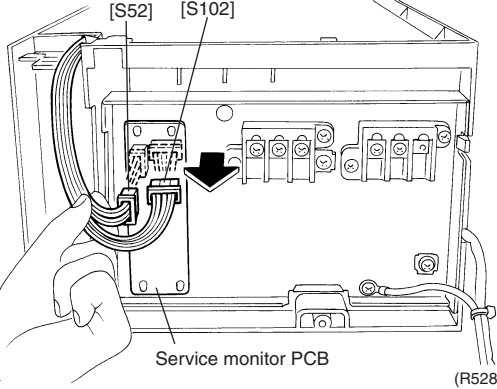
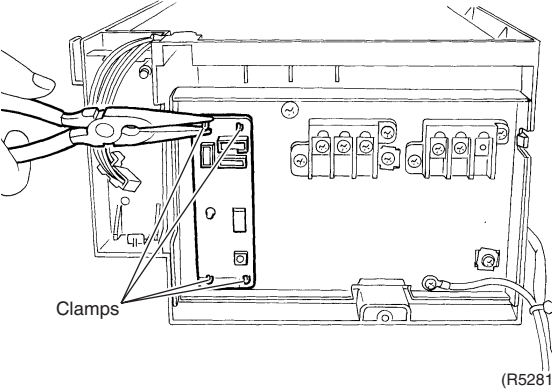
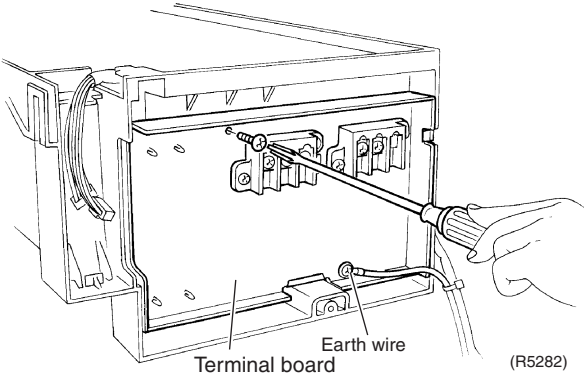

**Warning** Be sure to wait for 10 minutes or more after turning off all power supplies before disassembling work.

Step	Procedure	Points
<p>1. Remove the PCB.</p> <p>1 Disconnect the connectors [S52] [S102] from the service monitor PCB.</p> <p>2 Detach the 4 clamps with pliers to remove the service monitor PCB.</p> <p>3 Remove the screws of the terminal board and the earth wire.</p>	 <p style="text-align: center;">Service monitor PCB (R5280)</p>  <p style="text-align: center;">Clamps (R5281)</p>  <p style="text-align: center;">Terminal board Earth wire (R5282)</p>	<p><b>Preparation</b> Remove the electrical box according to the "Removal of Electrical Box".</p>

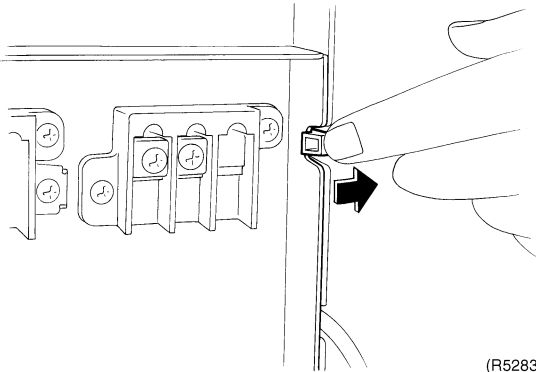
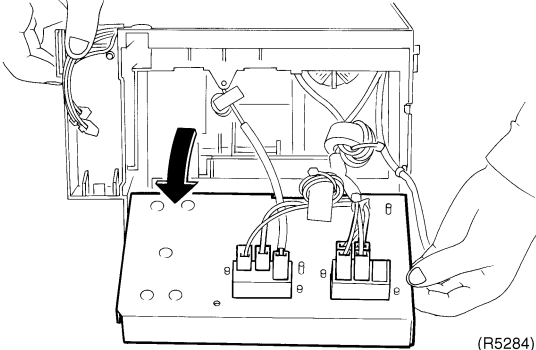
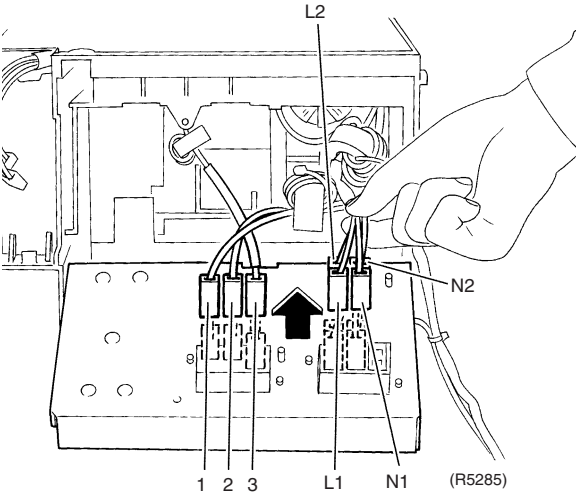
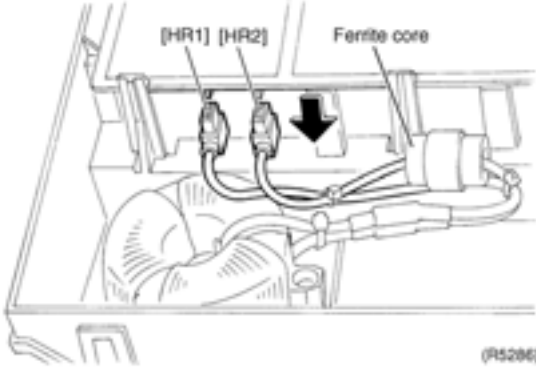
Step	Procedure	Points
4	Unfasten the hook on the right.	
	 <p>(R5283)</p>	
5	Open the terminal board.	
	 <p>(R5284)</p>	
6	Disconnect the harnesses.	
	 <p>(R5285)</p>	<p>1: Black                  2: White                  3: Red                  L1: Black                  L2: Brown                  N1: White                  N2: Blue</p>
7	Disconnect the 2 harnesses for the reactor [HR1] [HR2].	
	 <p>(R5286)</p>	<p>[HR1] : white                  [HR2] : blue                  ■ The harness for [HR2] has a ferrite core.</p>

Step	Procedure	Points
8	Remove the 3 screws of the main PCB.	
9	Unfasten the 4 hooks.	
10	Lift up and remove the main PCB.	<ul style="list-style-type: none"> <li>See page 10 for detail of the main PCB.</li> </ul>

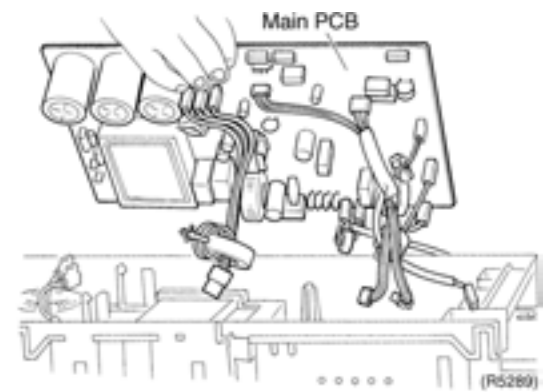
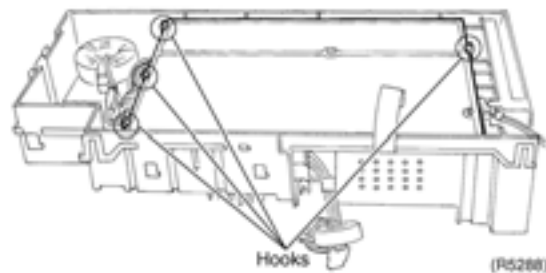
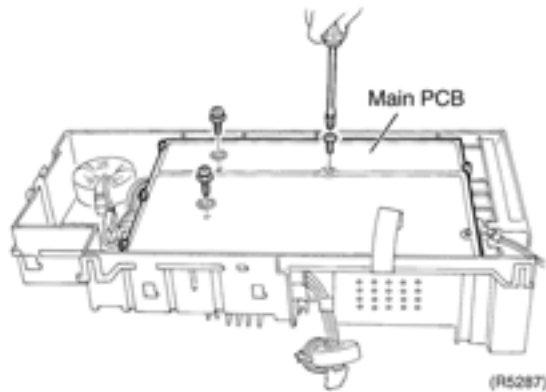

### 3.4 Removal of Fan Motor

**Procedure**

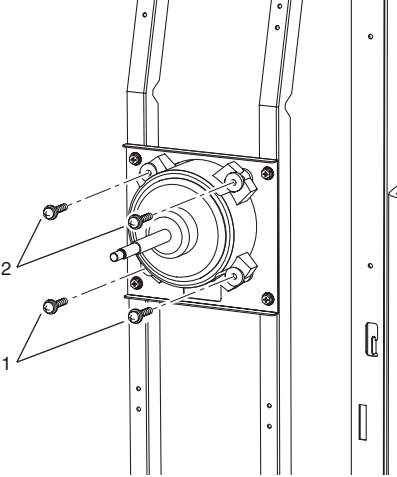
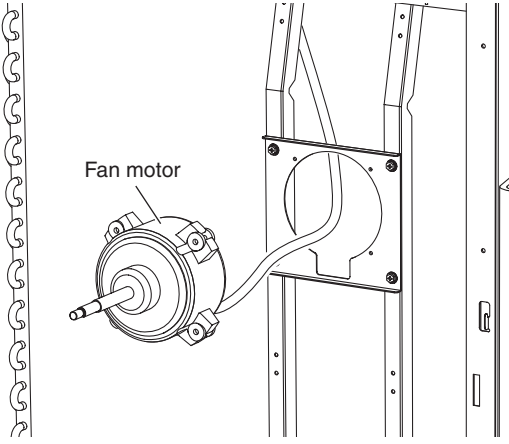
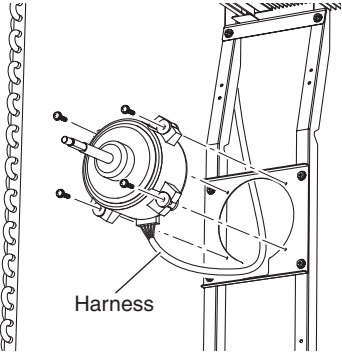

**Warning** Be sure to wait for 10 minutes or more after turning off all power supplies before disassembling work.

Step	Procedure	Procedure	Points
1	Remove the 2 lower screws.	 <p>(R6442)</p>	<ul style="list-style-type: none"> <li>Be sure to remove the lower screws first. If the upper screws are removed first, the fan motor, the center of gravity of which is toward the front, may tilt down or fall, getting you injured.</li> </ul>
2	Then, remove the 2 upper top screws.		
3	Remove the fan motor.	 <p>(R6443)</p>	<ul style="list-style-type: none"> <li>When reassembling, be sure to place the wire harness lower.</li> </ul>
		 <p>(R6444)</p>	

### 3.5 Removal of Coils / Thermistors

**Procedure**

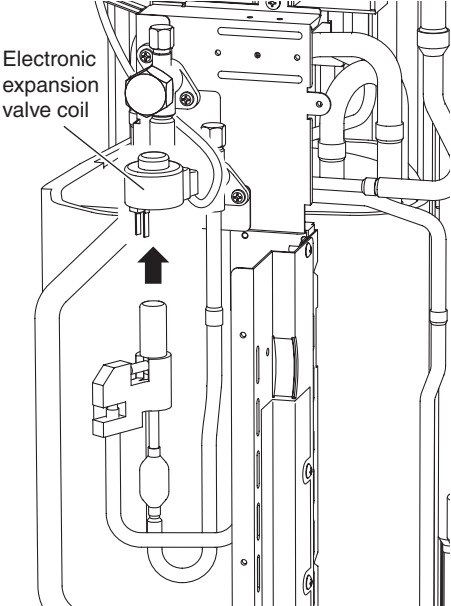
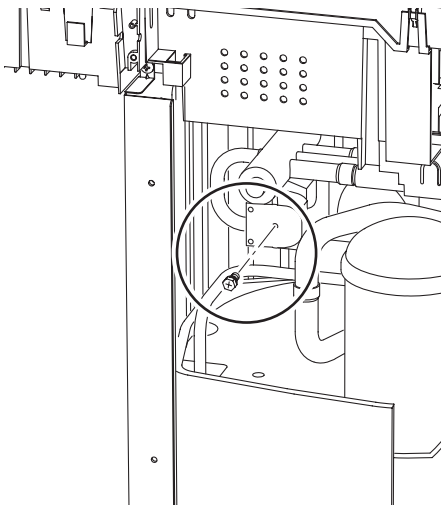
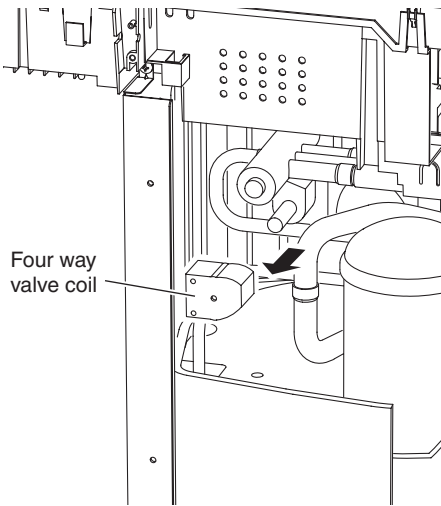

**Warning** Be sure to wait for 10 minutes or more after turning off all power supplies before disassembling work.

Step	Procedure	Points
<p>1. Remove the electronic expansion valve coil.</p> <p>1 Pull the electronic expansion valve coil out of position.</p>	 <p>Electronic expansion valve coil</p> <p>(R11159)</p>	
<p>2. Remove the four way valve coil.</p> <p>1 Remove the screw.</p> <p>2 Remove the four way valve coil.</p>	 <p>(R6457)</p>  <p>Four way valve coil</p> <p>(R6458)</p>	

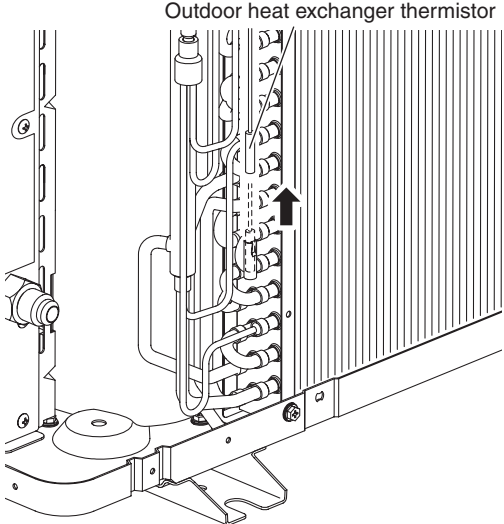
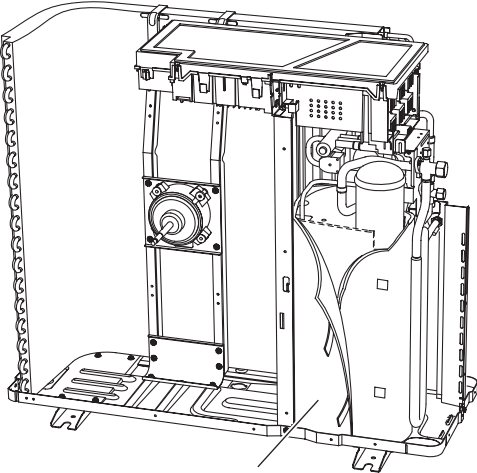
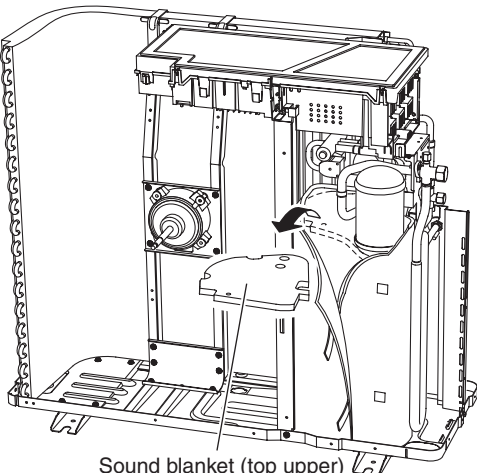
Step	Procedure	Points
<p>3. Remove the thermistors.</p>	<p>1 Pull out the outdoor heat exchanger thermistor.</p>  <p>Outdoor heat exchanger thermistor</p> <p>(R11160)</p> <p>2 Slightly open the sound blanket (outer).</p>  <p>Sound blanket (outer)</p> <p>(R7011)</p> <p>3 Remove the sound blanket (top upper).</p>  <p>Sound blanket (top upper)</p> <p>(R7012)</p>	

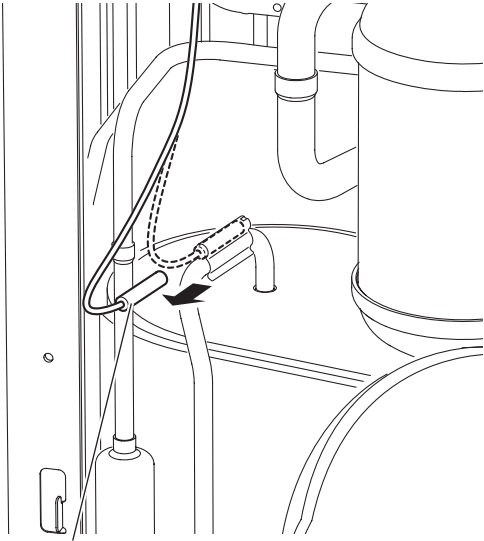
Step	Procedure	Points
4	<p data-bbox="199 219 459 280">Remove the discharge pipe thermistor.</p>  <p data-bbox="587 795 831 824">Discharge pipe thermistor</p> <p data-bbox="970 801 1029 824">(R9469)</p>	

### 3.6 Removal of Sound Blanket

**Procedure**



**Warning** Be sure to wait for 10 minutes or more after turning off all power supplies before disassembling work.

Step	Procedure	Procedure	Points
1	Open the sound blanket (outer).	<p>(R7013)</p>	
2	Remove the sound blanket (top upper).	<p>(R7014)</p>	<ul style="list-style-type: none"> <li>■ The sound blanket is fragile. Carefully pass the discharge pipe through it.</li> </ul>
3	Remove the screw from the partition plate (1) and open the plate slightly to the left for easy work.	<p>(R7015)</p>	

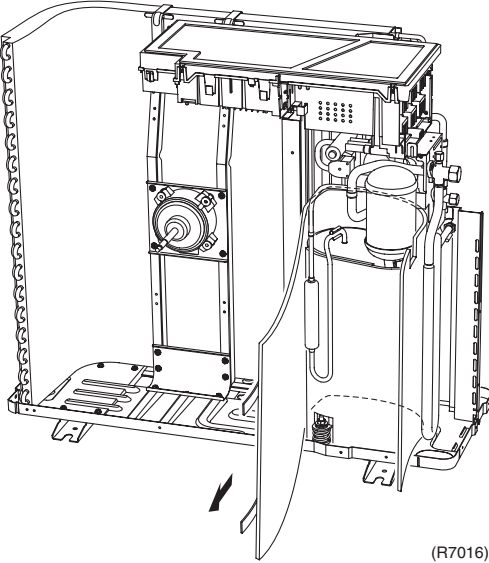
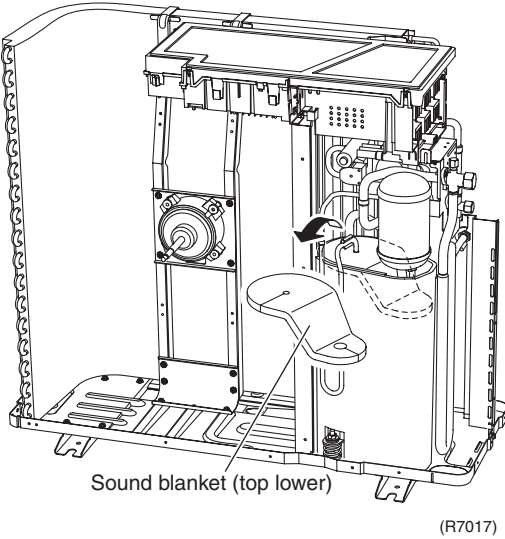
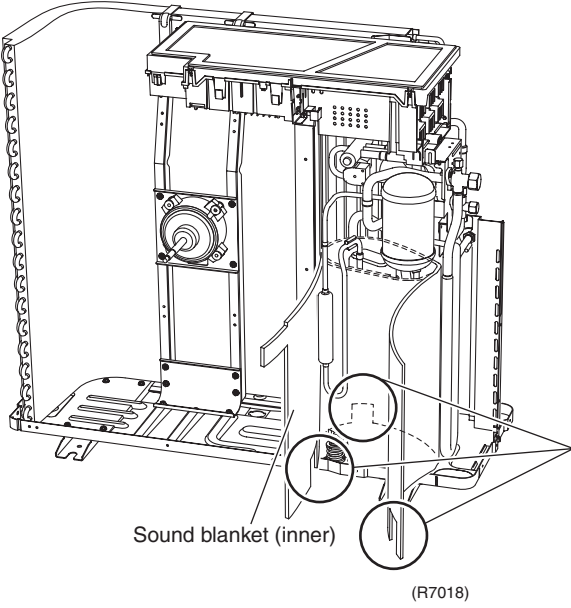

Step	Procedure	Points
4	Remove the sound blanket (outer).	
	 <p style="text-align: right;">(R7016)</p>	
5	Remove the sound blanket (top lower).	<ul style="list-style-type: none"> <li>■ The sound blanket is fragile. Carefully pass the discharge pipe through it.</li> </ul>
	 <p style="text-align: center;">Sound blanket (top lower)</p> <p style="text-align: right;">(R7017)</p>	
6	Open the sound blanket (inner).	<ul style="list-style-type: none"> <li>■ The sound blanket is fragile. Be careful of the notches of the compressor mount (3 locations).</li> </ul>
	 <p style="text-align: center;">Sound blanket (inner)</p> <p style="text-align: right;">(R7018)</p>	

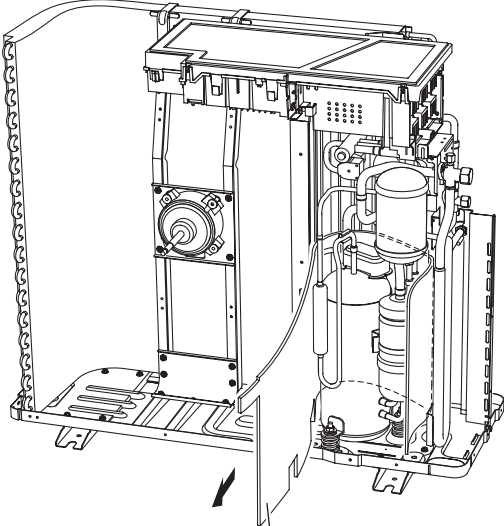
Step	Procedure	Points
<p>7</p>	<p>Remove the sound blanket (inner).</p>  <p>Sound blanket (inner) (R7019)</p>	

### 3.7 Removal of Compressor

**Procedure**

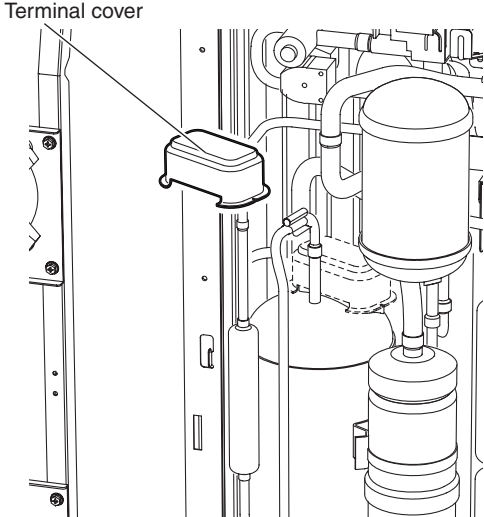
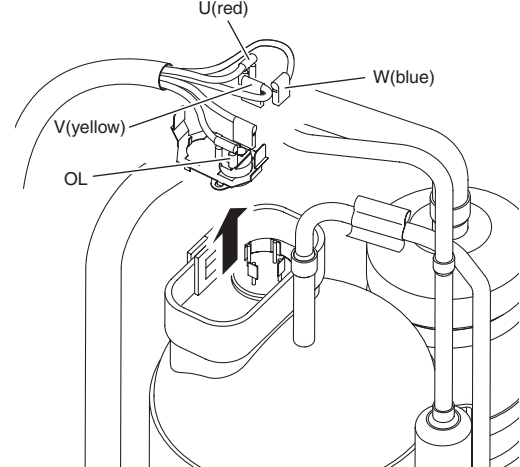
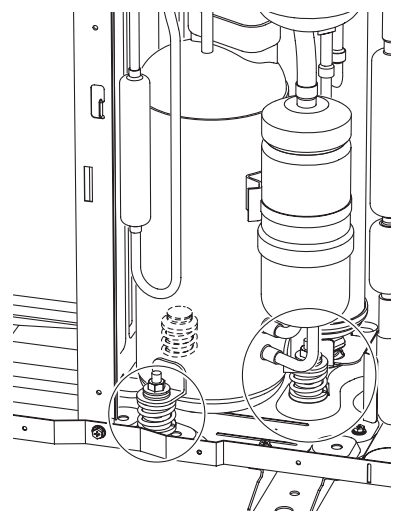

**Warning** Be sure to wait for 10 minutes or more after turning off all power supplies before disassembling work.

Step	Procedure	Procedure	Points
1	Remove the terminal cover.	 <p style="text-align: right;">(R9690)</p>	
2	Pull out the 3 leads wires.		<p>■ U: red, V: yellow, W: blue</p>
3	Remove the overload protector (OL).	 <p style="text-align: right;">(R9471)</p>	
4	Remove the 2 nuts.	 <p style="text-align: right;">(R9472)</p>	<p>■ Disconnect the piping, referring to page 142.</p>

---

# Part 8 Others

1. Others .....	175
1.1 Trial Operation.....	175
1.2 Field Settings.....	176
1.3 Application of Silicon Grease to a Power Transistor and a Diode Bridge.....	177

# 1. Others

## 1.1 Trial Operation

### Outline

1. Measure the supply voltage and make sure that it falls in the specified range.
2. Trial operation should be carried out in either cooling or heating mode.
3. Carry out the trial operation in accordance with the operation manual to ensure that all functions and parts, such as flap movement, are working properly.
  - The air conditioner requires a small amount of power in its standby mode. If the system is not to be used for some time after installation, shut off the circuit breaker to eliminate unnecessary power consumption.
  - If the circuit breaker trips to shut off the power to the air conditioner, the system backs up the operation mode. The system then restarts operation with the previous mode when the circuit breaker is restored.

In cooling mode, select the lowest programmable temperature; in heating mode, select the highest programmable temperature.

- Trial operation may be disabled in either mode depending on the room temperature.
- After trial operation is complete, set the temperature to a normal level.  
(26°C to 28°C in cooling mode, 20°C to 24°C in heating mode)
- For protection, the system does not start for 3 minutes after it is turned off.

### Detail

#### ARC433 Series

- (1) Press the ON/OFF button to turn on the system.
- (2) Press the center of the TEMP button and the MODE button at the same time.
- (3) Press the MODE button twice.  
(“?” appears on the display to indicate that trial operation is selected.)
- (4) Press the MODE button and select operation mode.
- (5) Trial operation terminates in approx. 30 minutes and switches into normal mode. To quit a trial operation, press the ON/OFF button.

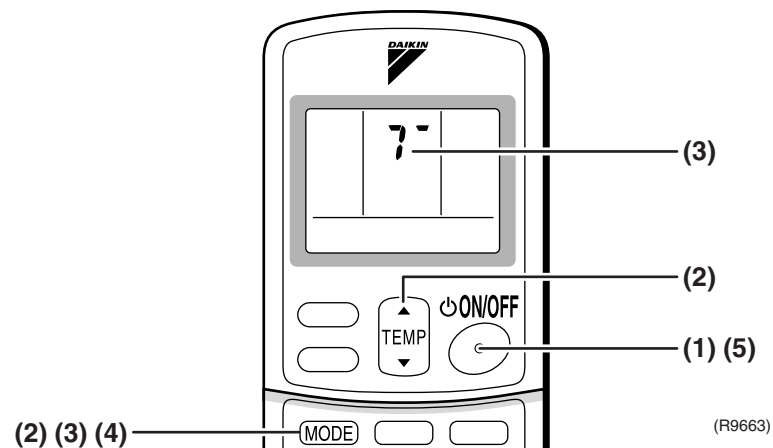

## 1.2 Field Settings

### 1.2.1 When 2 Units are Installed in 1 Room

How to set the different addresses.

- When 2 indoor units are installed in 1 room, 1 of the 2 pairs of indoor unit and wireless remote controller can be set for different addresses. Both the indoor unit PCB and the wireless remote controller need alteration.

#### Indoor Unit PCB

- Cut the address setting jumper JA on the PCB.

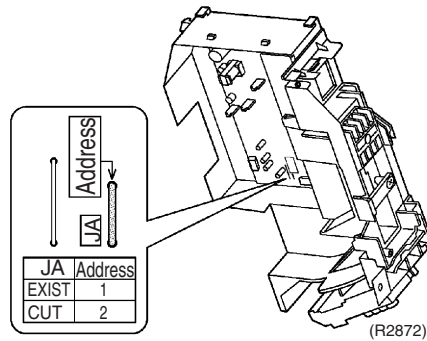

#### Wireless Remote Controller

- Cut the address setting jumper J4.

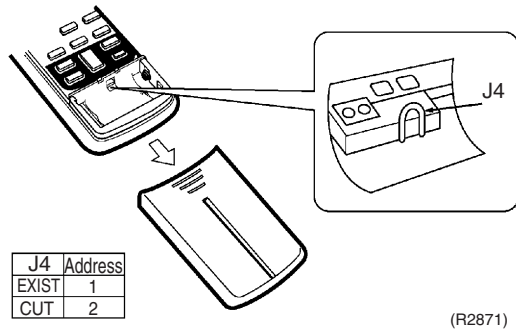

### 1.2.2 Jumper and Switch Settings

Jumper	Function	When connected (factory set)	When cut
JB (on indoor unit PCB)	Fan speed setting when compressor stops for thermostat OFF. (effective only at cooling operation)	Fan speed setting ; Remote controller setting	Fan speed setting; "0" (The fan stops.)
JC (on indoor unit PCB)	Power failure recovery function	Auto-restart	The unit does not resume operation after recovering from a power failure. Timer settings are cleared.



For the location of the jumper, refer to page 8.

Switch	Function	OFF (factory set)	ON
SW4-C (on outdoor unit PCB)	Improvement of defrost performance	Standard control	Reinforced control (ex. The frequency increases, the duration time of defrost lengthens.)



For the location of the switch, refer to page 11.

## 1.3 Application of Silicon Grease to a Power Transistor and a Diode Bridge

### Applicable Models

All outdoor units using inverter type compressor for room air conditioner.

When the printed circuit board (PCB) of an outdoor unit is replaced, it is required that silicon grease (\*1) is certainly applied to the heat radiation part (the contact point to the radiation fin) of the power transistor and diode bridge.

\*1: Parts number of the silicon grease – 1172698 (Drawing number 3FB03758-1)

### Details

The silicon grease is an essential article for encouraging the heat radiation of the power transistor and the diode bridge. Applying the paste should be implemented in accordance with the following instruction.

Remark: There is the possibility of failure with smoke in case of bad heat radiation.

- Wipe off the old silicon grease completely on a radiation fin.
- Apply the silicon grease evenly to the whole.
- Do not leave any foreign object such as solder or paper waste between the power transistor and the radiation fin, and also the diode bridge, and the radiation fin.
- Tighten the screws of the power transistor and the diode bridge, and contact to the radiation fin without any gap.

### <Example>

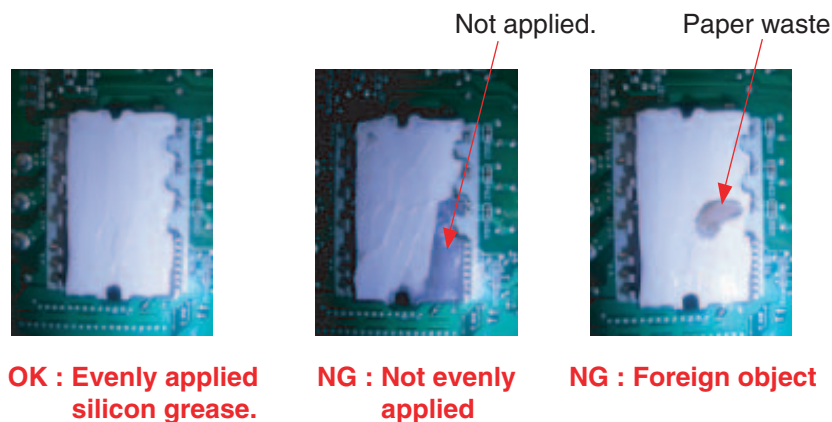
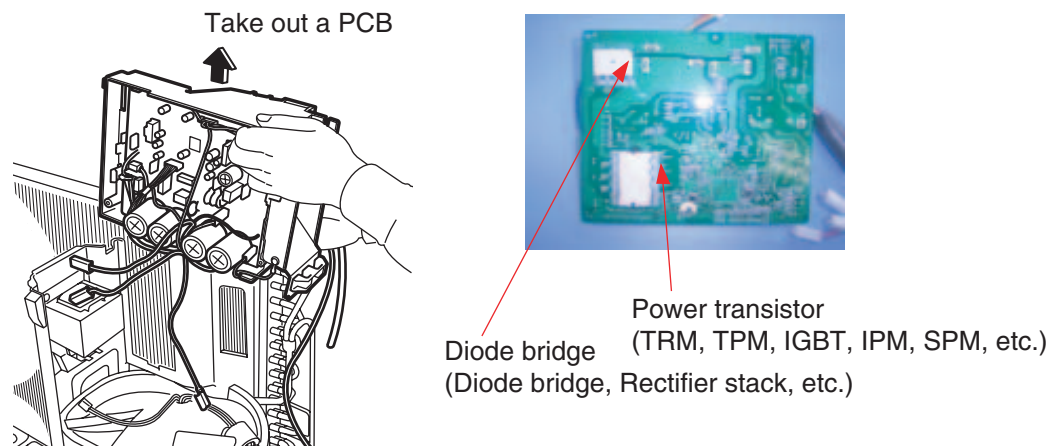

(R9056)

---

# Part 9

# Appendix

1. Piping Diagrams.....	179
1.1 Indoor Unit.....	179
1.2 Outdoor Unit.....	180
2. Wiring Diagrams.....	181
2.1 Indoor Unit.....	181
2.2 Outdoor Unit.....	181



# 1. Piping Diagrams

## 1.1 Indoor Unit

FTX50/60GV1B

FTX71GV1B

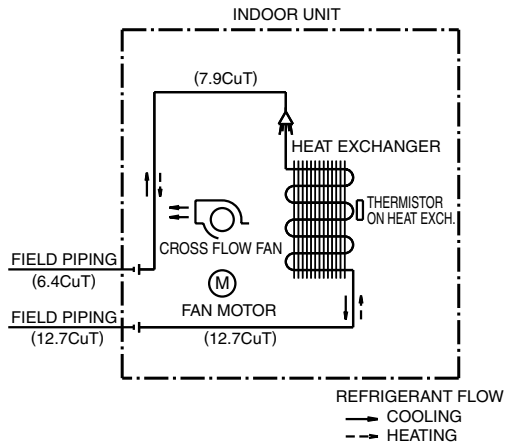

4D040081V

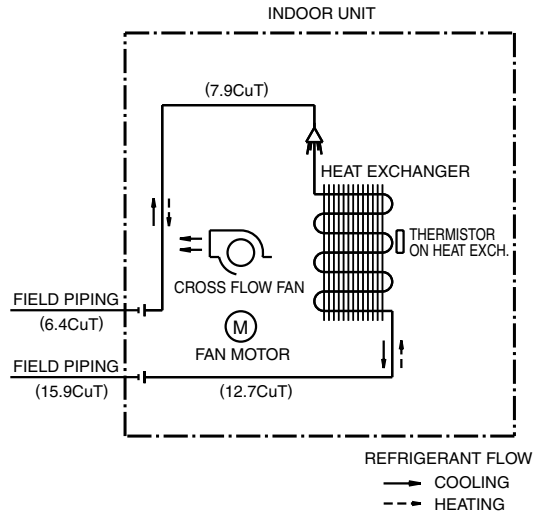

4D040082T

# 1.2 Outdoor Unit

## RX50/60G2V1B

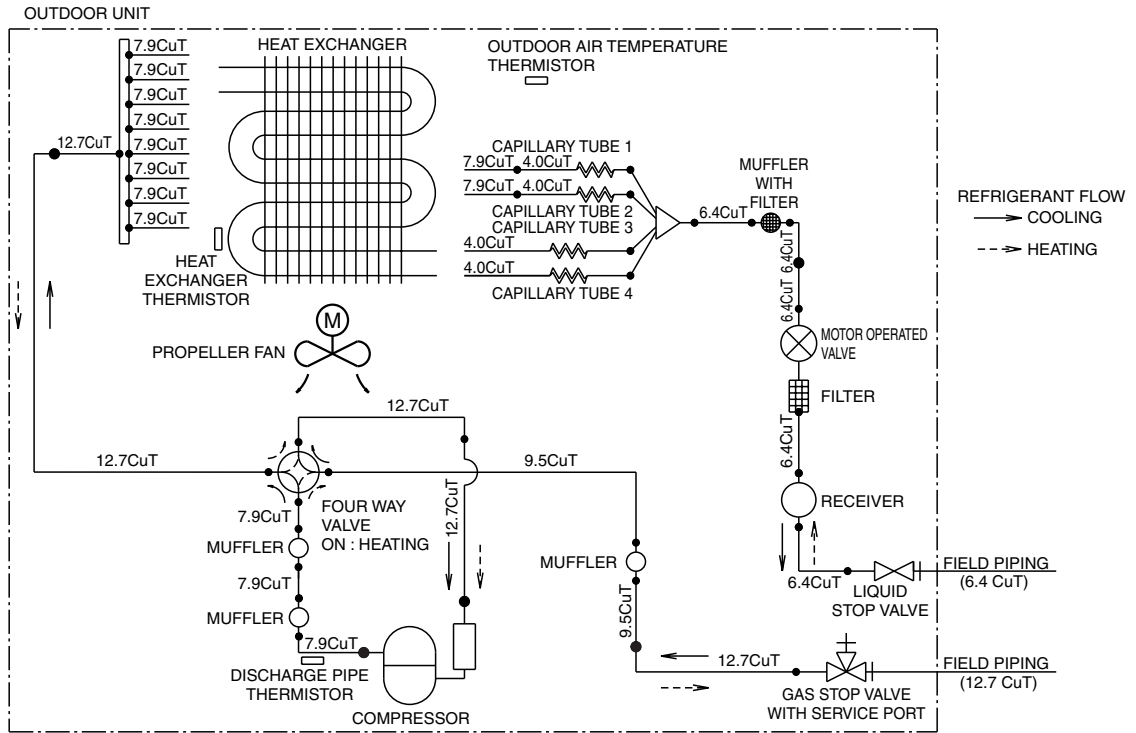

3D051637Q

## RX71GV1B

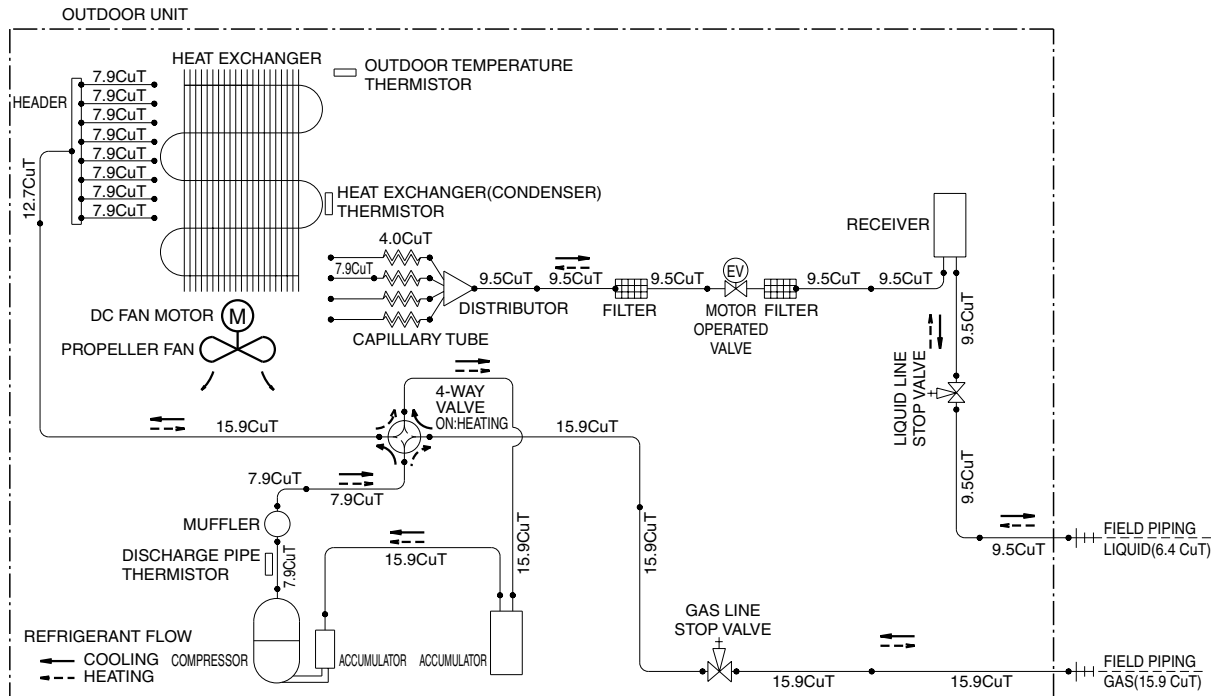

3D054593F

# 2. Wiring Diagrams

## 2.1 Indoor Unit

FTX50/60/71GV1B

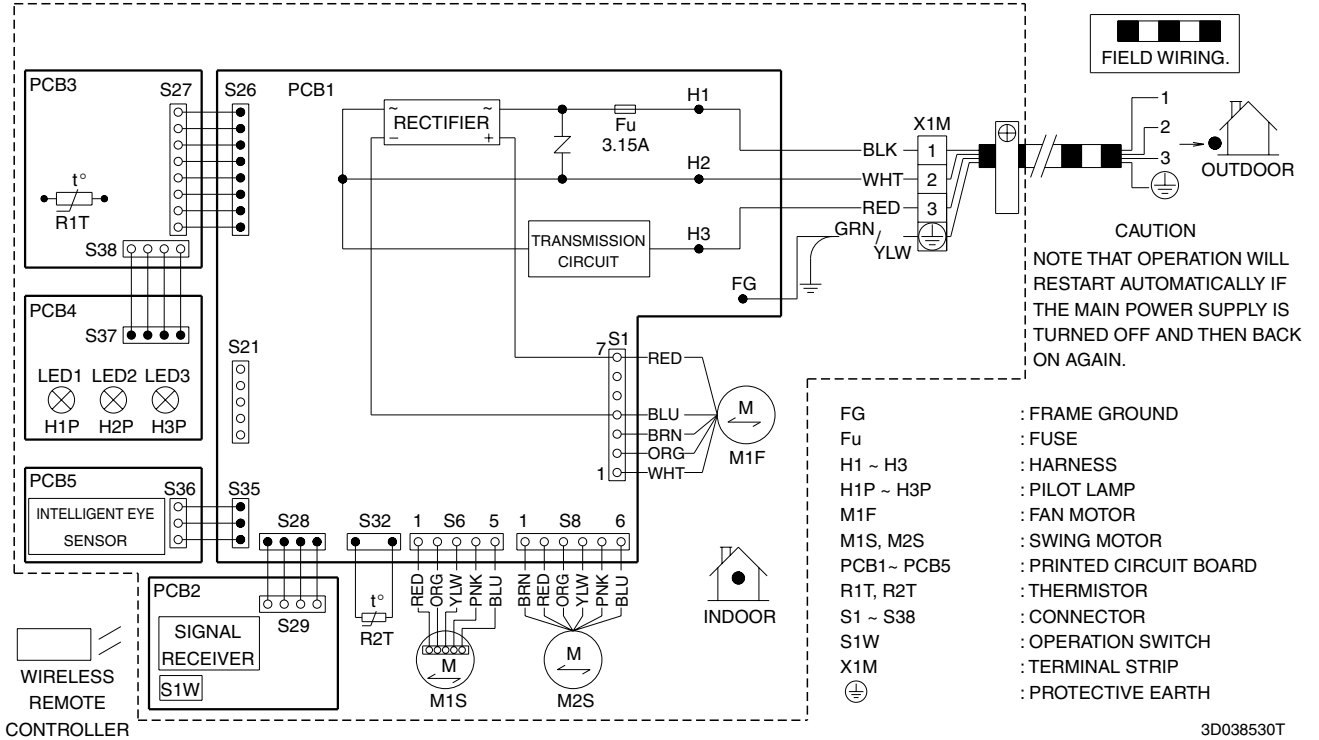

3D038530T

## 2.2 Outdoor Unit

RX50G2V1B

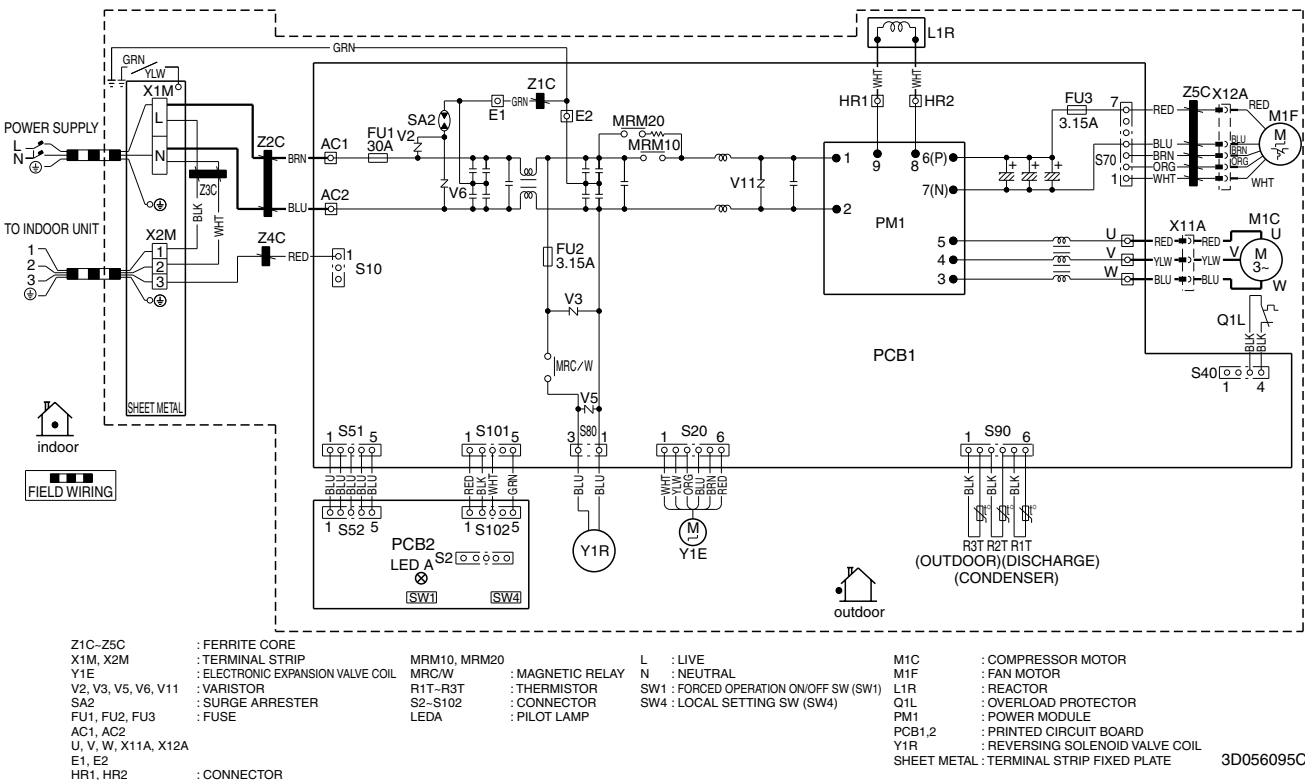

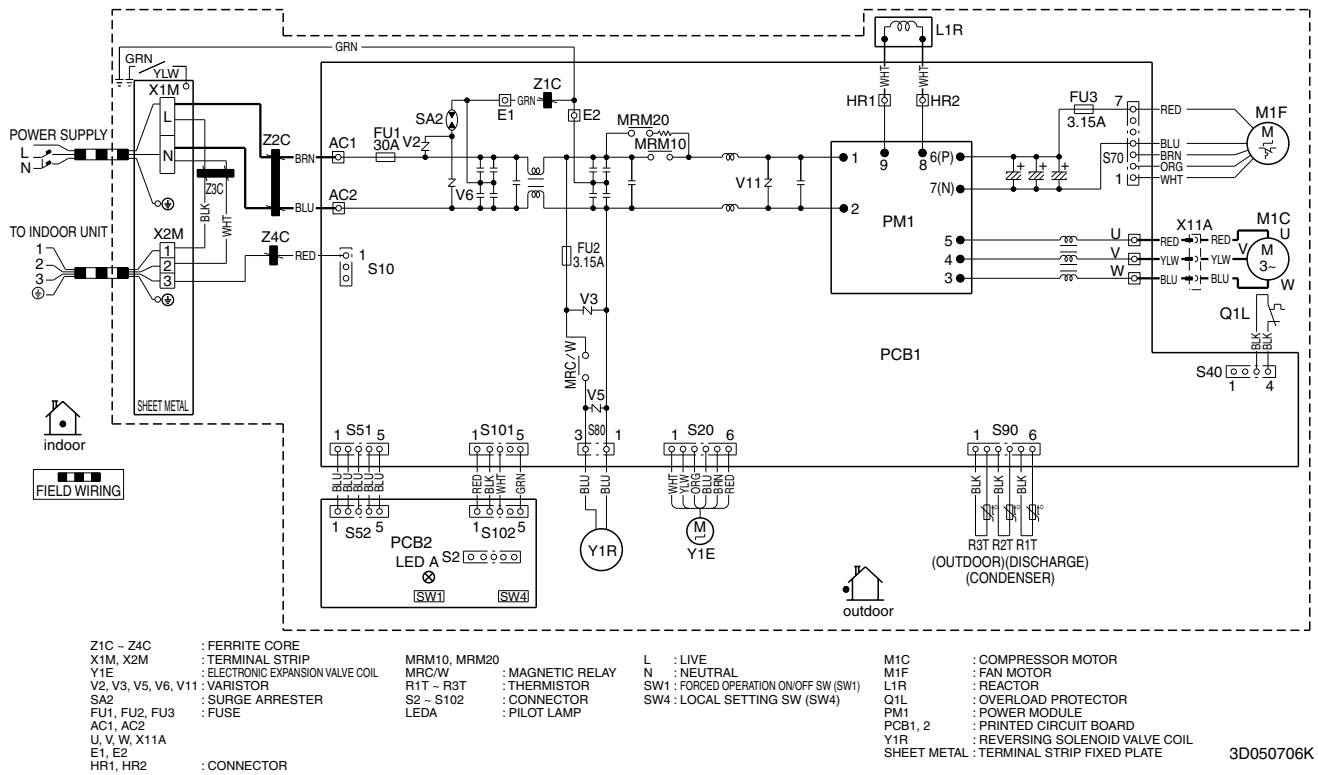

3D056095C

**RX60G2V1B**

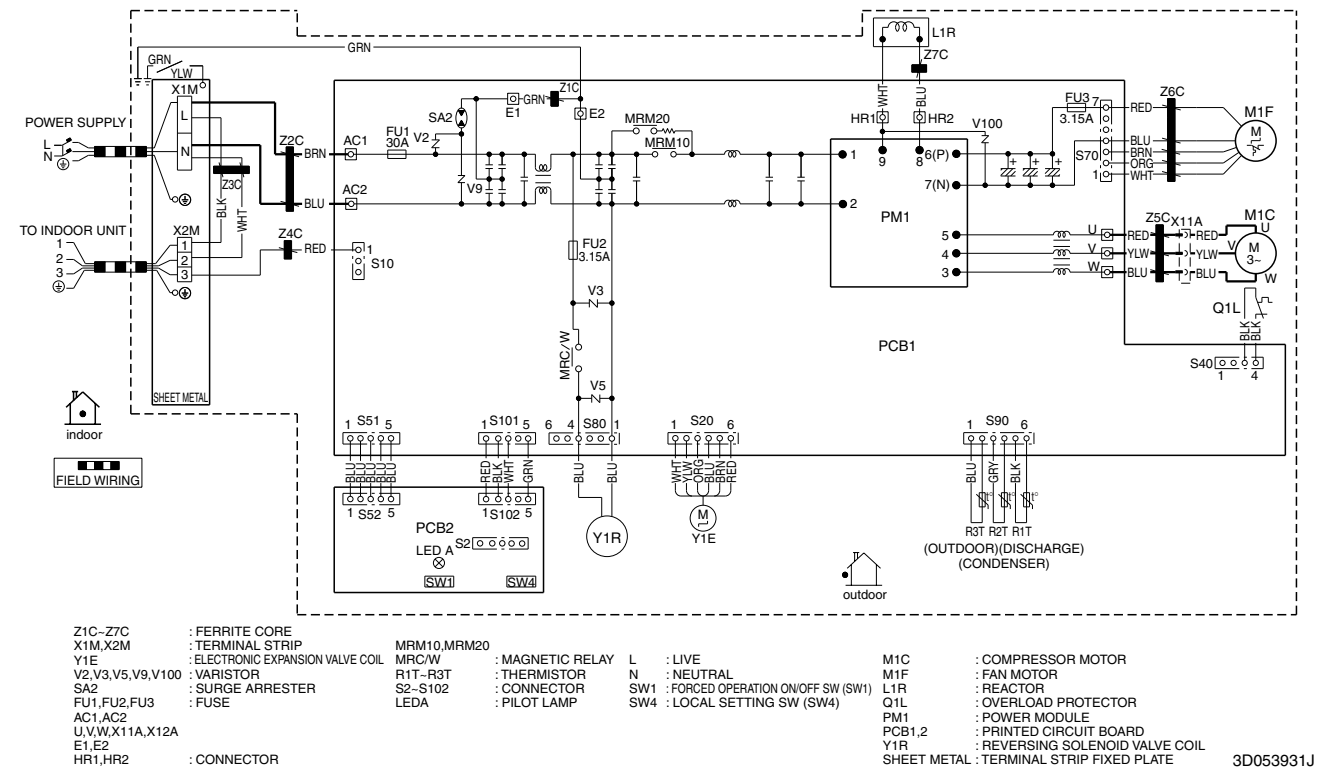

**RX71GV1B**



**Warning**  ● Daikin Industries, Ltd.'s products are manufactured for export to numerous countries throughout the world. Daikin Industries, Ltd. does not have control over which products are exported to and used in a particular country. Prior to purchase, please therefore confirm with your local authorised importer, distributor and/or retailer whether this product conforms to the applicable standards, and is suitable for use, in the region where the product will be used. This statement does not purport to exclude, restrict or modify the application of any local legislation.

- Ask a qualified installer or contractor to install this product. Do not try to install the product yourself. Improper installation can result in water or refrigerant leakage, electrical shock, fire or explosion.
- Use only those parts and accessories supplied or specified by Daikin. Ask a qualified installer or contractor to install those parts and accessories. Use of unauthorised parts and accessories or improper installation of parts and accessories can result in water or refrigerant leakage, electrical shock, fire or explosion.
- Read the User's Manual carefully before using this product. The User's Manual provides important safety instructions and warnings. Be sure to follow these instructions and warnings.

If you have any enquiries, please contact your local importer, distributor and/or retailer.

### Cautions on product corrosion

1. Air conditioners should not be installed in areas where corrosive gases, such as acid gas or alkaline gas, are produced.
2. If the outdoor unit is to be installed close to the sea shore, direct exposure to the sea breeze should be avoided. If you need to install the outdoor unit close to the sea shore, contact your local distributor.



JMI-0107

Organization:  
DAIKIN INDUSTRIES, LTD.  
AIR CONDITIONING MANUFACTURING DIVISION

Scope of Registration:  
THE DESIGN/DEVELOPMENT AND MANUFACTURE OF COMMERCIAL AIR CONDITIONING, HEATING, COOLING, REFRIGERATING EQUIPMENT, COMMERCIAL HEATING EQUIPMENT, RESIDENTIAL AIR CONDITIONING EQUIPMENT, HEAT RECLAIM VENTILATION, AIR CLEANING EQUIPMENT, MARINE TYPE CONTAINER REFRIGERATION UNITS, COMPRESSORS AND VALVES.



JQA-1452

Organization:  
DAIKIN INDUSTRIES  
(THAILAND) LTD.

Scope of Registration:  
THE DESIGN/DEVELOPMENT AND MANUFACTURE OF AIR CONDITIONERS AND THE COMPONENTS INCLUDING COMPRESSORS USED FOR THEM



EC99J2044

All of the Daikin Group's business facilities and subsidiaries in Japan are certified under the ISO 14001 international standard for environment management.

### Dealer

#### **DAIKIN INDUSTRIES, LTD.**

Head Office:  
Umeda Center Bldg., 2-4-12, Nakazaki-Nishi,  
Kita-ku, Osaka, 530-8323 Japan

Tokyo Office:  
JR Shinagawa East Bldg., 2-18-1, Konan,  
Minato-ku, Tokyo, 108-0075 Japan

[http://www.daikin.com/global\\_ac/](http://www.daikin.com/global_ac/)

©All rights reserved