

Service Manual

Air-to-Water Heatpump

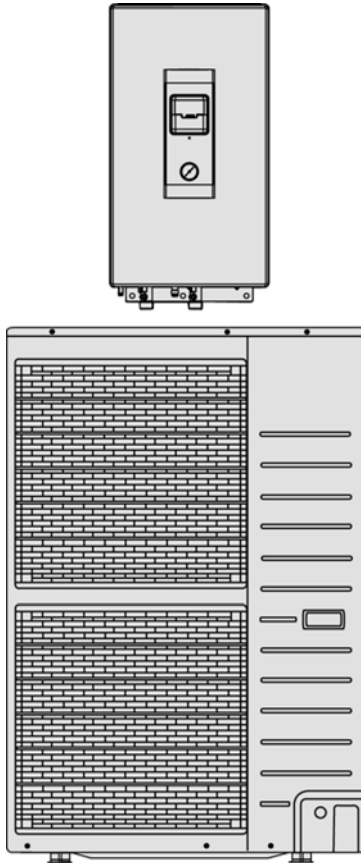

Indoor Unit	Outdoor Unit
WH-SDC09C3E8	WH-UD09CE8
WH-SDC12C9E8	WH-UD12CE8
WH-SDC14C9E8	WH-UD14CE8
WH-SDC16C9E8	WH-UD16CE8

WARNING

This service information is designed for experienced repair technicians only and is not designed for use by the general public. It does not contain warnings or cautions to advise non-technical individuals of potential dangers in attempting to service a product. Products powered by electricity should be serviced or repaired only by experienced professional technicians. Any attempt to service or repair the product or products dealt with in this service information by anyone else could result in serious injury or death.

PRECAUTION OF LOW TEMPERATURE



In order to avoid frostbite, be assured of no refrigerant leakage during the installation or repairing of refrigerant circuit.

TABLE OF CONTENTS

	PAGE		PAGE
1. Safety Precautions	3	12.16 Two Ways Valve Control.....	67
2. Specifications	5	13. Protection Control	68
2.1 WH-SDC09C3E8 WH-UD09CE8.....	5	13.1 Protection Control for All Operations	68
2.2 WH-SDC12C9E8 WH-UD12CE8.....	7	13.2 Protection Control for Heating Operation....	70
2.3 WH-SDC14C9E8 WH-UD14CE8.....	9	13.3 Protection Control for Cooling Operation....	70
2.4 WH-SDC16C9E8 WH-UD16CE8.....	11	14. Servicing Mode	71
3. Features	13	14.1 Test Run	71
4. Location of Controls and Components	14	14.2 Proper Pump Down Procedure.....	71
4.1 Indoor Unit	14	14.3 How to Adjust Water Flow Rate.....	71
4.2 Outdoor Unit.....	19	14.4 Expansion Vessel Pre Pressure Checking	71
5. Dimensions	20	15. Maintenance Guide	72
5.1 Indoor Unit	20	16. Troubleshooting Guide	74
5.2 Outdoor Unit.....	21	16.1 Refrigeration Cycle System	74
6. Refrigeration and Water Cycle Diagram	22	16.2 Relationship between the Condition of the Air-to-Water Heatpump Indoor and Outdoor Units and Pressure and Electric Current	75
7. Block Diagram	24	16.3 Breakdown Self Diagnosis Function	76
7.1 WH-UD09CE8.....	24	16.4 Error Codes Table.....	77
7.2 WH-UD12CE8 WH-UD14CE8 WH-UD16CE8.....	25	16.5 Self-diagnosis Method	79
8. Wiring Connection Diagram	26	17. Disassembly and Assembly Instructions ...	112
8.1 Indoor Unit	26	17.1 To Remove Front Plate.....	112
8.2 Outdoor Unit.....	28	17.2 To Remove Cabinet.....	112
9. Electronic Circuit Diagram	29	17.3 To Remove Pressure Gauge	113
9.1 Indoor Unit	29	17.4 To Remove Control Panel	113
9.2 Outdoor Unit.....	31	17.5 To Remove RCCB	114
10. Printed Circuit Board	32	17.6 To Remove Transformer and Electronic Controller Board.....	114
10.1 Indoor Unit	32	17.7 To Remove Pressure Relief Valve, Flow Switch, Water Pump and Bottle Complete.....	115
10.2 Outdoor Unit.....	34	18. Technical Data	117
11. Installation Instruction	36	18.1 Operation Characteristics	117
11.1 Select the Best Location	36	18.2 Heating Capacity Table.....	133
11.2 Indoor/Outdoor Unit Installation Diagram ...	36	18.3 Cooling Capacity Table.....	134
11.3 Indoor Unit	37	18.4 Hydraulic Pump Performance.....	134
11.4 Outdoor Unit.....	42	19. Exploded View and Replacement Parts List	135
12. Operation and Control	46	19.1 WH-SDC09C3E8 WH-SDC12C9E8 WH-SDC14C9E8 WH-SDC16C9E8	135
12.1 Basic Function	46	19.2 WH-UD09CE8 WH-UD12CE8 WH-UD14CE8 WH-UD16CE8	137
12.2 Water Pump	58		
12.3 Pump Down Operation	58		
12.4 Flow Switch.....	58		
12.5 Force Heater Mode Operation	59		
12.6 Indoor Unit Safety	59		
12.7 Auto Restart Control	59		
12.8 Indication Panel	60		
12.9 Indoor Back-Up Heater Control	60		
12.10 Tank Booster Heater Control	61		
12.11 Three Way Valve Control.....	61		
12.12 Sterillization Mode.....	61		
12.13 Quiet Operation.....	62		
12.14 Solar Operation (Optional).....	62		
12.15 External Room Thermostat Control (Optional)	66		

1. Safety Precautions



- Read the following “SAFETY PRECAUTIONS” carefully before perform any servicing.
- Electrical work must be installed or serviced by a licensed electrician. Be sure to use the correct rating and main circuit for the model installed.
- The caution items stated here must be followed because these important contents are related to safety. The meaning of each indication used is as below. Incorrect installation or servicing due to ignoring of the instruction will cause harm or damage, and the seriousness is classified by the following indications.

 WARNING	This indication shows the possibility of causing death or serious injury.
 CAUTION	This indication shows the possibility of causing injury or damage to properties.

- The items to be followed are classified by the symbols:

	This symbol denotes item that is PROHIBITED from doing.
---	---

- Carry out test run to confirm that no abnormality occurs after the servicing. Then, explain to user the operation, care and maintenance as stated in instructions. Please remind the customer to keep the operating instructions for future reference.

 WARNING	
1.	Do not modify the machine, part, material during repairing service.
2.	If wiring unit is supplied as repairing part, do not repair or connect the wire even only partial wire break. Exchange the whole wiring unit.
3.	Do not wrench the fasten terminal. Pull it out or insert it straightly.
4.	Engage dealer or specialist for installation and servicing. If installation of servicing done by the user is defective, it will cause water leakage, electrical shock or fire.
5.	Install according to this installation instructions strictly. If installation is defective, it will cause water leakage, electric shock or fire.
6.	Use the attached accessories parts and specified parts for installation and servicing. Otherwise, it will cause the set to fall, water leakage, refrigerant leakage, fire or electrical shock.
7.	Install at a strong and firm location which is able to withstand the set's weight. If the strength is not enough or installation is not properly done, the set will drop and cause injury.
8.	Do not install outdoor unit near handrail of veranda. When installing outdoor unit at veranda of high rise building, child may climb up to outdoor unit and cross over the handrail and causing accident. 
9.	For electrical work, follow the local national wiring standard, regulation and the installation instruction. An independent circuit and single outlet must be used. If electrical circuit capacity is not enough or defect found in electrical work, it will cause electrical shock or fire.
10.	This equipment must be properly earthed. Earth line must not be connected to gas pipe, water pipe, earth of lightning rod and telephone. Otherwise, it may cause electric shock in case equipment breakdown or insulation breakdown.
11.	Do not use joint cable for indoor/outdoor connection cable. Use specified indoor/outdoor connection cable, refer to Installation Instructions CONNECT THE CABLE TO THE INDOOR UNIT and connect tightly for indoor/outdoor connection. Clamp the cable so that no external force will be acted on the terminal. If connection or fixing is not perfect, it will cause heat up or fire at the connection.
12.	When install or relocate Air to Water Heatpump indoor/outdoor unit, do not let any substance other than the specified refrigerant, eg. air etc. mix into refrigerant cycle (piping). Mixing of air etc. will cause abnormal high pressure in refrigeration cycle and result in explosion, injury etc.
13.	This is a R410A model. When connecting the piping, do not use any existing (R22) pipes and flare nuts. Using such same may cause abnormally high pressure in the refrigeration cycle (piping), and possibly result in explosion and injury. Use only R410A refrigerant. Thickness of copper pipes used with R410A must be more than 0.8 mm. Never use copper pipes thinner than 0.8 mm. It is desirable that the amount of residual oil is less than 40 mg/10 m. 
14.	During installation, install the refrigerant piping properly before run the compressor. Operation of compressor without fixing refrigeration piping and valves at opened condition will cause suck-in of air, abnormal high pressure in refrigeration cycle and result in explosion, injury etc.
15.	During pump down operation, stop the compressor before remove the refrigeration piping. Removal of refrigeration piping while compressor is operating and valves are opened condition will cause suck-in of air, abnormal high pressure in refrigeration cycle and result in explosion, injury etc.
16.	After completion of the installation servicing confirm there is no leakage of refrigerant gas. It may generate toxic gas when the refrigerant contacts with fire.
17.	Ventilate the room if there is refrigerant gas leakage during operation. Extinguish all fire sources if present. It may cause toxic gas when the refrigerant contacts with fire.
18.	Only use the supplied or specified installation parts, else, it may cause unit vibrate loose, water/refrigerant leakage, electrical shock or fire.

 **WARNING**

19. The unit is only for use in a closed portable water system. Utilization in an open water circuit or non-portable water circuit, may lead to excessive corrosion of the water piping and risk of incubating bacteria colonies, particularly Legionella, in water.	
20. Do not insert your fingers or other objects into the unit, high speed rotating fan may cause injury.	⊘
21. Do not dismantle refrigerant piping using pipe wrench. It might deform the piping and cause the unit to malfunction.	⊘
22. Select a location where in case of water leakage, the leakage will not cause damage to other properties.	
23. Do not locally purchase electrical parts of the product for the purpose of installation, service, maintenance and etc. They might cause electrical shock or fire.	⊘
24. Do not branch the power from terminal block to heater tape. Overloaded terminal block will cause electrical shock or fire.	⊘
25. Installation or servicing work. It may need two people to carry out the installation or servicing work.	⊘
26. Do not use unspecified cord, modified cord, joint cord or extension cord for power supply cord. Do not share the single outlet with other electrical appliances. Poor contact, poor insulation or over current will cause electrical shock or fire.	
27. Tighten the flare nut with torque wrench according to specified method. If the flare nut is over-tightened, after a long period, the flare may break and cause refrigerant gas leakage.	

 **CAUTION**

1. Do not install the air-to-water heatpump indoor unit and outdoor unit at place where leakage of flammable gas may occur. In case gas leaks and accumulates at surrounding of the unit, it may cause fire.	⊘
2. Carry out drainage piping as mentioned in installation instructions. If drainage is not perfect, water may enter the room and damage the furniture.	
3. It may need two persons to carry out the installation work. The weight of indoor/outdoor unit might cause injury if carried by one person.	
4. Do not touch outdoor unit air inlet and aluminium fin. It may cause injury.	⊘
5. Select an installation location which is easy for maintenance.	
6. Pb free solder has a higher melting point than standard solder; typically the melting point is 50°F - 70°F (30°C - 40°C) higher. Please use a high temperature solder iron. In case of the soldering iron with temperature control, please set it to 700 ± 20°F (370 ± 10°C). Pb free solder will tend to splash when heated too high (about 1100°F/600°C).	
7. Power supply connection to indoor unit. <ul style="list-style-type: none"> • Power supply point should be in easily accessible place for power disconnection in case of emergency. • Must follow local national wiring standard, regulation and this installation instruction. • Strongly recommended to make permanent connection to a circuit breaker. <ul style="list-style-type: none"> - Power 1: Use approved 20A 4-poles circuit breaker with a minimum contact gap of 3.0mm. - Power 2: Use approved 15/16A 2-poles circuit breaker with a minimum contact gap of 3.0mm. - Power 3: Use approved 15/16A 4-poles circuit breaker with a minimum contact gap of 3.0mm. (Not applicable for WH-SDC09C3E8) 	
8. Do not release refrigerant during piping work for installation, servicing, re-installation and during repairing a refrigeration parts. Take care of the liquid refrigerant, it may cause frostbite.	⊘
9. Do not install this appliance in a laundry room or other high humidity location. This condition will cause rust and damage to the unit.	⊘
10. Make sure the insulation of power supply cord does not contact to hot part (i.e. refrigerant piping, water piping) to prevent from insulation failure (melt).	⊘
11. Do not sit, step or place anything on the unit, you may fall down accidentally.	⊘
12. Do not touch the sharp aluminum fins or edges of metal parts. If you are required to handle sharp parts during installation or servicing, please wear hand glove. Sharp parts may cause injury.	⊘
13. After installation, check the water leakage condition in connection area during test run. If leakage occur, it will cause damage to other properties.	
14. The unit described in this manual is designed for use in a closed water system only. Utilization in an open water circuit may lead to excessive corrosion of the water piping.	⊘

2. Specifications

2.1 WH-SDC09C3E8 WH-UD09CE8

Item		Unit	Outdoor Unit
Performance Test Condition			EUROVENT
Cooling Capacity		kW	7.00
		BTU/h	23900
		kcal/h	6020
EER		W/W	3.11
		kcal/hW	2.68
Heating Capacity		kW	9.00
		BTU/h	30700
		kcal/h	7740
COP		W/W	4.74
		kcal/hW	4.07
Noise Level		dB (A)	Cooling: 49 Heating: 49
		Power Level dB	Cooling: 67 Heating: 66
Air Flow		m ³ /min (ft ³ /min)	Cooling: 89.5 (3160) Heating: 76.8 (2710)
Refrigeration Control Device			Expansion Valve
Refrigeration Oil		cm ³	FV50S (1200)
Refrigerant (R410A)		kg (oz)	2.75 (97.1)
Dimension	Height	mm (inch)	1340 (52-3/4)
	Width	mm (inch)	900 (35-7/16)
	Depth	mm (inch)	320 (12-19/32)
Net Weight		kg (lbs)	109 (240)
Pipe Diameter	Liquid	mm (inch)	9.52 (3/8)
	Gas	mm (inch)	15.88 (5/8)
Standard Length		m (ft)	7 (23.0)
Pipe Length Range		m (ft)	3 (9.8) ~ 40 (131.2)
I/D & O/D Height Difference		m (ft)	30 (98.4)
Additional Gas Amount		g/m (oz/ft)	50 (0.5)
Refrigeration Charge Less		m (ft)	30 (98.4)
Compressor	Type		Hermetic Motor
	Motor Type		Brushless (4-poles)
	Rated Output	kW	4.30
Fan	Type		Propeller Fan
	Material		PP
	Motor Type		Induction (8-poles)
	Input Power	W	—
	Output Power	W	60
	Fan Speed	rpm	Cooling: 550 (Top Fan) 590 (Bottom Fan) Heating: 490 (Top Fan) 530 (Bottom Fan)
Heat Exchanger	Fin material		Aluminium (Pre Coat)
	Fin Type		Corrugated Fin
	Row × Stage × FPI		2 × 51 × 18
	Size (W × H × L)	mm	881.5 × 1295.4 × 44

Item	Unit	
Power Source (Phase, Voltage, Cycle)	ø	Three
	V	400
	Hz	50

Item		Unit	
Input Power		kW	Cooling: 2.25 Heating: 1.90
Starting Current		A	3.4
Running Current		A	Cooling: 3.4 Heating: 2.9
Max. Current / Max. Input Power Heatpump Unit (Heatpump Unit + Back-up Heater)		A / kW	7.5 (11.8) / 4.94 (7.94)
Back-up Heater: Max. Current / Max. Input Power		A / kW	Common ELCB to Heatpump
Tank Heater [1 Phase, 230V]: Max. Current / Max. Input Power		A / kW	13.0 / 3.00
Power Factor		%	Cooling: 96 Heating: 95
Power factor means total figure of compressor and outdoor fan motor.			
Power Cord	Number of core		-
	Length	m (ft)	-
Thermostat			Electronic Control
Protection Device			Electronic Control

Item		Unit	Indoor Unit
Performance Test Condition			EUROVENT
Operation Range	Outdoor Ambient	°C	Cooling: 16 ~ 43 Heating: -20 ~ 35
	Water Outlet	°C	Cooling: 5 ~ 20 Heating: 25 ~ 55
Internal Pressure Differential		kPa	Cooling: 7.0 Heating: 10.9
Noise Level		dB (A)	Cooling: 30 Heating: 30
		Power Level dB	Cooling: 43 Heating: 43
Dimension	Height	mm (inch)	892 (35-1/8)
	Width	mm (inch)	502 (19-3/4)
	Depth	mm (inch)	353 (13-29/32)
Net Weight		kg (lbs)	51 (113)
Refrigerant Pipe Diameter	Liquid	mm (inch)	9.52 (3/8)
	Gas	mm (inch)	15.88 (5/8)
Water Pipe Diameter	Inlet	mm (inch)	28 (1-3/32)
	Outlet	mm (inch)	28 (1-3/32)
Water Drain Hose Inner Diameter		mm (inch)	15.00 (19/32)
Pump	Motor Type		Capacitor Run Induction Motor (5 µF)
	No. of Speed		3
	Input Power	W	180
Hot Water Coil	Type		Brazed Plate
	No. of Plates		80
	Size (W x H x L)	mm	130 x 93 x 325
	Water Flow Rate	l/min (m ³ /h)	Cooling: 20.1 (1.2) Heating: 25.8 (1.5)
Pressure Relief Valve Water Circuit		kPa	Open: 190, Close: 183 and below
Flow Switch			Magnetic Lead Switch
Protection Device		A	Residual Current Circuit Breaker (1 Phase: 40 & 3 Phase: 25)
Expansion Vessel	Volume	l	10
	MWP	bar	1
Capacity of Integrated Electric Heater		kW	3.00

Note:

- Cooling capacities are based on outdoor air temperature of 35°C Dry Bulb with controlled indoor water inlet temperature of 12°C and water outlet temperature of 7°C.
- Heating capacities are based on outdoor air temperature of 7°C Dry Bulb (44.6°F Dry Bulb), 6°C Wet Bulb (42.8°F Wet Bulb) with controlled indoor water inlet temperature of 30°C and water outlet temperature of 35°C.
- Specification are subjected to change without prior notice for further improvement.

2.2 WH-SDC12C9E8 WH-UD12CE8

Item		Unit	Outdoor Unit
Performance Test Condition			EUROVENT
Cooling Capacity		kW	10.00
		BTU/h	34100
		kcal/h	8600
EER		W/W	2.82
		kcal/hW	2.42
Heating Capacity		kW	12.00
		BTU/h	41000
		kcal/h	10320
COP		W/W	4.67
		kcal/hW	4.02
Noise Level		dB (A)	Cooling: 50 Heating: 50
		Power Level dB	Cooling: 68 Heating: 67
Air Flow		m ³ /min (ft ³ /min)	Cooling: 93.3 (3290) Heating: 80.0 (2830)
Refrigeration Control Device			Expansion Valve
Refrigeration Oil		cm ³	FV50S (1200)
Refrigerant (R410A)		kg (oz)	2.75 (97.1)
Dimension	Height	mm (inch)	1340 (52-3/4)
	Width	mm (inch)	900 (35-7/16)
	Depth	mm (inch)	320 (12-19/32)
Net Weight		kg (lbs)	109 (240)
Pipe Diameter	Liquid	mm (inch)	9.52 (3/8)
	Gas	mm (inch)	15.88 (5/8)
Standard Length		m (ft)	7 (23.0)
Pipe Length Range		m (ft)	3 (9.8) ~ 40 (131.2)
I/D & O/D Height Difference		m (ft)	30 (98.4)
Additional Gas Amount		g/m (oz/ft)	50 (0.5)
Refrigeration Charge Less		m (ft)	30 (98.4)
Compressor	Type		Hermetic Motor
	Motor Type		Brushless (4-poles)
	Rated Output	kW	4.30
Fan	Type		Propeller Fan
	Material		PP
	Motor Type		Induction (8-poles)
	Input Power	W	—
	Output Power	W	60
	Fan Speed	rpm	Cooling: 600 (Top Fan) 640 (Bottom Fan) Heating: 510 (Top Fan) 550 (Bottom Fan)
Heat Exchanger	Fin material		Aluminium (Pre Coat)
	Fin Type		Corrugated Fin
	Row × Stage × FPI		2 × 51 × 18
	Size (W × H × L)	mm	881.5 × 1295.4 × 44

Item	Unit	
Power Source (Phase, Voltage, Cycle)	∅	Three
	V	400
	Hz	50
Input Power	kW	Cooling: 3.55 Heating: 2.57

Item	Unit	
Starting Current	A	5.3
Running Current	A	Cooling: 5.3 Heating: 3.9
Max. Current / Max. Input Power Heatpump Unit (Heatpump Unit + Back-up Heater)	A / kW	8.8 / 5.85 (Separate ELCB)
Back-up Heater: Max. Current / Max. Input Power	A / kW	13.0 / 9.00
Tank Heater [1 Phase, 230V]: Max. Current / Max. Input Power	A / kW	13.0 / 3.00
Power Factor	%	Cooling: 97 Heating: 96
Power factor means total figure of compressor and outdoor fan motor.		
Power Cord	Number of core	-
	Length	m (ft)
Thermostat		Electronic Control
Protection Device		Electronic Control

Item	Unit	Indoor Unit
Performance Test Condition		EUROVENT
Operation Range	Outdoor Ambient	°C
	Water Outlet	°C
Internal Pressure Differential	kPa	Cooling: 16 ~ 43 Heating: -20 ~ 35
Noise Level		Cooling: 5 ~ 20 Heating: 25 ~ 55
	Power Level dB	Cooling: 12.4 Heating: 17.4
Dimension	Height	mm (inch)
	Width	mm (inch)
	Depth	mm (inch)
Net Weight	kg (lbs)	892 (35-1/8)
Refrigerant Pipe Diameter	Liquid	mm (inch)
	Gas	mm (inch)
Water Pipe Diameter	Inlet	mm (inch)
	Outlet	mm (inch)
Water Drain Hose Inner Diameter	mm (inch)	52 (115)
Pump	Motor Type	Capacitor Run Induction Motor (5 μF)
	No. of Speed	3
	Input Power	W
Hot Water Coil	Type	Brazed Plate
	No. of Plates	80
	Size (H x W x L)	mm
	Water Flow Rate	l/min (m ³ /h)
Pressure Relief Valve Water Circuit	kPa	130 × 93 × 325
Flow Switch		Cooling: 28.7 (1.7) Heating: 34.4 (2.1)
Protection Device	A	Open: 190, Close: 183 and below
Expansion Vessel	Volume	l
	MWP	bar
Capacity of Integrated Electric Heater	kW	Magnetic Lead Switch
		Residual Current Circuit Breaker (1 Phase: 40 & 3 Phase: 25)
		10
		1
		9.00

Note:

- Cooling capacities are based on outdoor air temperature of 35°C Dry Bulb with controlled indoor water inlet temperature of 12°C and water outlet temperature of 7°C.
- Heating capacities are based on outdoor air temperature of 7°C Dry Bulb (44.6°F Dry Bulb), 6°C Wet Bulb (42.8°F Wet Bulb) with controlled indoor water inlet temperature of 30°C and water outlet temperature of 35°C.
- Specification are subjected to change without prior notice for further improvement.

2.3 WH-SDC14C9E8 WH-UD14CE8

Item		Unit	Outdoor Unit
Performance Test Condition			EUROVENT
Cooling Capacity		kW	11.50
		BTU/h	39200
		kcal/h	9890
EER		W/W	2.61
		kcal/hW	2.25
Heating Capacity		kW	14.00
		BTU/h	47800
		kcal/h	12040
COP		W/W	4.50
		kcal/hW	3.87
Noise Level		dB (A)	Cooling: 52 Heating: 51
		Power Level dB	Cooling: 70 Heating: 68
Air Flow		m ³ /min (ft ³ /min)	Cooling: 97.8 (3450) Heating: 84.0 (2970)
Refrigeration Control Device			Expansion Valve
Refrigeration Oil		cm ³	FV50S (1200)
Refrigerant (R410A)		kg (oz)	2.75 (97.1)
Dimension	Height	mm (inch)	1340 (52-3/4)
	Width	mm (inch)	900 (35-7/16)
	Depth	mm (inch)	320 (12-19/32)
Net Weight		kg (lbs)	109 (240)
Pipe Diameter	Liquid	mm (inch)	9.52 (3/8)
	Gas	mm (inch)	15.88 (5/8)
Standard Length		m (ft)	7 (23.0)
Pipe Length Range		m (ft)	3 (9.8) ~ 40 (131.2)
I/D & O/D Height Difference		m (ft)	30 (98.4)
Additional Gas Amount		g/m (oz/ft)	50 (0.5)
Refrigeration Charge Less		m (ft)	30 (98.4)
Compressor	Type		Hermetic Motor
	Motor Type		Brushless (4-poles)
	Rated Output	kW	4.30
Fan	Type		Propeller Fan
	Material		PP
	Motor Type		Induction (8-poles)
	Input Power	W	—
	Output Power	W	60
	Fan Speed	rpm	Cooling: 630 (Top Fan) 670 (Bottom Fan) Heating: 540 (Top Fan) 580 (Bottom Fan)
Heat Exchanger	Fin material		Aluminium (Pre Coat)
	Fin Type		Corrugated Fin
	Row × Stage × FPI		2 × 51 × 18
	Size (W × H × L)	mm	881.5 × 1295.4 × 44

Item	Unit	
Power Source (Phase, Voltage, Cycle)	ø	Three
	V	400
	Hz	50
Input Power	kW	Cooling: 4.40 Heating: 3.11

Item	Unit	
Starting Current	A	6.6
Running Current	A	Cooling: 6.6 Heating: 4.7
Max. Current / Max. Input Power Heatpump Unit (Heatpump Unit + Back-up Heater)	A / kW	9.4 / 6.25 (Separate ELCB)
Back-up Heater: Max. Current / Max. Input Power	A / kW	13.0 / 9.00
Tank Heater [1 Phase, 230V]: Max. Current / Max. Input Power	A / kW	13.0 / 3.00
Power Factor	%	Cooling: 97 Heating: 96
Power factor means total figure of compressor and outdoor fan motor.		
Power Cord	Number of core	-
	Length	m (ft)
Thermostat		Electronic Control
Protection Device		Electronic Control

Item	Unit	Indoor Unit
Performance Test Condition		EUROVENT
Operation Range	Outdoor Ambient	°C
	Water Outlet	°C
Internal Pressure Differential	kPa	Cooling: 16 ~ 43 Heating: -20 ~ 35
Noise Level		Cooling: 5 ~ 20 Heating: 25 ~ 55
		Cooling: 30 Heating: 30
Dimension	Height	mm (inch)
	Width	mm (inch)
Net Weight	kg (lbs)	892 (35-1/8)
Refrigerant Pipe Diameter	Liquid	mm (inch)
	Gas	mm (inch)
Water Pipe Diameter	Inlet	mm (inch)
	Outlet	mm (inch)
Water Drain Hose Inner Diameter	mm (inch)	502 (19-3/4)
Pump	Motor Type	Capacitor Run Induction Motor (5 μF)
	No. of Speed	3
	Input Power	W
Hot Water Coil	Type	Brazed Plate
	No. of Plates	80
	Size (H x W x L)	mm
	Water Flow Rate	l/min (m ³ /h)
Pressure Relief Valve Water Circuit	kPa	130 × 93 × 325 Cooling: 33.0 (2.0) Heating: 40.1 (2.4)
Flow Switch		Open: 190, Close: 183 and below
Protection Device	A	Magnetic Lead Switch
Expansion Vessel	Volume	l
	MWP	bar
Capacity of Integrated Electric Heater	kW	Residual Current Circuit Breaker (1 Phase: 40 & 3 Phase: 25) 10 1 9.00

Note:

- Cooling capacities are based on outdoor air temperature of 35°C Dry Bulb with controlled indoor water inlet temperature of 12°C and water outlet temperature of 7°C.
- Heating capacities are based on outdoor air temperature of 7°C Dry Bulb (44.6°F Dry Bulb), 6°C Wet Bulb (42.8°F Wet Bulb) with controlled indoor water inlet temperature of 30°C and water outlet temperature of 35°C.
- Specification are subjected to change without prior notice for further improvement.

2.4 WH-SDC16C9E8 WH-UD16CE8

Item		Unit	Outdoor Unit
Performance Test Condition			EUROVENT
Cooling Capacity		kW	12.20
		BTU/h	41600
		kcal/h	10490
EER		W/W	2.54
		kcal/hW	2.19
Heating Capacity		kW	16.00
		BTU/h	54600
		kcal/h	13760
COP		W/W	4.23
		kcal/hW	3.64
Noise Level		dB (A)	Cooling: 54 Heating: 53
		Power Level dB	Cooling: 72 Heating: 70
Air Flow		m ³ /min (ft ³ /min)	Cooling: 97.8 (3450) Heating: 90.0 (3180)
Refrigeration Control Device			Expansion Valve
Refrigeration Oil		cm ³	FV50S (1200)
Refrigerant (R410A)		kg (oz)	2.75 (97.1)
Dimension	Height	mm (inch)	1340 (52-3/4)
	Width	mm (inch)	900 (35-7/16)
	Depth	mm (inch)	320 (12-19/32)
Net Weight		kg (lbs)	109 (240)
Pipe Diameter	Liquid	mm (inch)	9.52 (3/8)
	Gas	mm (inch)	15.88 (5/8)
Standard Length		m (ft)	7 (23.0)
Pipe Length Range		m (ft)	3 (9.8) ~ 40 (131.2)
I/D & O/D Height Difference		m (ft)	30 (98.4)
Additional Gas Amount		g/m (oz/ft)	50 (0.5)
Refrigeration Charge Less		m (ft)	30 (98.4)
Compressor	Type		Hermetic Motor
	Motor Type		Brushless (4-poles)
	Rated Output	kW	4.30
Fan	Type		Propeller Fan
	Material		PP
	Motor Type		Induction (8-poles)
	Input Power	W	—
	Output Power	W	60
	Fan Speed	rpm	Cooling: 630 (Top Fan) 670 (Bottom Fan) Heating: 580 (Top Fan) 620 (Bottom Fan)
Heat Exchanger	Fin material		Aluminium (Pre Coat)
	Fin Type		Corrugated Fin
	Row × Stage × FPI		2 × 51 × 18
	Size (W × H × L)	mm	881.5 × 1295.4 × 44

Item	Unit	
Power Source (Phase, Voltage, Cycle)	ø	Three
	V	400
	Hz	50
Input Power	kW	Cooling: 4.80 Heating: 3.78

Item	Unit	
Starting Current	A	7.2
Running Current	A	Cooling: 7.2 Heating: 5.7
Max. Current / Max. Input Power Heatpump Unit (Heatpump Unit + Back-up Heater)	A / kW	9.9 / 6.59 (Separate ELCB)
Back-up Heater: Max. Current / Max. Input Power	A / kW	13.0 / 9.00
Tank Heater [1 Phase, 230V]: Max. Current / Max. Input Power	A / kW	13.0 / 3.00
Power Factor	%	Cooling: 97 Heating: 96
Power factor means total figure of compressor and outdoor fan motor.		
Power Cord	Number of core	-
	Length	m (ft)
Thermostat		Electronic Control
Protection Device		Electronic Control

Item	Unit	Indoor Unit
Performance Test Condition		EUROVENT
Operation Range	Outdoor Ambient	°C
	Water Outlet	°C
Internal Pressure Differential	kPa	Cooling: 16 ~ 43 Heating: -20 ~ 35
Noise Level		Cooling: 5 ~ 20 Heating: 25 ~ 55
		Cooling: 18.0 Heating: 30.2
Dimension	Height	mm (inch)
	Width	mm (inch)
Net Weight	kg (lbs)	892 (35-1/8)
Refrigerant Pipe Diameter	Liquid	mm (inch)
	Gas	mm (inch)
Water Pipe Diameter	Inlet	mm (inch)
	Outlet	mm (inch)
Water Drain Hose Inner Diameter	mm (inch)	502 (19-3/4)
Pump	Motor Type	Capacitor Run Induction Motor (5 μF)
	No. of Speed	3
	Input Power	W
Hot Water Coil	Type	Brazed Plate
	No. of Plates	80
	Size (H x W x L)	mm
	Water Flow Rate	l/min (m ³ /h)
Pressure Relief Valve Water Circuit	kPa	130 × 93 × 325
Flow Switch		Cooling: 35.0 (2.1) Heating: 45.9 (2.8)
Protection Device	A	Open: 190, Close: 183 and below
Expansion Vessel		Magnetic Lead Switch
Capacity of Integrated Electric Heater	Volume	l
	MWP	bar
	kW	Residual Current Circuit Breaker (1 Phase: 40 & 3 Phase: 25)
		10
		1
		9.00

Note:

- Cooling capacities are based on outdoor air temperature of 35°C Dry Bulb with controlled indoor water inlet temperature of 12°C and water outlet temperature of 7°C.
- Heating capacities are based on outdoor air temperature of 7°C Dry Bulb (44.6°F Dry Bulb), 6°C Wet Bulb (42.8°F Wet Bulb) with controlled indoor water inlet temperature of 30°C and water outlet temperature of 35°C.
- Specification are subjected to change without prior notice for further improvement.

3. Features

- **Inverter Technology**
 - Energy saving
- **High Efficiency**
- **Compact Design**
- **Environment Protection**
 - Non-ozone depletion substances refrigerant (R410A)
- **Long Installation Piping**
 - Long piping up to 40 meter with height difference 30 meter
 - Flexible 4-way piping for outdoor unit
- **Easy to use control panel**
- **Weekly Timer setting**
- **Quality Improvement**
 - Random auto restart after power failure for safety restart operation
 - Gas leakage protection
 - Prevent compressor reverse cycle
 - Inner protector to protect compressor
- **Serviceability Improvement**
 - Breakdown Self Diagnosis function
 - System Status Check Buttons for servicing purpose
 - System Pumpdown Button for servicing purpose
 - Front maintenance design for outdoor unit
- **Operation Condition**

		Indoor	Outdoor
		Water outlet temperature (°C)	Ambient temperature (°C)
COOLING	Maximum	20	43
	Minimum	5	16
HEATING	Maximum	55	35
	Minimum	25	-20

NOTICE : When the outdoor temperature is out of the above temperature range, the heating capacity will drop significantly and outdoor unit might stop for protection control.

4. Location of Controls and Components

4.1 Indoor Unit

4.1.1 Location of Control

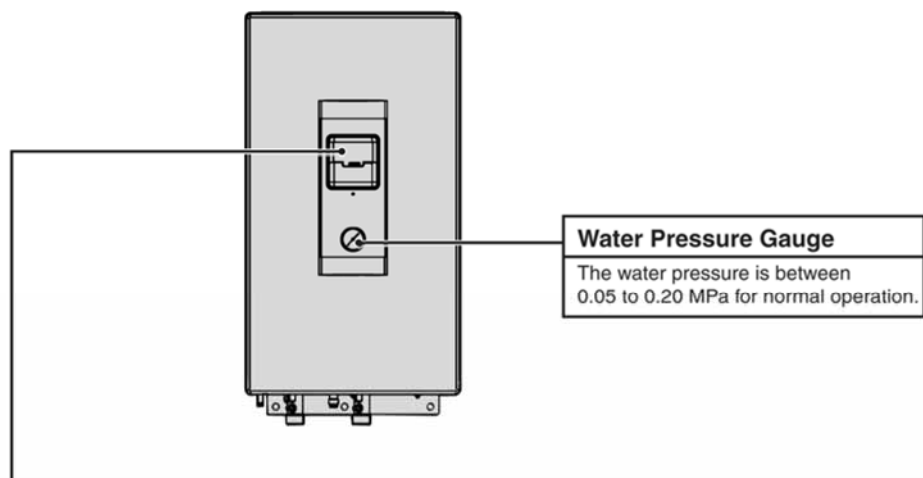

Control Panel

- ① **OFF/ON Button**
This button starts or stops the mode operation function of the unit.
- ② **Operation LED**
This LED indicates the unit is in operation.
- ③ **Heat Mode Indicator**
This icon indicates heating mode operation.
- ④ **Water Outlet Temperature Display**
This LCD show the water outlet temperature.
- ⑤ **Tank Mode Indicator**
This icon indicates tank mode operation.
- ⑥ **Outdoor Ambient Temperature Display**
This LCD show the outdoor ambient temperature.
- ⑦ **Timer/Clock Setting display**
This LCD show the weekly schedule timer setting and clock display.
- ⑧ **System Setting Indicator**
This icon indicates the system setting mode request OFF/ON display.
- ⑨ **System Status Indicator**
This icon indicates the status check mode request OFF/ON display.
- ⑩ **System Pumpdown Indicator**
This icon indicates the system pump down OFF/ON display.
- ⑪ **Quiet Mode Indicator**
This icon indicates quiet mode operation.
- ⑫ **HEATER/FORCE Indicator**
This icon indicates backup heater/force heater mode operation.
- ⑬ **HEATER/BOOSTER indicator**
This icon indicates backup heater/booster heater actual operation.
- ⑬ **Remote Display**
This LCD show the external thermo controller display.
- ⑭ **Solar Display**
This LCD show the solar display.
- ⑮ **Cool Mode Indicator**
This icon indicates cooling mode operation.

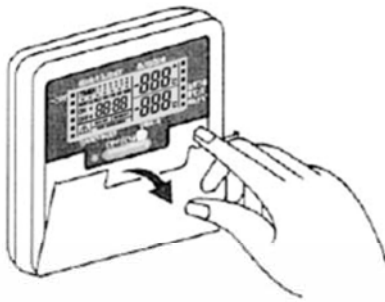

Open cover for buttons selections.

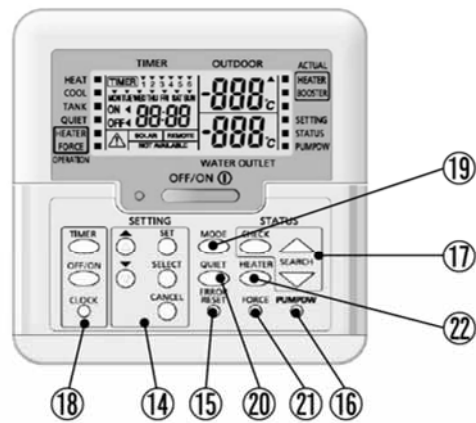

14 System Setting Button

These setting button can change the temperature range of setup setting mode selection.

Perform the steps below to set preferred temperature range.

STEP 1: Press SET button for 5 seconds to enter setting mode.

STEP 2: Press upward or downward button to choose the 8 of the parameter as below for change the temperature range.

- 1) Outdoor ambient set temperature for heat mode at low water outlet temperature (Selection range: $-15^{\circ}\text{C} \sim 15^{\circ}\text{C}$).
- 2) Outdoor ambient set temperature for heat mode at high water outlet temperature (Selection range: $-15^{\circ}\text{C} \sim 15^{\circ}\text{C}$).
- 3) Water outlet set temperature for heat mode at low outdoor ambient temperature (Selection range: $25^{\circ}\text{C} \sim 55^{\circ}\text{C}$).
- 4) Water outlet set temperature for heat mode at high outdoor ambient temperature (Selection range: $25^{\circ}\text{C} \sim 55^{\circ}\text{C}$).
- 5) Set temperature for turning OFF heating operation (Selection range: $5^{\circ}\text{C} \sim 35^{\circ}\text{C}$).
- 6) Outdoor ambient set temperature for turning ON heater operation (Selection range: $-15^{\circ}\text{C} \sim 20^{\circ}\text{C}$).
- 7) Water set temperature during cool mode ($5^{\circ}\text{C} \sim 20^{\circ}\text{C}$).
- 8) Sanitary tank set temperature (Selection range: $40^{\circ}\text{C} \sim 75^{\circ}\text{C}$).

STEP 3: Press SELECT button to enter selected parameter.

STEP 4: Press upward or downward button to set desired temperature.

STEP 5: Press SET button again to confirm the setting.

Note: Repeat steps 2 to 5 to set other parameters.

STEP 6: Press CANCEL button or wait 30 seconds to exit setting mode.

Water Temperature Thermo Shift Setting

Perform the steps below to set the desired shift temperature.

STEP 1: Press SET button within 5 seconds.

STEP 2: Press SELECT button to enter the setting temperature.

STEP 3: Press upward or downward button to set desired temperature (Selection range: $-5^{\circ}\text{C} \sim 5^{\circ}\text{C}$).

STEP 4: Press SET button again to confirm the setting.

STEP 5: Press CANCEL button or wait 30 seconds to exit setting.

15 Error Reset Button

This button is to reset the control panel and system error code.

16 System Pumpdown Button

This button is to select the pump down operation (Press 5 seconds)
Press OFF/ON button to stop the pump down operation.

17 System Status Check Button

This button is to check the various mode status.

Perform the steps below to check the selection status.

STEP 1: Press CHECK button for 5 seconds to enter status mode.

STEP 2: Press SEARCH Upward or Downward buttons for checking below value.

1.Compressor running frequency

2.Error history

3.Water inlet tempetarure

4.Tank Temperature

STEP 3: Press CANCEL button at setting mode or wait 30 seconds to exit status check.

18 Timer Button

This button is to set weekly timer and clock-time combine with setting button.

Perform the steps below to setting the current day and time.

STEP 1: Press CLOCK button.

STEP 2: Press SETTING Upward or Downward buttons to set current day.

STEP 3: Press SET button to confirm.

STEP 4: Repeat STEP 2 and 3 to set the current time.

Note: The current time that has been set will be the standard time for all the Timer Operations.

19 Mode Button

This button is to set operation mode.

The mode does the following transition by button operation.



20 Quiet Button

This button is to enjoy quiet environment by reduces outdoor unit noise.

21 Force Button

This button is to select force heater mode operation.

Press OFF/ON button to stop the force heater mode operation.

22 Heater Button

This button is to select backup heater mode operation.

4.1.2 Weekly Timer Setting

Timer Display

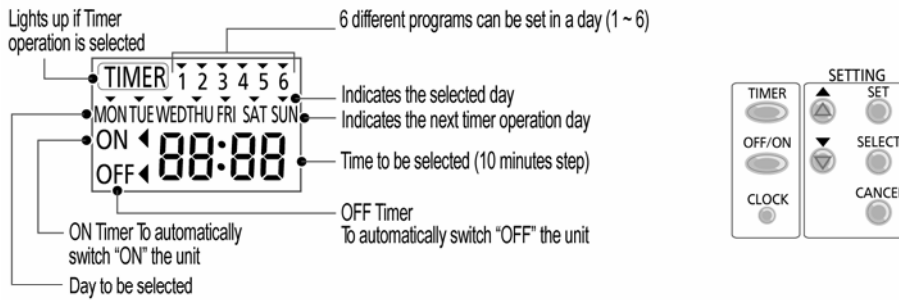

Function	Step
Enter timer mode	Press .
Set day & time	<ol style="list-style-type: none"> Press or to select your desired day. Press to confirm. "1" will be blinking, press to set program 1. Press to select ON or OFF timer. Press or to select your desired time. If you want to set the timer together with other operations, press and . Press to confirm program 1. The selected day will be highlighted with . • After 2 seconds, the display will move to the next program. Repeat steps 4 to 7 to set programs 2 to 6. • During timer setup, if no button is pressed within 30 seconds, or if the button is pressed the setting at that moment is confirmed and timer setup is ended.
Add/Modify timer	Repeat the steps above.
Disable timer	Press , then press .
Enable timer	Press , then press .
Check timer	<ol style="list-style-type: none"> Press . Press or until your desired day is shown, press to confirm your selection. Press or to check the set programs.
Cancel timer	<ol style="list-style-type: none"> Press . Press or until your desired day is shown. Press to enter program setting. Press or until your desired program is shown. Press to cancel the program.

Notes:

- You can set the Timer for each day of the week (Monday to Sunday) with 6 programs per day.
- When the unit is switched ON by the ON TIMER, it will use the previously set temperature to control the room temperature.
- Same timer program cannot be set in the same day.
- You may also select collective days with same timer setting.
- Promotes energy saving by allowing you to set up to 6 programs in any given day.

4.1.3 Setting Up the Special Functions

- After initial installation, you can manually adjust the settings. The initial setting remains active until the user changes it.
- The control panel can be used for multiple installations. Some functions may not be applicable to your unit.

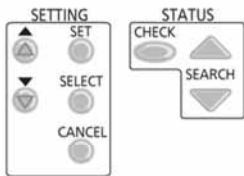
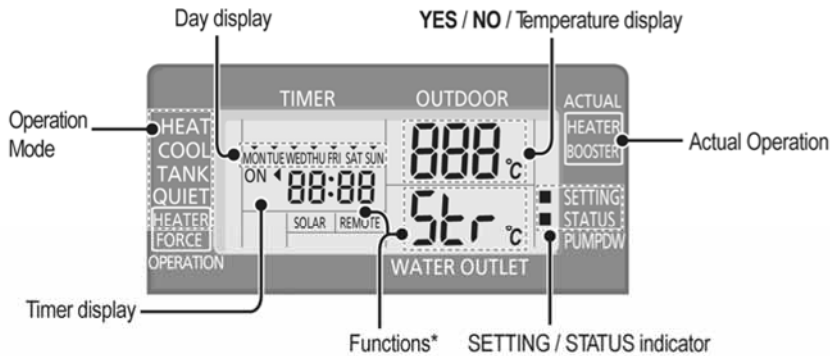

SELECT FUNCTIONS AND SET YOUR DESIRED TIMER

1. Press **SET** and **CHECK** simultaneously for 5 seconds to enter special setting mode. "SETTING" and "STATUS" indicator is ON.
(Make sure the OFF/ON control panel LED is OFF no operation)
2. Press **▲** or **▼** to browse functions.
3. Press **SELECT** to enter the function.
4. Press **▲** or **▼** to enable **YES** or disable **NO** function, or set your desired day and time.
5. Press **SET** to confirm.

Set	Function*	Operation Mode/ Actual Operation	Description
Set 1	con	ro on	External Thermo Controller (YES / NO) To set external thermo controller connection.
Set 2	con	TANK	Tank Connection (YES / NO) To set tank connection. Note: If select "Tank connection" is "NO", Set 3~11 are skipped.
Set 3	PrY	SOLAR	Solar Priority (YES / NO) To choose the solar use for water tank heat up.
Set 4	PrY	HEAT	Heating Priority (YES / NO) To choose the heat pump only use for Heating side during HEAT + TANK mode. Note: If select "Heating priority" is "YES", Set 5~7 are skipped.
Set 5	int	HEAT	Heating Heat-up Interval Set To set timer for Heating during HEAT + TANK mode (0.5hour ~ 10hours).
Set 6	int	TANK	Tank Heat-up Interval Set To set timer for Tank during HEAT + TANK mode (5minutes ~ 1hour 35minutes).
Set 7	dLY	BOOSTER	Booster Heater Delay Time Set To set delay timer for booster heater to ON if tank temperature is not reached (20minutes ~ 1hour 35minutes).
Set 8	Fun	StrL	Sterilization (YES / NO) To set sterilization, if required. Note: If select "Sterilization" is "NO", Set 9~11 are skipped.
Set 9	Str		Sterilization Day & Time Set To set timer for sterilization (only once a week).
Set 10	bo i	StrL	Sterilization Temperature Set To set temperature for sterilization function (40°C ~ 75°C).
Set 11	oPr	Str	Sterilization Continue Time To set timer to maintain heating temperature in order to complete the sterilization function (5minutes ~ 1hour).

4.1.4 Main Components

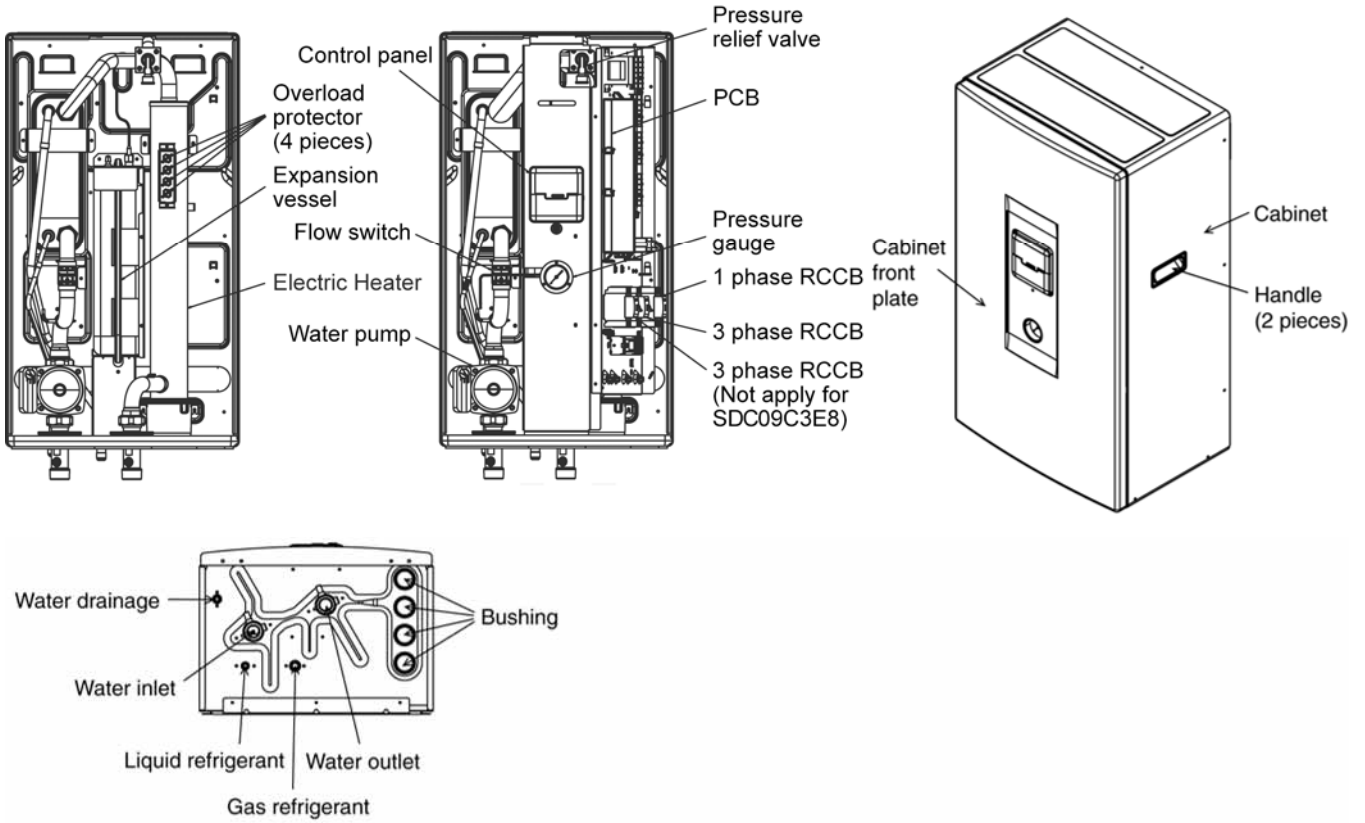

- Water pump:** The pump circulates the water in the water circuit.
- Pressure gauge:** The manometer allows read out of the water pressure in the water circuit.
- Flow switch:** The flow switch checks the flow in the water circuit and protects the heat exchanger against high pressure built-up and the pump against damage.
- Pressure relief valve:** The pressure relief valve prevents excessive water pressure in the water circuit (> 190kPa).
- Control panel:** The user interface allows the installer and user to setup, use and maintain the unit.
- Electric Heater:** Additional heating capacity to the system when water and ambient temp is low.
- Expansion Vessel:** Storage for excessive water.

4.2 Outdoor Unit

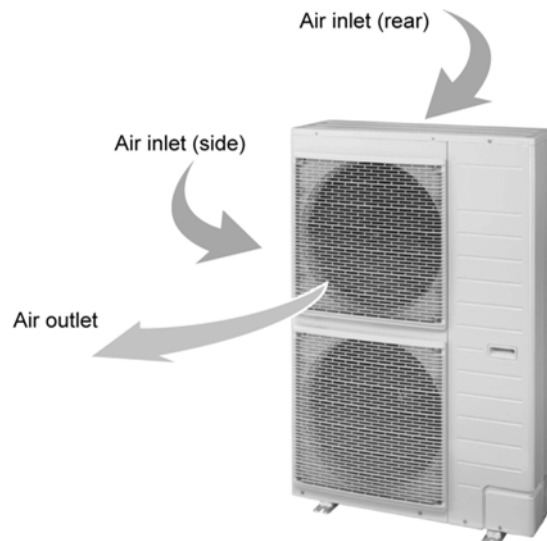

5. Dimensions

5.1 Indoor Unit

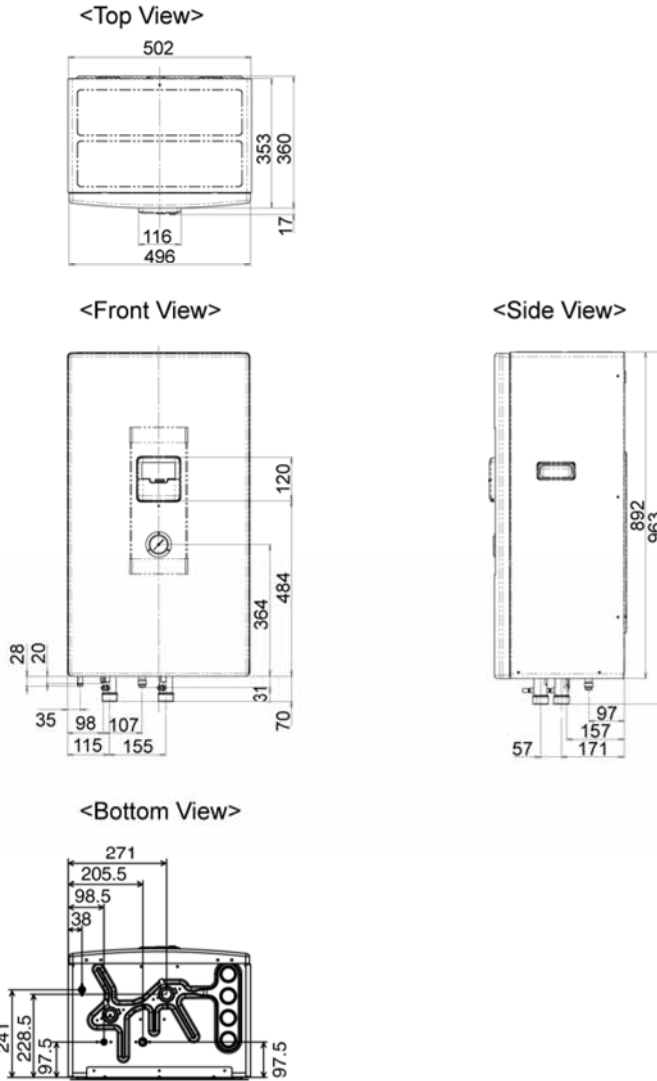

Relative position between the indoor unit and the installation plate <Front View>

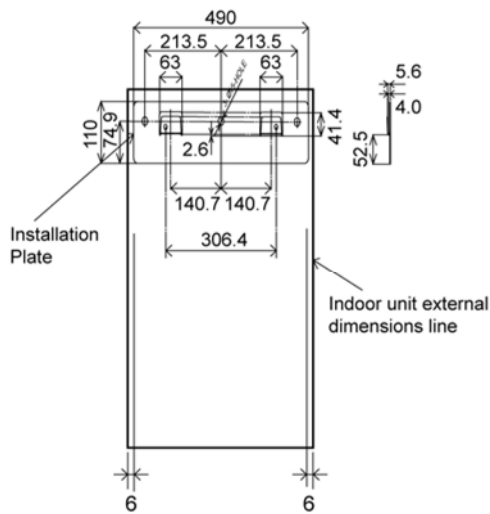

Unit: mm

5.2 Outdoor Unit

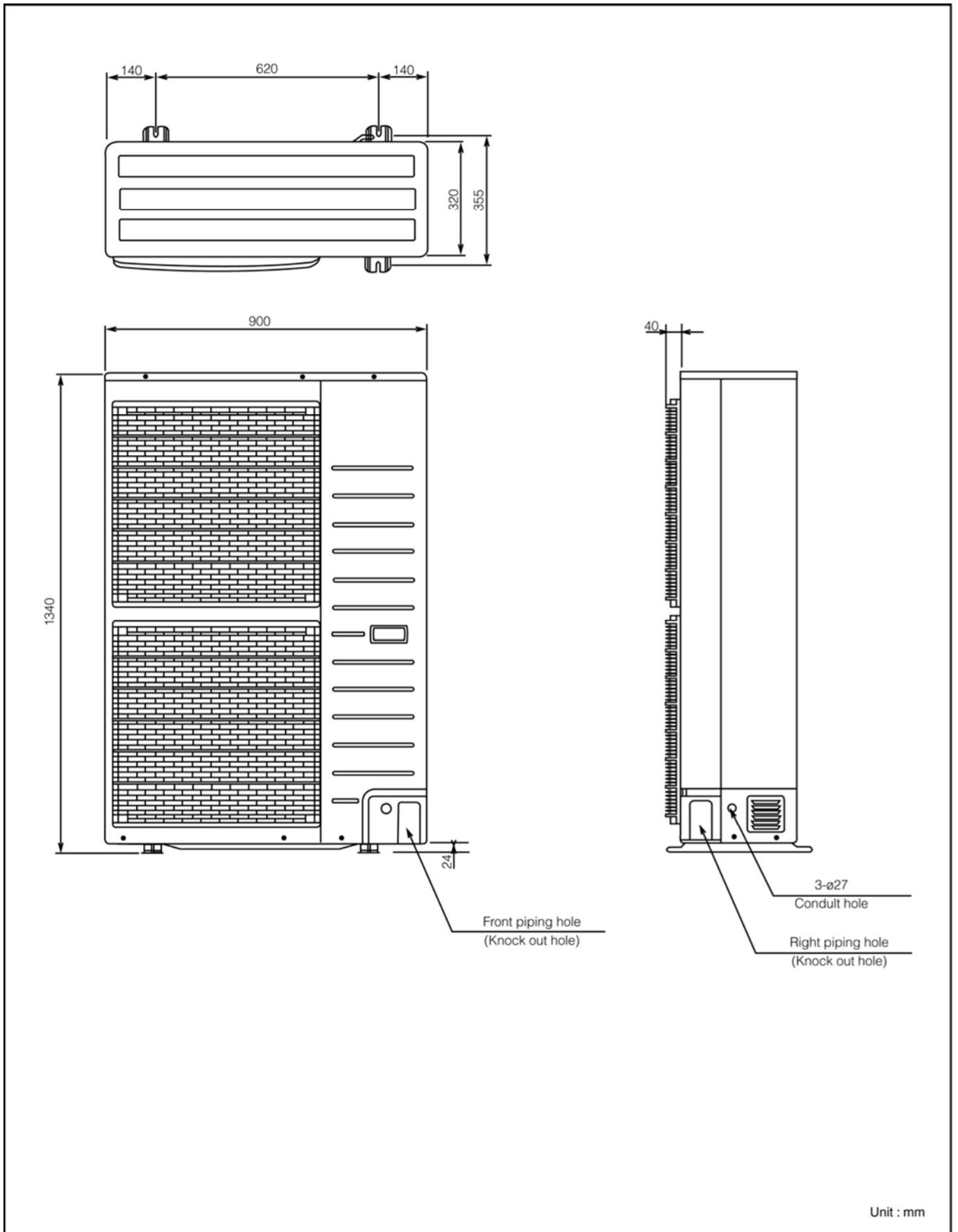

6. Refrigeration and Water Cycle Diagram

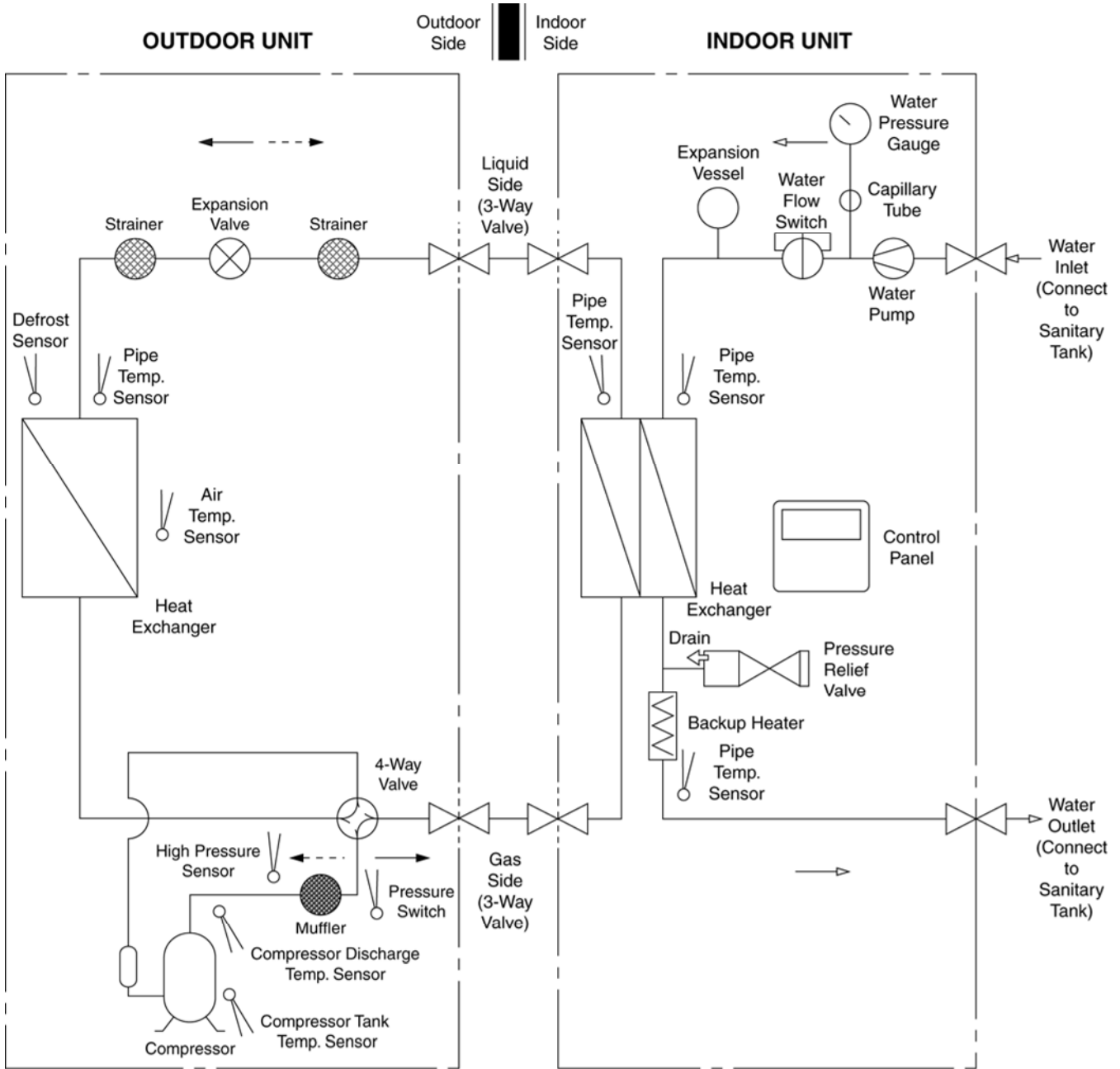

- ▶ Refrigerant Cycle (Heating)
- ▶ Water Cycle
- - -▶ Refrigerant Cycle (Cooling)

Model	Piping size		Rated Length (m)	Common Length (m)	Max Elevation (m)	Min. Piping Length (m)	Max. Piping Length (m)	Additional Refrigerant (g/m)
	Gas	Liquid						
UD09CE8	5/8"	3/8"	7	30	30	3	40	50
UD12CE8	5/8"	3/8"	7	30	30	3	40	50
UD14CE8	5/8"	3/8"	7	30	30	3	40	50
UD16CE8	5/8"	3/8"	7	30	30	3	40	50

* If piping length is over common length, additional refrigerant should be added as shown in the table.

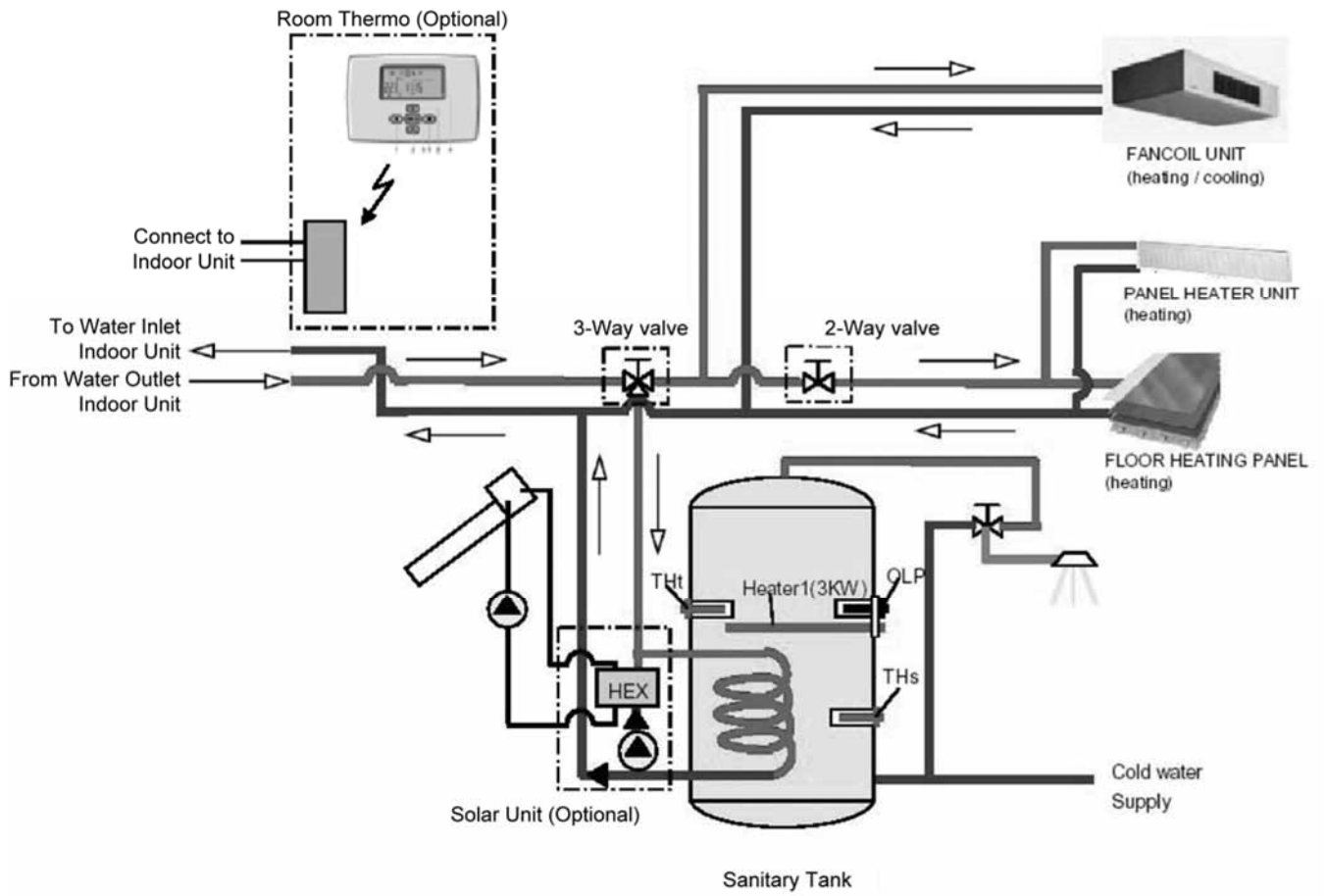

7. Block Diagram

7.1 WH-UD09CE8

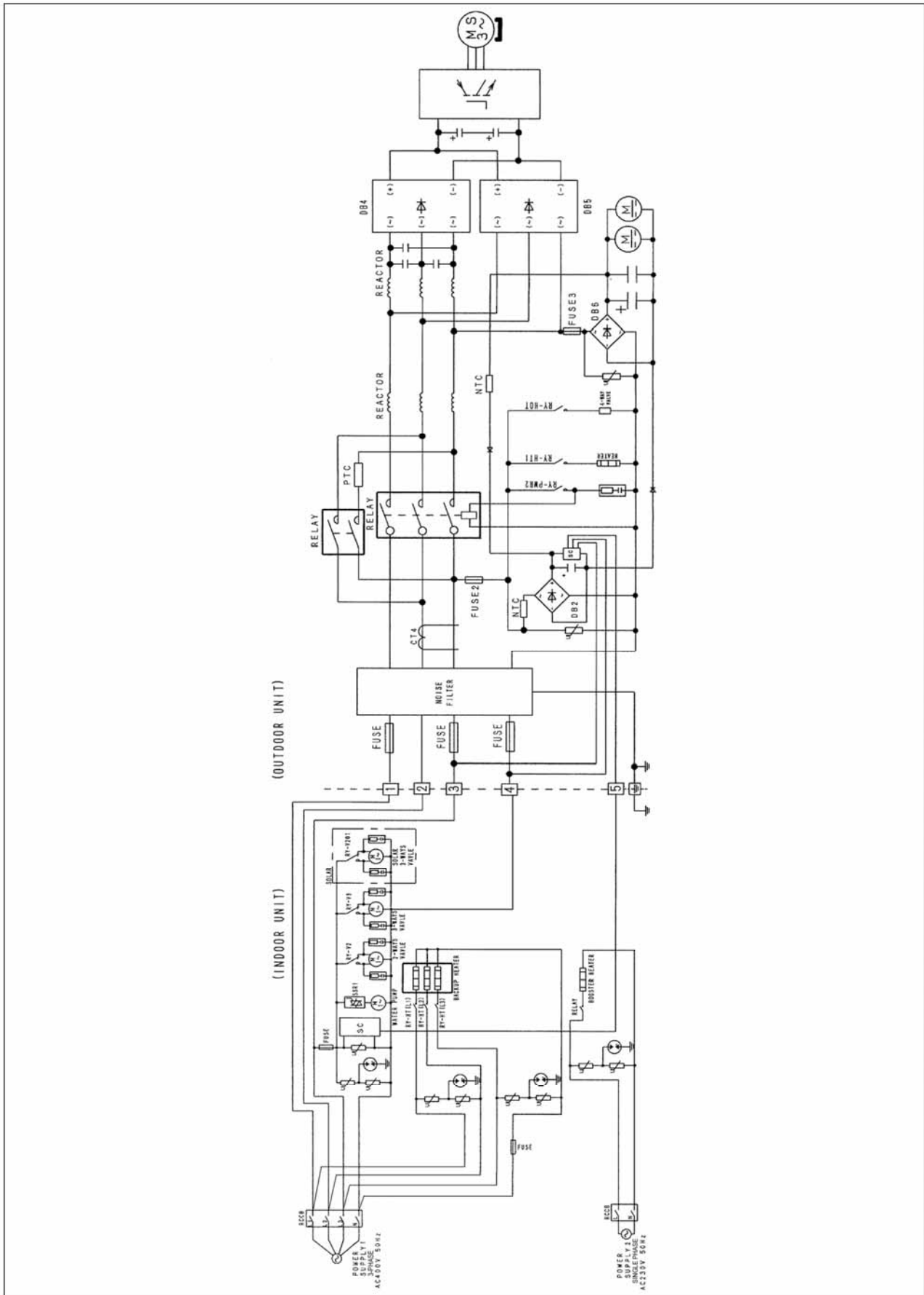

7.2 WH-UD12CE8 WH-UD14CE8 WH-UD16CE8

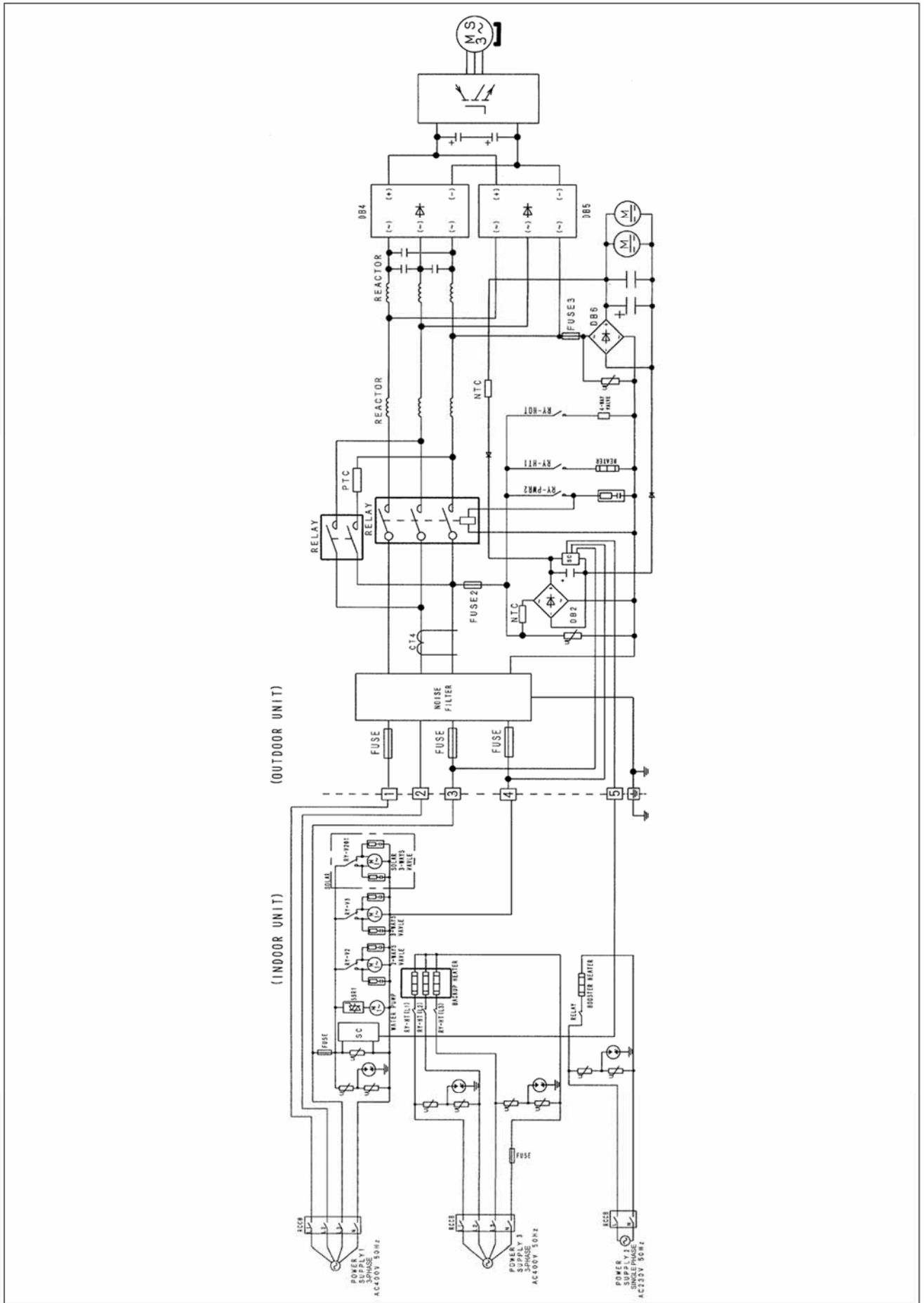

8. Wiring Connection Diagram

8.1 Indoor Unit

8.1.1 WH-SDC09C3E8

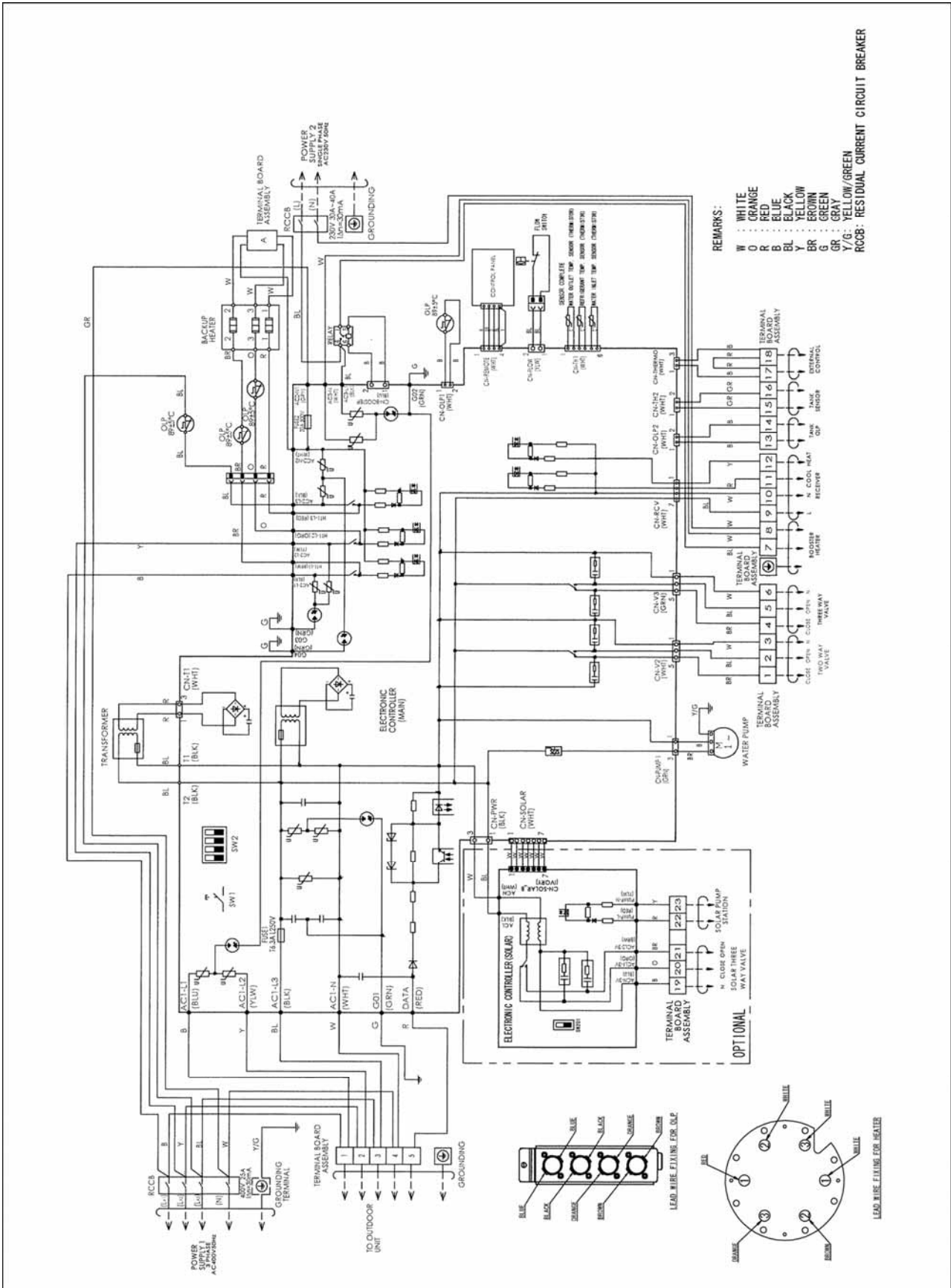

8.1.2 WH-SDC12C9E8 WH-SDC14C9E8 WH-SDC16C9E8

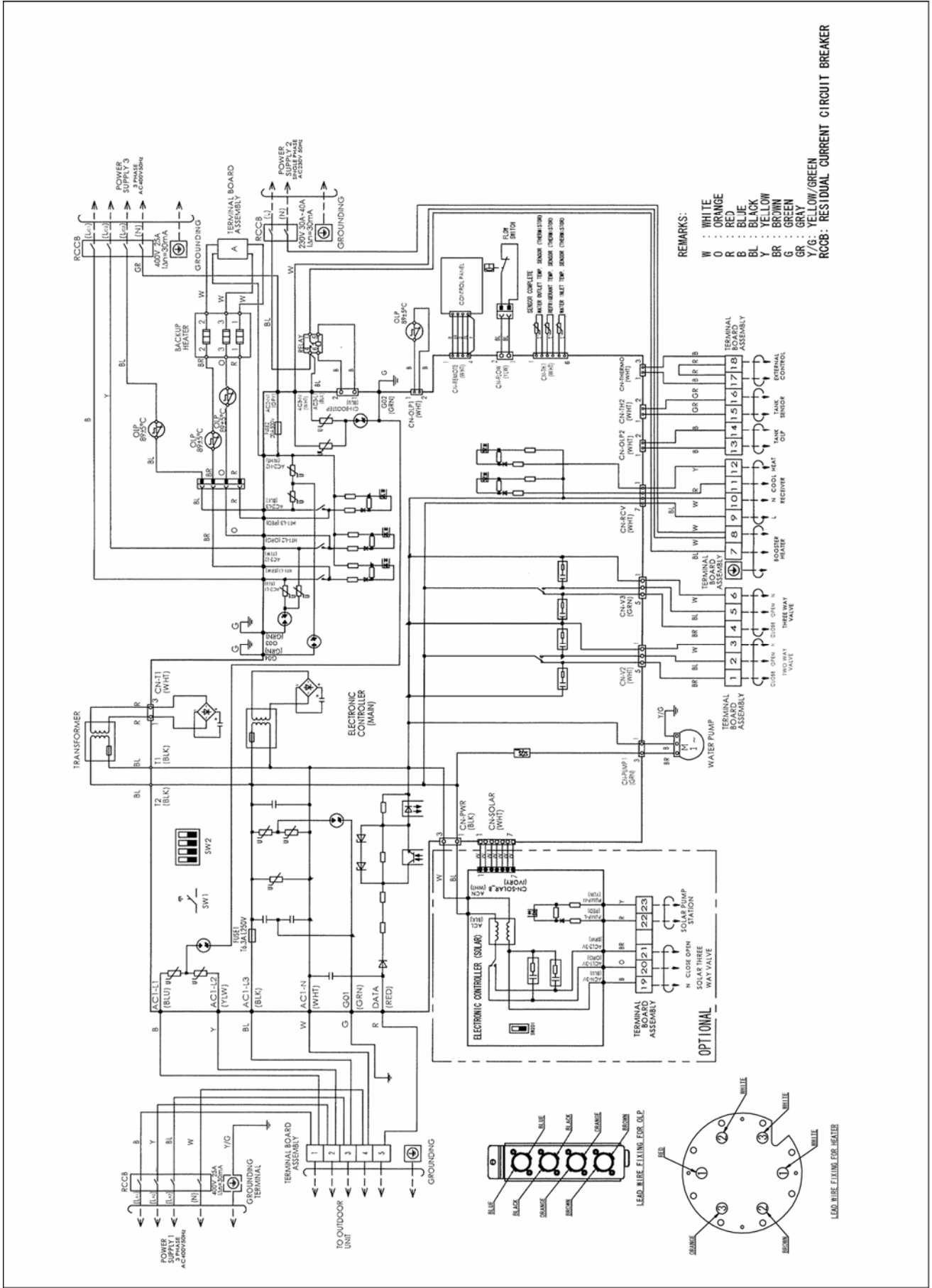

8.2 Outdoor Unit

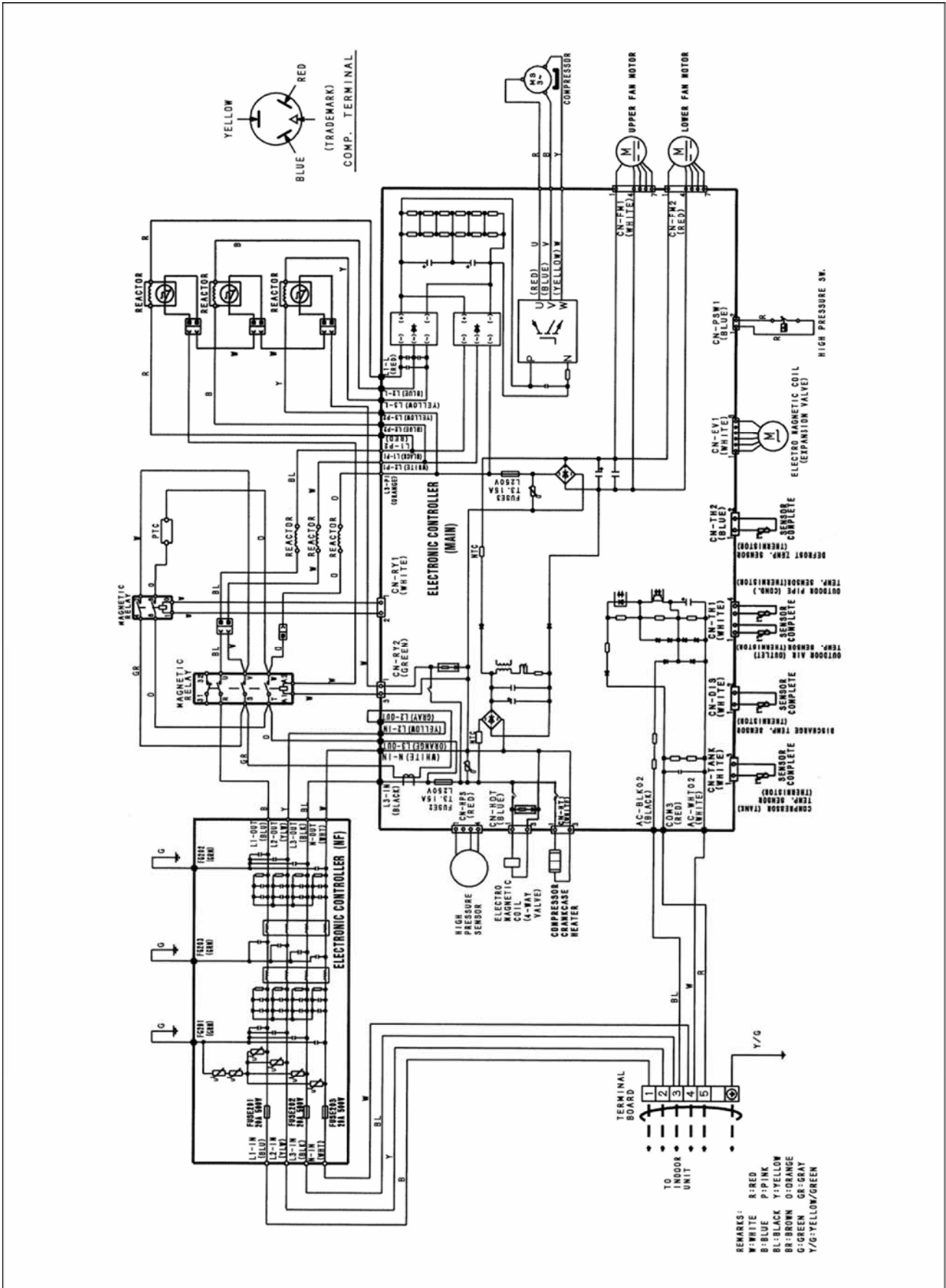

9. Electronic Circuit Diagram

9.1 Indoor Unit

9.1.1 WH-SDC09C3E8

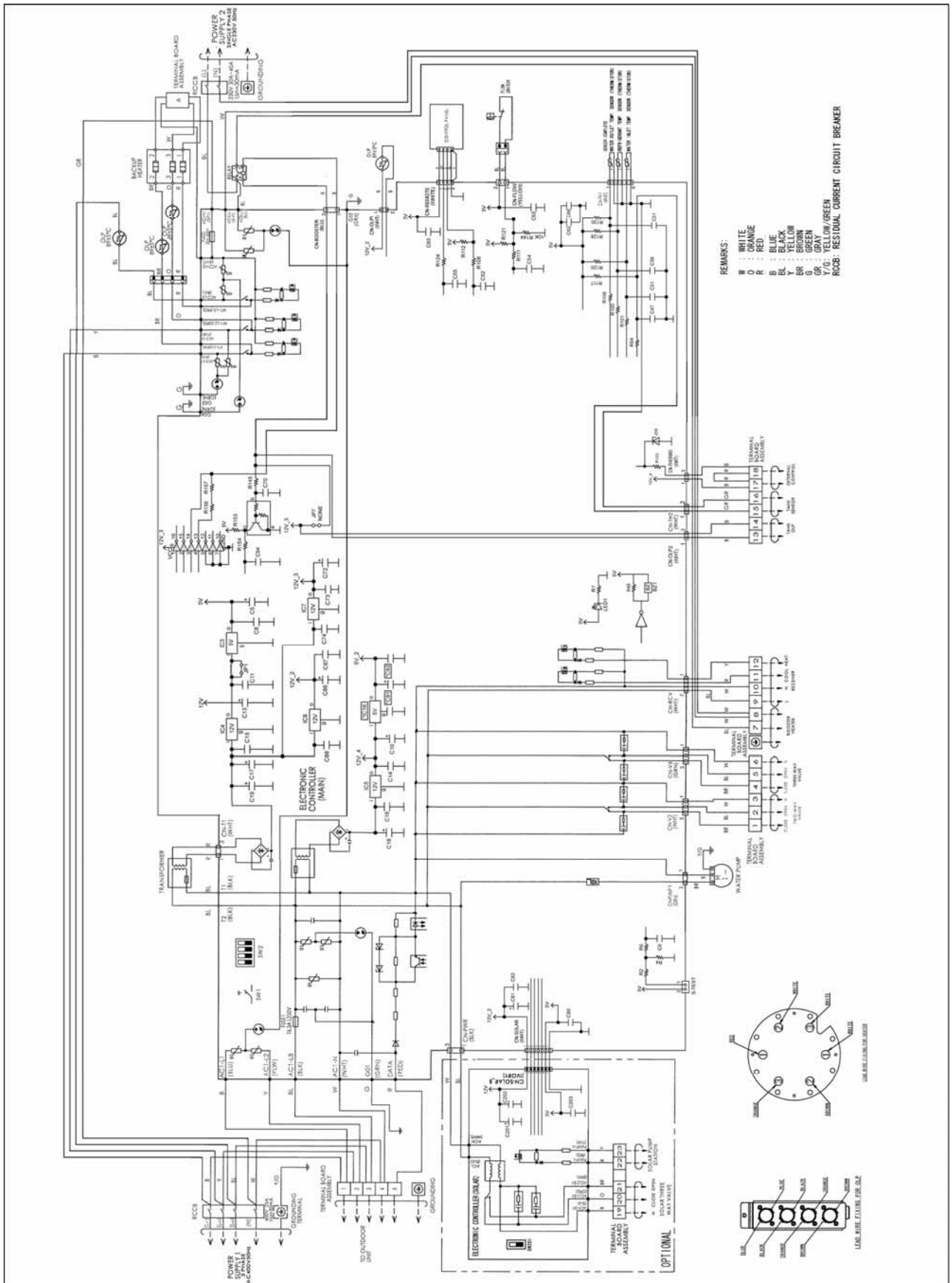

9.1.2 WH-SDC12C9E8 WH-SDC14C9E8 WH-SDC16C9E8

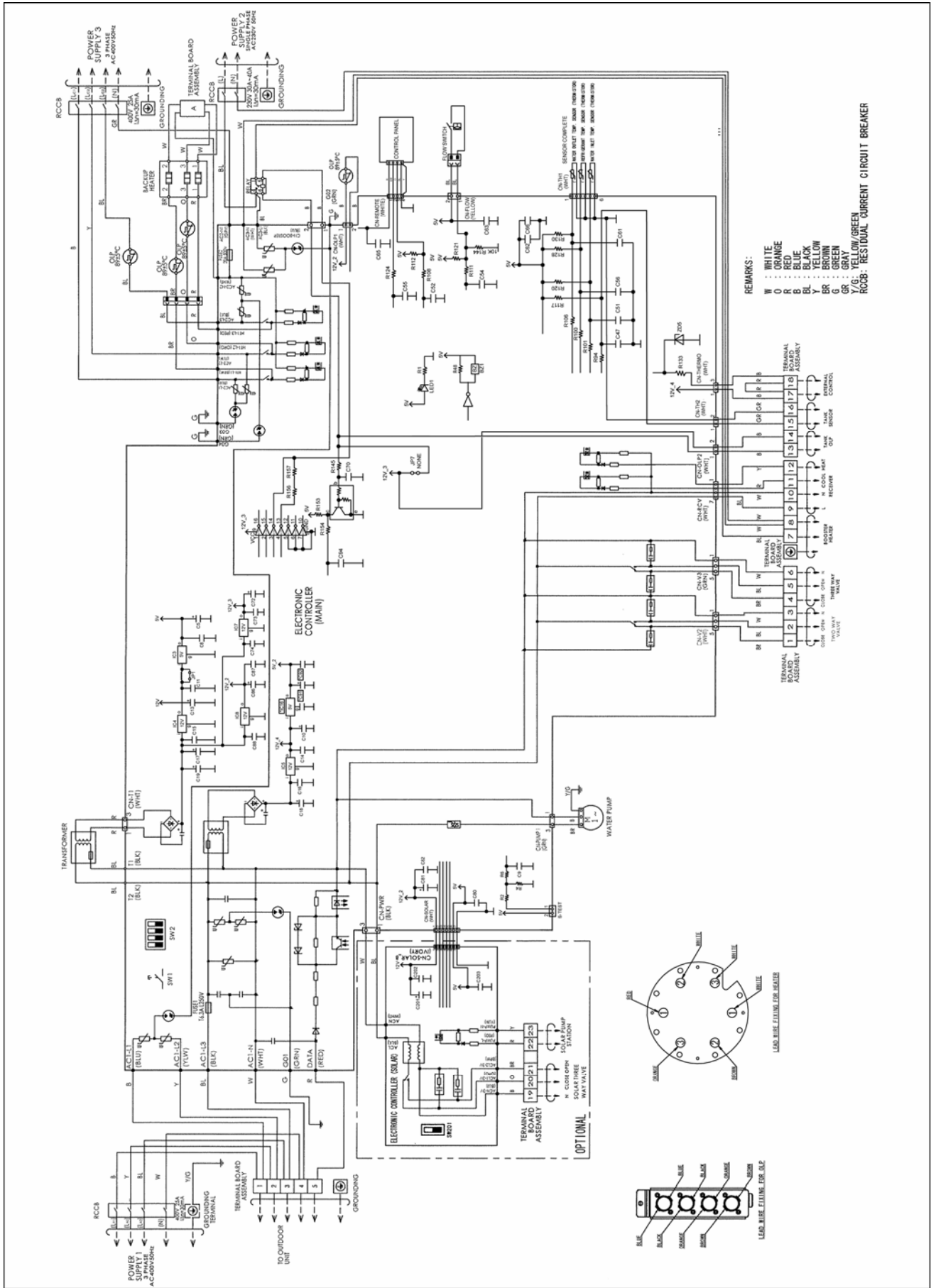

9.2 Outdoor Unit

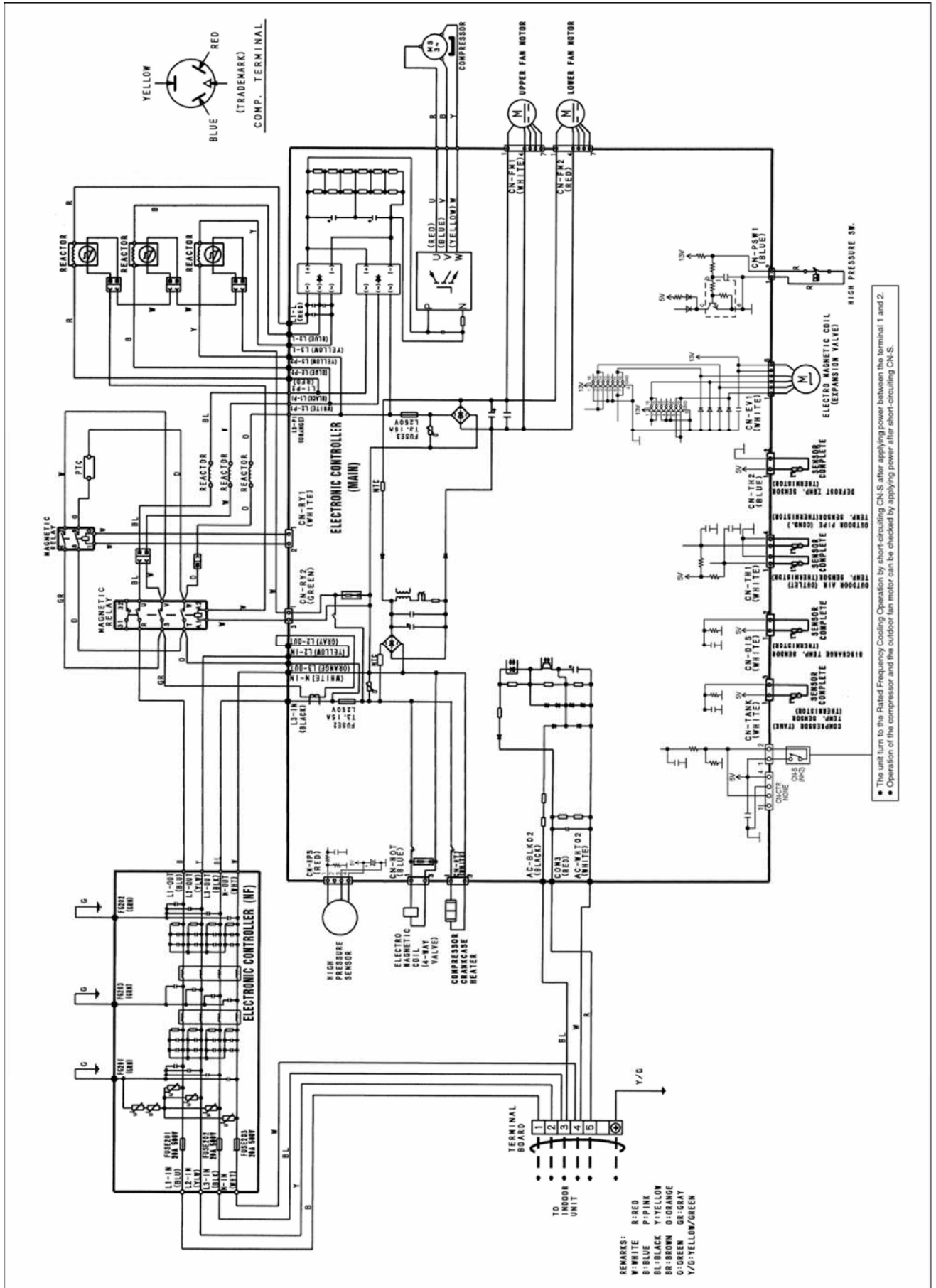

10. Printed Circuit Board

10.1 Indoor Unit

10.1.1 Main Printed Circuit Board

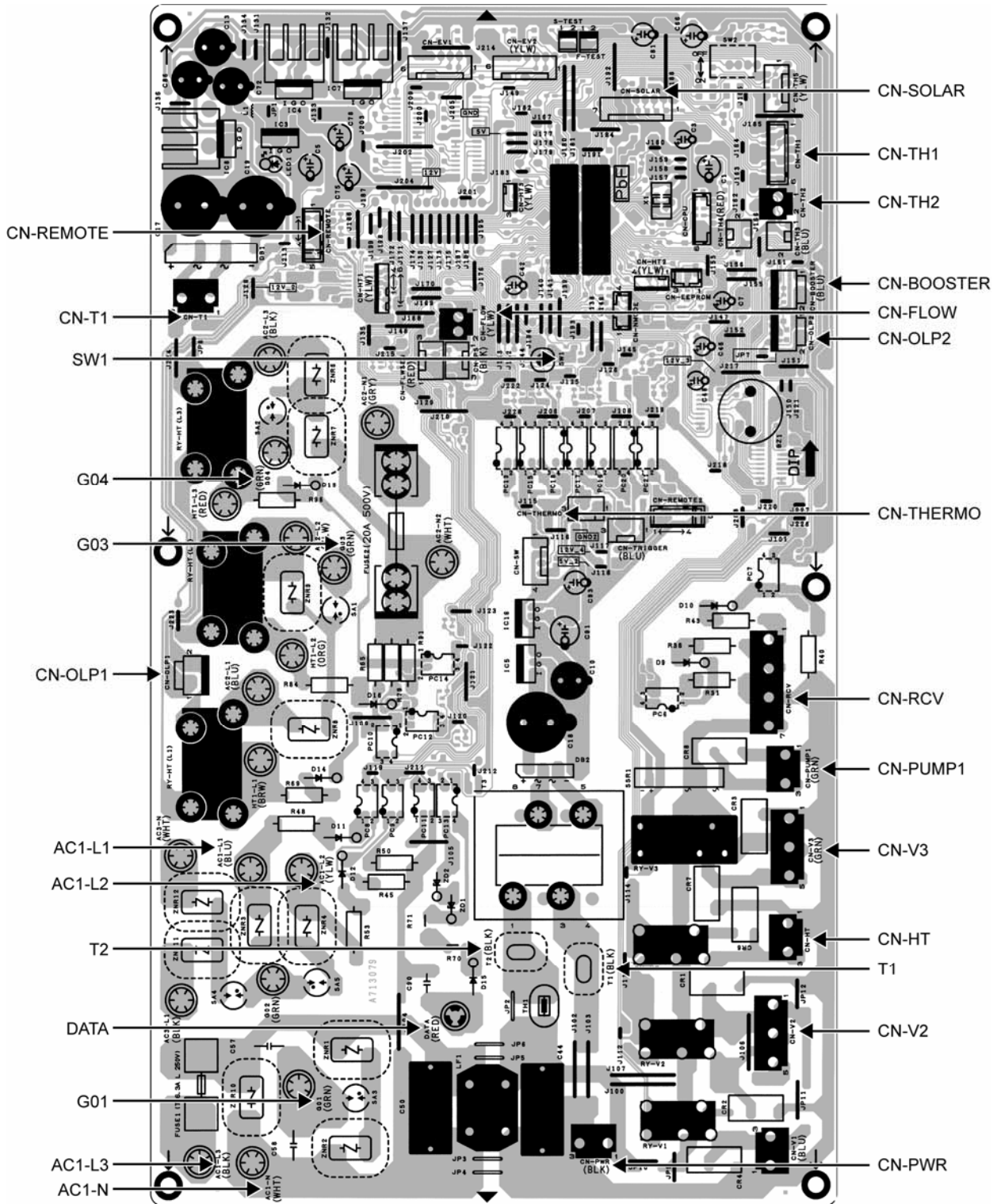

10.1.2 Solar Printed Circuit Board (Optional)

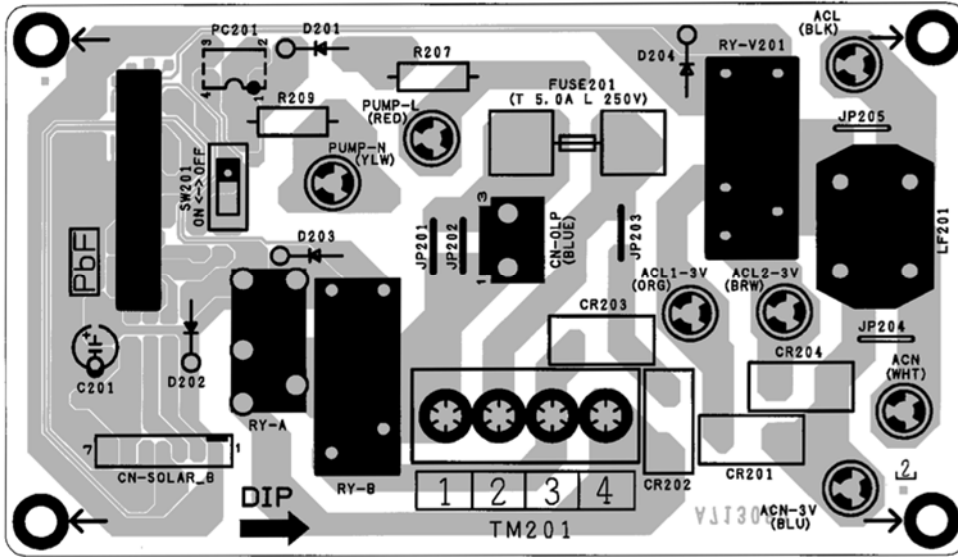

10.2 Outdoor Unit

10.2.1 Main Printed Circuit Board

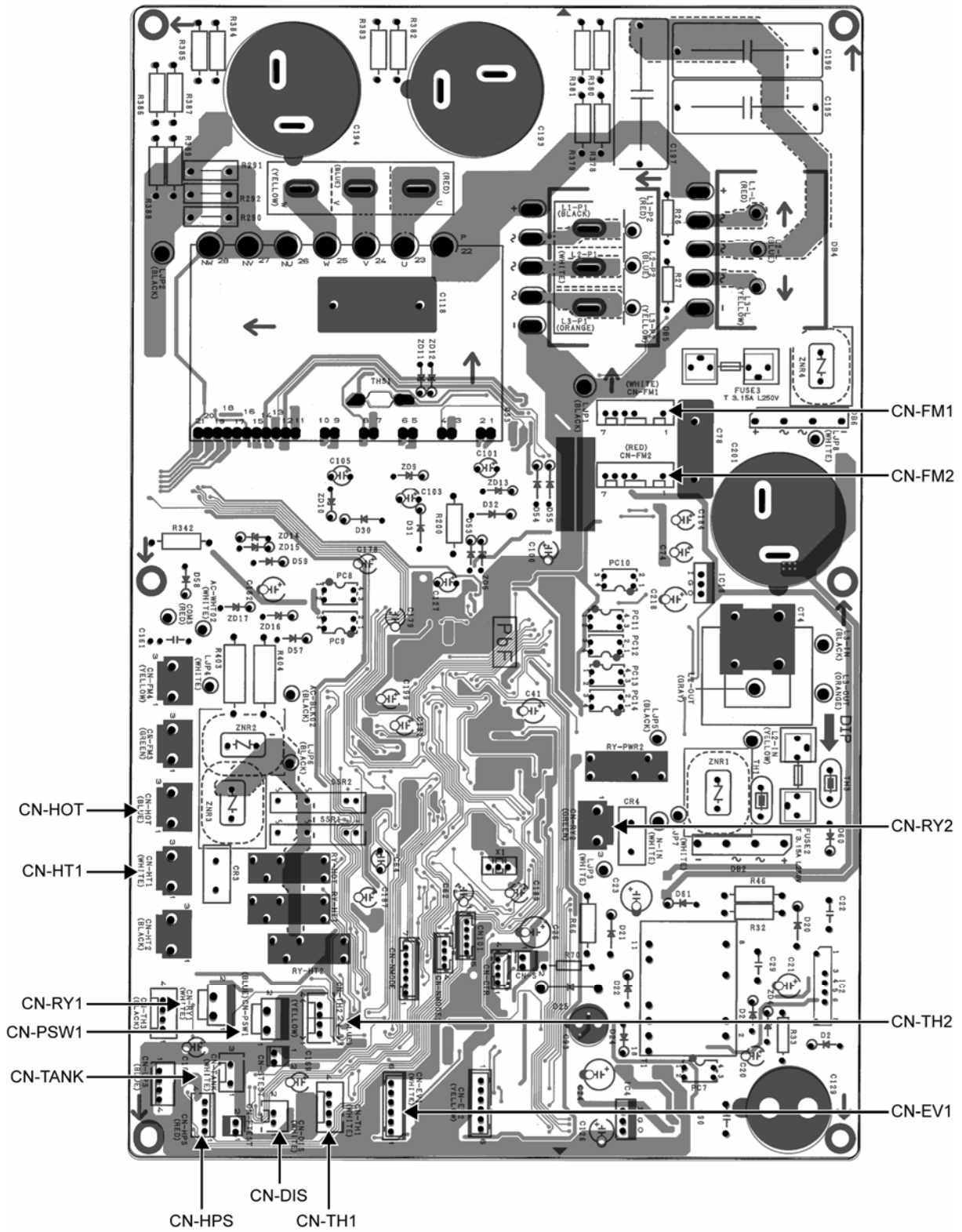

10.2.2 Noise Filter Printed Circuit Board

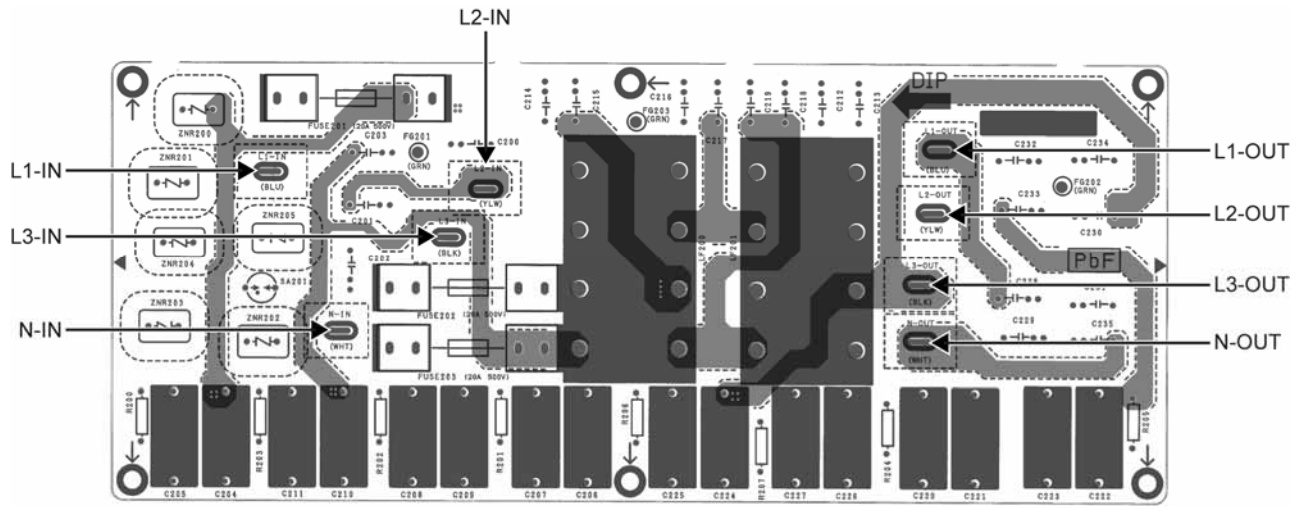

11. Installation Instruction

11.1 Select the Best Location

Indoor Unit

- There should not be any heat source or steam near the unit.
- A place where air circulation in the room is good.
- A place where drainage can be easily done.
- A place where noise prevention is taken into consideration.
- Do not install the unit near the door way.
- Ensure the spaces indicated by arrows from the wall, ceiling, fence or other obstacles.
- Recommended installation height for indoor unit shall be at least 800 mm.
- Must install on a vertical wall.
- When install electrical equipment at wooden building of metal lath or wire lath, according to electrical facility technical standard, no electrical contact between equipment and building is allowed. Insulator must be installed in between.
- Do not install the unit at outdoor. This is designed for indoor installation only.
- When connecting solar pump station cable between indoor unit and solar pump station, the distance between both apparatuses shall be 2 ~ 8 meters and the length of the said cable must be shorter than 10 meter. Fail to do so may lead to abnormal operation to the system.

Outdoor Unit

- If an awning is built over the unit to prevent direct sunlight or rain, be careful that heat radiation from the condenser is not obstructed.
- Avoid location where ambient temperature is below -20°C.
- Keep the spaces indicated by arrows from wall, ceiling, fence or other obstacles.
- Do not place any obstacles which may cause a short circuit of the discharged air.
- If outdoor unit installed near sea, region with high content of sulphur or oily location (e.g. machinery oil, etc), it lifespan maybe shorten.
- When installing the product in a place where it will be affected by typhoon or strong wind such as wind blowing between buildings, including the rooftop of a building and a place where there is no building in surroundings, fix the product with an overturn prevention wire, etc. (Overturn prevention fitting model number: K-KYZP15C)
- If piping length is over 30 m, additional refrigerant should be added as shown in the table.



Model	Piping size		Rated Length (m)	Max Elevation (m)	Min. Piping Length (m)	Max. Piping Length (m)	Additional Refrigerant (g/m)
	Gas	Liquid					
SDC09C3E8/UD09CE8	ø15.88 mm (5/8")	ø9.52 mm (3/8")	5 ~ 7.5	30	3	40	50
SDC12C9E8/UD12CE8	ø15.88 mm (5/8")	ø9.52 mm (3/8")	5 ~ 7.5	30	3	40	50
SDC14C9E8/UD14CE8	ø15.88 mm (5/8")	ø9.52 mm (3/8")	5 ~ 7.5	30	3	40	50
SDC16C9E8/UD16CE8	ø15.88 mm (5/8")	ø9.52 mm (3/8")	5 ~ 7.5	30	3	40	50

Example: For SDC12C9E8/UD12CE8
If piping length is 40m, the quantity of additional refrigerant should be 500g. [(40-30)m x 50 g/m = 500g]

11.2 Indoor/Outdoor Unit Installation Diagram

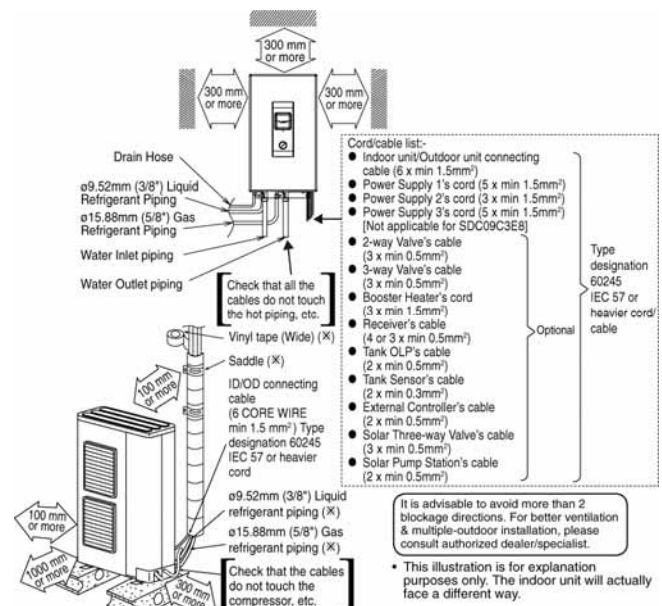

11.3 Indoor Unit

11.3.1 How to Fix Installation Plate

The mounting wall is strong and solid enough to prevent it from vibration.

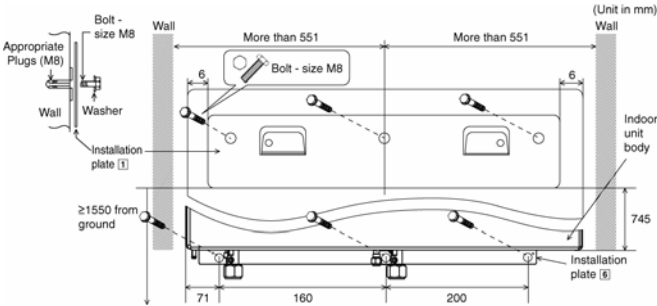

The centre of installation plate should be at more than 551 mm at right and left of the wall.

The distance from installation plate edge to ground should more than 1550 mm.

- Always mount the installation plate horizontally by aligning the marking thread and using a level gauge.
- Mount the installation plate on the wall with 6 sets of plug, bolt and washer (all non-supply) with size M8.

11.3.2 To Drill a Hole in the Wall and Install a Sleeve of Piping

- 1 Insert the piping sleeve to the hole.
- 2 Fix the bushing to the sleeve.
- 3 Cut the sleeve until it extrudes about 15 mm from the wall.



CAUTION

When the wall is hollow, please be sure to use the sleeve for tube assembly to prevent dangers caused by mice biting the connecting cable.

- 4 Finish by sealing the sleeve with putty or caulking compound at the final stage.

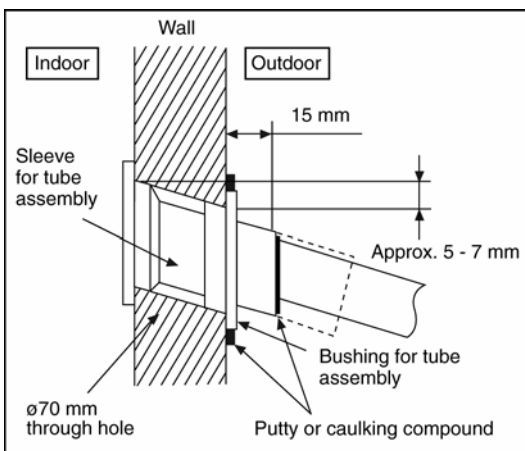

11.3.3 Indoor Unit Installation

11.3.3.1 Install the Indoor Unit

- 1 When connecting solar pump station cable between indoor unit and solar pump station, the distance between both apparatuses shall be 2 ~ 8 meters and the length of the said cable must be shorter than 10 meter. Fail to do so may lead to abnormal operation to the system.
- 2 Engage the slots on the indoor unit to the hooks of installation plate 1. Ensure the hooks are properly seated on the installation plate by moving it left and right.
- 3 Fix the screws 5 to the holes on the hooks of installation plate, 6, as illustrated below.

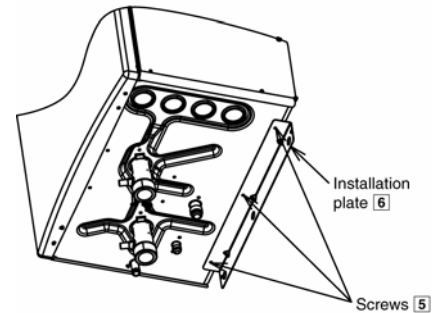
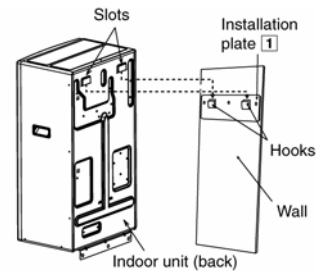

11.3.3.2 Water Piping Installation

- The minimum requirement of water in the system is 50 litres (for 12.0kW~16.0kW) and 30 litres (for 9.0kW). If these values could not be achieved, please install additional buffer tank (field supply).
- Water inlet and water outlet in indoor unit are used for connection to water circuit. Please request a licensed technician to install this water circuit.
- This water circuit must comply with all relevant European and national regulations, i.e. IEC/EN 61770.
- Be careful not to deform the piping with excessive force when doing piping connection job.
- Do not install any valve between indoor unit and water piping to avoid accidental closure of water supply to the indoor unit.
- Use Rp 1 1/4" nut for both water inlet and outlet connection and clean all pipings with tap water before install.
- Cover the pipe end to prevent dirt and dust when inserting it through a wall.
- Choose proper sealer which can withstand the pressures and temperatures of the system.

- If old heatpump terminal/tank is utilized, please clean the dust properly before installation.
- Refer Diagram 4.1 for installation of 3-way Valve Kit and 2-way Valve Kit.
- Must install an external filter (30 mesh or more, field supply) before water inlet connector of indoor unit (indicated with "WATER IN").
- Connect the external filter inlet to boiler tank outlet. Then, connect water outlet connector of indoor unit (indicated with "WATER OUT") to boiler tank inlet. Fail to connect the tube appropriately might causing the indoor unit malfunction.
- Be sure to use two spanners to tighten the connection. Further tighten the nuts with torque wrench in specified torque as stated in the table.
- If non-brass metallic piping is used for installation, make sure to insulate the pipes to prevent galvanic corrosion.
- Make sure to insulate the water circuit pipes to prevent reduction of heating capacity.
- After installation, check the water leakage condition in connection area during test run.
- Finally, mount the PS foam [7] and long banding strap [8] to water inlet and outlet connectors, as shown in below illustration.

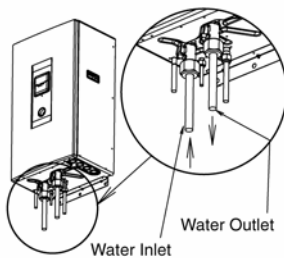
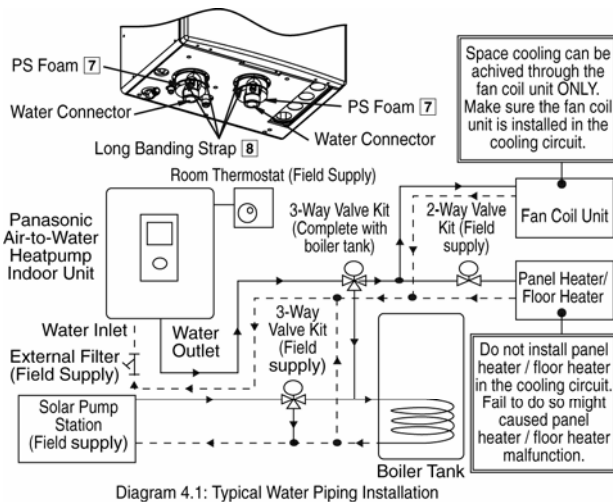

Model	Nut size (Torque)
	Water
SDC09C3E8/UD09CE8, SDC12C9E8/UD12CE8, SDC14C9E8/UD14CE8, SDC16C9E8/UD16CE8	Rp 1¼" [117.6 N•m]

CAUTION
Do not over tighten, over tightening cause water leakage.

11.3.3.3 Indoor Unit Refrigerant Pipe Installation

- 1 Please make flare after inserting flare nut (located at joint portion of tube assembly) onto the copper pipe. (In case of using long piping)
- 2 Do not use pipe wrench to open refrigerant piping. Flare nut may be broken and cause leakage. Use proper spanner or ring wrench.
- 3 Connect the piping:
 - Align the center of piping and sufficiently tighten the flare nut with fingers.
 - Further tighten the flare nut with torque wrench in specified torque as stated in the table.

Model	Piping size (Torque)	
	Gas	Liquid
SDC09C3E8/UD09CE8, SDC12C9E8/UD12CE8, SDC14C9E8/UD14CE8, SDC16C9E8/UD16CE8	ø15.88mm (5/8") [65 N•m]	ø 9.52mm (3/8") [42 N•m]

CAUTION
Do not over tighten, over tightening cause gas leakage.

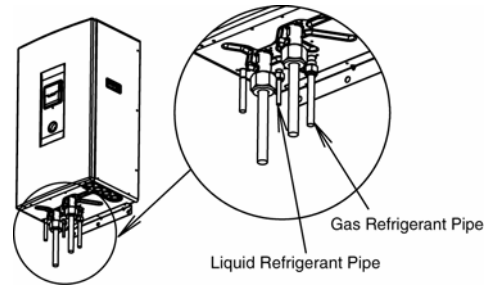

11.3.3.4 Drain Hose Installation

- Use inner diameter 15 mm drain hose in the market.
- This hose must to be installed in a continuously downward direction and in a frost-free environment.
- Guides this hose's outlet to outdoor only.
- Do not insert this hose into sewage hose or cleaning hose that may generate ammonia gas, sulfuric gas, etc.
- If necessary, use hose clamp to further tighten the hose at drain hose connector to prevent leakage.
- The water may drip from drain hose . Therefore must ensure the outlet of the hose is always not closed or not blocked.

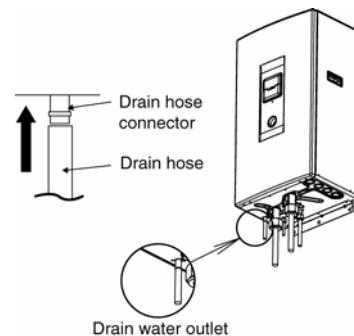

11.3.4 Connect the Cable to the Indoor Unit

- 1 Connecting cable between indoor unit and outdoor unit shall be approved polychloroprene sheathed (6 x min 1.5 mm²) flexible cord, type designation 60245 IEC 57 or heavier cord.
 - Ensure the colour of wires of outdoor unit and the terminal Nos. are the same to the indoor unit's respectively.
 - Earth wire shall be longer than the other wires as shown in the figure for the electrical safety in case of the slipping out of the cord from the Holder (Clamper).
- 2 Cable connection to the power supply through isolating device (Disconnecting means).
 - Isolating device (Disconnecting means) should have minimum 3.0 mm contact gap.
 - Connect the approved polychloroprene sheathed power supply 1 cord (5 x min 1.5 mm²) and power supply 2 cord (3 x min 1.5 mm²) and power supply 3 cord (5 x min 1.5 mm²), type designation 60245 IEC 57 or heavier cord to the terminal board, and to the other end of the cord to isolating device (Disconnecting means).
- 3 To avoid cable and cord harmed by sharp edge, cable and cord must go through bushing (located at the bottom of indoor unit) before carry out electrical connection. The bushing must be used and must not take off.

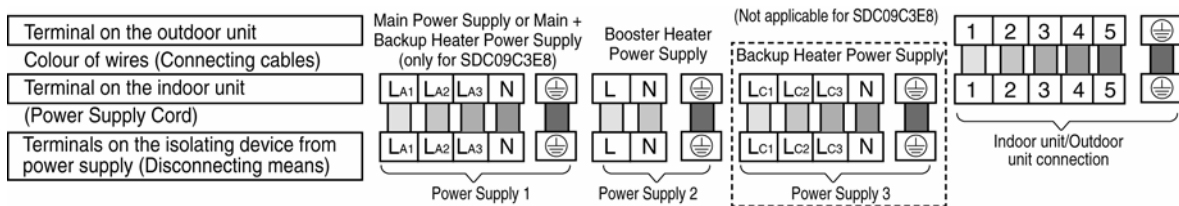

Connecting with external device (optional)

- 1 **All connections shall** follow to the local national wiring standard.
- 2 It is strongly recommended to use manufacturer-recommended parts and accessories for installation.
- 3 Maximum output power of booster heater shall be ≤ 3 kW. Booster Heater's cord must be (3 x min 1.5 mm²), of type designation 60245 IEC 57 or heavier.
- 4 Two-way Valve shall be spring and electronic type, refer to "Field Supply Accessories" table for details. Valve's cable shall be (3 x min 0.5 mm²), of type designation 60245 IEC 57 or heavier, or similarly double insulation sheathed cable.
 - * note: - Two-way Valve shall be CE marking compliance component.
 - Maximum load for the valve is 3VA.
- 5 Three-Way Valve shall be spring and electronic type. Valve's cable shall be (3 x min 0.5 mm²), of type designation 60245 IEC 57 or heavier, or similarly double insulation sheathed cable.
 - * note: - Shall be CE marking compliance component.
 - It shall be directed to heating mode when it is OFF.
 - Maximum load for the valve is 3VA.
- 6 Receiver shall be connected to "Room Thermostat", refer to "Field Supply Accessories" table for details. Receiver's cable must be (4 or 3 x min 0.5 mm²), double insulation layer of PVC-sheathed or rubber-sheathed cable. (connection refer to Diagram 5.2).
- 7 Tank OLP's cable must be (2 x min 0.5 mm²), double insulation layer of PVC-sheathed or rubber-sheathed cable.
 - * note: if such connection deemed NOT necessary for tank OLP, please connect jumper between terminal no #13 and #14.
- 8 Tank Sensor shall be resistance type, please refer to Graph 5.1 for the characteristic and details of sensor. Its cable shall be (2 x min 0.3 mm²), double insulation layer (with insulation strength of min 30V) of PVC-sheathed or rubber-sheathed cable.
- 9 External Controller shall be connected to 1-pole switch with min 3.0mm contact gap. (connection refer to Diagram 5.3). Its cable must be (2 x min 0.5 mm²), double insulation layer of PVC-sheathed or rubber-sheathed cable.
 - * note: - When making such connection, kindly remove the jumper between terminal no #17 and #18.
 - Switch used shall be CE marking compliance component.
 - Maximum operating current shall be less than $3A_{rms}$.
- 10 Solar Three-way Valve's cable shall be (3 x min 0.5 mm²), double insulation layer PVC-sheathed or rubber-sheathed cable.
- 11 Must install Solar Connection PCB **10** to indoor unit when Solar Pump Station is utilized. Refer Solar Connection PCB's installation instruction for detail of installation.

12 Solar Pump Station's cable shall be (2 x min 0.5 mm²), of double insulation PVC-sheathed or rubber-sheathed cable. Strongly recommended install with maximum length of 10 meter only.

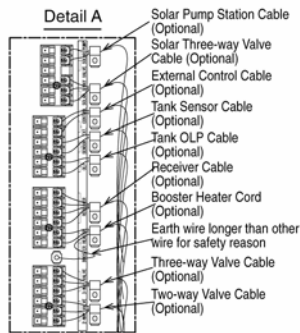
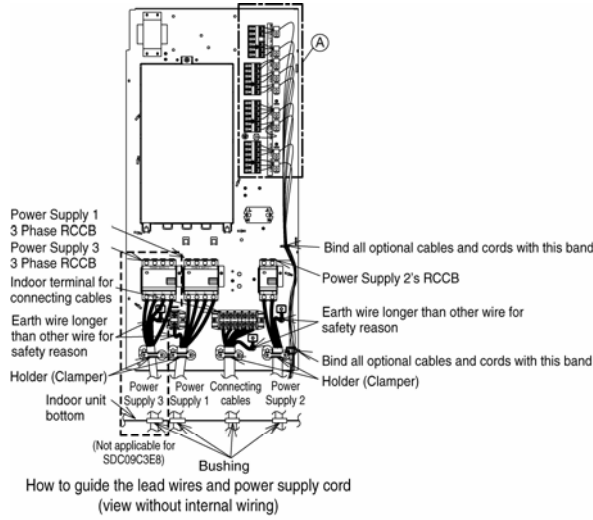
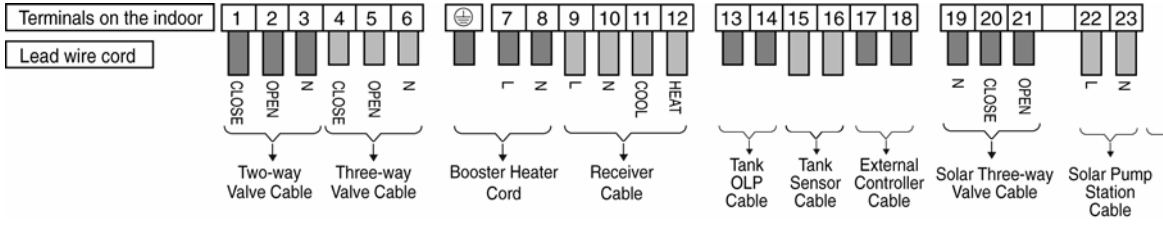

Terminal screw	Tightening torque N•cm {kgf•cm}
M4	157~196 {16~20}
M5	196~245 {20~25}

11.3.4.1 Wire Stripping and Connecting Requirement

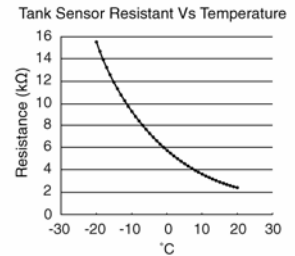
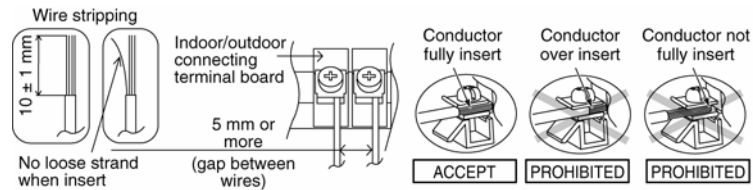

Graph 5.1: Tank sensor characteristic

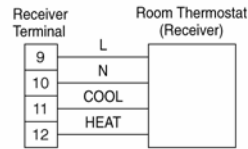

Diagram 5.2: Room Thermostat (Receiver) connecting diagram

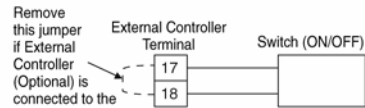

Diagram 5.3: External Controller connecting diagram

11.3.4.2 Connecting Requirement

For SDC09C3E8/UD09CE8

- The equipment's power supply 1 complies with IEC/EN 61000-3-2.
- The equipment's power supply 2 complies with IEC/EN 61000-3-2.

For SDC12C9E8/UD12CE8, SDC14C9E8/UD14CE8, SDC16C9E8/UD16CE8

- The equipment's power supply 1 complies with IEC/EN 61000-3-2.
- The equipment's power supply 2 complies with IEC/EN 61000-3-2.
- The equipment's power supply 3 complies with IEC/EN 61000-3-12 provided that the short-circuit power S_{sc} is greater than or equal to 575kW (for SDC12C9E8/UD12CE8, SDC14C9E8/UD14CE8, SDC16C9E8/UD16CE8) at the interface point between the user's supply and the public system. It is the responsibility of the installer or user of the equipment to ensure, by the consultation with the distribution network operator if necessary, that the equipment is connected only to a supply with short-circuit power S_{sc} greater than or equal to 575kW.
- The equipment's power supply 3 shall be connected to a suitable supply network, with the following maximum permissible system impedance Z_{max} at the interface of the point for model:
 SDC12C9E8/UD12CE8, SDC14C9E8/UD14CE8, SDC16C9E8/UD16CE8 : 0.449 Ω
 Please liaise with supply authority to ensure that power supply 3 is connected to a supply of the impedance or less.

11.4 Outdoor Unit

11.4.1 Install the Outdoor Unit

- After selecting the best location, start installation according to Indoor/Outdoor Unit Installation Diagram.
 - Fix the unit on concrete or rigid frame firmly and horizontally by bolt nut ($\varnothing 10$ mm).
 - When installing at roof, please consider strong wind and earthquake. Please fasten the installation stand firmly with bolt or nails.

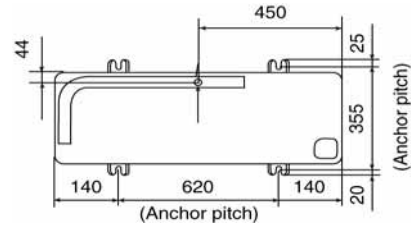

(Unit in mm)

11.4.2 Connecting the Piping

Model	Piping size (Torque)	
	Gas	Liquid
SDC09C3E8/UD09CE8, SDC12C9E8/UD12CE8, SDC14C9E8/UD14CE8, SDC16C9E8/UD16CE8	$\varnothing 15.88\text{mm}$ (5/8") [65 N•m]	$\varnothing 9.52\text{mm}$ (3/8") [42 N•m]
 CAUTION Do not over tighten, over tightening cause gas leakage.		

Connecting the Piping to Outdoor Unit

Decide piping length and then cut by using pipe cutter. Remove burrs from cut edge. Make flare after inserting the flare nut (locate at valve) onto the copper pipe.

Align center of piping to valves and then tighten with torque wrench to the specified torque as stated in the table.

Local pipes can project in any of four directions.

- Make holes in the pipe panels for the pipes to pass through.
- Be sure to install the pipe panels to prevent rain from getting inside the outdoor unit.

[Removing the service panel].

- Remove the three mounting screws.
 - Slide the service panel downward to release the pawls.
- After this, pull the service panel toward you to remove it.

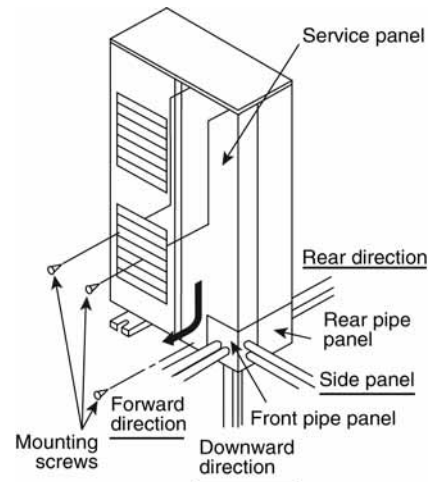

Be sure to use two spanners to tighten.
(If the nuts are overtightened, it may cause the flares to break or leak.)

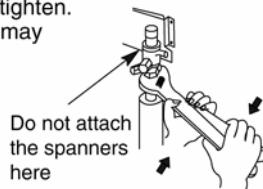

Close the tube joining area with putty heat insulator (local supply) without any gap as shown in right figure. (To prevent insects or small animal entering.)

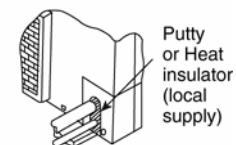

Cutting and Flaring the Piping

- 1 Please cut using pipe cutter and then remove the burrs.
- 2 Remove the burrs by using reamer. If burrs is not removed, gas leakage may be caused. Turn the piping end down to avoid the metal powder entering the pipe.
- 3 Please make flare after inserting the flare nut onto the copper pipes.

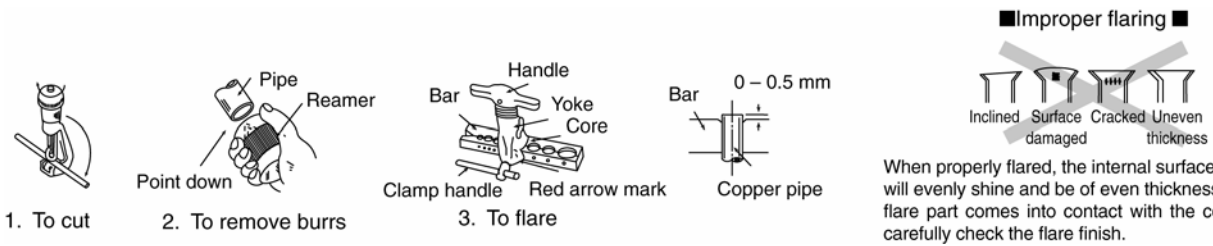

11.4.3 Evacuation of the Equipment

WHEN INSTALLING AN AIR-TO-WATER HEATPUMP, BE SURE TO EVACUATE THE AIR INSIDE THE INDOOR UNIT AND PIPES in the following procedure.

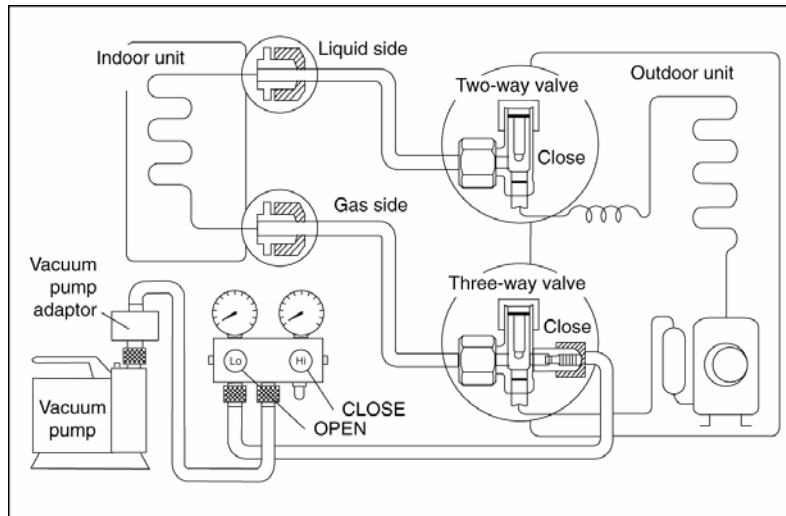

- 1 Connect a charging hose with a push pin to the Low side of a charging set and the service port of the 3-way valve.
 - Be sure to connect the end of the charging hose with the push pin to the service port.
- 2 Connect the center hose of the charging set to a vacuum pump with check valve, or vacuum pump and vacuum pump adaptor.
- 3 Turn on the power switch of the vacuum pump and make sure that the needle in the gauge moves from 0 cmHg (0 MPa) to -76 cmHg (-0.1 MPa). Then evacuate the air approximately ten minutes.
- 4 Close the Low side valve of the charging set and turn off the vacuum pump. Make sure that the needle in the gauge does not move after approximately five minutes.

Note: BE SURE TO FOLLOW THIS PROCEDURE IN ORDER TO AVOID REFRIGERANT GAS LEAKAGE.
- 5 Disconnect the charging hose from the vacuum pump and from the service port of the 3-way valve.
- 6 Tighten the service port caps of the 3-way valve at a torque of 18 N•m with a torque wrench.
- 7 Remove the valve caps of both of the 2-way valve and 3-way valve. Position both of the valves to "OPEN" using a hexagonal wrench (4 mm).
- 8 Mount valve caps onto the 2-way valve and the 3-way valve.
 - Be sure to check for gas leakage.

CAUTION

- If gauge needle does not move from 0 cmHg (0 MPa) to -76 cmHg (-0.1 MPa), in step ③ above take the following measure:
- If the leak stops when the piping connections are tightened further, continue working from step ③.
 - If the leak does not stop when the connections are retightened, repair location of leak.
 - Do not release refrigerant during piping work for installation and reinstallation. Take care of the liquid refrigerant, it may cause frostbite.

11.4.4 Connect the Cable to the Outdoor Unit

(FOR DETAIL REFER TO WIRING DIAGRAM AT UNIT)

- 1 Remove the control board cover from the unit by loosening the screw.
- 2 Connecting cable between indoor unit and outdoor unit shall be approved polychloroprene sheathed (6 x min 1.5 mm²) flexible cord, type designation 60245 IEC 57 or heavier cord.

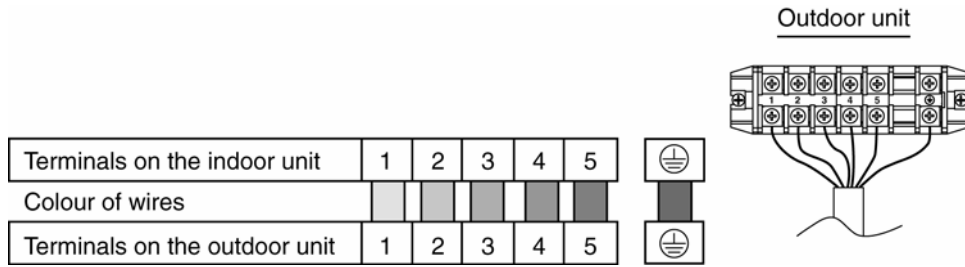

- 3 Secure the cable onto the control board with the holder (clamer).
- 4 Select required direction and apply protective bushing provided in accessories to protect cables from sharp edges.
- 5 Once all wiring work has been completed, tie the cables and cord together with the binding strap so that they do not touch other parts such as the compressor and bare copper pipes.
- 6 Install back the control board cover.

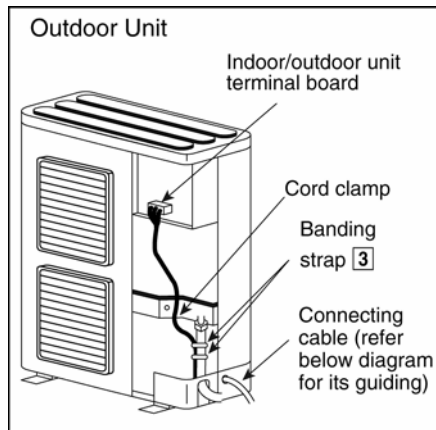

11.4.4.1 Wire Stripping and Connecting Requirement

Same as indoor requirement. For details please refer the diagram on AIR-TO-WATER HEATPUMP INDOOR UNIT, section ⑤ (CONNECT THE CABLE TO THE INDOOR UNIT).

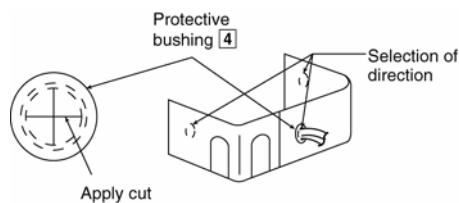

DETAIL OF CONNECTING CABLE GUIDING



CAUTION

- For three phase model never operate the unit by pressing the electromagnetic switch.
- Never correct the phase by switching over any of the wires inside the unit.

11.4.5 Pipe Insulation

- 1 Please carry out insulation at pipe connection portion as mentioned in Indoor/Outdoor Unit Installation Diagram. Please wrap the insulated piping end to prevent water from going inside the piping.
- 2 If drain hose or connecting piping is in the room (where dew may form), please increase the insulation by using POLY-E FOAM with thickness 6 mm or above.

11.4.6 Disposal of Outdoor Unit Drain Water

- If a drain elbow is used, the unit should be placed on a stand which is taller than 50 mm.
- If the unit is used in an area where temperature falls below 0°C for 2 or 3 days in succession, it is recommended not to use a drain elbow, for the drain water freezes and the fan will not rotate.

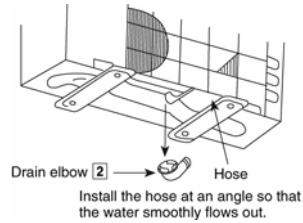

12. Operation and Control

12.1 Basic Function

Inverter control, which is equipped with a microcomputer, determines the most suitable operating mode as time passes, automatically adjusting output power for maximum comfort. In order to achieve the suitable operating mode, the microcomputer maintains the set temperature by measuring the temperature of the environment and performing temperature shifting. The compressor at the outdoor unit is operating following the frequency instructed by the microcomputer at the indoor unit, which judges the condition according to the internal water setting temperature and the water outlet temperature.

12.1.1 Internal Water Setting Temperature

Once the operation starts, the control panel setting temperature will be taken as the base value for temperature shifting processes. These shifting processes depend on the Air-to-Water Heatpump settings and the operation environment. The final shifted value will be used as the internal water setting temperature and is updated continuously whenever the electrical power is supplied to the unit.

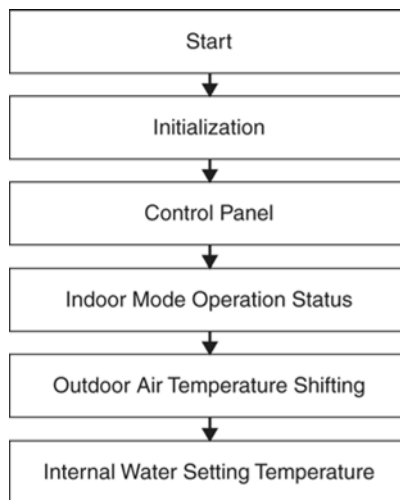

12.1.2 Heating Operation

12.1.2.1 Thermostat control

- Compressor is OFF when Water Outlet Temperature - Internal Water Setting Temperature > 2°C for continuously 3 minutes.
- Compressor is ON after waiting for 3 minutes, if the Water Outlet Temperature - Water Inlet Temperature (temperature at thermostat OFF is triggered) < -3°C.

12.1.3 Cooling Operation

12.1.3.1 Thermostat control

- Compressor is OFF when Water Outlet Temperature - Internal Water Setting Temperature < -1.5°C for continuously 3 minutes.
- Compressor is ON after waiting for 3 minutes, if the Water Outlet Temperature - Water Inlet Temperature (temperature at thermostat OFF is triggered) > 3°C.

12.1.4 Cool Mode Operation

- 1 3 ways valve control:
 - 3 ways valve switch and fix to room side.
- 2 Heatpump operate follow normal cooling operation.
- 3 Backup heater DOES NOT operate during cool mode.
- 4 Solar 3 way valve operates follow solar operation specification.
- 5 2 ways valve control:
 - 2 ways valve is closed.

Cool Mode Operation Time Chart

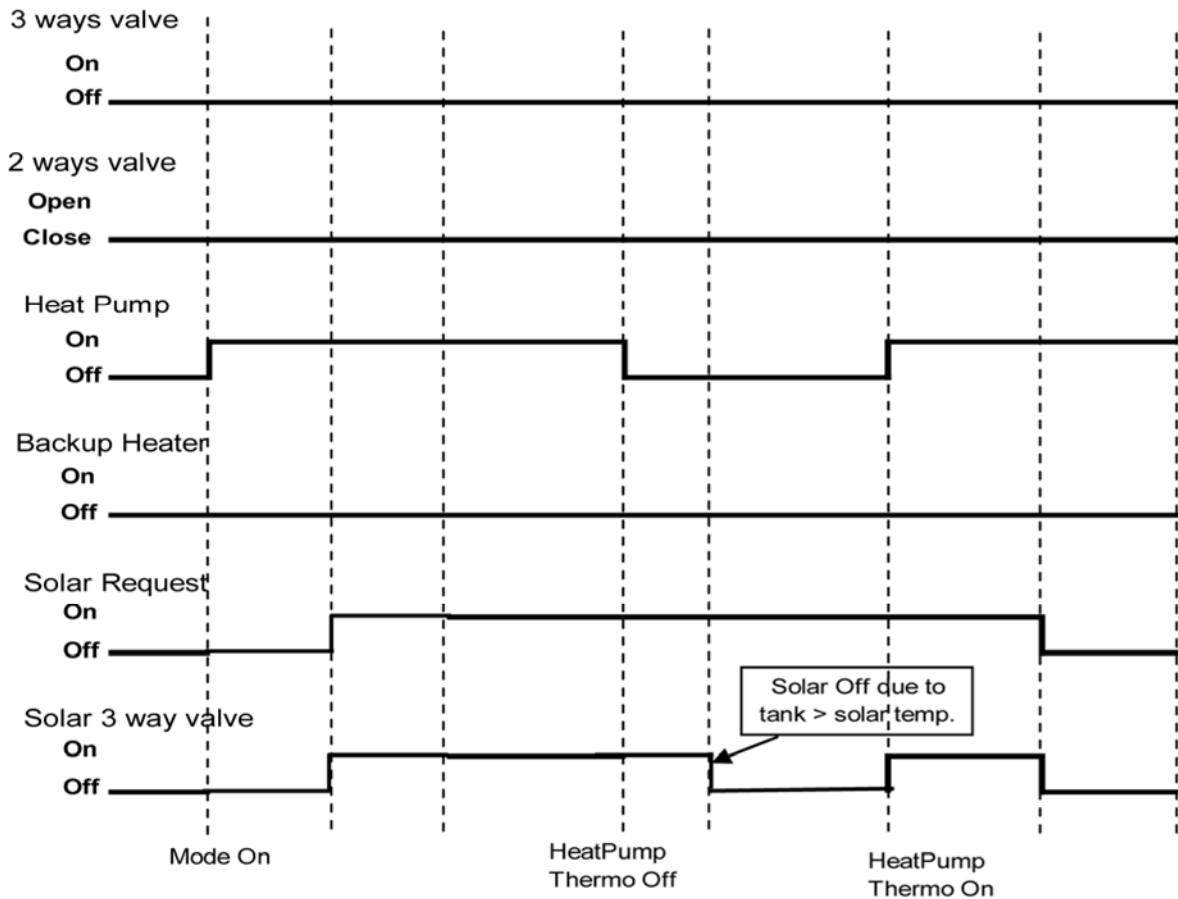

12.1.5 Cool + Tank Mode Operation

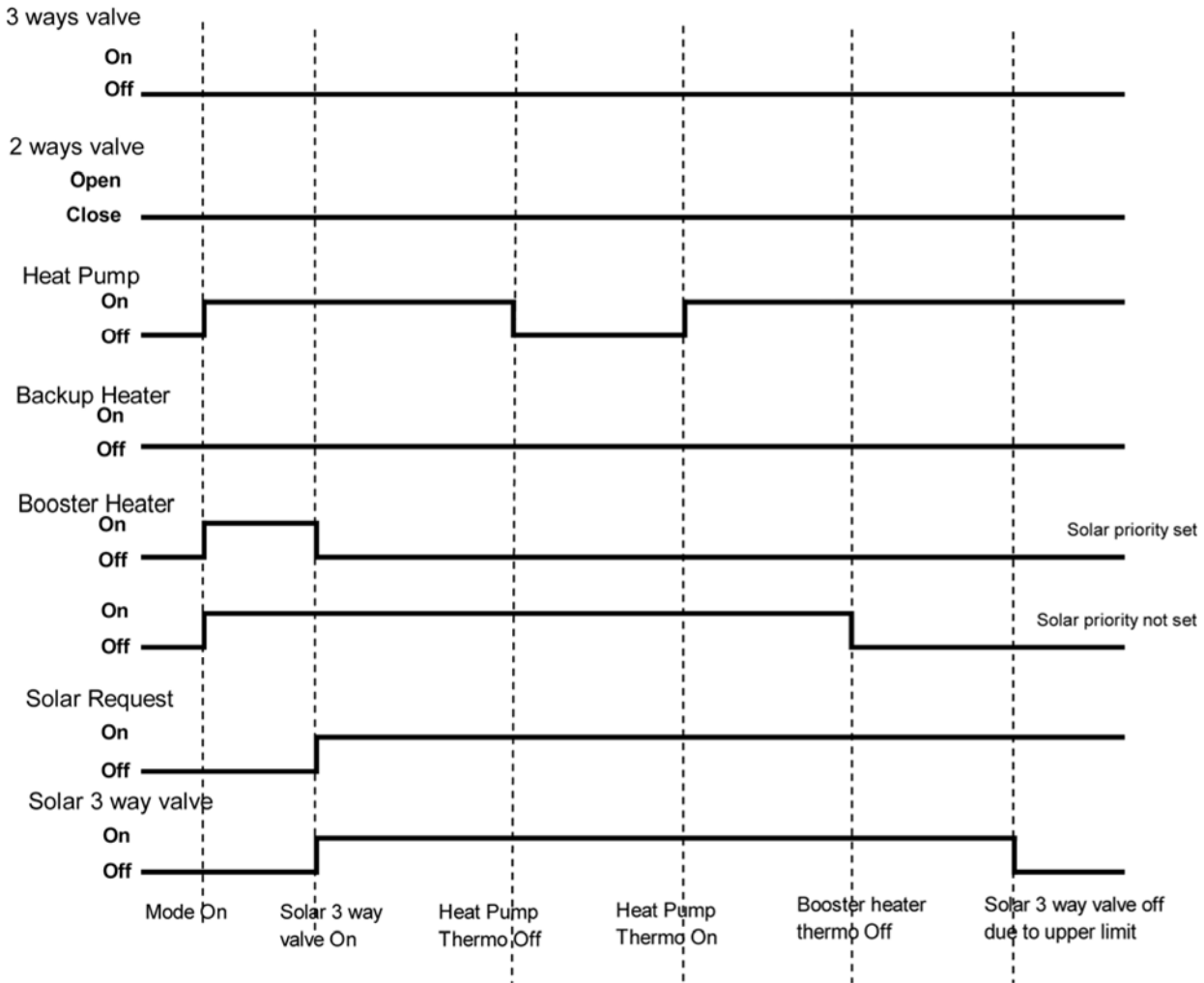

12.1.6 Tank Mode Operation

Control contents:

- 3 ways valve direction
 - 3 ways valve switch and fix to tank side.
 - Heatpump Thermostat characteristic
 - Water set temperature = Tank set temperature or **[55°C]** whichever lower.
 - Heatpump Water Outlet set temperature is set to Maximum (55°C) at tank mode
- i. Case 1
- THERMO OFF TEMP:
 - 1 THERMO OFF TEMP = Water set temperature + **[+2°C]**.
 - 2 Tank temperature > THERMO OFF TEMP for continuous 3 minutes, heatpump OFF and water pump OFF.
 - THERMO ON TEMP:
 - 1 THERMO ON TEMP = Water set temperature + **[-3°C]**.
 - 2 When detect tank temperature < THERMO ON TEMP, water pump ON for 3 minute then heatpump ON.
 - Pump ON when Tank temperature is less than tank temperature when Heatpump Thermo Off - **[-3°C]**.

ii. Case 2

- Heatpump THERMO OFF TEMP:

- 1 Heatpump THERMO OFF TEMP = $55^{\circ}\text{C} + [+2^{\circ}\text{C}]$.
- 2 Water outlet temperature > Heatpump THERMO OFF TEMP for continuous 3 minutes, heatpump OFF but water pump ON.

- Heatpump THERMO ON TEMP:

- 1 Heatpump THERMO ON TEMP = Water inlet during thermo off time + $[-3^{\circ}\text{C}]$.
- 2 Heatpump ON back when water outlet temperature < Heatpump THERMO ON TEMP

iii. Case 3

- Heatpump THERMO OFF TEMP:

- 1 Water inlet temperature > 52°C for continuous 60 sec, heatpump OFF and water pump OFF

- Heatpump THERMO ON TEMP:

- 1 Heatpump THERMO ON TEMP = Water inlet during thermo off time + $[-3^{\circ}\text{C}]$.
- 2 Heatpump ON back when water outlet temperature < Tank temp. when heatpump thermo off + $[-3^{\circ}\text{C}]$
- 3 Heatpump only ON back after water outlet temperature < Heatpump THERMO ON TEMP & water pump ON for 3 minutes.

• Booster heater control

- 1 Booster heater turn On and OFF follow normal operation.
- 2 Booster heater turn ON condition:
 - During startup time (initialization), Booster heater turn ON after DELAY TIMER.
 - When tank temperature lower than HEATER ON TEMP
 - 20 minutes from previous heater off.
- 3 Booster heater turn OFF condition:
 - When tank temperature higher than tank set temperature for continuous 15 sec.

• Solar 3 way valve

- Solar pump operates follow solar operation specification.

• 2 ways valve control:

- 2 ways valve close

• Others

- Indoor backup heater cannot be On during tank mode only.

Solar Priority is Set

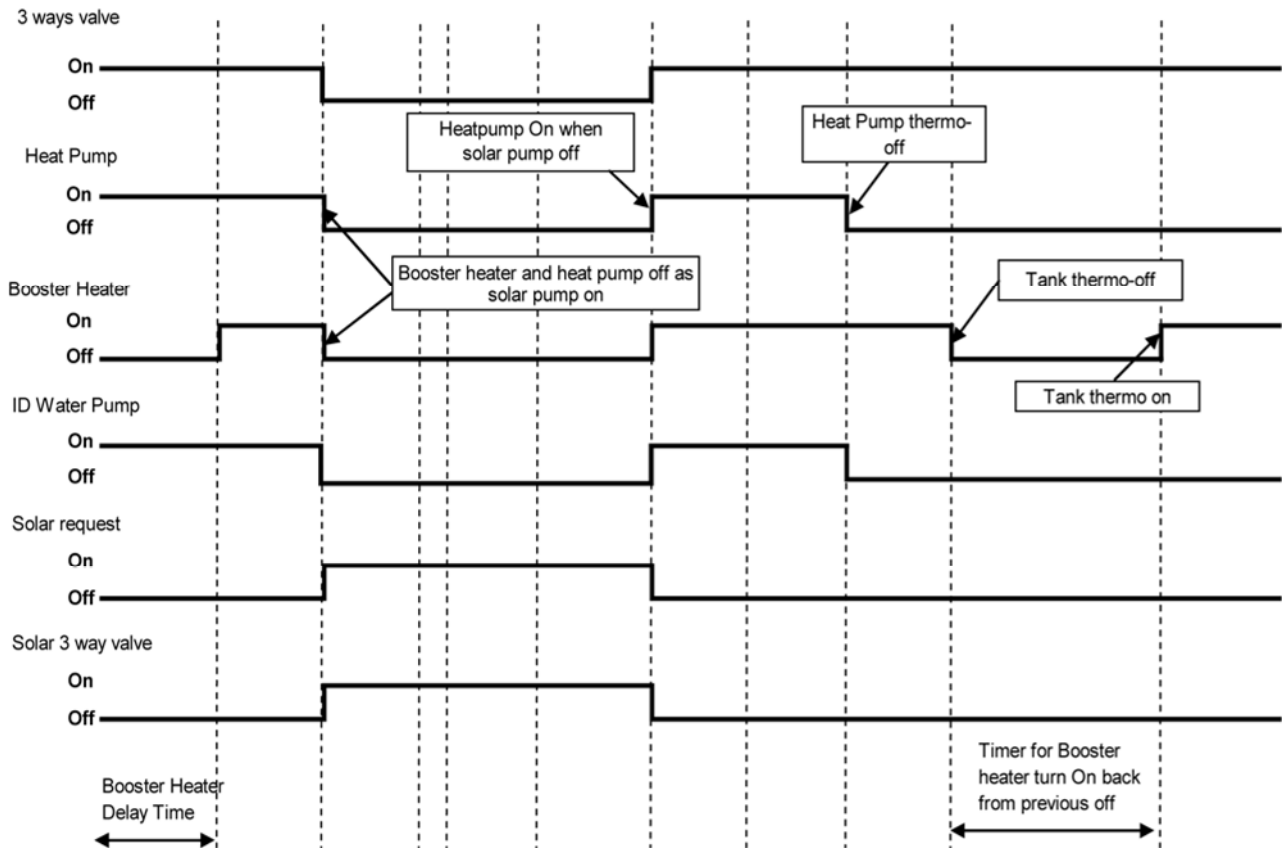

Solar Priority is Not Set

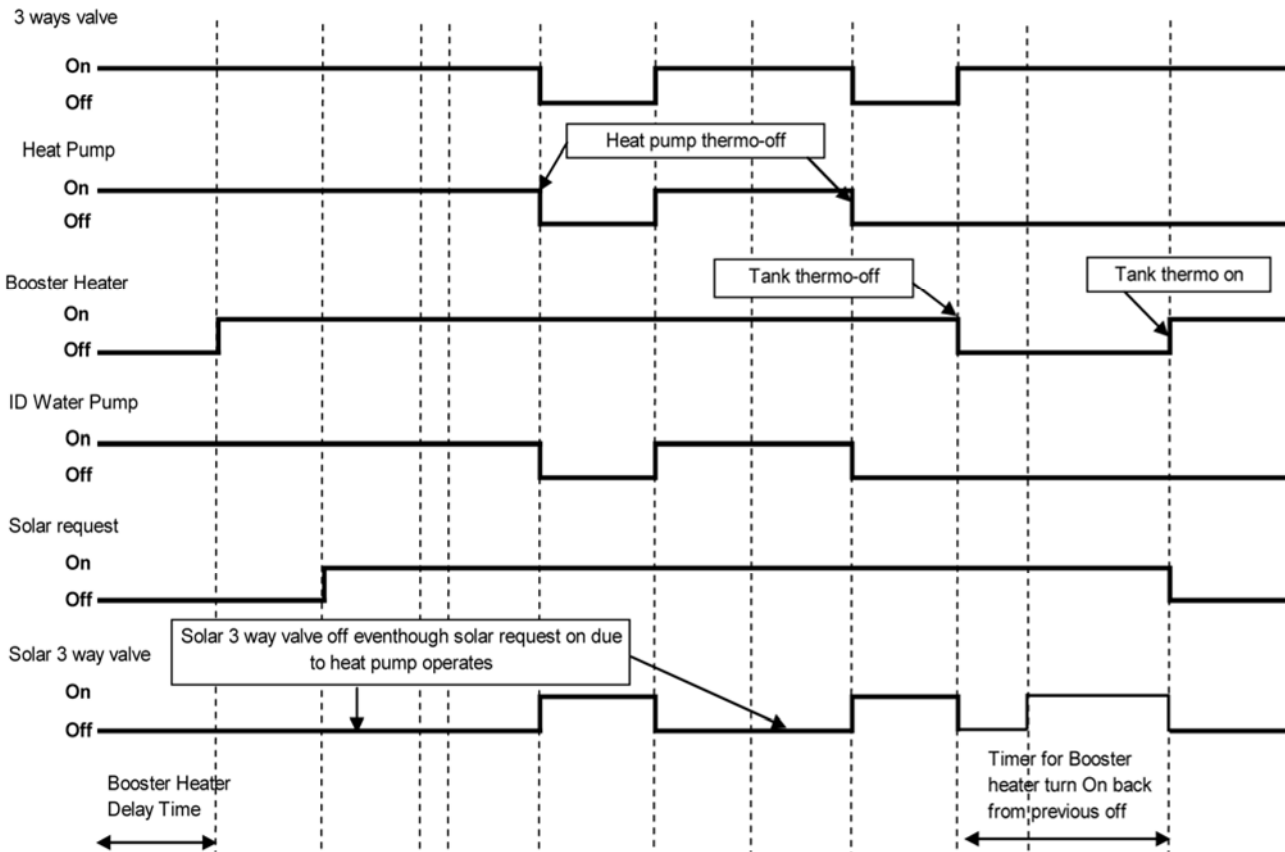

12.1.7 Heat + Tank Mode Operation

Setting 1: When Heating priority is set by control panel:

- 1 3 ways valve control:
 - 3 ways valve switch and fix to room side.
- 2 Heatpump operation control:
 - Heatpump operate follow normal operation
- 3 Backup Heater control:
 - Backup heater operate follow normal operation
- 4 Booster heater control:
 - Booster heater On/Off follow normal operation
- 5 Solar 3 way valve:
 - Solar 3 way valve operates follow solar operation specification.
- 6 2 ways valve control:
 - 2 ways valve opens.

* Under solar priority is set condition, when solar 3 way valve is ON, booster heater turn OFF

Setting 2: When heating priority is not set by control panel:

- When Solar Priority is set/not set by control panel:

- 1 3 ways valve control:
 - 3 ways valve switch to room side during heating heat-up interval, and switch to tank side during tank heat-up interval. Both mode will switch alternatively.
- 2 Heatpump operation control:
 - a. During heating heat-up interval
 - Follow normal heating operation.
Under solar priority set condition:
 - Always detect the tank temperature after heating heat-up interval. Switch only to tank heat-up interval and start counting tank heat-up timer when tank temperature < THERMO ON TEMP AND solar 3WV OFF
Under solar priority not set condition:
 - Always detect the tank temperature after heating heat-up interval. Switch only to tank heat-up interval and start counting tank heat-up timer when tank temperature < THERMO ON TEMP
 - * THERMO ON TEMP is defined form following Case1 to Case4.
 - b. During tank heat-up interval
 - Heatpump tank target temperature = Tank set temperature or [55°C] whichever lower
 - Heatpump Water Outlet set temperature is set to Maximum (55°C) during tank interval
 - Case 1:
 - THERMO OFF TEMP:
 1. THERMO OFF TEMP = Heatpump tank target temperature + [+2°C].
 2. Tank temperature > THERMO OFF TEMP for continuous 3 minutes, switch 3 ways valve to room side. End Tank heat-up interval and start count heating heat-up interval.
 - THERMO ON TEMP:
 1. THERMO ON TEMP = Heatpump tank target temperature + [-3°C].
 2. After Heating heat-up interval, always detect tank temperature. Switch to next tank heat-up interval when tank temperature < THERMO ON TEMP.

Case 2:

- Heatpump THERMO OFF TEMP:
 1. Heatpump THERMO OFF TEMP = 55°C + [+2°C].
 2. Water outlet temperature > Heatpump THERMO OFF TEMP for continuous 90 seconds, switch 3 ways valve to room side. End Tank heat-up interval and start count heating heat-up interval.
- THERMO ON TEMP:
 1. THERMO ON TEMP = Tank temp. when heatpump thermo off + [-3°C].
 2. After Heating heat-up interval, always detect tank temperature. Switch to next tank heat-up interval when tank temperature < THERMO ON TEMP.

Case 3:

- Heatpump THERMO OFF TEMP:
 1. Water inlet temperature > 52°C for continuous 60 sec, switch 3 ways valve to room side. End tank heat-up interval and start count heating heat-up interval.
- THERMO ON TEMP:
 1. THERMO ON TEMP = Tank temp. when heatpump thermo off + [-3°C].
 2. After Heating heat-up interval, always detect tank temperature. Switch to next tank heat-up interval when tank temperature < THERMO ON TEMP.

Case 4: (Only during solar priority is set condition)

- When solar pump ON, tank heat-up interval end early and 3 ways valve switch to room side.
- THERMO ON TEMP:
 1. THERMO ON TEMP = Heatpump tank target temperature + [-3°C].
 2. After Heating heat-up interval, always detect tank temperature. Switch to next tank heat-up interval when tank temperature < THERMO ON TEMP. and solar 3 way valve OFF.

3 Backup heater control:

- a. During heating heat up interval
 - Follow normal backup heater control operation.
- b. During tank heat-up interval
 - Backup heater OFF during this interval

4 Booster heater control:

- a. During heating heat-up interval.
 - Booster heater ON/OFF according to booster heater operation control
- b. During tank heat-up interval.
 - Once switch from heating heat-up interval to tank heat-up interval, turn off the booster heater and start counting the BOOSTER HEATER DELAY TIMER.
 - Booster heater turn ON after BOOSTER HEATER DELAY TIMER fulfil and tank temperature lower than tank set temperature.
 - BOOSTER HEATER DELAY TIMER is clear when switch to heating heat-up interval.

5 Solar 3 way valve

- Solar 3WV operates follow solar operation specification.

* Under solar priority is set condition, when solar 3WV is ON, booster heater turn OFF.

* Under solar priority is not set condition, solar 3WV only can ON during heating heat-up interval.

6 2 ways valve control:

- 2 ways valve opens.

Heat + Tank (Heating No Priority)
 (Solar Priority Set)

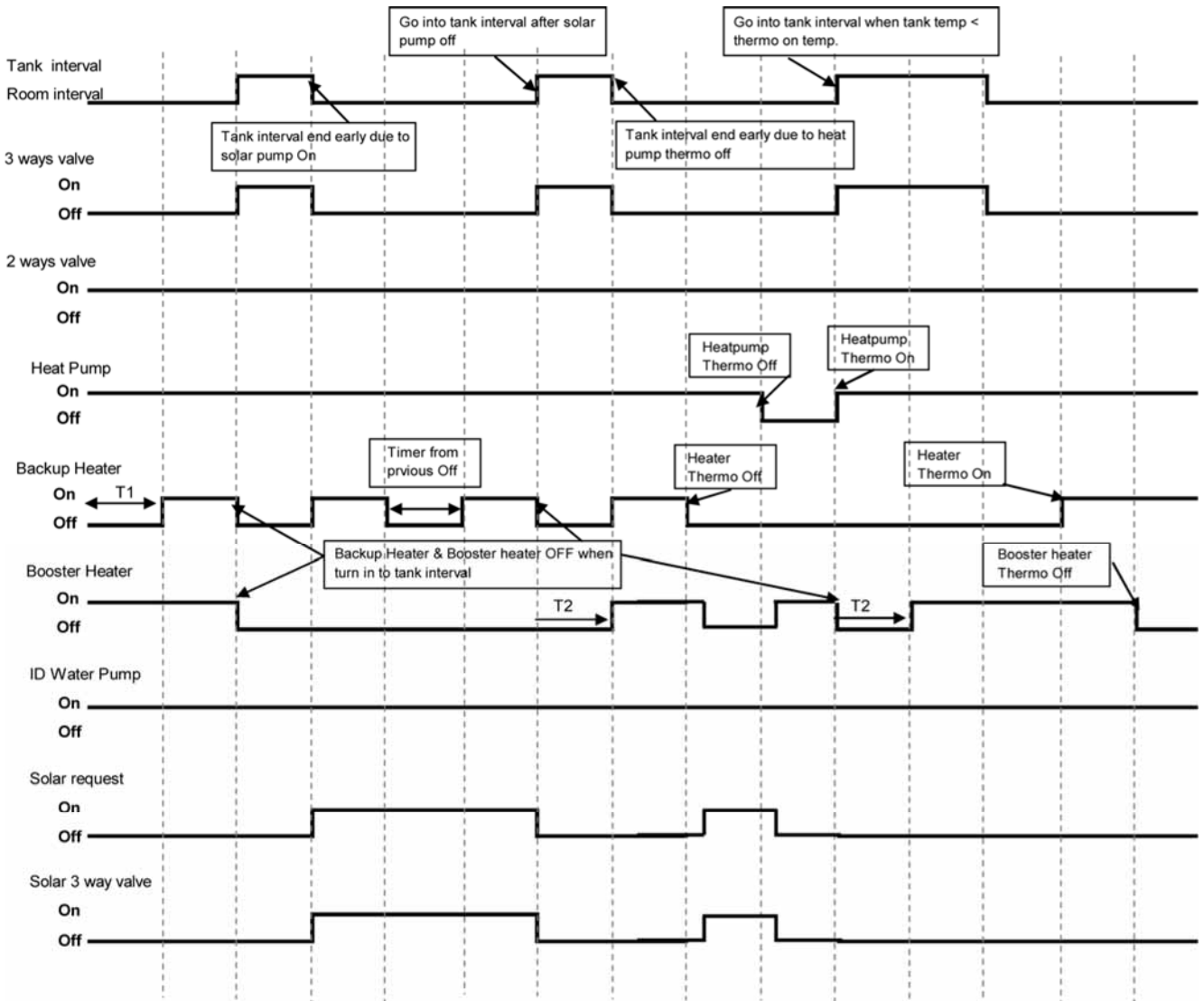

T1 - Backup heater delay on timer
 T2 - Booster heater delay on timer

Heat + Tank (Heating No Priority)
 (Solar Priority Not Set)

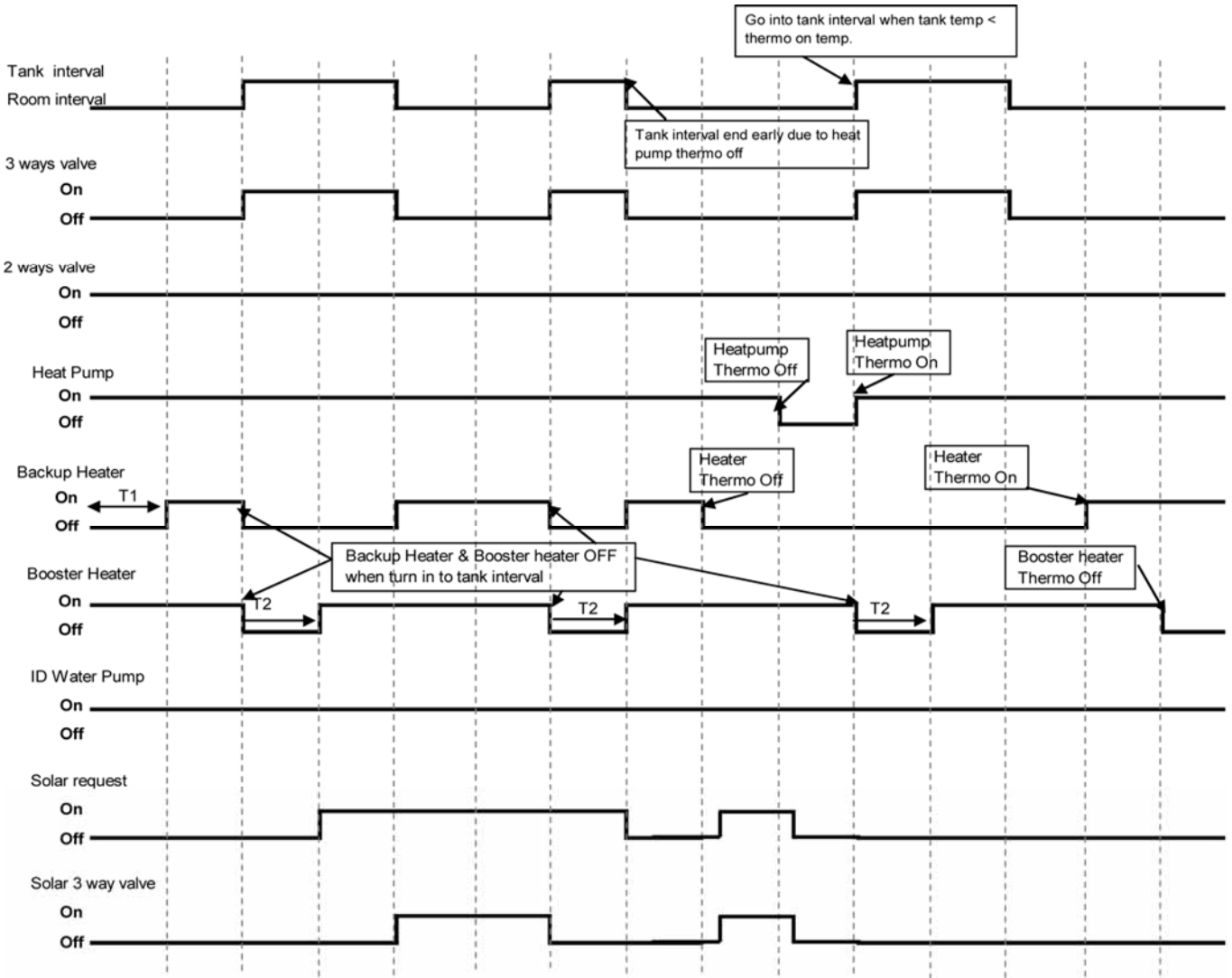

T1 - Backup heater delay on timer
 T2 - Booster heater delay on timer

12.1.8 Setting Water Outlet Temperature for Heat Mode

- The set temperature define the parameters for the outdoor ambient temperature dependent operation of the unit. Where by the internal water setting temperature is determined automatically depending on the outdoor temperature. The colder outdoor temperatures will result in warmer water and vice versa. The user has the possibility to shift up or down the target water temperature by control panel setting.

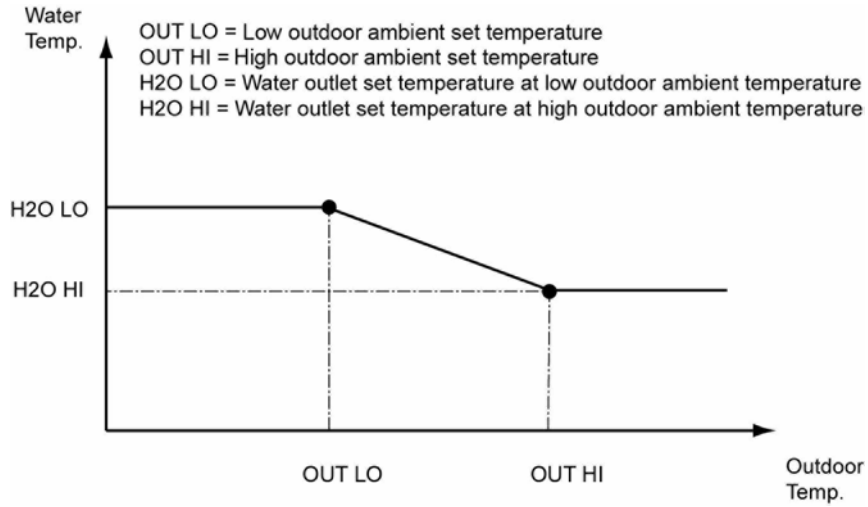

- Change in setting water outlet temperature is updated every 30 minutes.

12.1.8.1 Heating Mode Operation Time Chart

Exp:

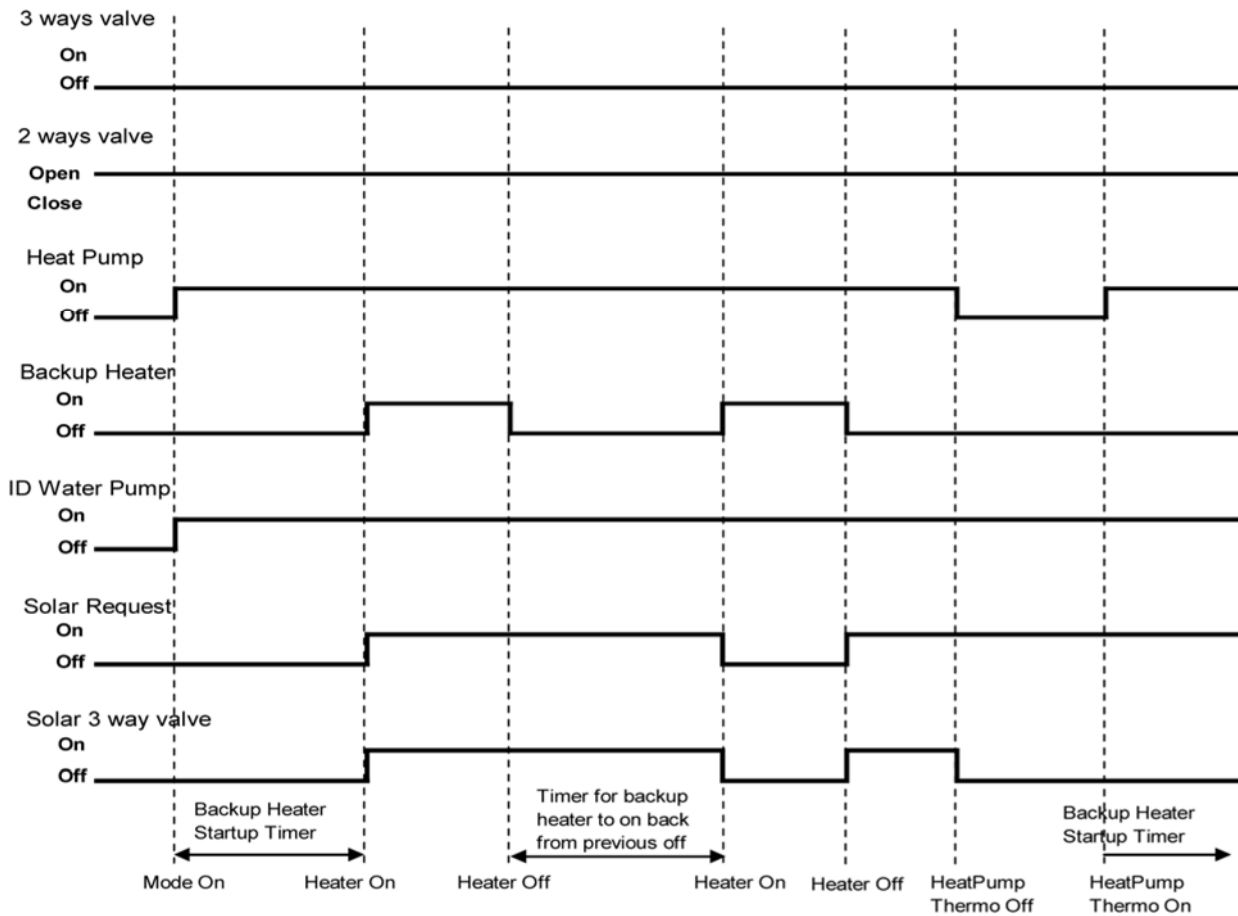

- 1 3 ways valve control:
 - 3 ways valve switch and fix to room side.
- 2 Heatpump operate follow normal heating operation.
- 3 Backup heater operate follow normal operation.
- 4 Solar 3 way valve operates follow solar operation specification
- 5 2 ways valve control:
 - 2 ways valve opens.

12.1.9 Water Temperature Thermo Shift Setting

- Switches are ignored during “PUMPDW” = ON.
- Switches are ignored during “STATUS” = ON.
- “▲”, “▼”, “SELECT” switch are ignored if “SETTING” = OFF.
- “CANCEL” switch is ignored if “SETTING” = OFF & “STATUS” = OFF.
- If “SET” Switch pressed for less than 5secs, immediately enter water temperature shift setting mode.
- Once enter this setting mode, “SETTING” display is ON.
This setting mode is used to easily shift the target water outlet temperature.

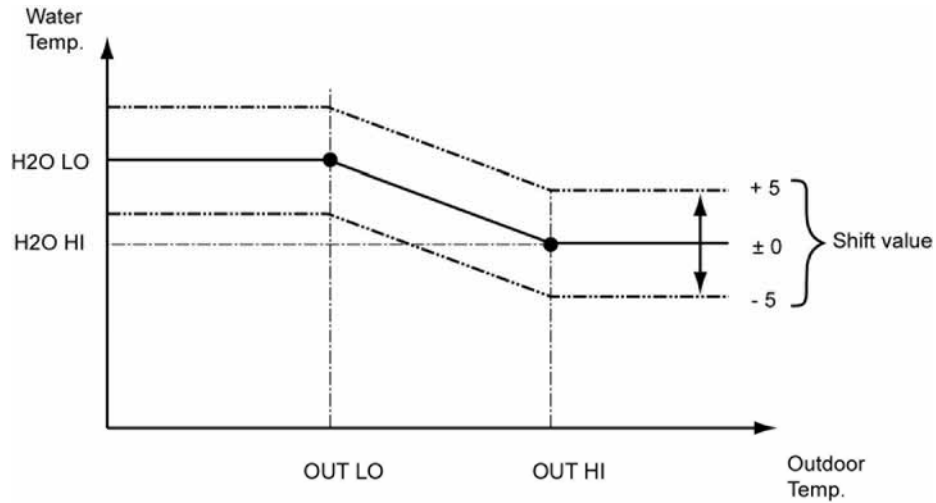

OUT LO = Low outdoor ambient set temperature
 OUT HI = High outdoor ambient set temperature
 H2O LO = Water outlet set temperature at low outdoor ambient temperature
 H2O HI = Water outlet set temperature at high outdoor ambient temperature
 Shift Value = Setting water temperature thermo shift

12.1.10 Outdoor Fan Motor Operation

Outdoor fan motor is adjusted according to operation condition. It starts when compressor starts operation and it stops 30 seconds after compressor stops operation.

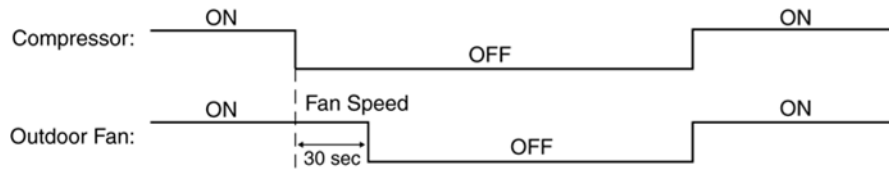

12.2 Water Pump

12.2.1 Water Pump Control

- 1 Once the indoor unit is ON, the water pump will be ON immediately and no error judgement for 9 minutes. However, during this 9 minutes operation, if there is any abnormality cause at outdoor or malfunction, the compressor should be OFF immediately and restart delay after 3 minutes.
- 2 The system will start checking on the water flow level after operation start for 9 minutes. If water flow level is detected low continuously for 1 minute, the water pump and compressor will be OFF permanently and OFF/ON control panel LED will blink (H62 error occurs).
- 3 The water pump will remain ON when compressor OFF due to thermostat OFF.

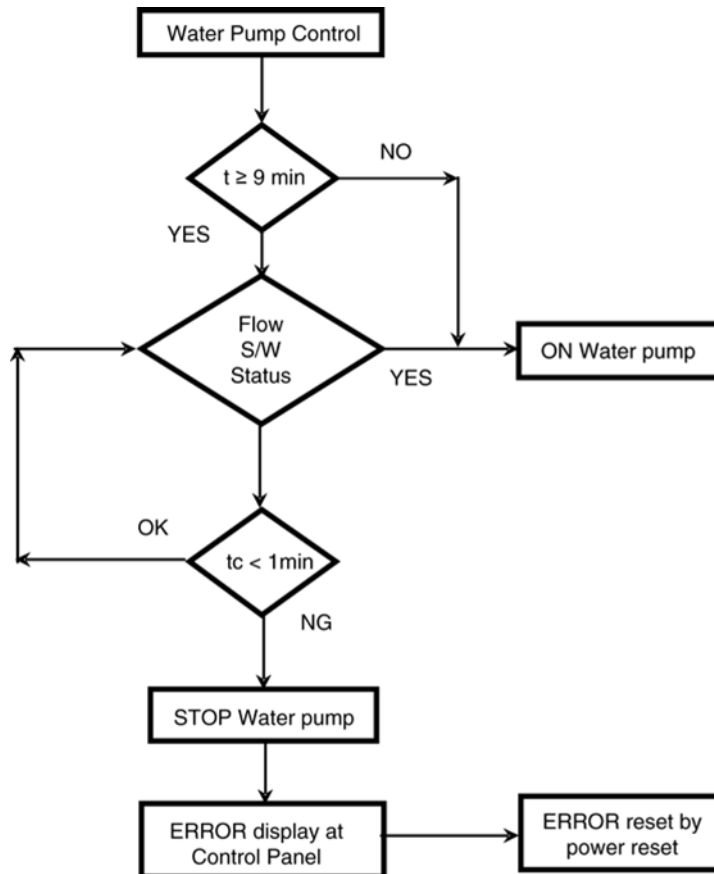

12.3 Pump Down Operation

Purpose

Ensure the pump down operation when relocating or disposing of the unit. The pump down operation will extract all refrigerant from the piping into the outdoor unit.

- 1 Make sure the OFF/ON control panel LED is OFF (no operation).
- 2 Press the Pump Down button to start the pump down operation.
- 3 No low pressure protection error during pump down operation and 3-way valve will be shift to heating side.
- 4 Press OFF/ON button to stop the pump down operation.

12.4 Flow Switch

12.4.1 Flow Switch Control

- 1 The water flow switch serve as an overload protector that shuts down the unit when the water level is detected to be low.
- 2 Detection is Lo (0V) when there is no water flow, and detection is Hi (5V) when there is water flow.

12.5 Force Heater Mode Operation

The backup heater also serves as backup in case of malfunctioning of the outdoor unit.

- 1 Make sure the OFF/ON control panel LED is OFF (no operation).
- 2 Press the Force button to start the force heater mode operation.
- 3 During force heater mode, all other operations are not allowed.
- 4 Press OFF/ON button to stop the force heater mode operation.

12.6 Indoor Unit Safety

12.6.1 Indoor Unit Safety Control

- 1 When water pump is ON, the system will start checking flow switch status (ON/OFF).
- 2 If the flow switch ON for 10 seconds, the system will check on the water inlet temperature for 10 seconds. If the water inlet temperature not exceeds 80°C, the water pump shall be continuously running with normal mode. If the water inlet temperature exceeds 80°C for continuously 10 seconds, the water pump will be OFF immediately.
- 3 After water pump OFF for more than 10 minutes, it will be ON back and the indoor unit safety control checking is restarted.

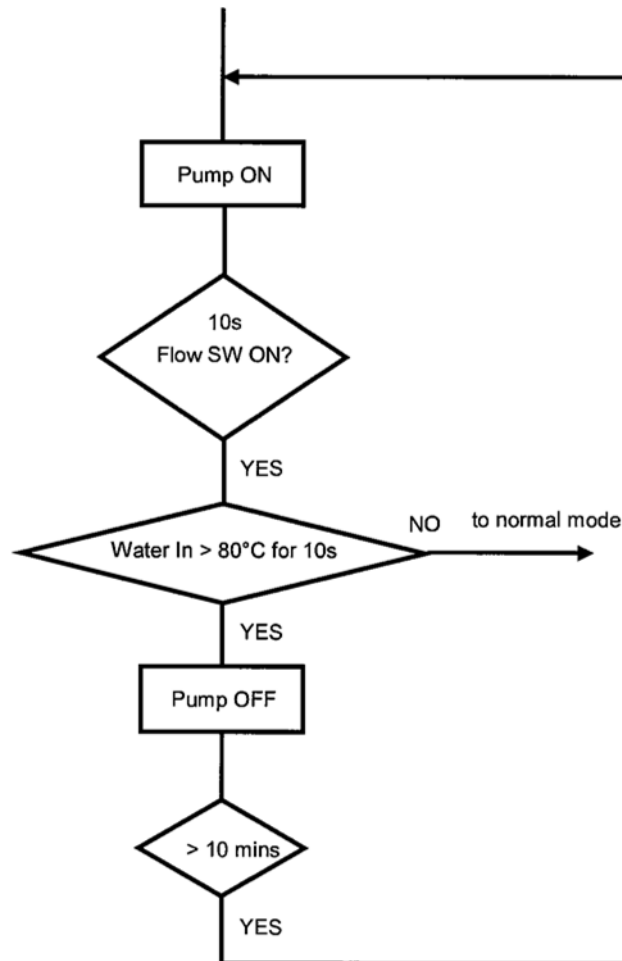

12.7 Auto Restart Control

- 1 When the power supply is cut off during the operation of Air-to-Water Heatpump, the compressor will re-operate after power supply resumes.

12.8 Indication Panel

LED	Operation
Color	Green
Light ON	Operation ON
Light OFF	Operation OFF

Note:

- If Operation LED is blinking, there is an abnormality operation occurs.

12.9 Indoor Back-Up Heater Control

12.9.1 Indoor Electric Heater Control

- 1 Normal Heating Mode
 - Heater On condition:
 - a. Heater switch is ON
 - b. After Heatpump thermo ON for **[30]** mins
 - c. After water pump operate **[9]** mins
 - d. Outdoor air temperature < Outdoor set temperature for heater
 - e. When water outlet temperature < Water set temperature + **[-8°C]**
 - f. **[20]** minutes since previous Backup heater Off
 - * When heatpump cannot operate due to error happens during normal operation, heater will go into force mode automatic
 - * Heater need to operate during deice operation
 - Heater Stop Condition:
 - a. When outdoor set temperature > outdoor set temperature + **[+2°C]** for continuous 15 secs OR
 - b. When water out temp > water set temperature + **[-2°C]** for continuous 15 secs OR
 - c. Heater switch is Off OR
 - d. Heatpump thermo-off or OFF condition
 - 2 Force Heater Mode
 - Heater On condition:
 - a. After water pump operate **[9]** mins
 - b. When water outlet temperature < water set temperature + **[-8°C]**
 - c. **[20]** minutes since previous Backup heater Off
 - Heater Stop condition
 - a. Force mode off **OR**
 - b. When water outlet temperature > water set temperature + **[-2°C]** for continuous 15 secs
- * Do not operate heater at the following situation
- 1 Water outlet temperature sensor, and water inlet sensor abnormal
 - 2 Flow switch abnormal
 - 3 Circulation pump stop condition
 - 4 During Heatpump switch to tank side

12.10 Tank Booster Heater Control

12.10.1 Tank Booster Heater Control

Heating operation condition:

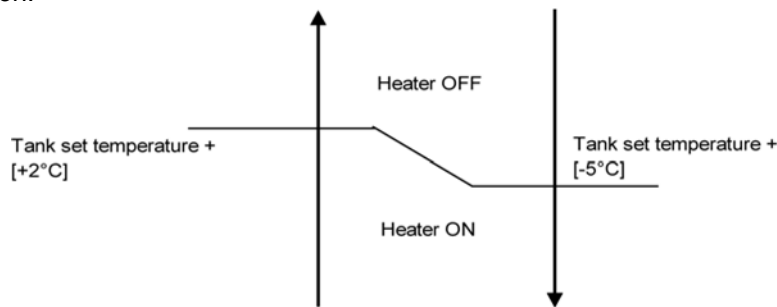

- 1 Booster heater Turn On condition:
 - After BOOSTER HEATER DELAY TIMER fulfil during heatpump startup time in tank mode, or during switching from heating heat-up interval to tank heat-up interval in heat+tank mode (heating priority not set).
 - Tank temperature < Tank set temperature + [-5°C],
 - 20 minutes since previous heater off.

* BOOSTER HEATER DELAY TIMER is clear when tank heat-up interval end.
- 2 Booster heater Turn Off condition:
 - Tank temperature > Tank set temperature + [+2°C] for continuous 15 sec
 - When BOOSTER HEATER DELAY TIMER start count after switch from heating heat-up interval to tank heat-up interval

* DELAY TIMER can be set by control panel.

12.11 Three Way Valve Control

- Purpose:
 - 3 ways valve is used to change flow direction of hot water from heatpump between heating side and tank side
- Control contents:
 - 1 3 ways valve switch Off:
 - During 3 ways valve switch Off time, the hot water will provide heat capacity to heating side.
 - 2 3 ways valve switch On:
 - During 3 ways valve switch On time, the hot water will provide heat capacity to tank side.
 - 3 Stop condition:
 - During stop mode, 3 ways valve will be in switch off position

12.12 Sterillization Mode

- 1 During sterillization mode, tank will be heat up to the sterillize set temperature for a certain period of time, also set by controller.
- 2 The function can only be set on timer to operate once in a week.
- 3 It will be cancelled even when the temperature is not reached after 4 hours.
- 4 When tank mode is OFF or disabled, sterillization is cancelled.

12.13 Quiet Operation

- Purpose:
 - To provide quiet operation compare to normal operation by reduces outdoor unit noise.
- Starting condition:
 - 1 When quiet button is presses.
 - 2 When quiet request ON time by weekly timer (Refer to control panel.)
- When any of above mentioned condition is achieved, this control is activated.
 - New target FM speed = Present target FM speed - 80 rpm
 - Minimum target FM speed = 200 rpm
- Cancellation condition:
 - 1 Cancel by press quiet button
 - 2 Stop by OFF/ON button
 - 3 When quiet request OFF time by weekly timer
 When any of above mentioned condition is achieved, this control is cancelled.

12.14 Solar Operation (Optional)

12.14.1 Solar Operation:

- Control according to preset whether solar priority is set or not.
- When tank connection is NOT set at SETTING mode, solar operation is disabled.
- When Pump A (from solar pump station) is detected On through connection Y3 and Y4, then the Solar pump 3 Way Valve is requested ON (refer to figure below).

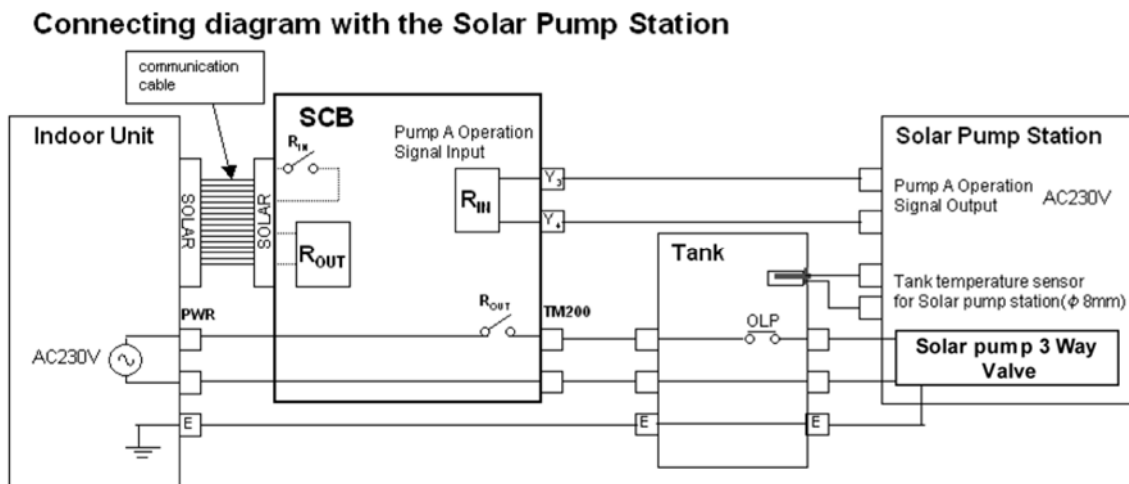

12.14.2 Solar Operation Control

When solar priority is SET

- 1 Operation condition:
 - Solar pump operates if all of the following conditions are fulfilled:
 - i) Power On. (regardless operation ON or OFF)
 - ii) There is operation request from solar pump station.
 - iii) Tank hot water temp is below solar on upper limit temp [EEPROM 1 : 70]°C.
- 2 Stop condition:
 - Solar pump stops operating when:
 - i) No power supply to unit **OR**
 - ii) There is **NO** operation request from solar pump station **OR**
 - iii) Tank hot water temp is above solar off upper limit temp [EEPROM 2 : 77]°C.

- * heatpump OFF OR operate to room side when solar pump operate during solar priority set
- * booster heater OFF when solar pump operate during solar priority set

When solar priority is NOT SET

- 1 Operation condition:
 - Solar pump operates if all of the following conditions are fulfilled:
 - i) Power On. (regardless operation ON or OFF)
 - ii) There is operation request from solar pump station.
 - iii) Tank hot water temp is below solar on upper limit temp [EEPROM 1 : 70]°C.
 - iv) Heatpump thermo OFF in tank mode OR Heatpump operate to room side. (during operation ON and tank mode selected)
- 2 Stop condition:
 - Solar pump stops operating when:
 - i) No power supply to unit **OR**
 - ii) There is **NO** operation request from solar pump station **OR**
 - iii) Tank hot water temp is above solar off upper limit temp [EEPROM 2 : 77]°C.
 - iv) Heatpump thermo ON and operate to tank side. (during operation ON and tank mode selected)

Heat + Tank Mode (Heating Priority Not Set)

(Solar Priority Set)

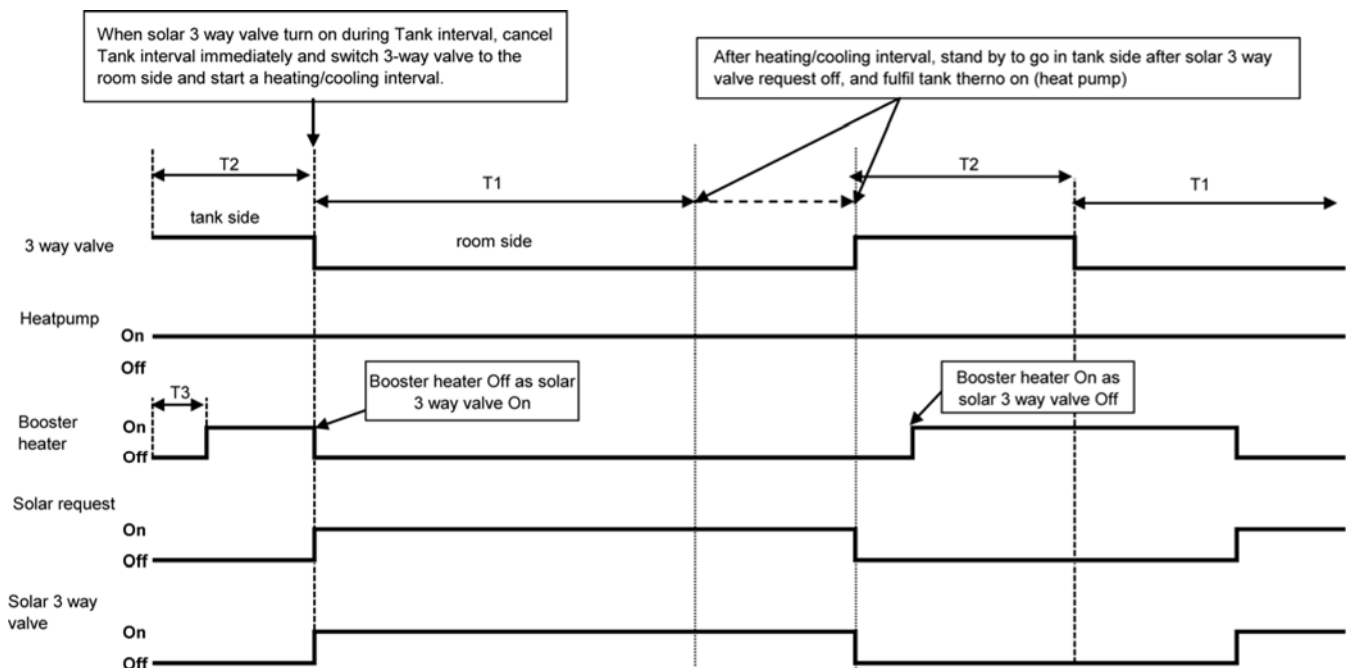

(Solar Priority Not Set)

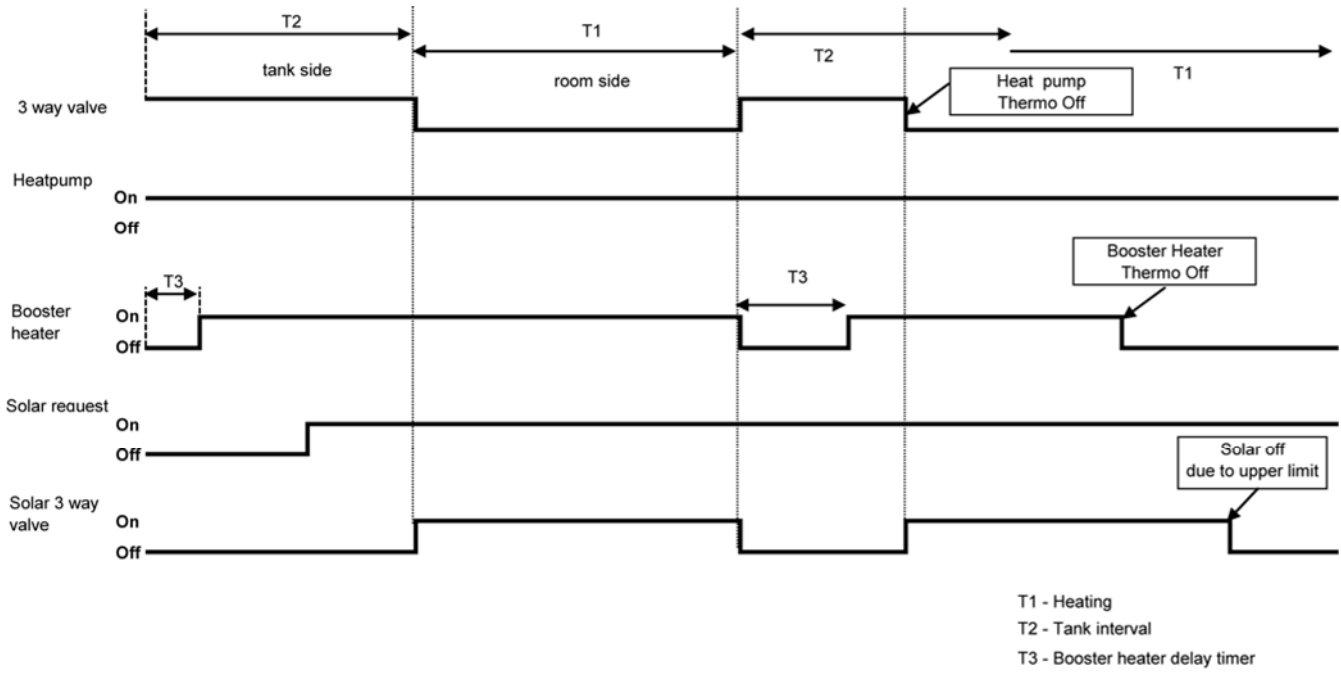

Heat + Tank Mode (Heating Priority Set)

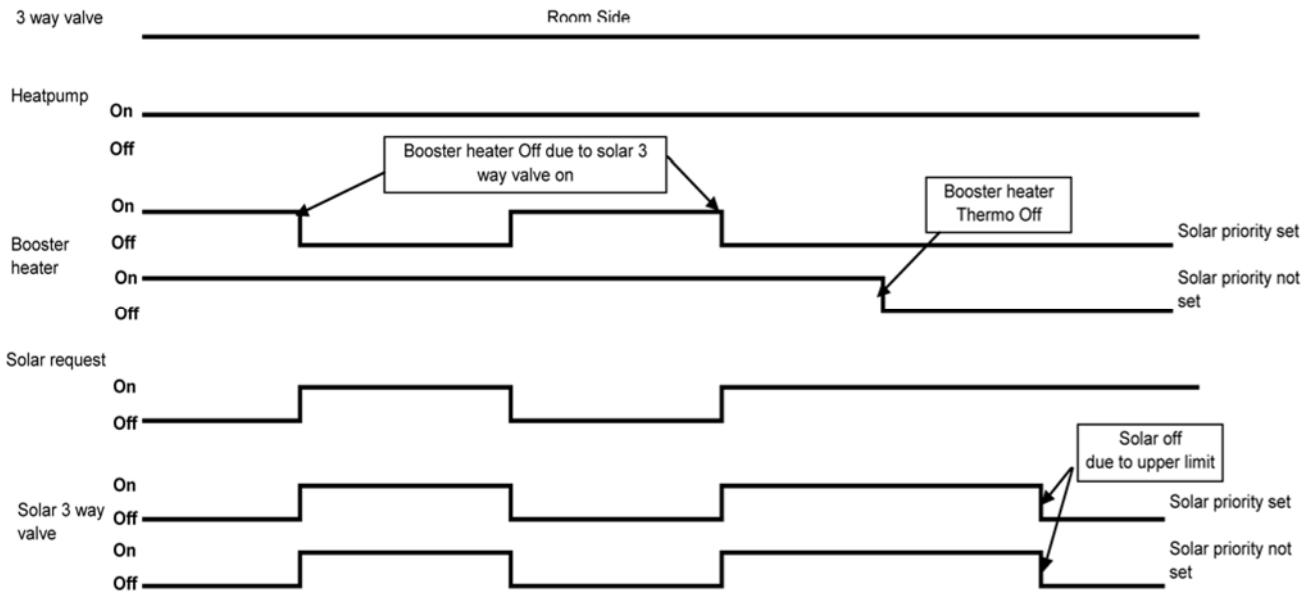

Tank Mode
(Solar Priority Set)

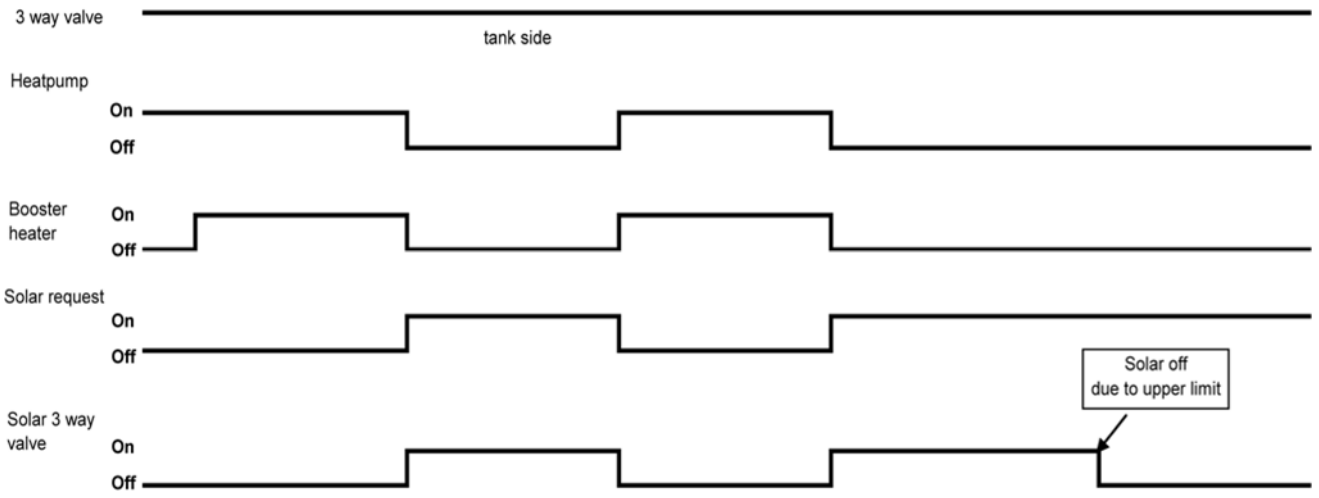

(Solar Priority Not Set)

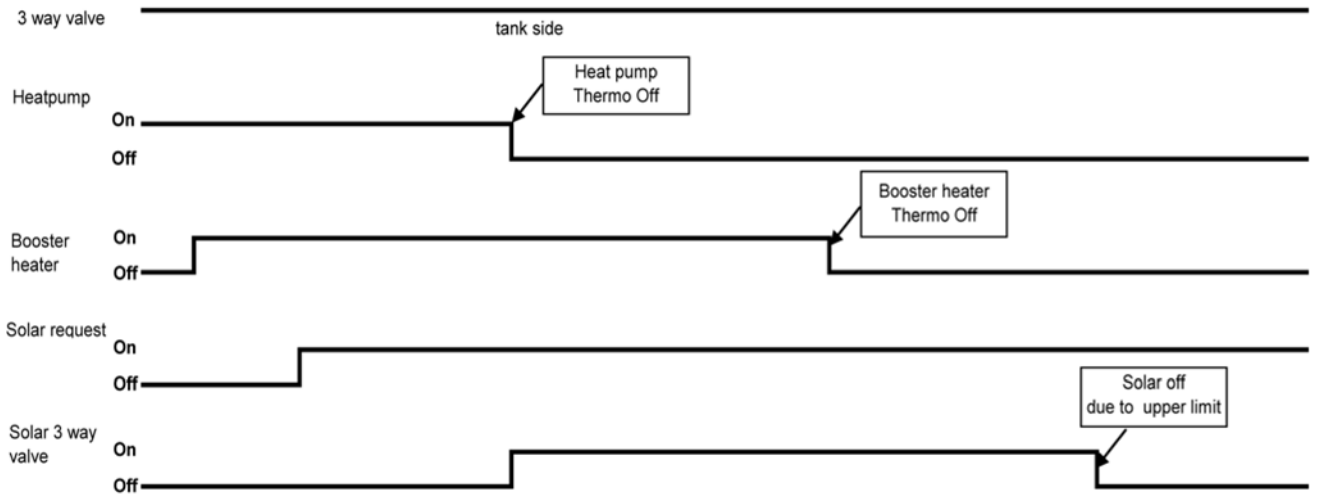

12.15 External Room Thermostat Control (Optional)

Purpose:

- Better room temperature control to fulfil different temperature request by external room thermostat.

Recommended external room thermostat:

Maker	Characteristic
Siemem (REV200)	Touch panel
Siemem (RAA200)	Analog

Connection external room thermostat:

Wire Connection and thermo characteristic of Siemen REV200:

Setting	L/L1 (H)	Heat Thermo	L/L2 (C)	Cool Thermo
Set Temp < Actual Temp	Open Circuit	OFF	Short Circuit	ON
Set Temp > Actual Temp	Short Circuit	ON	Open Circuit	OFF

* Siemen REV200 thermostat must fix to default mode or heat mode selection.

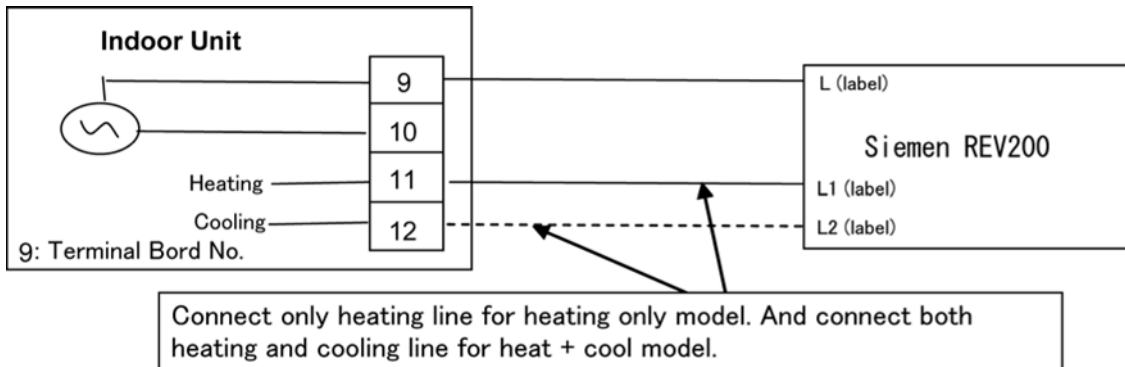

Wire Connection and thermo characteristic of Siemen RAA20:

Setting	L/Y1 (H)	Heat Thermo	L/Y2 (C)	Cool Thermo
Set Temp < Actual Temp	Open Circuit	OFF	Short Circuit	ON
Set Temp > Actual Temp	Short Circuit	ON	Open Circuit	OFF

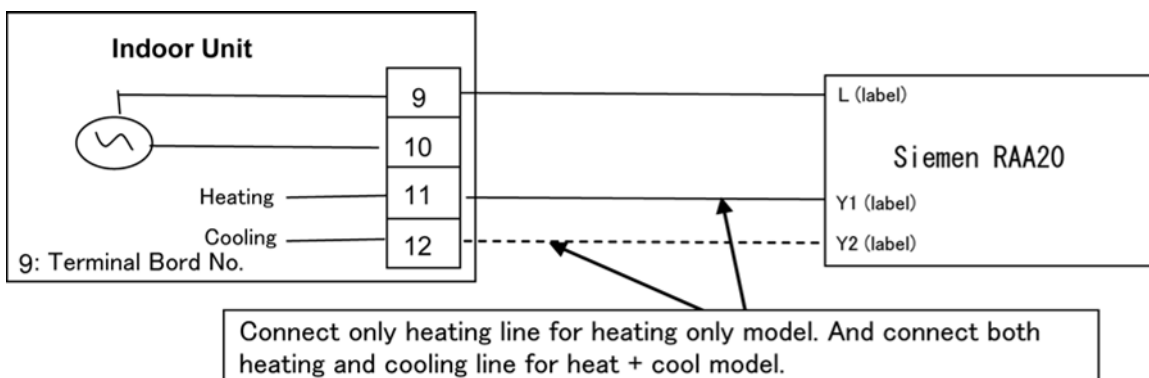

Control Content:

- External room thermostat control activate only when remote thermostat connection select YES by Indoor control panel.
- When indoor running heat mode, refer thermo On/Off from heating line feedback. And when indoor running cool mode, refer thermo On/Off from cooling line feedback.
- Heatpump Off immediately when receive thermo off feedback.

12.16 Two Ways Valve Control

Functionality of 2 ways valve:

- Use to allow hot water to floor heating panel or block cold water to floor heating panel.

Control contents:

- 1 When indoor running in heat mode, OPEN the 2 ways valve.
- 2 When indoor running in cool mode, CLOSE the 2 ways valve.
- 3 Stop condition:
 - a. During stop mode, fix 2 ways valve in close condition.

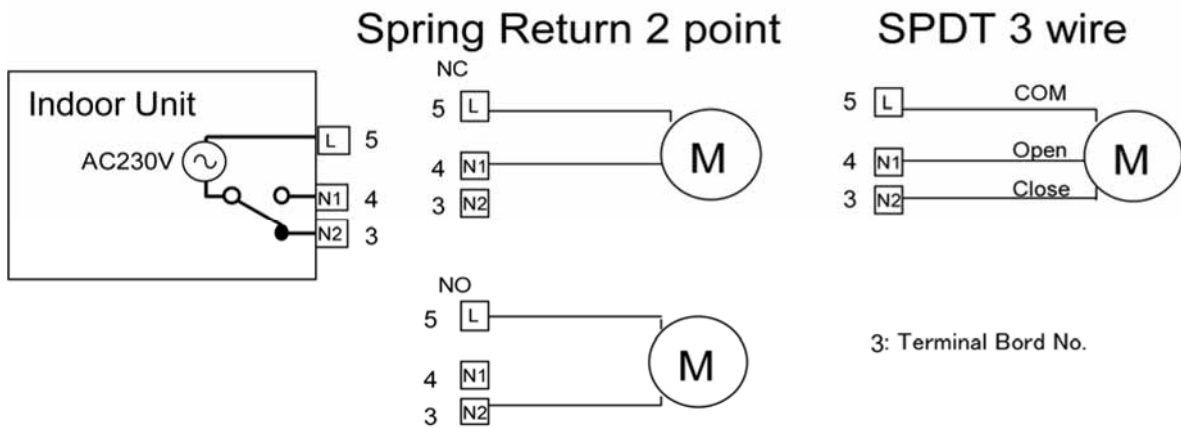

* During pump down mode, fix 2 ways valve in close condition.

* During force mode, open 2 ways valve.

* Recommended Parts : SFA 21/18 (Siemens)

13. Protection Control

13.1 Protection Control for All Operations

13.1.1 Time Delay Safety Control

- 1 The compressor will not start for three minutes after stop of operation.

13.1.2 30 Seconds Forced Operation

- 1 Once the compressor starts operation, it will not stop its operation for 30 seconds.
- 2 However, it can be stopped using control panel at indoor unit.

13.1.3 Total Running Current Control

- 1 When the outdoor running current exceeds X value, the compressor frequency will decrease.
- 2 If the outdoor running current does not exceed X value, the compressor frequency will return to normal operating frequency.
- 3 If the outdoor running current continue to increase till exceed Y value, compressor will stop, and if this occurs 3 times within 20 minutes, system will stop operation and OFF/ON control panel LED will blink (F16 error occurs).

Operation Mode	09C		12C		14C		16C	
	X (A)	Y (A)	X (A)	Y (A)	X (A)	Y (A)	X (A)	Y (A)
Heating	6.2	10.6	7.4	10.6	8.0	10.6	8.5	10.6
Cooling	6.3	10.6	6.6	10.6	7.9	10.6	8.5	10.6

13.1.4 IPM (Power Transistor) Prevention Control

A. Overheating Prevention Control

- 1 When the IPM temperature rises to 95°C, compressor will stop immediately.
- 2 Compressor will restart delay 3 minutes when the IPM temperature decreases to 90°C.
If this condition repeats continuously 3 times within 30 minutes, system will stop operation and OFF/ON control panel LED will blink (F22 error occurs).

B. DC Peak Current Control

- 1 When the current to IPM exceeds set value of 40.1 ± 5.0 A (UD09CE), 44.7 ± 5.0 A (UD12CE, UD14CE and UD16CE), compressor will stop. Compressor will restart after three minutes.
- 2 If the set value exceeds again for more than 30 seconds after the compressor restarts, operation will restart after two minutes.
- 3 If the set value exceeds again for within 30 seconds after the compressor restarts, operation will restart after one minute. If this condition repeats continuously for seven times, system will stop operation and OFF/ON control panel LED will blink (F23 error occurs).

13.1.5 Compressor Overheating Prevention Control

- The compressor operating frequency is regulated in accordance to compressor tank temperature as shown in below figures. When the compressor tank temperature exceeds 112°C, compressor will stop, and if this occurs 4 times within 30 minutes, system will stop operation and OFF/ON control panel LED will blink (F20 error occurs).

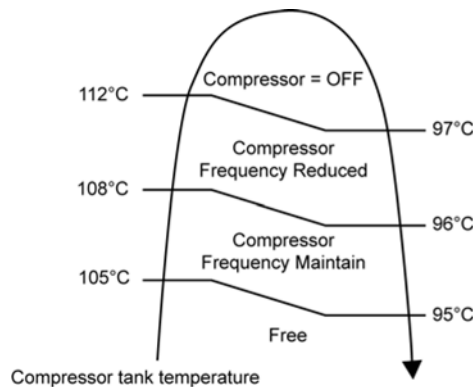

13.1.6 Low Frequency Protection Control 1

- When the compressor continuously operates at frequency lower than 25 Hz for 240 minutes, the operation frequency will change to 24 Hz for 2 minutes.

13.1.7 Low Frequency Protection Control 2

- When all the below conditions comply, the minimum compressor frequency will change to lower frequency.

Temperature, T, for:	Heating	Cooling
Outlet water (°C)	$T < 14$ or $T \geq 48$	$T < 14$ or $T \geq 30$
Outdoor air (°C)	$T < 4$ or $T \geq 24$	$T < 13$ or $T \geq 38$
Indoor heat exchanger (°C)	$T \geq 0$	$T < 30$

13.1.8 High Pressure Sensor Control

- Purpose:
 - To protect the system operation.
- Detection period:
 - After compressor on for 5 minutes.
- Detection conditions:
 - When abnormal high voltage detection, 5V or when open circuit detection 0V for 5 seconds continuously.
- After detection:
 - When abnormality is detected continue 5 seconds, unit stop operation.
 - OFF/ON control panel LED will blink (H64 error occurs).

13.1.9 Outside Temperature Current Control

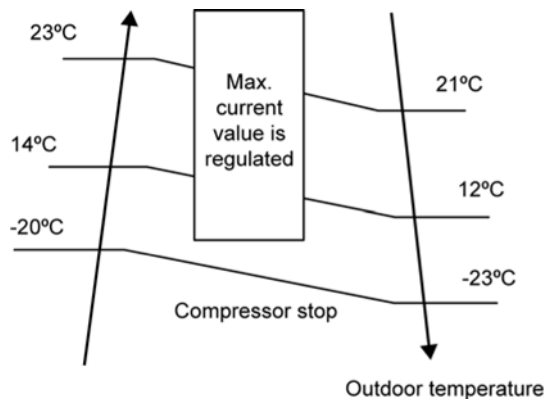

13.1.10 Crank Case Heater Control

- Purpose:
 - For compressor protection during low outdoor ambient operation (during heating low temperature operation).
- Control content:
 - a. Trigger heater START condition
 - When the outdoor air temperature is 4°C or below, and discharge temperature is 11.6°C or below.
 - b. Resetting heater STOP condition
 1. When the outdoor air temperature exceeds entry condition (6°C)
 2. When the discharge temperature exceeds entry condition (18.8°C)

13.2 Protection Control for Heating Operation

13.2.1 Outdoor Air Temperature Control

The maximum current value is regulated when the outdoor air temperature rises above 14°C in order to avoid compressor overloading.

13.2.2 Deice Operation

When outdoor pipe temperature and outdoor air temperature is low, deice operation start where outdoor fan motor stop.

13.3 Protection Control for Cooling Operation

13.3.1 Outdoor Air Temperature Control

- The Compressor operating frequency is regulated in accordance to the outdoor air temperature as shown in the diagram below.
- This control will begin 1 minute after the compressor starts.
- Compressor frequency will adjust base on outdoor air temperature.

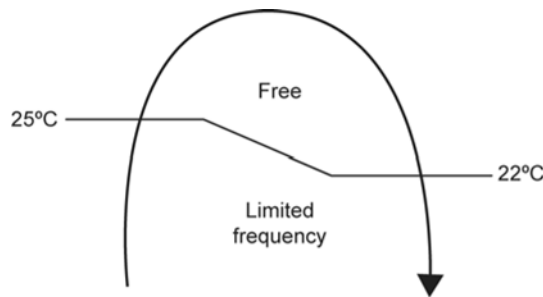

13.3.2 Freeze Prevention Control 1

- 1 When indoor heat exchanger temperature is lower than 0°C continuously for 10 seconds, compressor will stop operating.
- 2 Compressor will resume its operation three minutes after the indoor heat exchanger is higher than 1°C.
- 3 Indoor heat exchanger freeze prevention (H99) will memory in error history.

14. Servicing Mode

14.1 Test Run

- 1 Fill up the boiler tank with water. For details refer to boiler tanks installation instruction and operation instruction.
- 2 Set ON to the indoor unit and RCCB. Then, for control panel's operation please refers to air-to-water heatpump's operation instruction.
- 3 For normal operation, pressure gauge reading should be in between 0.05 MPa and 0.2 MPa. If necessary, adjust the water pump speed accordingly to obtain normal water pressure operating range. If adjust water pump speed cannot solve the problem, contact your local authorized dealer.
- 4 After test run, please clean the external filter. Reinstall it after finish cleaning.

14.2 Proper Pump Down Procedure

- 1 Make sure the OFF/ON control panel LED is OFF (no operation).
- 2 Press the "PUMPDW" switch on control panel to begin PUMP DOWN mode. Operate the system in PUMP DOWN mode for 10 ~ 15 minutes.
- 3 After 10-15 minutes, (after 1 or 2 minutes in case very low ambient temperatures ($< 10^{\circ}\text{C}$)), fully close 3 way valve (Liquid Side).
- 4 After 3 minutes, fully close 3 way valve (Gas Side).
- 5 Press the "OFF/ON" switch on control panel to stop PUMP DOWN mode.
- 6 Remove the refrigerant piping.

14.3 How to Adjust Water Flow Rate

- Before adjust the water flow rate, make sure that the total water volume in the installation is 30 litres minimum (UD09CE) and 50 litres minimum (UD12CE, UD14CE & UD16CE).
- The water flow rate can be adjusted with select the water pump speed on the water pump. The default setting is moderate speed (II). Adjust it to high speed (III) and slow speed (I) if necessary (e.g. reduce the noise of running water).

Below graph shown the external static pressure (kPa) versus water flow rate (l/min).

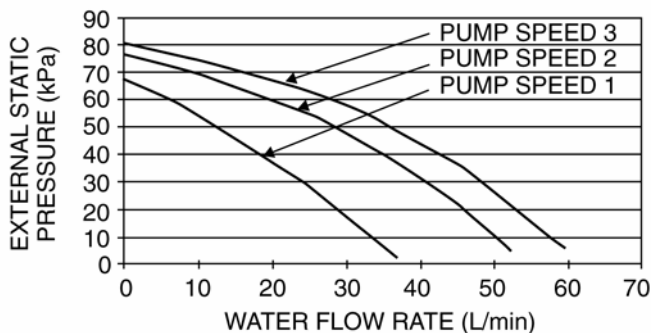

- Flow rate characteristic of indoor unit is as per above mentioned.

14.4 Expansion Vessel Pre Pressure Checking

- Expansion Vessel with 10L air capacity and initial pressure of 1 bar is installed in this indoor unit.
- Total amount of water in system should be below 200L.
(Note: This amount of water is not include the tank unit volume)
- If total amount of water is over 200L, please add expansion vessel.
- Please keep the installation height difference of system water circuit within 7m.
(Inner volume of same indoor unit is about 5L)

15. Maintenance Guide

In order to ensure optimal performance of the unit, checks and inspections on the unit and the field wiring must be carried out regularly. Please request a licensed technician for carry out maintenance job.

Before carried out any maintenance or repair work, and removing the front plate of heat exchanger unit, always switch off all power supply (i.e. indoor unit power supply, heater power supply and sanitary tank power supply). Below checks must be carried out at least once a year.

1 Water pressure

Water pressure should not lower than 0.05 MPa (with inspects the pressure gauge). If necessary add tap water into boiler tank. Refer to boiler tank installation instruction for details on how to add water.

2 Pressure relief valve

- Check for correction operation of pressure relief valve by turn up the lever to become horizontal. (Refer to figure below)
- If you do not hear a clacking sound (due to water drainage), contact your local authorized dealer.
- Turn down the lever after checking finish.
- In case the water keeps drained out from the unit, switch off the system, and then contact your local authorized dealer.

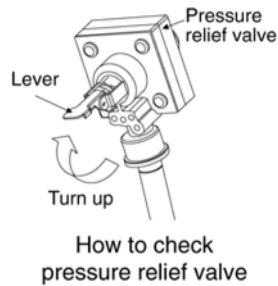

3 Indoor unit control board area

Thorough visual inspection of the control board and look for defects, i.e. loose connection, melting of wire insulator and etc.

4 RCCB

Ensure the RCCB set to “ON” condition before check RCCB.
Turn on the power supply to the indoor unit.

This testing could only be done when power is supplied to the indoor unit.



WARNING

Be careful not to touch parts other than RCCB test button when the power is supplied to Indoor Unit. Else, electrical shock may happen.

- Push the “TEST” button on the RCCB. The lever would turn down and indicate “0” and indicate green colour if it functions normal.
 - Contact authorized dealer if the RCCB malfunction.
 - Turn off the power supply to the indoor unit.
 - If RCCB functions normal, set the lever to “ON” again after testing finish.
- ### 5 How to release the trapped air in water circuit
- Turn up the lever to become horizontal. (Refer to figure “Pressure relief valve”). The trapped air will be drained out together with water. After few seconds, turn down the lever to stop the water drainage.
 - Repeat it until the bubbling sound disappear.

6 Reset overload protector

Overload protector serves the safety purpose to prevent the water over heating. When the overload protector trip at high water temperature, take below steps to reset it.

- a. Take out OLP cover.
- b. Use a test pen to push the centre button gently in order to reset the overload protector.
- c. After finish, install back the overload protector following the reverse order of step a & b.

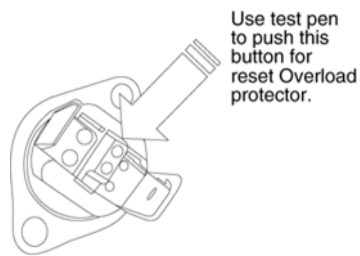

Use test pen to push this button for reset Overload protector.

How to reset Overload protector

7 External water filter (field supply)

Clean the external water filter in regularly basic.

- External water filter is located inside the tube connector which is before water inlet connector of indoor unit (indicated with "WATER IN"). (Refer to figure below)
- Use spanner to detach the tube connector nut.
- Take out the filter carefully so that not deforms it shape.
- Use tap water only to wash the residue on the filter. If necessary, gently use soft brush only to clean the hard dirt.
- After clean, put it back to the original location and tighten the nut connection with torque wrench.

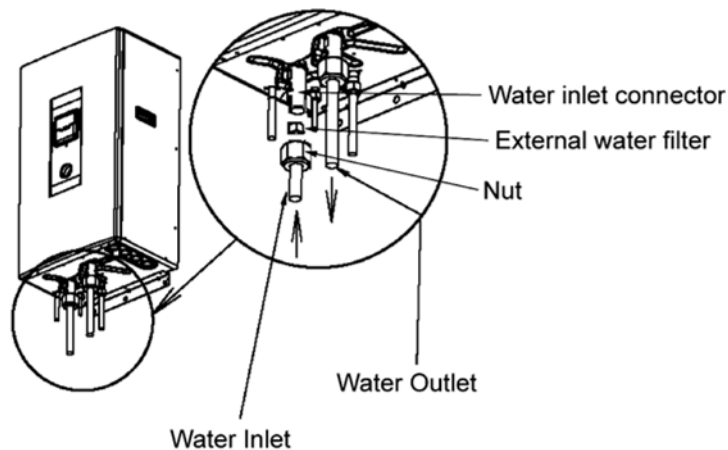

Location of external water filter

16. Troubleshooting Guide

16.1 Refrigeration Cycle System

In order to diagnose malfunctions, make sure that there are no electrical problems before inspecting the refrigeration cycle. Such problems include insufficient insulation, problem with the power source, malfunction of a compressor and a fan. The normal pressure of the refrigeration cycle depends on various conditions, the standard values for them are shown in the table on the right.

Normal Pressure (Standard)

	Gas pressure MPa (kg/cm ² G)
Heating Mode	2.3 ~ 2.9 (23 ~ 29)
Cooling Mode	0.9 ~ 1.2 (9 ~ 12)

- ★ Condition:
- Outdoor temperature 7°C at heating mode and 35°C at cooling mode.
 - Compressor operates at rated frequency.

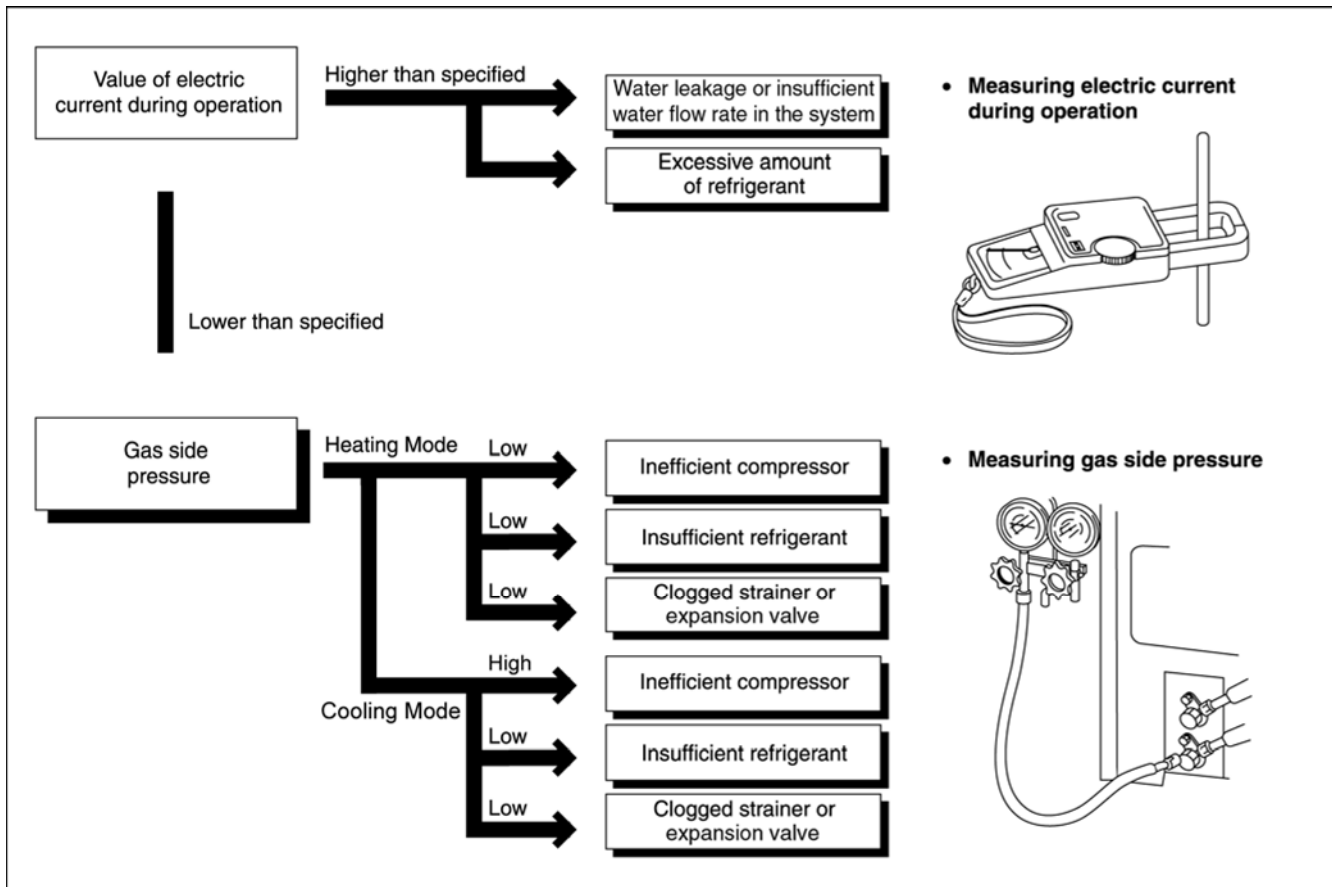

16.2 Relationship between the Condition of the Air-to-Water Heatpump Indoor and Outdoor Units and Pressure and Electric Current

Condition of the Air-to-Water Heatpump indoor and outdoor units	Heating Mode			Cooling Mode		
	Low Pressure	High Pressure	Electric current during operation	Low Pressure	High Pressure	Electric current during operation
Water leakage or insufficient water flow rate in the system						
Excessive amount of refrigerant						
Inefficient compression						
Insufficient refrigerant (gas leakage)						
Outdoor heat exchange deficiency						
Clogged expansion valve or Strainer						

- Carry out the measurements of pressure, electric current, and temperature fifteen minutes after an operation is started.

16.3 Breakdown Self Diagnosis Function

16.3.1 Self Diagnosis Function (Three Digits Alphanumeric Code)

- When abnormality occur during operation, the system will stop operation, and OFF/ON control panel LED will blink and error code will display on the control panel timer display LCD.
- Even error code is reset by turning OFF power supply or by pressing ERROR RESET button, if the system abnormality is still un-repaired, system will again stop operation, and OFF/ON control panel LED will again blink.
- The error code will store in IC memory.
- **To check the error code**
 - 1 When an abnormality occurs, system will stop operation and OFF/ON control panel LED will blink.
 - 2 Error code of the abnormality will display on the control panel timer display LCD.
 - 3 To determine the abnormality description, the error code table needs to be referred.
- **To display past/last error code**
 - 1 Turn ON power supply.
 - 2 Press and hold the CHECK button for more than 5 seconds to enter status mode.
 - 3 Press the SEARCH DOWN/UP button to retrieve past/last error code.
 - 4 Press the CANCEL button or wait 30 seconds to exit status mode.
- **To permanently delete error code from IC memory**
 - 1 Turn ON power supply.
 - 2 Press and hold the ERROR RESET button for more than 8 seconds till a beep sound is heard.

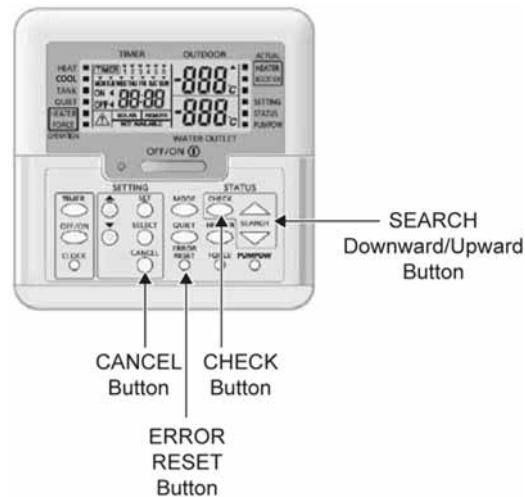

16.4 Error Codes Table

Diagnosis display	Abnormality/Protection control	Abnormality judgement	Primary location to verify
H00	No abnormality detected	—	—
H12	Indoor/Outdoor capacity unmatched	90s after power supply	<ul style="list-style-type: none"> Indoor/outdoor connection wire Indoor/outdoor PCB Specification and combination table in catalogue
H15	Outdoor compressor temperature sensor abnormality	Continue for 5 sec.	<ul style="list-style-type: none"> Compressor temperature sensor (defective or disconnected)
H23	Indoor refrigerant liquid temperature sensor abnormality	Continue for 5 sec.	<ul style="list-style-type: none"> Refrigerant liquid temperature sensor (defective or disconnected)
H42	Compressor low pressure abnormality	—	<ul style="list-style-type: none"> Outdoor pipe temperature sensor Clogged expansion valve or strainer Insufficient refrigerant Outdoor PCB Compressor
H62	Water flow switch abnormality	Continue for 1 min.	<ul style="list-style-type: none"> Water flow switch
H64	Refrigerant high pressure abnormality	Continue for 5 sec.	<ul style="list-style-type: none"> Outdoor high pressure sensor (defective or disconnected)
H70	Back-up heater OLP abnormality	Continue for 60 sec.	<ul style="list-style-type: none"> Back-up heater OLP (Disconnection or activated)
H72	Tank sensor abnormal	Continue for 5 sec.	<ul style="list-style-type: none"> Tank sensor
H76	Indoor - control panel communication abnormality	—	<ul style="list-style-type: none"> Indoor - control panel (defective or disconnected)
H90	Indoor/outdoor abnormal communication	> 1 min after starting operation	<ul style="list-style-type: none"> Internal/external cable connections Indoor/Outdoor PCB
H91	Tank heater OLP abnormality	Continue for 60 sec.	<ul style="list-style-type: none"> Tank heater OLP (Disconnection or activated)
H95	Indoor/Outdoor wrong connection	—	<ul style="list-style-type: none"> Indoor/Outdoor supply voltage
H98	Outdoor high pressure overload protection	—	<ul style="list-style-type: none"> Outdoor high pressure sensor Water pump or water leakage Clogged expansion valve or strainer Excess refrigerant Outdoor PCB
H99	Indoor heat exchanger freeze prevention	—	<ul style="list-style-type: none"> Indoor heat exchanger Refrigerant shortage
F12	Pressure switch activate	4 times occurrence within 20 minutes	<ul style="list-style-type: none"> Pressure switch
F14	Outdoor compressor abnormal revolution	4 times occurrence within 20 minutes	<ul style="list-style-type: none"> Outdoor compressor
F15	Outdoor fan motor lock abnormality	2 times occurrence within 30 minutes	<ul style="list-style-type: none"> Outdoor PCB Outdoor fan motor
F16	Total running current protection	3 times occurrence within 20 minutes	<ul style="list-style-type: none"> Excess refrigerant Outdoor PCB
F20	Outdoor compressor overheating protection	4 times occurrence within 30 minutes	<ul style="list-style-type: none"> Compressor tank temperature sensor Clogged expansion valve or strainer Insufficient refrigerant Outdoor PCB Compressor
F22	IPM (power transistor) overheating protection	3 times occurrence within 30 minutes	<ul style="list-style-type: none"> Improper heat exchange IPM (Power transistor)
F23	Outdoor Direct Current (DC) peak detection	7 times occurrence continuously	<ul style="list-style-type: none"> Outdoor PCB Compressor
F24	Refrigeration cycle abnormality	2 times occurrence within 20 minutes	<ul style="list-style-type: none"> Insufficient refrigerant Outdoor PCB Compressor low compression
F25	Cooling/Heating cycle changeover abnormality	4 times occurrence within 30 minutes	<ul style="list-style-type: none"> 4-way valve V-coil
F27	Pressure switch abnormality	Continue for 1 min.	<ul style="list-style-type: none"> Pressure switch
F36	Outdoor air temperature sensor abnormality	Continue for 5 sec.	<ul style="list-style-type: none"> Outdoor air temperature sensor (defective or disconnected)
F37	Indoor water inlet temperature sensor abnormality	Continue for 5 sec.	<ul style="list-style-type: none"> Water inlet temperature sensor (defective or disconnected)
F40	Outdoor discharge pipe temperature sensor abnormality	Continue for 5 sec.	<ul style="list-style-type: none"> Outdoor discharge pipe temperature sensor (defective or disconnected)

Diagnosis display	Abnormality/Protection control	Abnormality judgement	Primary location to verify
F41	PFC control	4 times occurrence within 10 minutes	<ul style="list-style-type: none"> • Voltage at PFC
F42	Outdoor heat exchanger temperature sensor abnormality	Continue for 5 sec.	<ul style="list-style-type: none"> • Outdoor heat exchanger temperature sensor (defective or disconnected)
F43	Outdoor defrost sensor abnormality	Continue for 5 sec.	<ul style="list-style-type: none"> • Outdoor defrost sensor (defective or disconnected)
F45	Indoor water outlet temperature sensor abnormality	Continue for 5 sec.	<ul style="list-style-type: none"> • Water outlet temperature sensor (defective or disconnected)
F46	Outdoor Current Transformer open circuit	—	<ul style="list-style-type: none"> • Insufficient refrigerant • Outdoor PCB • Compressor low
F95	Cooling high pressure overload protection	—	<ul style="list-style-type: none"> • Outdoor high pressure sensor • Water pump or water leakage • Clogged expansion valve or strainer • Excess refrigerant • Outdoor PCB

16.5 Self-diagnosis Method

16.5.1 Connection Capability Rank Abnormality (H12)

Malfunction Decision Conditions:

During startup operation of cooling and heating, the capability rank of indoor checked by the outdoor is used to determine connection capability rank abnormality.

Malfunction Caused:

- 1 Wrong model interconnected.
- 2 Wrong indoor unit or outdoor unit PCB (main) used.
- 3 Faulty indoor unit or outdoor unit PCB (main).

Abnormality Judgment:

Continue for 90 seconds.

Troubleshooting:

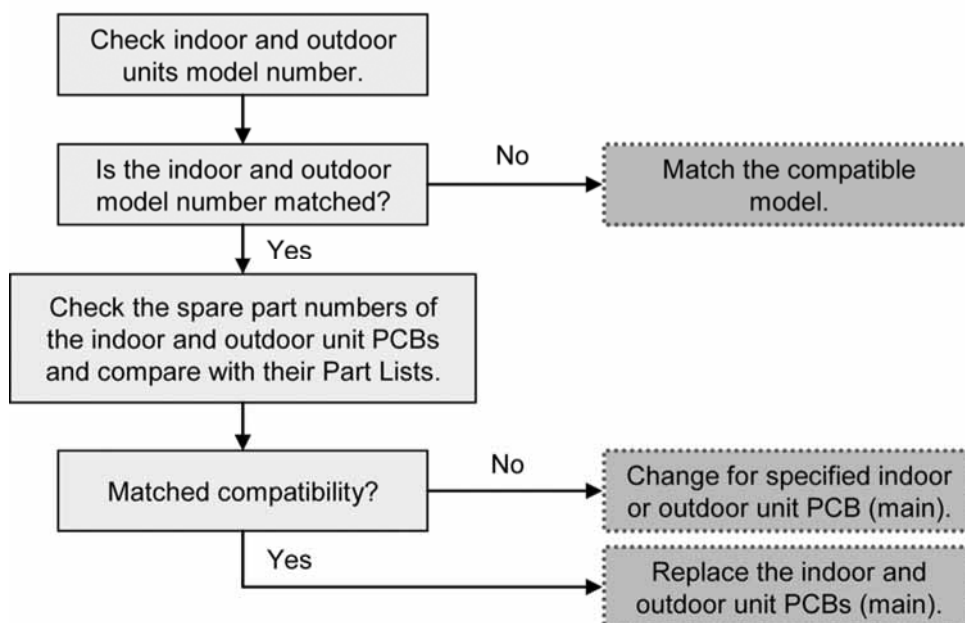

16.5.2 Compressor Tank Temperature Sensor Abnormality (H15)

Malfunction Decision Conditions:

During startup and operation of cooling and heating, the temperatures detected by the compressor tank temperature sensor are used to determine sensor error.

Malfunction Caused:

- 1 Faulty connector connection.
- 2 Faulty sensor.
- 3 Faulty outdoor unit PCB (main).

Abnormality Judgment:

Continue for 5 seconds.

Troubleshooting:

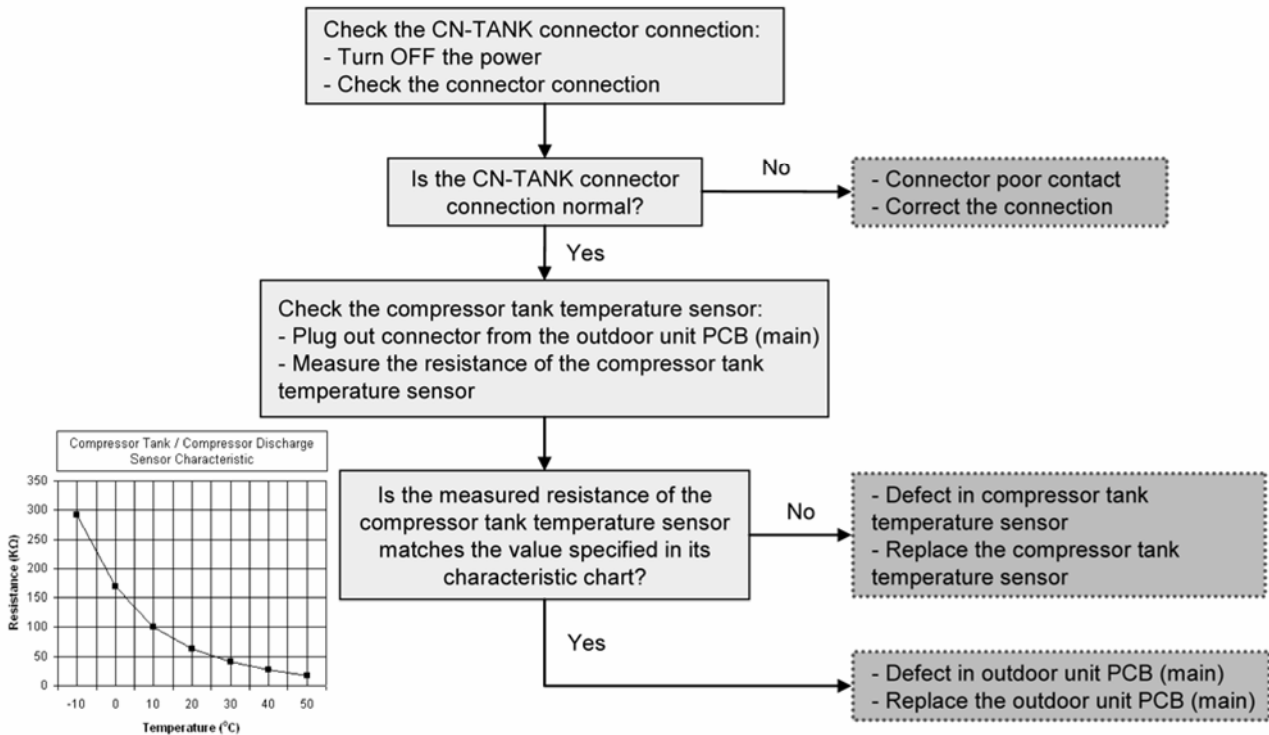

16.5.3 Indoor Refrigerant Liquid Temperature Sensor Abnormality (H23)

Malfunction Decision Conditions:

During startup and operation of cooling and heating, the temperatures detected by the indoor refrigerant liquid temperature sensor are used to determine sensor error.

Malfunction Caused:

- 1 Faulty connector connection.
- 2 Faulty sensor.
- 3 Faulty indoor unit PCB (main).

Abnormality Judgment:

Continue for 5 seconds.

Troubleshooting:  **Caution** For safety reason and to prevent component breakdown, always switch off the power before remove and connect the component.

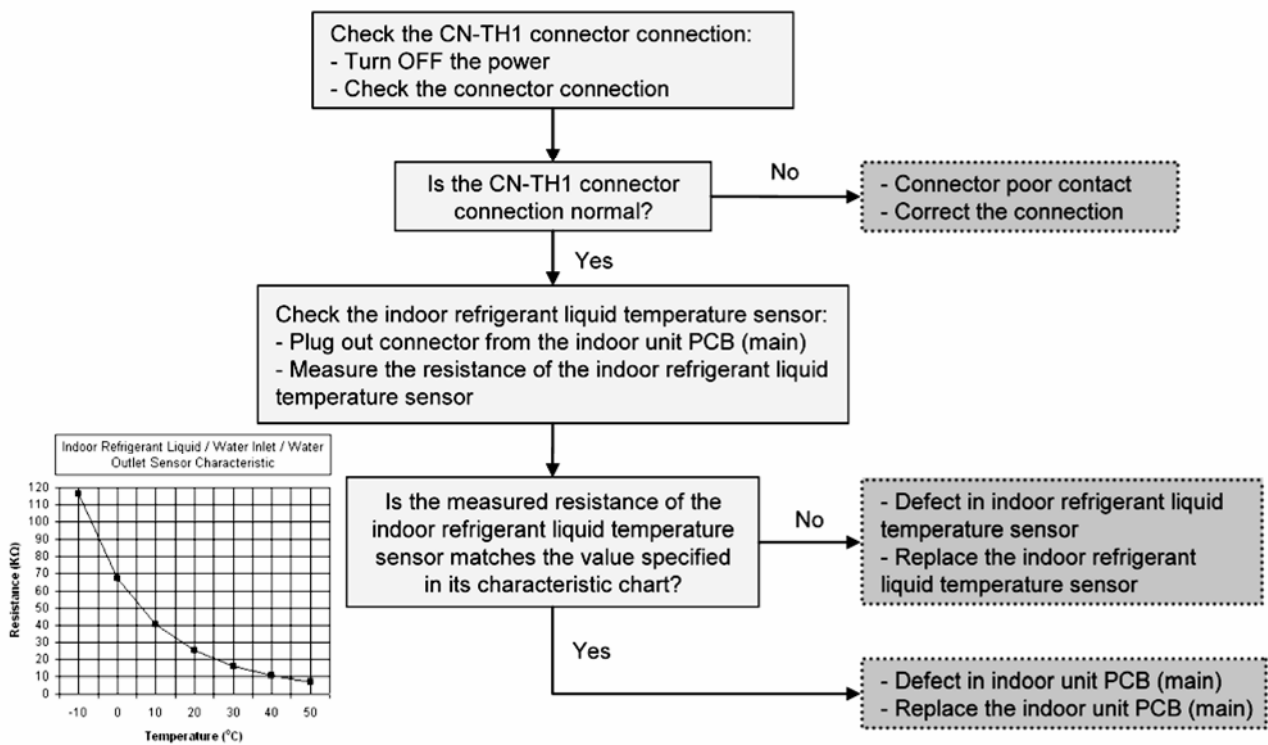

16.5.4 Compressor Low Pressure Protection (H42)

Malfunction Decision Conditions:

During operation of heating and after 5 minutes compressor ON, when outdoor pipe temperature below -29°C or above 26°C is detected by the outdoor pipe temperature sensor.

Malfunction Caused:

- 1 Dust accumulation on the outdoor unit heat exchanger.
- 2 Air short circuit at outdoor unit.
- 3 2 way valve partially closed.
- 4 Faulty outdoor unit fan motor.
- 5 Refrigerant shortage (refrigerant leakage).
- 6 Clogged expansion valve or strainer.
- 7 Faulty outdoor pipe temperature sensor.
- 8 Faulty outdoor unit main PCB (main).

Troubleshooting:



Caution

For safety reason and to prevent component breakdown, always switch off the power before remove and connect the component.

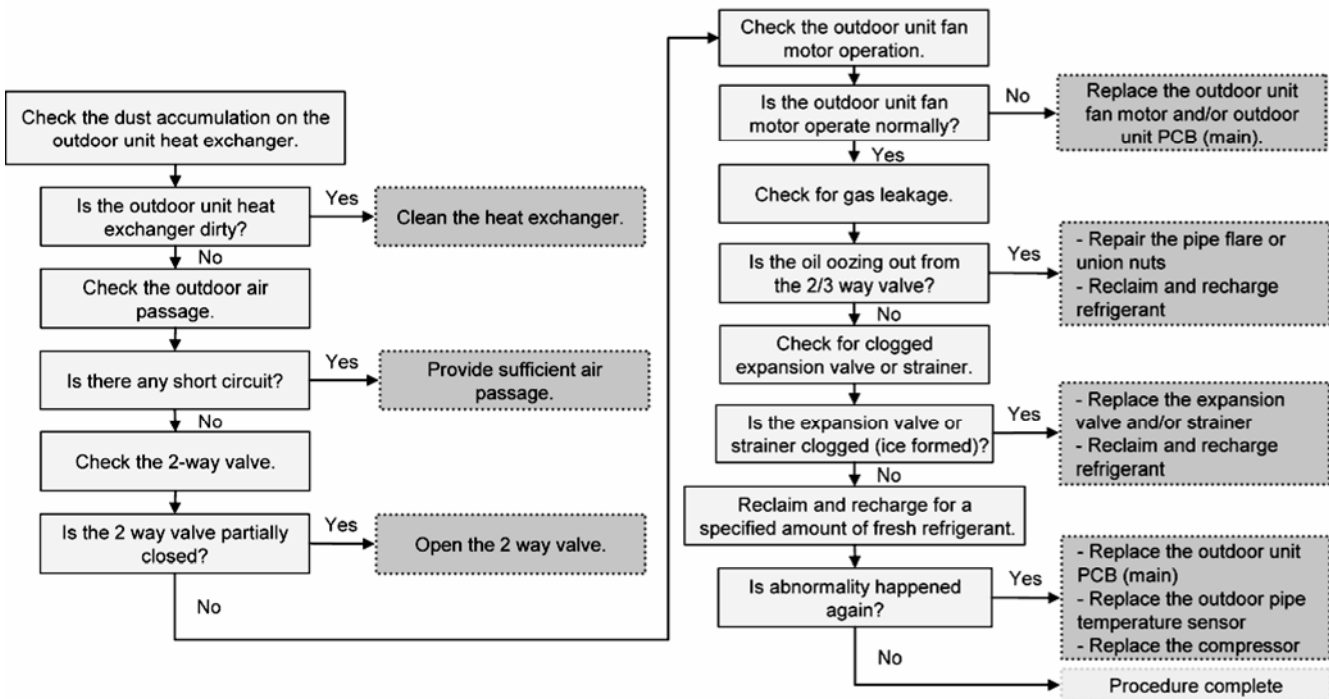

16.5.5 Water Flow Switch Abnormality (H62)

Malfunction Decision Conditions:

During operation of cooling and heating, the water flow detected by the indoor water flow switch is used to determine water flow error.

Malfunction Caused:

- 1 Faulty water pump.
- 2 Water leak in system.
- 3 Faulty connector connection.
- 4 Faulty water flow switch.
- 5 Faulty indoor unit PCB (main).

Abnormality Judgment:

Continue for 10 seconds (but no judgment for 9 minutes after compressor startup/restart).

Troubleshooting:



For safety reason and to prevent component breakdown, always switch off the power before remove and connect the component.

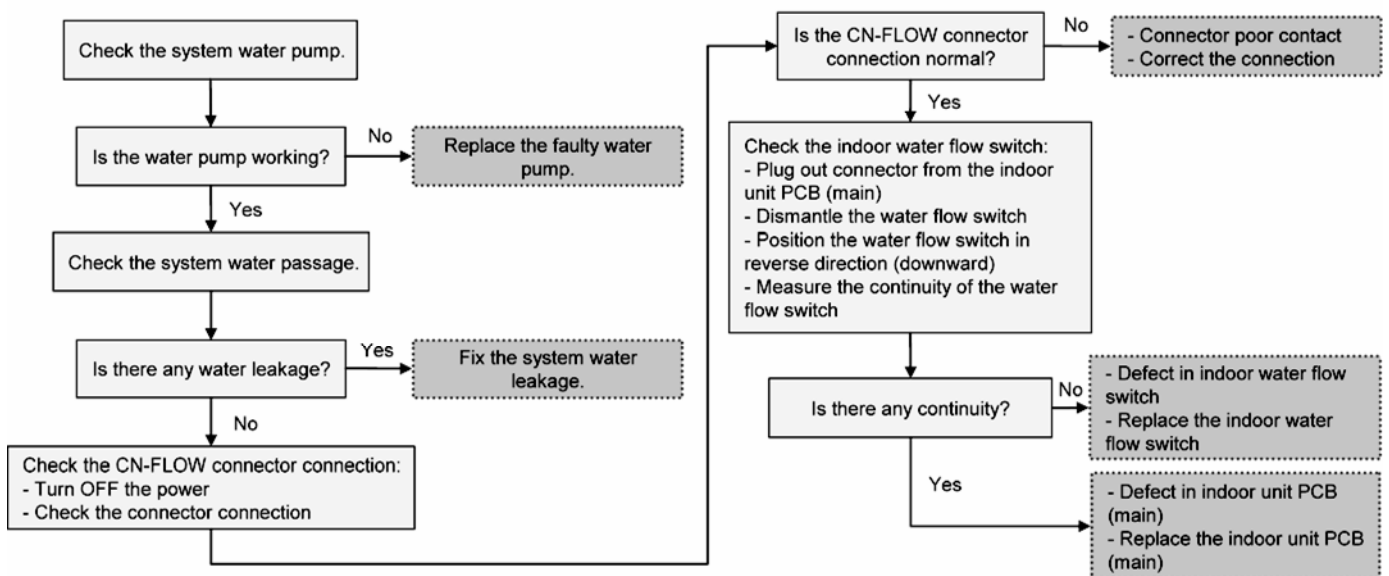

16.5.6 Outdoor High Pressure Abnormality (H64)

Malfunction Decision Conditions:

During operation of cooling and heating, when the outdoor high pressure sensor output signal is 0Vdc or 5Vdc.

Malfunction Caused:

- 1 Faulty connector connection.
- 2 Faulty sensor.
- 3 Faulty outdoor unit PCB (main).

Abnormality Judgment:

Continue 4 times in 20 minutes.

Troubleshooting:



Caution

For safety reason and to prevent component breakdown, always switch off the power before remove and connect the component.

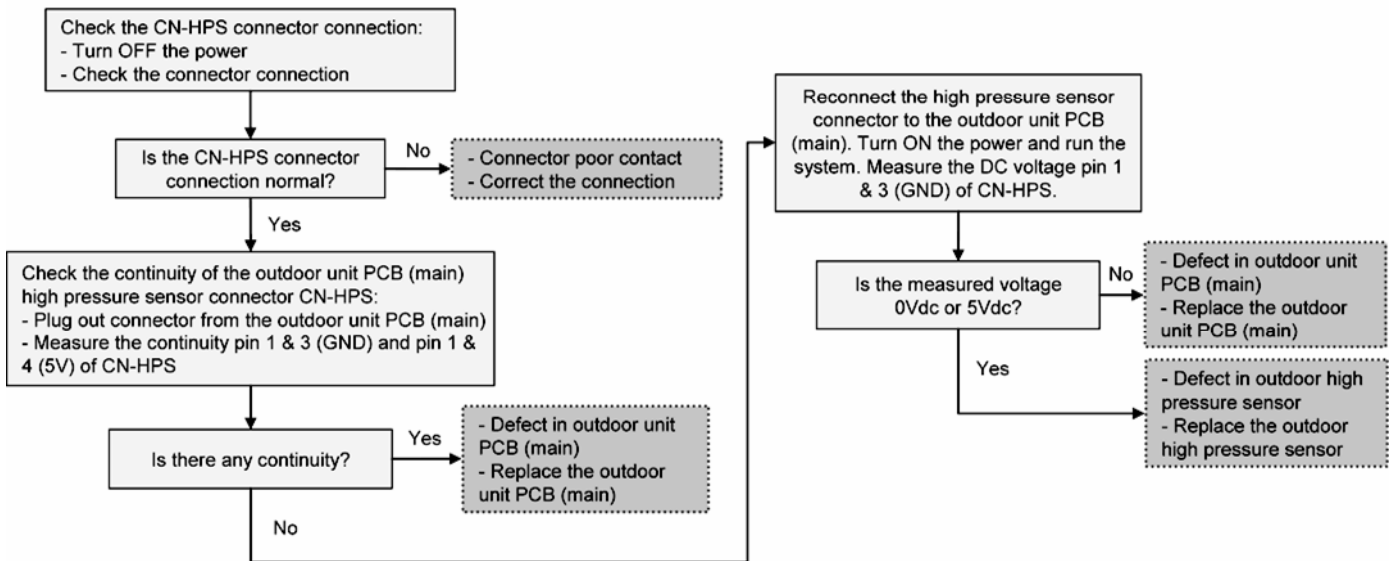

16.5.7 Indoor Backup Heater OLP Abnormality (H70)

Malfunction Decision Conditions:

During operation of indoor backup heater, when no power supplies to indoor backup heater or OLP open circuit.

Malfunction Caused:

- 1 Faulty power supply connector connection.
- 2 Faulty connector connection.
- 3 Faulty indoor backup heater overload protector (OLP).
- 4 Faulty indoor unit PCB (main).

Abnormality Judgment:

Continue for 60 seconds.

Troubleshooting:



Caution

For safety reason and to prevent component breakdown, always switch off the power before remove and connect the component.

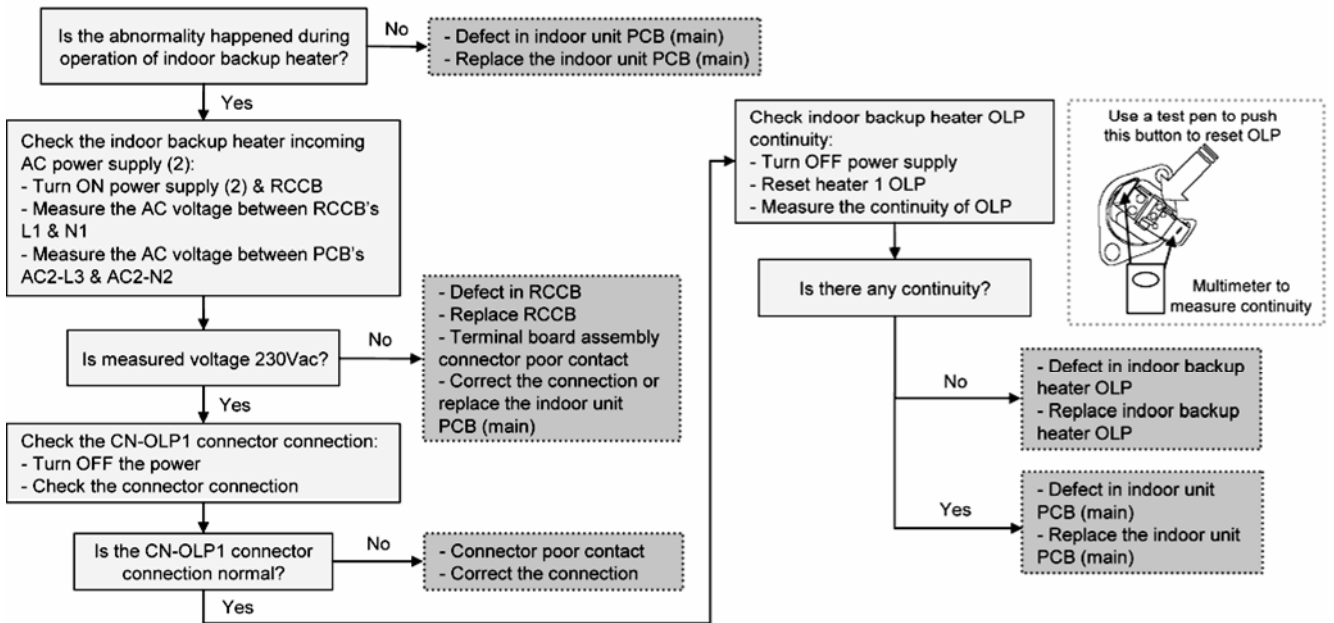

16.5.8 Tank Temperature Sensor Abnormality (H72)

Malfunction Decision Conditions:

When tank connection is set to ON, the temperatures detected by the tank temperature sensor are used to determine sensor error.

Malfunction Caused:

- 1 Faulty connector connection.
- 2 Faulty sensor.
- 3 Faulty indoor unit PCB (main).

Abnormality Judgment:

Continue for 5 seconds.

Troubleshooting:



Caution

For safety reason and to prevent component breakdown, always switch off the power before remove and connect the component.

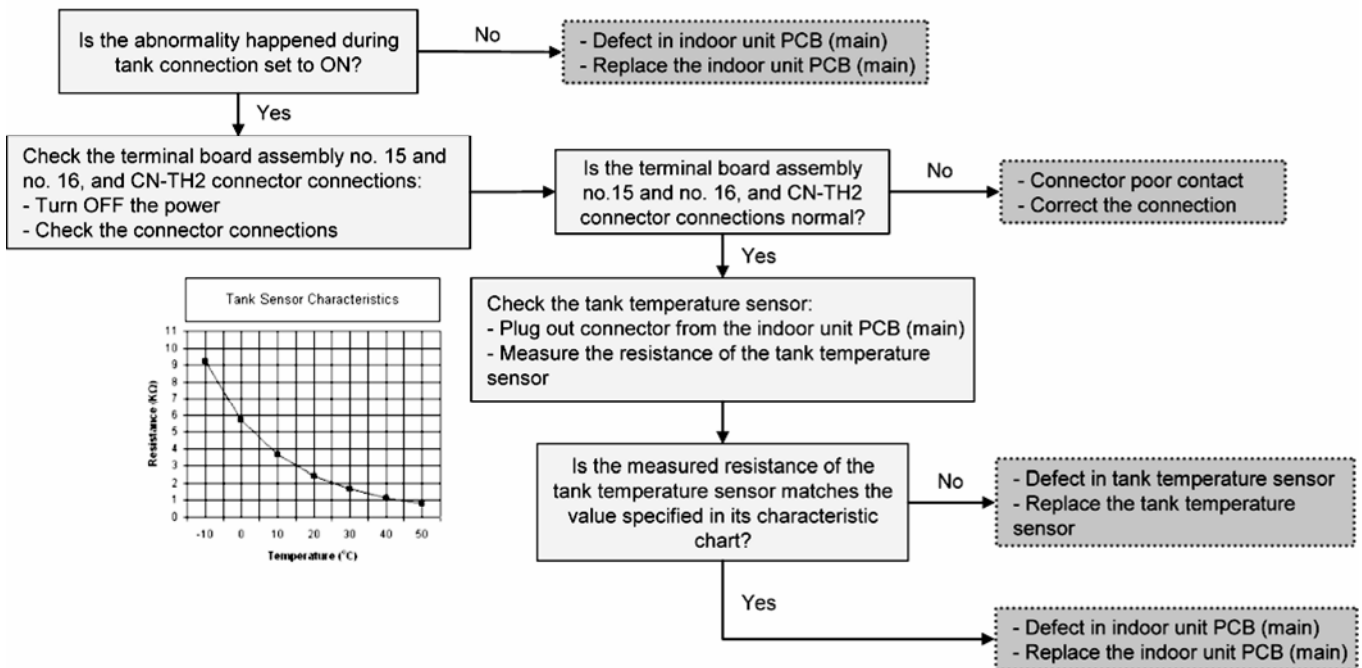

16.5.9 Indoor-Control Panel Communication Abnormality (H76)

Malfunction Decision Conditions:

During standby and operation of cooling and heating, indoor-control panel error occur.

Malfunction Caused:

- 1 Faulty connector connection.
- 2 Faulty control panel.
- 3 Faulty indoor unit PCB (main).

Troubleshooting:



Caution

For safety reason and to prevent component breakdown, always switch off the power before remove and connect the component.

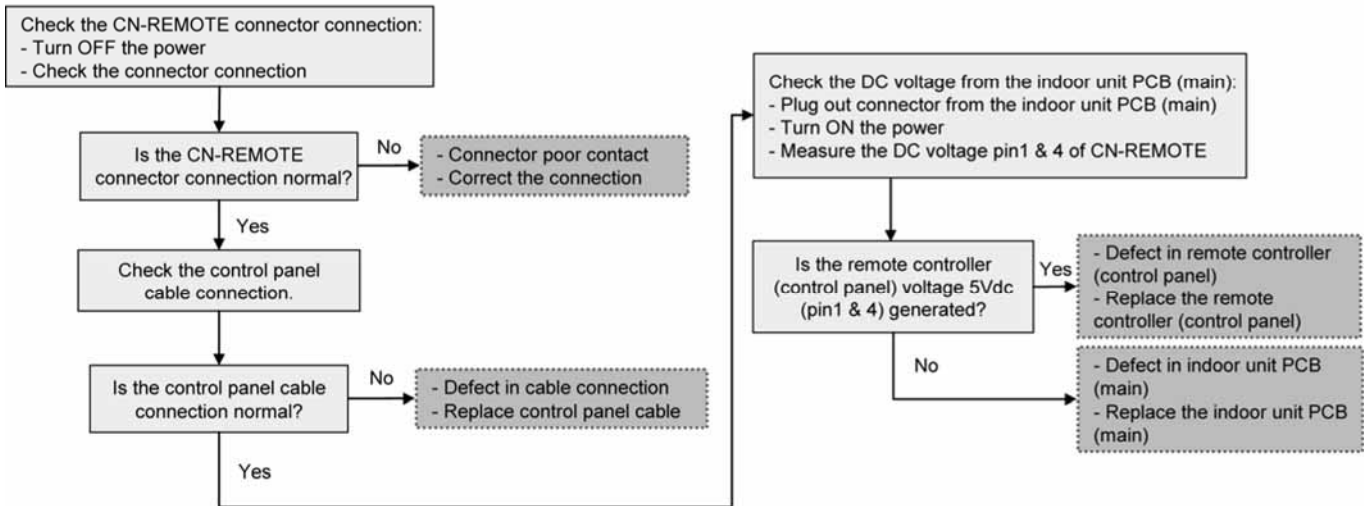

16.5.10 Indoor/Outdoor Abnormal Communication (H90)

Malfunction Decision Conditions:

During operation of cooling and heating, the data received from outdoor unit in indoor unit signal transmission is checked whether it is normal.

Malfunction Caused:

- 1 Faulty outdoor unit PCB (main).
- 2 Faulty indoor unit PCB (main).
- 3 Indoor-outdoor signal transmission error due to wrong wiring.
- 4 Indoor-outdoor signal transmission error due to breaking of wire in the connection wires between the indoor and outdoor units.
- 5 Indoor-outdoor signal transmission error due to disturbed power supply waveform.

Abnormality Judgment:

Continue for 1 minute after operation.

Troubleshooting:



For safety reason and to prevent component breakdown, always switch off the power before remove and connect the component.

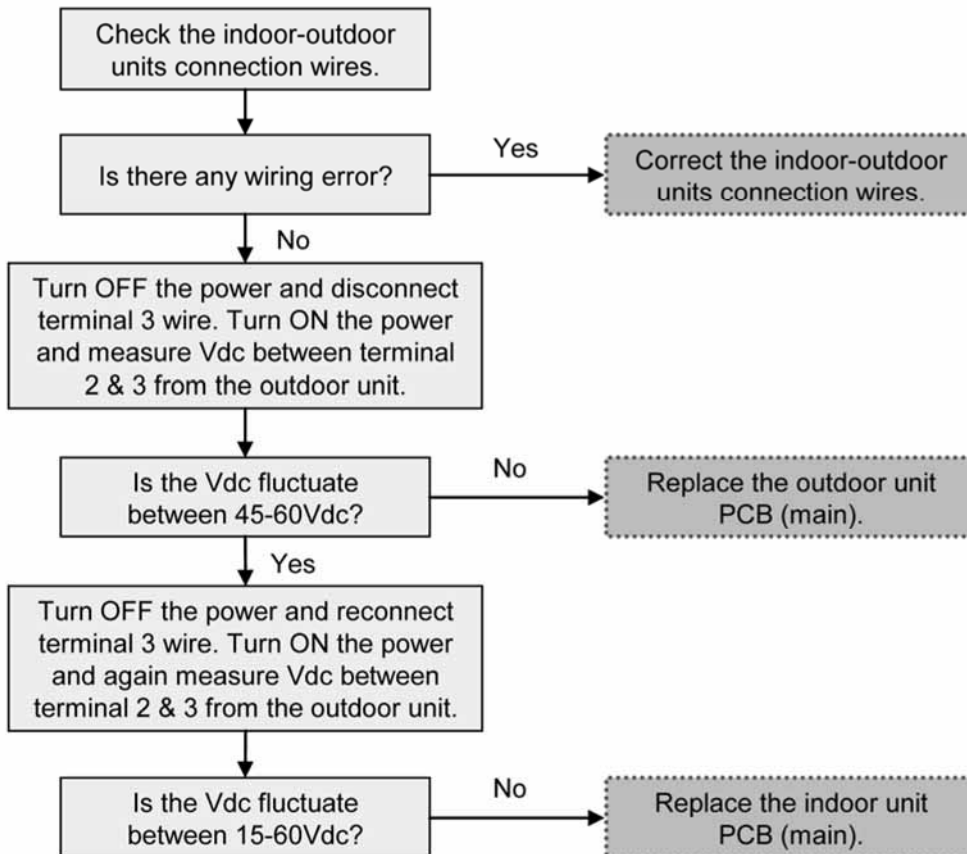

16.5.11 Tank Booster Heater OLP Abnormality (H91)

Malfunction Decision Conditions:

During operation of tank booster heater, and tank booster heater OLP open circuit.

Malfunction Caused:

- 1 Faulty connector connection.
- 2 Faulty tank booster heater overload protector (OLP).
- 3 Faulty indoor unit PCB (main).

Abnormality Judgment:

Continue for 60 seconds.

Troubleshooting:



Caution

For safety reason and to prevent component breakdown, always switch off the power before remove and connect the component.

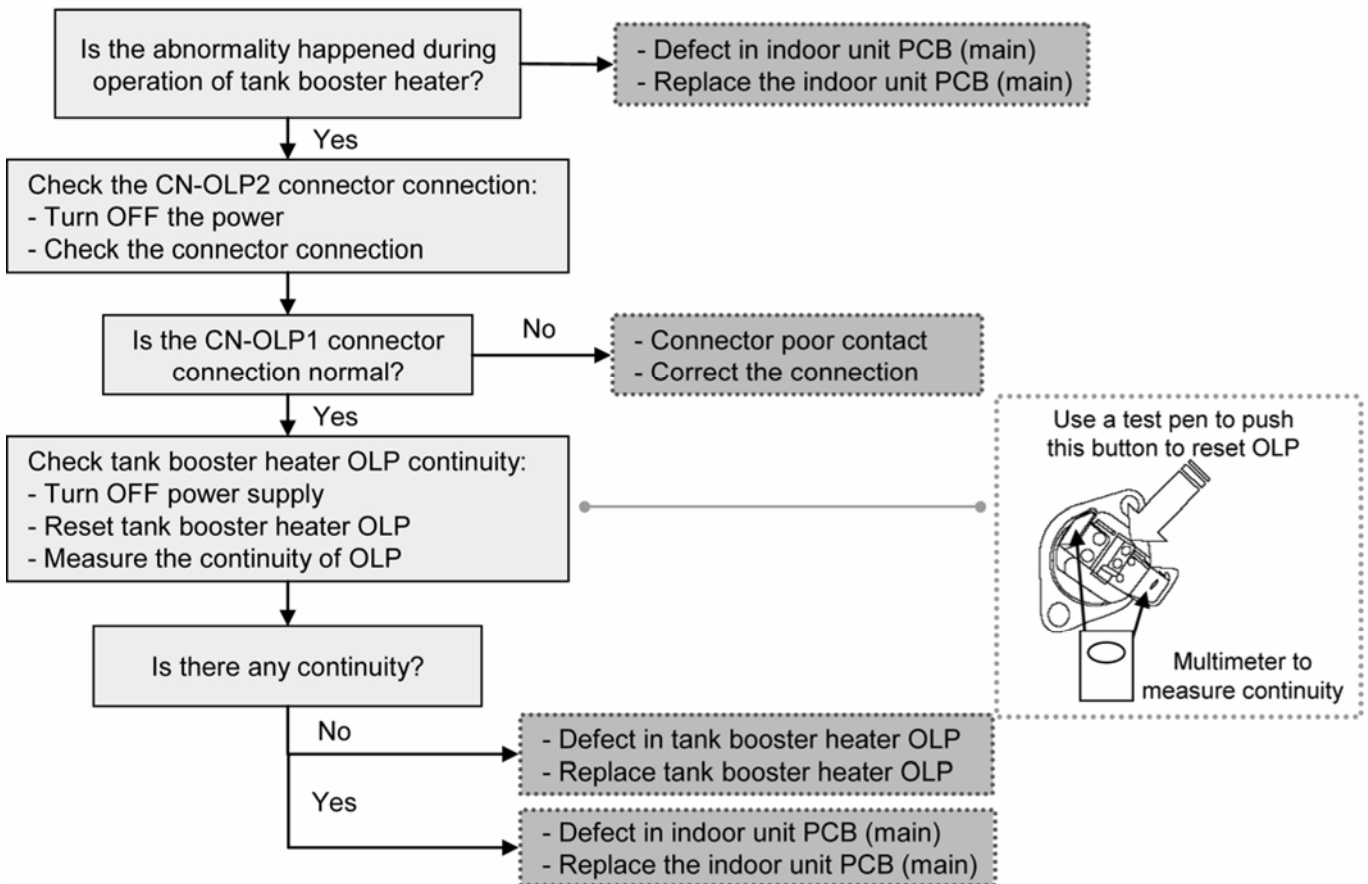

16.5.12 Unspecified Voltage between Indoor and Outdoor (H95)

Malfunction Decision Conditions:

The supply power is detected for its requirement by the indoor/outdoor transmission.

Malfunction Caused:

- 1 Insufficient power supply.
- 2 Faulty outdoor unit PCB (noise filter/main).

Troubleshooting:



Caution

For safety reason and to prevent component breakdown, always switch off the power before remove and connect the component.

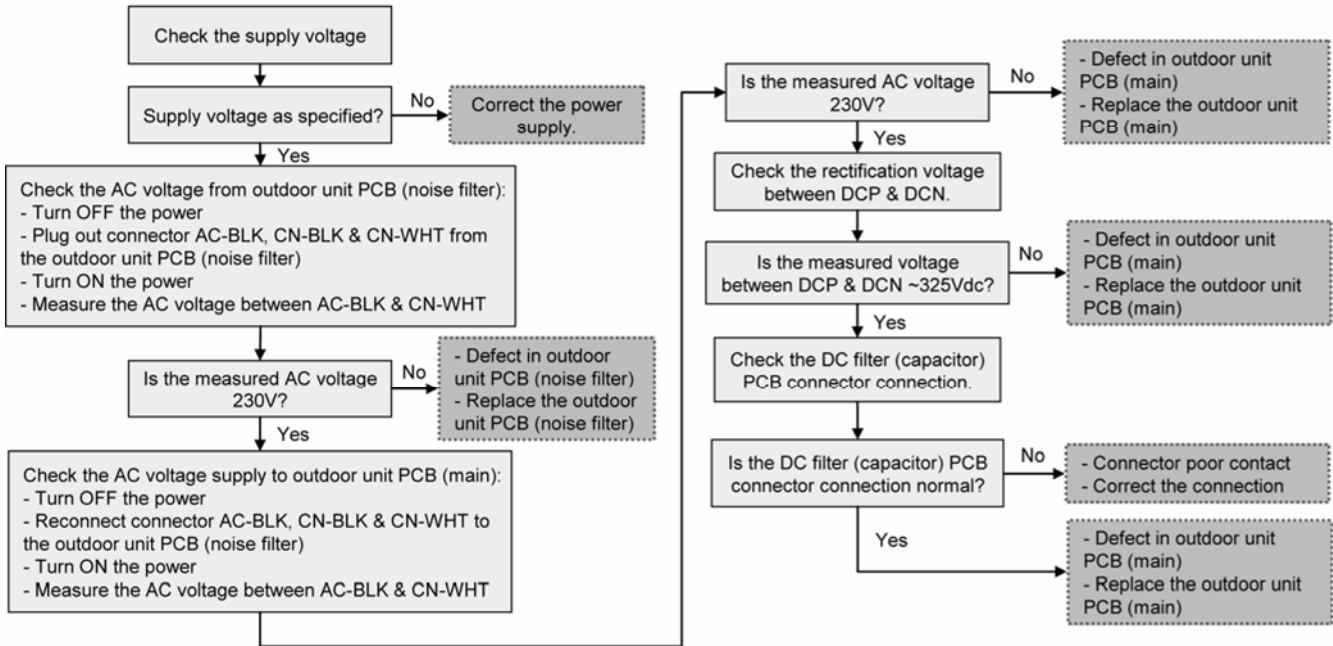

16.5.13 Outdoor High Pressure Protection (H98)

Malfunction Decision Conditions:

During operation of heating, when pressure 4.0MPa and above is detected by outdoor high pressure sensor.

Malfunction Caused:

- 1 Faulty water pump.
- 2 Insufficient water flow rate in system.
- 3 Water leak in system.
- 4 2/3 way closed.
- 5 Clogged expansion valve or strainer.
- 6 Excessive refrigerant.
- 7 Faulty outdoor high pressure sensor.
- 8 Faulty outdoor unit PCB (main).

Troubleshooting:



Caution

For safety reason and to prevent component breakdown, always switch off the power before remove and connect the component.

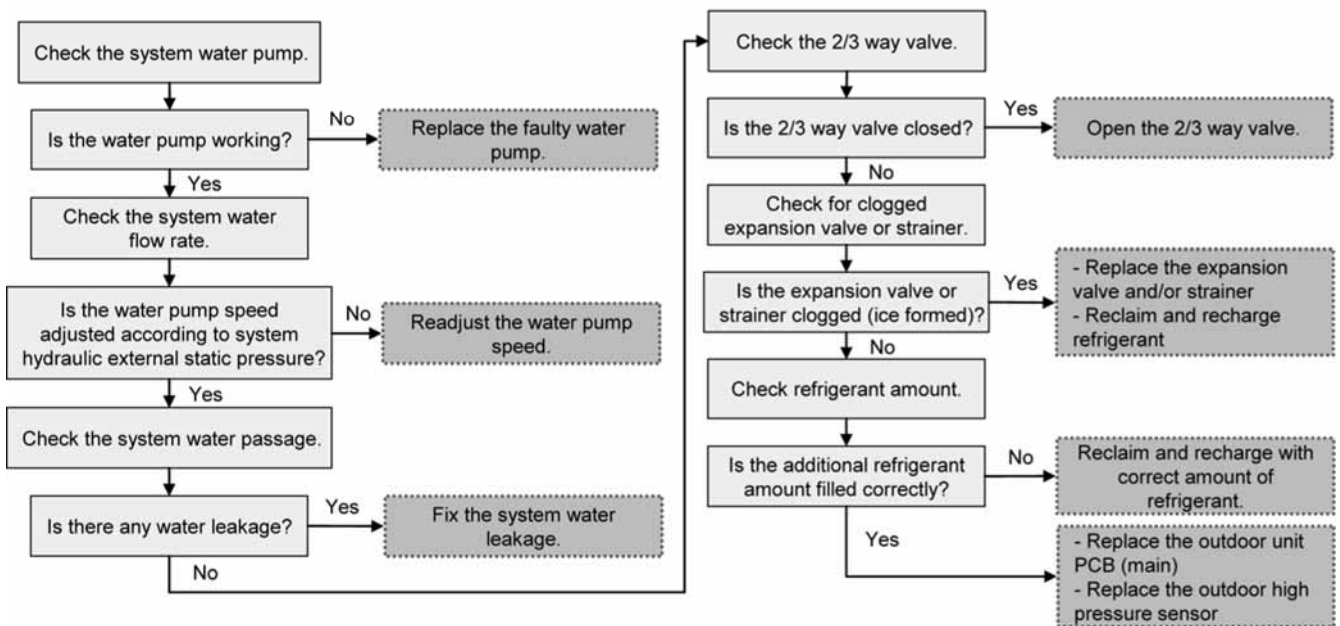

16.5.14 Indoor Freeze-up Protection (H99)

Malfunction Decision Conditions:

During anti-freezing control in cooling operation, when the indoor refrigerant liquid temperature $< 0^{\circ}\text{C}$.

Malfunction Caused:

- 1 Faulty water pump.
- 2 Insufficient water flow rate in system.
- 3 Water leak in system.
- 4 2 way valve partially closed.
- 5 Clogged expansion valve or strainer.
- 6 Refrigerant shortage (refrigerant leakage).
- 7 Faulty indoor refrigerant liquid temperature sensor.
- 8 Faulty indoor unit PCB (main).

Troubleshooting:



Caution

For safety reason and to prevent component breakdown, always switch off the power before remove and connect the component.

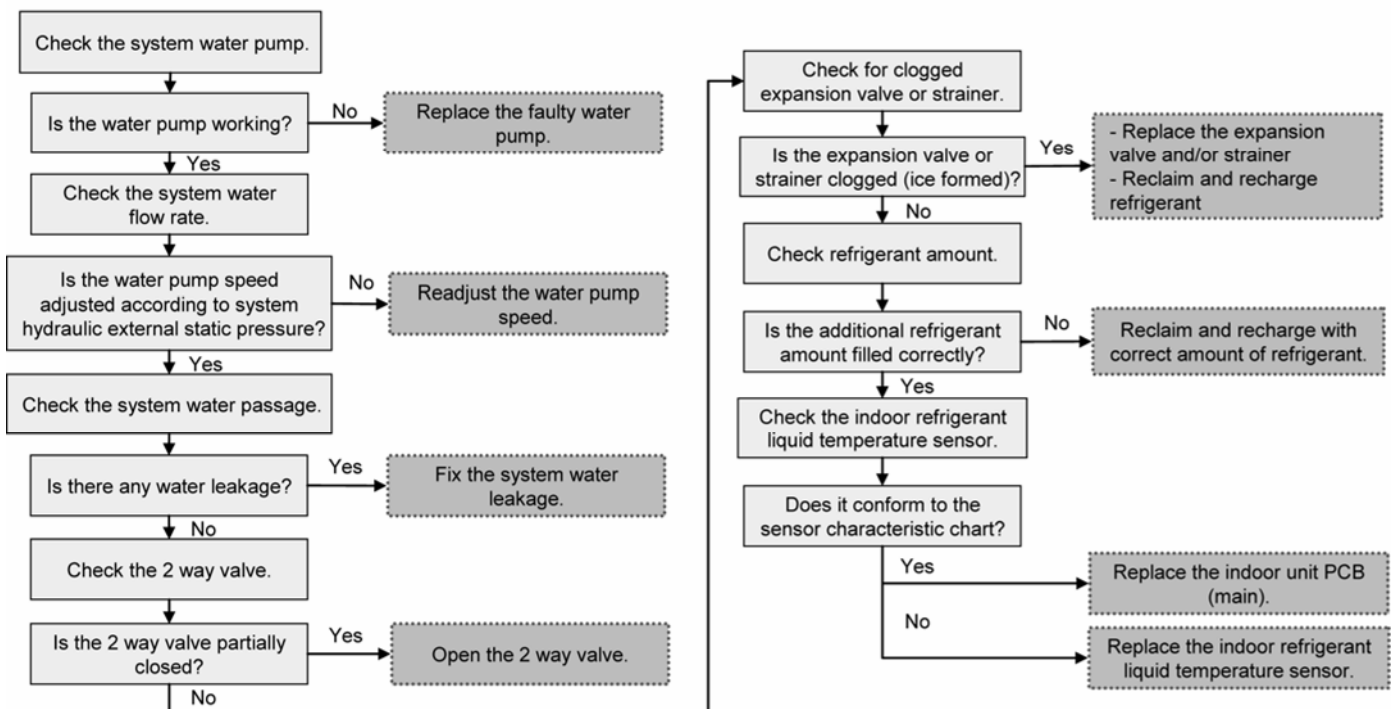

16.5.15 Outdoor High Pressure Switch Activate (F12)

Malfunction Decision Conditions:

During operation of cooling and heating, when pressure 4.5MPa and above is detected by outdoor high pressure switch.

Malfunction Caused:

- 1 Dust accumulation on the outdoor unit heat exchanger.
- 2 Air short circuit at outdoor unit.
- 3 Faulty water pump.
- 4 Insufficient water flow rate in system.
- 5 Water leak in system.
- 6 2/3 way valve closed.
- 7 Clogged expansion valve or strainer.
- 8 Excessive refrigerant.
- 9 Faulty outdoor high pressure sensor and switch.
- 10 Faulty outdoor unit PCB.

Abnormality Judgment:

Continue 4 times in 20 minutes.

Troubleshooting:



For safety reason and to prevent component breakdown, always switch off the power before remove and connect the component.

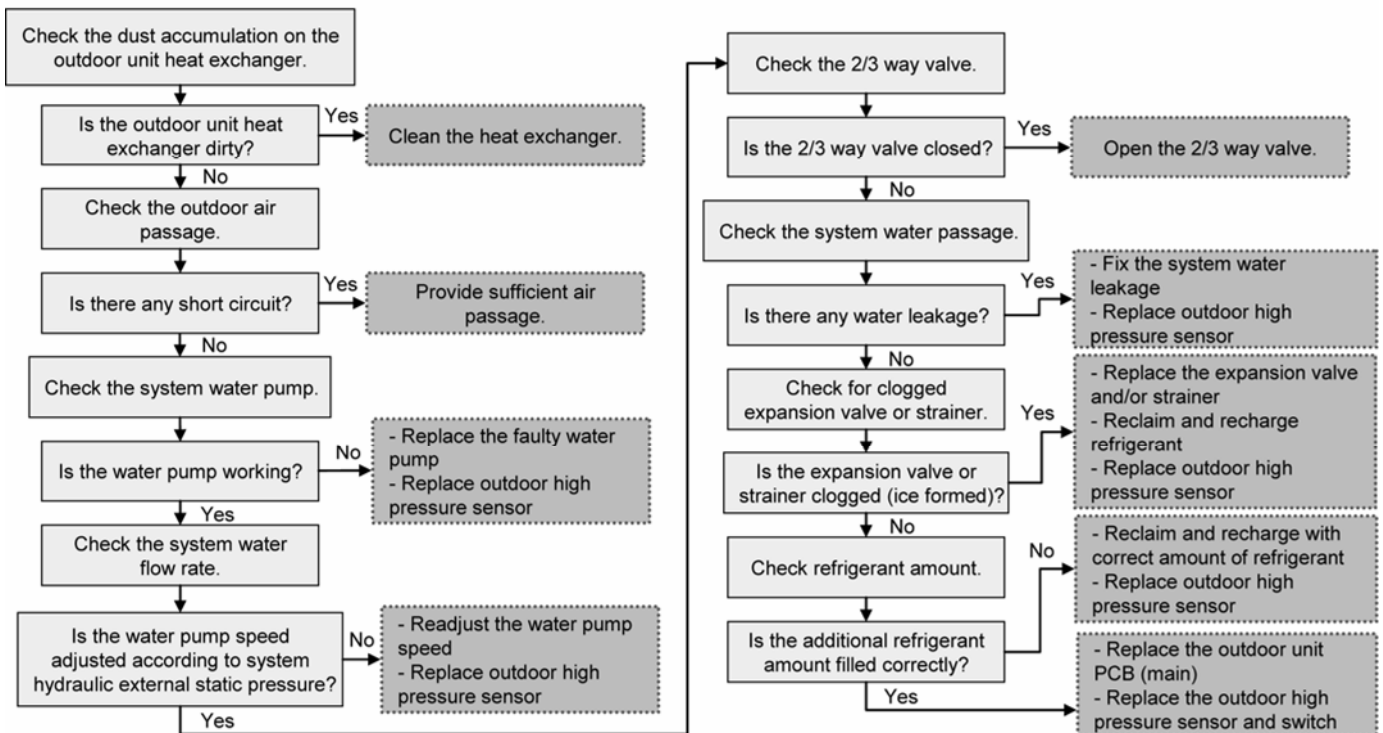

16.5.16 Compressor Rotation Failure (F14)

Malfunction Decision Conditions:

A compressor rotation failure is detected by checking the compressor running condition through the position detection circuit.

Malfunction Caused:

- 1 Compressor terminal disconnect.
- 2 Faulty outdoor unit PCB (main).
- 3 Faulty compressor.

Abnormality Judgment:

Continue 4 times in 20 minutes.

Troubleshooting:



Caution

For safety reason and to prevent component breakdown, always switch off the power before remove and connect the component.

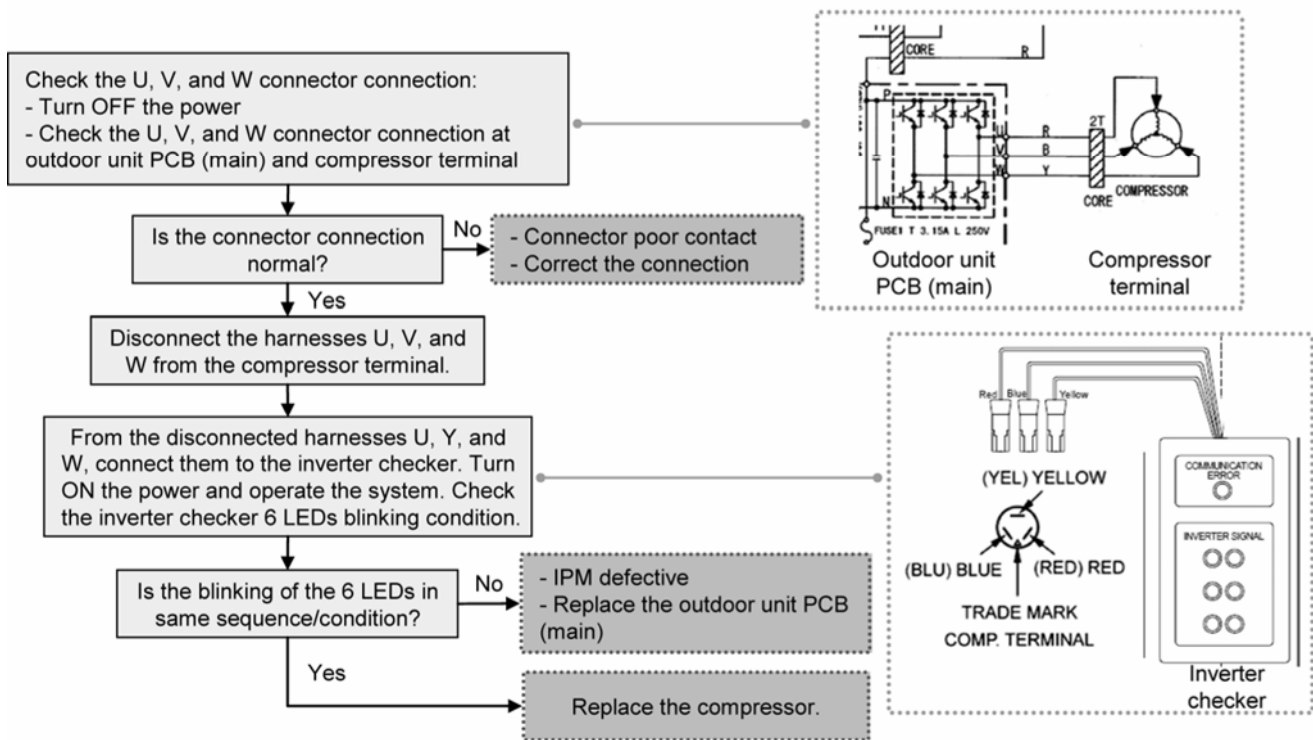

16.5.17 Outdoor Fan Motor (DC Motor) Mechanism Locked (F15)

Malfunction Decision Conditions:

The rotation speed detected by the Hall IC of the fan motor during fan motor operation is used to determine abnormal fan motor (feedback of rotation > 2550rpm or < 50rpm).

Malfunction Caused:

- 1 Operation stop due to short circuit inside the fan motor winding.
- 2 Operation stop due to breaking of wire inside the fan motor.
- 3 Operation stop due to breaking of fan motor lead wires.
- 4 Operation stop due to fan motor Hall IC malfunction.
- 5 Operation error due to faulty outdoor unit PCB.

Abnormality Judgment:

Continue 2 times in 30 minutes.

Troubleshooting:



Caution

For safety reason and to prevent component breakdown, always switch off the power before remove and connect the component.

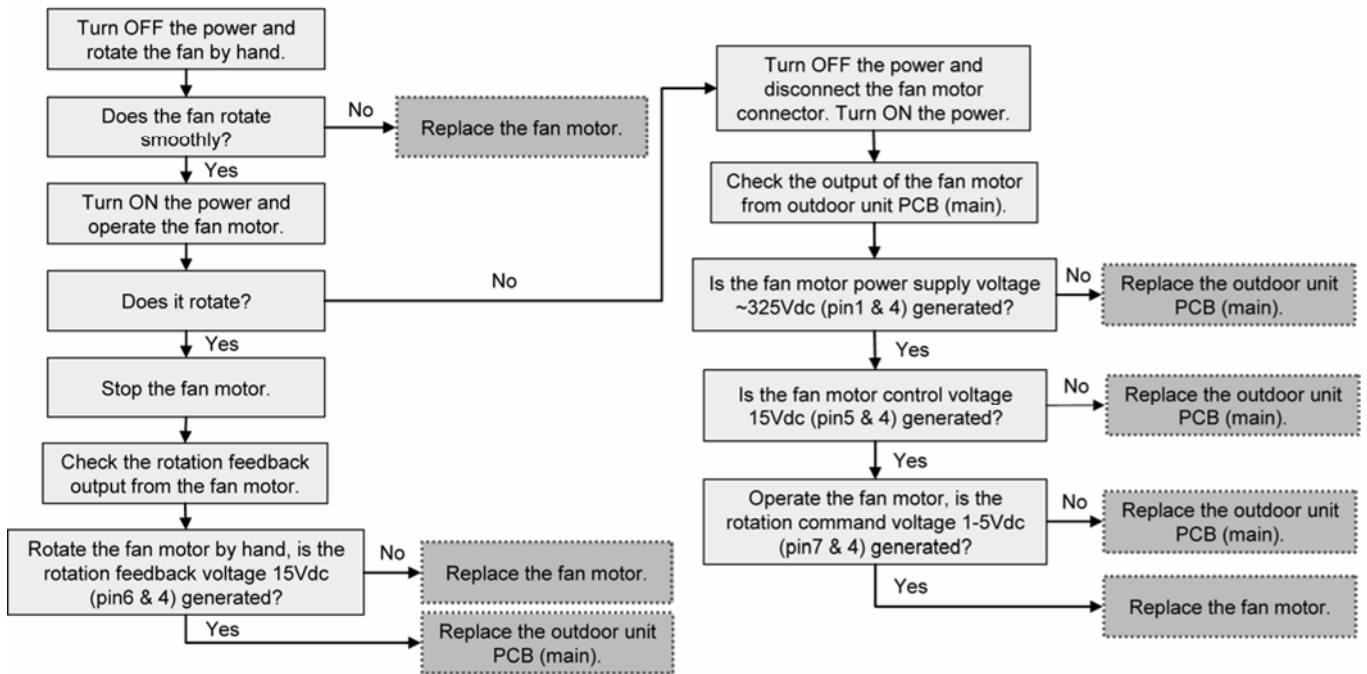

16.5.18 Input Over Current Detection (F16)

Malfunction Decision Conditions:

During operation of cooling and heating, when outdoor current above 10.6A is detected by the current transformer (CT) in the outdoor unit PCB.

Malfunction Caused:

- 1 Excessive refrigerant.
- 2 Faulty outdoor unit PCB (main).

Abnormality Judgment:

Continue 3 times in 20 minutes.

Troubleshooting:



For safety reason and to prevent component breakdown, always switch off the power before remove and connect the component.

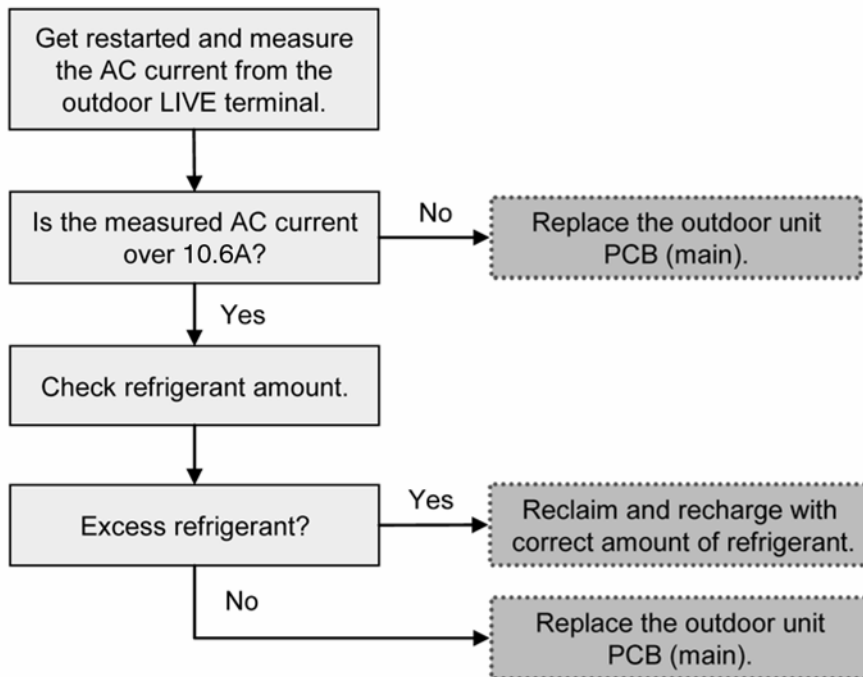

16.5.19 Compressor Overheating (F20)

Malfunction Decision Conditions:

During operation of cooling and heating, when temperature above 112°C is detected by the compressor tank temperature sensor.

Malfunction Caused:

- 1 Faulty compressor tank temperature sensor.
- 2 2/3 way valve closed.
- 3 Refrigerant shortage (refrigerant leakage).
- 4 Clogged expansion valve or strainer.
- 5 Faulty outdoor unit PCB (main).
- 6 Faulty compressor.

Abnormality Judgment:

Continue 4 times in 30 minutes.

Troubleshooting:



Caution

For safety reason and to prevent component breakdown, always switch off the power before remove and connect the component.

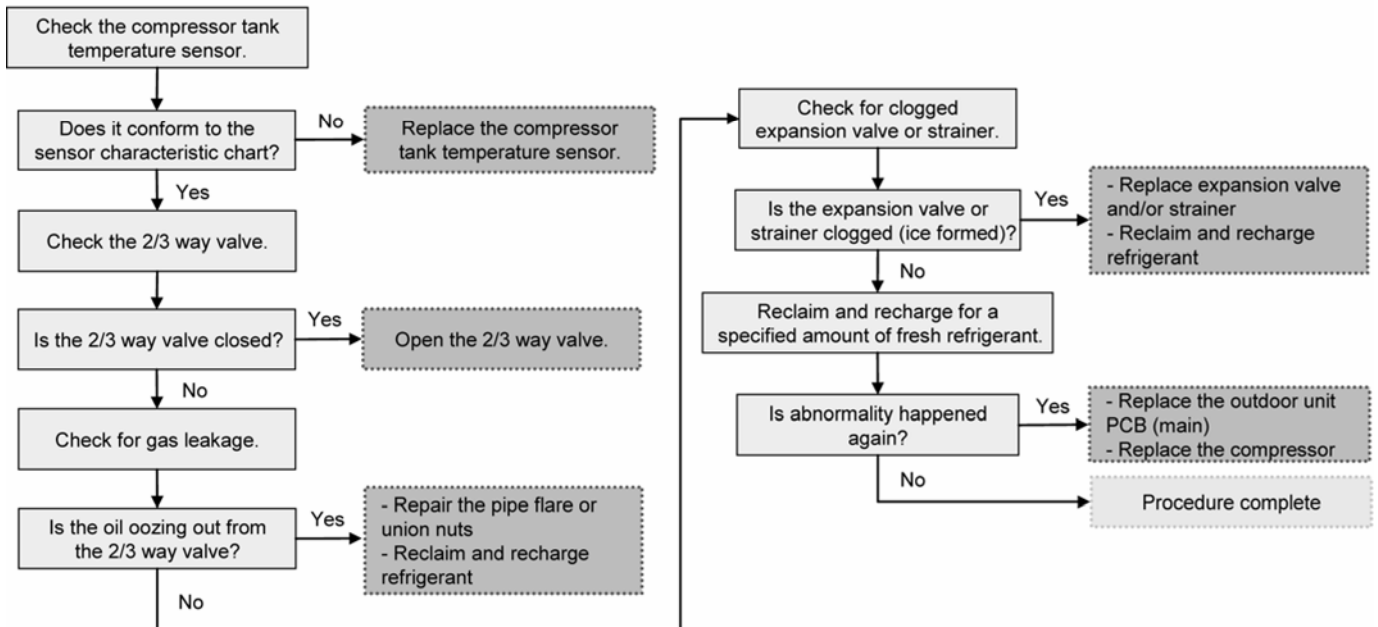

16.5.20 IPM Overheating (F22)

Malfunction Decision Conditions:

During operation of cooling and heating, when temperature 95°C is detected by the outdoor IPM temperature sensor.

Malfunction Caused:

- 1 Faulty outdoor unit fan motor.
- 2 Faulty outdoor unit PCB (main).

Abnormality Judgment:

Continue 3 times in 30 minutes.

Troubleshooting:



Caution

For safety reason and to prevent component breakdown, always switch off the power before remove and connect the component.

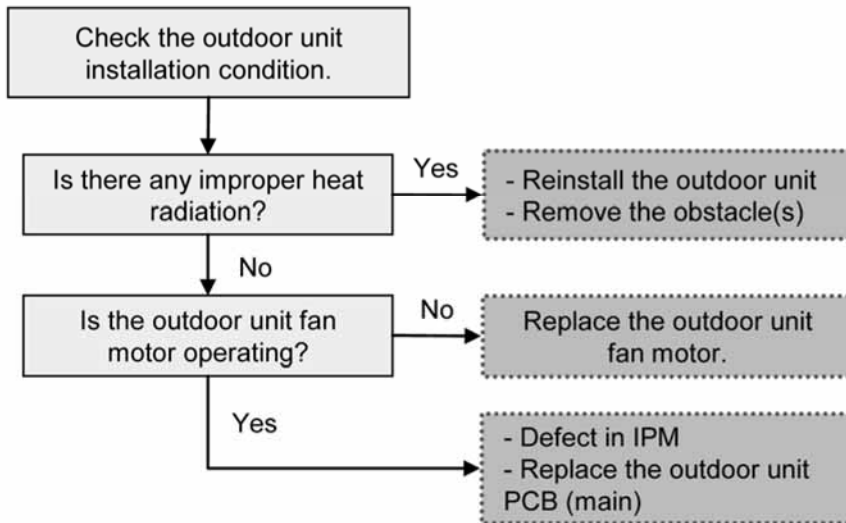

16.5.21 Output Over Current Detection (F23)

Malfunction Decision Conditions:

During operation of cooling and heating, when outdoor DC current is above $40.1 \pm 5.0A$ (for: UD07~09CE) OR $44.7 \pm 5.0A$ (for:UD12~16CE) is detected by the IPM DC Peak sensing circuitry in the outdoor unit PCB (main).

Malfunction Caused:

- 1 Faulty outdoor unit PCB (main).
- 2 Faulty compressor.

Abnormality Judgment:

Continue for 7 times.

Troubleshooting:



Caution

For safety reason and to prevent component breakdown, always switch off the power before remove and connect the component.

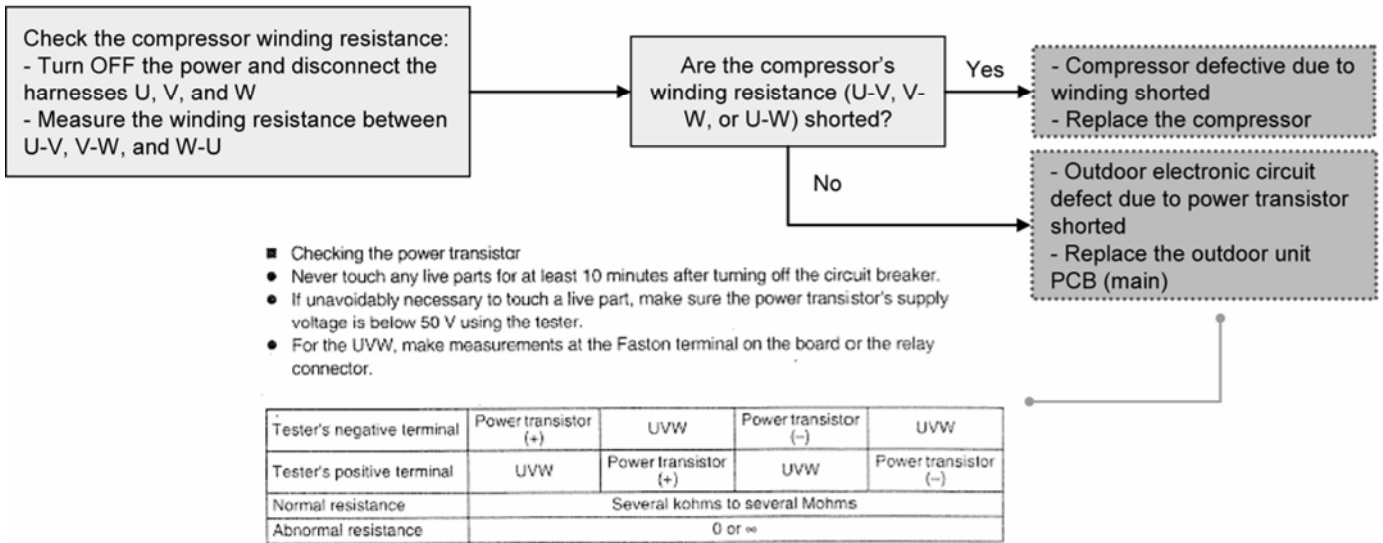

16.5.22 Refrigeration Cycle Abnormality (F24)

Malfunction Decision Conditions:

- 1 During operation of cooling and heating, compressor frequency > Frated.
- 2 During operation of cooling and heating, running current: $0.65A < I < 1.65A$.
- 3 During operation of cooling, water inlet temperature - indoor refrigerant liquid temperature < 5°C.
- 4 During operation of heating, indoor refrigerant liquid temperature - water inlet temperature < 5°C.

Malfunction Caused:

- 1 Faulty water inlet or indoor refrigerant liquid temperature sensors.
- 2 2/3 way valve closed.
- 3 Refrigerant shortage (refrigerant leakage).
- 4 Clogged expansion valve or strainer.
- 5 Faulty outdoor unit PCB (main).
- 6 Poor compression of compressor.

Abnormality Judgment:

Continue 2 times in 20 minutes.

Troubleshooting:



For safety reason and to prevent component breakdown, always switch off the power before remove and connect the component.

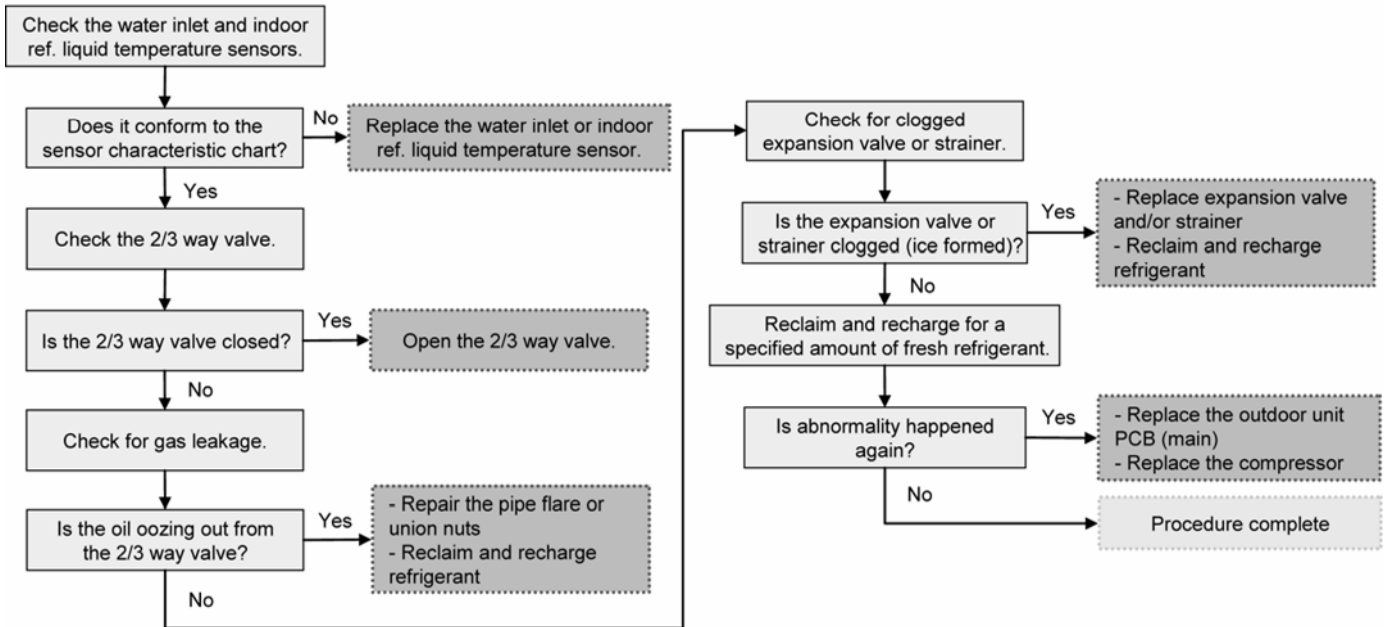

16.5.23 Four Way Valve Abnormality (F25)

Malfunction Decision Conditions:

- 1 During heating operation, when the indoor pipe temperature of thermostat ON indoor unit < 0°C.
- 2 During cooling operation, when the indoor pipe temperature of thermostat ON indoor unit > 45°C.

Malfunction Caused:

- 1 Faulty sensor.
- 2 Faulty connector connection.
- 3 Faulty outdoor unit PCB (noise filter/main).
- 4 Faulty four way valve.

Abnormality Judgment:

Continue 4 times in 30 minutes.

Troubleshooting:



Caution

For safety reason and to prevent component breakdown, always switch off the power before remove and connect the component.

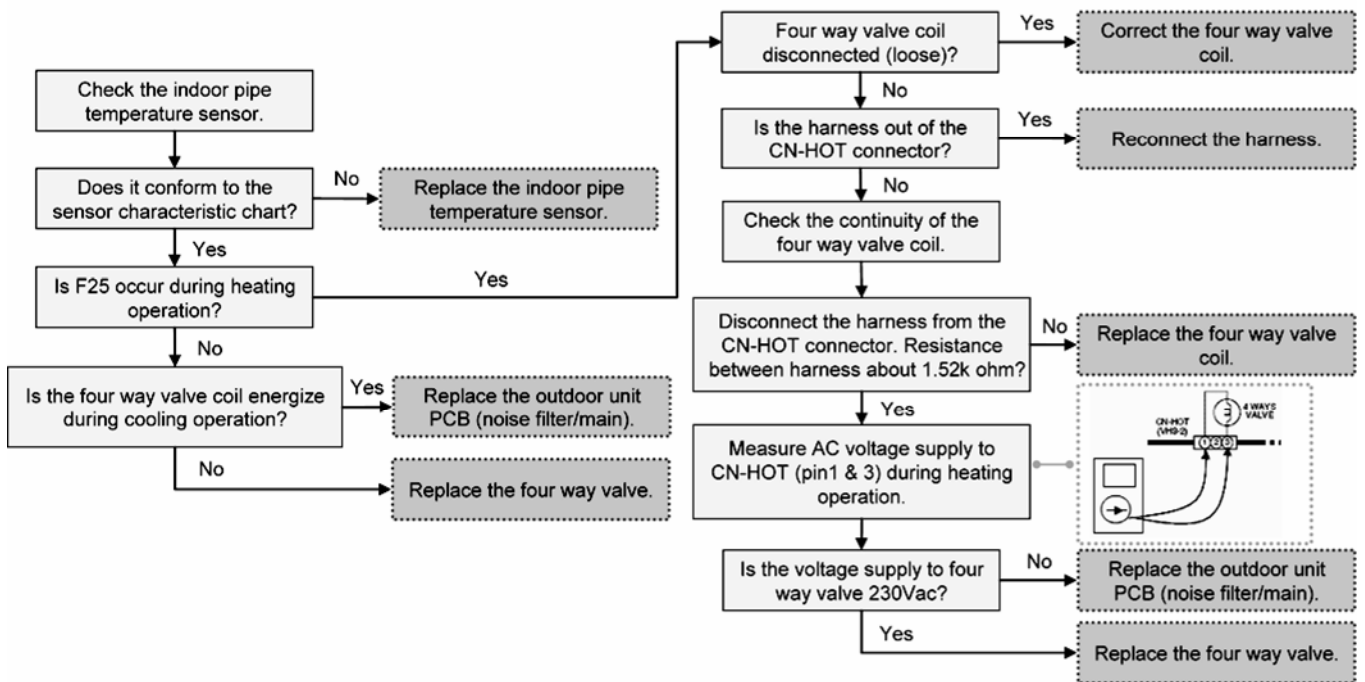

16.5.24 Outdoor High Pressure Switch Abnormal (F27)

Malfunction Decision Conditions:

During compressor stop, and outdoor high pressure switch is remain opened.

Malfunction Caused:

- 1 Faulty connector connection.
- 2 Faulty switch.
- 3 Faulty outdoor unit PCB (main).

Abnormality Judgment:

Continue for 1 minute.

Troubleshooting:



Caution

For safety reason and to prevent component breakdown, always switch off the power before remove and connect the component.

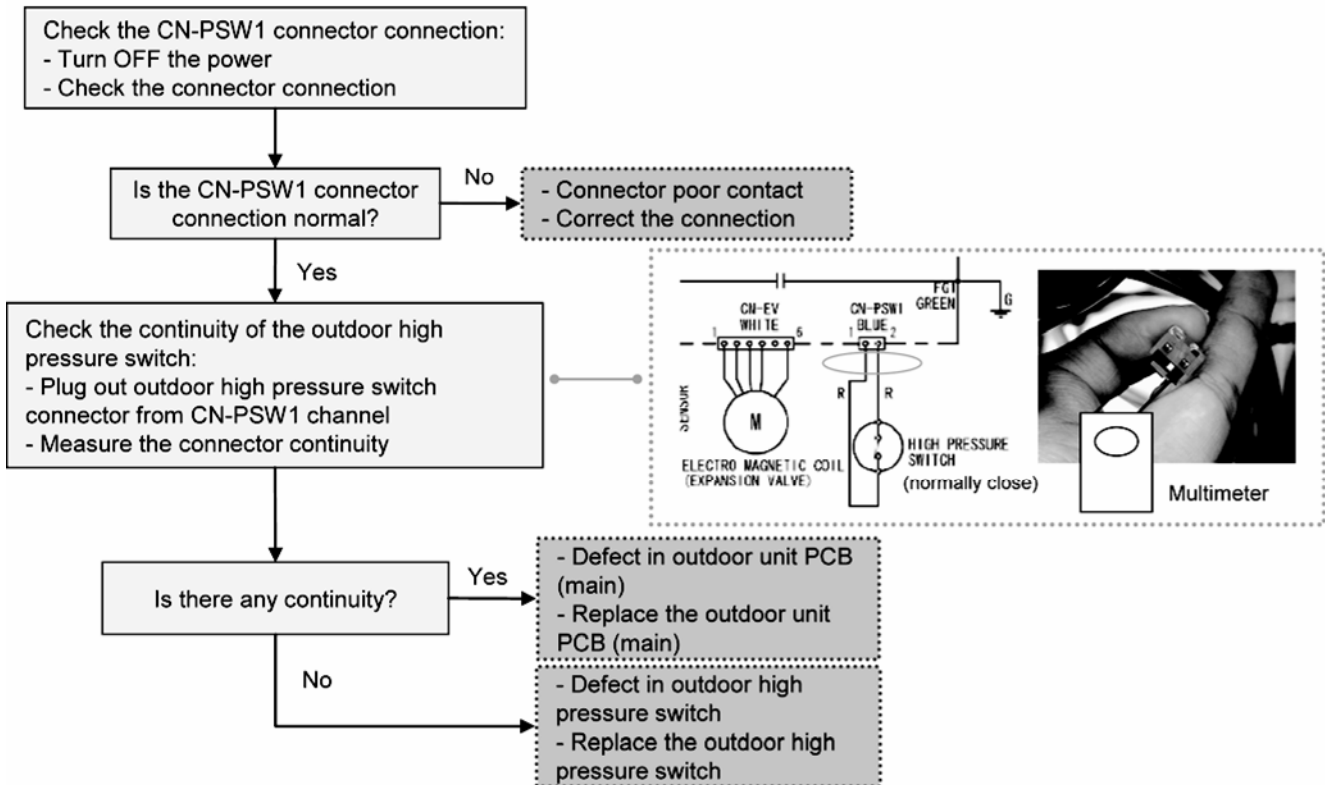

16.5.25 Outdoor Air Temperature Sensor Abnormality (F36)

Malfunction Decision Conditions:

During startup and operation of cooling and heating, the temperatures detected by the outdoor air temperature sensor are used to determine sensor error.

Malfunction Caused:

- 1 Faulty connector connection.
- 2 Faulty sensor.
- 3 Faulty outdoor unit PCB (main).

Abnormality Judgment:

Continue for 5 seconds.

Troubleshooting:



Caution

For safety reason and to prevent component breakdown, always switch off the power before remove and connect the component.

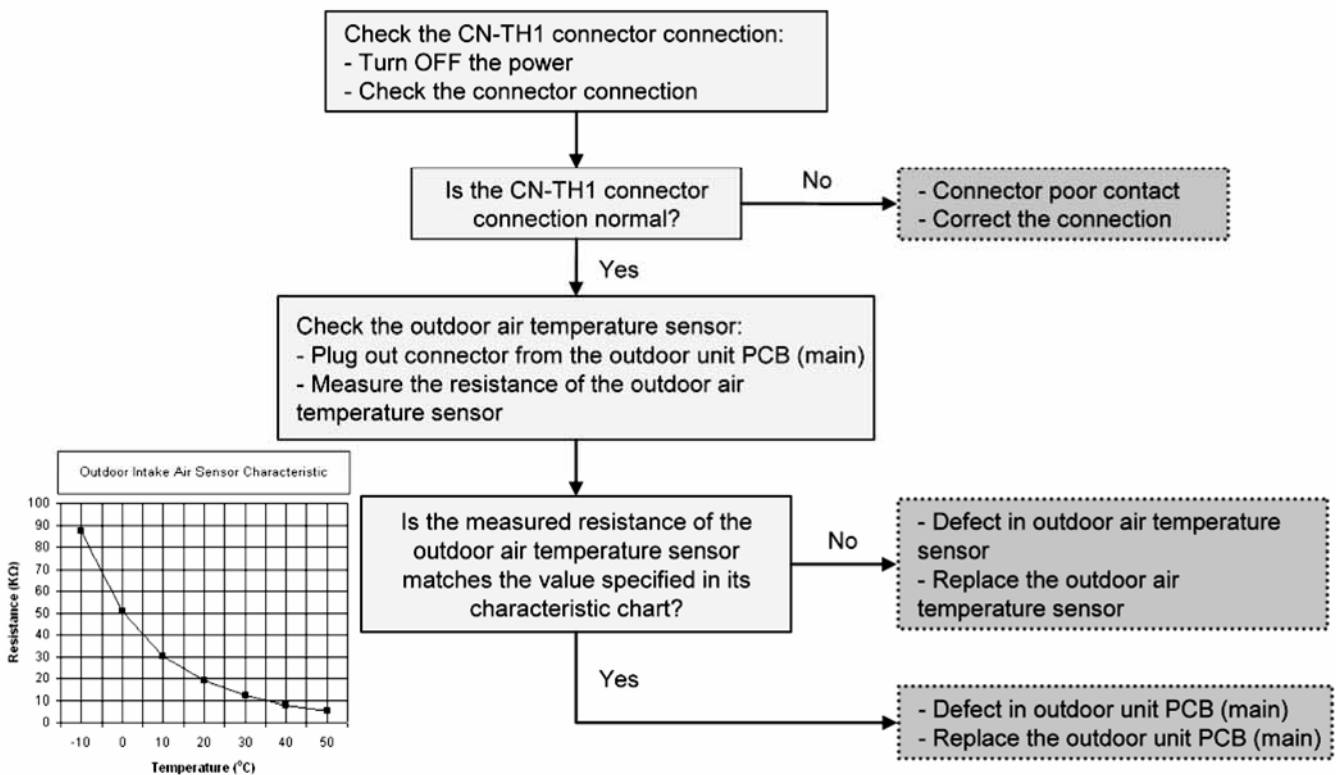

16.5.26 Indoor Water Inlet Temperature Sensor Abnormality (F37)

Malfunction Decision Conditions:

During startup and operation of cooling and heating, the temperatures detected by the indoor water inlet temperature sensor are used to determine sensor error.

Malfunction Caused:

- 1 Faulty connector connection.
- 2 Faulty sensor.
- 3 Faulty indoor unit PCB (main).

Abnormality Judgment:

Continue for 5 seconds.

Troubleshooting:



Caution

For safety reason and to prevent component breakdown, always switch off the power before remove and connect the component.

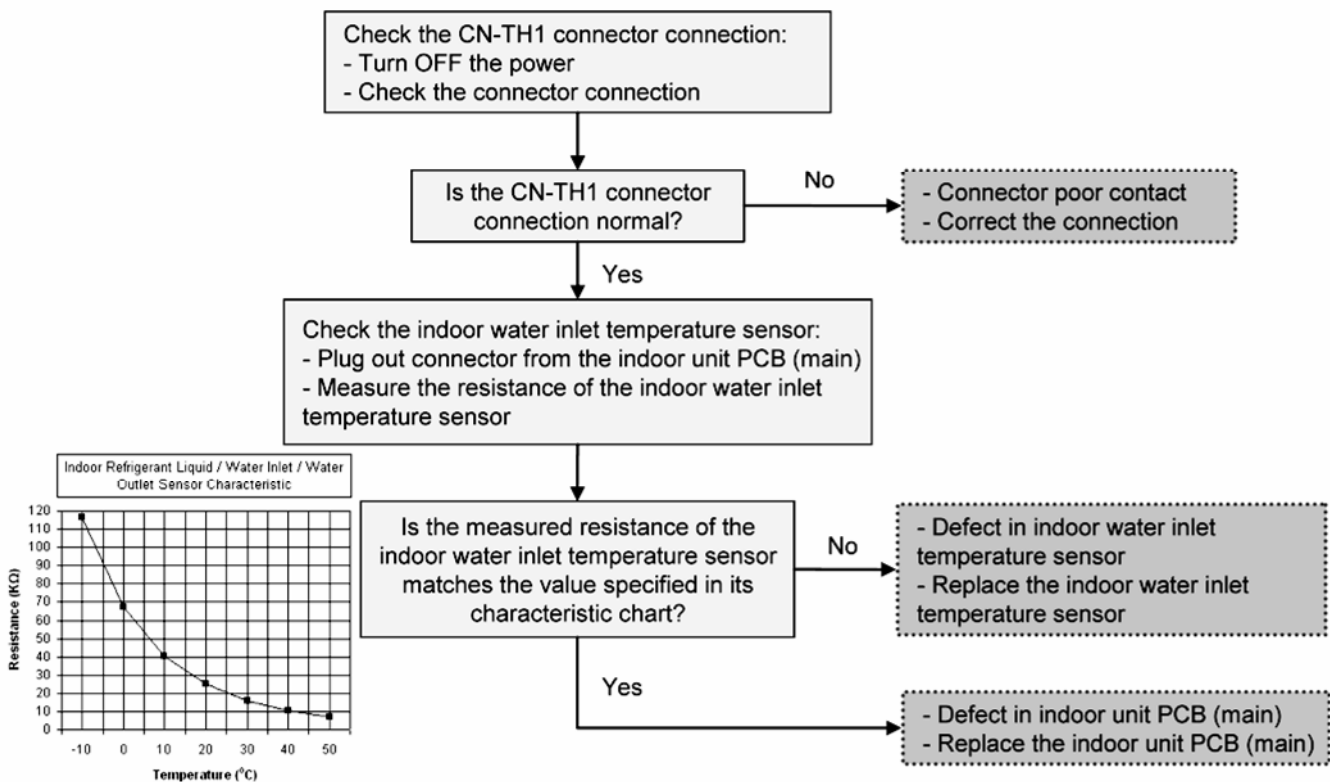

16.5.27 Outdoor Discharge Pipe Temperature Sensor Abnormality (F40)

Malfunction Decision Conditions:

During startup and operation of cooling and heating, the temperatures detected by the outdoor discharge pipe temperature sensor are used to determine sensor error.

Malfunction Caused:

- 1 Faulty connector connection.
- 2 Faulty sensor.
- 3 Faulty outdoor unit PCB (main).

Abnormality Judgment:

Continue for 5 seconds.

Troubleshooting:



Caution

For safety reason and to prevent component breakdown, always switch off the power before remove and connect the component.

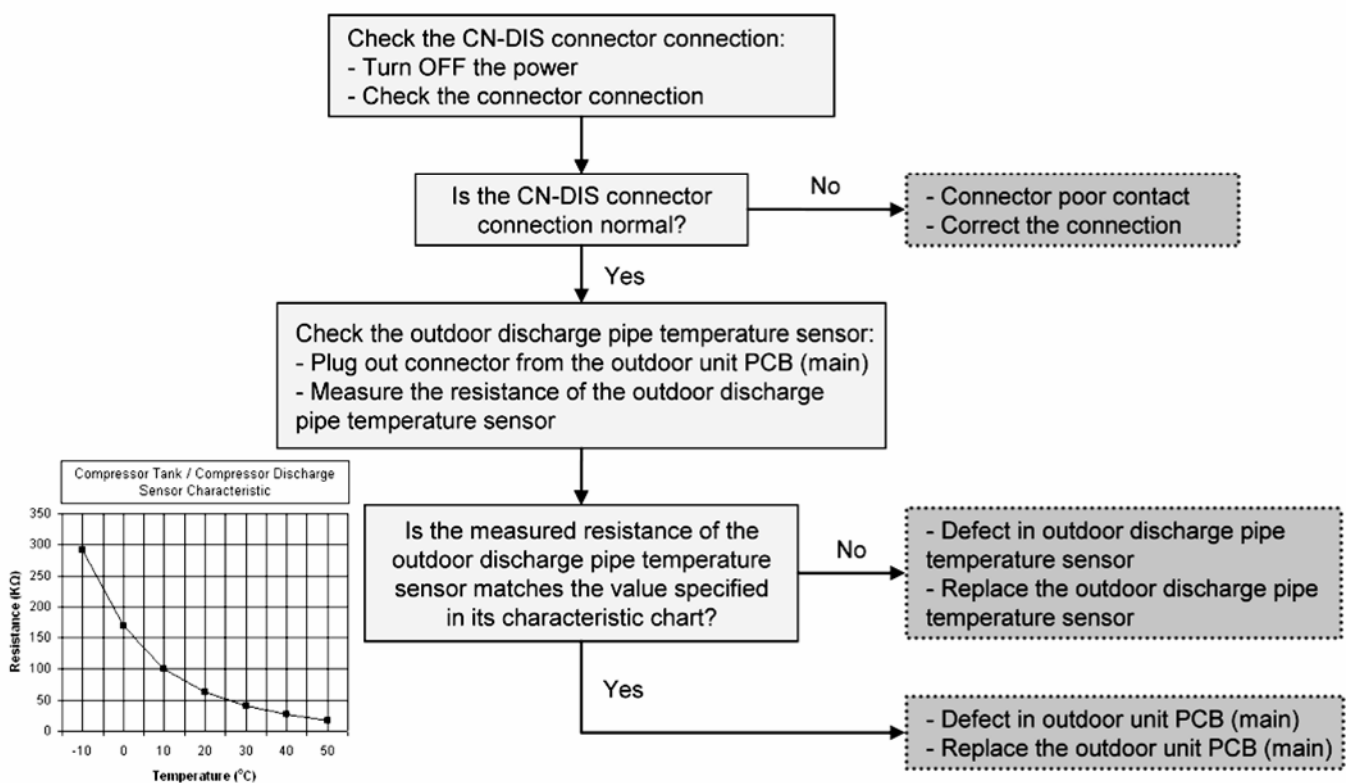

16.5.28 Power Factor Correction (PFC) Abnormality (F41)

Malfunction Decision Conditions:

During operation of cooling and heating, when the PFC protection circuitry in the outdoor unit PCB (main) senses abnormal high DC voltage level.

Malfunction Caused:

- 1 Power supply surge.
- 2 Compressor windings not uniform.
- 3 Faulty outdoor unit PCB (main).

Abnormality Judgment:

Continue 4 times in 10 minutes.

Troubleshooting:



Caution

For safety reason and to prevent component breakdown, always switch off the power before remove and connect the component.

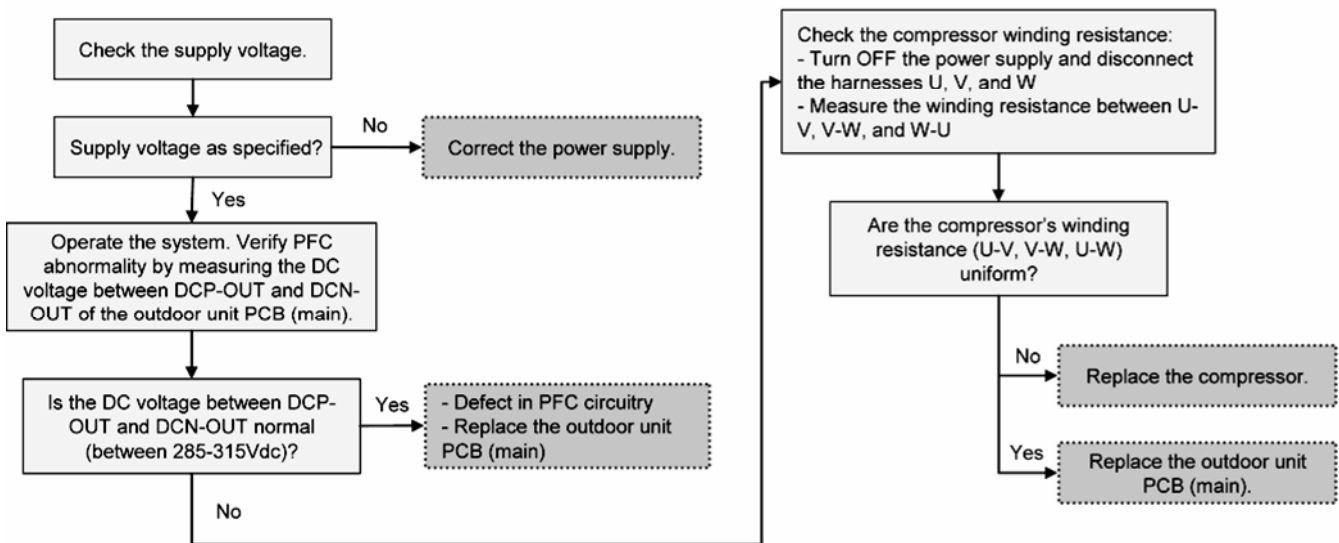

16.5.29 Outdoor Pipe Temperature Sensor Abnormality (F42)

Malfunction Decision Conditions:

During startup and operation of cooling and heating, the temperatures detected by the outdoor pipe temperature sensor are used to determine sensor error.

Malfunction Caused:

- 1 Faulty connector connection.
- 2 Faulty sensor.
- 3 Faulty outdoor unit PCB (main).

Abnormality Judgment:

Continue for 5 seconds.

Troubleshooting:



Caution

For safety reason and to prevent component breakdown, always switch off the power before remove and connect the component.

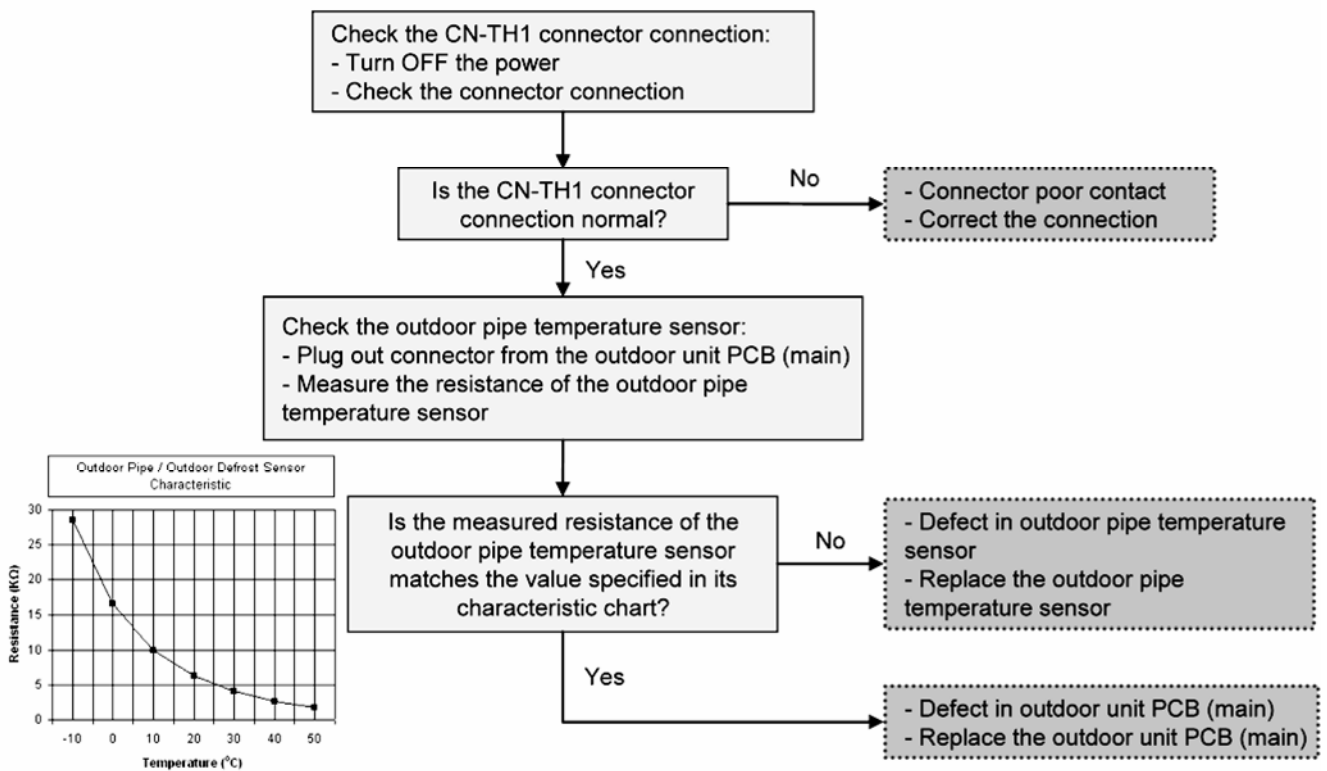

16.5.30 Outdoor Defrost Temperature Sensor Abnormality (F43)

Malfunction Decision Conditions:

During startup and operation of cooling and heating, the temperatures detected by the outdoor defrost temperature sensor are used to determine sensor error.

Malfunction Caused:

- 1 Faulty connector connection.
- 2 Faulty sensor.
- 3 Faulty outdoor unit PCB (main).

Abnormality Judgment:

Continue for 5 seconds.

Troubleshooting:



Caution

For safety reason and to prevent component breakdown, always switch off the power before remove and connect the component.

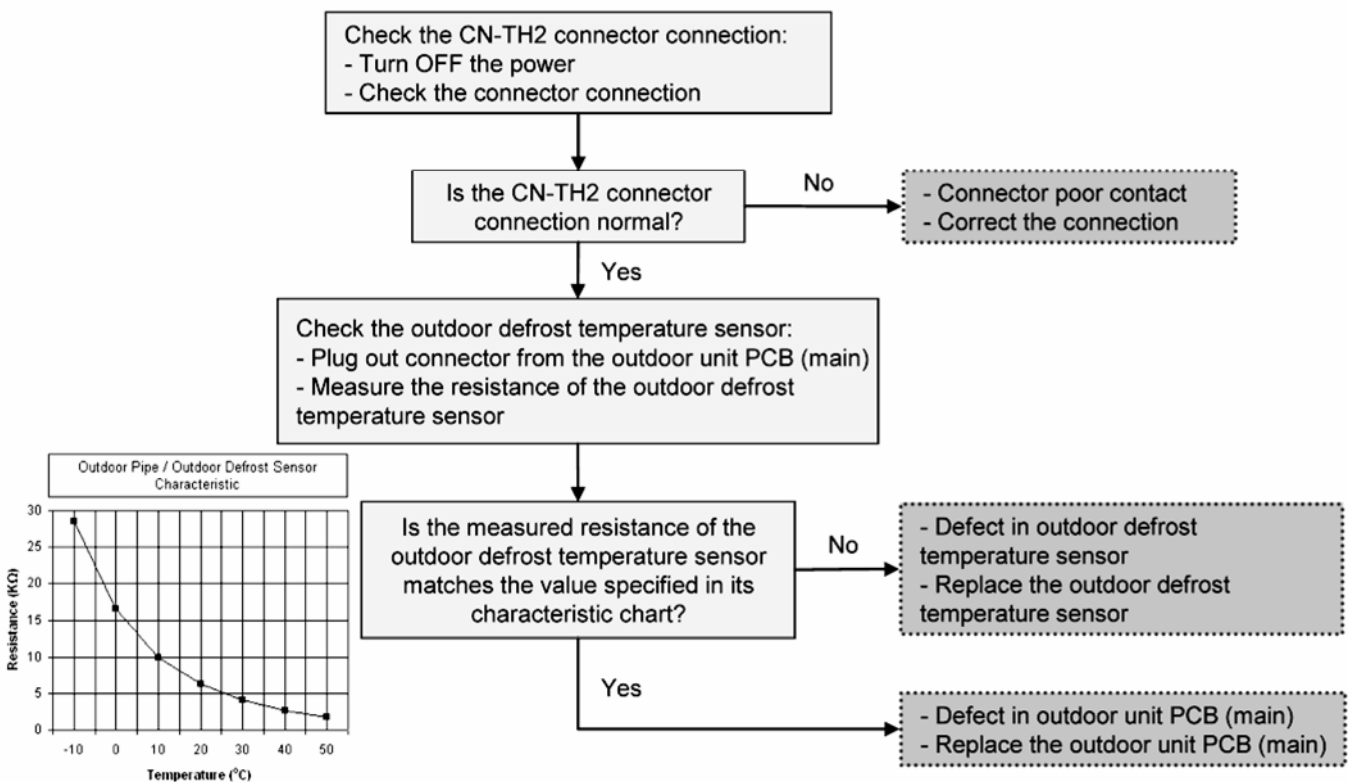

16.5.31 Indoor Water Outlet Temperature Sensor Abnormality (F45)

Malfunction Decision Conditions:

During startup and operation of cooling and heating, the temperatures detected by the indoor water outlet temperature sensor are used to determine sensor errors.

Malfunction Caused:

- 1 Faulty connector connection.
- 2 Faulty sensor.
- 3 Faulty indoor unit PCB (main).

Abnormality Judgment:

Continue for 5 seconds.

Troubleshooting:



Caution

For safety reason and to prevent component breakdown, always switch off the power before remove and connect the component.

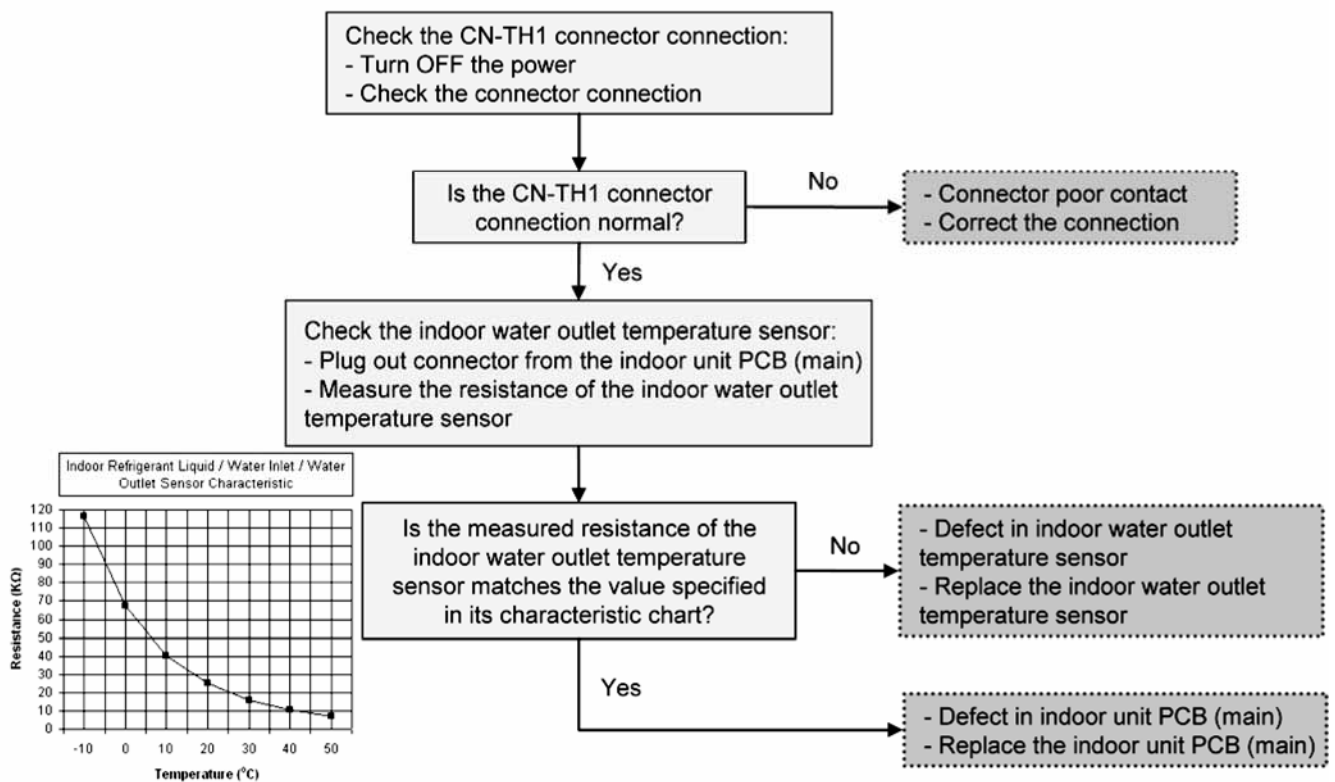

16.5.32 Outdoor Current Transformer Open Circuit (F46)

Malfunction Decision Conditions:

A current transformer (CT) open circuit is detected by checking the compressor running frequency (\geq rated frequency) and CT detected input current ($< 0.65A$) for continuously 20 seconds.

Malfunction Caused:

- 1 CT defective.
- 2 Faulty outdoor unit PCB (main).
- 3 Compressor defective (low compression).

Abnormality Judgment:

Continue 3 times in 20 minutes.

Troubleshooting:



For safety reason and to prevent component breakdown, always switch off the power before remove and connect the component.

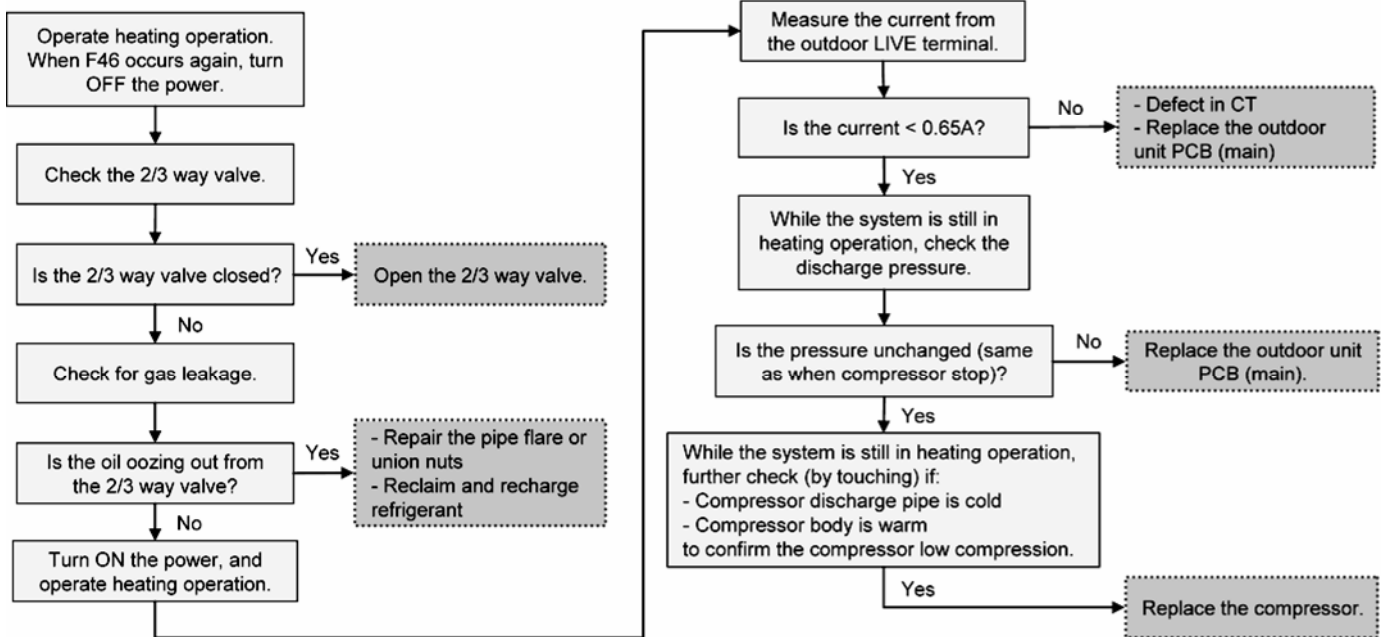

16.5.33 Cooling High Pressure Overload Protection (F95)

Malfunction Decision Conditions:

During operation of cooling, when pressure 4.0MPa and above is detected by outdoor high pressure sensor.

Malfunction Caused:

- 1 Dust accumulation in the outdoor unit heat exchanger.
- 2 Air short circuit at outdoor unit.
- 3 2 way valve closed.
- 4 Faulty outdoor unit fan motor.
- 5 Clogged expansion valve or strainer.
- 6 Excessive refrigerant.
- 7 Faulty outdoor high pressure sensor.
- 8 Faulty outdoor unit PCB (main).

Troubleshooting:



Caution

For safety reason and to prevent component breakdown, always switch off the power before remove and connect the component.

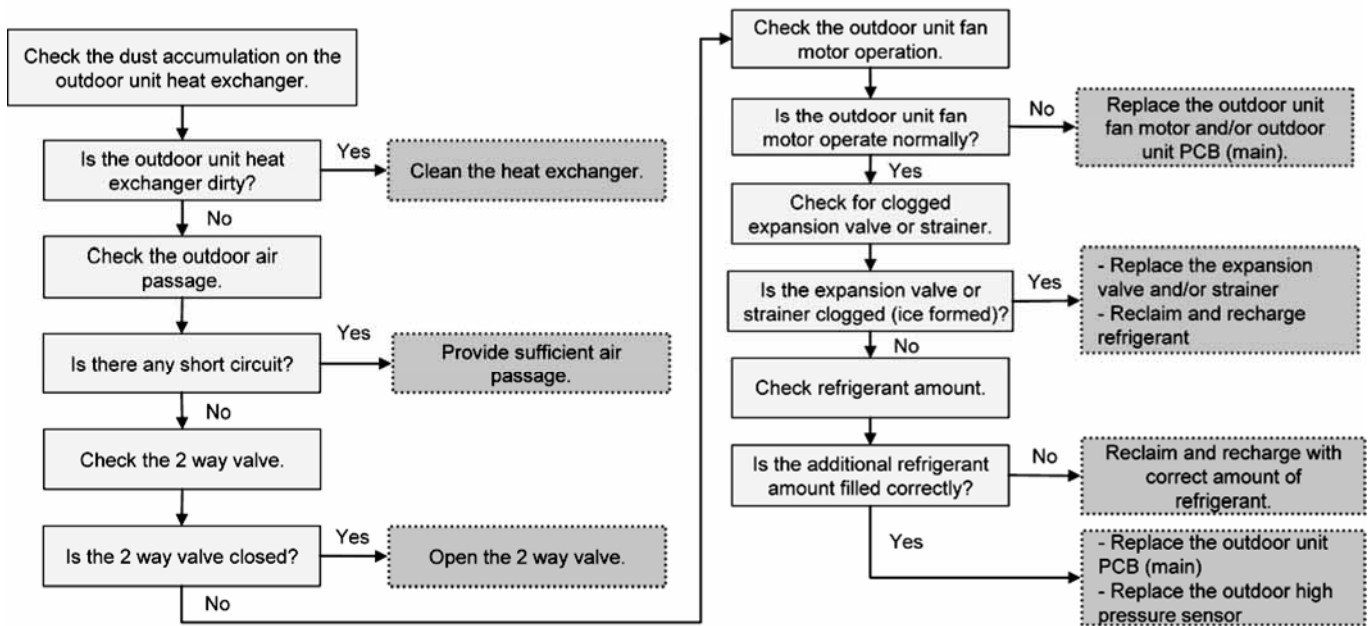

17. Disassembly and Assembly Instructions



WARNING

High Voltage are generated in the electrical parts area by the capacitor. Ensure that the capacitor has discharged sufficiently before proceeding with repair work. Failure to heed this caution may result in electric shocks.

17.1 To Remove Front Plate

Please follow the steps below for take out front plate. Before removing the front plate of indoor unit, always switch off all power supply (i.e. indoor unit power supply, heater power supply and boiler tank power supply).

- 1 Remove the 2 mounting screws which located at bottom of the front plate and 1 mounting screw at the front of the plate.
- 2 Gently pull the lower section of the front plate towards you to remove the front plate from left and right hooks.
- 3 Hold the left edge and right edge of front plate to lift up front plate from hooks.

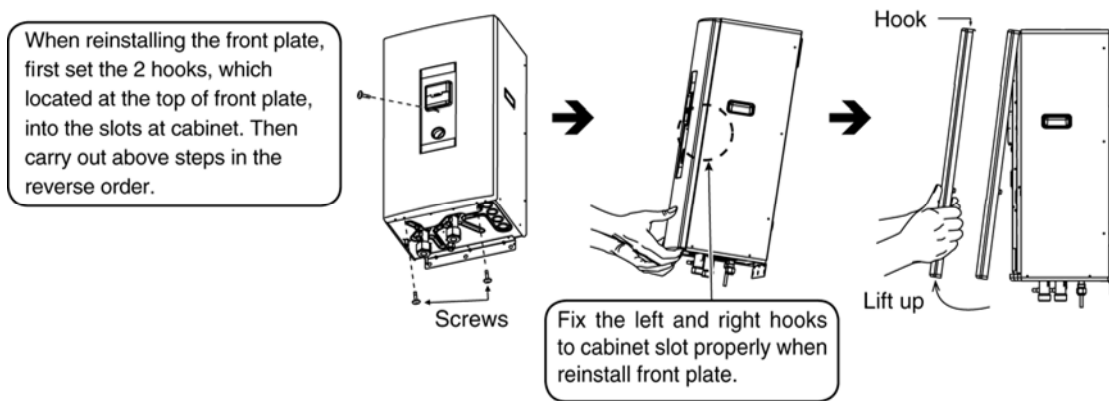

17.2 To Remove Cabinet

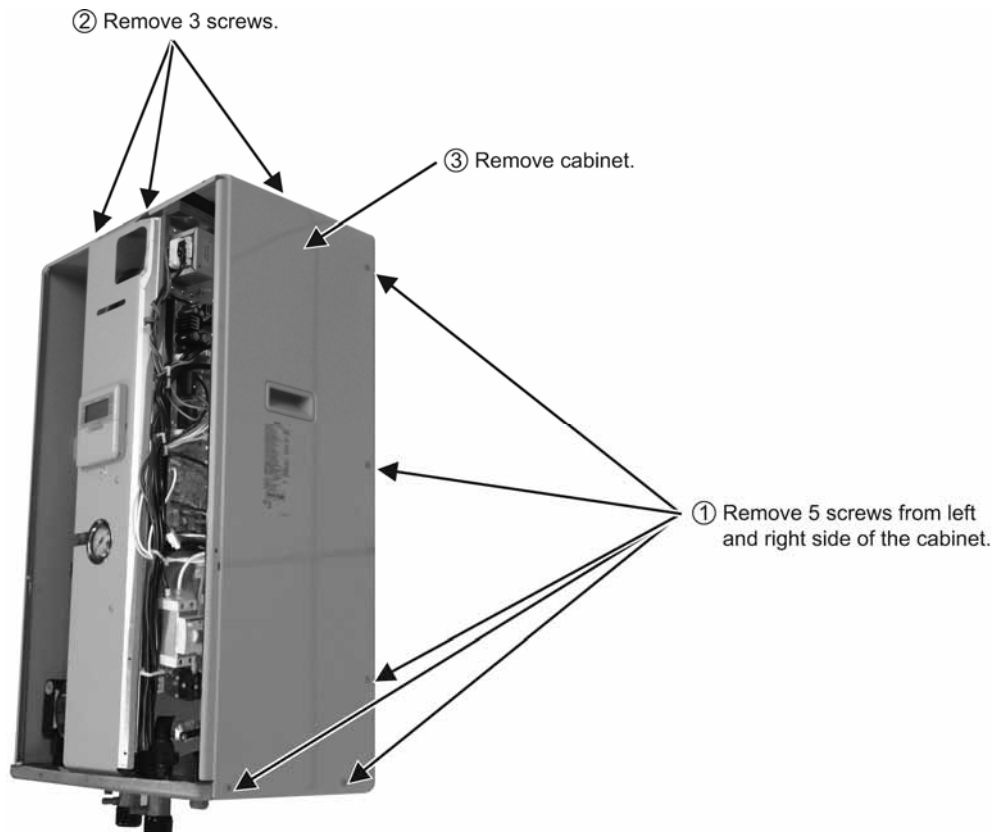

17.3 To Remove Pressure Gauge

① Remove 3 screws.



② Use spanner to release nut of pressure gauge.

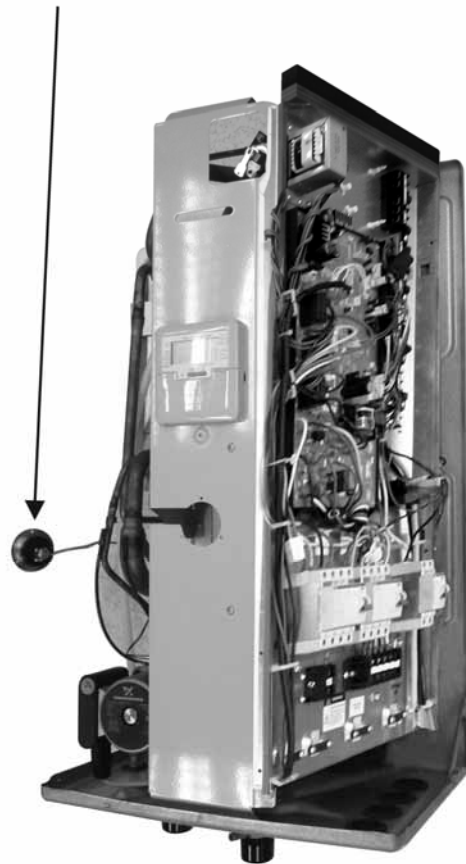

17.4 To Remove Control Panel

Control Panel

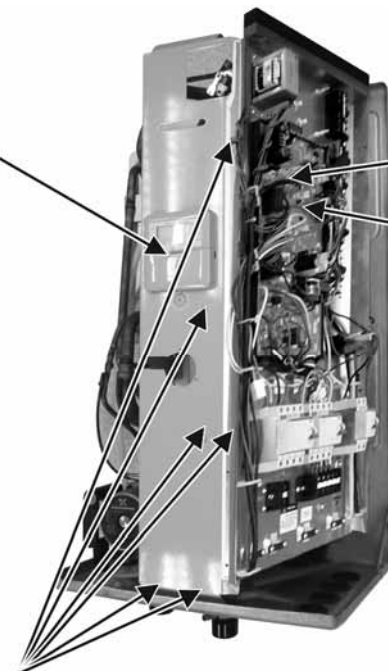

① Disconnect the connector of CN-REMOTE (WHT) from the Electronic Controller Board.

Electronic Controller Board

② Remove 6 screws to remove Control Panel.

17.5 To Remove RCCB

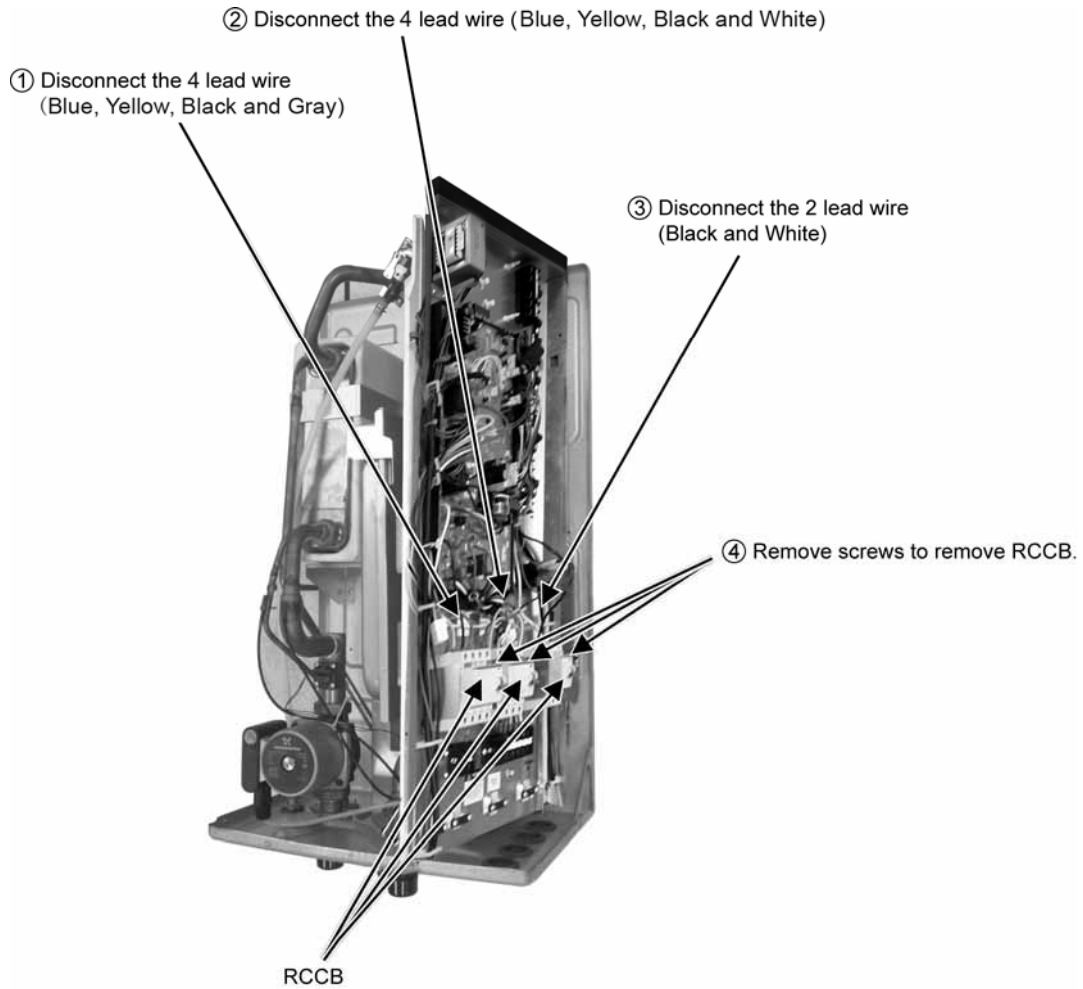

17.6 To Remove Transformer and Electronic Controller Board

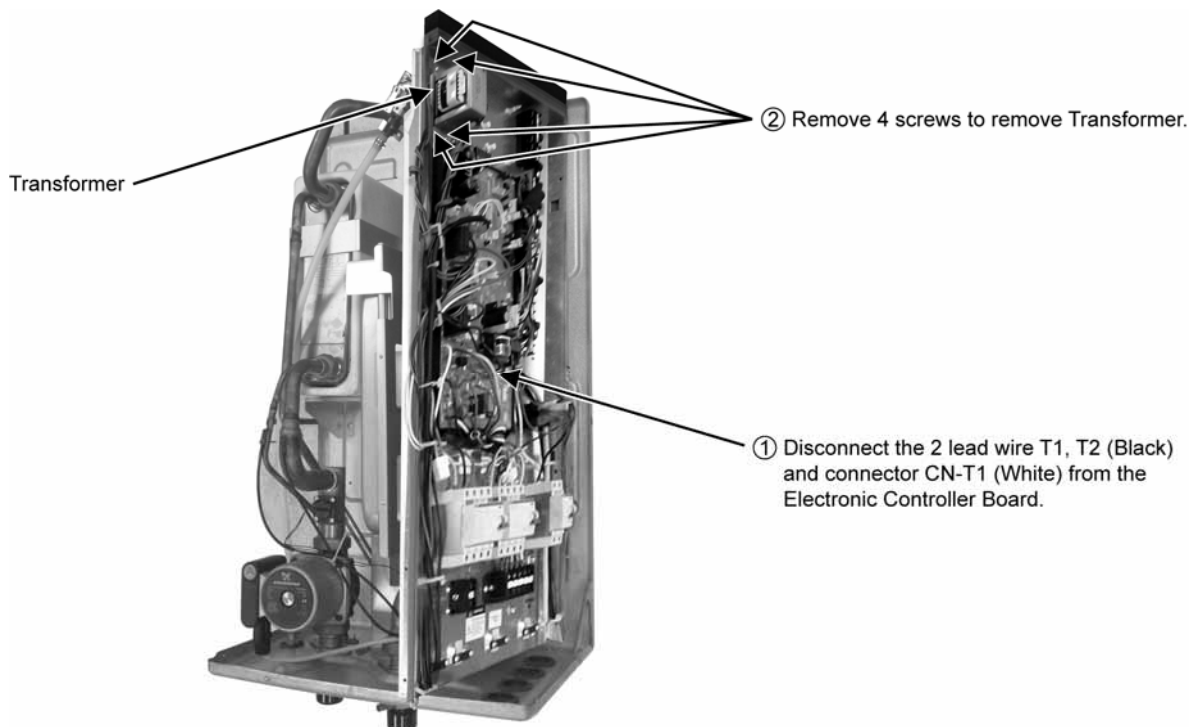

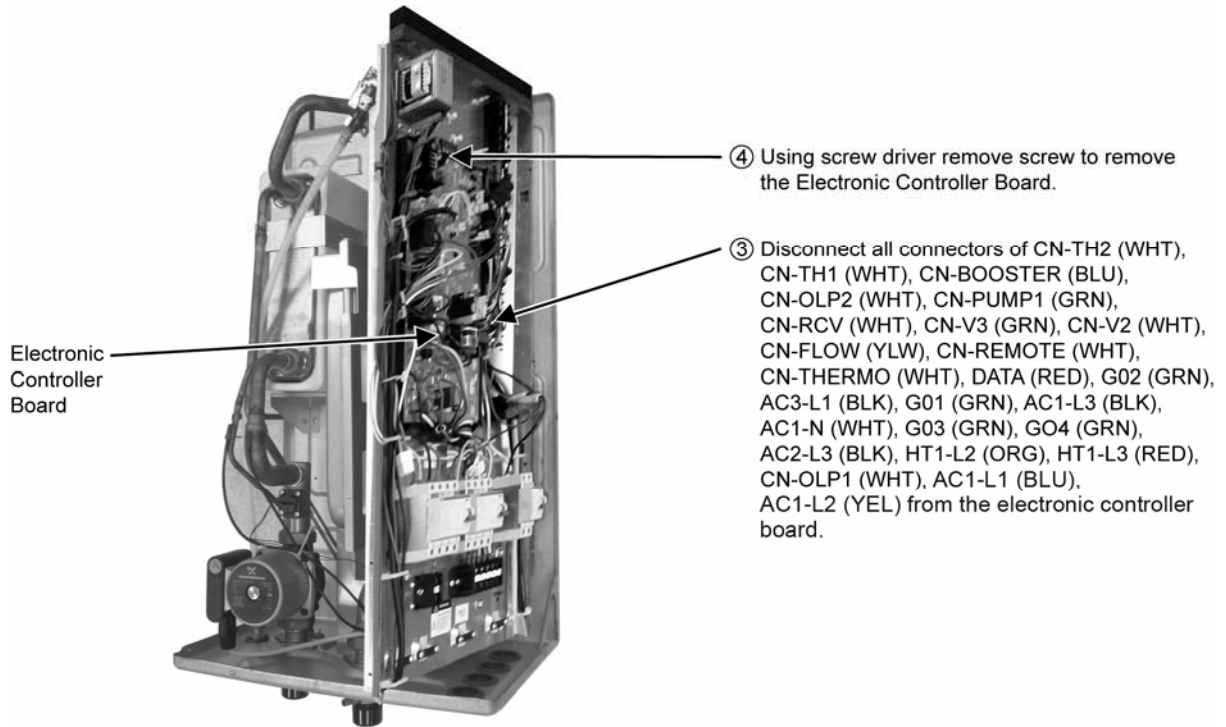

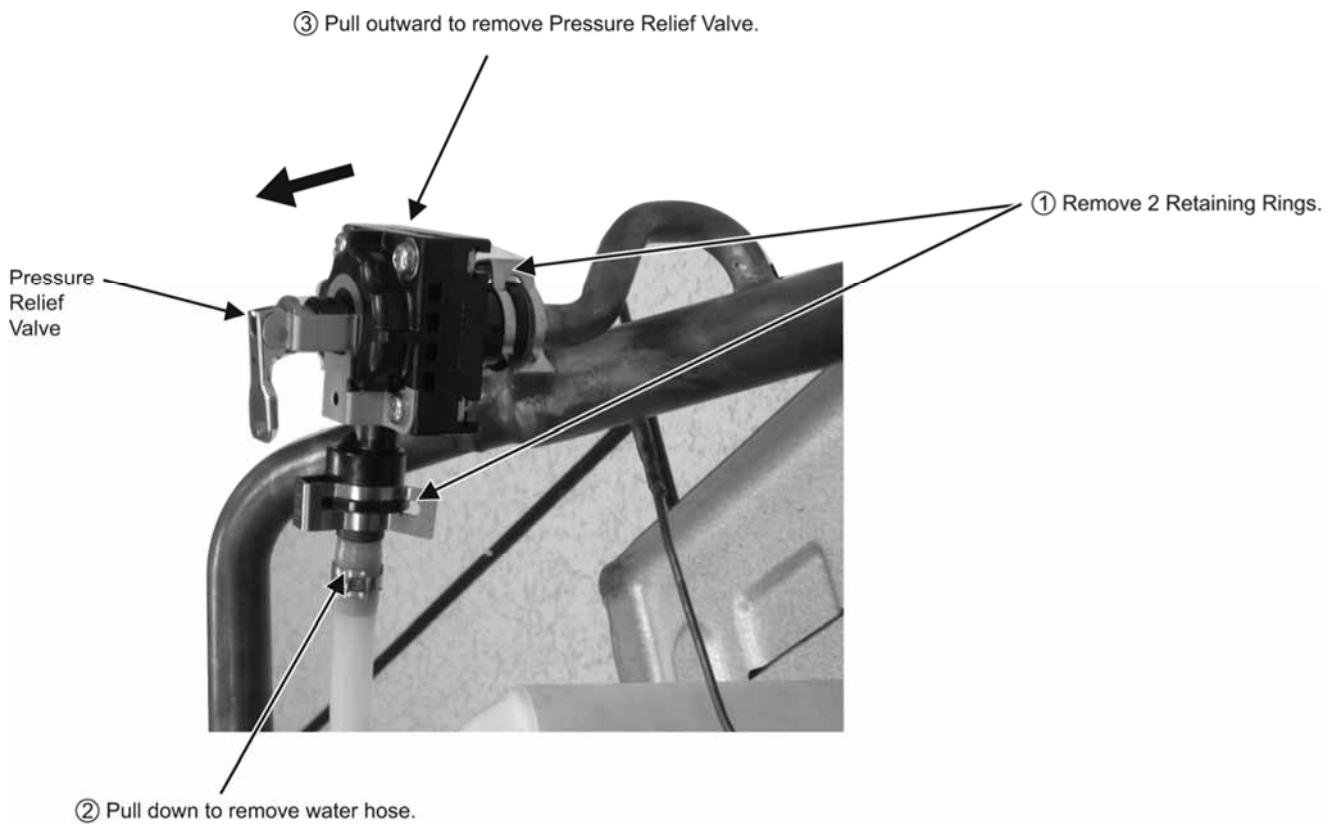

17.7 To Remove Pressure Relief Valve, Flow Switch, Water Pump and Bottle Complete

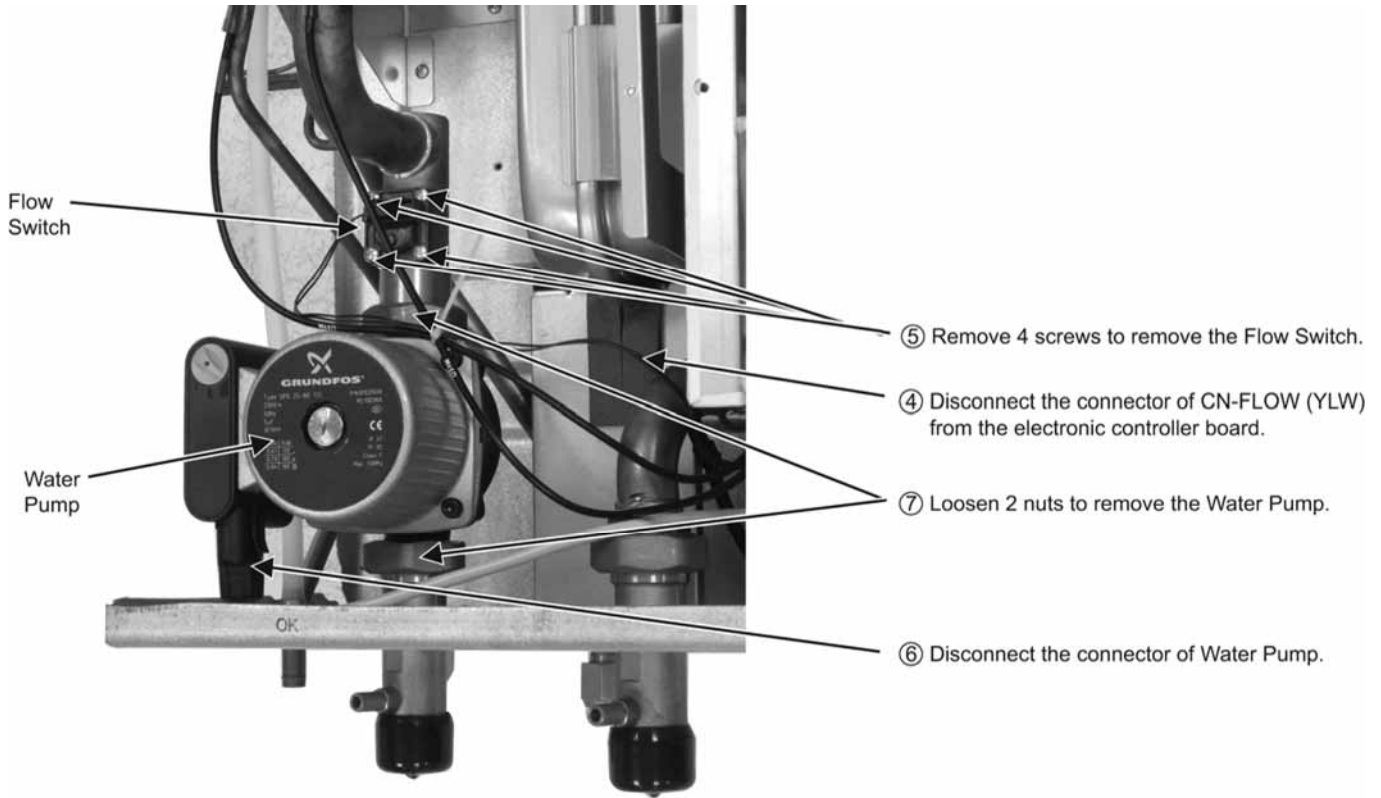

⚠ When reinstall the water pipe, use grease or water at the joining.



 When reinstall the water pipe, use grease or water at the joining.

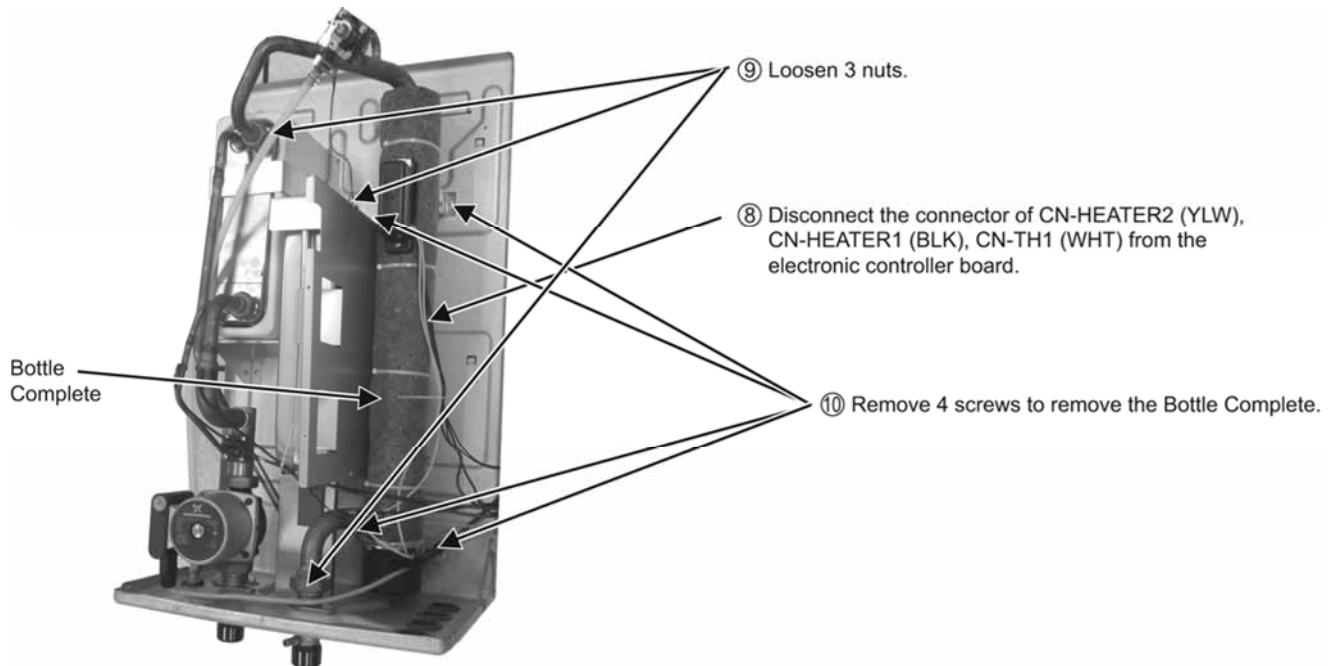

 When reinstall the water pipe, use grease or water at the joining.

18. Technical Data

18.1 Operation Characteristics

18.1.1 WH-SDC09C3E8 WH-UD09CE8

Heating Characteristics at Different Outdoor Air Temperature

Condition

Outdoor air temperature : 7°C (DBT), 6°C (WBT)

Indoor water inlet temperature : 30°C

Indoor water outlet temperature : 35°C

Piping length : 7m

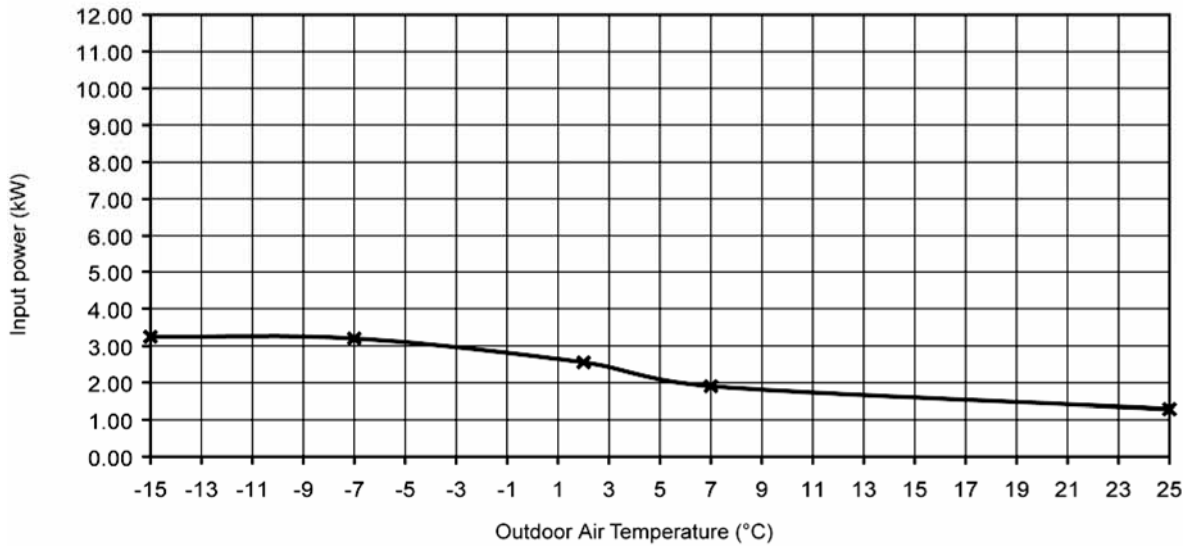
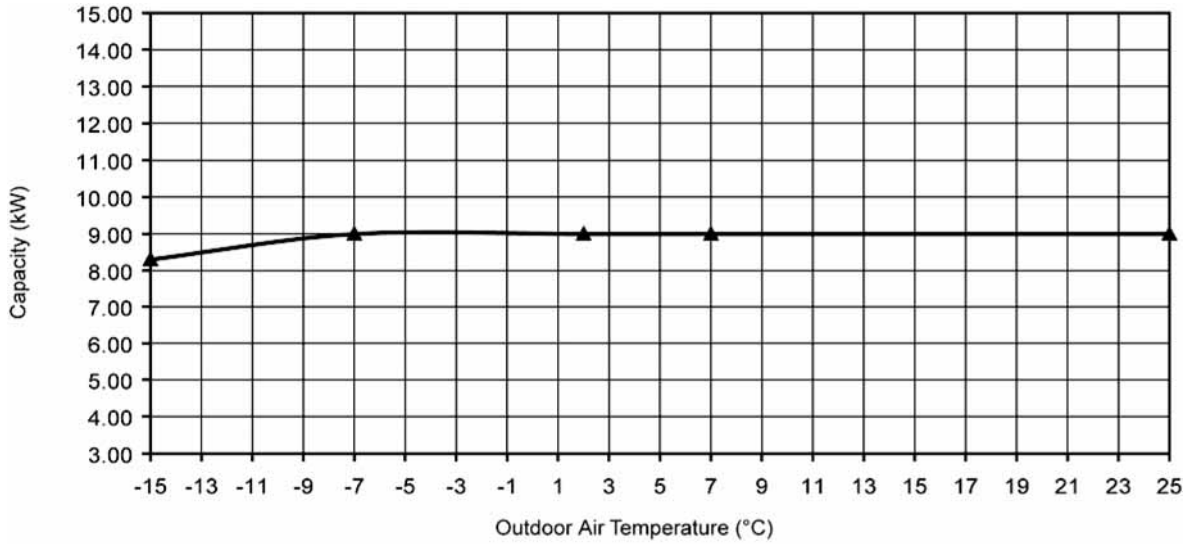

Cooling Characteristics at Different Outdoor Air Temperature

Condition

Outdoor air temperature : 35°C (DBT), -°C (WBT)

Indoor water inlet temperature : 12°C

Indoor water outlet temperature : 7°C

Piping length : 7m

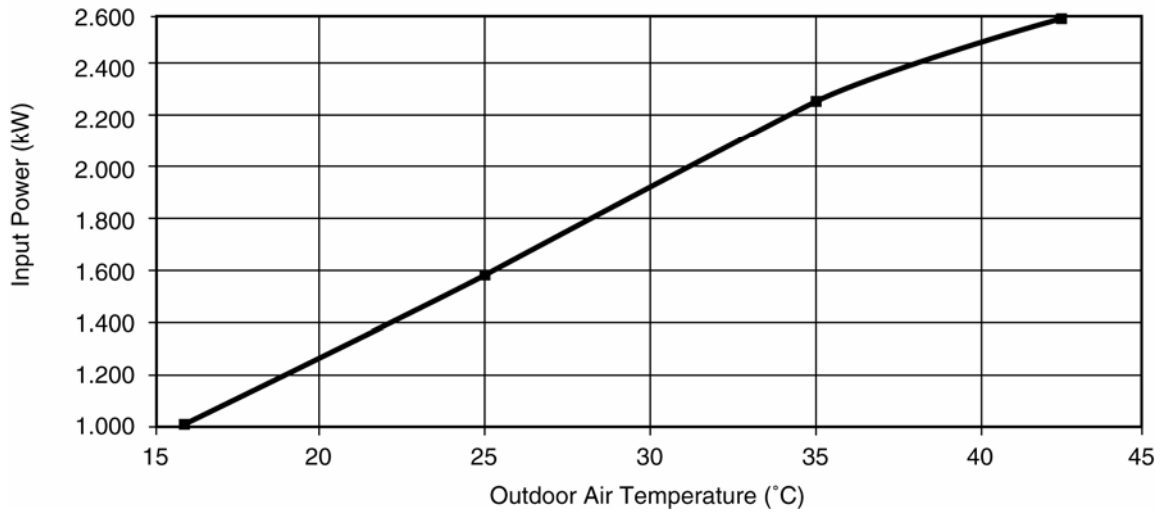
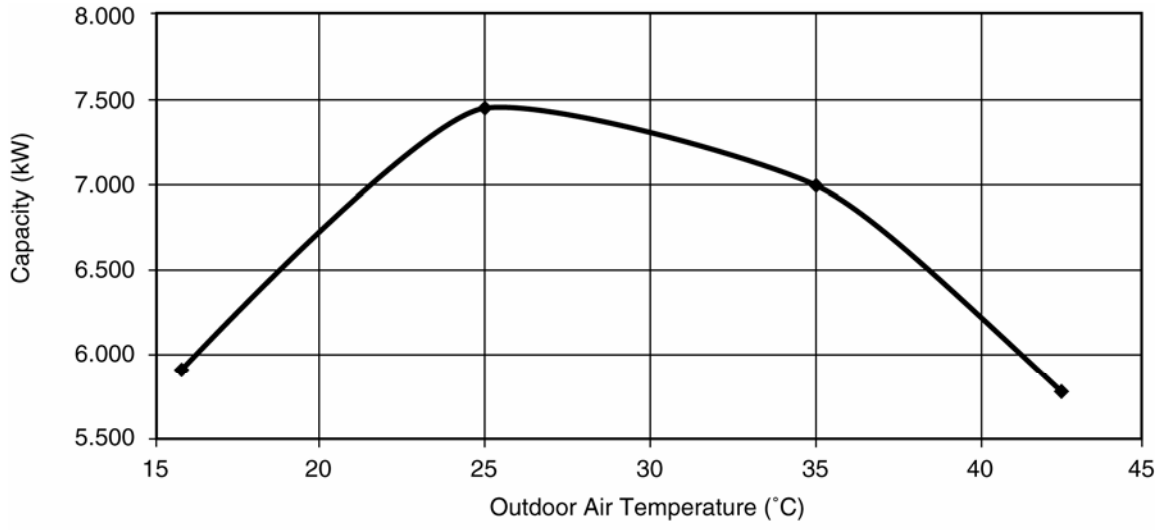

Heating Characteristics at Different Piping Length

Condition

Outdoor air temperature : 7°C (DBT), 6°C (WBT)

Indoor water inlet temperature : 30°C

Indoor water outlet temperature : 35°C

Piping length : 7m

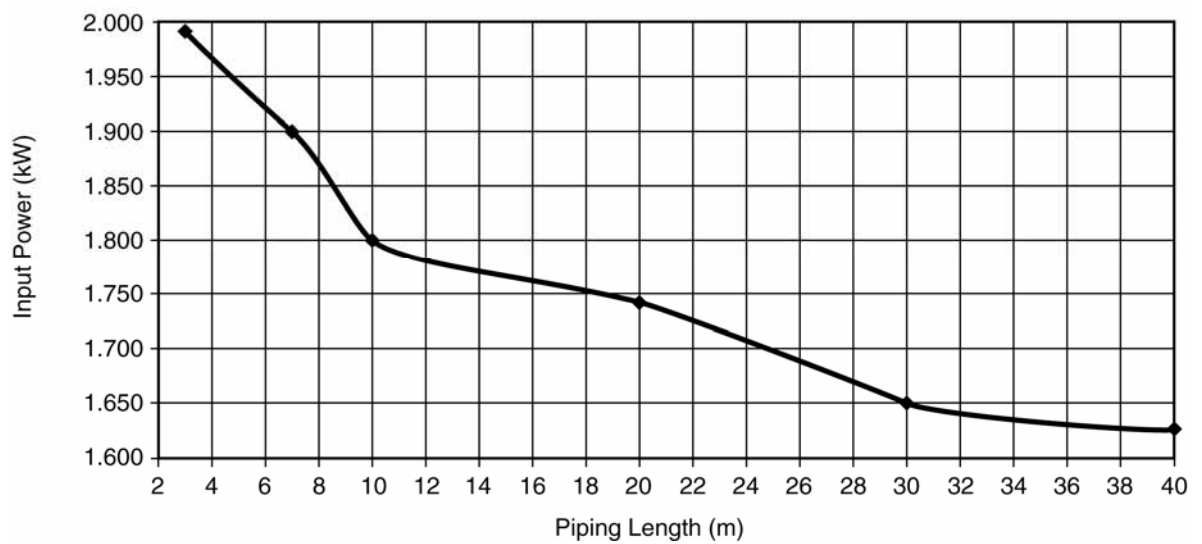
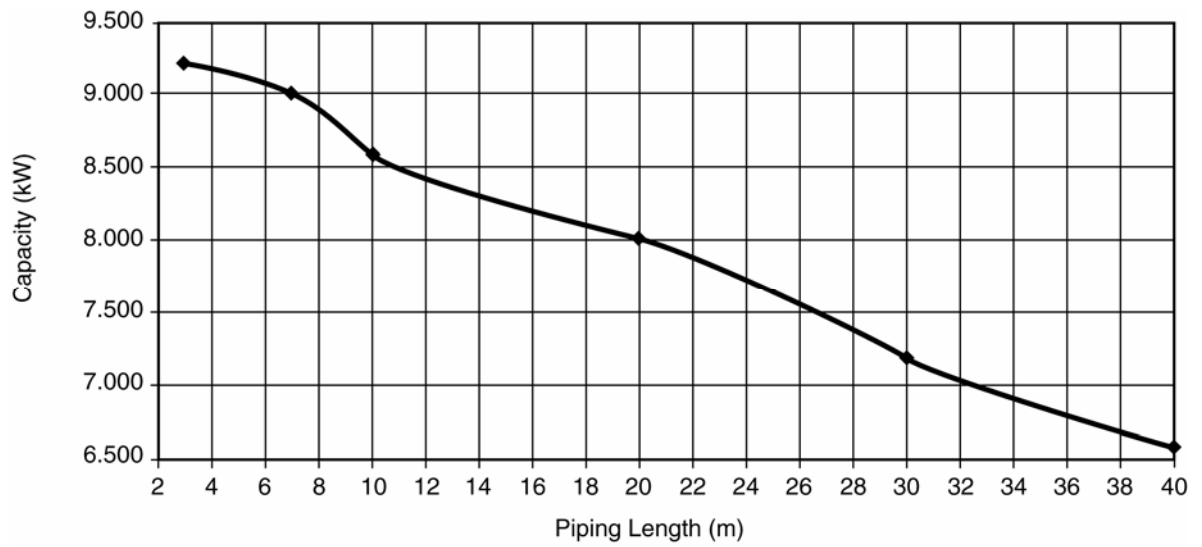

Cooling Characteristics at Different Piping Length

Condition

Outdoor air temperature : 35°C (DBT), -°C (WBT)

Indoor water inlet temperature : 12°C

Indoor water outlet temperature : 7°C

Piping length : 7m

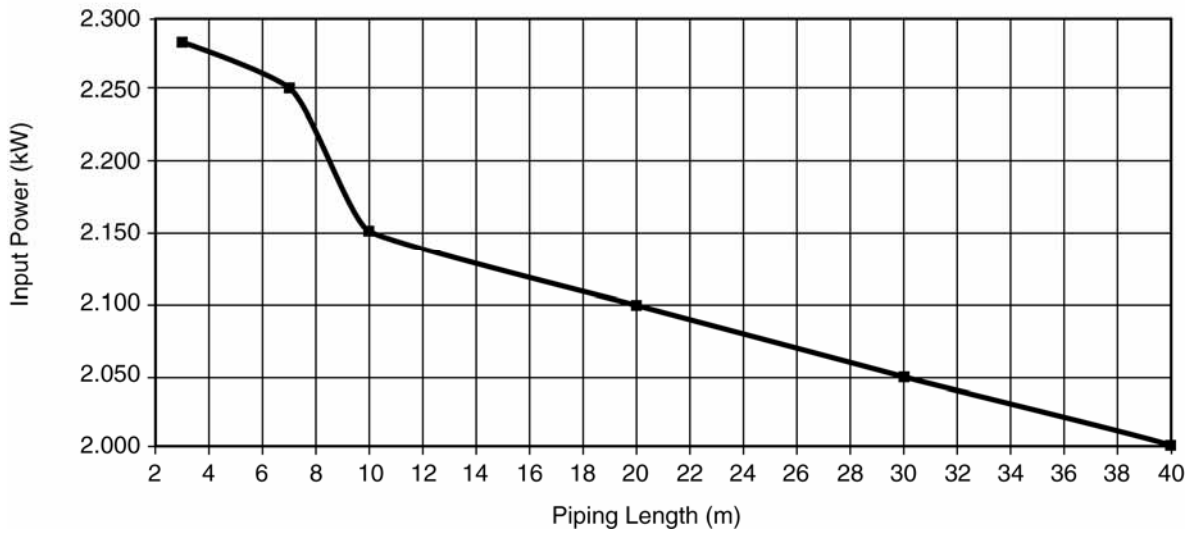
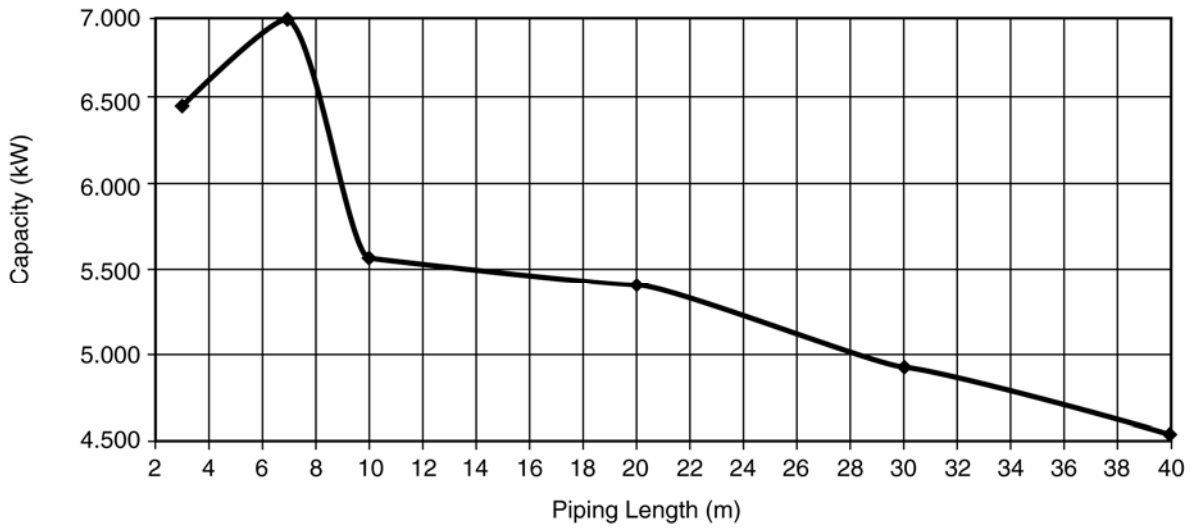

18.1.2 WH-SDC12C9E8 WH-UD12CE8

Heating Characteristics at Different Outdoor Air Temperature

Condition

Outdoor air temperature : 7°C (DBT), 6°C (WBT)

Indoor water inlet temperature : 30°C

Indoor water outlet temperature : 35°C

Piping length : 7m

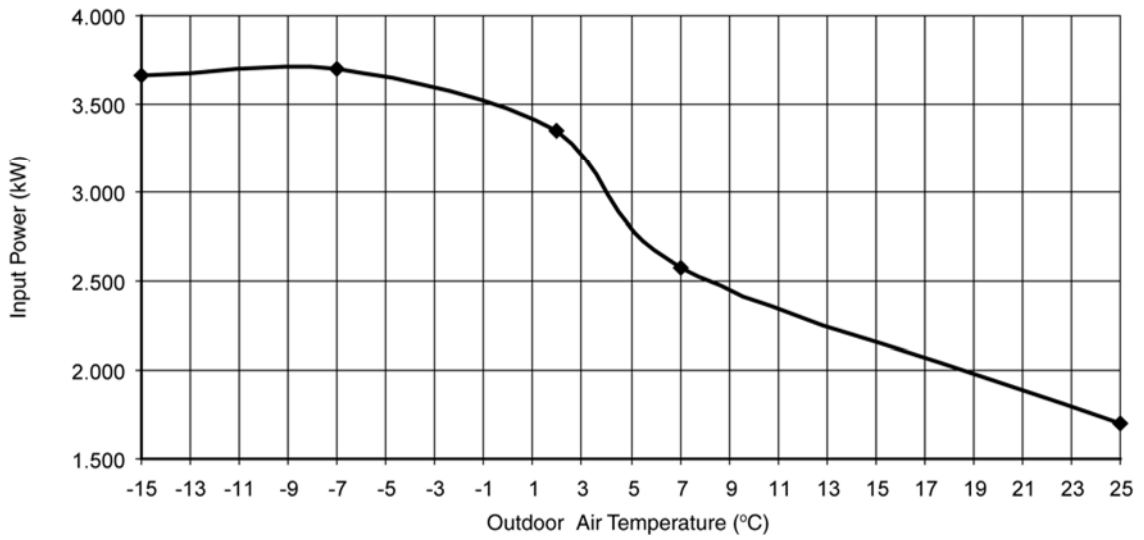
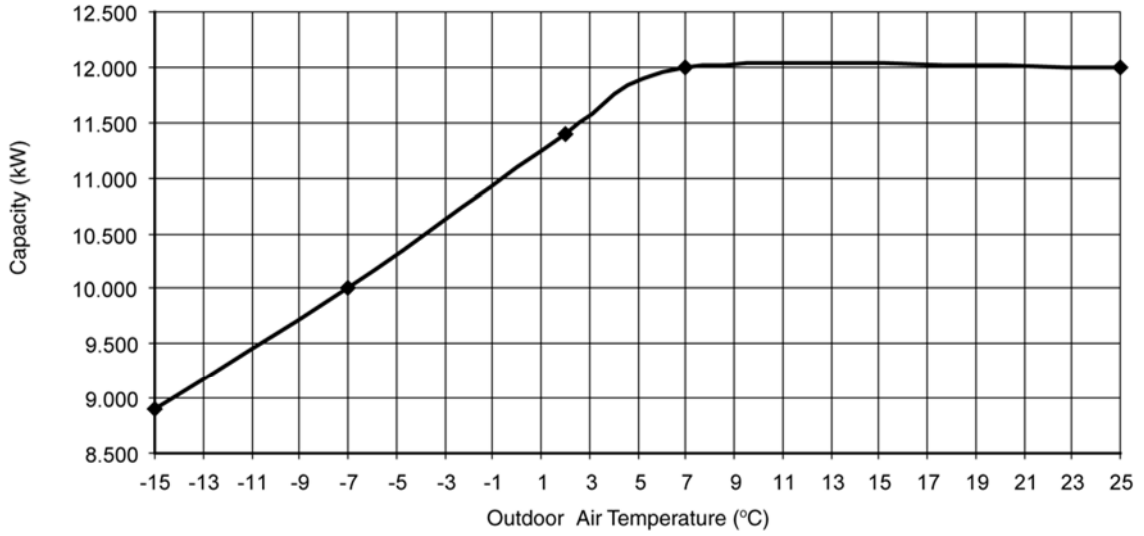

Cooling Characteristics at Different Outdoor Air Temperature

Condition

Outdoor air temperature : 35°C (DBT), -°C (WBT)

Indoor water inlet temperature : 12°C

Indoor water outlet temperature : 7°C

Piping length : 7m

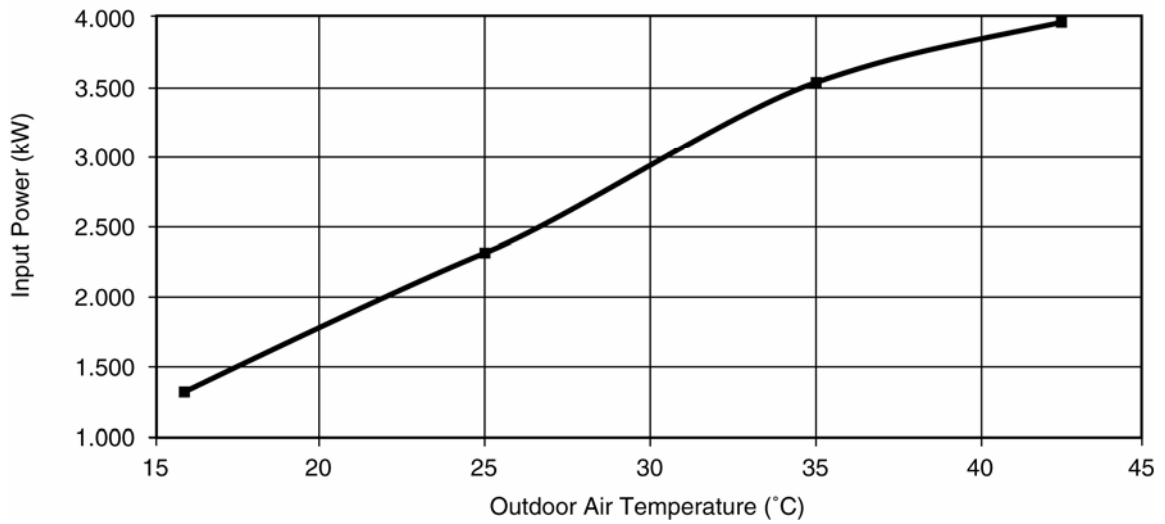
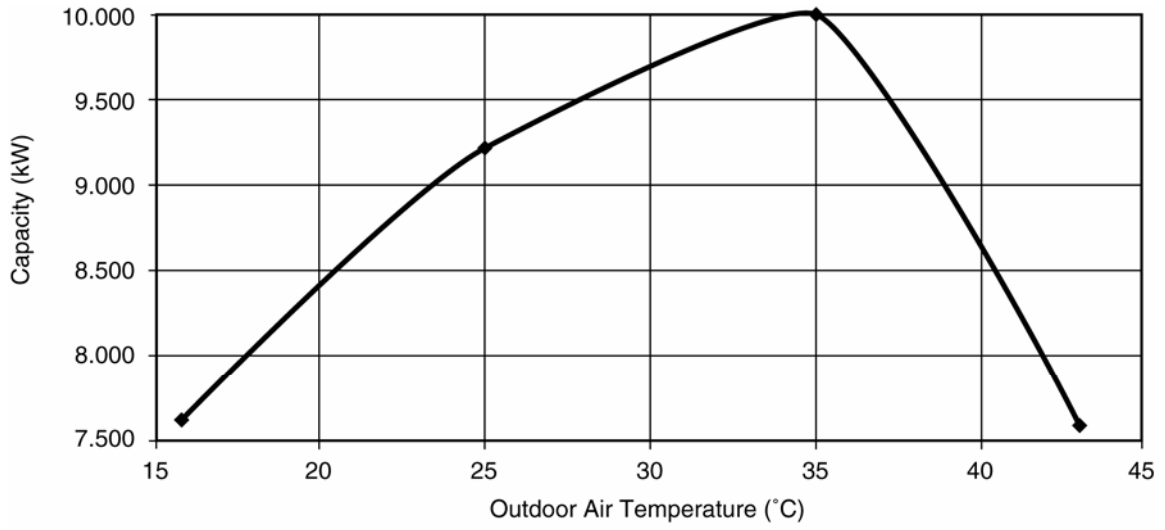

Heating Characteristics at Different Piping Length

Condition

Outdoor air temperature : 7°C (DBT), 6°C (WBT)

Indoor water inlet temperature : 30°C

Indoor water outlet temperature : 35°C

Piping length : 7m

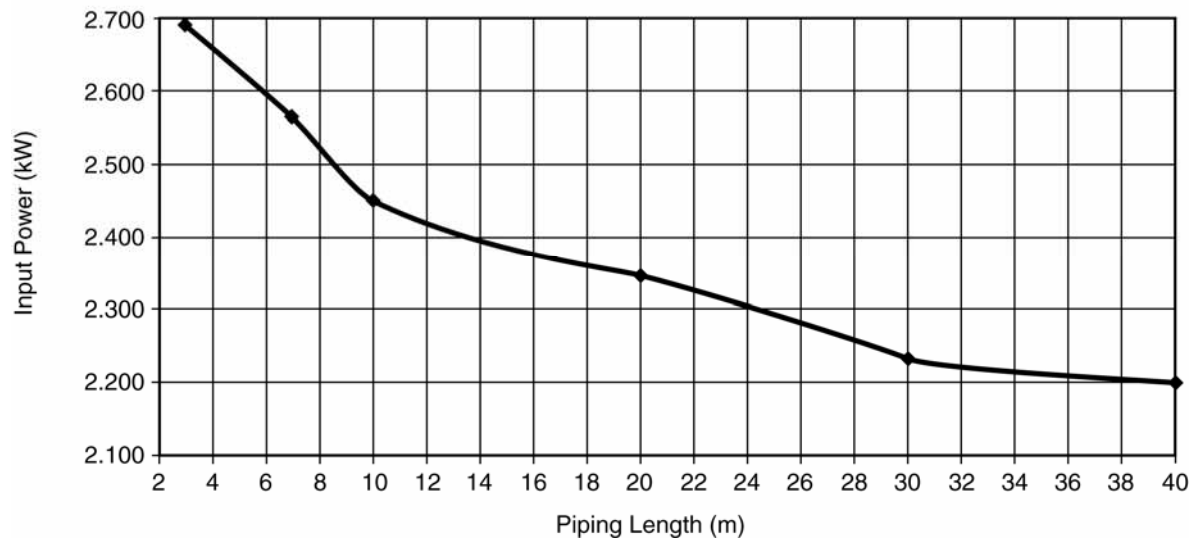
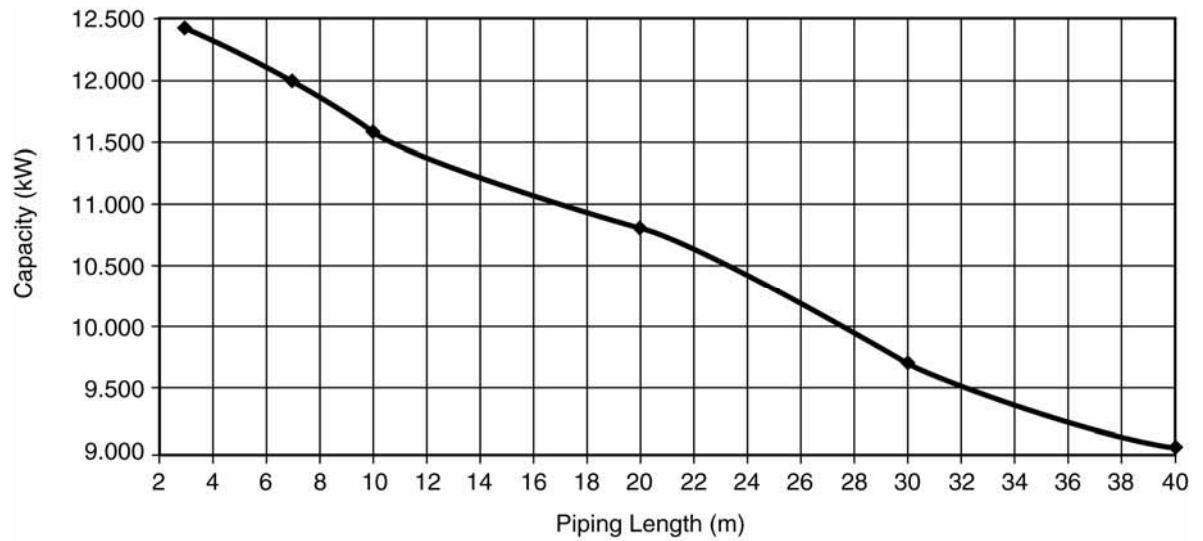

Cooling Characteristics at Different Piping Length

Condition

Outdoor air temperature : 35°C (DBT), -°C (WBT)

Indoor water inlet temperature : 12°C

Indoor water outlet temperature : 7°C

Piping length : 7m

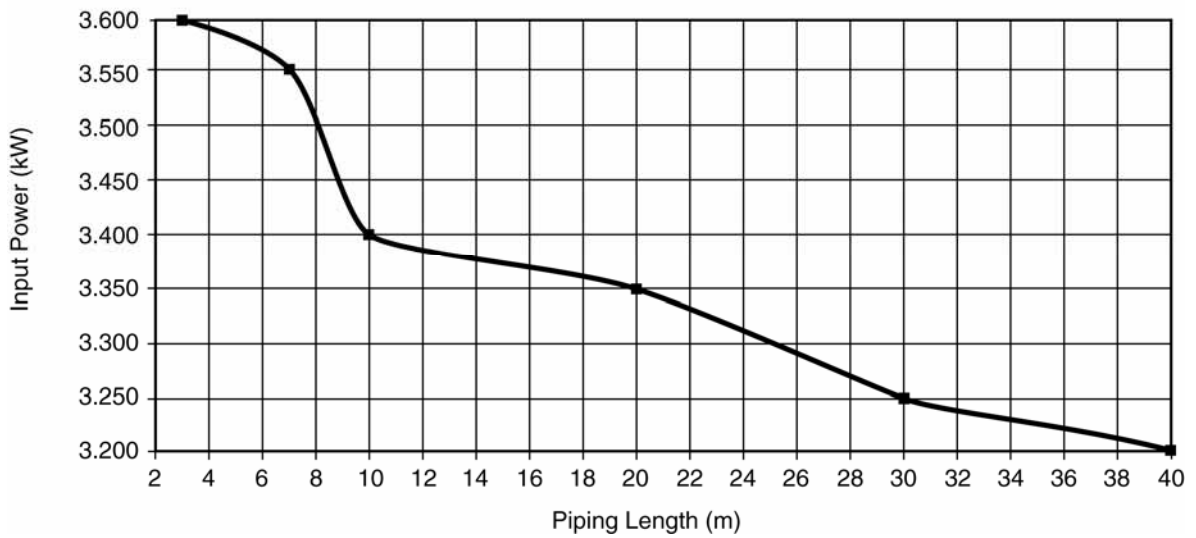
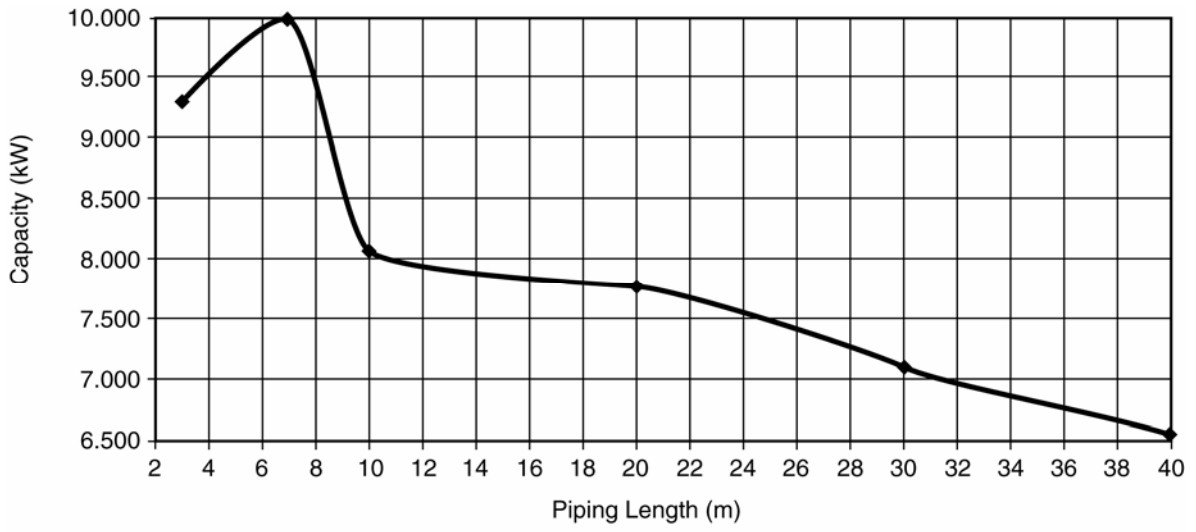

18.1.3 WH-SDC14C9E8 WH-UD14CE8

Heating Characteristics at Different Outdoor Air Temperature

Condition

Outdoor air temperature : 7°C (DBT), 6°C (WBT)

Indoor water inlet temperature : 30°C

Indoor water outlet temperature : 35°C

Piping length : 7m

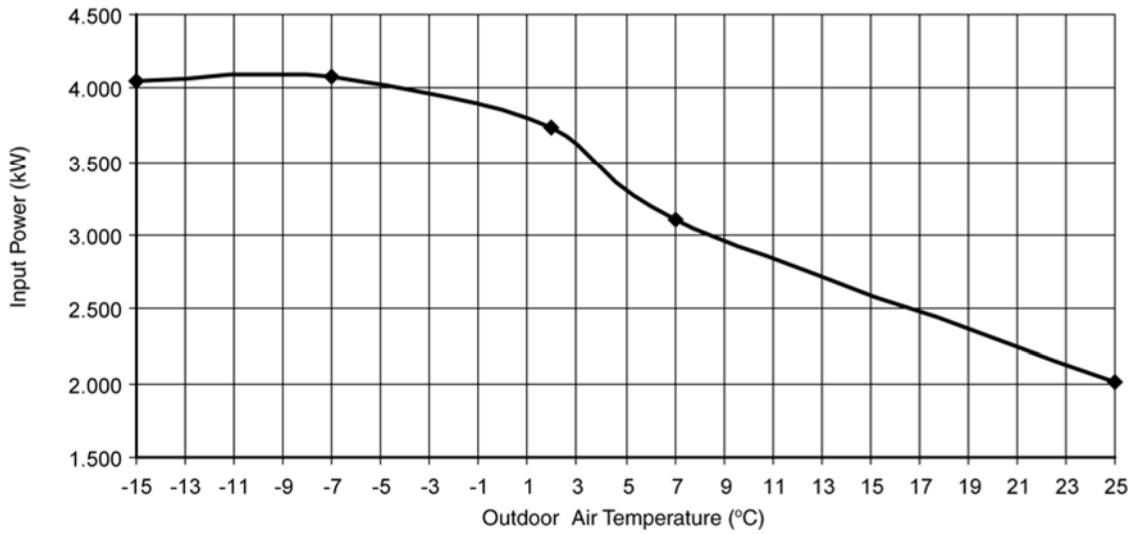
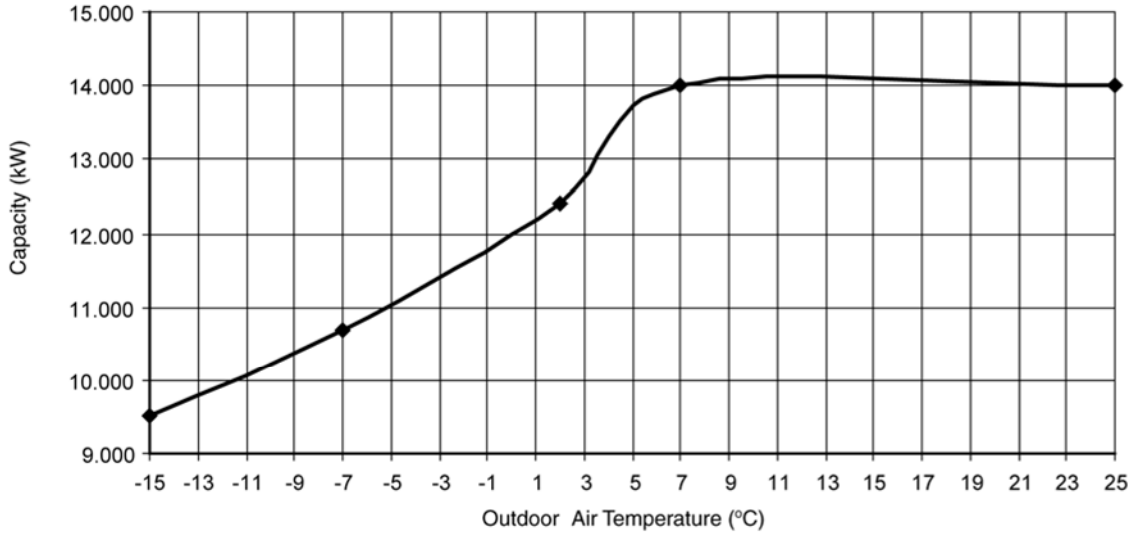

Cooling Characteristics at Different Outdoor Air Temperature

Condition

Outdoor air temperature : 35°C (DBT), -°C (WBT)

Indoor water inlet temperature : 12°C

Indoor water outlet temperature : 7°C

Piping length : 7m

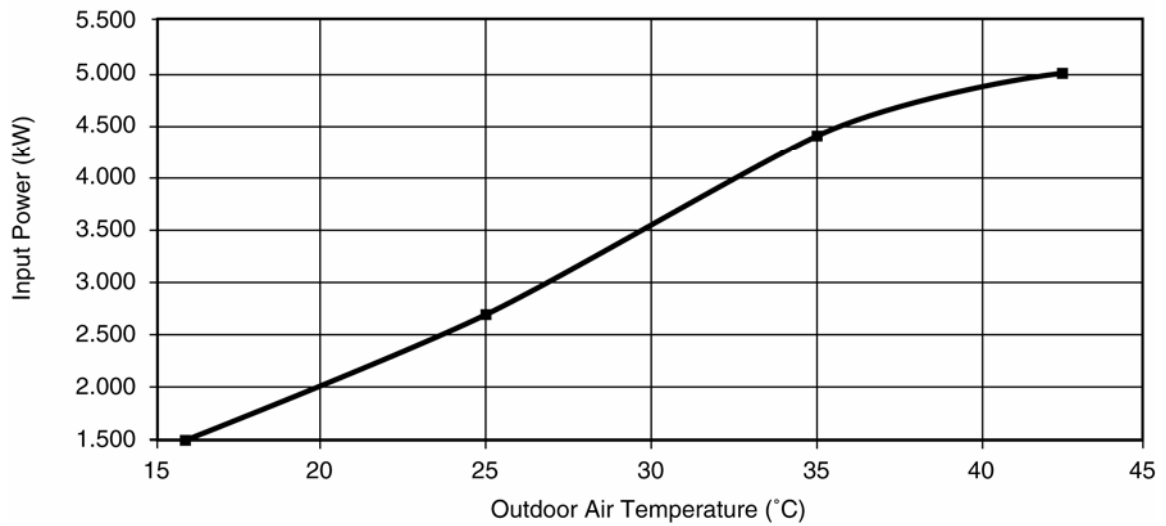
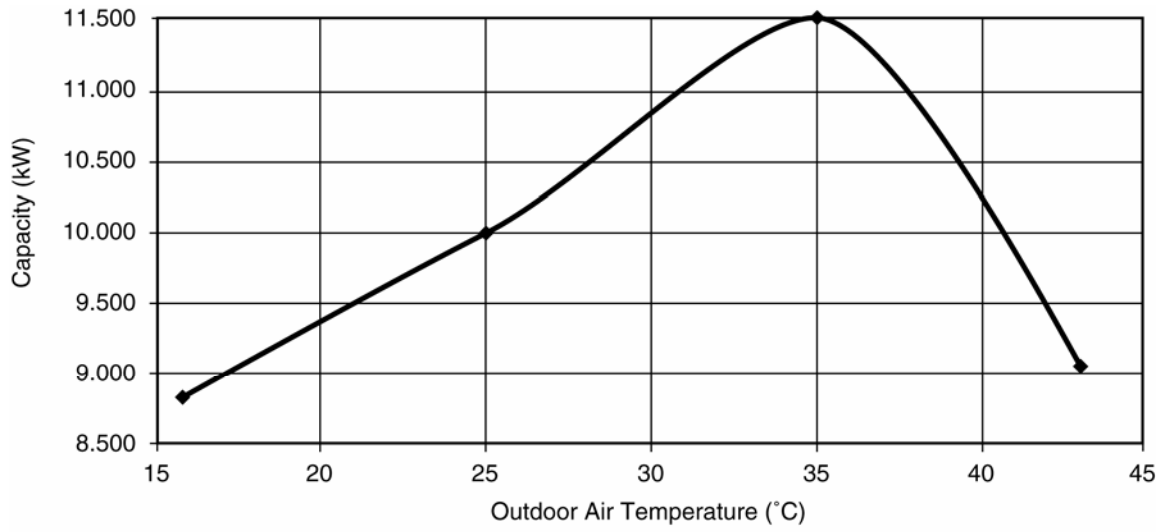

Heating Characteristics at Different Piping Length

Condition

Outdoor air temperature : 7°C (DBT), 6°C (WBT)

Indoor water inlet temperature : 30°C

Indoor water outlet temperature : 35°C

Piping length : 7m

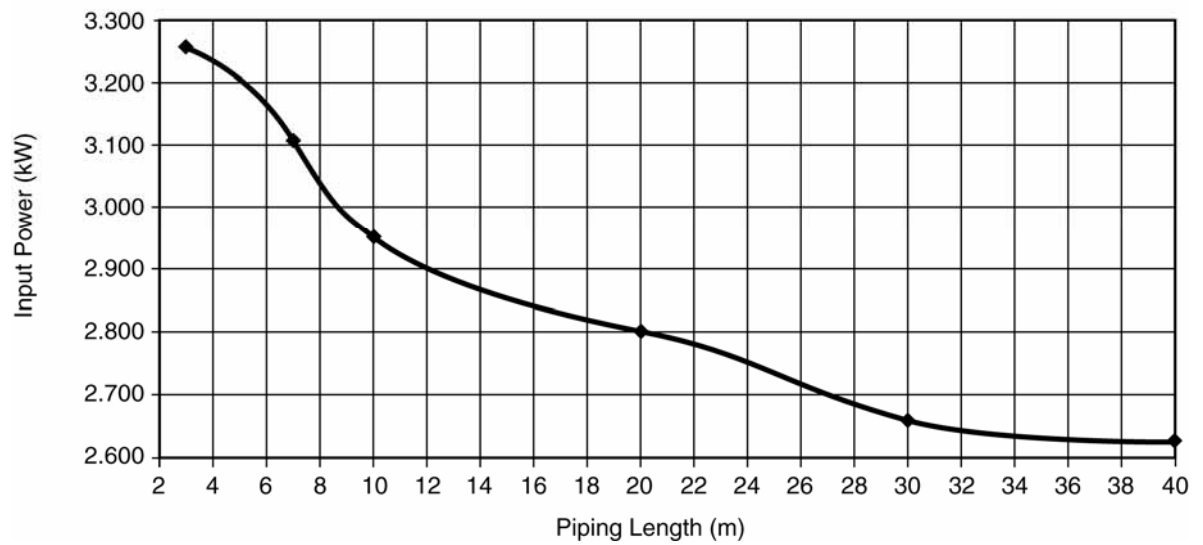
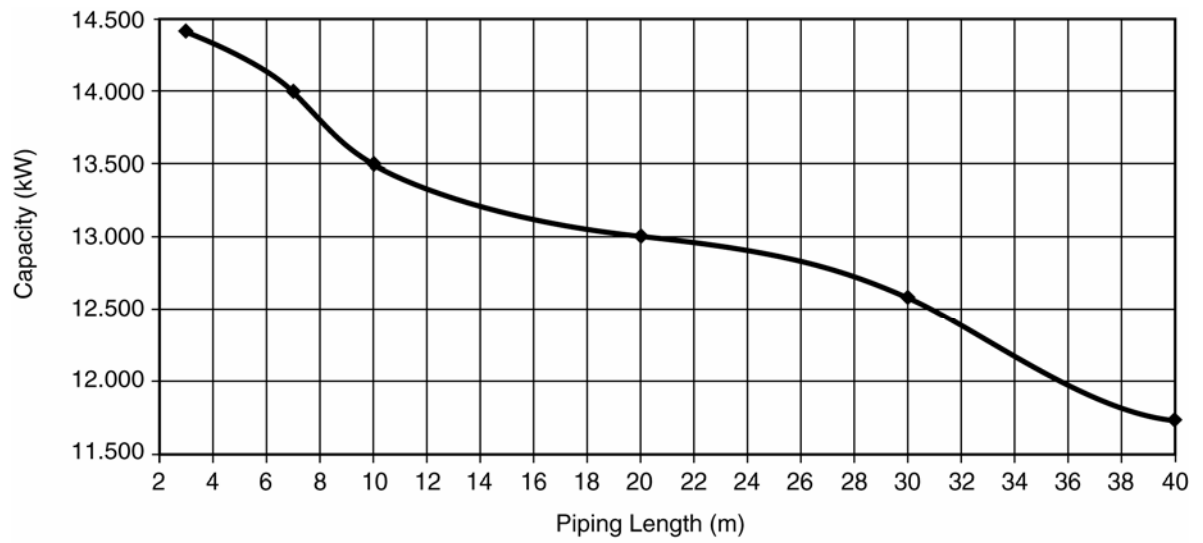

Cooling Characteristics at Different Piping Length

Condition

Outdoor air temperature : 35°C (DBT), -°C (WBT)

Indoor water inlet temperature : 12°C

Indoor water outlet temperature : 7°C

Piping length : 7m

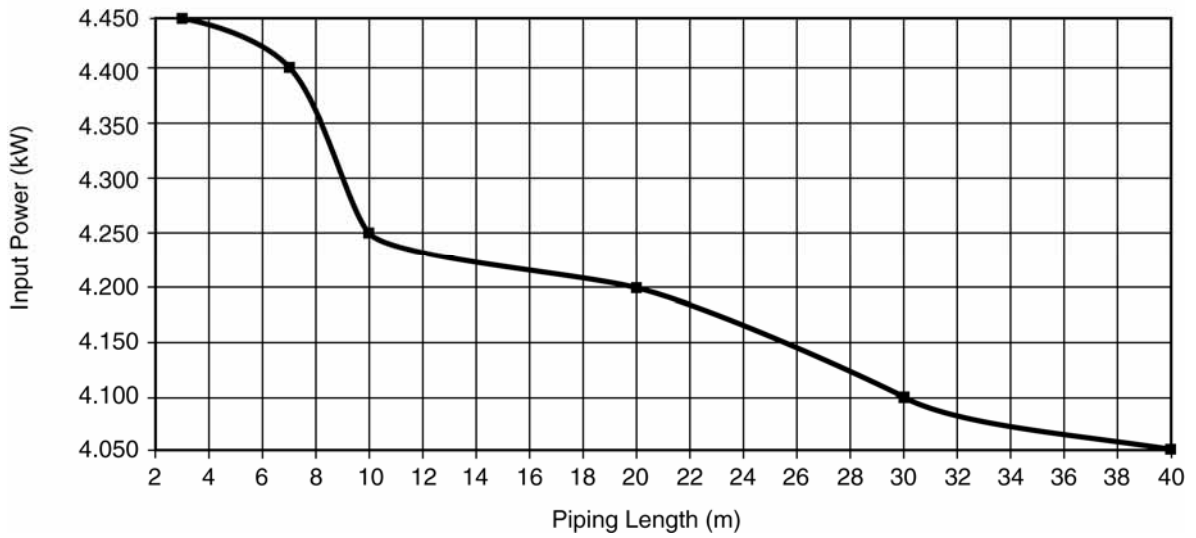
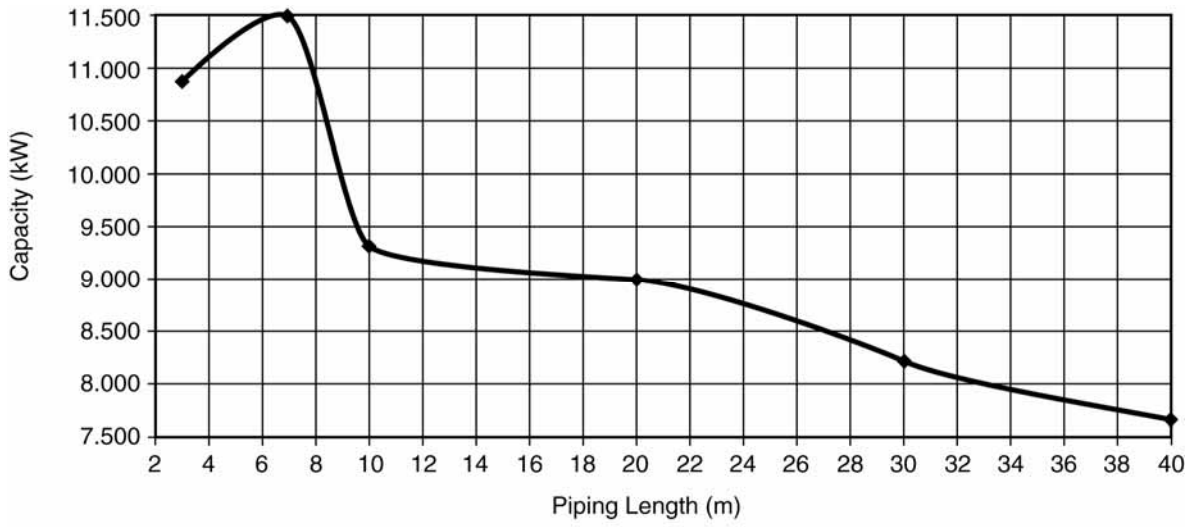

18.1.4 WH-SDC16C9E8 WH-UD16CE8

Heating Characteristics at Different Outdoor Air Temperature

Condition

Outdoor air temperature : 7°C (DBT), 6°C (WBT)

Indoor water inlet temperature : 30°C

Indoor water outlet temperature : 35°C

Piping length : 7m

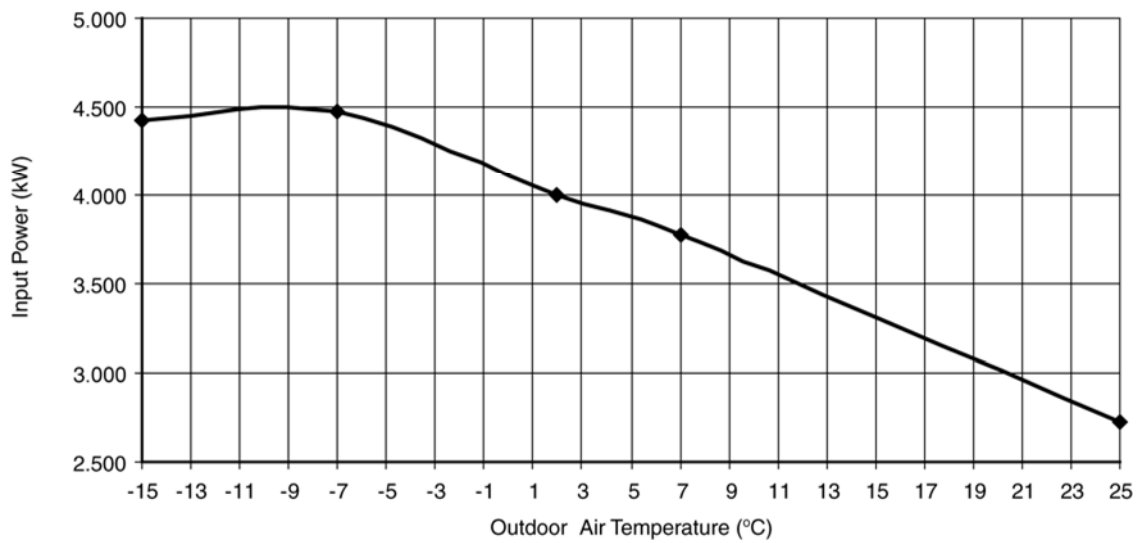
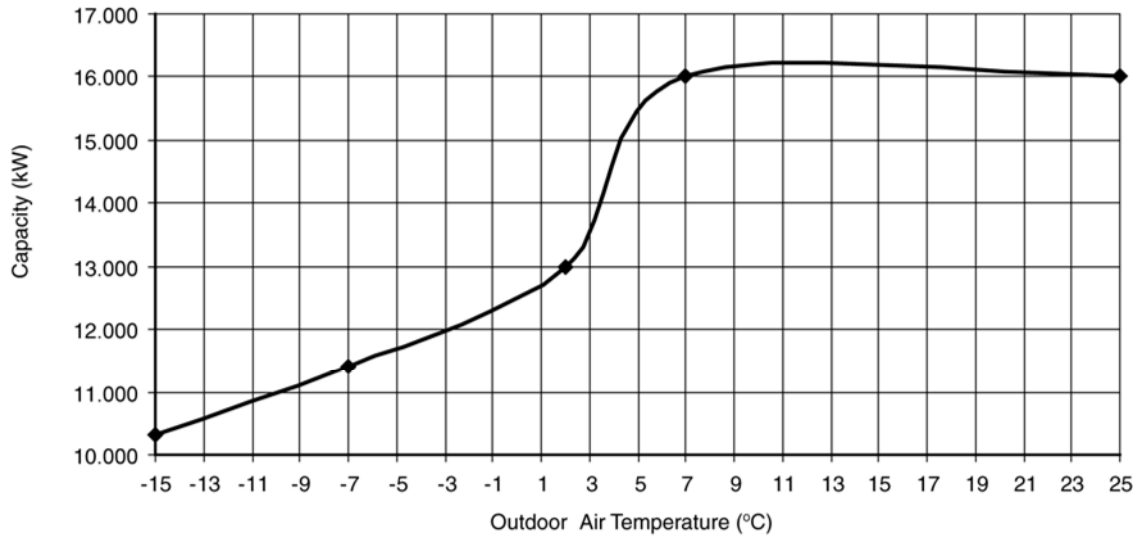

Cooling Characteristics at Different Outdoor Air Temperature

Condition

Outdoor air temperature : 35°C (DBT), -°C (WBT)

Indoor water inlet temperature : 12°C

Indoor water outlet temperature : 7°C

Piping length : 7m

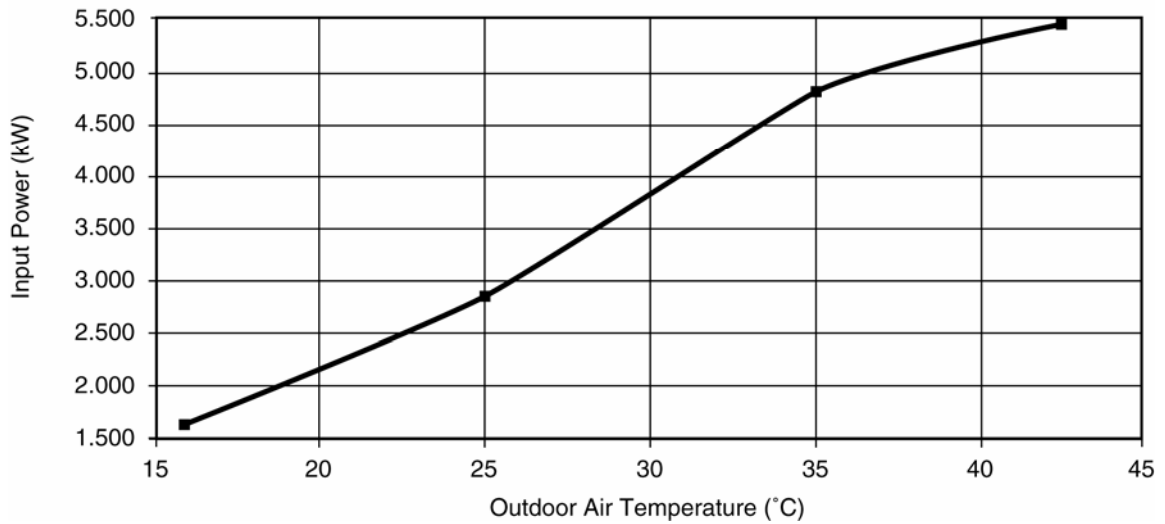
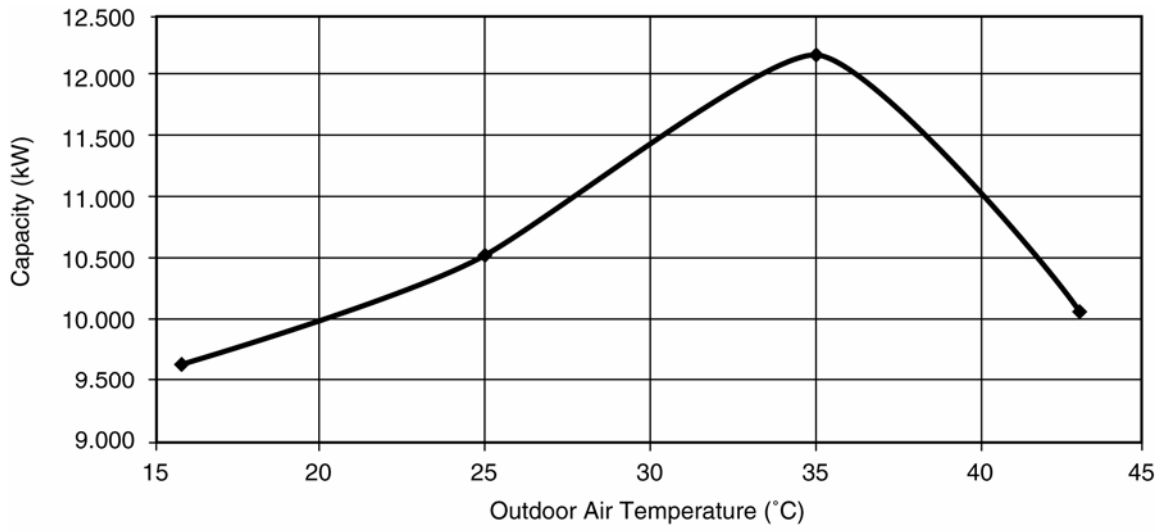

Heating Characteristics at Different Piping Length

Condition

Outdoor air temperature : 7°C (DBT), 6°C (WBT)

Indoor water inlet temperature : 30°C

Indoor water outlet temperature : 35°C

Piping length : 7m

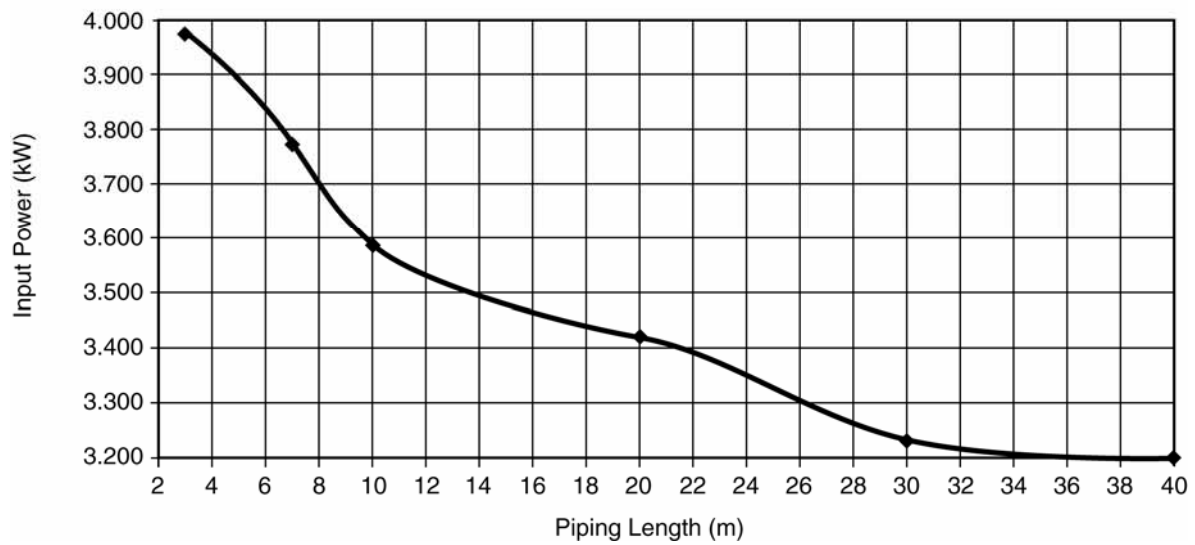
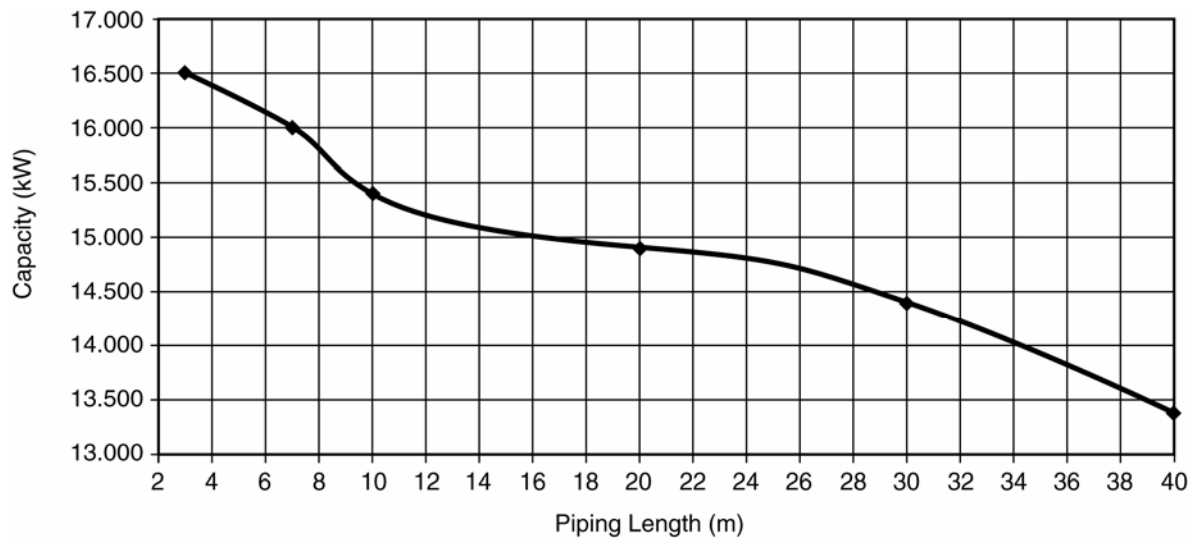

Cooling Characteristics at Different Piping Length

Condition

Outdoor air temperature : 35°C (DBT), -°C (WBT)

Indoor water inlet temperature : 12°C

Indoor water outlet temperature : 7°C

Piping length : 7m

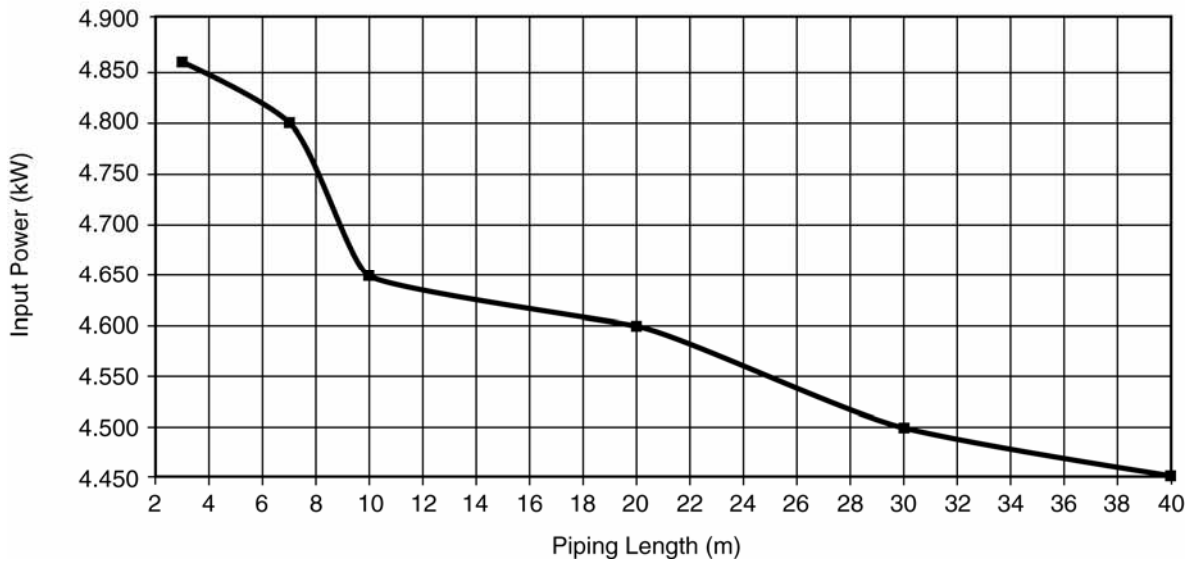
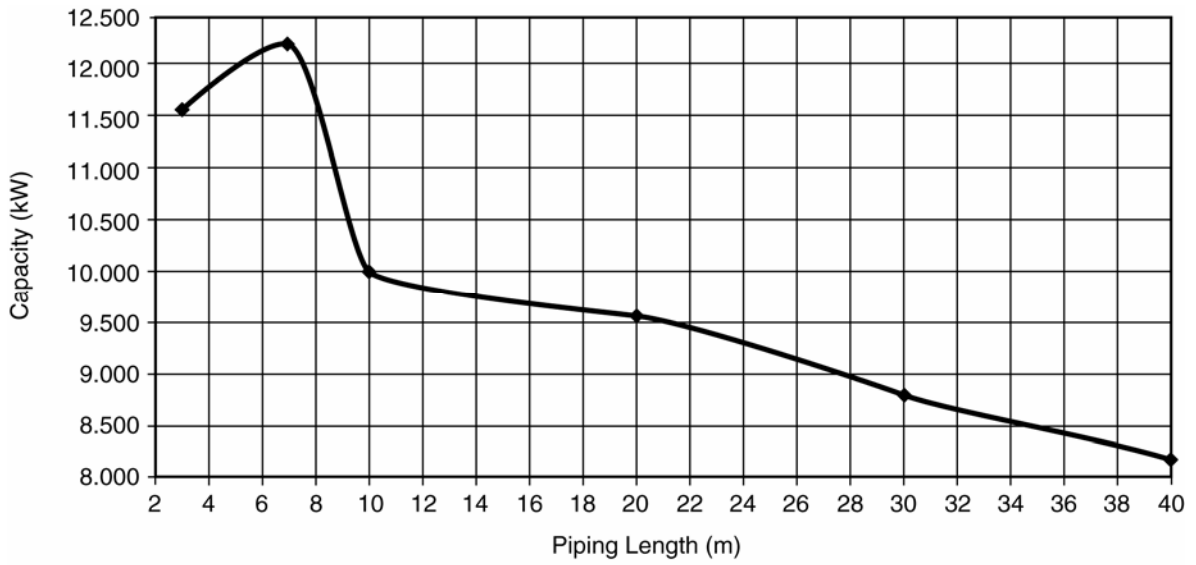

18.2 Heating Capacity Table

18.2.1 WH-SDC09C3E8 WH-UD09CE8

LWC	30		35		40		45		50		55	
Tamb	HC	IP	HC	IP	HC	IP	HC	IP	HC	IP	HC	IP
-15	8.65	3.10	8.30	3.25	7.95	3.45	7.60	3.65	7.15	3.75	6.70	3.85
-7	9.35	2.95	9.00	3.20	8.85	3.58	8.70	3.96	8.30	3.93	7.90	3.90
2	9.31	2.39	9.00	2.55	9.00	2.82	9.00	3.09	8.90	3.53	8.80	3.98
7	9.00	1.58	9.00	1.90	9.00	2.20	9.00	2.50	9.00	2.80	9.00	3.10
25	9.00	1.09	9.00	1.28	8.73	1.48	8.46	1.68	8.28	1.86	8.10	2.04

HC: Heating Capacity (kW)

IP: Power Input (kW)

LWC: Leaving Water Condenser Temperature (°C)

Tamb: Ambient Temperature (°C)

18.2.2 WH-SDC12C9E8 WH-UD12CE8

LWC	30		35		40		45		50		55	
Tamb	HC	IP	HC	IP	HC	IP	HC	IP	HC	IP	HC	IP
-15	9.30	3.50	8.90	3.66	8.50	3.83	8.10	3.99	7.50	4.09	7.00	4.20
-7	10.40	3.41	10.00	3.70	9.60	3.99	9.20	4.28	8.70	4.30	8.20	4.31
2	11.80	3.14	11.40	3.35	11.00	3.57	10.60	3.78	9.80	3.98	9.10	4.18
7	12.00	2.14	12.00	2.57	12.00	3.00	12.00	3.43	12.00	3.82	12.00	4.20
25	12.00	1.42	12.00	1.70	11.80	1.98	11.70	2.27	11.50	2.53	11.40	2.78

HC: Heating Capacity (kW)

IP: Power Input (kW)

LWC: Leaving Water Condenser Temperature (°C)

Tamb: Ambient Temperature (°C)

18.2.3 WH-SDC14C9E8 WH-UD14CE8

LWC	30		35		40		45		50		55	
Tamb	HC	IP	HC	IP	HC	IP	HC	IP	HC	IP	HC	IP
-15	9.90	3.91	9.50	4.05	9.00	4.19	8.60	4.33	7.90	4.45	7.30	4.56
-7	11.10	3.73	10.70	4.08	10.20	4.43	9.80	4.78	9.10	4.76	8.50	4.74
2	12.90	3.51	12.40	3.73	11.90	3.95	11.40	4.17	10.40	4.29	9.50	4.40
7	14.00	2.60	14.00	3.11	14.00	3.63	14.00	4.14	13.60	4.61	13.30	5.08
25	14.00	1.75	14.00	2.10	14.00	2.45	14.00	2.80	14.00	3.05	14.00	3.44

HC: Heating Capacity (kW)

IP: Power Input (kW)

LWC: Leaving Water Condenser Temperature (°C)

Tamb: Ambient Temperature (°C)

18.2.4 WH-SDC16C9E8 WH-UD16CE8

LWC	30		35		40		45		50		55	
Tamb	HC	IP	HC	IP	HC	IP	HC	IP	HC	IP	HC	IP
-15	10.60	4.13	10.30	4.42	10.00	4.71	9.70	5.00	8.80	4.98	7.90	4.95
-7	11.90	4.07	11.40	4.47	10.80	4.87	10.30	5.26	9.60	5.13	9.00	4.99
2	13.50	3.78	13.00	4.00	12.40	4.22	11.90	4.44	10.80	4.50	9.80	4.55
7	16.00	3.25	16.00	3.78	16.00	4.31	16.00	4.84	15.20	5.15	14.50	5.45
25	16.00	2.35	16.00	2.73	16.00	3.11	16.00	3.49	16.00	3.71	15.90	3.93

HC: Heating Capacity (kW)

IP: Power Input (kW)

LWC: Leaving Water Condenser Temperature (°C)

Tamb: Ambient Temperature (°C)

18.3 Cooling Capacity Table

MODELS	WH-SDC09		WH-SDC12		WH-SDC14		WH-SDC16	
IWC	12		12		12		12	
LWC	7		7		7		7	
Tamb	TC	IP	TC	IP	TC	IP	TC	IP
16	5.90	1.01	7.65	1.30	8.85	1.50	9.62	1.63
25	7.45	1.59	9.20	2.30	10.00	2.68	10.51	2.85
35	7.00	2.25	10.00	3.55	11.50	4.40	12.20	4.80
43	5.80	2.59	7.60	3.95	9.05	5.01	10.08	5.47

TC: Cooling Capacity (kW)

IP: Power Input (kW)

IWC: Inlet Water Condenser Temperature (°C)

LWC: Leaving Water Condenser Temperature (°C)

Tamb: Ambient Temperature (°C)

18.4 Hydraulic Pump Performance

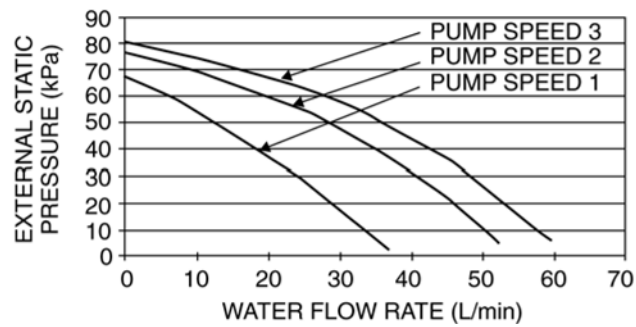

19. Exploded View and Replacement Parts List

19.1 WH-SDC09C3E8 WH-SDC12C9E8 WH-SDC14C9E8 WH-SDC16C9E8

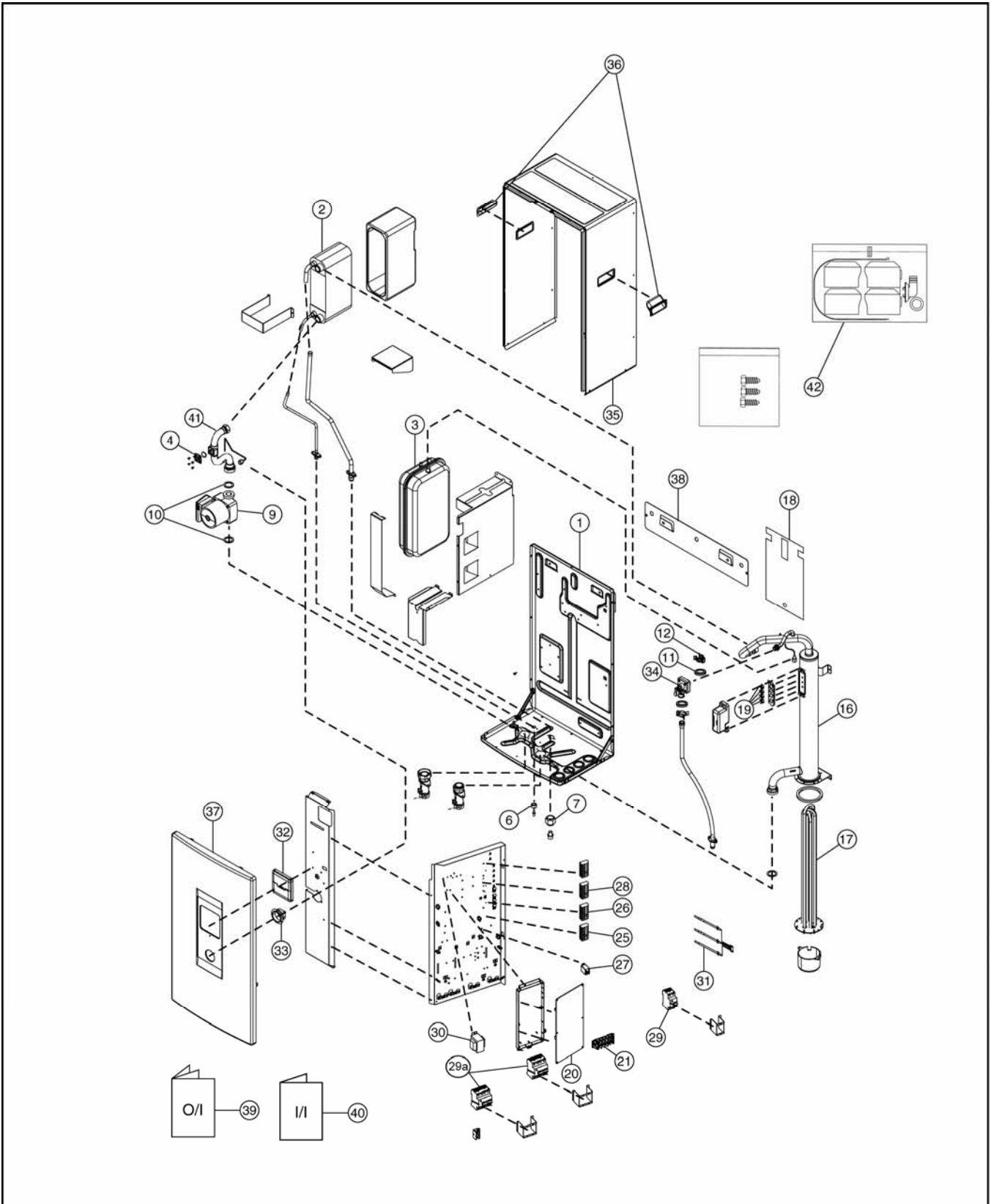

Note:

- The above exploded view is for the purpose of parts disassembly and replacement.
- The non-numbered parts are not kept as standard service parts.

<Model: WH-SDC09C3E8 WH-SDC12C9E8 WH-SDC14C9E8 WH-SDC16C9E8>

REF. NO.	DESCRIPTION & NAME	QTY.	WH-SDC09C3E8	WH-SDC12C9E8	WH-SDC14C9E8	WH-SDC16C9E8	REMARKS
1	BASE PAN	1	CWD521279	←	←	←	
2	HOT WATER COIL-COMplete	1	CWB90C1051	←	←	←	O
3	RECEIVER	1	CWB141039	←	←	←	
4	FLOAT (FLOW SWITCH)	1	CWB601008	←	←	←	O
6	FLARE NUT (3/8)	1	CWT251061	←	←	←	
7	FLARE NUT (5/8)	1	CWT251064	←	←	←	
9	PUMP	1	CWB532096	←	←	←	O
10	PACKING (O-RING) I.D 32mm	2	CWB811082	←	←	←	
11	PACKING (O-RING) I.D 13.8mm	2	CWB811022	←	←	←	
12	RETAINING RING D:22mm	1	CWH581007	←	←	←	
16	BOTTLE COMPLETE	1	CWH90C0017	←	←	←	
17	HEATER ASS'Y	1	CWA34K1029	CWA34K1030	←	←	O
18	SOUND PROOF MATERIAL	1	CWG302575	←	←	←	
19	THERMOSTAT	4	CWA151065	←	←	←	O
20	ELECTRONIC CONTROLLER-MAIN	1	CWA73C5112	CWA73C5113	CWA73C5114	CWA73C5115	O
21	TERMINAL BOARD ASS'Y	1	CWA28K1240	←	←	←	
25	TERMINAL BOARD ASS'Y	1	CWA28K1229	←	←	←	
26	TERMINAL BOARD ASS'Y	1	CWA28K1230	←	←	←	
27	ELECTRO MAGNETIC SWITCH	1	K6C1AYY00004	←	←	←	O
28	TERMINAL BOARD ASS'Y	1	CWA28K1231	←	←	←	
29a	RESIDUAL CURRENT CIRCUIT BREAKER	1/2	CWA181008	←	←	←	
29	RESIDUAL CURRENT CIRCUIT BREAKER	1	CWA181005	←	←	←	O
30	TRANSFORMER-COMplete	1	CWA40C1075	←	←	←	O
31	SENSOR-COMplete	1	CWA50C2762	←	←	←	O
32	REMOTE CONTROL COMPLETE	1	CWA75C3592	←	←	←	O
33	PRESSURE GAUGE	1	CWB070001	←	←	←	O
34	PRESSURE RELIEF VALVE	1	CWB621011	←	←	←	O
35	CABINET	1	CWE001050A	←	←	←	
36	HANDLE	2	CWE161008	←	←	←	
37	CABINET FRONT PLATE	1	CWE061265A	←	←	←	
38	INSTALLING HOLDER	1	CWH361103A	←	←	←	
39	OPERATING INSTRUCTION	1	CFW567803	←	←	←	
40	INSTALLATION INSTRUCTION	1	CFW614574	←	←	←	
41	TUBE CONNECTOR-COMplete	1	CWT29C1053	←	←	←	
42	ACCESSORY-COMplete	1	CWH82C1763	←	←	←	

Note:

- All parts are supplied from PHAAM, Malaysia (Vendor Code: 00029488).
- "O" marked parts are recommended to be kept in stock.

19.2 WH-UD09CE8 WH-UD12CE8 WH-UD14CE8 WH-UD16CE8

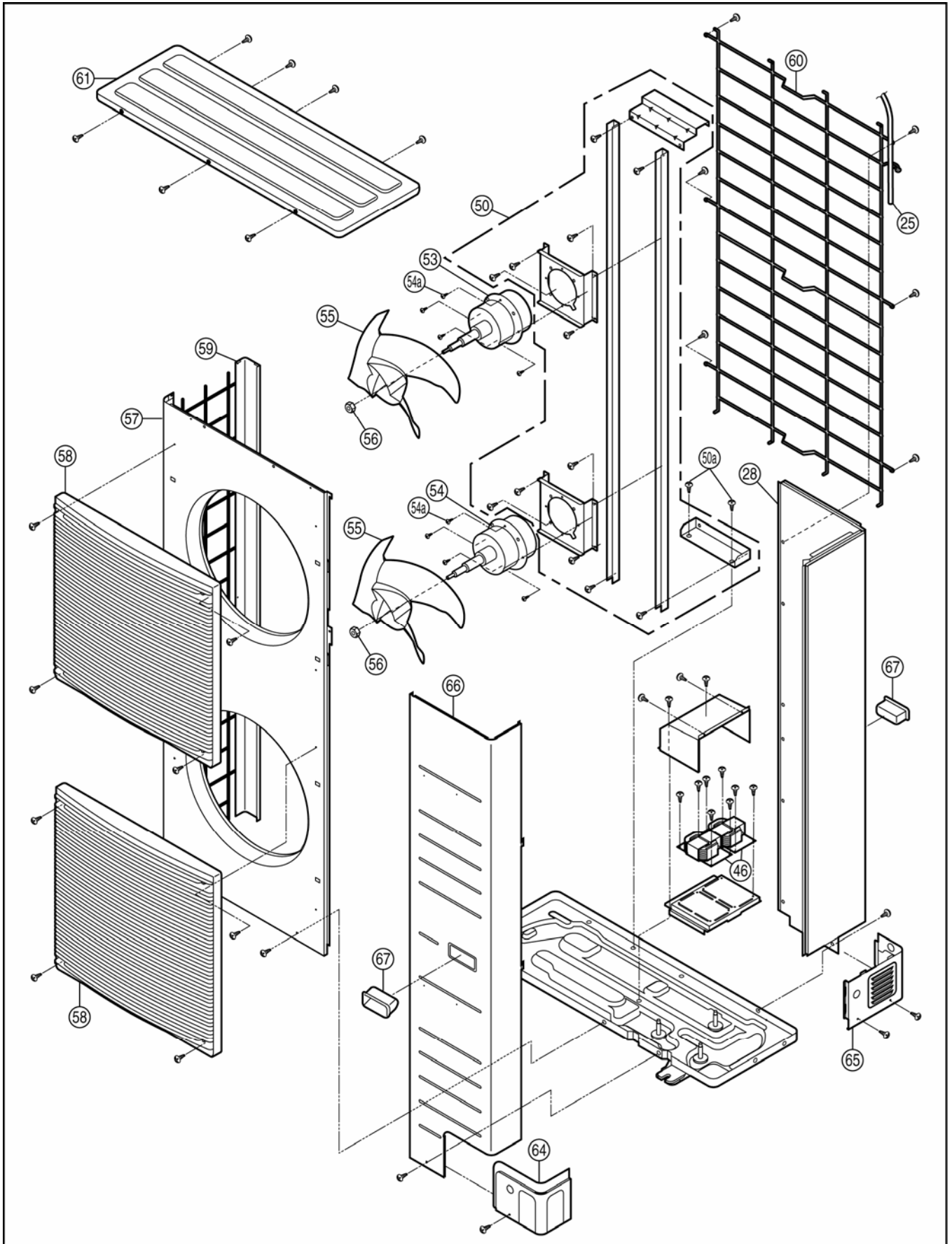

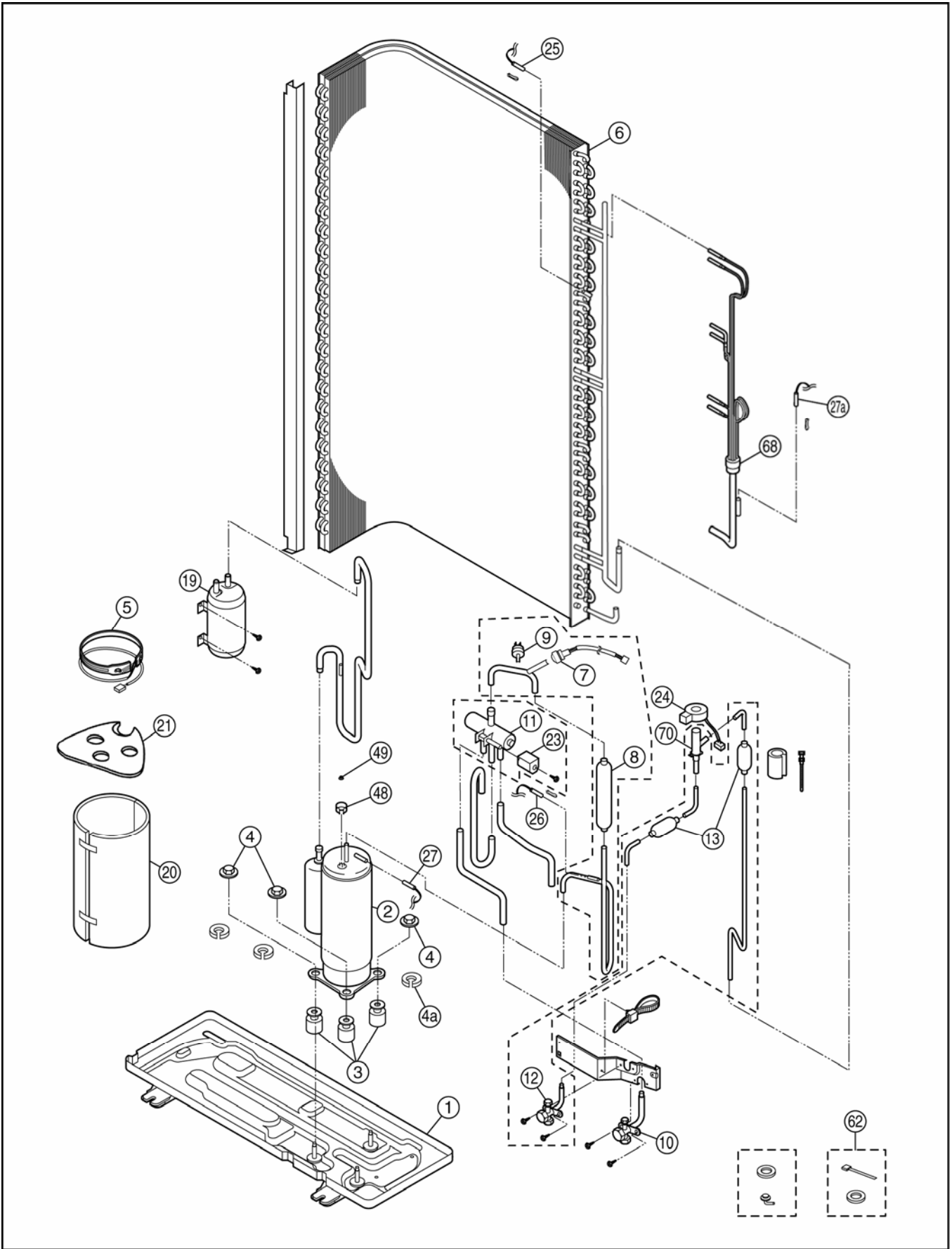

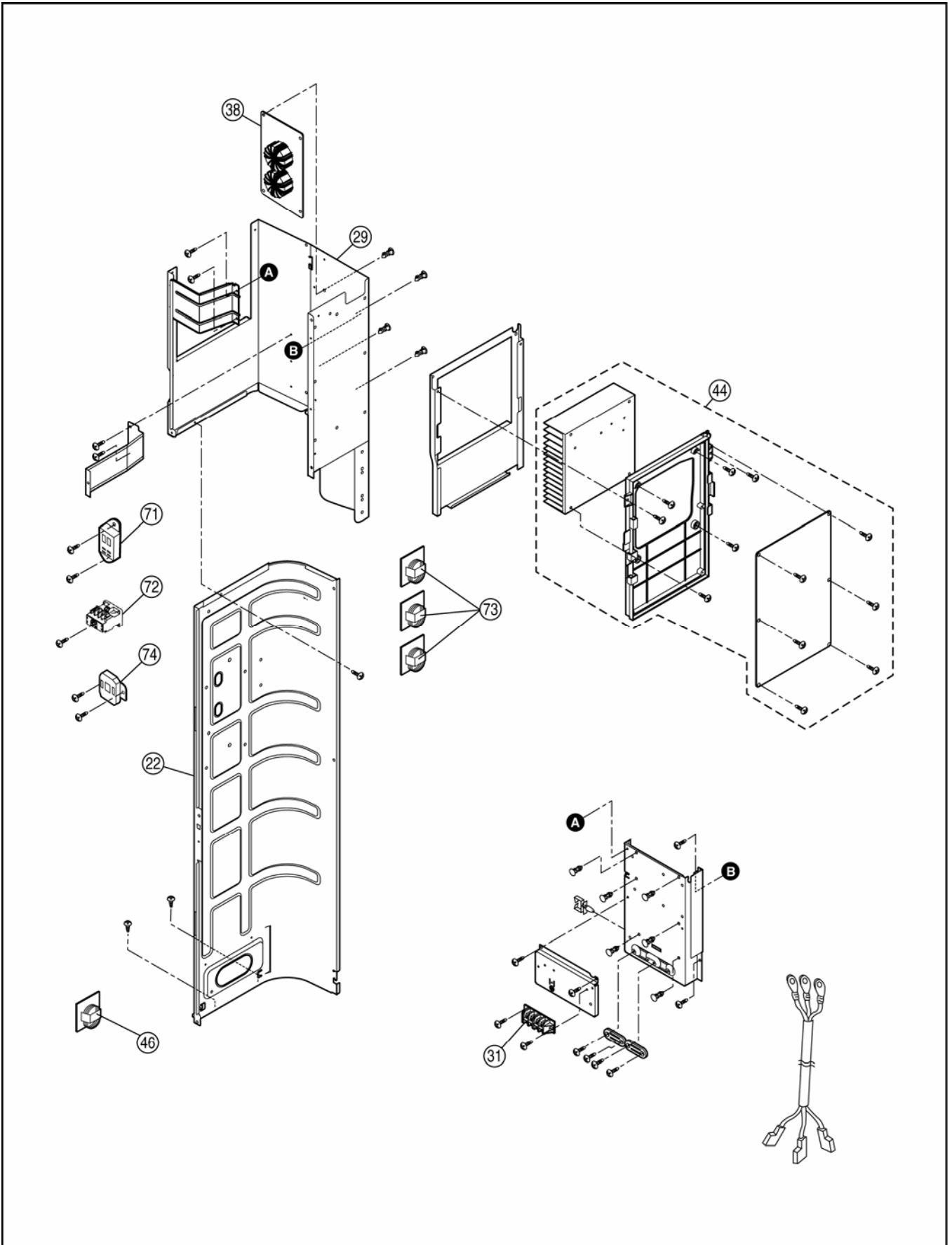

Note:

- The above exploded view is for the purpose of parts disassembly and replacement.
- The non-numbered parts are not kept as standard service parts.

<Model: WH-UD09CE8 WH-UD12CE8 WH-UD14CE8 WH-UD16CE8>

REF. NO.	DESCRIPTION & NAME	QTY.	WH-UD09CE8	WH-UD12CE8	WH-UD14CE8	WH-UD16CE8	REMARKS
1	BASE PAN ASS'Y	1	CWD52K1200	←	←	←	
2	COMPRESSOR	1	5JD420XBA22	←	←	←	O
3	ANTI-VIBRATION BUSHING	3	CWH50055	←	←	←	
4	NUT FOR COMP. MOUNT.	3	CWH561049	←	←	←	
4a	PACKING	3	CWB811017	←	←	←	
5	CRANKCASE HEATER	1	CWA341053	←	←	←	
6	CONDENSER COMPLETE	1	CWB32C3035	←	←	←	
7	HIGH PRESSURE SENSOR	1	CWA50C2570	←	←	←	
8	DISCHARGE MUFFLER	1	CWB121014	←	←	←	
9	PRESSURE SWITCH	1	CWA101013	←	←	←	
10	3-WAYS VALVE (GAS)	1	CWB011251	←	←	←	
11	4-WAYS VALVE	1	CWB001046	←	←	←	
12	3-WAYS VALVE (LIQUID)	1	CWB011292	←	←	←	
13	STRAINER	2	CWB111032	←	←	←	
19	ACCUMULATOR ASS'Y	1	CWB131026A	←	←	←	
20	SOUND PROOF MATERIAL - COMP	1	CWG302265	←	←	←	
21	SOUND PROOF MATERIAL	1	CWG302266	←	←	←	
22	SOUND-PROOF BOARD ASS'Y	1	CWH15K1031	←	←	←	
23	V-COIL COMPLETE - 4-WAYS VALVE	1	CWA43C2169J	←	←	←	O
24	V-COIL COMPLETE - EXP. VALVE	1	CWA43C2385	←	←	←	O
25	SENSOR-OD TEMP./COIL	1	CWA50C2730	←	←	←	
26	SENSOR-COMP.DISCHARGE	1	CWA50C2576	←	←	←	
27	SENSOR-COMP. TOP	1	CWA50C2629	←	←	←	
27a	SENSOR-COMP. DEF.	1	CWA50C2577	←	←	←	
28	CABINET REAR PLATE	1	CWE02C1059	←	←	←	
29	CONTROL BOARD CASING	1	CWH10K1133	←	←	←	
31	TERMINAL BOARD ASS'Y	1	CWA28K1214	←	←	←	
38	ELECTRONIC CONTROLLER (NOISE FILTER)	1	CWA745822	←	←	←	O
44	ELECTRONIC CONTROLLER (MAIN)	1	CWA73C5074R	CWA73C5075R	CWA73C5076R	CWA73C5077R	O
46	REACTOR	3	G0C293J00001	←	←	←	
48	TERMINAL COVER	1	CWH171039A	←	←	←	
49	NUT FOR TERMINAL COVER	1	CWH7080300J	←	←	←	
50	BRACKET FAN MOTOR	1	CWD54K1024	←	←	←	
50a	SCREW-BRACKET FAN MOTOR	2	CWH551040J	←	←	←	
53	FAN MOTOR (UPPER)	1	EHDS80AAC	←	←	←	O
54	FAN MOTOR (LOWER)	1	EHDS80BAC	←	←	←	O
54a	SCREW-FAN MOTOR	8	CWH551016J	←	←	←	
55	PROPELLER FAN	2	CWH00K1006	←	←	←	
56	NUT for PROPELLER FAN	2	CWH561051	←	←	←	
57	CABINET FRONT PLATE	1	CWE061098A	←	←	←	
58	DISCHARGE GRILLE	2	CWE201073	←	←	←	
59	CABINET SIDE PLATE	1	CWE04K1023A	←	←	←	
60	WIRE NET	1	CWD041103A	←	←	←	
61	CABINET TOP PLATE COMPLETE	1	CWE03C1096	←	←	←	
62	ACCESSORY COMPLETE	1	CWH82C1535	←	←	←	
64	PIPE COVER (FRONT)	1	CWD601074A	←	←	←	
65	PIPE COVER (BACK)	1	CWD601075A	←	←	←	
66	CABINET FRONT PLATE COMPLETE	1	CWE06C1091	←	←	←	
67	HANDLE	2	CWE161008	←	←	←	
68	TUBE ASS'Y (CAPILLARY TUBE)	1	CWT07K1541	←	←	←	
70	EXPANSION VALVE	1	CWB051028	←	←	←	

REF. NO.	DESCRIPTION & NAME	QTY.	WH-UD09CE8	WH-UD12CE8	WH-UD14CE8	WH-UD16CE8	REMARKS
71	ELECTRO MAGNETIC SWITCH	1	K6C2AGA00002	←	←	←	
72	ELECTRO MAGNETIC SWITCH	1	K6C4E8A00001	←	←	←	
73	REACTOR	3	G0C153J00009	←	←	←	
74	PTC THERMISTORS	1	D4DDG1010001	←	←	←	

Note:

- All parts are supplied from PHAAM, Malaysia (Vendor Code: 00029488).
- "O" marked parts are recommended to be kept in stock.