

Service Manual

Air Conditioner

CS-E24EKES CU-E24EKE

CS-E28EKE CU-E28EKE

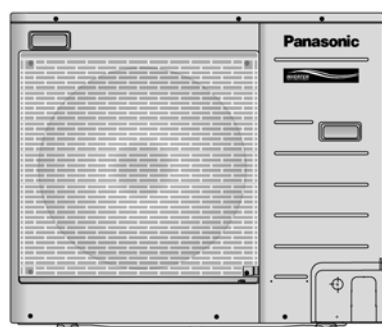

⚠ WARNING

This service information is designed for experienced repair technicians only and is not designed for use by the general public. It does not contain warnings or cautions to advise non-technical individuals of potential dangers in attempting to service a product. Products powered by electricity should be serviced or repaired only by experienced professional technicians. Any attempt to service or repair the product or products dealt with in this service information by anyone else could result in serious injury or death.

⚠ PRECAUTION OF LOW TEMPERATURE

In order to avoid frostbite, be assured of no refrigerant leakage during the installation or repairing of refrigeration circuit.

TABLE OF CONTENTS

	PAGE		PAGE
1 Safety Precautions	3	8.2. Outdoor Unit.....	16
2 Specifications	5	9 Printed Circuit Board	18
2.1. CS-E24EKES CU-E24EKE	5	9.1. Indoor Unit	18
2.2. CS-E28EKE CU-E28EKE	7	9.2. Outdoor Unit.....	22
3 Features	9	10 Installation Instruction	28
4 Location of Controls and Components	10	10.1. Select The Best Location	28
4.1. Indoor Unit.....	10	10.2. Indoor/Outdoor Unit Installation Diagram	28
4.2. Outdoor Unit	10	10.3. Indoor Unit	29
4.3. Remote Control	10	10.4. Outdoor Unit.....	32
5 Dimensions	11	11 Operation And Function	35
5.1. Indoor Unit & Remote Control	11	11.1. Basic Function	35
5.2. Outdoor Unit	12	11.2. Airflow Direction	35
6 Refrigeration Cycle Diagram	13	11.3. Quiet operation (Cooling Mode/Cooling area of Soft Dry Mode)	36
7 Block Diagram	14	11.4. Powerful Mode Operation.....	38
8 Wiring Connection Diagram	15	11.5. ON Timer Control	38
8.1. Indoor Unit.....	15		

Panasonic®

© 2005 Panasonic HA Air-Conditioning (M) Sdn Bhd (11969-T). All rights reserved. Unauthorized copying and distribution is a violation of law.

11.6. OFF Timer Control	39
11.7. Auto Restart Control	39
11.8. Ionizer Operation	39
12 Protection Control	40
12.1. Protection Control For All Operations	40
12.2. Protection Control For Cooling & Soft Dry Operation	41
12.3. Protection Control For Heating Operation	42
13 Servicing Mode	44
13.1. Auto Switch Operation	44
13.2. Selecting The Wireless Remote Control Transmission Code	44
13.3. Indication Panel	45
14 Troubleshooting Guide	46
14.1. Refrigeration Cycle System	46
14.2. Relationship Between The Condition Of The Air Conditioner And Pressure And Electric Current	47
14.3. Breakdown Self Diagnosis Function	48
14.4. Error Codes Table	49
15 Disassembly and Assembly Instructions	50
15.1. Indoor Electronic Controller and Control Board	50
15.2. Indoor Cross Flow Fan and Fan Motor	52
16 Technical Data	54
16.1. Operation Characteristics	54
16.2. Sensible Capacity Chart	70
17 Exploded View and Replacement Parts List	71
17.1. CS-E24EKES CS-E28EKE	71
17.2. CU-E24EKE CU-E28EKE	73

1 Safety Precautions

- Read the following "SAFETY PRECAUTIONS" carefully before perform any servicing.
- Electrical work must be installed or serviced by a licensed electrician. Be sure to use the correct rating of the power plug and main circuit for the model installed.
- The caution items stated here must be followed because these important contents are related to safety. The meaning of each indication used is as below.
Incorrect installation or servicing due to ignoring of the instruction will cause harm or damage, and the seriousness is classified by the following indications.





 WARNING	This indication shows the possibility of causing death or serious injury.
--------------------------------------------------------------------------------------------------	---------------------------------------------------------------------------



 CAUTION	This indication shows the possibility of causing injury or damage to properties.
--------------------------------------------------------------------------------------------------	----------------------------------------------------------------------------------

The items to be followed are classified by the symbols:

	This symbol denotes item that is PROHIBITED from doing.
-----------------------------------------------------------------------------------	---------------------------------------------------------

- Carry out test running to confirm that no abnormality occurs after the servicing. Then, explain to user the operation, care and maintenance as stated in instructions. Please remind the customer to keep the operating instructions for future reference.

 WARNING	
1. Engage dealer or specialist for installation and servicing. If installation or servicing done by the user is defective, it will cause water leakage, electrical shock or fire.	
2. Install according to this installation instructions strictly. If installation is defective, it will cause water leakage, electrical shock or fire.	
3. Use the attached accessories parts and specified parts for installation and servicing. Otherwise, it will cause the set to fall, water leakage, fire or electrical shock.	
4. Install at a strong and firm location which is able to withstand the set's weight. If the strength is not enough or installation is not properly done, the set will drop and cause injury.	
5. For electrical work, follow the local national wiring standard, regulation and the installation instruction. An independent circuit and single outlet must be used. If electrical circuit capacity is not enough or defect found in electrical work, it will cause electrical shock or fire.	
6. Use the specified cable and connect tightly for indoor/outdoor connection. Connect tightly and clamp the cable so that no external force will be acted on the terminal. If connection or fixing is not perfect, it will cause heat-up or fire at the connection.	
7. Wire routing must be properly arranged so that control board cover is fixed properly. If control board cover is not fixed perfectly, it will cause heat-up at connection point of terminal, fire or electrical shock.	
8. When connecting the piping, do not allow air or any substances other than the specified refrigerant to enter the refrigeration cycle. Otherwise, this may lower the capacity, cause abnormally high pressure in the refrigeration cycle, and possibly result in explosion and injury.	
9. Thickness of copper pipes used must be more than 0.8 mm. Never use copper pipes thinner than 0.8 mm.	
10. It is desirable that the amount of residual oil is less than 40 mg/10 m.	
11. Do not modify the length of the power supply cord or use of the extension cord, and do not share the single outlet with other electrical appliances. Otherwise, it will cause fire or electrical shock.	

 CAUTION	
1. The equipment must be earthed. It may cause electrical shock if grounding is not perfect.	
2. Do not install the unit at place where leakage of flammable gas may occur. In case gas leaks and accumulates at surrounding of the unit, it may cause fire.	

 **CAUTION**

3. Carry out drainage piping as mentioned in installation instructions. If drainage is not perfect, water may enter the room and damage the furniture.
4. Pb free solder has a higher melting point than standard solder; typically the melting point is 50 - 70°F (30 - 40°C) higher. Please use a high temperature soldering iron. In case of the soldering iron with temperature control, please set it to 700 ± 20°F (370 ± 10°C). Pb free solder will tend to splash when heated too high (about 1100°F/600°C).

ATTENTION

1. Selection of the installation location. Select an installation location which is rigid and strong enough to support or hold the unit, and select a location for easy maintenance.
2. Power supply connection to the conditioner. Connect the power supply cord of the air conditioner to the mains using one of the following methods. Power supply point shall be the place where there is ease for access for the power disconnection in case of emergency. In some countries, permanent connection of this room air conditioner to the power supply is prohibited.
 1. Power supply connection to the receptacle using a power plug. Use an approved power plug with earth pin for the connection to the socket.
 2. Power supply connection to a circuit breaker for the permanent connection. Use an approved circuit breaker for the permanent connection. It must be a double pole switch with a minimum 3.5 mm contact gap.
3. Do not release refrigerant during piping work for installation, servicing reinstallation and during repairing a refrigeration parts. Take care of the liquid refrigerant, it may cause frostbite.
4. Installation work. It may need two people to carry out the installation work.
5. Do not install this appliance in a laundry room or other location where water may drip from the ceiling, etc.

2 Specifications

2.1. CS-E24EKES CU-E24EKE

		Unit	CS-E24EKES	CU-E24EKE
Performance Test Condition		EUROVENT		
Cooling Capacity		kW	6.80 (0.90 - 8.10)	
		kcal/h	5,850 (770 - 6,970)	
		BTU/h	23,200 (3,070 - 27,600)	
Heating Capacity		kW	8.60 (0.90 - 9.90)	
		kcal/h	7,400 (770 - 8,510)	
		BTU/h	29,300 (3,070 - 33,800)	
Moisture Removal		l/h	3.9	
		Pint/h	8.2	
Power Source (Phase, Voltage, Cycle)		∅	Single	
		V	230	
		Hz	50	
Airflow Method				
Air Volume	Lo	m ³ /min (cfm)	Cooling; 12.8 (450) Heating; 14.0 (490)	—
	Me	m ³ /min (cfm)	Cooling; 14.8 (520) Heating; 16.0 (570)	—
	Hi	m ³ /min (cfm)	Cooling; 16.9 (600) Heating; 18.3 (650)	Cooling; 54.5 (1,925) Heating; 54.5 (1,925)
Noise Level		dB (A)	Cooling; High 47, Low 38 Heating; High 47, Low 38	Cooling; 52 Heating; 52
		Power level dB	Cooling; High 60 Heating; High 60	Cooling; High 66 Heating; High 66
Electrical Data	Input Power	W	Cooling; 2,120 (350 - 2,700) Heating; 2,660 (360 - 3,200)	
	Running Current	A	Cooling; 9.7 Heating; 12.1	
	EER	W/W	Cooling; 3.21 (2.57 - 3.00)	
		BTU/hW	Cooling; 10.9 (8.8 - 10.2)	
	COP	W/W	Heating; 3.23 (2.50 - 3.09)	
		BTU/hW	Heating; 11.0 (8.5 - 10.6)	
Starting Current	A	12.5		
Piping Connection Port (Flare piping)		inch inch	G ; Half Union 5/8" L ; Half Union 1/4"	G ; 3-way valve 5/8" L ; 2-way valve 1/4"
Pipe Size (Flare piping)		inch inch	G (gas side) ; 5/8" L (liquid side) ; 1/4"	G (gas side) ; 5/8" L (liquid side) ; 1/4"
Drain	Inner diameter	mm	12	—
Hose	Length	m	0.65	—
Power Cord Length			—	—
Number of Core-wire			—	—
Dimensions	Height	inch (mm)	10 - 13/16 (275)	31 - 5/16 (795)
	Width	inch (mm)	39 - 9/32 (998)	35 - 7/16 (900)
	Depth	inch (mm)	9 - 1/16 (230)	12 - 19/32 (320)
Net Weight		lb (kg)	26 (12)	159 (72.0)
Compressor	Type		—	Hermetic Rotary
	Motor Type		—	DC Brushless (4-pole)
	Rated Output	W	—	1,700

		Unit	CS-E24EKES	CU-E24EKE	
Air Circulation	Type		Cross-flow Fan	Propeller Fan	
	Material		ASHT-18	P.P	
	Motor Type		Transistor (8-poles)	Induction (6-poles)	
	Rate Output	W	30	76	
	Fan Speed	Lo (Cool/Heat)	rpm	1,190 / 1,280	—
		Me (Cool/Heat)	rpm	1,370 / 1,480	—
Hi (Cool/Heat)		rpm	1,560 / 1,680	690 / 700	
Heat Exchanger	Description		Evaporator	Condenser	
	Tube material		Copper	Copper	
	Fin material		Aluminium (Pre Coat)	Aluminium	
	Fin Type		Slit Fin	Corrugated Fin	
	Row / Stage		(Plate fin configuration, forced draft)		
			2 / 15	2 / 30	
	FPI		21	19	
Size (W × H × L)	mm	810 × 315 × 25.4	864.4 × 762 × 44 898.9		
Refrigerant Control Device			—	Capillary Tube	
Refrigeration Oil		(cm ³)	—	FV50S (800)	
Refrigerant (R410A)		kg (oz)	—	1.65 (58.2)	
Thermostat			Electronic Control	—	
Protection Device			Electronic Control	Electronic Control	
Air Filter	Material Style		P.P. Honeycomb	—	
Fan Motor Capacitor		μF, VAC	—	3.5, 440	

- Specifications are subject to change without notice for further improvement.

2.2. CS-E28EKE CU-E28EKE

		Unit	CS-E28EKE	CU-E28EKE
Performance Test Condition			EUROVENT	
Cooling Capacity		kW kcal/h BTU/h	7.65 (0.90 - 8.60) 6,580 (770 - 7,400) 26,100 (3,070 - 29,300)	
Heating Capacity		kW kcal/h BTU/h	9.60 (0.90 - 11.00) 8,260 (770 - 9,460) 32,700 (3,070 - 37,500)	
Moisture Removal		l/h Pint/h	4.5 9.5	
Power Source (Phase, Voltage, Cycle)		∅ V Hz	Single 230 50	
Airflow Method				
Air Volume	Lo	m ³ /min (cfm)	Cooling; 12.8 (450) Heating; 14.0 (490)	—
	Me	m ³ /min (cfm)	Cooling; 15.2 (540) Heating; 16.0 (570)	—
	Hi	m ³ /min (cfm)	Cooling; 17.7 (625) Heating; 18.7 (660)	Cooling; 54.5 (1,925) Heating; 54.5 (1,925)
Noise Level		dB (A)	Cooling; High 49, Low 38 Heating; High 48, Low 38	Cooling; 53 Heating; 53
		Power level dB	Cooling; High 62 Heating; High 61	Cooling; High 67 Heating; High 67
Electrical Data	Input Power	W	Cooling; 2,540 (350 - 2,950) Heating; 3,300 (360 - 3,790)	
	Running Current	A	Cooling; 11.8 Heating; 15.3	
	EER	W/W	Cooling; 3.01 (2.57 - 2.92)	
		BTU/hW	Cooling; 10.3 (8.8 - 9.9)	
	COP	W/W	Heating; 2.91 (2.50 - 2.90)	
		BTU/hW	Heating; 9.9 (8.5 - 9.9)	
Starting Current	A	15.3		
Piping Connection Port (Flare piping)		inch inch	G ; Half Union 5/8" L ; Half Union 1/4"	G ; 3-way valve 5/8" L ; 2-way valve 1/4"
Pipe Size (Flare piping)		inch inch	G (gas side) ; 5/8" L (liquid side) ; 1/4"	G (gas side) ; 5/8" L (liquid side) ; 1/4"
Drain	Inner diameter	mm	12	—
Hose	Length	m	0.65	—
Power Cord Length			—	—
Number of Core-wire			—	—
Dimensions	Height	inch (mm)	10 - 13/16 (275)	31 - 5/16 (795)
	Width	inch (mm)	39 - 9/32 (998)	35 - 7/16 (900)
	Depth	inch (mm)	9 - 1/16 (230)	12 - 19/32 (320)
Net Weight		lb (kg)	26 (12)	159 (72.0)
Compressor	Type		—	Hermetic Rotary
	Motor Type		—	DC Brushless (4-pole)
	Rated Output	W	—	1,700

		Unit	CS-E28EKE	CU-E28EKE	
Air Circulation	Type		Cross-flow Fan	Propeller Fan	
	Material		ASHT-18	P.P	
	Motor	Type	Transistor (8-poles)	Induction (6-poles)	
		Rate Output	W	30	76
	Fan Speed	Lo (Cool/Heat)	rpm	1,190 / 1,280	—
		Me (Cool/Heat)	rpm	1,410 / 1,500	—
Hi (Cool/Heat)		rpm	1,640 / 1,720	690 / 700	
Heat Exchanger	Description		Evaporator	Condenser	
	Tube material		Copper	Copper	
	Fin material		Aluminium (Pre Coat)	Aluminium	
	Fin Type		Slit Fin	Corrugated Fin	
	Row / Stage		(Plate fin configuration, forced draft)		
			2 / 15	2 / 30	
	FPI		21	19	
Size (W × H × L)	mm	810 × 315 × 25.4	827.6 × 762 × 44 862.2		
Refrigerant Control Device			—	Capillary Tube	
Refrigeration Oil		(cm ³)	—	FV50S (800)	
Refrigerant (R410A)		kg (oz)	—	1.69 (59.7)	
Thermostat			Electronic Control	—	
Protection Device			Electronic Control	Electronic Control	
Air Filter	Material Style		P.P. Honeycomb	—	
Fan Motor Capacitor		μF, VAC	—	3.5, 440	

- Specifications are subject to change without notice for further improvement.

3 Features

- **Product**

- Four modes of operation selection
- Powerful Mode operation
- ON Timer and OFF Timer
- Ionizer Mode Operation
- Quiet Mode Operation
- Automatic air swing and manual adjusted by Remote Control for horizontal and vertical airflow
- Supersonic Air Purifying System with Super Allerbuster.

Inactive various harmful airborne elements including allergens, viruses and bacteria. Generated supersonic waves enhance the ability to collect dust and dirt in the air.

- **Serviceability Improvement**

- Removable washable Front Panel
- Breakdown Self Diagnosis function

- **Environmental Protection**

- Non-ozone depletion substances refrigerant (R410A)

- **Operation Improvement**

- Auto restart control

4 Location of Controls and Components

4.1. Indoor Unit

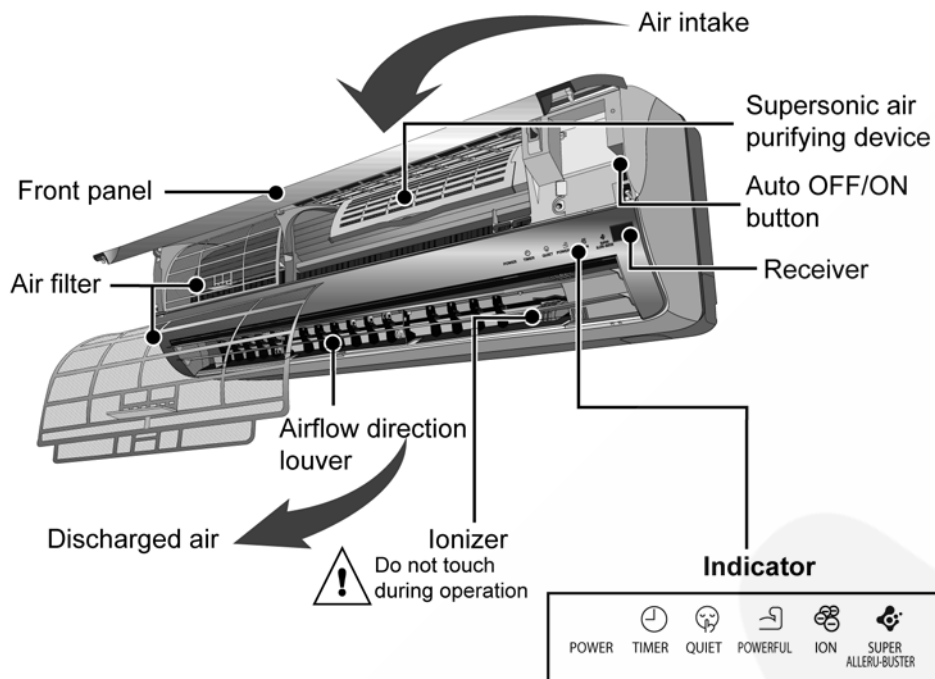

4.2. Outdoor Unit

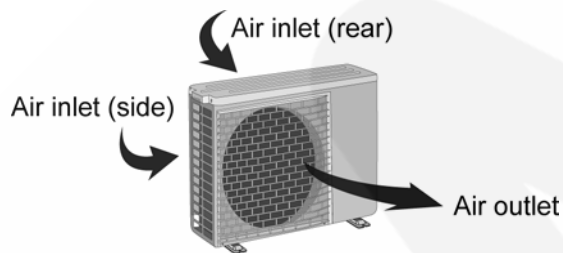

4.3. Remote Control

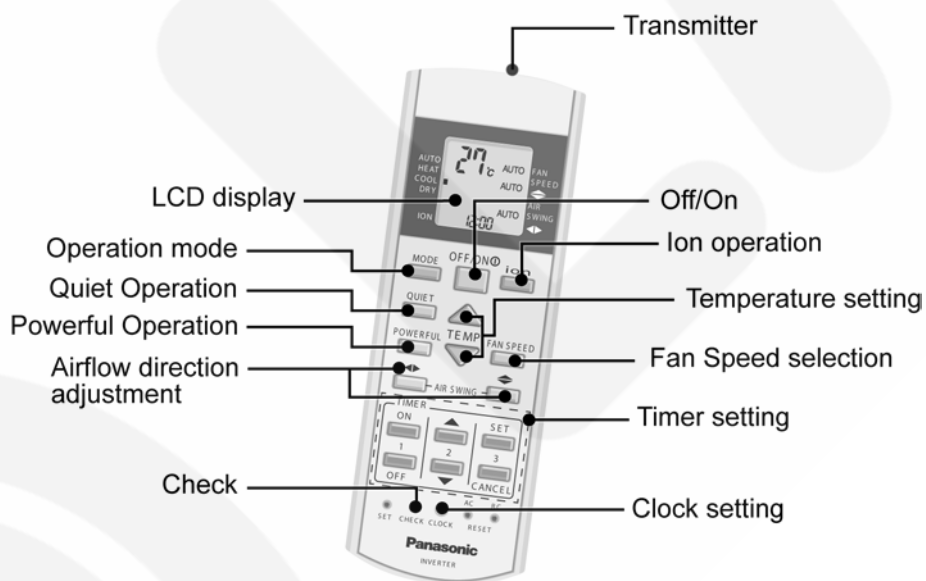

5 Dimensions

5.1. Indoor Unit & Remote Control

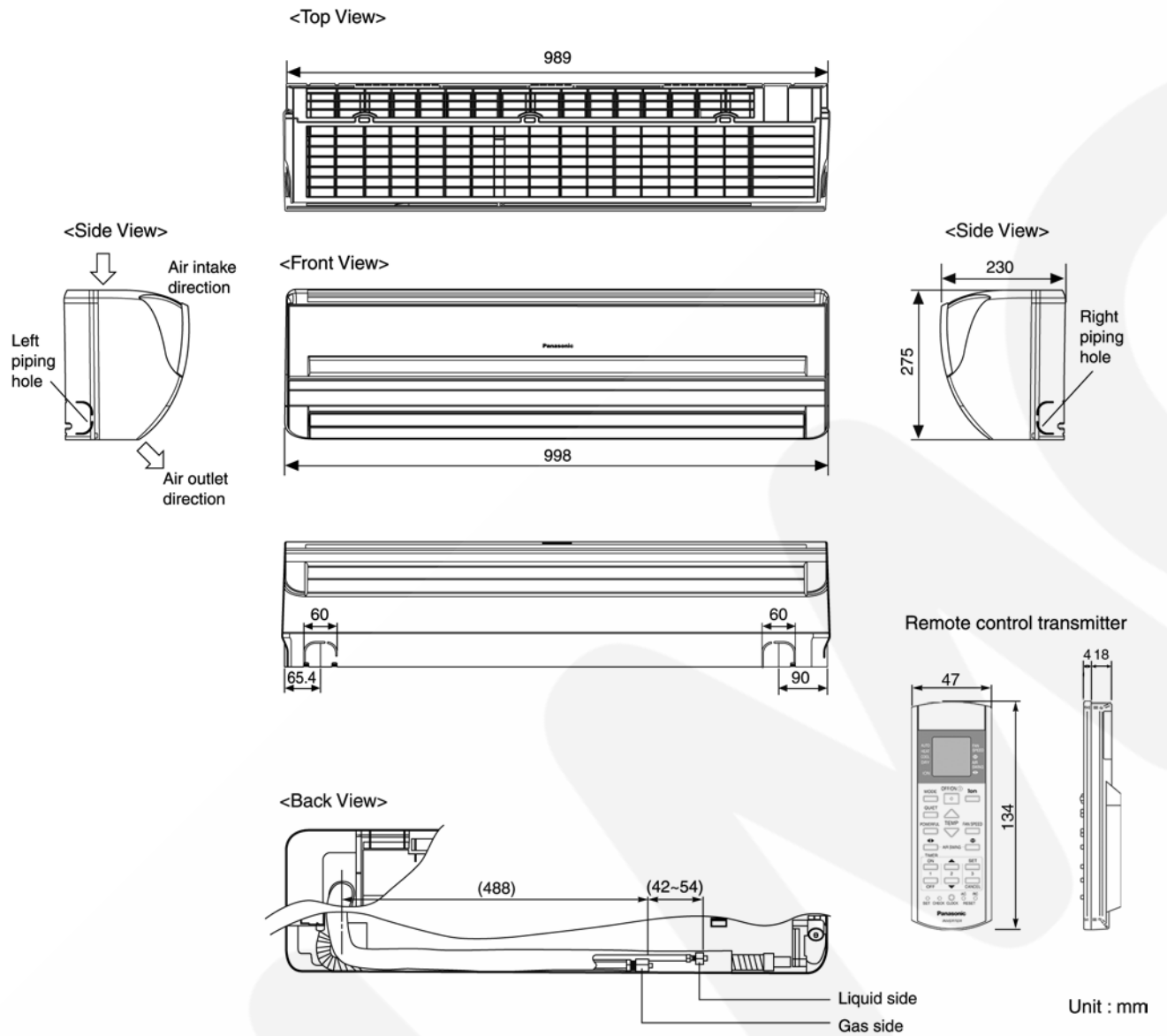

Relative position between the indoor unit and the installation plate <Front View>

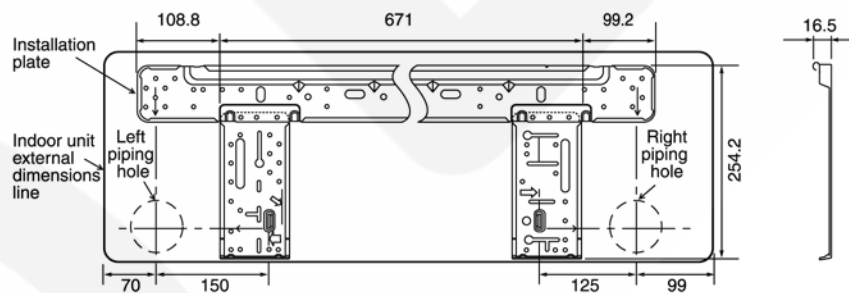

5.2. Outdoor Unit

Space necessary for installation

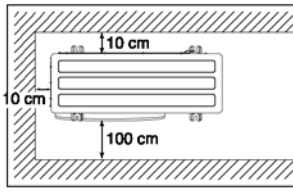

Anchor Bolt Pitch
355 x 620

<Top View>

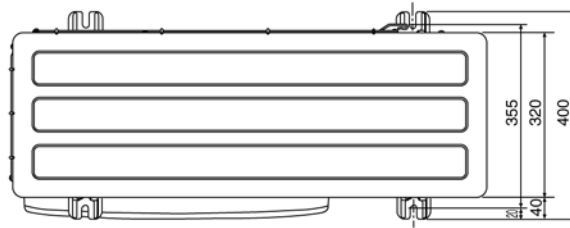

<Side View>

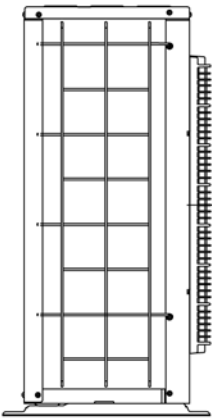

<Front View>

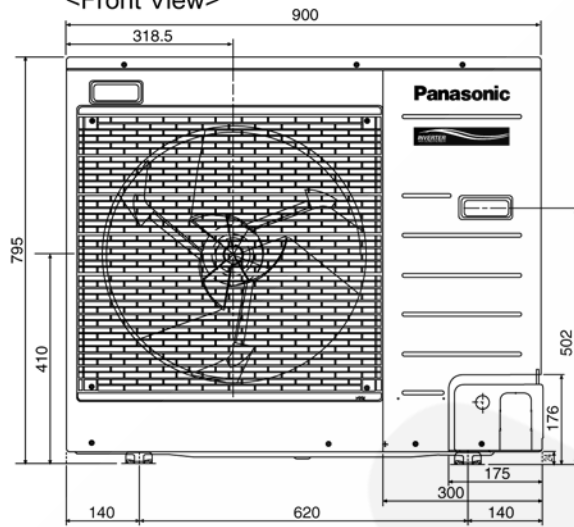

<Side View>

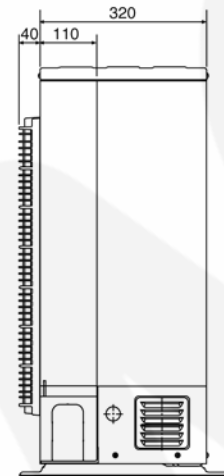

<Back View>

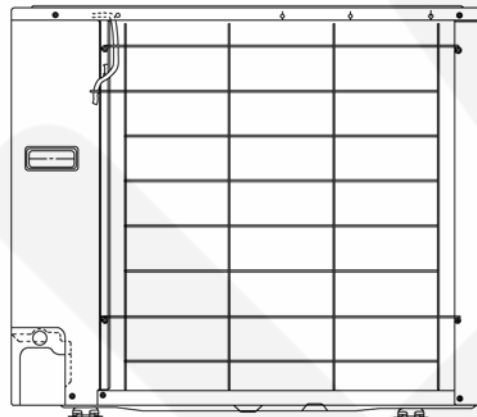

Unit : mm

6 Refrigeration Cycle Diagram

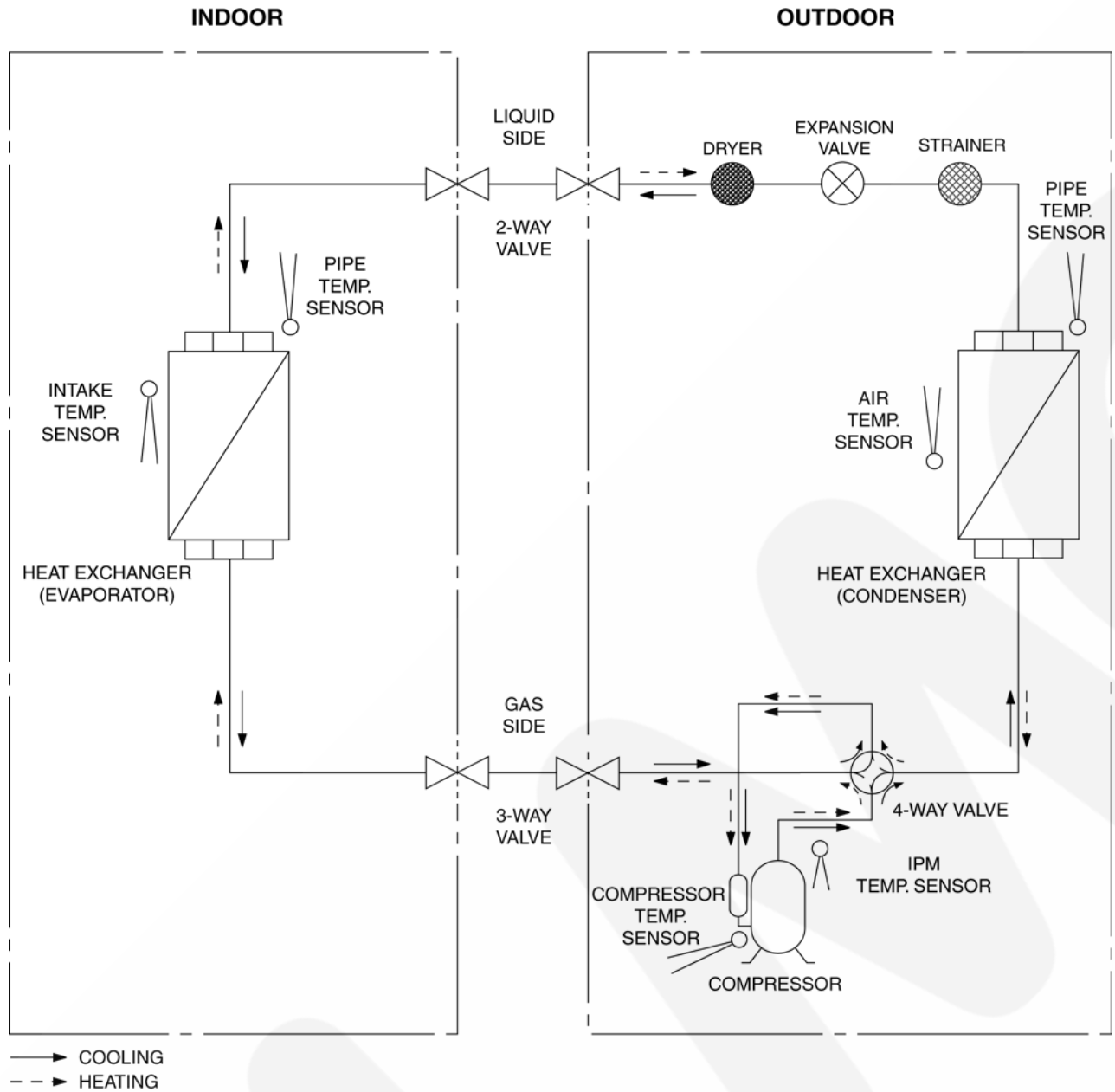

7 Block Diagram

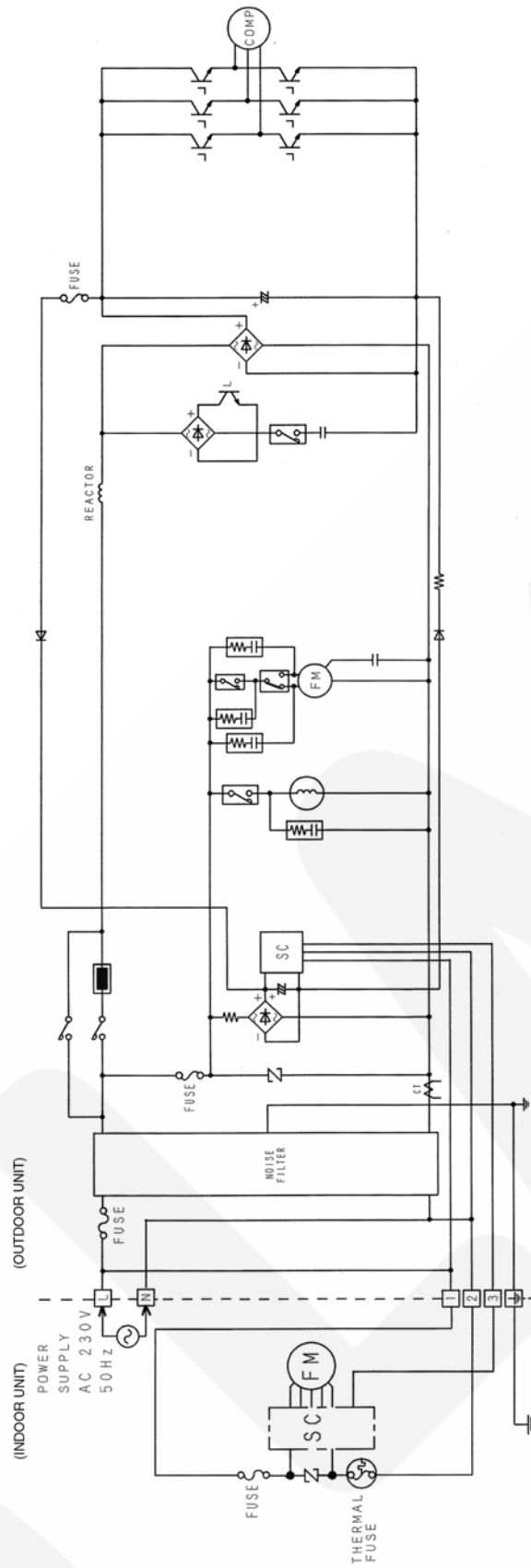

8 Wiring Connection Diagram

8.1. Indoor Unit

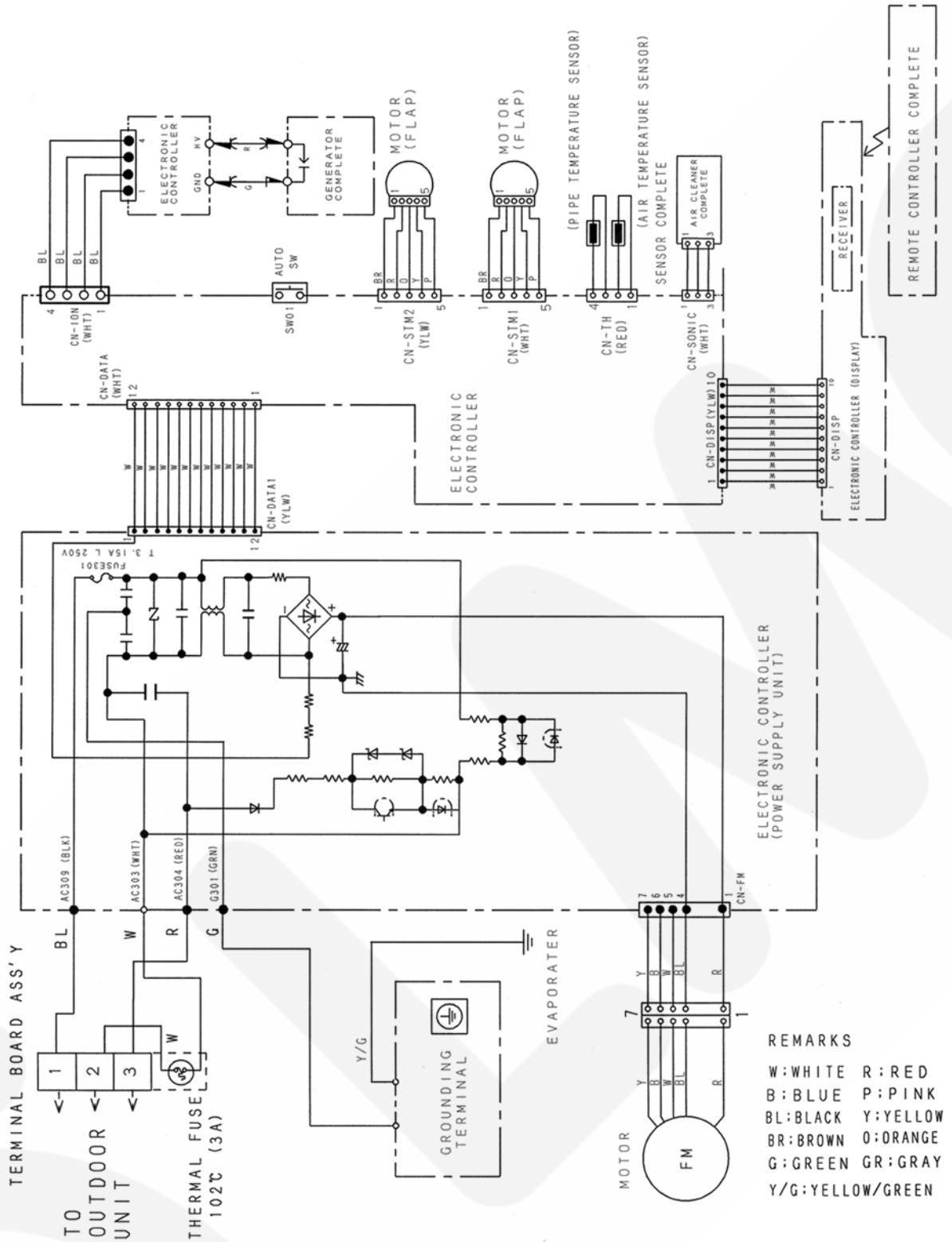

8.2. Outdoor Unit

8.2.1. CU-E24EKE

REMARKS

W ; WHITE R ; RED
 B ; BLUE P ; PINK
 BL ; BLACK Y ; YELLOW
 BR ; BROWN O ; ORANGE
 G ; GREEN GR ; GRAY
 Y/G ; YELLOW/GREEN

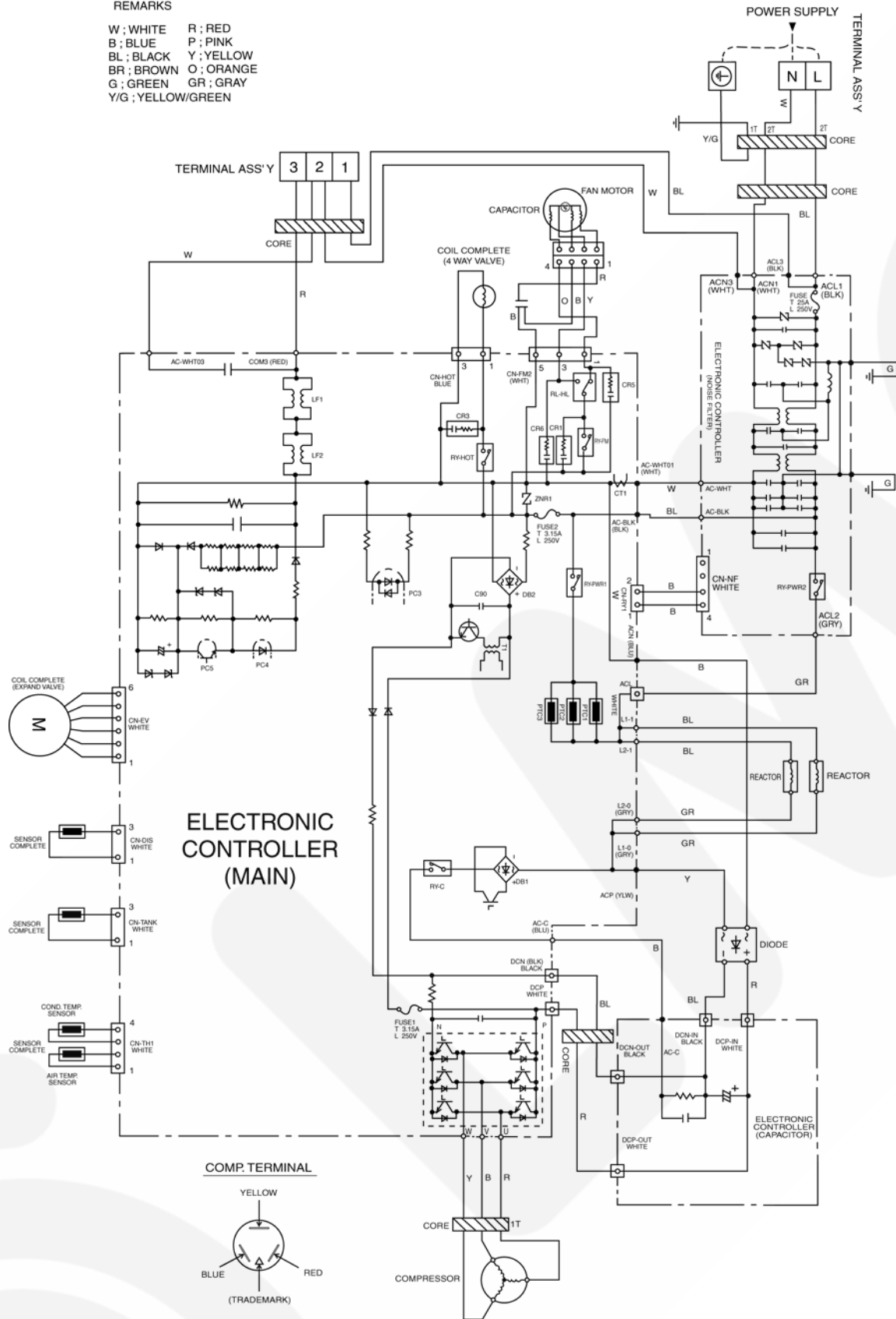

8.2.2. CU-E28EKE

REMARKS

W ; WHITE R ; RED
 B ; BLUE P ; PINK
 BL ; BLACK Y ; YELLOW
 BR ; BROWN O ; ORANGE
 G ; GREEN GR ; GRAY
 Y/G ; YELLOW/GREEN

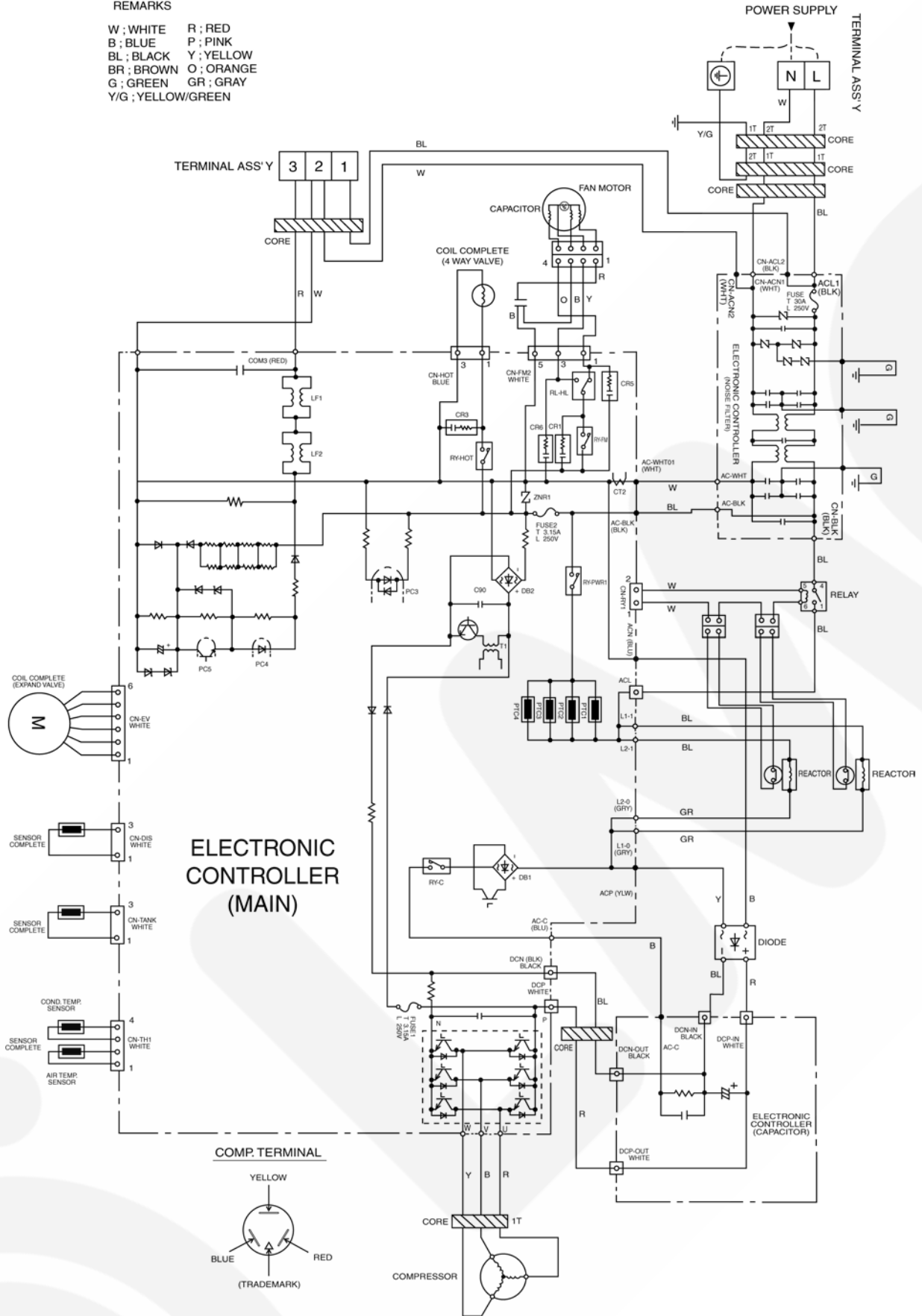

9 Printed Circuit Board

9.1. Indoor Unit

9.1.1. Main Printed Circuit Board

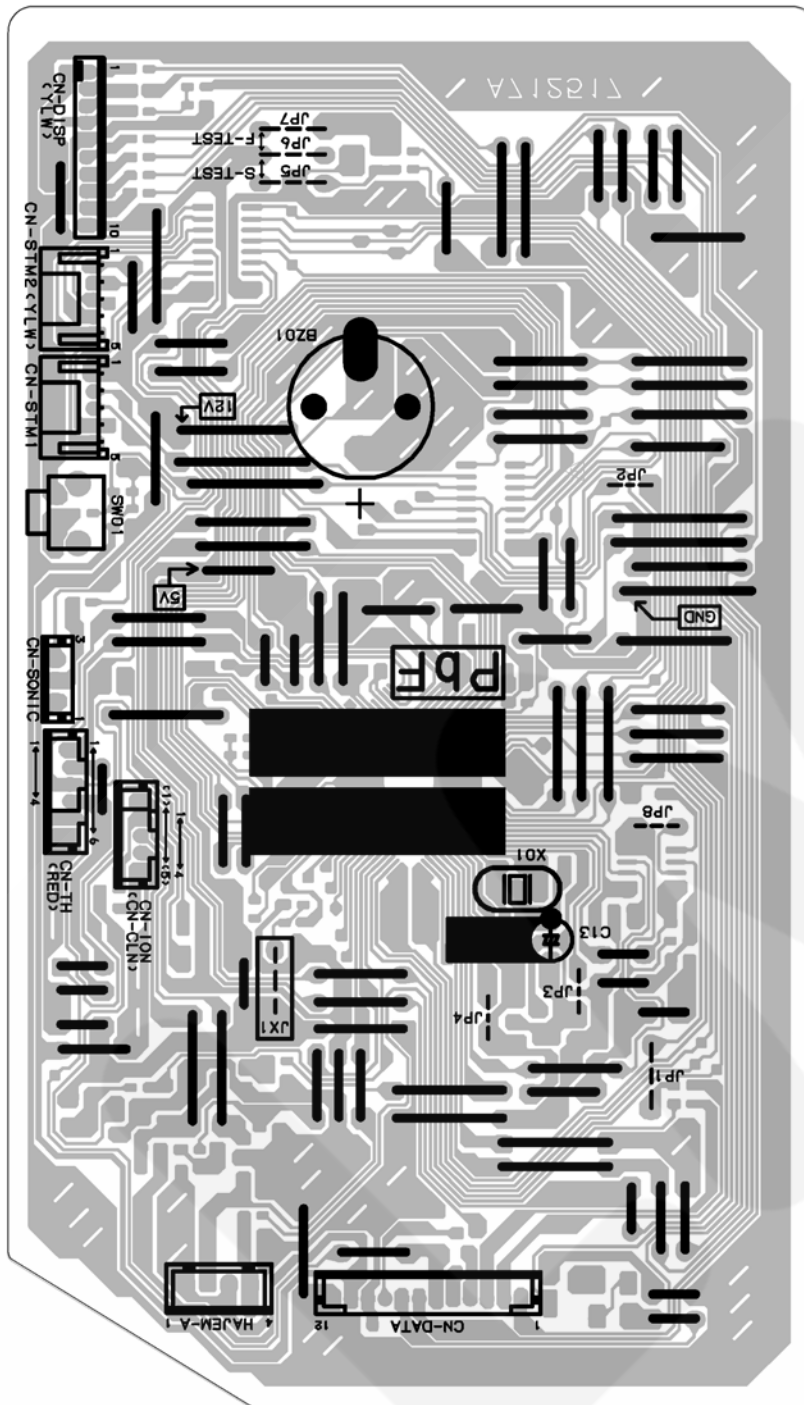

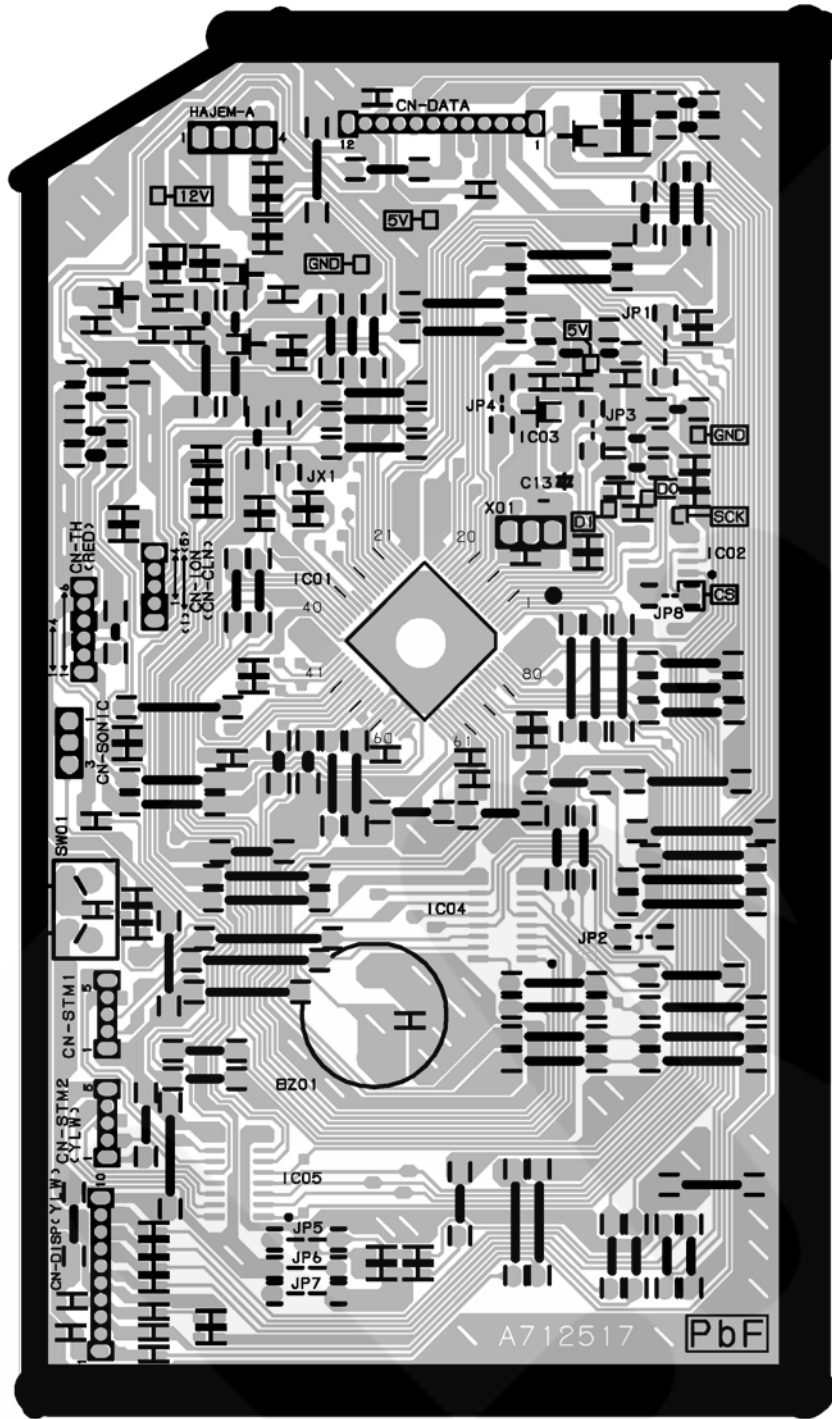

9.1.2. Power Printed Circuit Board

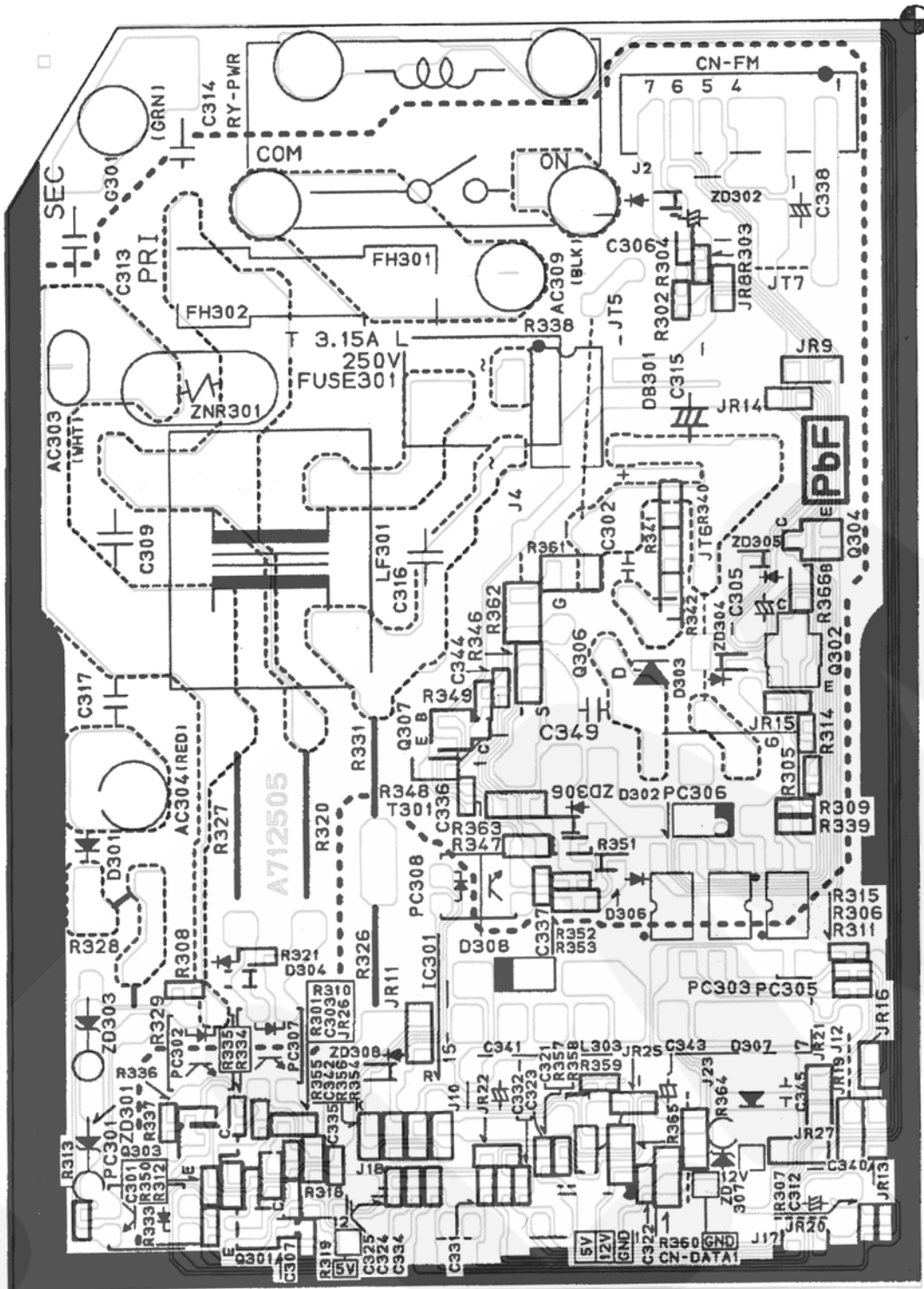

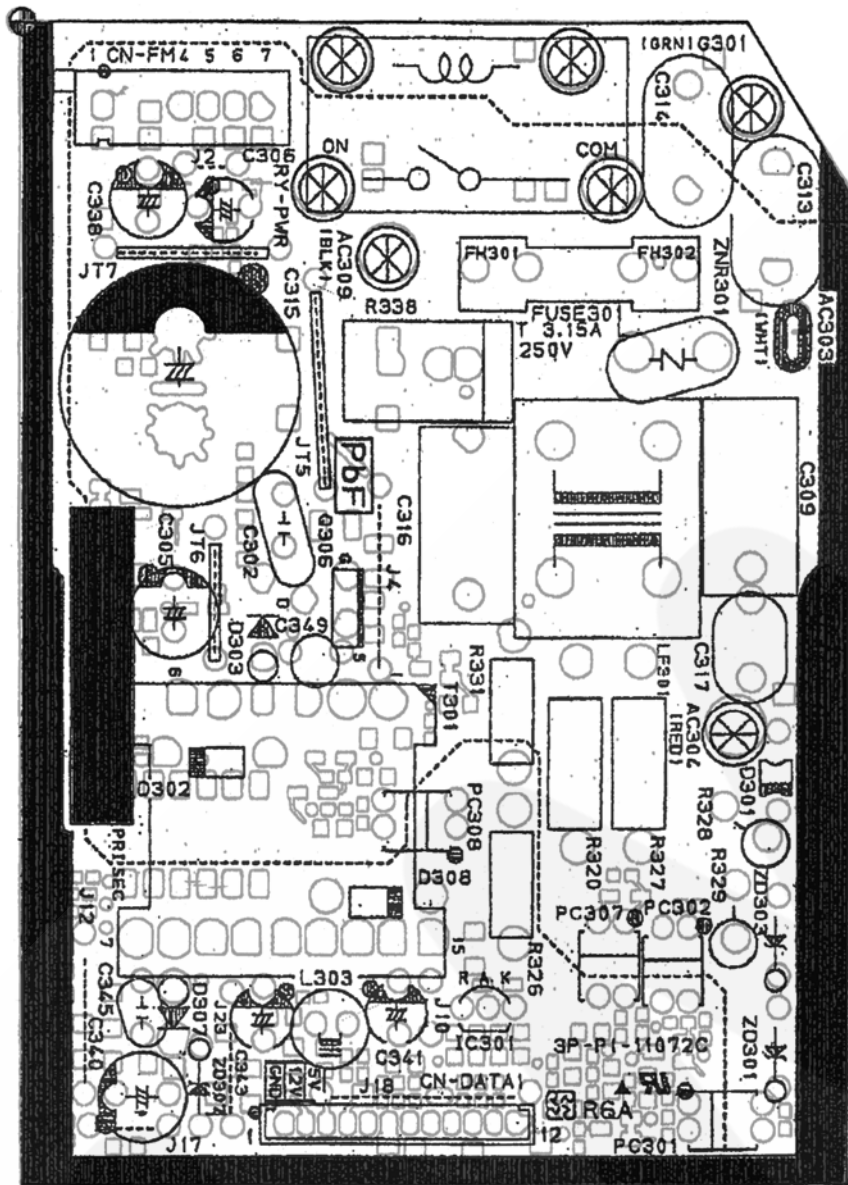

9.2. Outdoor Unit

9.2.1. Main Printed Circuit Board

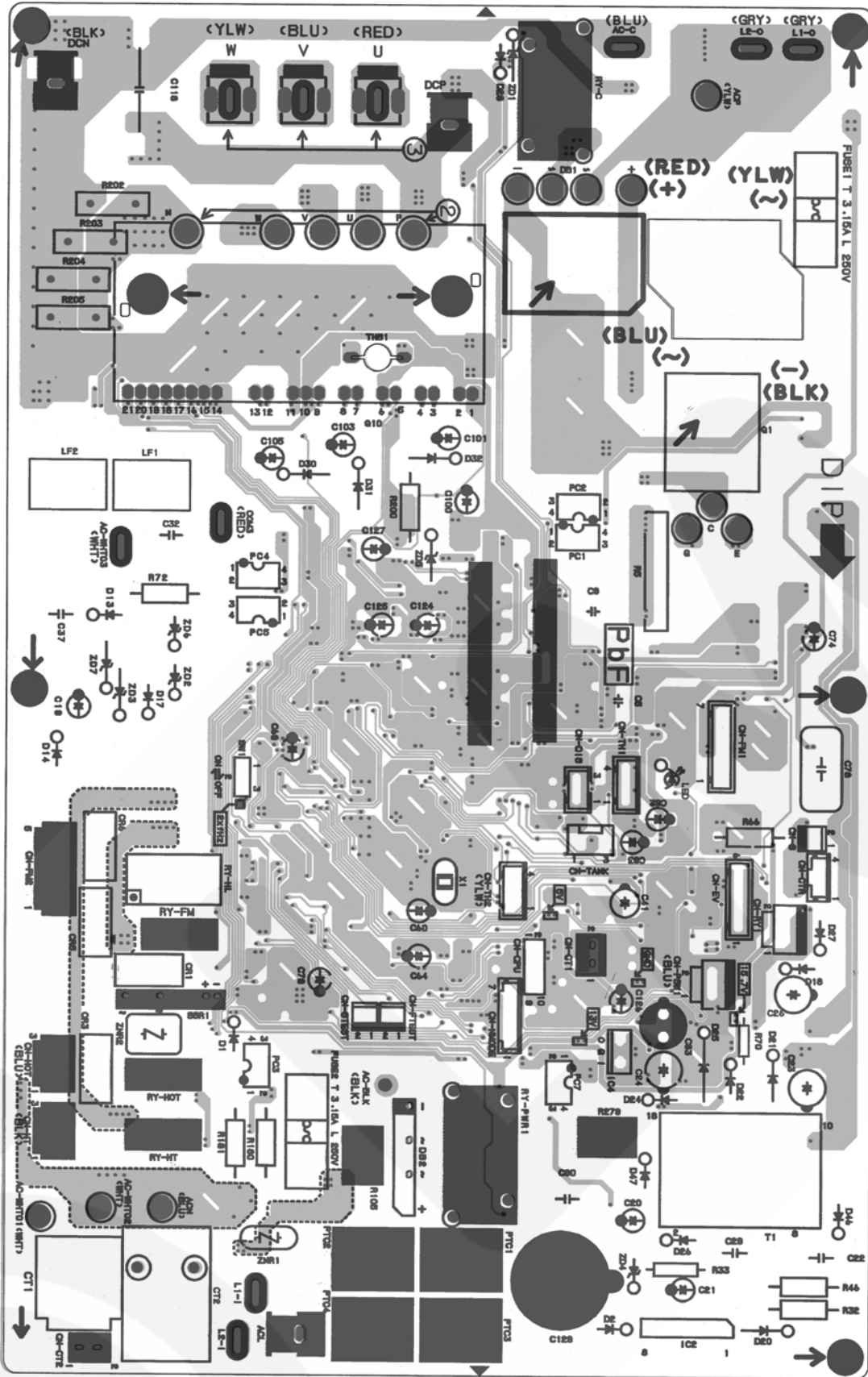

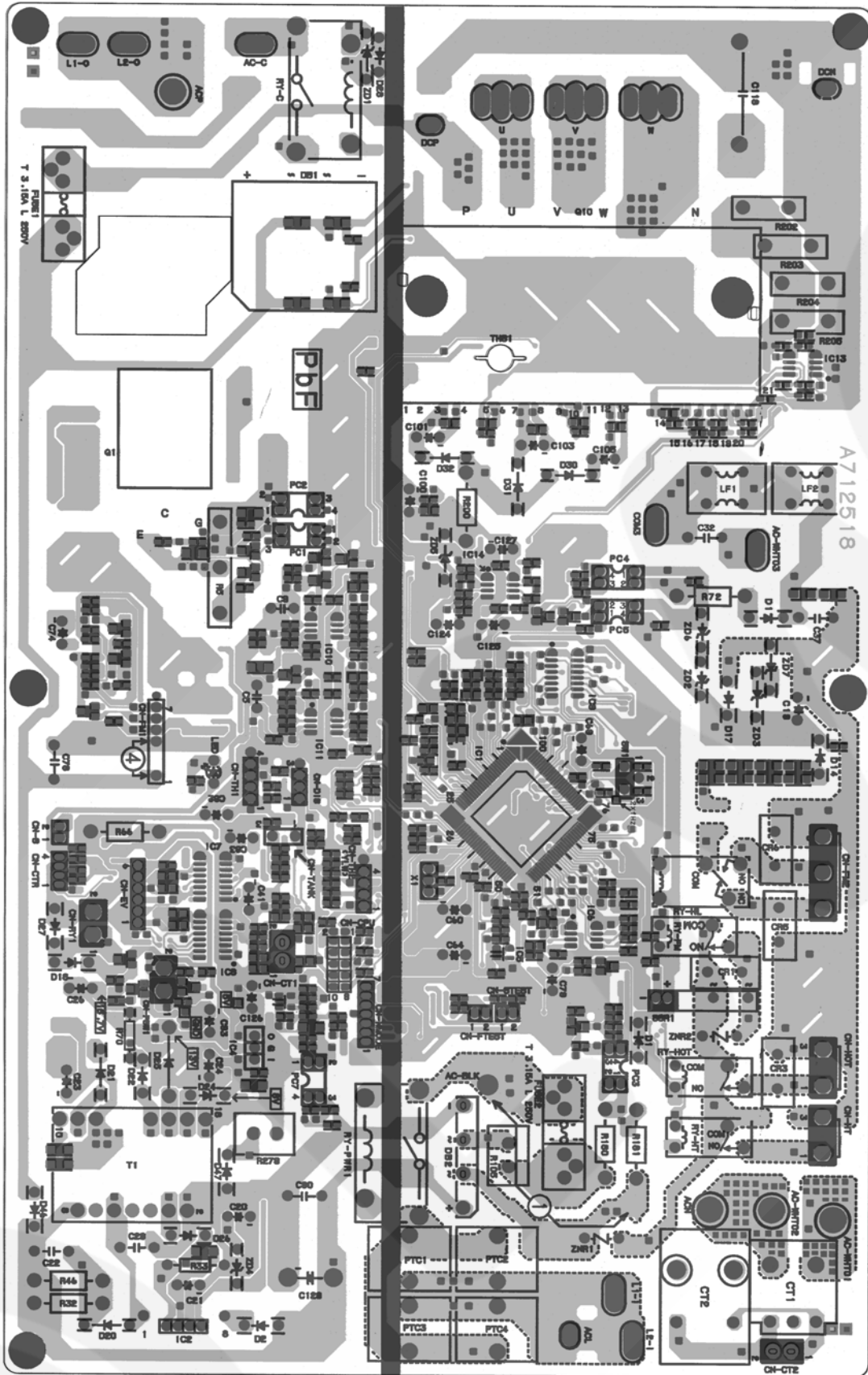

9.2.2. Power Printed Circuit Board

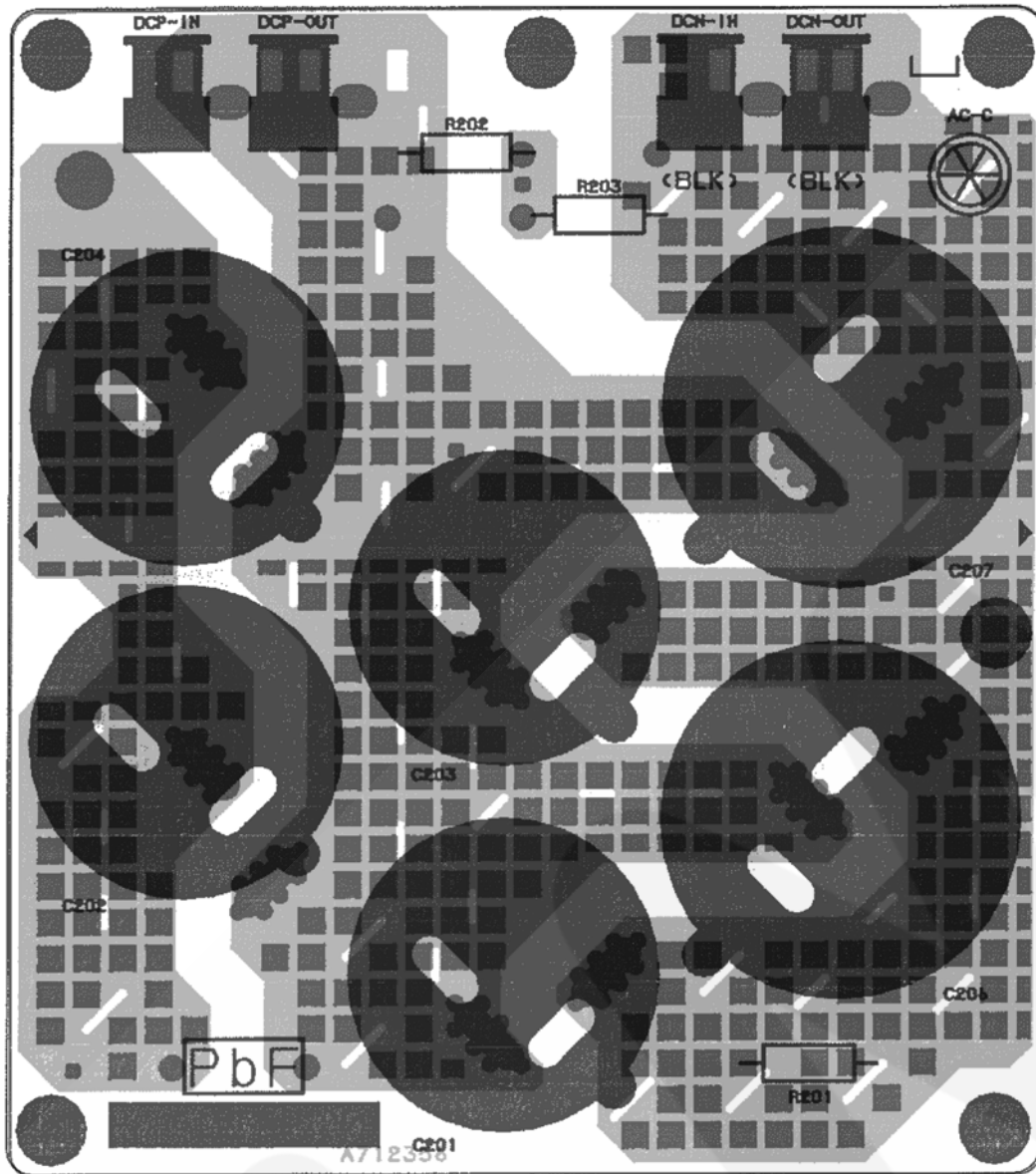

9.2.3. Noise Filter Printed Circuit Board

9.2.3.1. CU-E24EKE

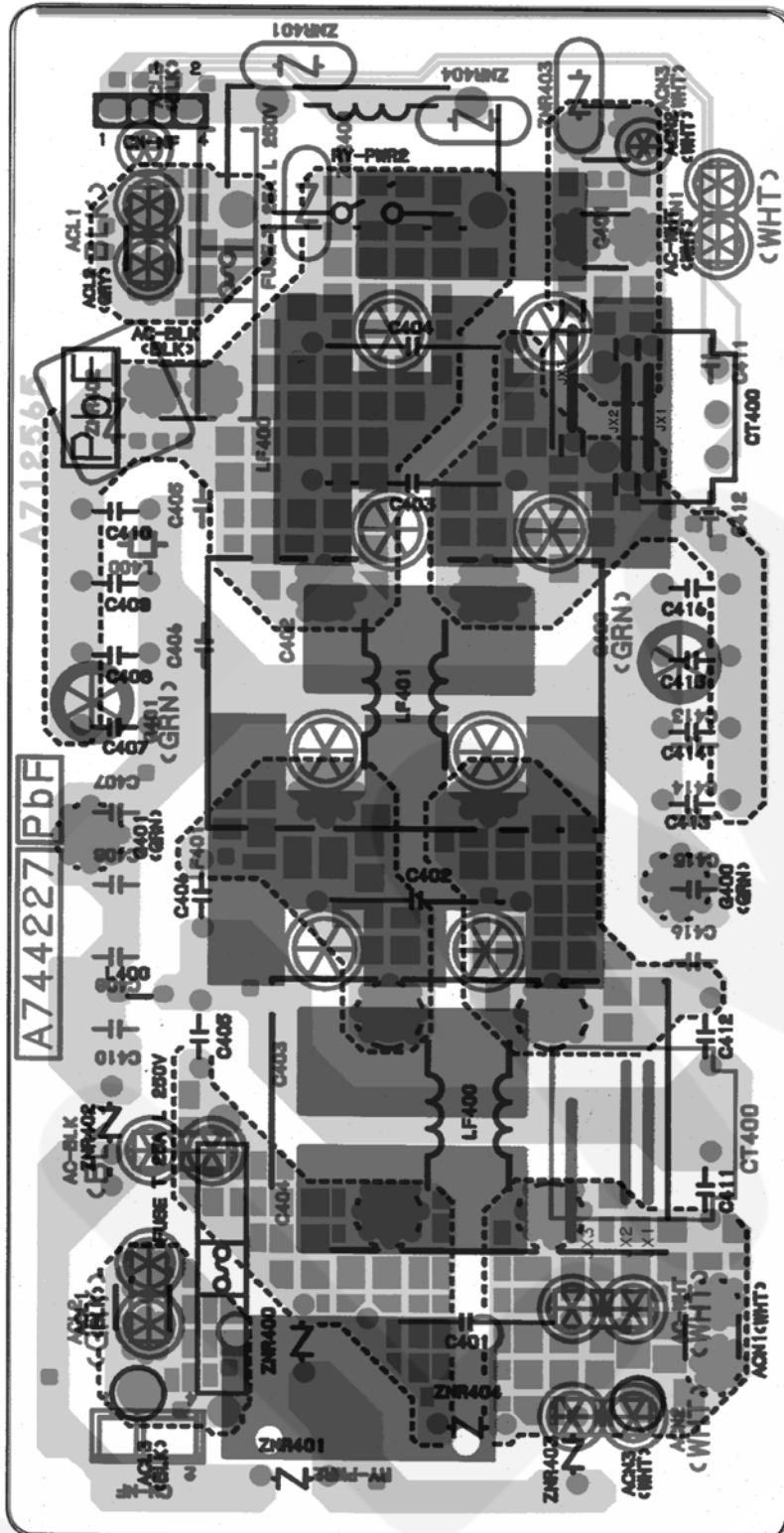

9.2.3.2. CU-E28EKE

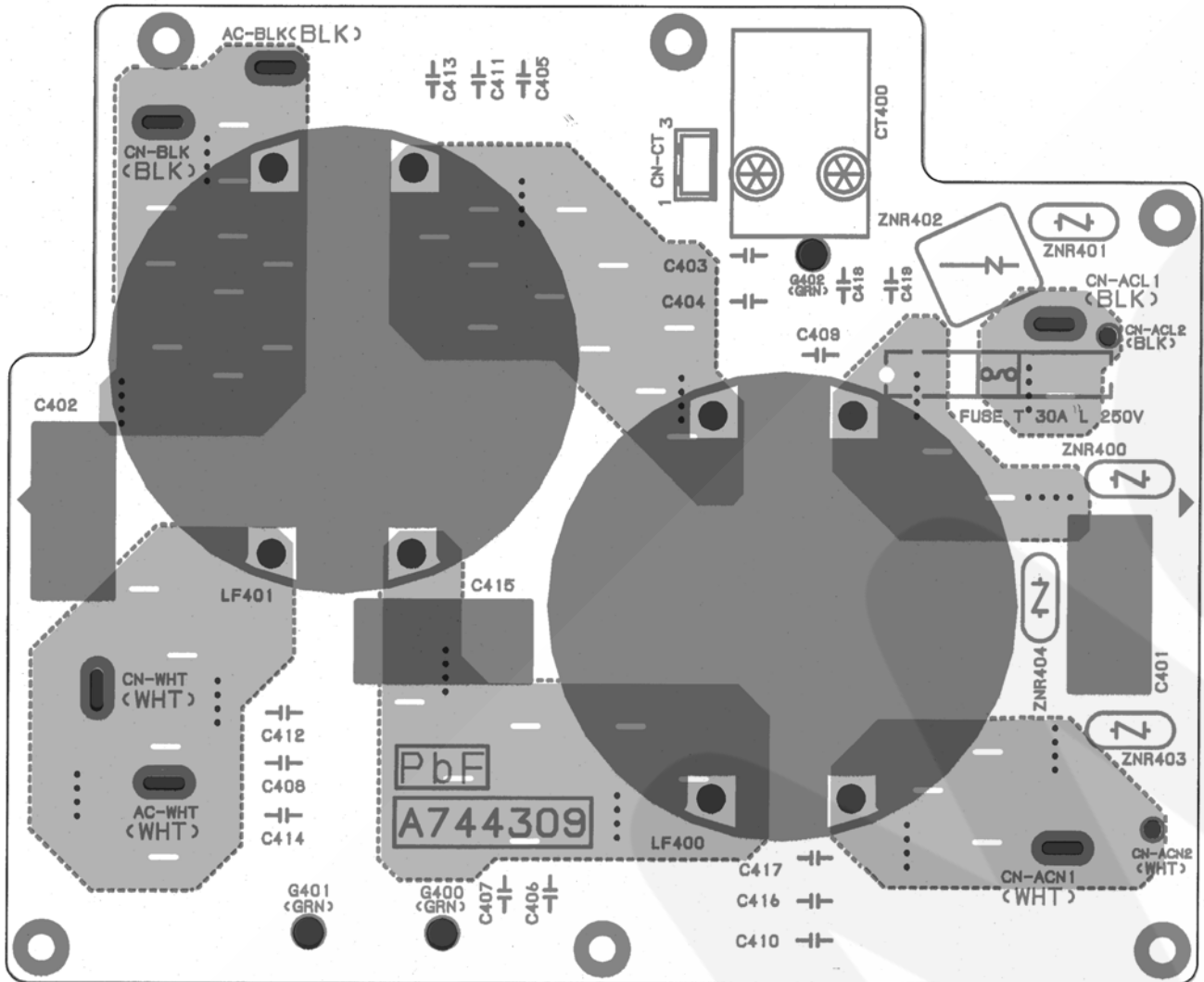

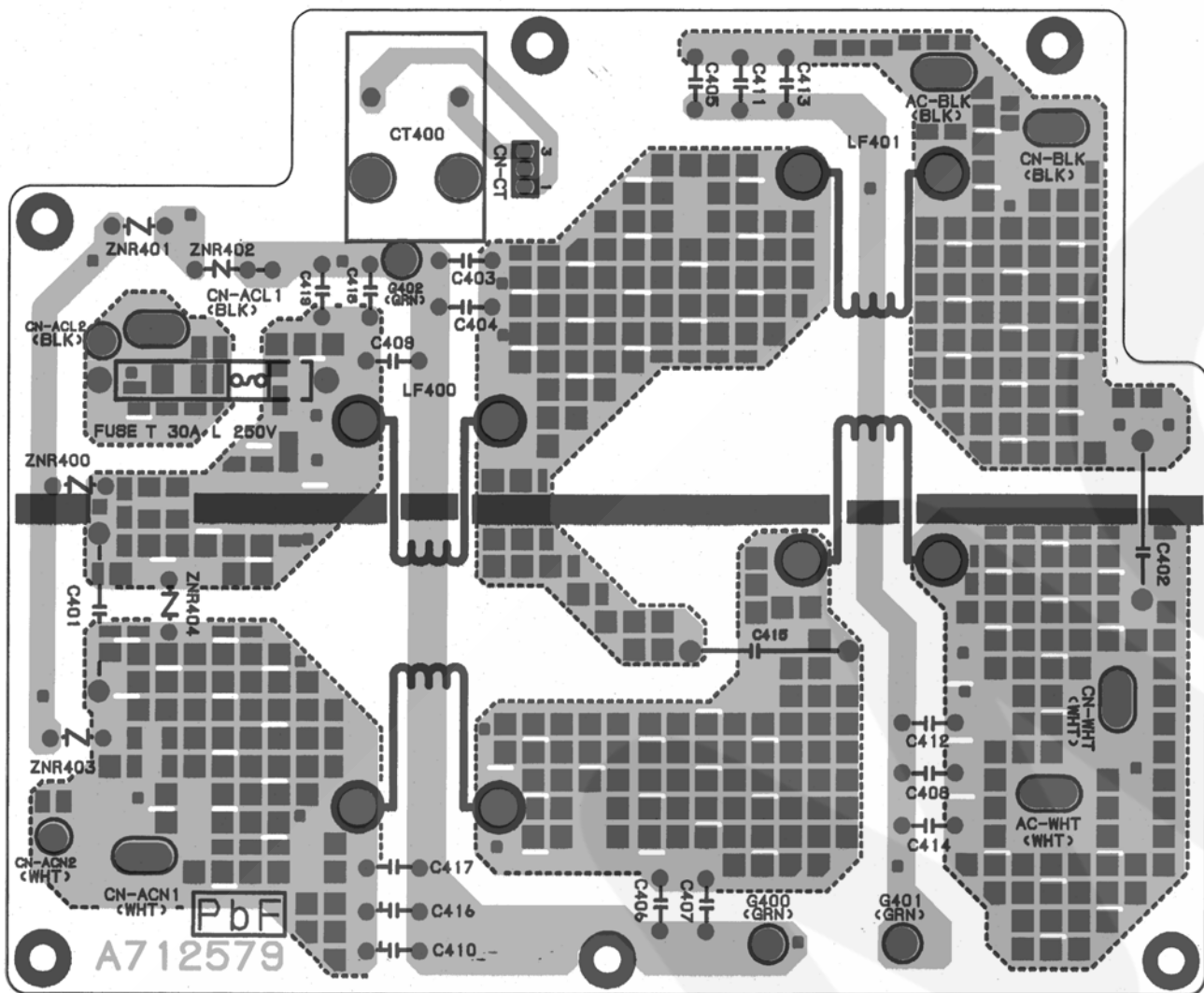

10 Installation Instruction

10.1. Select The Best Location

INDOOR UNIT

- There should not be any heat source or steam near the unit.
- There should not be any obstacles blocking the air circulation.
- A place where air circulation in the room is good.
- A place where drainage can be easily done.
- A place where noise prevention is taken into consideration.
- Do not install the unit near the door way.
- Ensure the spaces indicated by arrows from the wall, ceiling, fence or other obstacles.
- Recommended installation height for indoor unit shall be at least 2.5 m.

OUTDOOR UNIT

- If an awning is built over the unit to prevent direct sunlight or rain, be careful that heat radiation from the condenser is not obstructed.
- There should not be any animal or plant which could be affected by hot air discharged.
- Keep the spaces indicated by arrows from wall, ceiling, fence or other obstacles.
- Do not place any obstacles which may cause a short circuit of the discharged air.
- If piping length is over 10 m, additional refrigerant should be added as shown in the table.

Model	Piping size		Rated Length (m)	Max Elevation (m)	Max. piping Length (m)	Additional Refrigerant (g/m)
	Gas	Liquid				
E24EK	5/8"	1/4"	5	20	30	30
E28EK	5/8"	1/4"	5	20	30	30

Example : For E24EK

If the unit is installed at a 20 m distance, the quantity of additional refrigerant should be 300 g (20 - 10) m x 30 g/m = 300 g.

10.2. Indoor/Outdoor Unit Installation Diagram

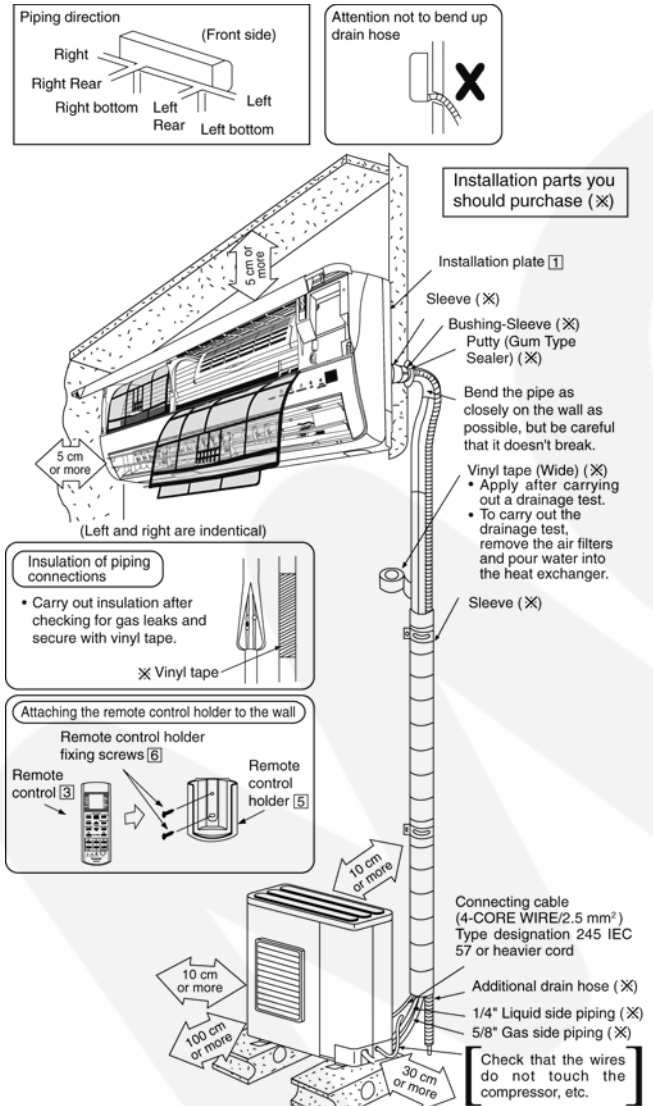

• This illustration is for explanation purposes only. The indoor unit will actually face a different way.

10.3. Indoor Unit

10.3.1. HOW TO FIX INSTALLATION PLATE

The mounting wall is strong and solid enough to prevent it from the vibration.

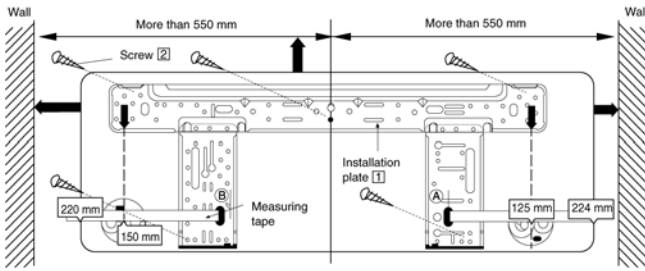

The centre of installation plate should be at more than 550 mm at right and left of the wall.

The distance from installation plate edge to ceiling should more than 67 mm.

From installation plate left edge to unit's left side is 47 mm.

From installation plate right edge to unit's right is 73 mm.

- Ⓑ :
- For left side piping, piping connection for liquid should be about 126 mm from this line.
 - For left side piping, piping connection for gas should be about 174 mm from this line.
 - For left side piping, piping connection cable should be about 984 mm from this line.

1. Mount the installation plate on the wall with 5 screws or more.
(If mounting the unit on the concrete wall consider using anchor bolts.)
 - Always mount the installation plate horizontally by aligning the marking-off line with the thread and using a level gauge.

2. Drill the piping plate hole with $\varnothing 70$ mm hole-core drill.
 - Line according to the arrows marked on the lower left and right side of the installation plate. The meeting point of the extended line is the centre of the hole. Another method is by putting measuring tape at position as shown in the diagram above. The hole centre is obtained by measuring the distance namely 150 mm and 125 mm for left and right hole respectively.
 - Drill the piping hole at either the right or the left and the hole should be slightly slanted to the outdoor side.

10.3.2. TO DRILL A HOLE IN THE WALL AND INSTALL A SLEEVE OF PIPING

1. Insert the piping sleeve to the hole.
2. Fix the bushing to the sleeve.
3. Cut the sleeve until it extrudes about 15 mm from the wall.

Caution

When the wall is hollow, please be sure to use the sleeve for tube ass'y to prevent dangers caused by mice biting the connecting cable.

4. Finish by sealing the sleeve with putty or caulking compound at the final stage.

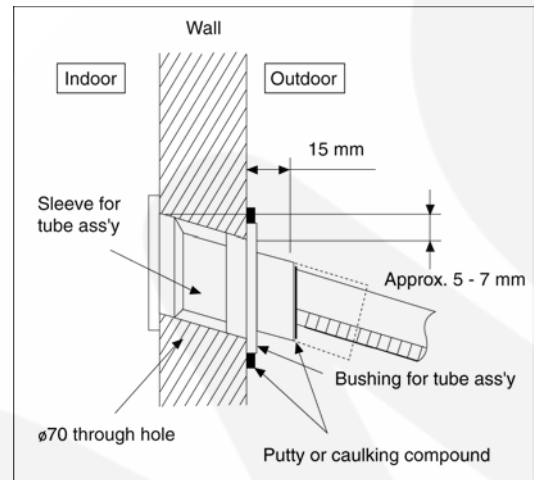

10.3.3. INDOOR UNIT INSTALLATION

1. For the right rear piping

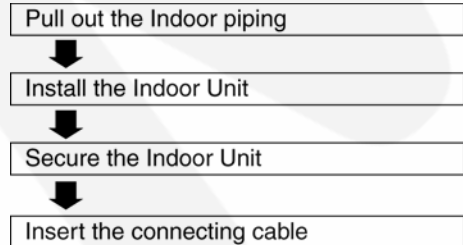

2. For the right and right bottom piping

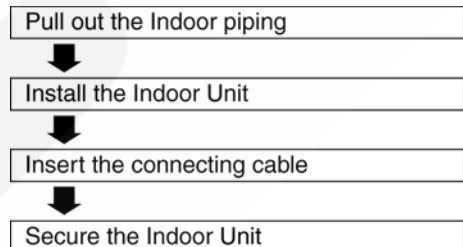

3. For the embedded piping

Replace the drain hose



Bend the embedded piping



- Use a spring bender or equivalent to bend the piping so that the piping is not crushed.

Install the Indoor Unit



Cut and flare the embedded piping



- When determining the dimensions of the piping, slide the unit all the way to the left on the installation plate.
- Refer to the section "Cutting and flaring the piping".

Pull the connecting cable into Indoor Unit



- The inside and outside connecting cable can be connected without removing the front grille.

Connect the piping



- Please refer to "Connecting the piping" column in outdoor unit section. (Below steps are done after connecting the outdoor piping and gas-leakage confirmation.)

Insulate and finish the piping



- Please refer to "Piping and finishing" column of outdoor section and "Insulation of piping connections" column as mentioned in Indoor/Outdoor Unit Installation.

Secure the Indoor Unit

Install the indoor unit

Hook the indoor unit onto the upper portion of installation plate. (Engage the indoor unit with the upper edge of the installation plate). Ensure the hooks are properly seated on the installation plate by moving it in left and right.

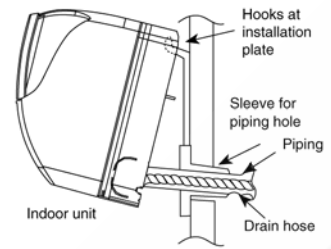

Secure the Indoor Unit

- Press the lower left and right side of the unit against the installation plate until hooks engages with their slot (sound click).

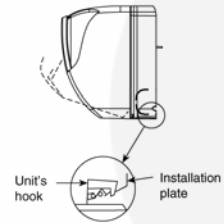

To take out the unit, push the **PUSH** marking at the bottom unit, and pull it slightly towards you to disengage the hooks from the unit.

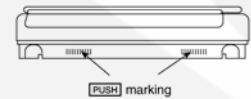

Pull out the piping and drain hose

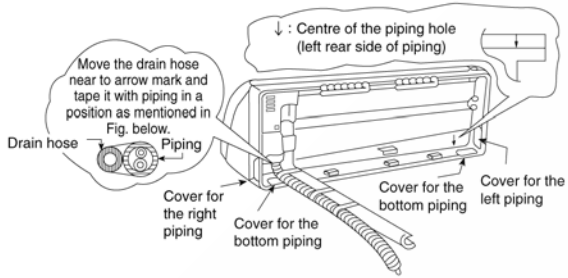

How to keep the cover

In case of the cover is cut, keep the cover at the rear of chassis as shown in the illustration for future reinstallation.

(Left, right and 2 bottom covers for piping.)

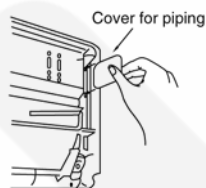

Insert the connecting cable

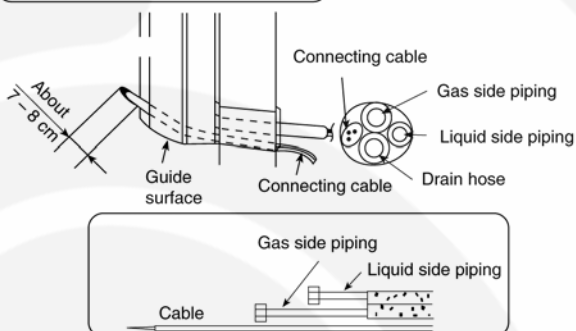

(This can be used for left rear piping and left bottom piping also.)

Exchange the drain hose and the cap

Rear view for left piping installation

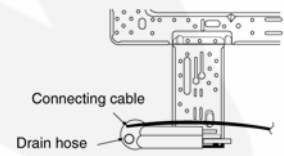
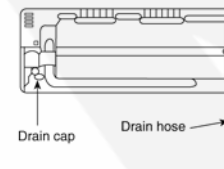

Adjust the piping slightly downwards.

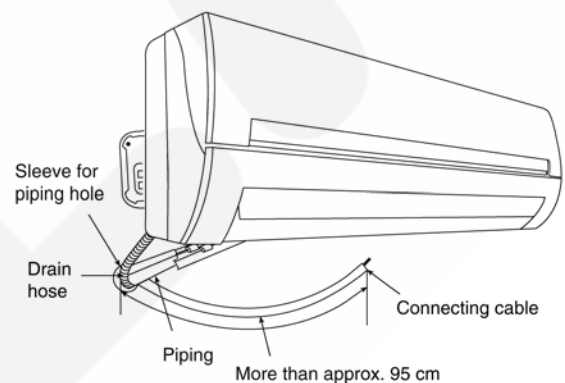

- How to pull the piping and drain hose out, in case of the embedded piping.

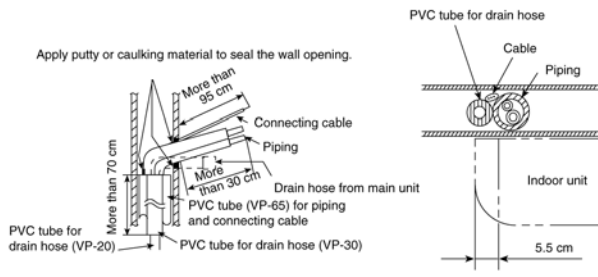

- In case of left piping how to insert the connecting cable and drain hose.

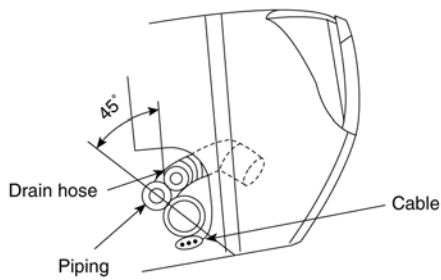

(For the right piping, follow the same procedure)

10.3.4. CONNECT THE CABLE TO THE INDOOR UNIT

1. The inside and outside connecting cable can be connected without removing the front grille.
2. Connecting cable between indoor unit and outdoor unit shall be approved polychloroprene sheathed $4 \times 1.5 \text{ mm}^2$ flexible cord, type designation 245 IEC 57 or heavier cord.
 - Ensure the colour of wires of outdoor unit and the terminal Nos. are the same to the indoor's respectively.
 - Earth lead wire shall be longer than the other lead wires as shown in the figure for the electrical safety in case of the slipping out of the cord from the anchorage.

Terminals on the indoor unit	1	2	3	
Colour of wires	Grey	Black	Blue	
Terminals on the outdoor unit	1	2	3	

- Secure the cable onto the control board with the holder (clammer).

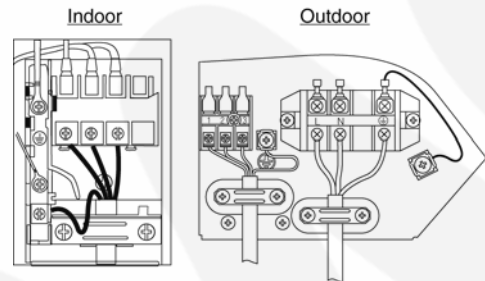

Terminal screw	Tightening torque N•cm (kgf•cm)
M3	69 ~ 98 (7 - 10)
M4	157 ~ 196 (16 - 20)
M5	196 ~ 245 (20 - 25)

10.4. Outdoor Unit

10.4.1. INSTALL THE OUTDOOR UNIT

- After selecting the best location, start installation according to Indoor/Outdoor Unit Installation Diagram.
 - Fix the unit on concrete or rigid frame firmly and horizontally by bolt nut ($\varnothing 10$ mm).
 - When installing at roof, please consider strong wind and earthquake. Please fasten the installation stand firmly with bolt or nails.

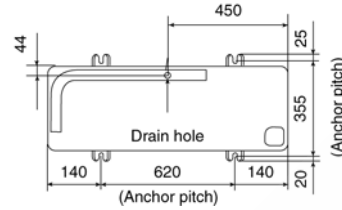

10.4.2. CONNECTING THE PIPING

Connecting The Piping To Indoor Unit

Please make flare after inserting flare nut (locate at joint portion of tube assembly) onto the copper pipe (in case of using long piping).

Connect the piping

- Align the center of piping and sufficiently tighten the flare nut with fingers.
- Further tighten the flare nut with torque wrench in specified torque as stated in the table.

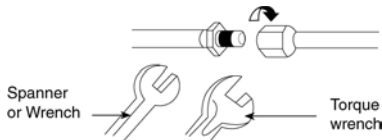

Model	Piping size (Torque)	
	Gas	Liquid
E24EK, E28EK	5/8" [65 N•m]	1/4" [18 N•m]

Connecting The Piping To Outdoor Unit

Decide piping length and then cut by using pipe cutter. Remove burrs from cut edge. Make flare after inserting the flare nut (locate at valve) onto the copper pipe. Align center of piping to valves and then tighten with torque wrench to the specified torque as stated in the table.

Local pipes can project in any of four directions.

- Make holes in the pipe panels for the pipes to pass through.
- Be sure to install the pipe panels to prevent rain from getting inside the outdoor unit.

[Removing the service panel].

- Remove the two mounting screws.
 - Slide the service panel downward to release the pawls.
- After this, pull the service panel toward you to remove it.

Be sure to use two spanners to tighten.
(If the nuts are overtightened, it may cause the flares to break or leak.)

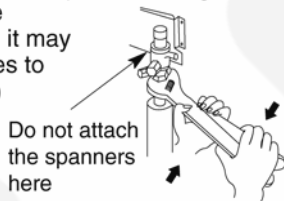

Close the tube joining area with putty heat insulator (local supply) without any gap as shown in right figure. (To prevent insects or small animal entering.)

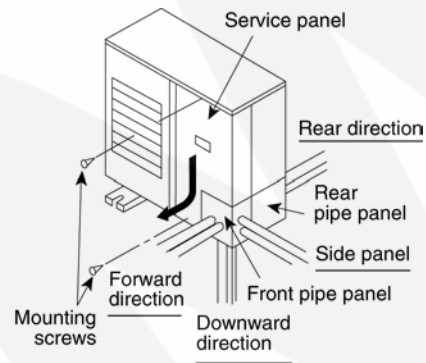
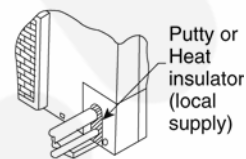

CUTTING AND FLARING THE PIPING

- Please cut using pipe cutter and then remove the burrs.
- Remove the burrs by using reamer. If burrs is not removed, gas leakage may be caused. Turn the piping end down to avoid the metal powder entering the pipe.
- Please make flare after inserting the flare nut onto the copper pipes.

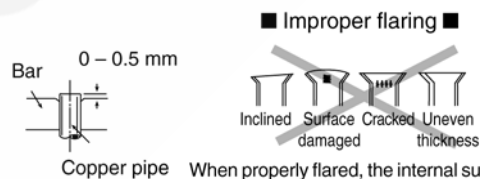
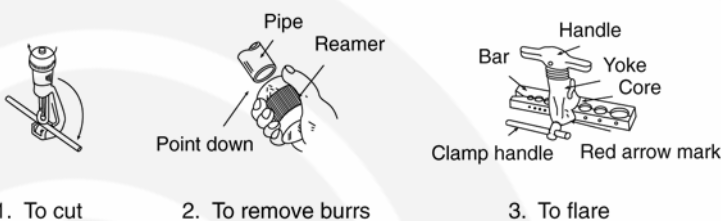

When properly flared, the internal surface of the flare will evenly shine and be of even thickness. Since the flare part comes into contact with the connections, carefully check the flare finish.

10.4.3. EVACUATION OF THE EQUIPMENT

WHEN INSTALLING AN AIR CONDITIONER, BE SURE TO EVACUATE THE AIR INSIDE THE INDOOR UNIT AND PIPES in the following procedure.

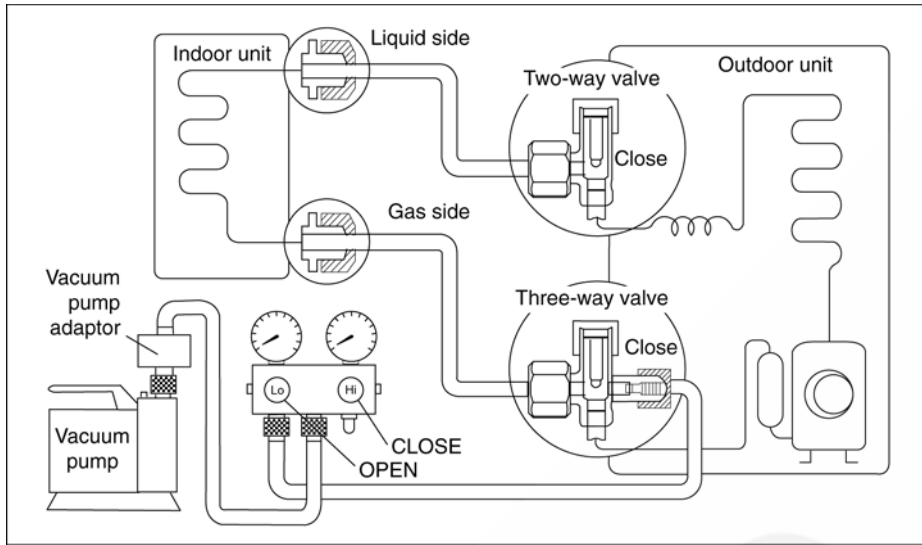

1. Connect a charging hose with a push pin to the Low side of a charging set and the service port of the 3-way valve.
 - Be sure to connect the end of the charging hose with the push pin to the service port.
2. Connect the center hose of the charging set to a vacuum pump with check valve, or vacuum pump and vacuum pump adaptor.
3. Turn on the power switch of the vacuum pump and make sure that the needle in the gauge moves from 0 cmHg (0 MPa) to -76 cmHg (-0.1 MPa). Then evacuate the air approximately ten minutes.
4. Close the Low side valve of the charging set and turn off the vacuum pump. Make sure that the needle in the gauge does not move after approximately five minutes.

Note: BE SURE TO FOLLOW THIS PROCEDURE IN ORDER TO AVOID REFRIGERANT GAS LEAKAGE.
5. Disconnect the charging hose from the vacuum pump and from the service port of the 3-way valve.
6. Tighten the service port caps of the 3-way valve at a torque of 18 N•m with a torque wrench.
7. Remove the valve caps of both of the 2-way valve and 3-way valve. Position both of the valves to "OPEN" using a hexagonal wrench (4 mm).
8. Mount valve caps onto the 2-way valve and the 3-way valve.
 - Be sure to check for gas leakage.

CAUTION

- If gauge needle does not move from 0 cmHg (0 MPa) to -76 cmHg (-0.1 MPa), in step ③ above take the following measure:
- If the leak stops when the piping connections are tightened further, continue working from step ③.
- If the leak does not stop when the connections are retightened, repair the location of leak.
- Do not release refrigerant during piping work for installation and reinstallation. Take care of the liquid refrigerant, it may cause frostbite.

10.4.4. CONNECT THE CABLE TO THE OUTDOOR UNIT

(FOR DETAIL REFER TO WIRING DIAGRAM AT UNIT)

1. Remove the control board cover from the unit by loosening the screw.
2. Connecting cable between indoor unit and outdoor unit shall be approved polychloroprene sheathed 4 x 1.5 mm² flexible cord, type designation 245 IEC 57 or heavier cord.

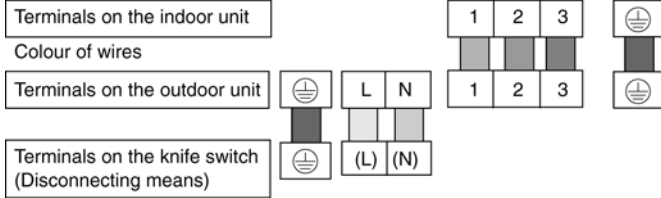

3. Secure the cable onto the control board with the holder (clammer).
4. Cable connection to the power supply through knife switch (Disconnecting means).
 - Connect the approved polychloroprene sheathed power supply cable (3 x 4.0 mm²), type designation 245 IEC 57 or heavier cord to the terminal board, and connect the other end of the cable to knife switch (Disconnecting means).
5. Select required direction and apply protective bushing provided in accessories to protect cables from sharp edges.
6. Once all wiring work has been completed, tie the wires and cord together with the binding strap so that they do not touch other parts such as the compressor and pipes.

Note: Knife switch (Disconnecting means) should have minimum 3.5 mm contact gap.

- Secure the cable onto the control board with the holder (clammer).

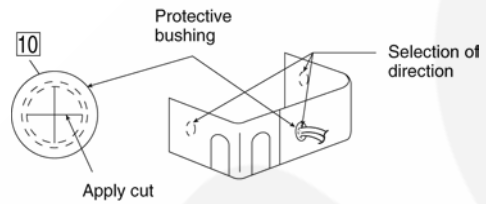
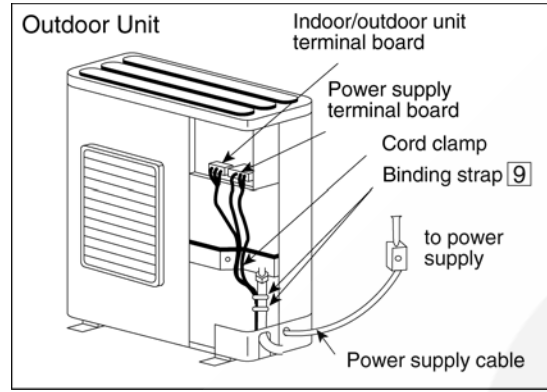

11 Operation And Function

11.1. Basic Function

Inverter control, which equipped with a microcomputer in determining the most suitable operating mode as time passes, automatically adjusts output power for maximum comfort always. In order to achieve the suitable operating mode, the microcomputer maintains the set temperature by measuring the temperature of the environment and performing temperature shifting. The compressor at outdoor unit is operating following the frequency instructed by the microcomputer at indoor unit that judging the condition according to internal setting temperature and intake air temperature.

11.1.1. Internal Setting Temperature

Once the operation starts, remote control setting temperature will be taken as base value for temperature shifting processes. These shifting processes are depending on the air conditioner settings and the operation environment. The final shifted value will be used as internal setting temperature and it is updated continuously whenever the electrical power is supplied to the unit.

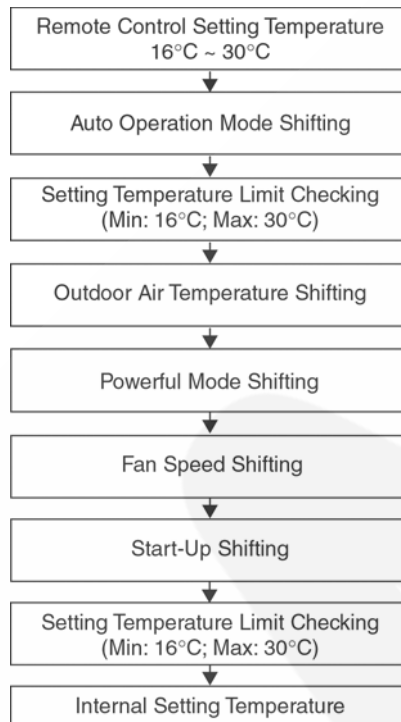

11.2. Airflow Direction

1. There are two types of airflow, vertical airflow (directed by horizontal vane) and horizontal airflow (directed by vertical vanes).
2. Control of airflow direction can be automatic (angles of direction is determined by operation mode, heat exchanger temperature and intake air temperature) and manual (angles of direction can be adjusted using remote control).

Vertical Airflow

Operation Mode	Airflow Direction		Vane Angle (°)				
			1	2	3	4	5
Heating	Auto with Heat Exchanger	A	19				
		B	49				
		C	8				
		D	8				
	Manual		8	17	33	49	60
Cooling, Soft Dry and Fan, Ion	Auto	8 ~ 38					
	Manual	8	17	25	33	38	
Mode Judgment in Auto	Auto	8					
	Manual	8	17	25	33	38	

- Automatic vertical airflow direction can be set using remote control; the vane swings up and down within the angles as stated above. For heating mode operation, the angle of the vane depends on the indoor heat exchanger temperature as Figure 1 below. When the air conditioner is stopped using remote control, the vane will shift to close position.
- Manual vertical airflow direction can be set using remote control; the angles of the vane are as stated above and the positions of the vane are as Figure 2 below. When the air conditioner is stopped using remote control, the vane will shift to close position.

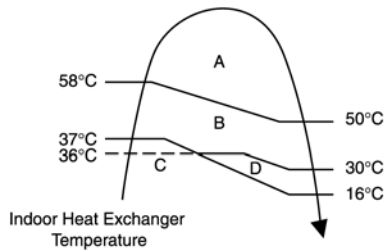

Figure 1

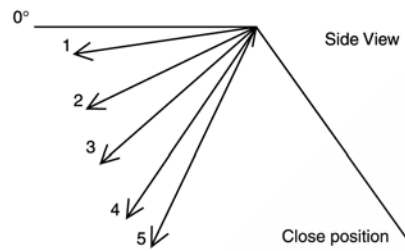

Figure 2

Horizontal Airflow

- Automatic horizontal airflow direction can be set using remote control; the vane swings left and right within the angles as stated below. For heating mode operation, the angle of the vane depends on the indoor heat exchanger temperature as Figure 1 below.

Operation Mode		Vane Angle (°)
Heating, with heat exchanger temperature	A	18 ~ 62
	B	90
Cooling, Soft Dry and Fan, Ion		18 ~ 62

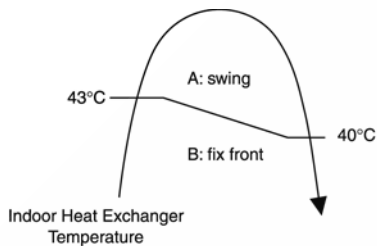

Figure 1

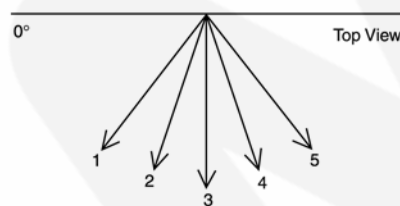

Figure 2

- Manual horizontal airflow direction can be set using remote control; the angles of the vane are as stated below and the positions of the vane are as Figure 2 above.

Pattern	1	2	3	4	5
Airflow Direction Patterns at Remote Control					
Vane Angle (°)	40	18	29	51	62

11.3. Quiet operation (Cooling Mode/Cooling area of Soft Dry Mode)

A. Purpose

To provide quiet cooling operation compare to normal operation.

B. Control condition

- Quiet operation start condition
 - When "quiet" button at remote control is pressed. Quiet LED illuminates.

b. Quiet operation stop condition

1. When one of the following conditions is satisfied, quiet operation stops:
 - a. Powerful button is pressed.
 - b. Stop by OFF/ON switch.
 - c. Timer "off" activates.
 - d. Quiet button is pressed again.
2. When quiet operation is stopped, operation is shifted to normal operation with previous setting.
3. When fan speed is changed, quiet operation is shifted to quiet operation of the new fan speed.
4. When operation mode is changed, quiet operation is shifted to quiet operation of the new mode.
5. During quiet operation, if timer "on" activates, quiet operation maintains.
6. After off, when on back, quiet operation is not memorised.

C. Control contents

1. Fan speed is changed from normal setting to quiet setting of respective fan speed.
This is to reduce sound of Hi, Me, Lo for 3dB.
2. Fan speed for quiet operation is -100 rpm from setting fan speed.

11.3.1. Quiet operation under Soft Dry operation (Dry area at Soft Dry Mode)

Automatic Fan Speed (Soft dry operation)

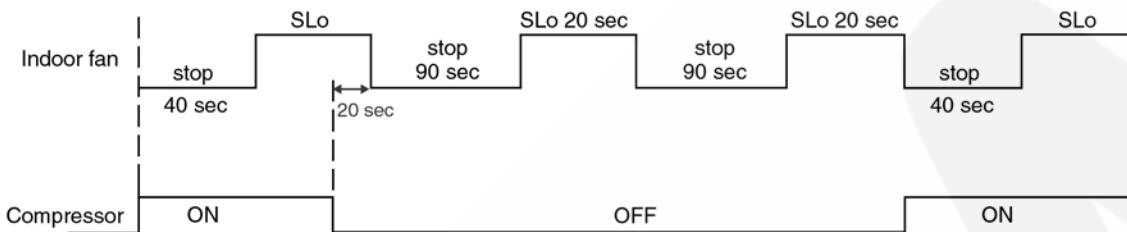

Manual Fan Speed (Soft dry operation)

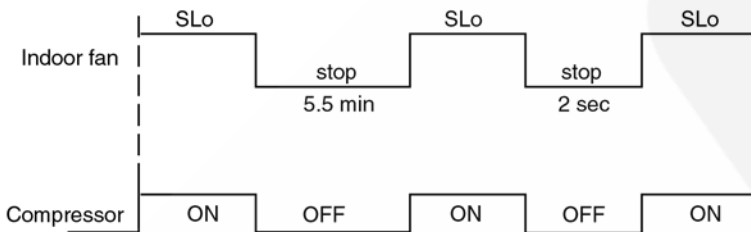

11.3.2. Quiet operation (Heating)

A. Purpose

To provide quiet heating operation compare to normal operation.

B. Control condition

- a. Quiet operation start condition
 - When "quiet" button at remote control is pressed.
Quiet LED illuminates.
- b. Quiet operation stop condition
 1. When one of the following conditions is satisfied, quiet operation stops:
 - a. Powerful button is pressed.
 - b. Stop by OFF/ON switch.
 - c. Timer "off" activates.
 - d. Quiet button is pressed again.
 2. When quiet operation is stopped, operation is shifted to normal operation with previous setting.
 3. When fan speed is changed, quiet operation is shifted to quiet operation of the new fan speed.
 4. When operation mode is changed, quiet operation is shifted to quiet operation of the new mode, except fan only mode.
 5. During quiet operation, if timer "on" activates, quiet operation maintains.
 6. After off, when on back, quiet operation is not memorised.

C. Control contents

a. Fan Speed manual

1. Fan speed is changed from normal setting to quiet setting of respective fan speed.
This is to reduce sound of Hi, Me, Lo for 3dB.
2. Fan speed for quiet operation is -100 rpm from setting fan speed.
3. Fan Speed Auto
 - If $FM < Lo$
-100 rpm reduce from normal Heating Auto Fan Speed
 - If $FM \geq Lo$
maintain RPM
Indoor FM RPM depends on pipe temp sensor of indoor heat exchanger.

11.4. Powerful Mode Operation

When the powerful mode is selected, the internal setting temperature will shift to achieve the setting temperature quickly.

(a) Cooling Operation

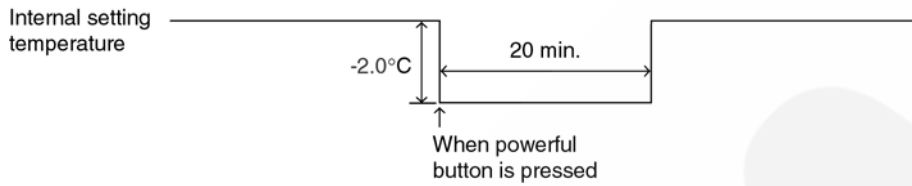

(b) Soft Dry Operation

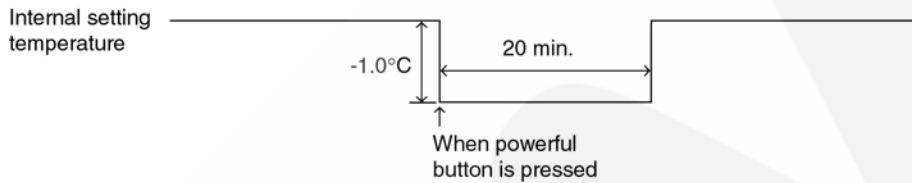

(c) Heating Operation

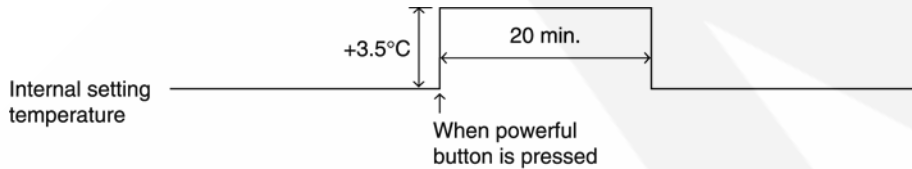

11.5. ON Timer Control

ON timer can be set using remote control, the unit with timer set will start operate earlier than the setting time. This is to provide a comfortable environment when reaching the set ON time.

Seventy minutes before the set time, indoor (at fan speed of Lo-) and outdoor fan motor start operate for 30 seconds to determine the indoor intake air temperature and outdoor air temperature in order to judge the operation starting time.

From the above judgment, the decided operation will start operate earlier than the set time as shown below.

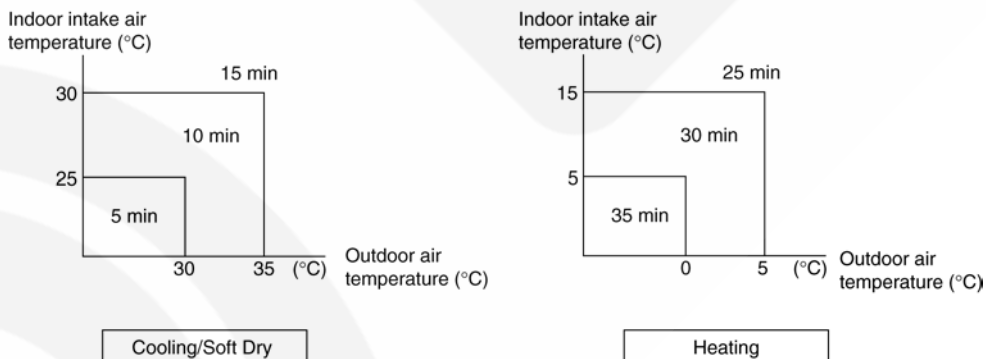

11.6. OFF Timer Control

OFF timer can be set using remote control, the unit with timer set will stop operate at set time.

11.7. Auto Restart Control

- When the power supply is cut off during the operation of air conditioner, the compressor will re-operate within three to four minutes (there are 10 patterns between 2 minutes 58 seconds and 3 minutes 52 seconds to be selected randomly) after power supply resumes.
- This type of control is not applicable during ON/OFF Timer setting.

11.8. Ionizer Operation

Purpose

To provide fresh air effect to users by discharging minus ion to air.

Control Condition

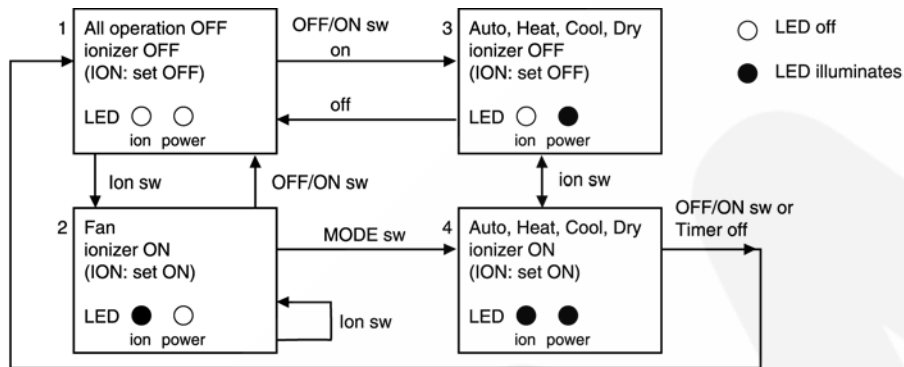

a. Ionizer Only Operation.

- When air-conditioner unit is at "OFF" condition (standby) and ION operation button at remote control is pressed. Fan & ionizer on, ION LED illuminates, but power LED maintain off. (1 → 2)
However, fan speed can be adjusted later by customer during this operation.

Fan speed	
Manual	Remote Control set fan speed
Auto	Repetition of 8 patterns as shown below

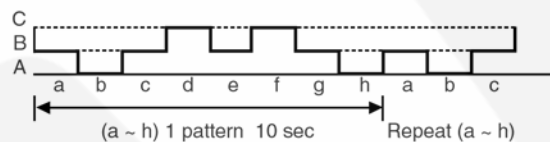

Airflow direction (Horizontal Vane) control:

Follow vane direction control at cooling mode.

Horizontal vane can be changed by customer during ion only operation.

b. Operation Mode + Ionizer Operation.

1. Ionising Operation Start Condition

When air conditioner unit is in "ON" condition (Heat, Cool, Soft Dry, Auto mode) and ION operation button at remote control is pressed. Ionizer on & ION LED illuminates. (3 → 4)
Power LED also illuminates.

2. Ionising Operation Stop Condition

When one of the following condition is satisfied, ION operation stops.

- Stopped by ON/OFF switch.
- Timer OFF activates.
- ION feedback signal shows error.

- Ionizer operation status is not memorised by micon. After OFF, when operation is "ON" again, air conditioner operates without ionizer operation.

12 Protection Control

12.1. Protection Control For All Operations

12.1.1. Time Delay Safety Control

1. The compressor will not start for three minutes after stop of operation.
2. This control is not applicable if the power supply is cut off and on again or after 4-way valve deices condition.

12.1.2. 30 Seconds Forced Operation

1. Once the compressor starts operation, it will not stop its operation for 30 seconds.
2. However, it can be stopped using remote control or Auto Switch at indoor unit.

12.1.3. Total Running Current Control

1. When the outdoor unit total running current (AC) exceeds X value, the frequency instructed for compressor operation will be decreased.
2. If the running current does not exceed X value for five seconds, the frequency instructed will be increased.
3. However, if total outdoor unit running current exceeds Y value, compressor will be stopped immediately for 2 minutes.

Operation Mode	E24EK		E28EK	
	X (A)	Y (A)	X (A)	Y (A)
Cooling/Soft Dry (A)	14.0	20.0	14.9	20.0
Cooling/Soft Dry (B)	12.0	20.0	14.6	20.0
Cooling/Soft Dry (C)	14.0	20.0	14.9	20.0
Heating	12.8	20.0	16.2	20.0

4. The first 30 minutes of cooling operation, (A) will be applied.

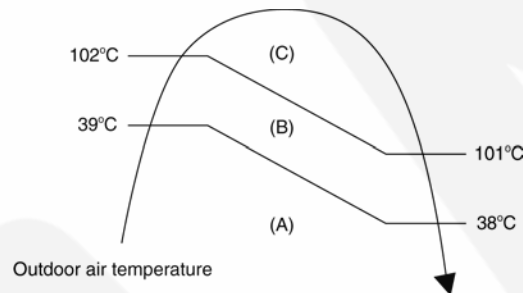

12.1.4. IPM (Power transistor) Prevention Control

- A. Overheating Prevention Control**
 1. When the IPM temperature rises to 110°C, compressor operation will stop immediately.
 2. Compressor operation restarts after three minutes the temperature decreases to 95°C.
- B. DC Peak Current Control**
 1. When electric current to IPM exceeds set value of 30.0 ± 5.0 A, the compressor will stop operate. Then, operation will restart after three minutes.
 2. If the set value is exceeded again more than 30 seconds after the compressor starts, the operation will restart after two minutes.
 3. If the set value is exceeded again within 30 seconds after the compressor starts, the operation will restart after one minute. If this condition repeats continuously for seven times, all indoor and outdoor relays will be cut off.

12.1.5. Compressor Overheating Prevention Control

Instructed frequency for compressor operation will be regulated by compressor top temperature. The changes of frequency are as below figure.

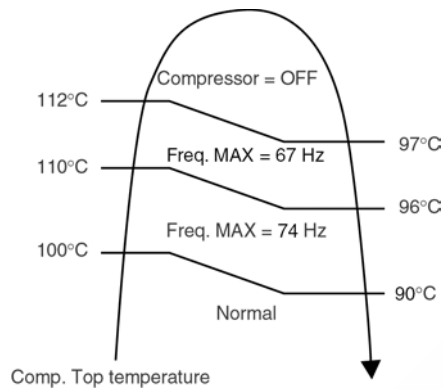

12.2. Protection Control For Cooling & Soft Dry Operation

12.2.1. Outdoor Air Temperature Control

The compressor operating frequency is regulated in accordance to the outdoor air temperature as shown in the diagram below.

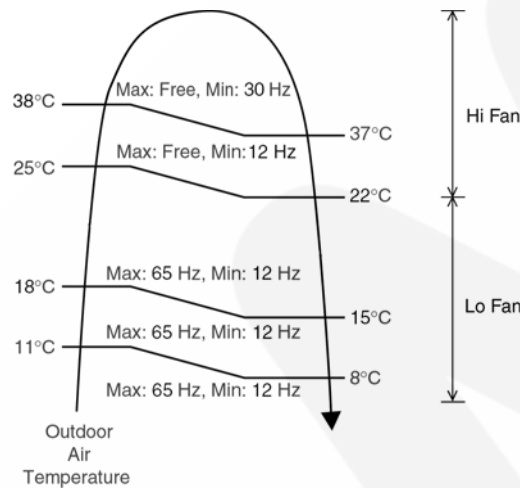

12.2.2. Cooling Overload Control

i. Pipe temperature limitation/restriction

- Detects the Outdoor pipe temperature and carry out below restriction/limitation (Limit the compressor Operation frequency)
- The compressor stop if outdoor pipe temperature exceeds 65°C.
- If the compressor stops 4 times in 20 minutes, Timer LED blinking (F95: outdoor high pressure rise protection)

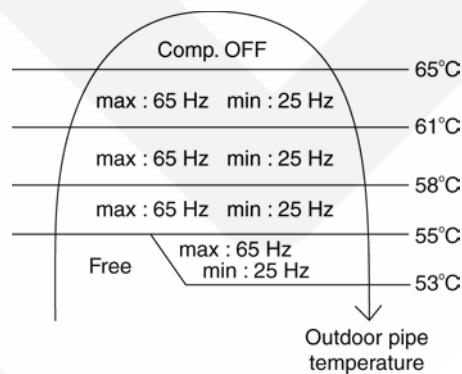

ii. Electrical part temperature rise protection control

- To prevent electrical component temperature rise during cooling overload.
- Judgement condition is by outdoor temperature (sampled every 10s).

- Control contents:
 - Outdoor fan speed (switch to zone A and B minimum fan speed).
 - Outdoor total current (zone C) higher than the specified.
- Cancellation condition: When one of above is not satisfied.

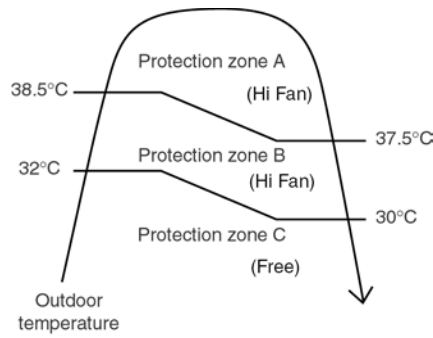

Outdoor total current

zone A	13.0 A
zone B	11.0 A
zone C	5.0 A

12.2.3. Freeze Prevention Control

- When indoor heat exchanger temperature is lower than 2°C continuously for six minutes, compressor will stop operating.
- Compressor will resume its operation three minutes after the indoor heat exchanger is higher than 10°C.
- At the same time, indoor fan speed increase +40 rpm compared to its normal operation.
- If indoor heat exchanger temperature is higher than 10°C for five minutes, the fan speed will return to its normal operation.

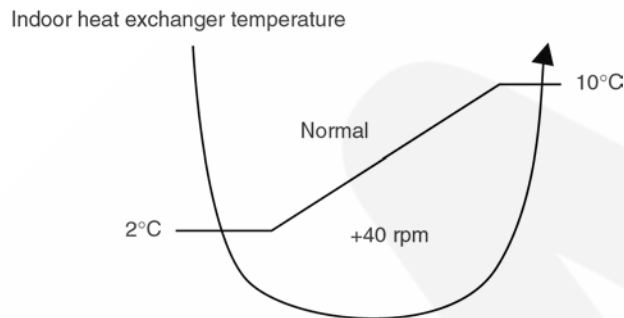

12.3. Protection Control For Heating Operation

12.3.1. Intake Air Temperature Control

Compressor will operate at rated freq. or less respectively if either one of the below conditions occur:

- When the indoor intake air temperature is above 10°C and remote control setting fan speed is lower Me-.
- When the indoor intake air temperature is 30°C or above.

12.3.2. Outdoor Air Temperature Control

The compressor operating frequency is regulated in accordance to the outdoor air temperature as shown in the below figures. This control will begin one minute after the compressor starts.

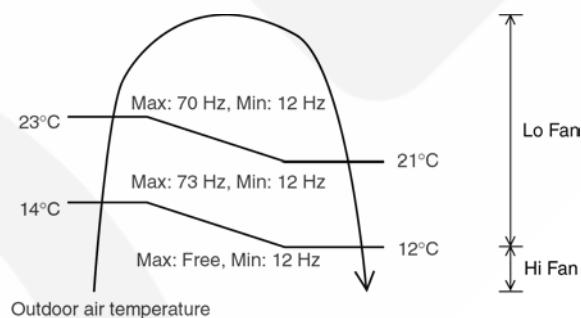

12.3.3. Overload Protection Control

The compressor operating frequency is regulated in accordance to indoor heat exchanger temperature as shown in below figures.

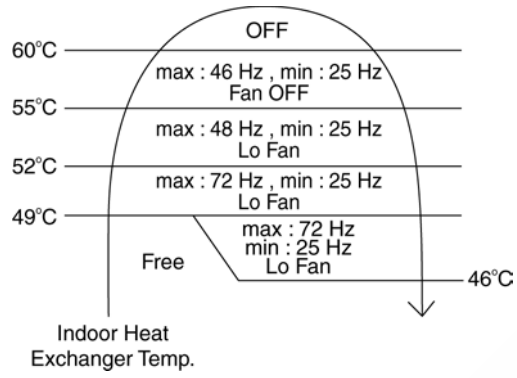

13 Servicing Mode

13.1. Auto Switch Operation

The below operations will be performed by pressing the "AUTO" switch.

1. AUTO OPERATION MODE

The Auto operation will be activated immediately once the Auto Switch is pressed.

2. TEST RUN OPERATION (FOR PUMP DOWN/SERVICING PURPOSE)

The Test Run operation will be activated if the Auto Switch is pressed continuously for more than 5 sec. A "beep" sound will occur at the fifth sec., in order to identify the starting of Test Run operation.

3. REMOTE CONTROLLER RECEIVING SOUND ON/OFF

The ON/OFF of remote controller receiving sound can be change over by pressing the following step:

a. Release the Auto Switch after Test Run operation is activated.

b. Then, within 20 sec., after a., press Auto Switch for more than 5 sec.

A "beep" "beep" sound will occur at the fifth sec., then release the Auto Switch.

c. Within 20 sec. after b., press Auto Switch again. Everytime Auto Switch is pressed (within 20 sec. interval), remote controller receiving sound status will be reversed between ON and OFF.

Long "beep" sound indicates that remote controller receiving sound is OFF.

Short "beep" sound indicates that remote controller receiving sound is ON.

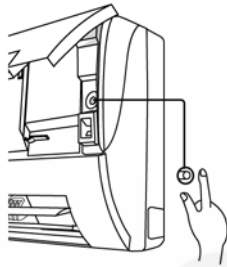

4.

Number of "beep":	1	2	3	4
Function:	Auto Operation	Forced Cool	Forced Heat	Various Setting Mode
Duration (s):	0	5	8	11
				16
				21

a. When the switch is pressed between 0 to 5 seconds, Auto Mode operation starts to function.

b. When the switch is pressed between 5 to 8 seconds, the unit is forced to operate in Cooling Mode.

c. When the switch is pressed between 8 to 11 seconds, the unit will enter forced Heating Mode standby. Press timer decrement button for 5S for the unit to operate in Heating Mode.

d. When the switch is pressed between 11 to 16 seconds and together with the signal from remote control (timer decrement button for 5S), the unit can be changed to different controlling setting (4 type of transmission codes).

e. When the switch is pressed between 16 to 21 seconds, either "H14" error detection selection mode or the remote control signal receiving sound can be cancelled or turned on.

13.2. Selecting The Wireless Remote Control Transmission Code

When there are more than one indoor units installed in the same room, it is possible to set different remote control receiving signal by modifying the jumpers inside Remote Control.

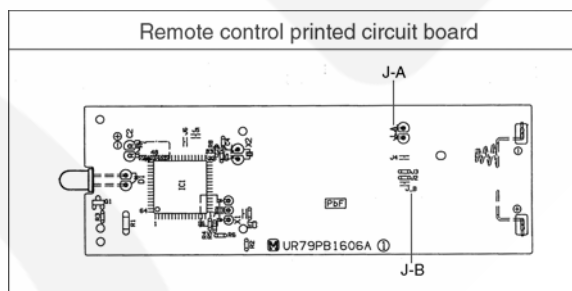

	Remote control printed circuit board		Note
	J - A	J - B	
0	SHORT	OPEN	At product delivery
1	OPEN	OPEN	
2	SHORT	SHORT	
3	OPEN	SHORT	

13.3. Indication Panel

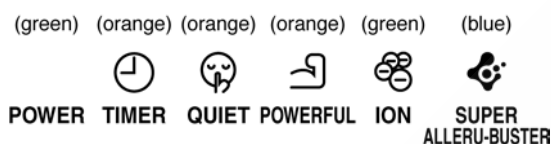

LED	POWER	TIMER	QUIET	POWERFUL	ION	ALLERGEN BUSTER
Color	Green	Orange	Orange	Orange	Green	Blue
Light ON	Operation ON	Timer Setting ON	Quiet Mode ON	Powerful Mode ON	Ion Mode ON	Operation ON
Light OFF	Operation OFF	Timer Setting OFF	Quiet Mode OFF	Powerful Mode OFF	Ion Mode OFF	Operation OFF

Note:

- If POWER LED is blinking, the possible operations of the unit are Hot Start, during Deice operation, operation mode judgment, or delay ON timer sampling.
- If Timer LED is blinking, there is an abnormality operation occurs.
- If Ionizer, LED is blinking, there is an abnormality of Ionizer occurs.

14 Troubleshooting Guide

14.1. Refrigeration Cycle System

In order to diagnose malfunctions, make sure that there are no electrical problems before inspecting the refrigeration cycle. Such problems include insufficient insulation, problem with the power source, malfunction of a compressor and a fan. The normal outlet air temperature and pressure of the refrigeration cycle depends on various conditions, the standard values for them are shown in the table on the right.

Normal Pressure and Outlet Air Temperature (Standard)

	Gas pressure MPa (kg/cm ² G)	Outlet air temperature (°C)
Cooling Mode	0.9 ~ 1.2 (9 ~ 12)	12 ~ 16
Heating Mode	2.3 ~ 2.9 (23 ~ 29)	36 ~ 45

- ★ Condition:
- Indoor fan speed; High
 - Outdoor temperature 35°C at cooling mode and 7°C at heating mode.
 - Compressor operates at rated frequency

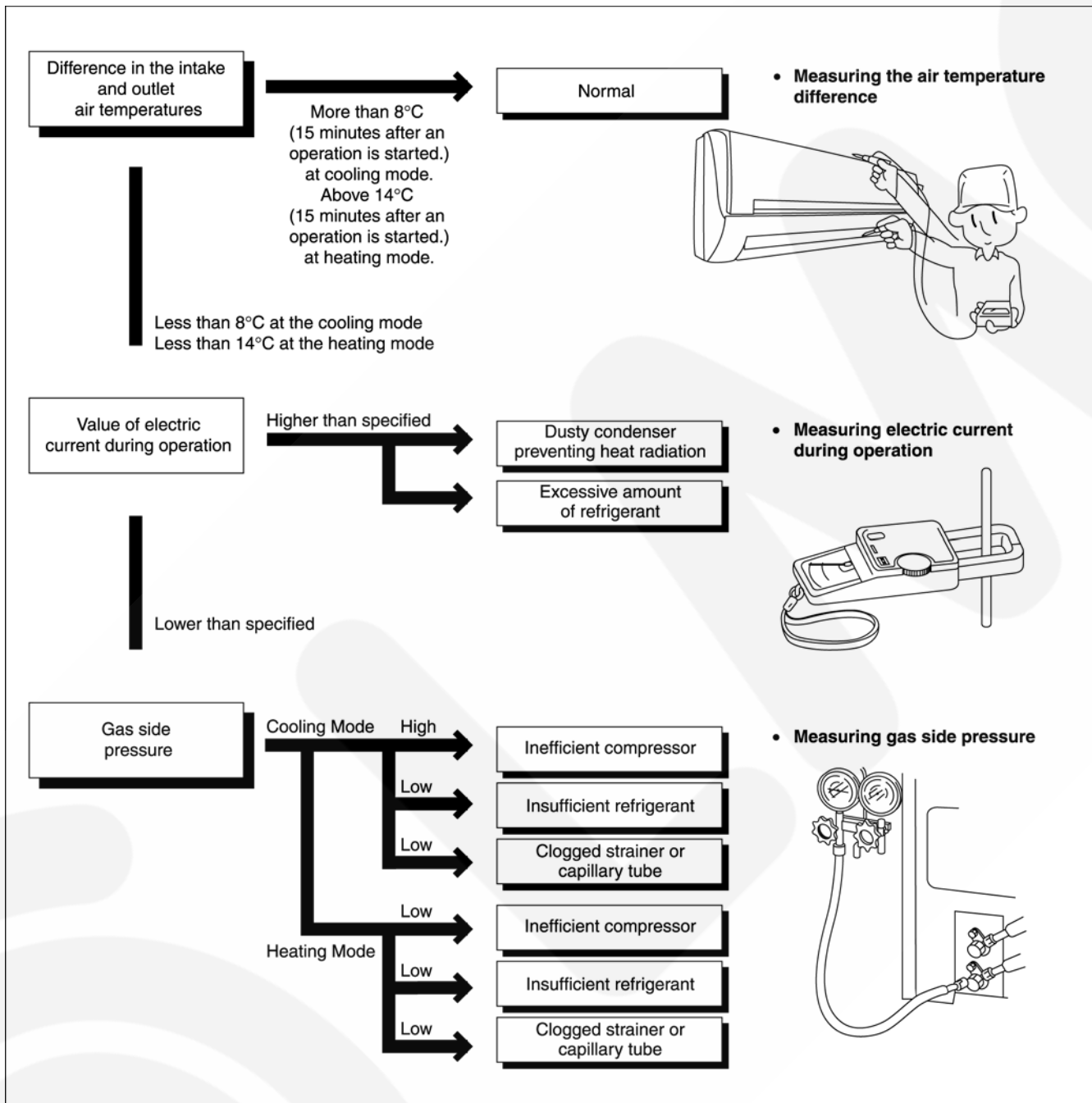

14.2. Relationship Between The Condition Of The Air Conditioner And Pressure And Electric Current

Condition of the air conditioner	Cooling Mode			Heating Mode		
	Low Pressure	High Pressure	Electric current during operation	Low Pressure	High Pressure	Electric current during operation
Insufficient refrigerant (gas leakage)	↘	↘	↘	↘	↘	↘
Clogged capillary tube or Strainer	↘	↘	↘	↗	↗	↗
Short circuit in the indoor unit	↘	↘	↘	↗	↗	↗
Heat radiation deficiency of the outdoor unit	↗	↗	↗	↘	↘	↘
Inefficient compression	↗	↘	↘	↗	↘	↘

- Carry out the measurements of pressure, electric current, and temperature fifteen minutes after an operation is started.

14.3. Breakdown Self Diagnosis Function

14.3.1. Self Diagnosis Function (Three Digits Alphanumeric Code)

- Once abnormality has occurred during operation, the unit will stop its operation, and Timer or both Timer and ION LEDs blink. (The unit does not stop under ION abnormality.)
- Although Timer LED goes off when power supply is turned off, if the unit is operated under a breakdown condition, the LED will light up again.
- In operation after breakdown repair, the Timer LED will no more blink. The last error code (abnormality) will be stored in IC memory.

• To make a diagnosis

1. Timer LED or both timer and ION LEDs start to blink and the unit automatically stops the operation.
2. Press the CHECK button on the remote controller continuously for 5 seconds.
3. “- -” will be displayed on the remote controller display. Note: Display only for “- -”. (No transmitting signal, no receiving sound and no Power LED blinking.)
4. Press the “TEMP” ▲ or ▼ button on the remote controller. The code “H00” (no abnormality) will be displayed and signal will be transmitted to the main unit.
5. Every press of the button (up or down) will increase abnormality numbers and transmit abnormality code signal to the main unit.
6. When the latest abnormality code on the main unit and code transmitted from the remote controller are matched, power LED will light up for 30 seconds and a beep sound (continuously for 4 seconds) will be heard. If no codes are matched, power LED will light up for 0.5 seconds and no sound will be heard.
7. The breakdown diagnosis mode will be canceled unless pressing the CHECK button continuously for 5 seconds or operating the unit for 30 seconds.
8. The LED will be off if the unit is turned off or the AC button on the main unit is pressed.

• To display memorized error (Protective operation) status:

1. Turn power on.
2. Press the CHECK button on the remote controller continuously for 5 seconds.
3. “- -” will be displayed on the remote controller display. Note: Display only for “- -”. (No transmitting signal, no receiving sound and no Power LED blinking.)
4. Press the “TEMP” ▲ or ▼ button on the remote controller. The code “H00” (no abnormality) will be displayed and signal will be transmitted to the main unit. The power LED lights up. If no abnormality is stored in the memory, three beeps sound will be heard.
5. Every press of the button (up or down) will increase abnormality numbers and transmit abnormality code signal to the main unit.
6. When the latest abnormality code on the main unit and code transmitted from the remote controller are matched, power LED will light up for 30 seconds and a beep sound (continuously for 4 seconds) will be heard. If no codes are matched, power LED will light up for 0.5 seconds and no sound will be heard.

7. The breakdown diagnosis mode will be canceled unless pressing the CHECK button continuously for 5 seconds or operating the unit for 30 seconds.
8. The same diagnosis can be repeated by turning power on again.



• To clear memorized error (Protective operation) status after repair:

1. Turn power on.
2. Press the AUTO button for 5 seconds (A beep receiving sound) on the main unit to operate the unit at Forced Cooling Operation mode.
3. Press the CHECK button on the remote controller.

• Temporary Operation (Depending on breakdown status)

1. Press the AUTO button (A beep receiving sound) on the main unit to operate the unit. (Remote control will become possible.)
2. The unit can temporarily be used until repaired.

Error Code	Operation	Temporary items
H23	Cooling	Emergency Operation with limited power
H27, H28	Cooling, Heating	
H26	Cooling, Heating	Emergency Operation without power limit

14.4. Error Codes Table

Diagnosis display	Abnormality / Protection control	Abnormality Judgement	Emergency operation	Primary location to verify
H00	No abnormality detected	—	Normal operation	—
H11	Indoor / outdoor abnormal communication	> 1 min after starting operation	Indoor fan operation only	<ul style="list-style-type: none"> • Internal / external cable connections • Indoor / Outdoor PCB
H14	Indoor intake air temperature sensor abnormality	Continue for 5 sec.	—	<ul style="list-style-type: none"> • Intake air temperature sensor (defective or disconnected)
H15	Outdoor compressor temperature sensor abnormality	Continue for 5 sec.	—	<ul style="list-style-type: none"> • Compressor temperature sensor (defective or disconnected)
H16	Outdoor Current Transformer open circuit	—	—	<ul style="list-style-type: none"> • Outdoor PCB • IPM (Power transistor) module
H19	Indoor fan motor mechanism lock	—	—	<ul style="list-style-type: none"> • Indoor PCB • Fan motor
H23	Indoor heat exchanger temperature sensor abnormality	Continue for 5 sec.	O (Cooling only)	<ul style="list-style-type: none"> • Heat exchanger temperature sensor (defective or disconnected)
H26	Ion abnormality	—	—	<ul style="list-style-type: none"> • Indoor PCB • Ionizer
H27	Outdoor air temperature sensor abnormality	Continue for 5 sec.	O	<ul style="list-style-type: none"> • Outdoor temperature sensor (defective or disconnected)
H28	Outdoor heat exchanger temperature sensor abnormality	Continue for 5 sec.	O	<ul style="list-style-type: none"> • Outdoor heat exchanger temperature sensor (defective or disconnected)
H30	Discharge temperature sensor abnormality	—	—	—
H33	Indoor/Outdoor wrong connection	—	—	<ul style="list-style-type: none"> • Indoor/Outdoor supply voltage
H38	Indoor/Outdoor mismatch	—	—	—
H98	Indoor high pressure protection	—	—	<ul style="list-style-type: none"> • Air filter dirty • Air circulation short circuit
H99	Indoor heat exchanger anti-freezing protection	—	—	<ul style="list-style-type: none"> • Insufficient refrigerant • Air filter dirty
F11	Cooling / Heating cycle changeover abnormality	4 times occurrence within 30 minutes	—	<ul style="list-style-type: none"> • 4-way valve • V-coil
F90	PFC control	4 times occurrence within 10 minutes	—	<ul style="list-style-type: none"> • Voltage at PFC
F91	Refrigeration cycle abnormality	7 times occurrence continuously	—	<ul style="list-style-type: none"> • No refrigerant (3-way valve is closed)
F93	Outdoor compressor abnormal revolution	4 times occurrence within 20 minutes	—	<ul style="list-style-type: none"> • Outdoor compressor
F95	Cool high pressure protection	4 times occurrence within 20 minutes	—	<ul style="list-style-type: none"> • Outdoor refrigerant circuit
F96	IPM (power transistor) overheating protection	—	—	<ul style="list-style-type: none"> • Excess refrigerant • Improper heat radiation • IPM (Power transistor)
F97	Outdoor compressor overheating protection	4 times occurrence within 20 minutes	—	<ul style="list-style-type: none"> • Insufficient refrigerant • Compressor
F98	Total running current protection	3 times occurrence within 20 minutes	—	<ul style="list-style-type: none"> • Excess refrigerant • Improper heat radiation
F99	Outdoor Direct Current (DC) peak detection	7 times occurrence continuously	—	<ul style="list-style-type: none"> • Outdoor PCB • IPM (Power transistor) • Compressor

Note:

“O” - Frequency measured and fan speed fixed.

The memory data of error code is erased when the power supply is cut off, or press the Auto Switch until “beep” sound heard following by pressing the “CHECK” button at Remote Control.

Although operation forced to stop when abnormality detected, emergency operation is possible for certain errors (refer to Error Codes Table) by using Remote Control or Auto Switch at indoor unit. However, the Remote Control signal receiving sound is changed from one “beep” to four “beep” sounds.

15 Disassembly and Assembly Instructions

WARNING

High voltages are generated in the electrical parts area by the capacitor. Ensure that the capacitor has discharged sufficiently before proceeding with repair work. Failure to heed this caution may result in electric shocks.

15.1. Indoor Electronic Controller and Control Board

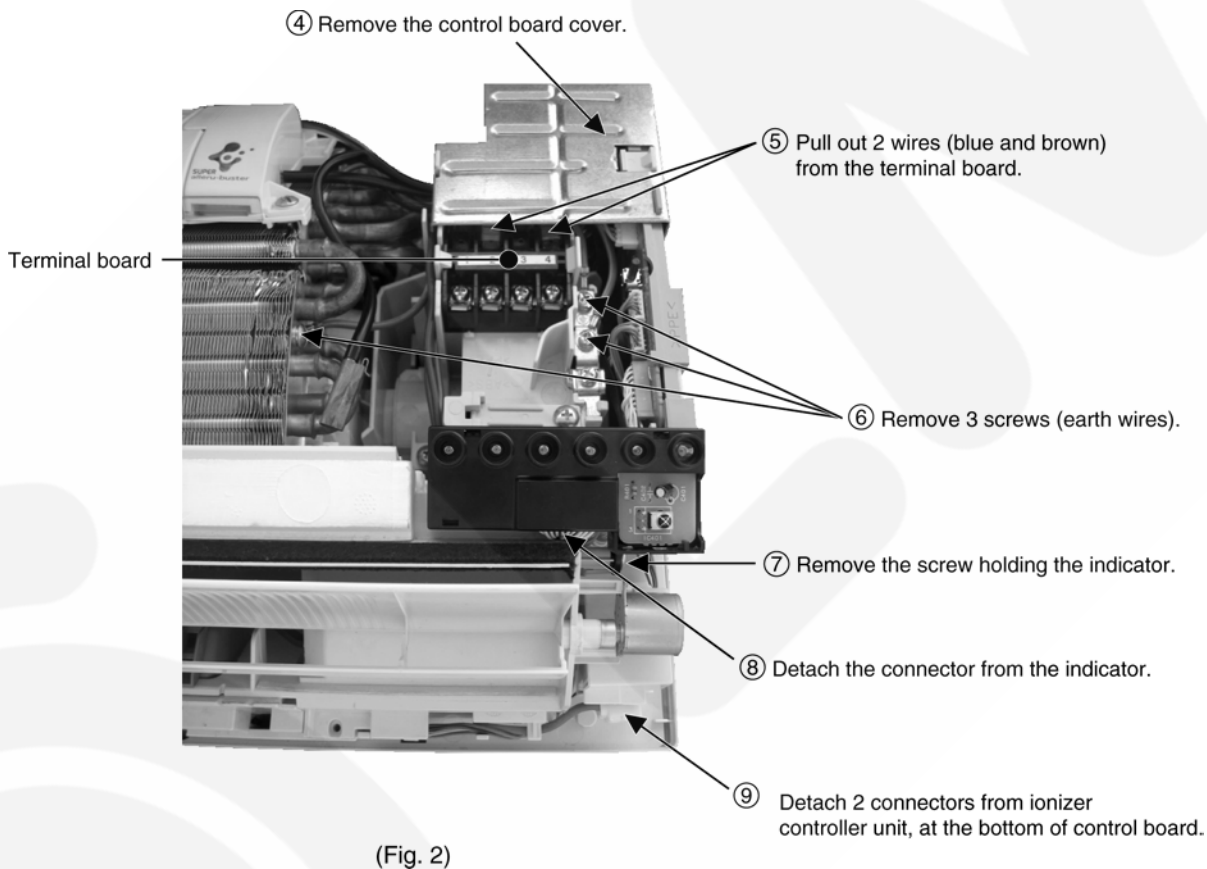
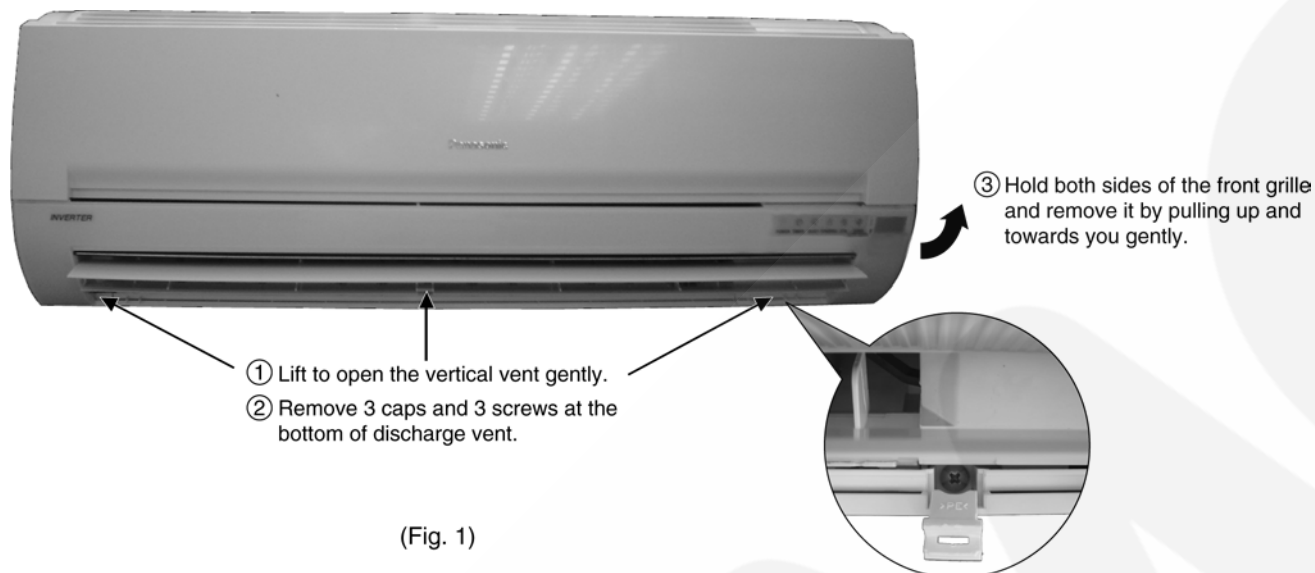

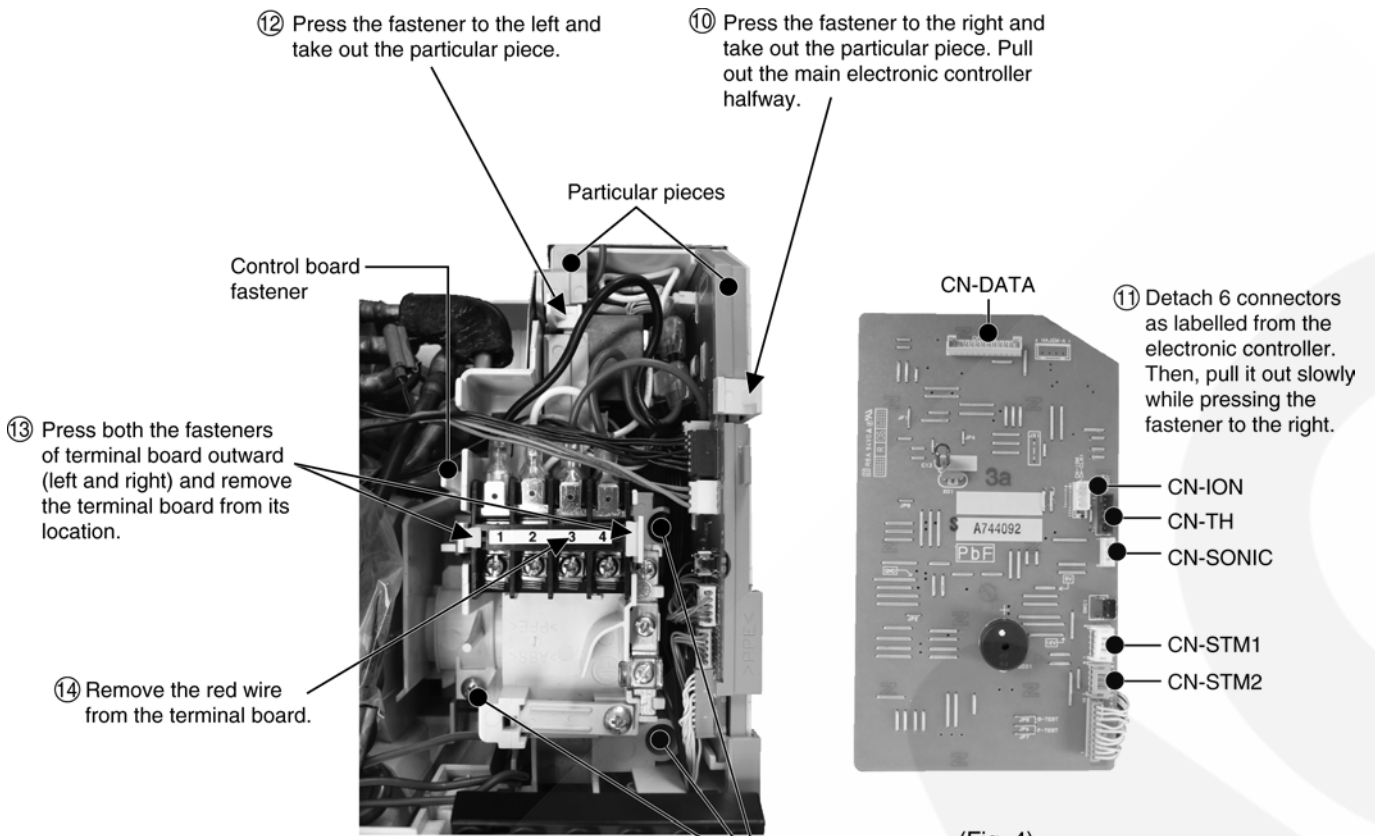

(Fig. 3)

(Fig. 4)

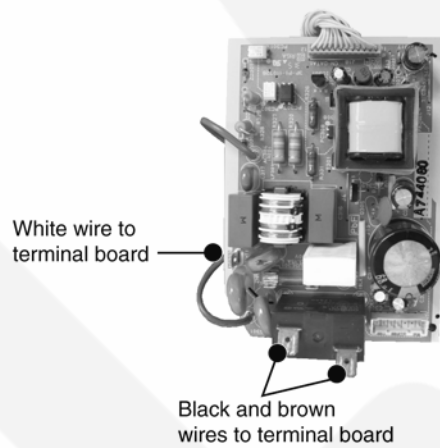

- ⑮ Detach 3 wires and one connector as labelled from the electronic controller. Then, pull it out slowly while pressing the fastener to the left.

(Fig. 5)

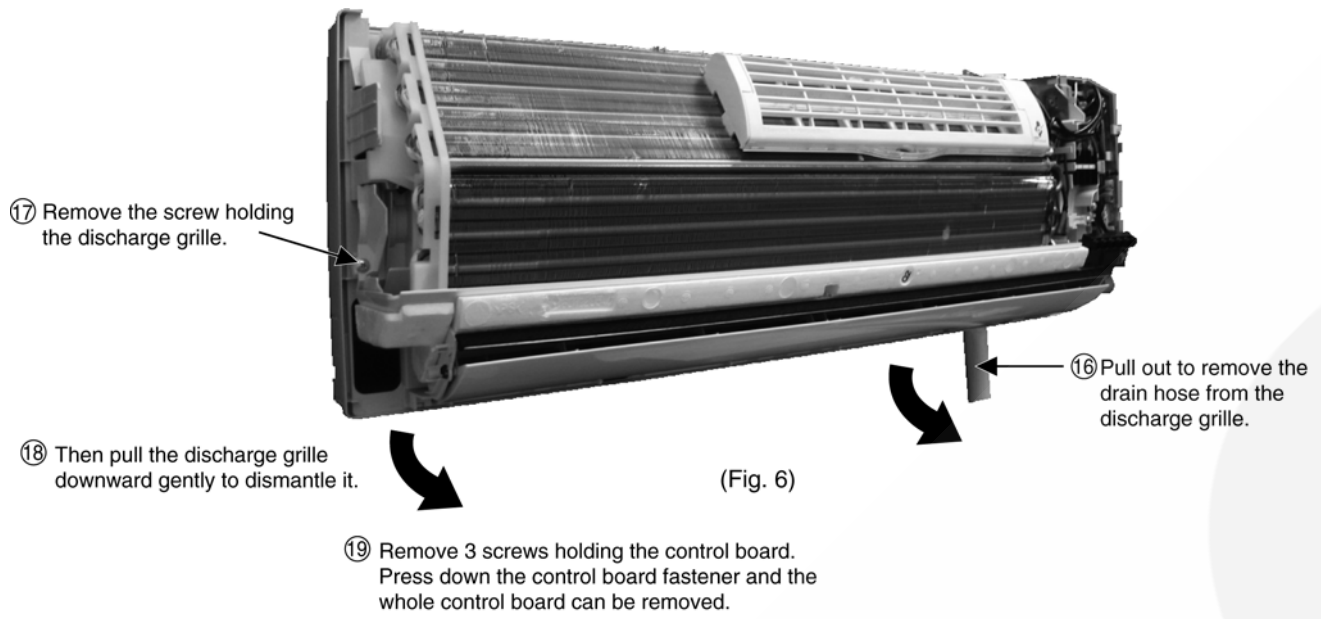

15.2. Indoor Cross Flow Fan and Fan Motor

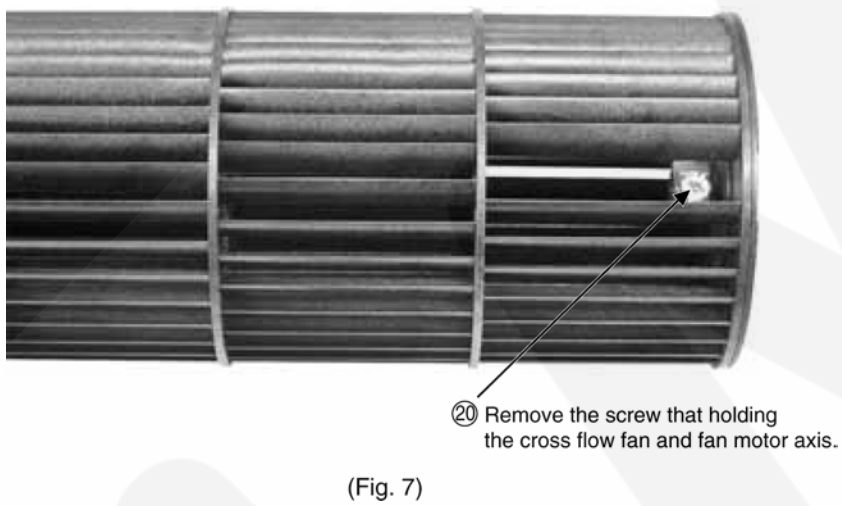

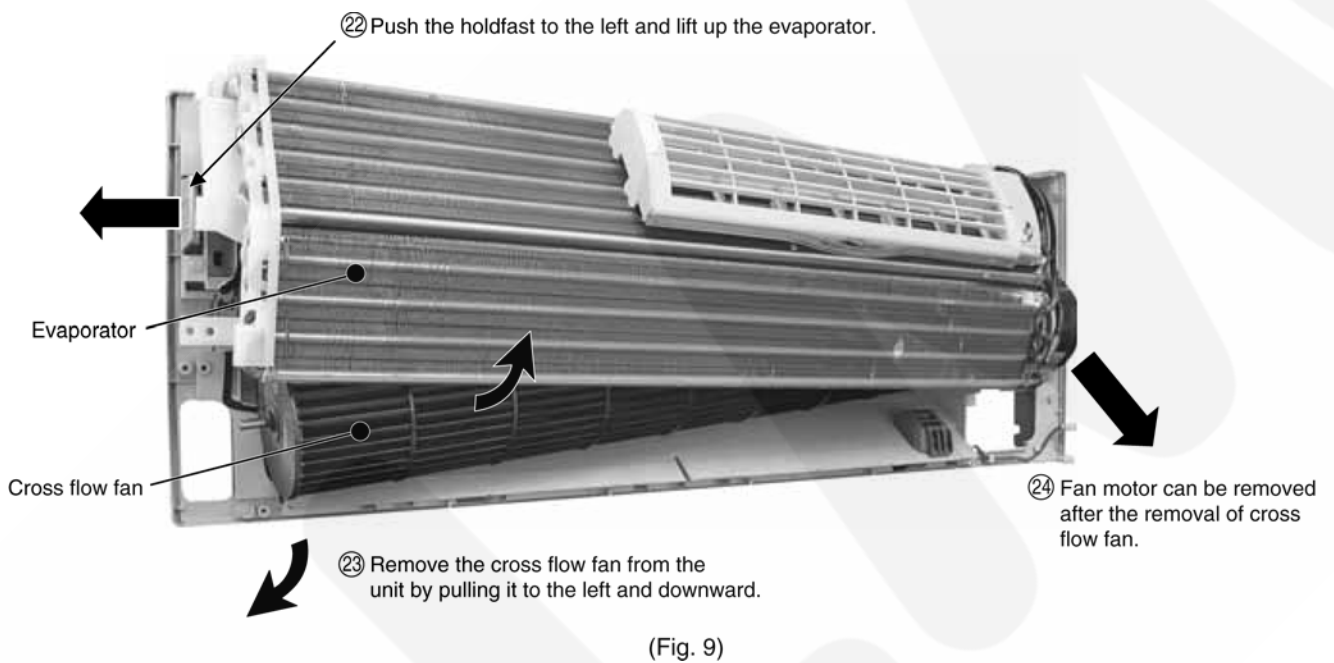

16 Technical Data

16.1. Operation Characteristics

16.1.1. CS-E24EKES CU-E24EKE

Cooling Characteristic at Different Outdoor Air Temperature

Condition

Indoor room temperature: 27/19 °C

Remote control setting: HI fan, COOL 16 °C

Compressor frequency: Rated cooling

Voltage: 230 V

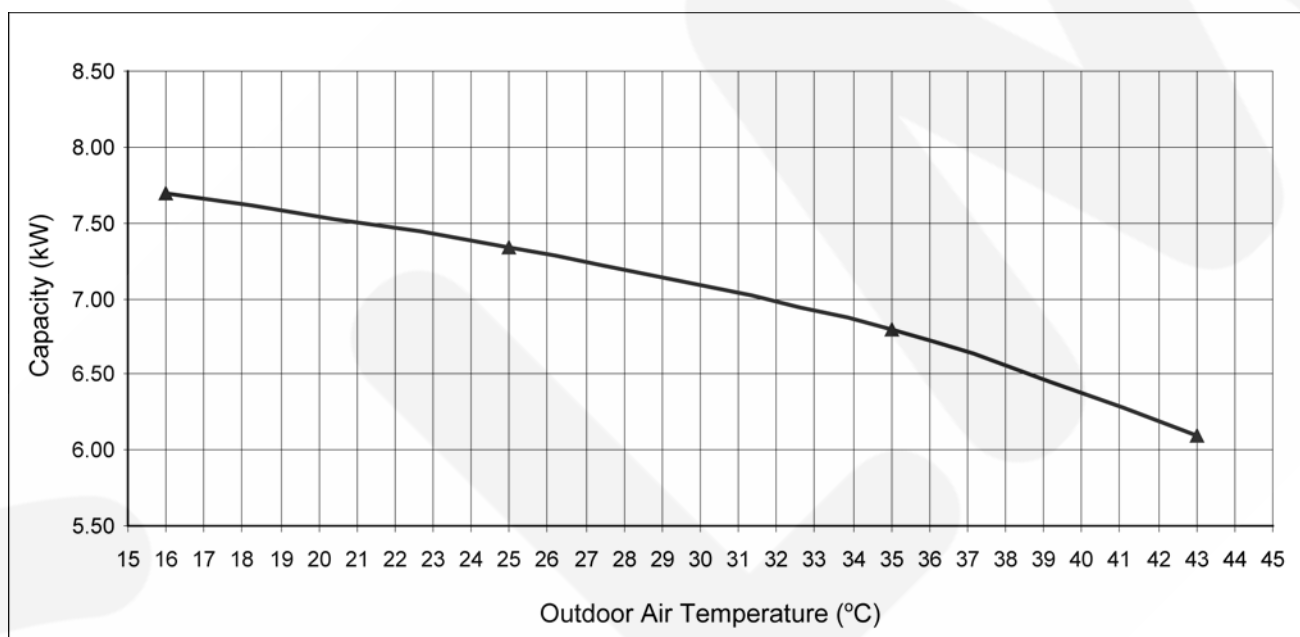
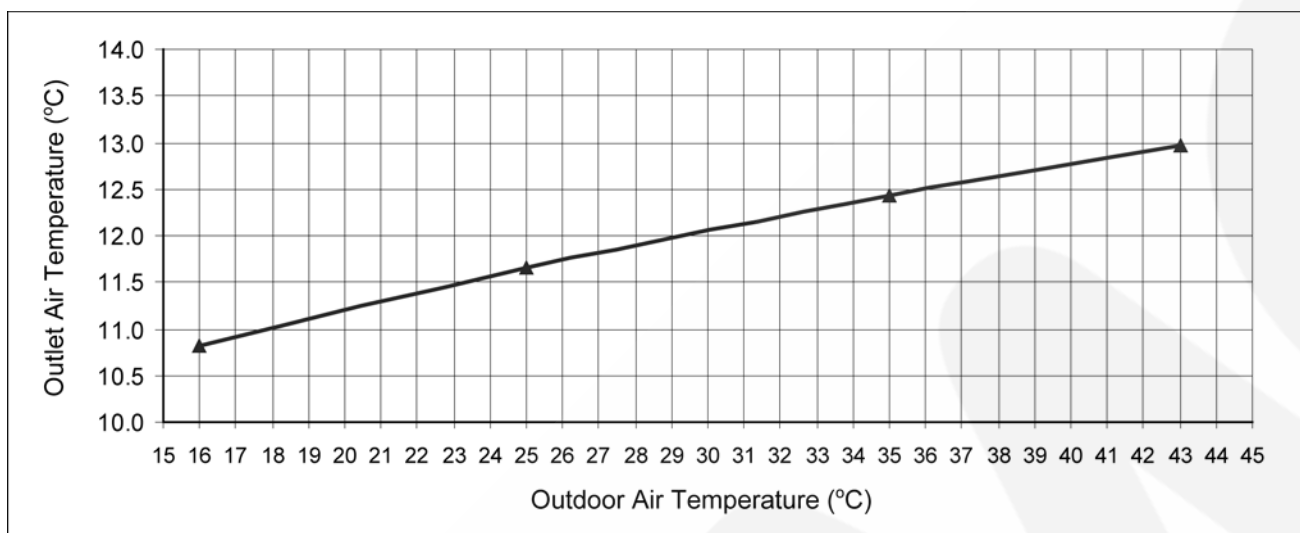

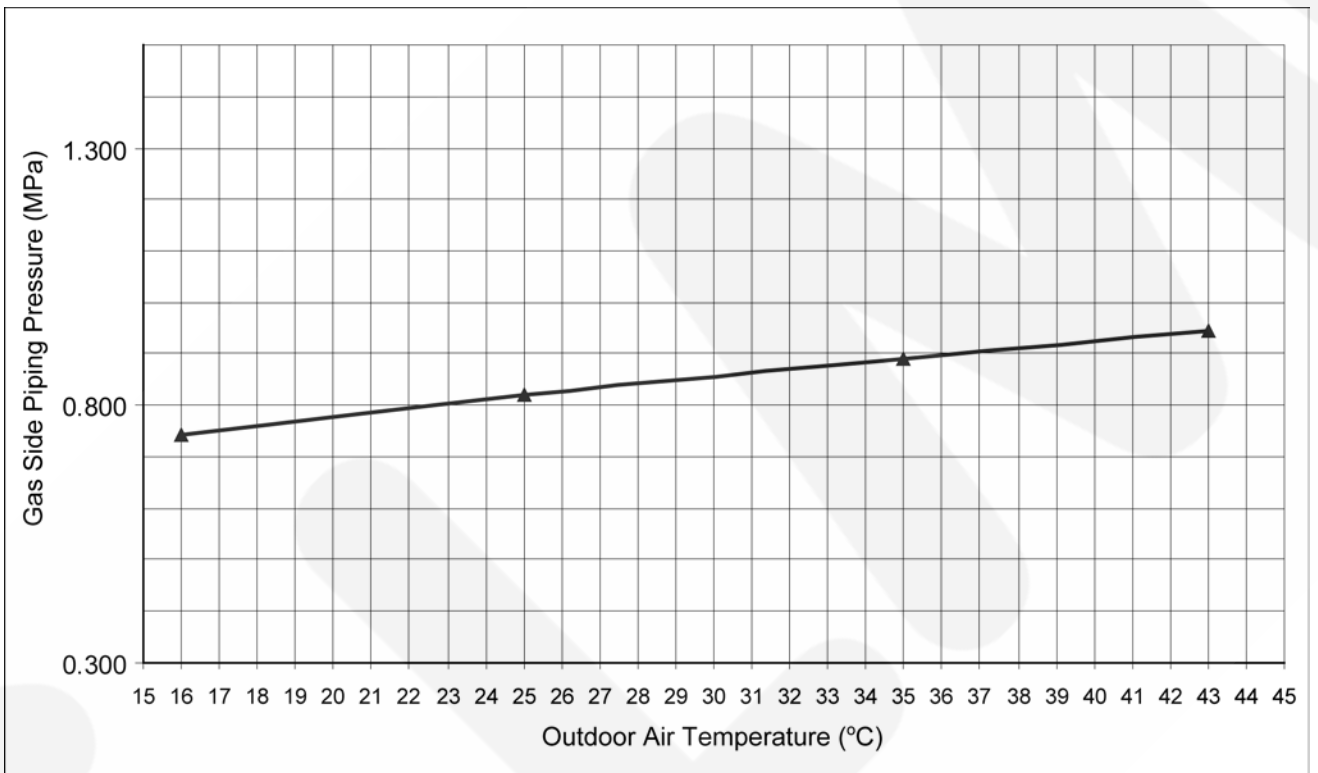
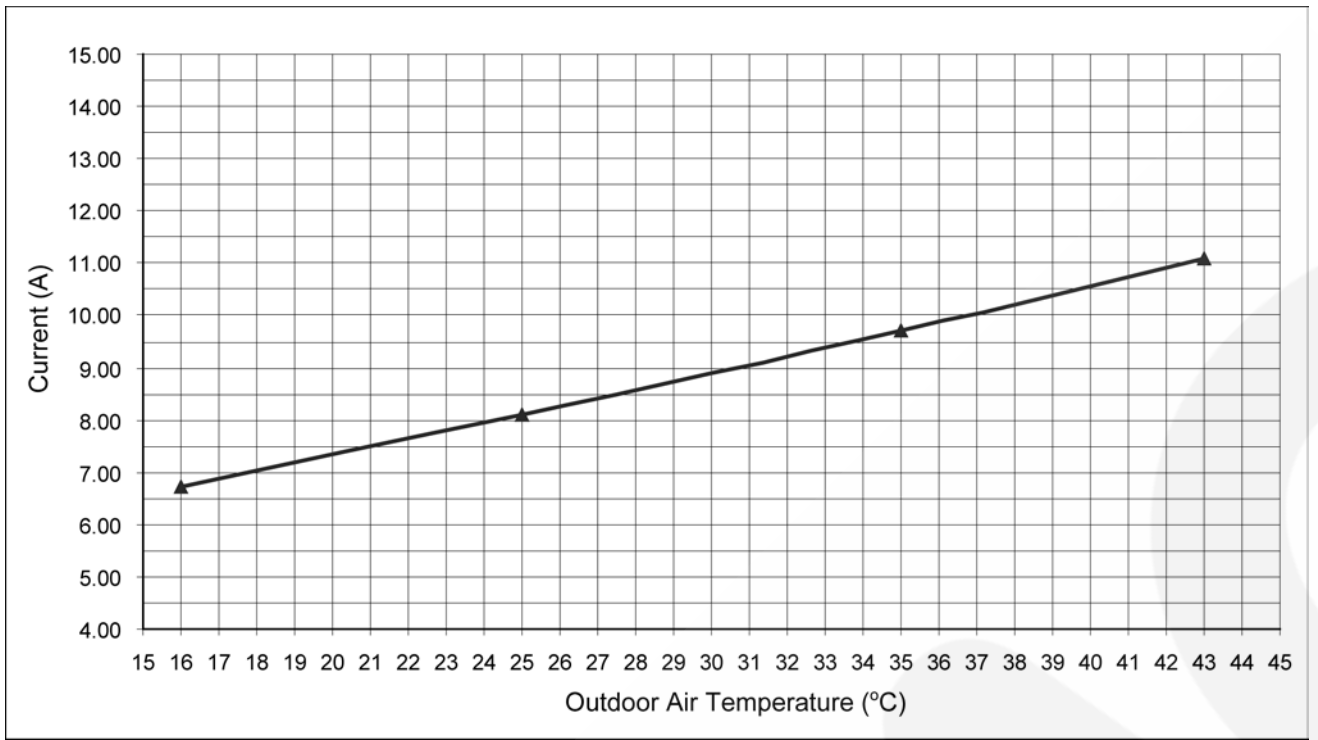

Heating Characteristic at Different Outdoor Air Temperature

Condition

Indoor room temperature : 20°C

Remote control setting : Hi Fan, HEAT 30°C

Compressor frequency : Rated heating

Voltage : 230 V

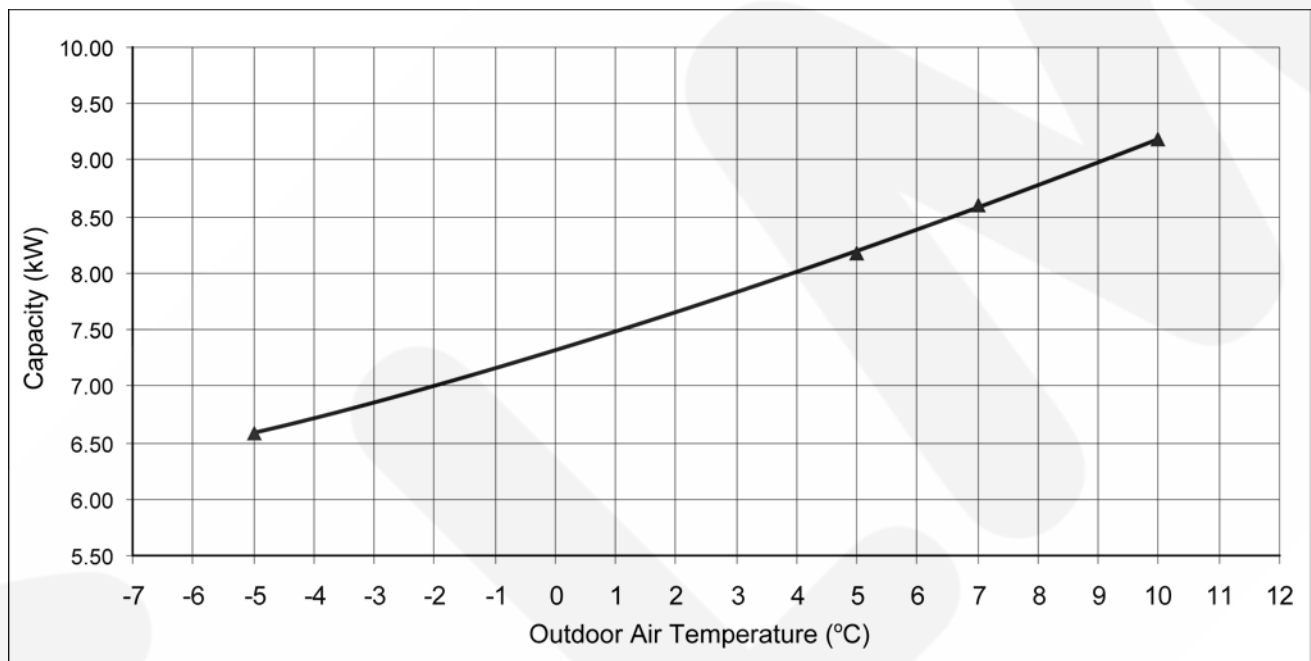
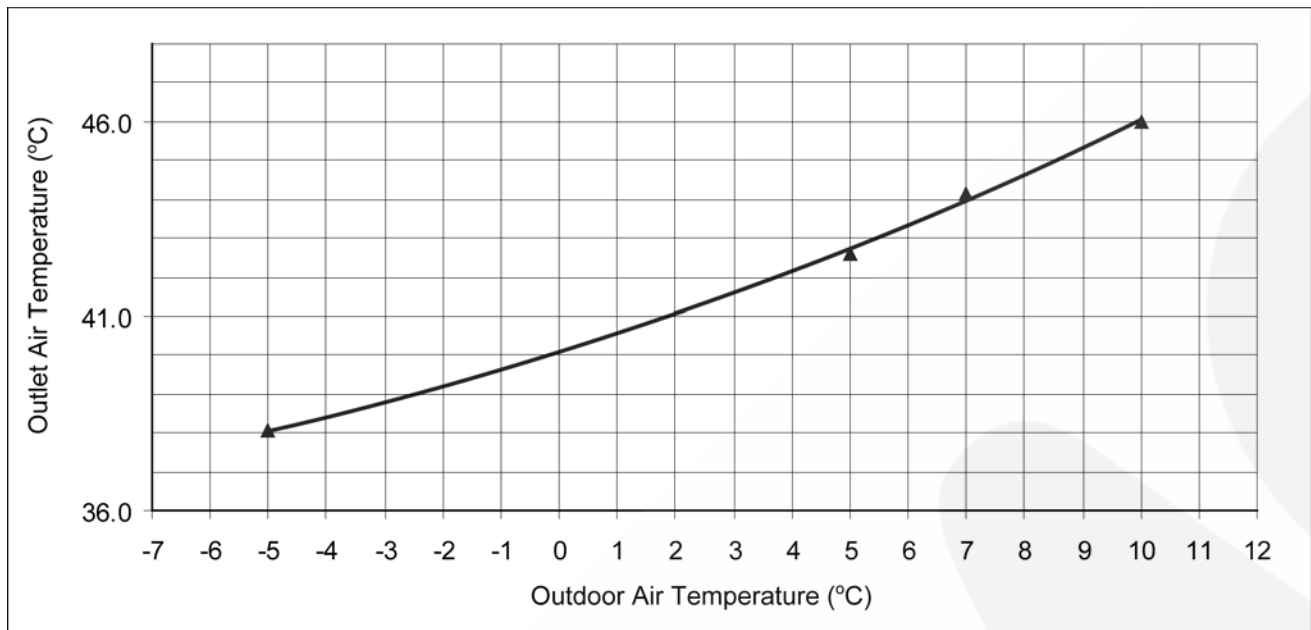

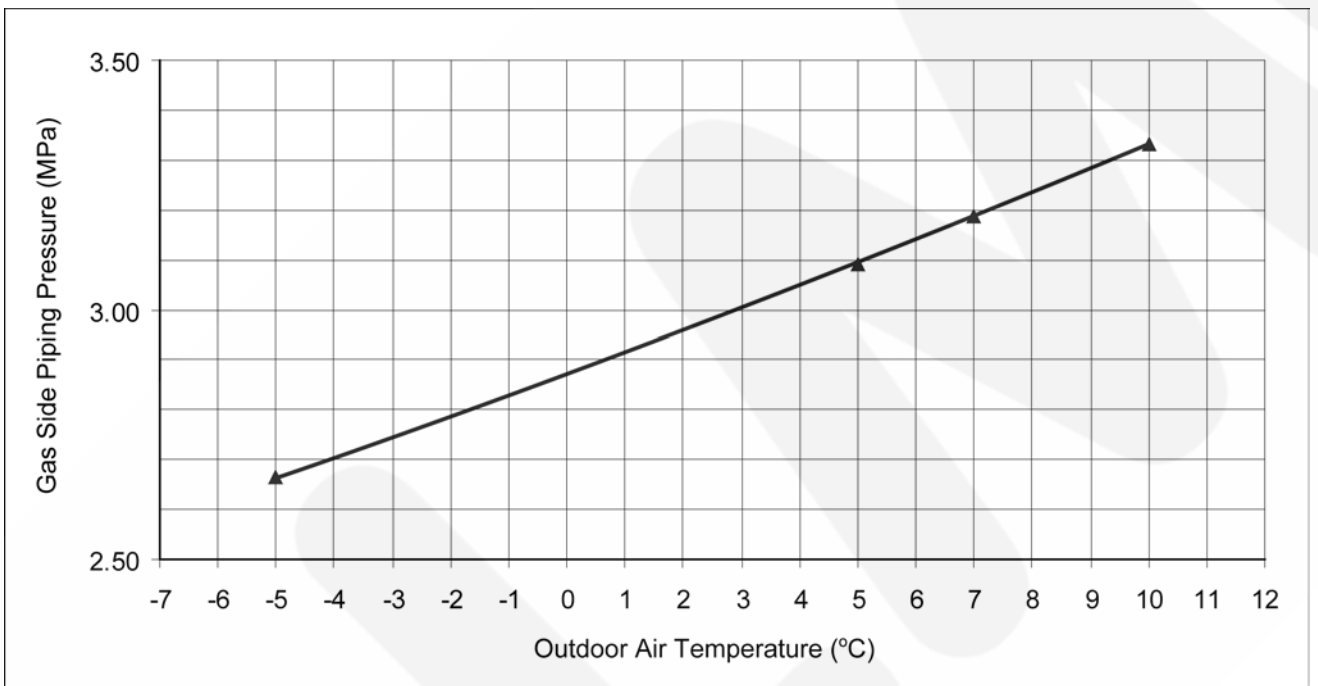
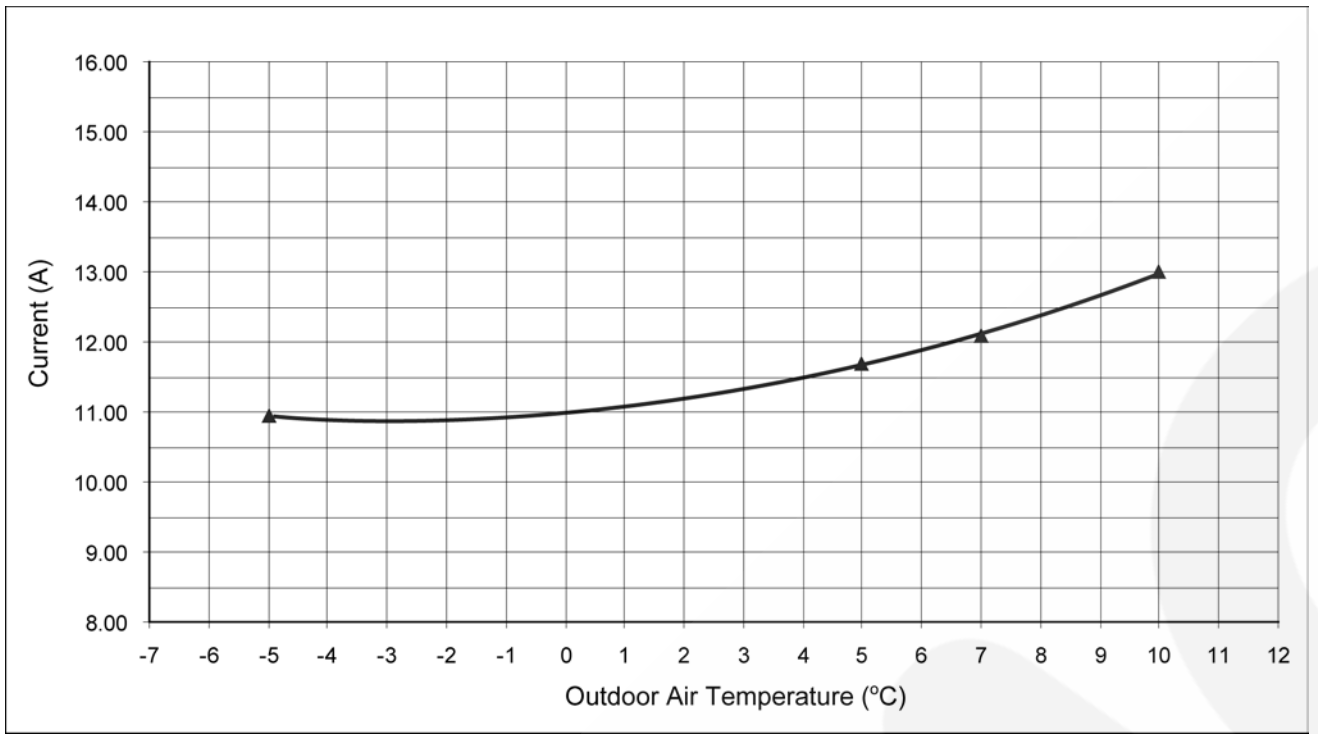

Cooling Characteristic at Different Piping Length

Condition

Indoor room temperature : 27/19°C

Remote control setting : Hi Fan, COOL 16°C

Compressor frequency : Rated cooling

Voltage : 230 V

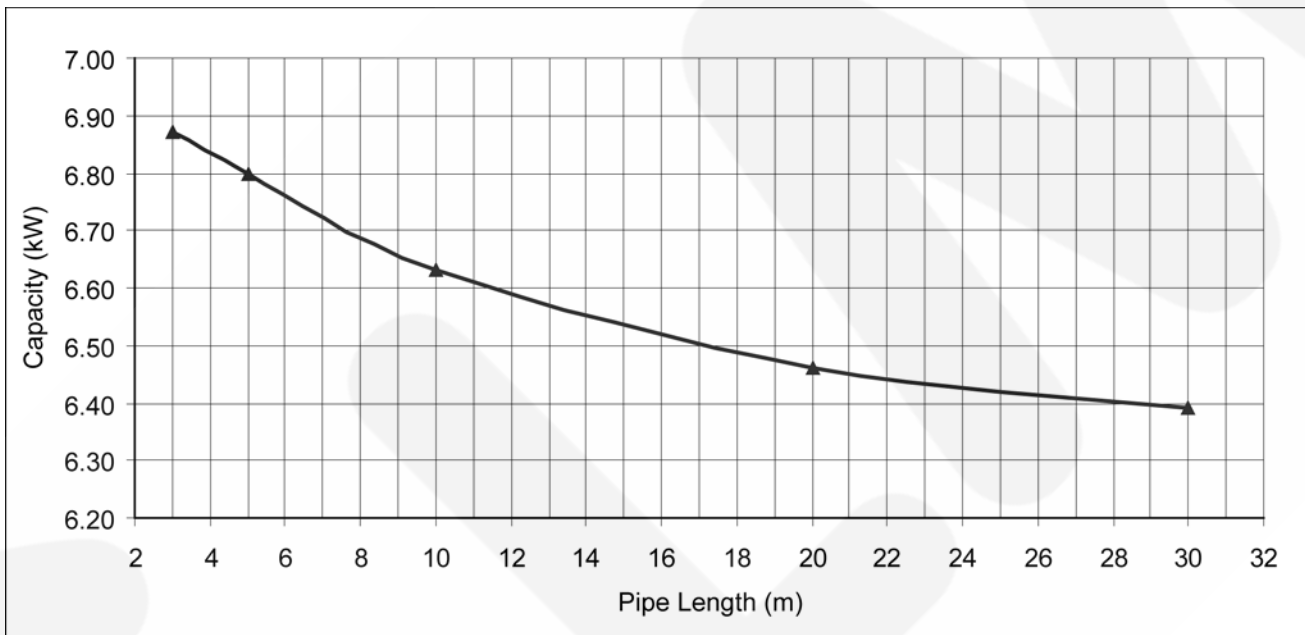

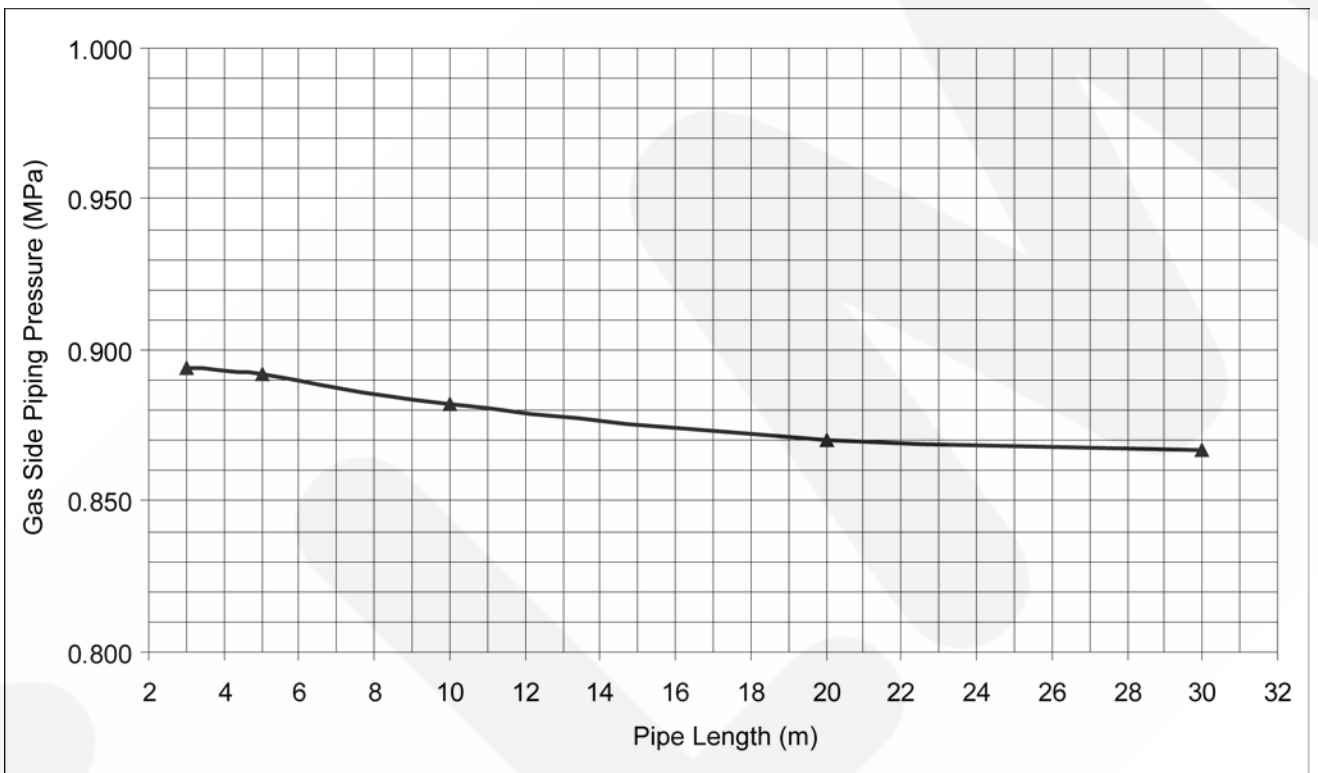
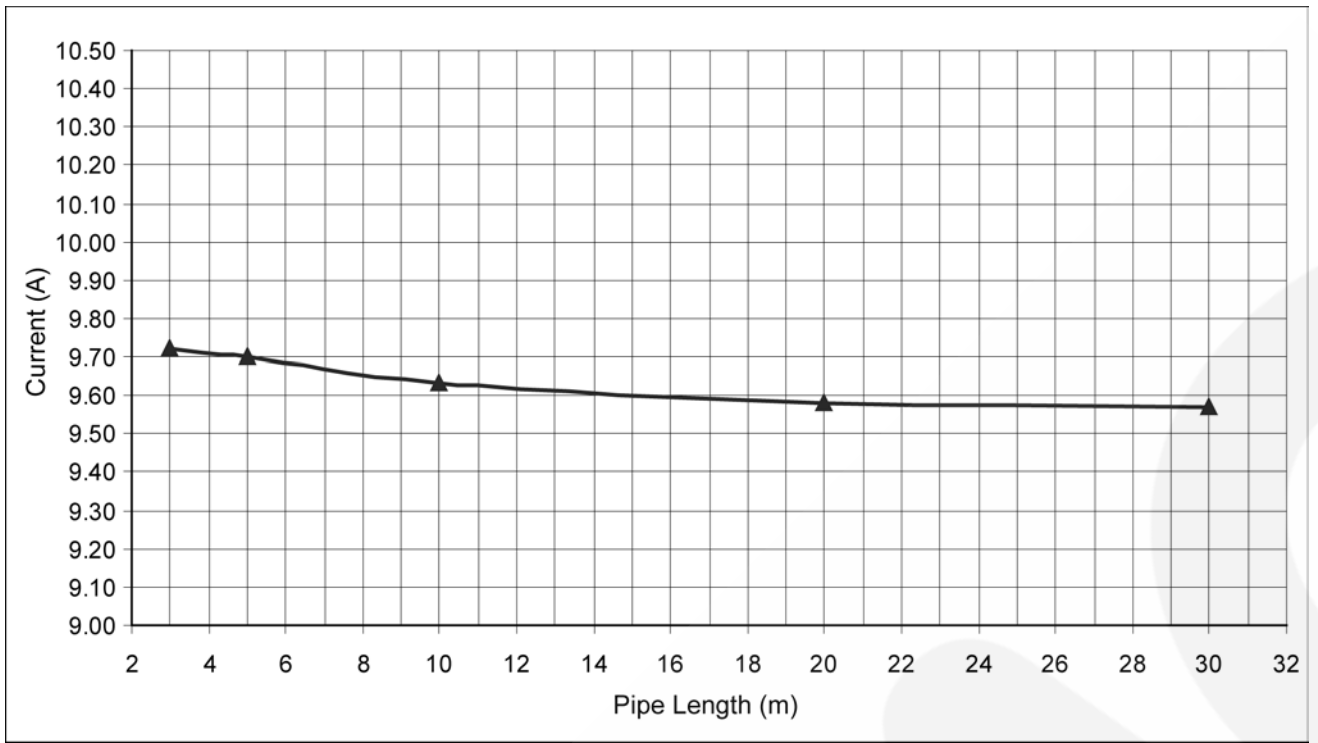

Heating Characteristic at Different Piping Length

Condition

Indoor room temperature: 20 °C

Remote control setting: HI fan, HEAT 30 °C

Compressor frequency: Rated heating

Voltage: 230 V

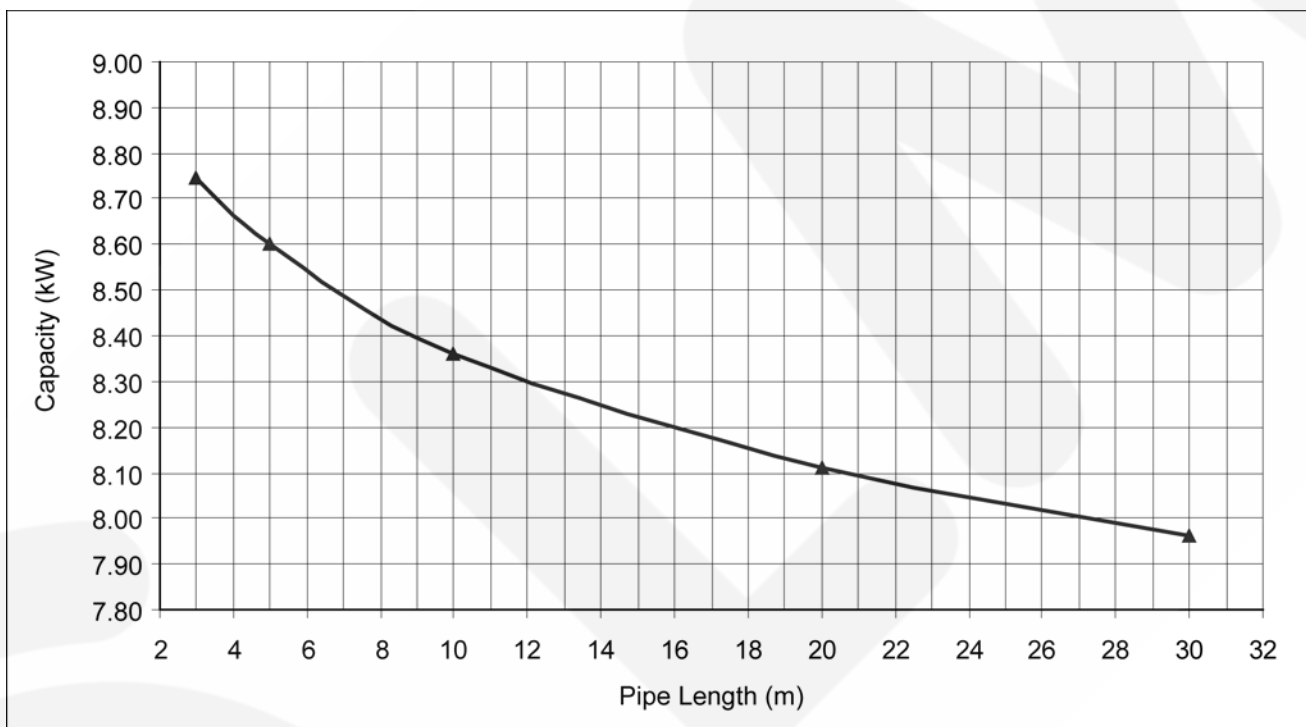
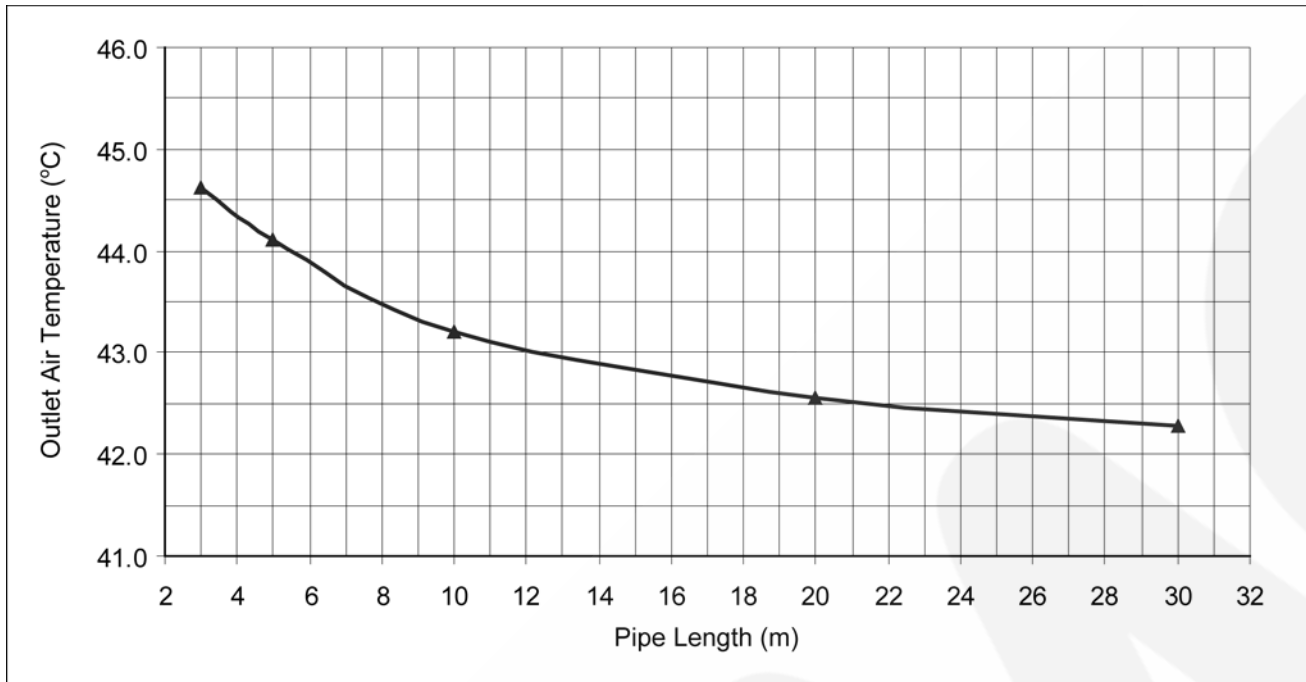

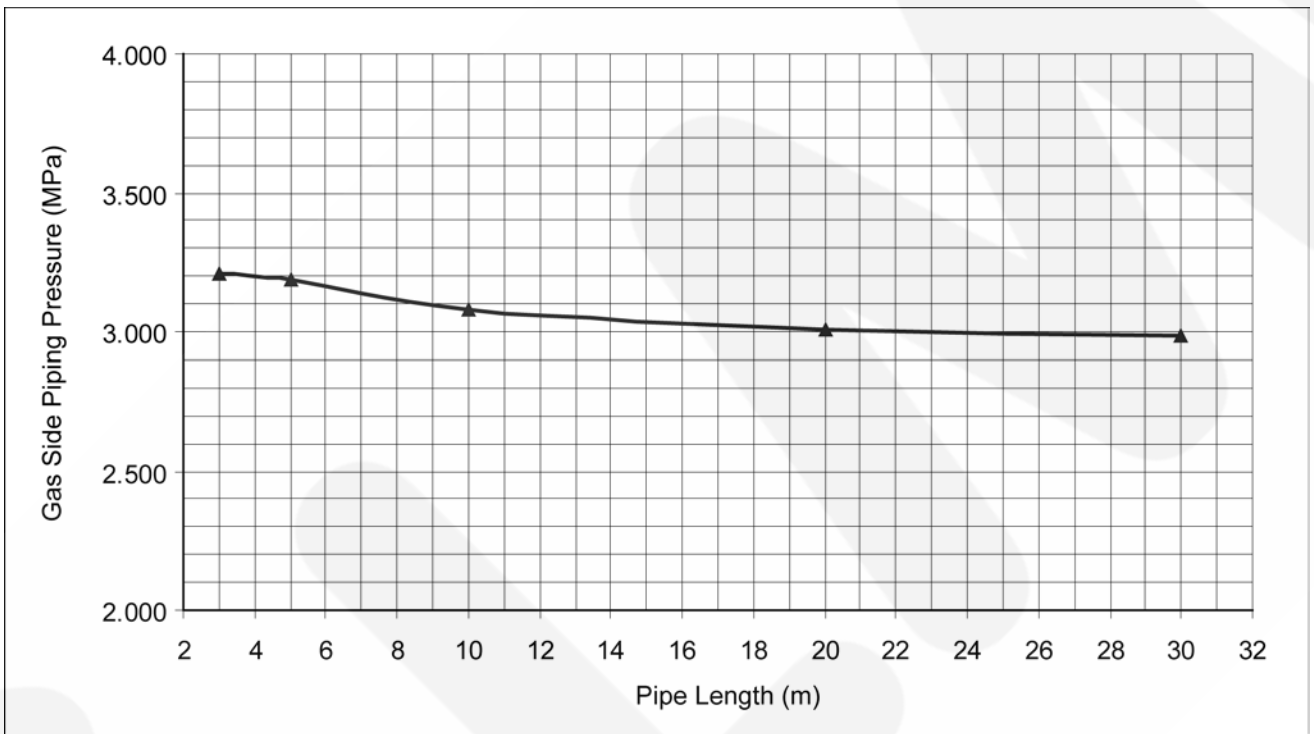
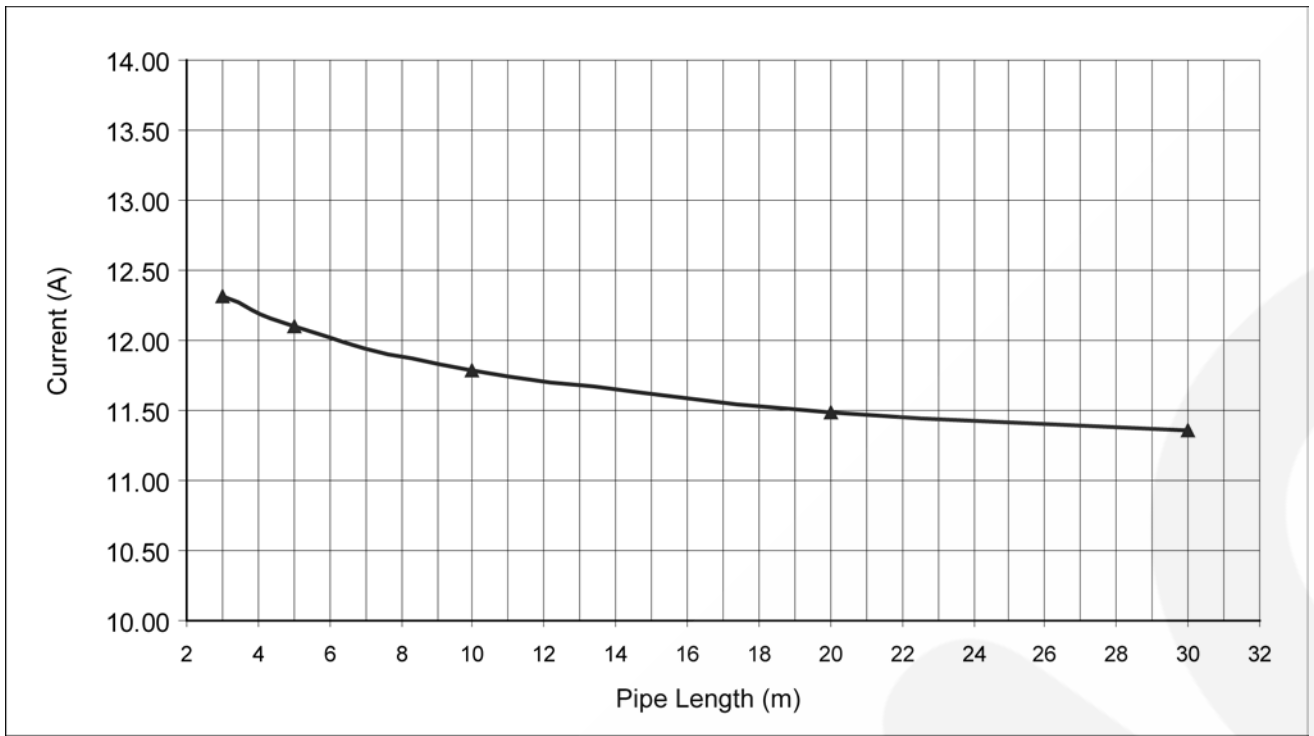

16.1.2. CS-E28EKE CU-E28EKE

Cooling Characteristic at Different Outdoor Air Temperature

Condition

Indoor room temperature: 27/19 °C

Remote control setting: HI fan, COOL 16 °C

Compressor frequency: Rated cooling

Voltage: 230 V

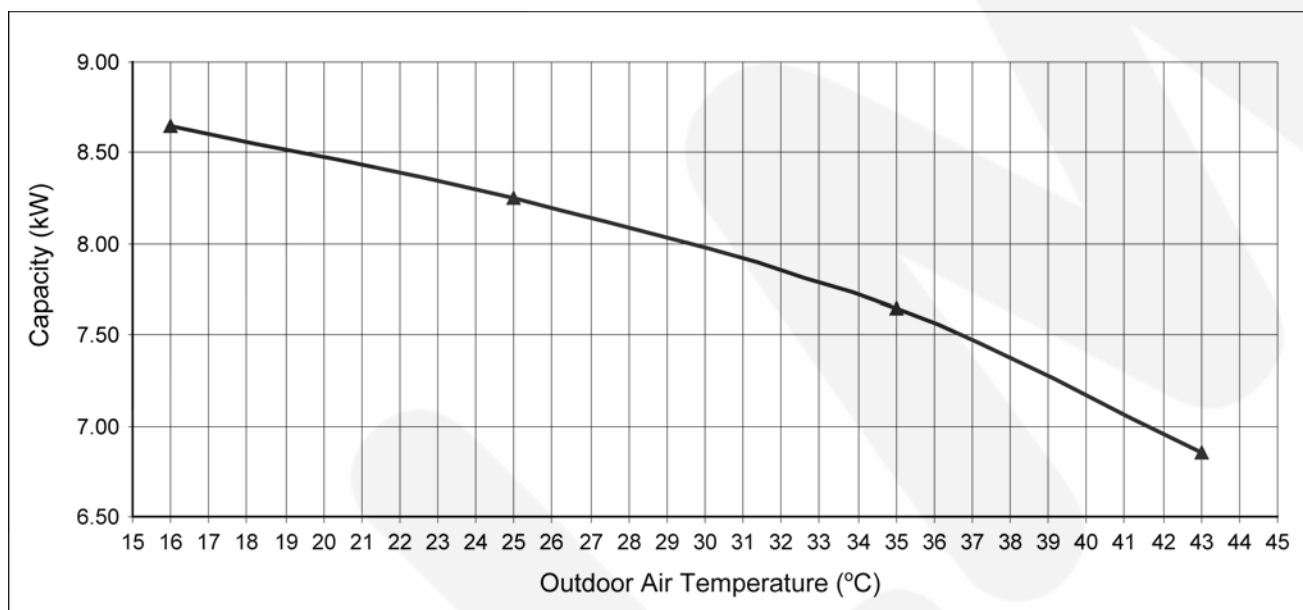
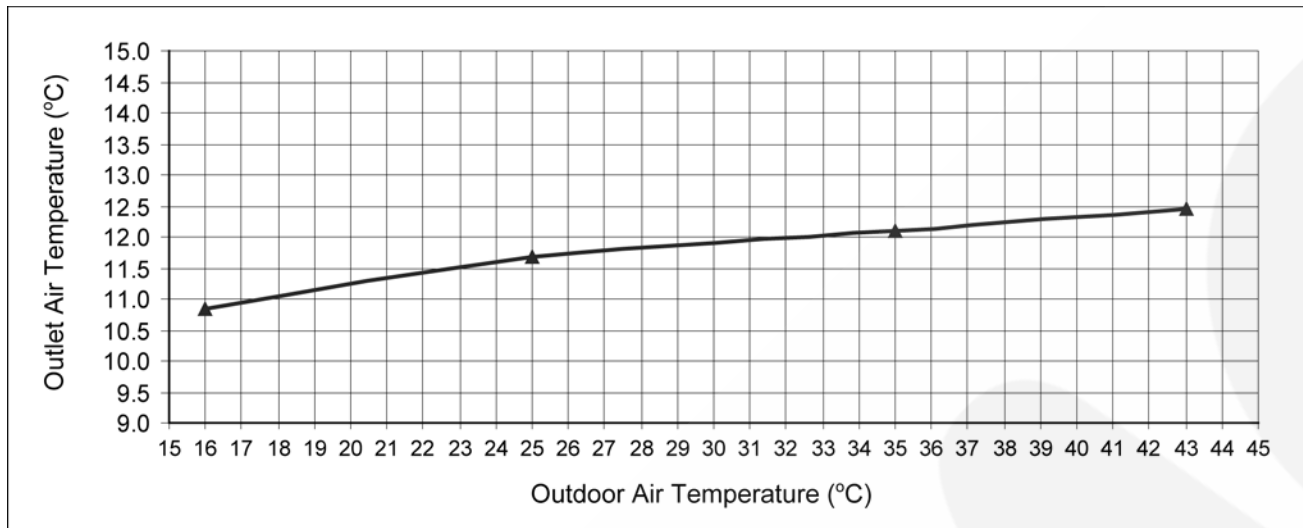

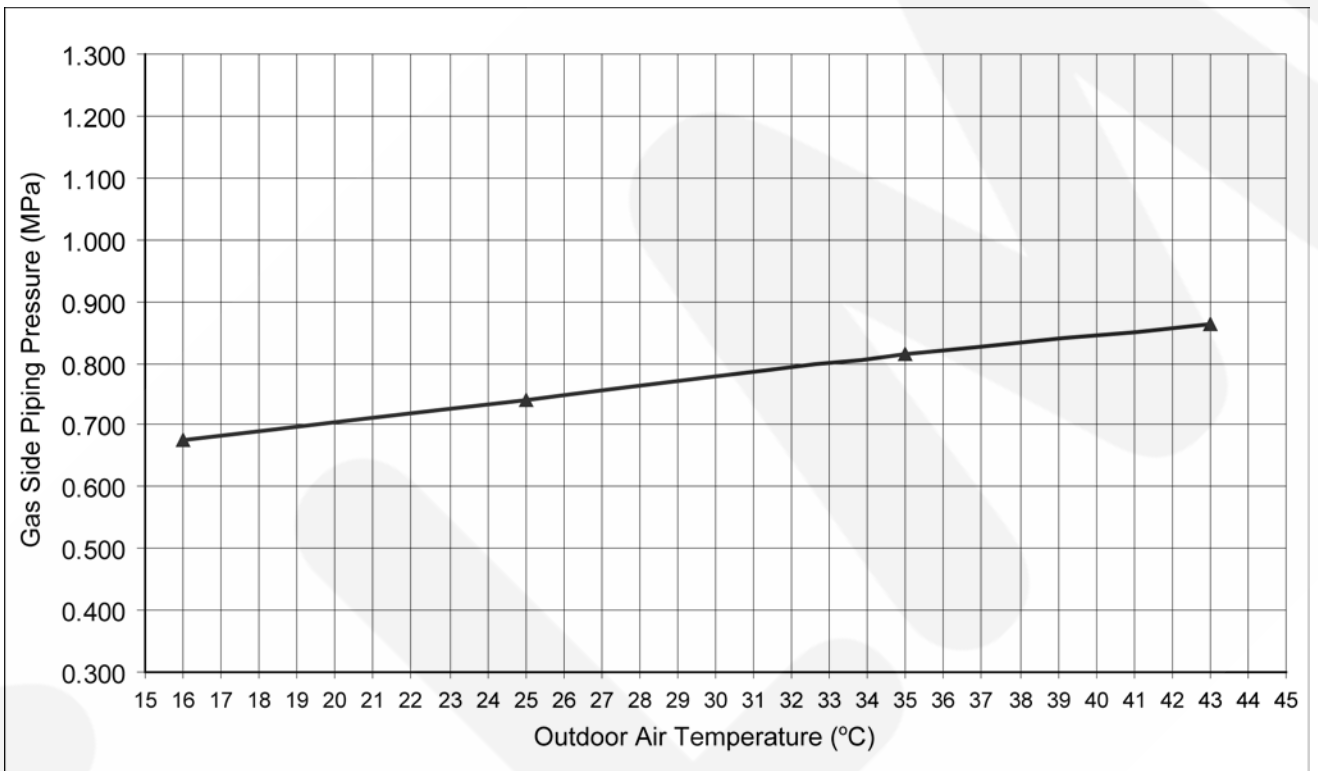
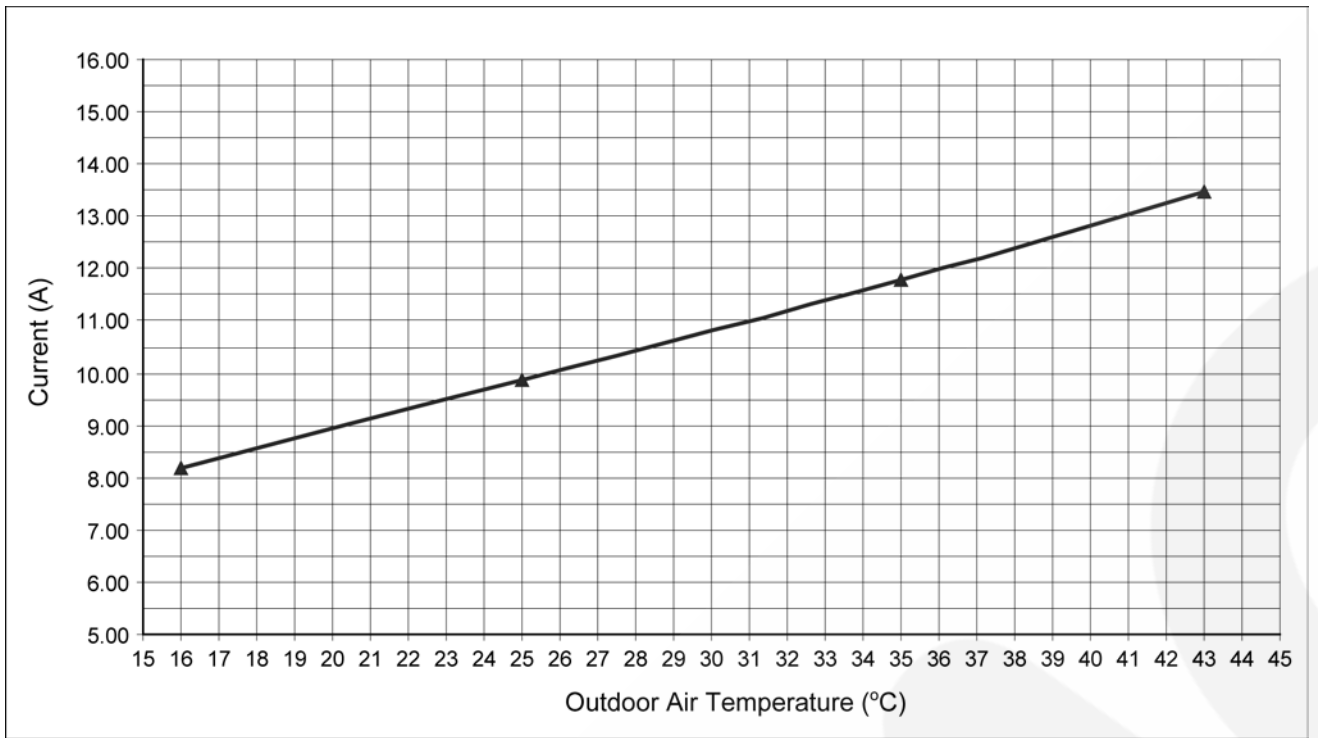

Heating Characteristic at Different Outdoor Air Temperature

Condition

Indoor room temperature : 20°C

Remote control setting : Hi Fan, HEAT 30°C

Compressor frequency : Rated heating

Voltage : 230 V

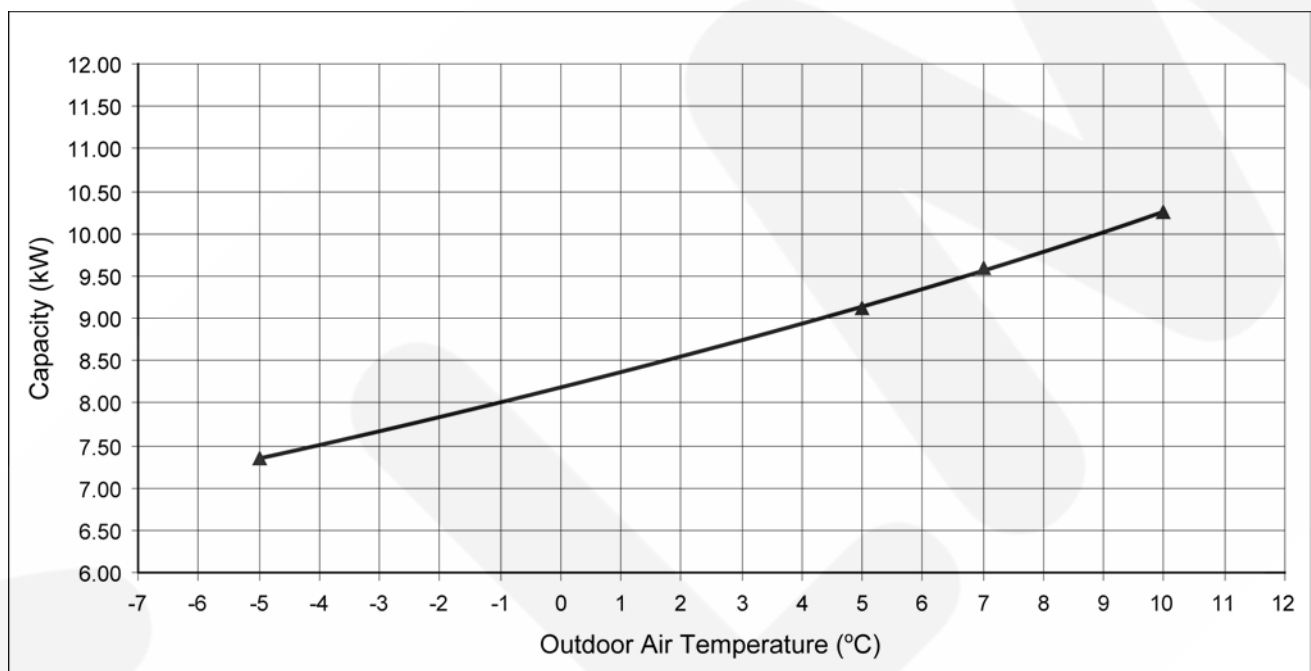
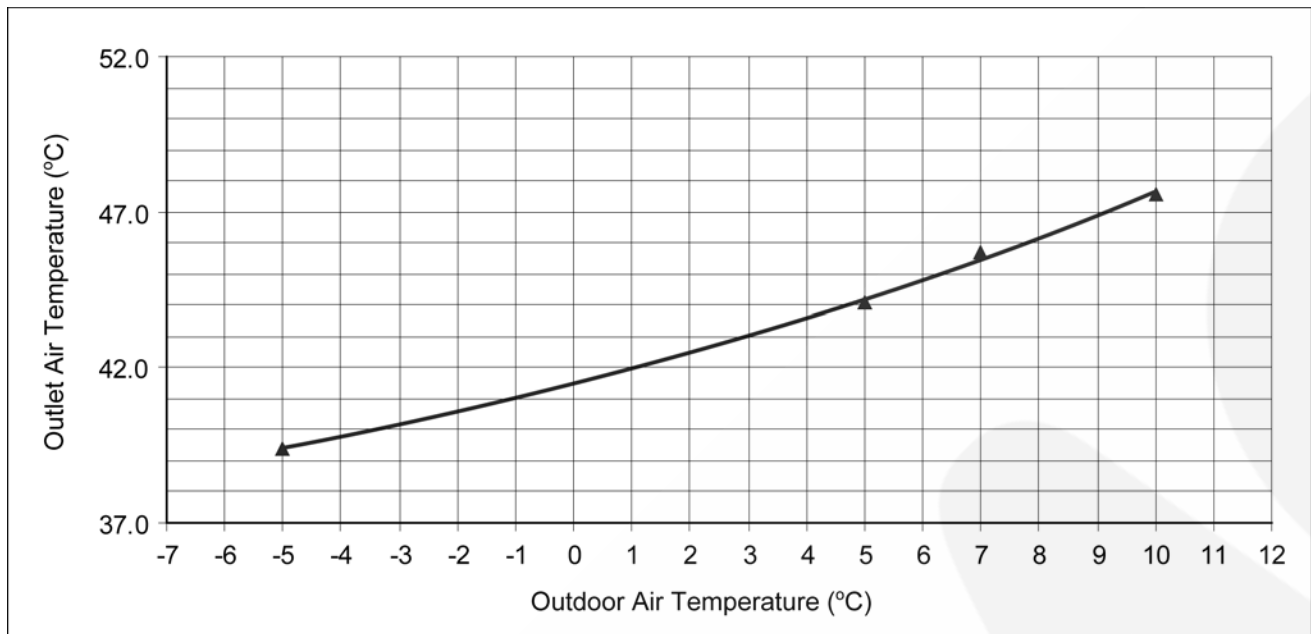

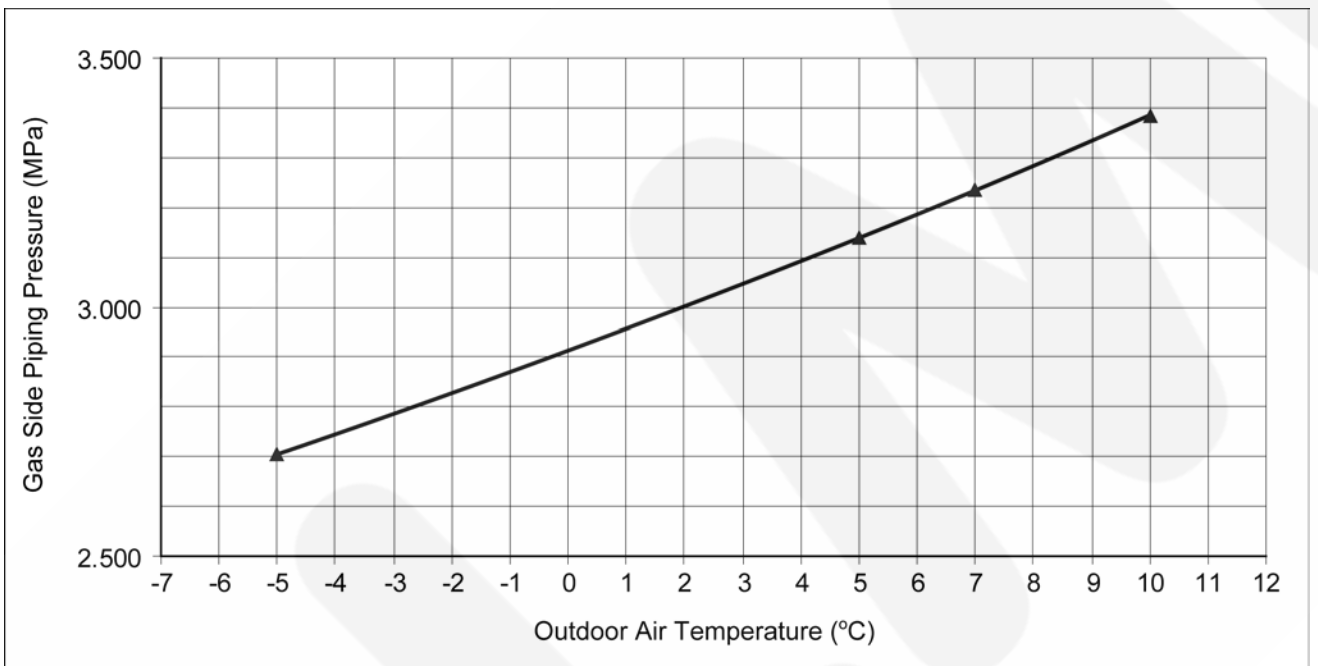
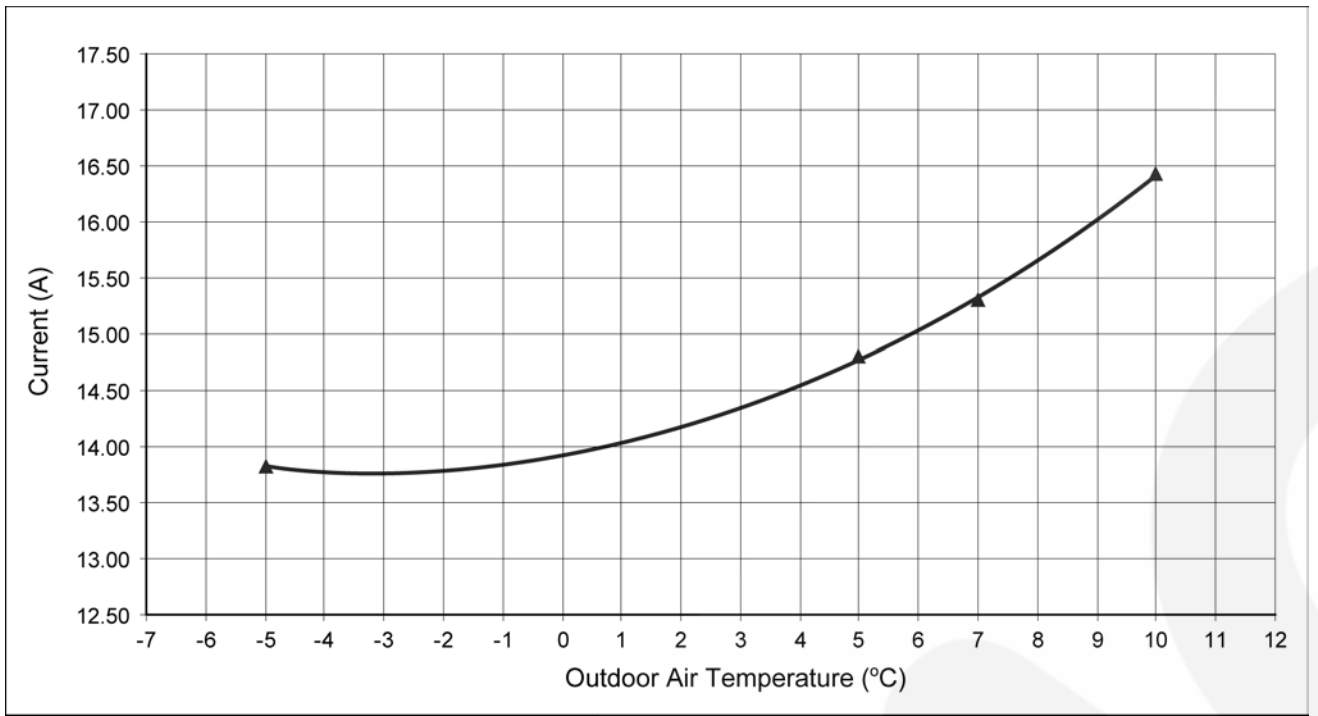

Cooling Characteristic at Different Piping Length

Condition

Indoor room temperature : 27/19°C

Remote control setting : Hi Fan, COOL 16°C

Compressor frequency : Rated cooling

Voltage : 230 V

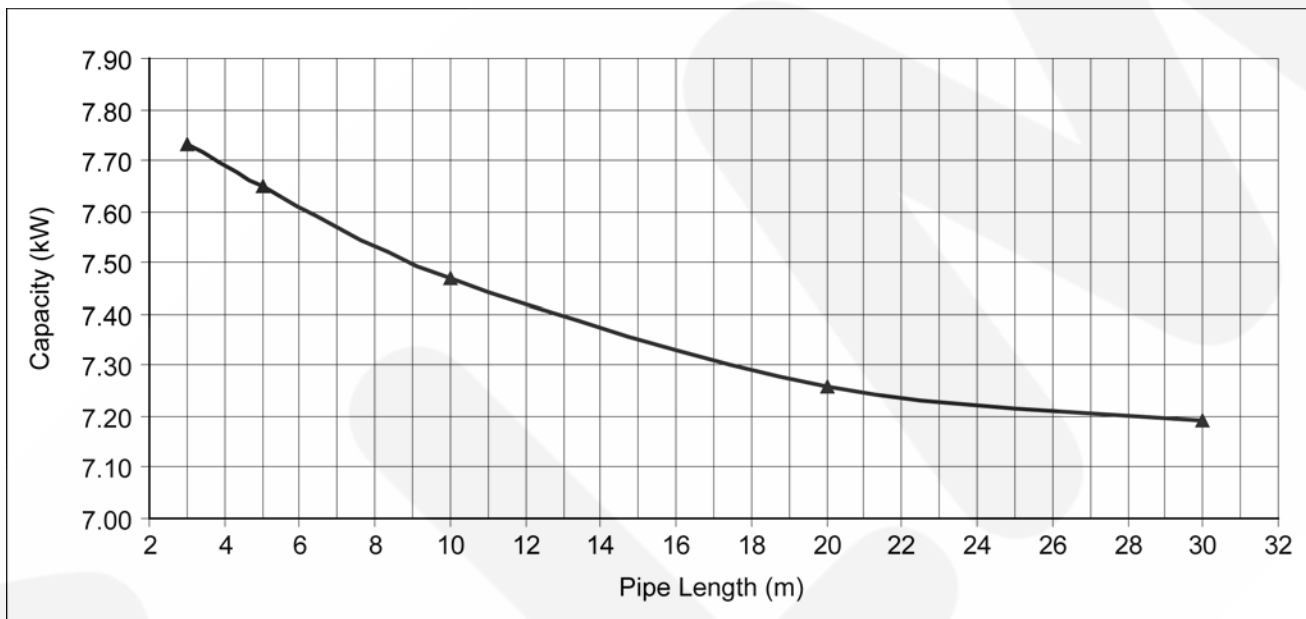
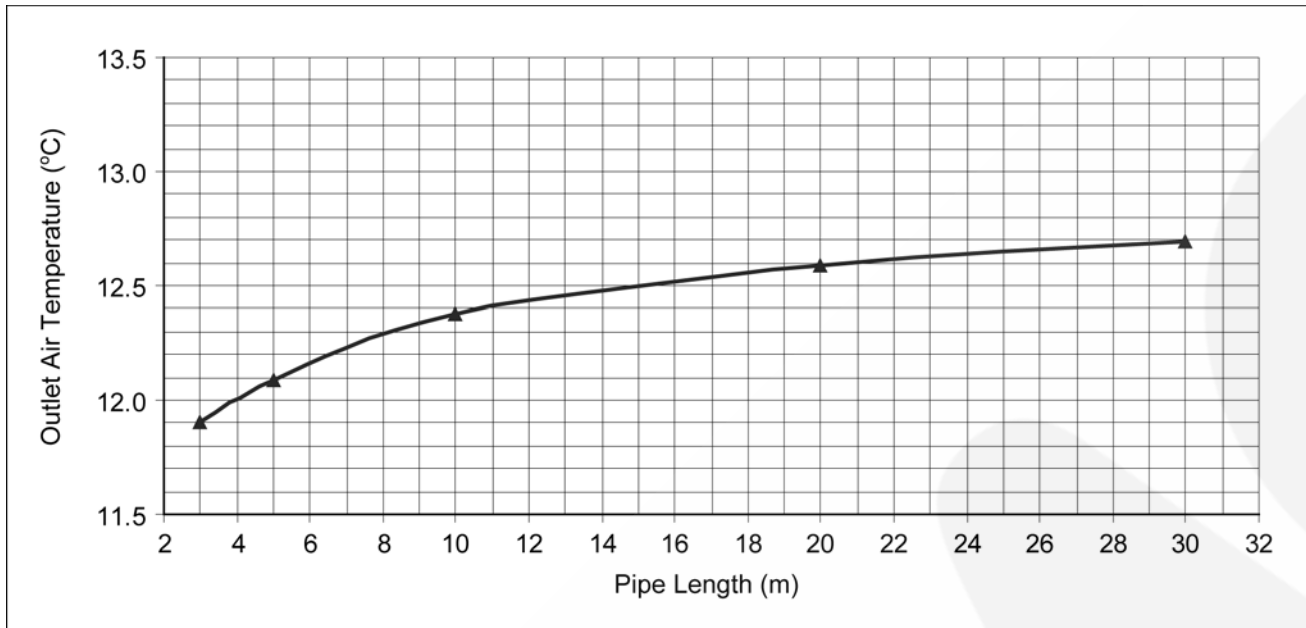

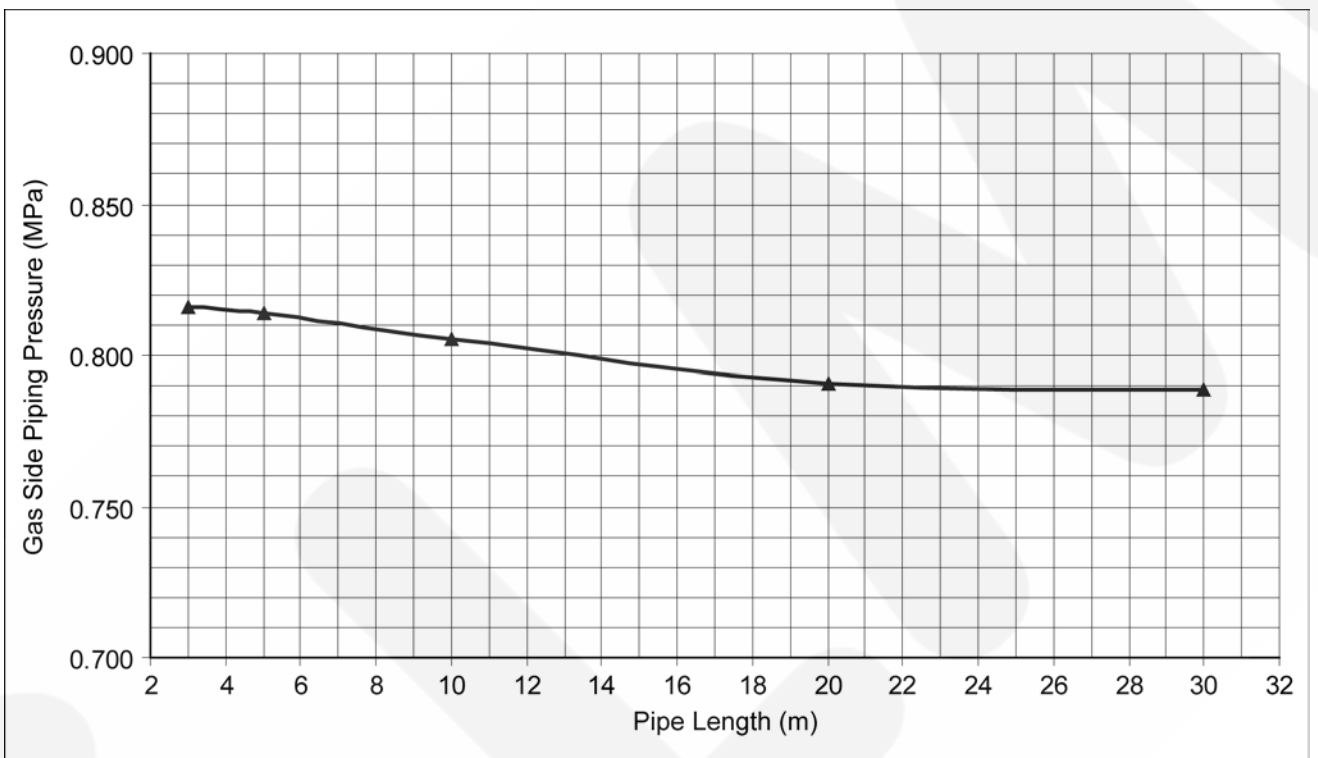
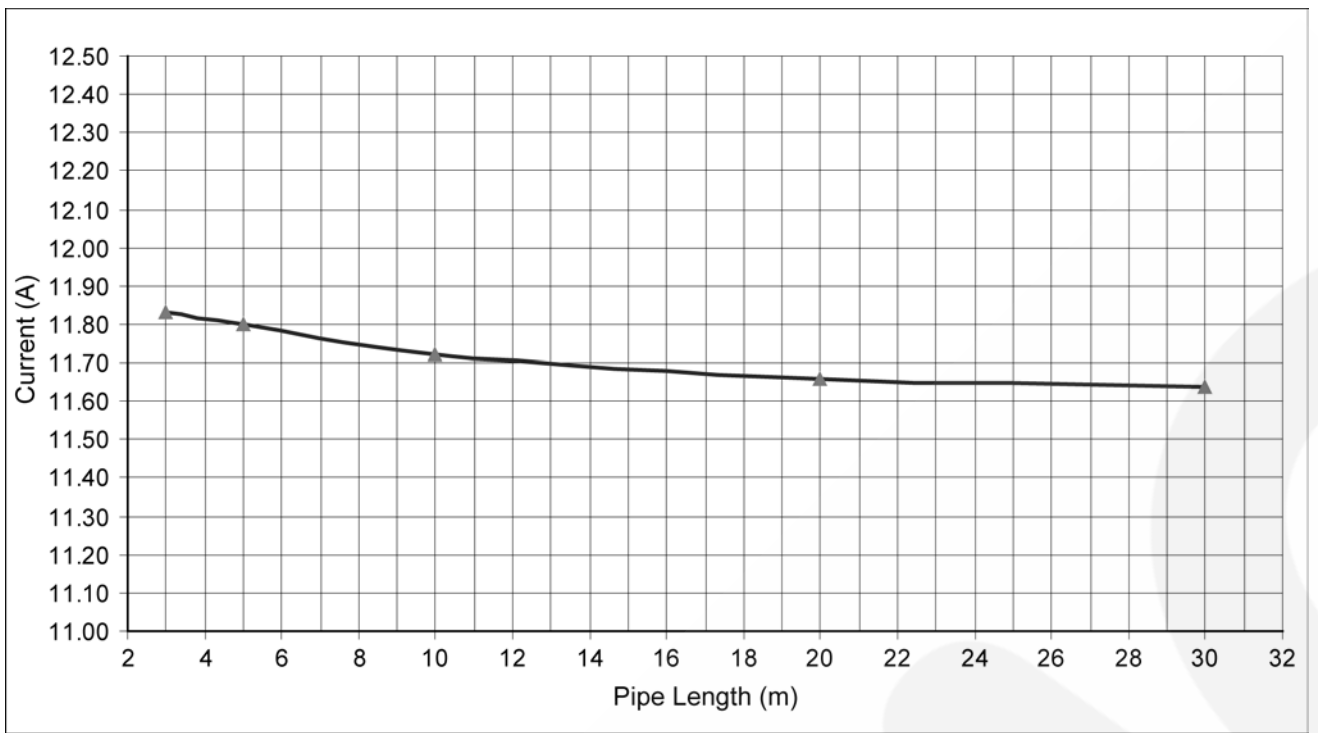

Heating Characteristic at Different Piping Length

Condition

Indoor room temperature: 20 °C

Remote control setting: HI fan, HEAT 30 °C

Compressor frequency: Rated heating

Voltage: 230 V

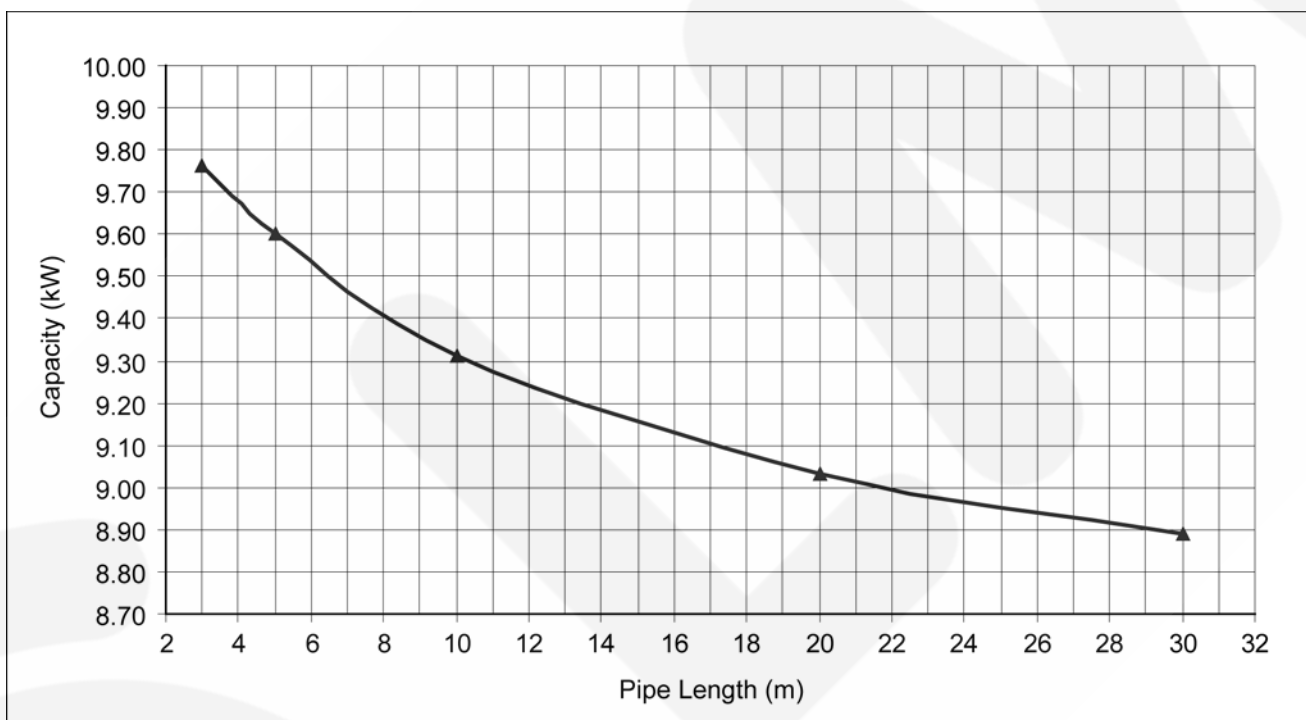
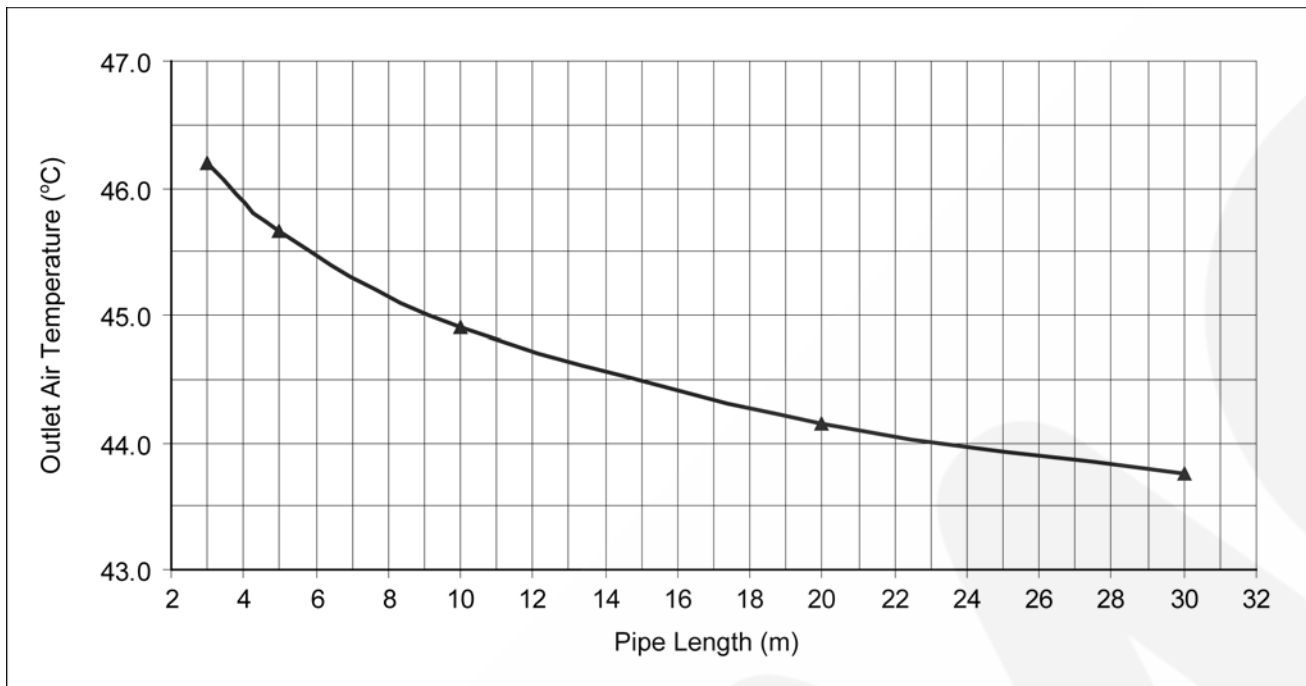

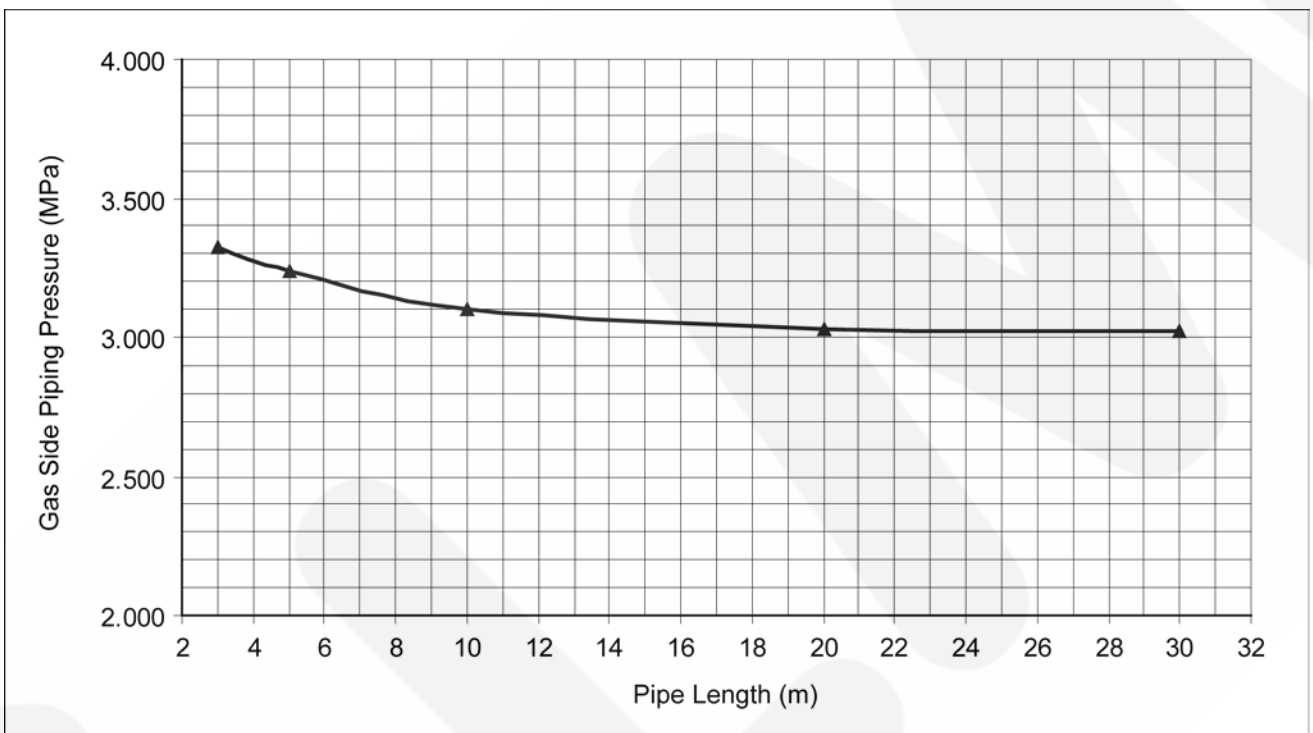
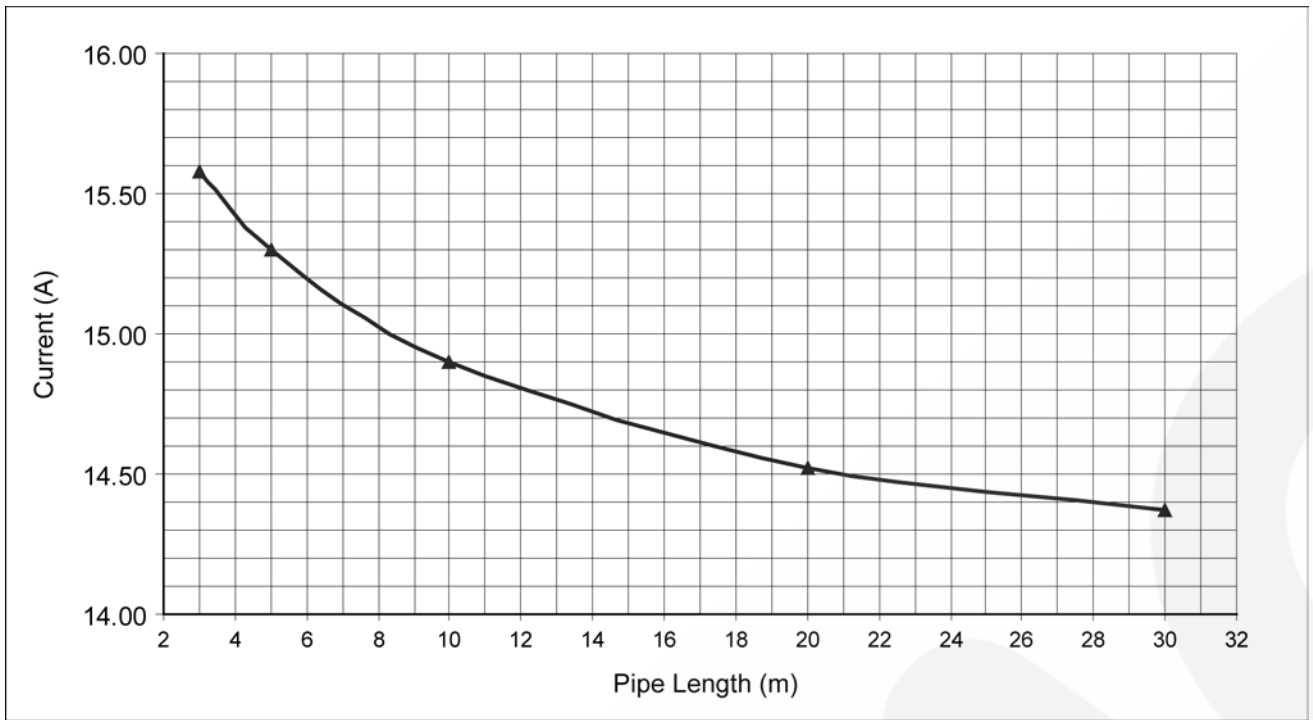

16.2. Sensible Capacity Chart

● CS-E24EKES CU-E24EKE

Indoor wet bulb temp.	Outdoor Temp. (°C)											
	30			35			40			46		
	TC	SHC	IP	TC	SHC	IP	TC	SHC	IP	TC	SHC	IP
17.0°C	6.75	5.11	1.94	6.30	4.90	2.09	5.86	4.71	2.23	5.33	4.48	2.41
19.0°C				6.80		2.12						
19.5°C	7.41	5.35	1.98	6.92	5.14	2.13	6.44	4.95	2.28	5.85	4.71	2.45
22.0°C	8.07	5.55	2.01	7.54	5.34	2.17	7.02	5.15	2.32	6.38	4.91	2.50

● CS-E28EKE CU-E28EKE

Indoor wet bulb temp.	Outdoor Temp. (°C)											
	30			35			40			46		
	TC	SHC	IP	TC	SHC	IP	TC	SHC	IP	TC	SHC	IP
17.0°C	7.59	5.75	2.33	7.09	5.52	2.50	6.59	5.30	2.68	6.00	5.04	2.89
19.0°C				7.65		2.54						
19.5°C	8.33	6.02	2.37	7.79	5.79	2.55	7.24	5.57	2.73	6.59	5.30	2.94
22.0°C	9.08	6.25	2.41	8.48	6.01	2.60	7.89	5.79	2.78	7.18	5.53	2.99

TC - Total Cooling Capacity (kW)
 SHC - Sensible Heat Capacity (kW)
 IP - Input Power (kW)

Indoor 27°C/19°C
 Outdoor 35°C/24°C

17 Exploded View and Replacement Parts List

17.1. CS-E24EKES CS-E28EKE

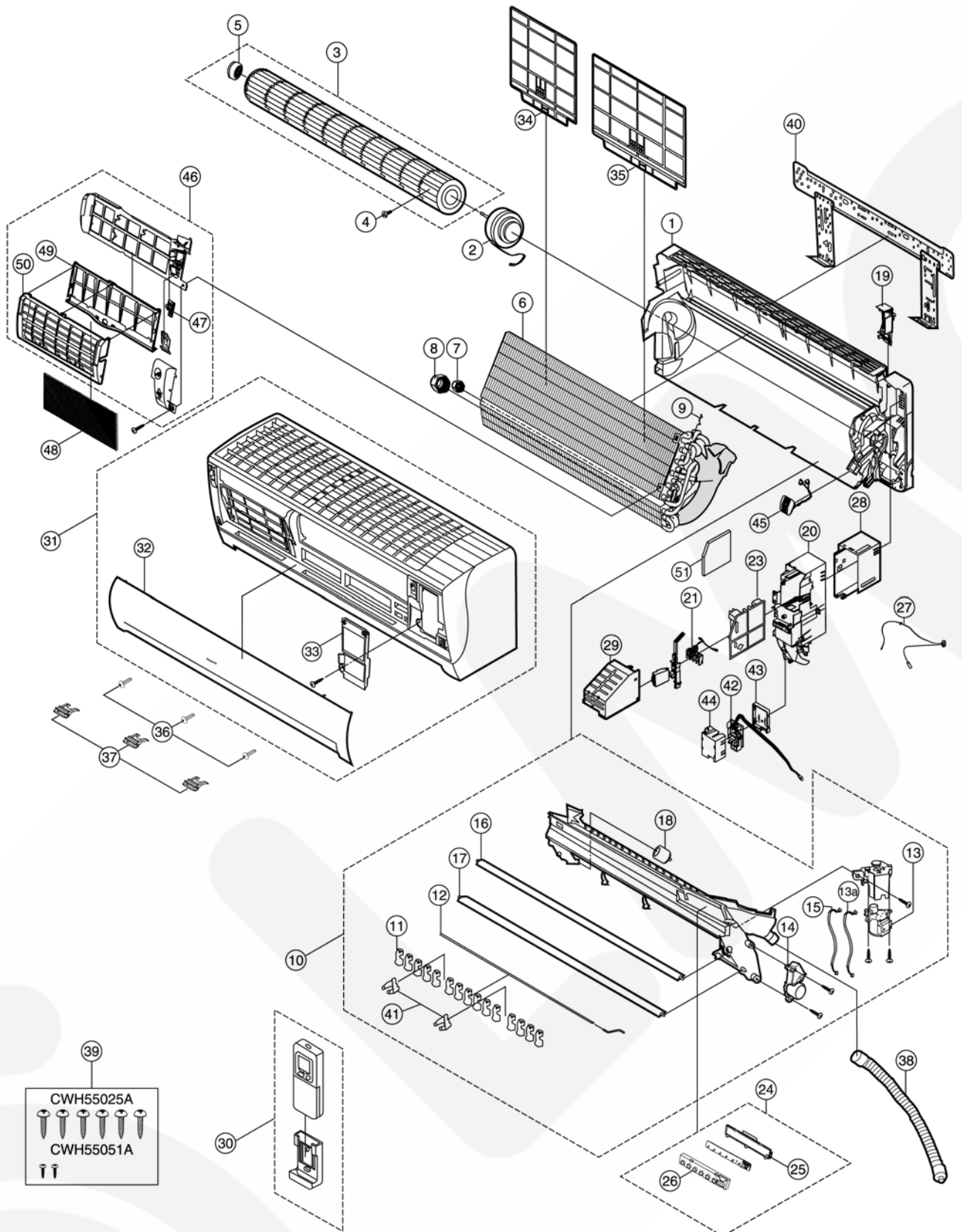

Note:

The above exploded view is for the purpose of parts disassembly and replacement.
The non-numbered parts are not kept as standard service parts.

<Model: CS-E24EKES, CS-E28EKE>

REF NO.	PART NAME & DESCRIPTION	QTY.	CS-E24EKES	CS-E28EKE	REMARKS
1	CHASSY COMPLETE	1	CWD50C1382	←	
2	FAN MOTOR	1	CWA981149J	←	O
3	CROSS FLOW FAN COMPLETE	1	CWH02C1010	←	
4	SCREW - CROSS FLOW FAN	1	CWH551146	←	
5	BEARING ASS'Y	1	CWH64K007	←	
6	EVAPORATOR	1	CWB30C1678	←	
7	FLARE NUT	1	CWT251030 (1/4")	←	
8	FLARE NUT	1	CWT251033 (5/8")	←	
9	HOLDER SENSOR	1	CWH32143	←	
10	DISCHARGE GRILLE COMPLETE	1	CWE20C2441	←	
11	VERTICAL VANE	15	CWE241088	←	
12	CONNECTING BAR	1	CWE261025	←	
13	AIR SWING MOTOR	1	CWA98260+MJ	←	O
13a	LEAD WIRE - AIR SWING MOTOR	1	CWA67C3849	CWA67C3731	
14	AIR SWING MOTOR	1	CWA98K1008	←	O
15	LEAD WIRE - AIR SWING MOTOR	1	CWA67C3731	←	
16	HORIZONTAL VANE	1	CWE241152A	←	
17	HORIZONTAL VANE	1	CWE241153A	←	
18	CAP - DRAIN TRAY	1	CWH52C1001	←	
19	BACK COVER CHASSIS	1	CWD932162B	←	
20	CONTROL BOARD CASING	1	CWH102291	←	
21	TERMINAL BOARD COMPLETE	1	CWA28C2128J	←	O
23	ELECTRONIC CONTROLLER - MAIN	1	CWA73C2251	CWA73C2019	O
24	INDICATOR COMPLETE	1	CWE39C1116	←	O
25	INDICATOR HOLDER	1	CWD932435	←	
26	INDICATOR HOLDER	1	CWD932436	←	
27	SENSOR COMPLETE	1	CWA50C2122	←	O
28	CONTROL BOARD TOP COVER	1	CWH131209	←	
29	CONTROL BOARD FRONT COVER	1	CWH131210	←	
30	REMOTE CONTROL COMPLETE	1	CWA75C2807	←	O
31	FRONT GRILLE COMPLETE	1	CWE11C3357	←	O
32	INTAKE GRILLE COMPLETE	1	CWE22C1159	←	O
33	GRILLE DOOR	1	CWE141076	←	
34	AIR FILTER (L)	1	CWD001137	←	
35	AIR FILTER (R)	1	CWD001138	←	
36	SCREW - FRONT GRILLE	3	XTT4+16CFJ	←	
37	CAP - FRONT GRILLE	3	CWH521062A	←	
38	DRAIN HOSE	1	CWH851063	←	
39	BAG COMPLETE - INSTALLATION SCREW	1	CWH82C067	←	
40	INSTALLATION PLATE	1	CWH36K1007	←	
41	FULCRUM	2	CWH621047	←	
42	ELECTRONIC CONTROLLER - IONIZER	1	CWA743675	←	O
43	CASING - IONIZER	1	CWD932464	←	
44	CASING - IONIZER	1	CWD932527	←	
45	ION GENERATOR	1	CWH94C0001	←	
46	SUPERSONIC AIR PURIFYING DEVICE	1	CWH91C1013	←	
47	ELECTRONIC CONTROLLER SUPERSONIC	1	CWA743874	←	O
48	SUPER ALLERU BUSTER FILTER	1	CWD00C1133	←	
49	FRAME FR AIR FILTER SUPERSONIC	1	CWD011027	←	
50	FRAME FR AIR FILTER SUPERSONIC	1	CWD011026	←	
51	ELECTRONIC CONTROLLER - POWER	1	CWA744061	CWA744321	O

(Note)

- All parts are supplied from PHAAM, Malaysia (Vendor Code: 061).
- "O" marked parts are recommended to be kept in stock.

17.2. CU-E24EKE CU-E28EKE

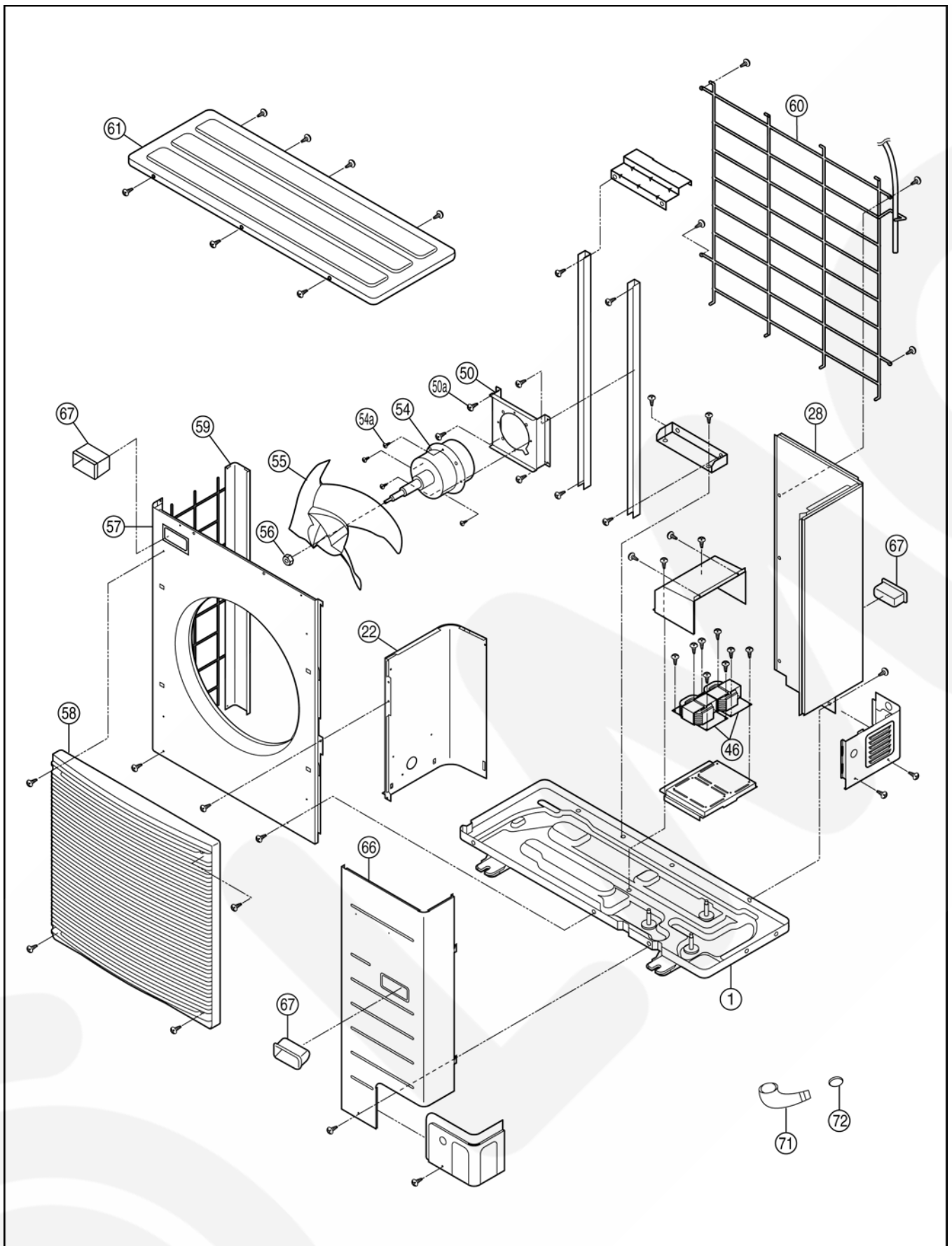

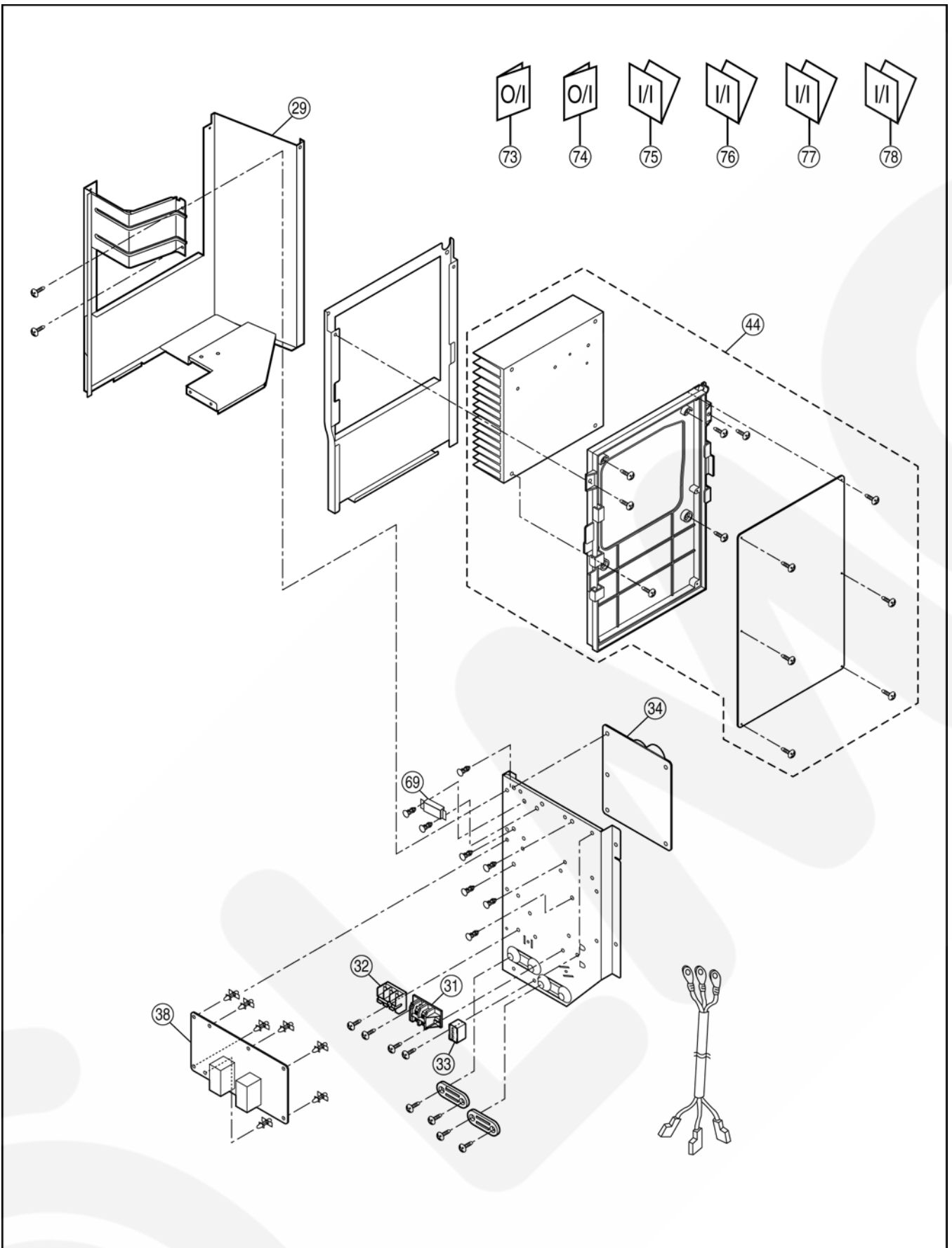

Note:
 The above exploded view is for the purpose of parts disassembly and replacement.
 The non-numbered parts are not kept as standard service parts.

<Model: CU-E24EKE, CU-E28EKE>

REF. NO.	DESCRIPTION & NAME	QTY.	CU-E24EKE	CU-E28EKE	REMARKS
1	BASE PAN ASS'Y	1	CWD52K1098	←	
2	COMPRESSOR	1	5KD240XAA21	←	O
3	ANTI-VIBRATION BUSHING	3	CWH50055	←	
4	NUT FOR COMP. MOUNT.	3	CWH561049	←	
4a	PACKING	3	CWB811017	←	
6	CONDENSER COMPLETE	1	CWB32C1750	←	
8	DISCHARGE MUFFLER	1	CWB121013	←	
10	3-WAYS VALVE (GAS)	1	CWB011251	←	
11	4-WAYS VALVE COMPLETE	1	CWB00C1034	←	
12	2-WAYS VALVE (LIQUID)	1	CWB021330	←	
20	SOUND PROOF MATERIAL-COMP	1	CWG302245	←	
21	SOUND PROOF MATERIAL	1	CWG302246	←	
22	SOUND-PROOF BOARD ASS'Y	1	CWH151075	←	
23	V-COIL COMPLETE	1	CWA43C2169J	←	O
24	V-COIL COMPLETE	1	CWA43C2141J	CWA43C2128J	O
25	SENSOR-OD TEMP./COIL	1	CWA50C2381	←	
26	SENSOR-COMP.DISCHARGE	1	CWA50C2214	←	
27	SENSOR-COMP.SUCT/DEFROST	1	CWA50C2185	←	
28	CABINET REAR PLATE	1	CWE02C1013	←	
29	CONTROL BOARD CASING	1	CWH10K1046	←	
31	TERMINAL BOARD ASS'Y	1	CWA28K1107	←	
32	TERMINAL BOARD ASS'Y	1	CWA28K1076J	←	
33	CAPACITOR-FAN MOTOR	1	DS441355NPQA	←	O
34	ELECTRONIC CONTROLLER (P. SUPPLY)	1	CWA743402	CWA744289	O
38	ELECTRONIC CONTROLLER (NOISE FILTER)	1	CWA744227	CWA744309	O
44	ELECTRONIC CONTROLLER (MAIN)	1	CWA73C2138R	CWA73C2140R	O
46	REACTOR	2	CWA421066	-	
48	TERMINAL COVER	1	CWH171001	←	
49	NUT FOR TERMINAL COVER	1	CWH7080300J	←	
50	BRACKET FAN MOTOR	1	CWD54K1028	←	
50a	SCREW - BRACKET FAN MOTOR	2	CWH551040J	←	
54	FAN MOTOR	1	CWA951510	←	O
54a	SCREW-FAN MOTOR	4	CWH551040J	←	
55	PROPELLER FAN	1	CWH001019	←	
56	NUT for PROPELLER FAN	1	CWH561038J	←	
57	CABINET FRONT PLATE	1	CWE061118A	←	
58	DISCHARGE GRILLE	1	CWE201073	←	
59	CABINET SIDE PLATE	1	CWE04K1019A	←	
60	WIRE NET	1	CWD041060A	←	
61	CABINET TOP PLATE COMPLETE	1	CWE03C1040	←	
62	ACCESSORY COMPLETE	1	CWH82C1105	←	
66	CABINET FRONT PLATE COMPLETE	1	CWE06C1086	←	
67	HANDLE	3	CWE161008	←	
68	TUBE ASS'Y (CAPILLARY TUBE)	1	CWT07K1334	CWT07K1321	
69	ELECTRO. MAGNETIC SWITCH	1	-	CWA001023	
70	EXPANSION VALVE	1	CWB051016J	CWB051018J	
71	DRAIN HOSE	1	CWH5850080	←	
72	PACKING - L. TUBE	1	CWB811010	←	
73	OPERATION INSTRUCTION	1	CWF565203	←	
74	OPERATION INSTRUCTION	1	CWF565204	←	
75	INSTALLATION INSTRUCTION	1	CWF612949	←	
76	INSTALLATION INSTRUCTION	1	CWF612950	←	
77	INSTALLATION INSTRUCTION	1	CWF612951	←	

REF. NO.	DESCRIPTION & NAME	QTY.	CU-E24EKE	CU-E28EKE	REMARKS
78	INSTALLATION INSTRUCTION	1	CWF612952	←	

(Note)

- All parts are supplied from PHAAM, Malaysia (Vendor Code: 061).
- "O" marked parts are recommended to be kept in stock.