

Service Manual

Room Air Conditioner

CS-E15CKP CU-E15CKP5



⚠ WARNING

This service information is designed for experienced repair technicians only and is not designed for use by the general public. It does not contain warnings or cautions to advise non-technical individuals of potential dangers in attempting to service a product. Products powered by electricity should be serviced or repaired only by experienced professional technicians. Any attempt to service or repair the product or products dealt with in this service information by anyone else could result in serious injury or death.

⚠ PRECAUTION OF LOW TEMPERATURE

In order to avoid frostbite, be assured of no refrigerant leakage during the installation or repairing of refrigeration circuit.

CONTENTS

	Page		Page
1 Features	2	10 Installation And Servicing Air Conditioner Using R410A	46
2 Functions	3	11 Installation Instructions	57
3 Product Specifications	6	12 Servicing Information	66
4 Dimensions	8	13 Technical Data	75
5 Refrigeration Cycle Diagram	10	14 Exploded View	77
6 Block Diagram	11	15 Replacement Parts List	78
7 Wiring Diagram	12	16 Exploded View	79
8 Operation Details	13	17 Replacement Parts List	80
9 Operating Instructions	38	18 Electronic Circuit Diagram	81

Panasonic

© 2003 Matsushita Industrial Corp. Sdn. Bhd. (11969-T). All rights reserved. Unauthorized copying and distribution is a violation of law.

1 Features

• Product

- Microcomputer-controlled compressor operating frequency
- Vertical and Horizontal Airflow Directions
- Five modes of operation selection
- Power Mode operation
- Delay ON Timer and OFF Timer
- Standby operation
- Remote Controller with illuminable buttons
- Power Monitor Display LED
- Catechin Air Purifying Filter
- Triple Deodorizing Filter
- Ionizer Mode Operation
- Quiet Mode Operation

• Serviceability

- Washable Front Panel
- Breakdown Self Diagnosis function

• Environmental Protection

- Non-ozone depletion substances refrigerant (R410A)

• Quality Improvement

- Gas leakage detection
- Deice operation
- Auto restart control

2 Functions

Remote Control

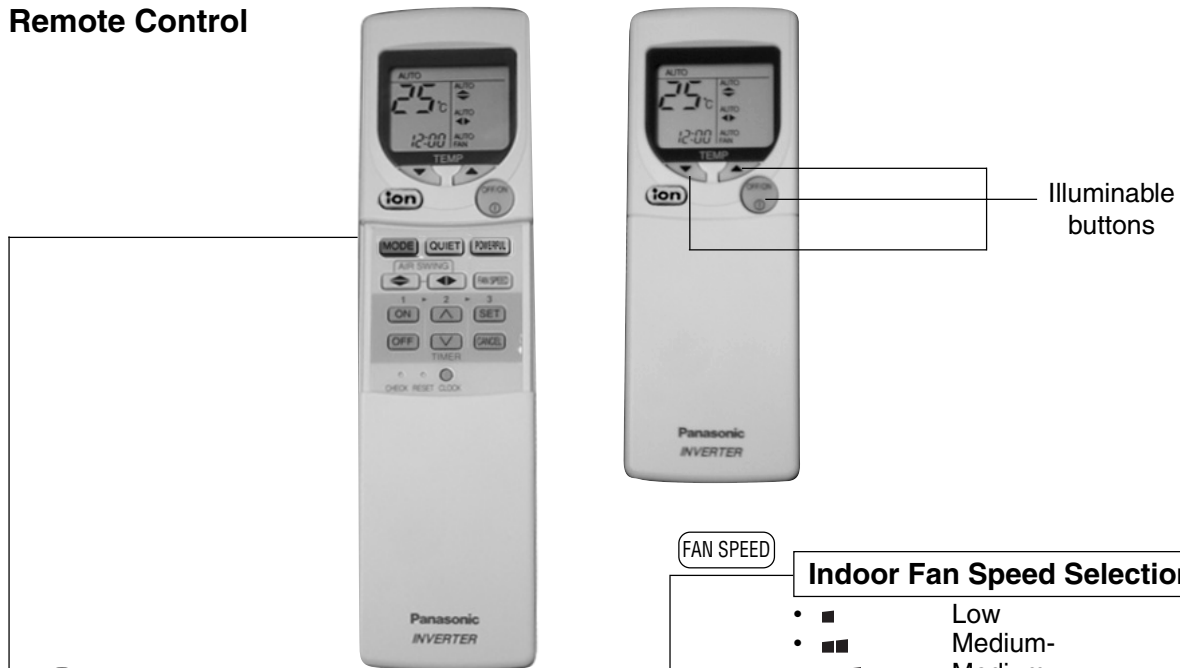

	Operation OFF / ON		Indoor Fan Speed Selection
	Operation Mode Selection	<ul style="list-style-type: none"> ■ Low ■ ■ Medium- ■ ■ ■ Medium ■ ■ ■ ■ Medium+ ■ ■ ■ ■ ■ High AUTO FAN Automatic Fan Speed 	
	Powerful Mode Operation		Room Temperature Setting
	Quiet Mode Operation OFF / ON	<ul style="list-style-type: none"> Temperature Setting (16°C to 30°C) 	
	Ion Mode Operation OFF / ON		Timer Operation Selection
	Airflow Direction Control	<ul style="list-style-type: none"> 24-hour, OFF / ON Real Timer Setting. 	
<ul style="list-style-type: none"> Vertical Automatic Airflow Direction Control and Manual Airflow Direction Control (5 stages of adjustment). Horizontal Automatic Airflow Direction Control and Manual Airflow Direction Control (5 stages of adjustment). 		Time / Timer Setting	
		<ul style="list-style-type: none"> Hours and minutes setting. 	
			Timer Operation Set / Cancel
			<ul style="list-style-type: none"> ON Timer and OFF Timer setting and cancellation.
			Clock Setting
		<ul style="list-style-type: none"> Current time setting. 	
			Check Point
		<ul style="list-style-type: none"> Breakdown self diagnosis function. 	
			Reset Point
		<ul style="list-style-type: none"> Clear memory data. 	

Indoor Unit



Automatic Operation Switch

- Press for < 5s to run Automatic Operation. (Used when the remote control cannot be used.)
- Press continuously for 5s and < 8s to run Forced Cooling Operation.
- Press continuously for 8s and < 11s to run Forced Heating Operation.
- Press continuously for 11s and < 16s to change different remote controlling setting (A↔B Mode).
- Press continuously for 16s or < 21s to switch OFF / ON Remote Control Receiving Sound or H14 Abnormality Detection Mode.

Operation Indication Lamps (LED)

- POWER MONITOR (Green) Lights up during compressor operation.
- **ion** (Green) Lights up in Ionizer Mode Operation.
- POWER (Green) Lights up in operation, blinks in Automatic Operation Mode judging and Hot Start operation.
- TIMER (Orange) Lights up in Timer Setting. Blinks in Self Diagnosis Control.
- QUIET (Orange) Lights up in Quiet Mode Operation.
- POWERFUL (Orange) ... Lights up when Powerful Mode is selected.

Five Operation Modes

- Automatic, Heating, Cooling, Soft Dry and Fan Operation.

Automatic and 5 Manual Indoor Fan Speeds

Automatic and 5 Manual Vertical Airflow Directions

Automatic and 5 Manual Horizontal Airflow Directions

Powerful Mode

- For quick cooling or heating.

Quiet Mode

- To provide extra quiet operation.

Ionizer Control

- Ionizer control for generate negative ion in discharge air.

Delay ON Timer and OFF Timer

Automatic Restart Control

- Operation is restarted after power failure at previous setting mode.

Microcomputer-controlled Room Temperature Control

Outdoor Unit



Breakdown Self Diagnosis Function

Low Pressure Control (Gas Leakage Detection)

Indoor Power Relay Control

Automatic Restart Control

Deodorizing Control

Anti-Fog Discharge Control

Anti Freezing Control

Anti-Cold Draft Control

Hot Start

Intake Air Temperature Control

High Pressure Control

Standby Control

Deice Operation

Time Delay Safety Control

30 seconds Forced Operation

High Pressure Control

Total Running Current Control

Compressor Overheating Prevention Control

IPM (Power Transistor) Overheating Protection Control

Low Operation Frequency Protection Control

Minimum Operation Frequency Protection Control



Outdoor Air Temperature Control

Standby Control

Deice Operation

※ Details can be referred to OPERATION DETAILS in this manual.

3 Product Specifications

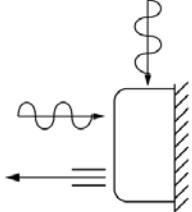
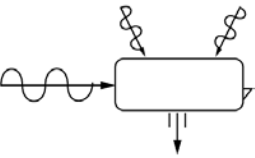
		Unit	CS-E15CKP	CU-E15CKP5
Cooling Capacity		kW kcal/h BTU/h	4.40 (0.60 - 5.00) 3,780 (520 - 4,300) 15,000 (2,050 - 17,100)	
Heating Capacity		kW kcal/h BTU/h	5.30 (0.60 - 6.80) 4,560 (520 - 5,850) 18,100 (2,050 - 23,200)	
Moisture Removal		l/h Pint/h	2.4 (5.1)	
Power Source		Phase V Cycle	Single 230 50	
Airflow Method		OUTLET  INTAKE 	SIDE VIEW 	TOP VIEW 
Air Volume	Indoor Air (Lo)	m ³ /min (cfm)	Cooling; 8.3 (290) Heating; 10.0 (350)	—
	Indoor Air (Me)	m ³ /min (cfm)	Cooling; 9.7 (340) Heating; 11.1 (390)	—
	Indoor Air (Hi)	m ³ /min (cfm)	Cooling; 11.5 (410) Heating; 12.4 (440)	Cooling; 31.0 (1,090)
Noise Level		dB (A)	Cooling; High 43, Low 32 Heating; High 43, Low 35	Cooling; 49 Heating; 50
		Power level dB	Cooling; High 54 Heating; High 54	Cooling; High 62 Heating; High 63
Electrical Data	Input Power	W	Cooling; 1,400 (120 - 1,620) Heating; 1,510 (115 - 1,900)	
	Running Current	A	Cooling; 6.4 Heating; 6.9	
	EER	W/W (kcal/hw), BTU/hw	Cooling; 3.14 (2.70), 10.7	
	COP	W/W (kcal/hw), BTU/hw	Heating; 3.51 (3.02), 12.0	
	Starting Current	A	6.9	
Piping Connection Port (Flare piping)		inch inch	G ; Half Union 1/2" L ; Half Union 1/4"	G ; 3-way valve 1/2" L ; 2-way valve 1/4"
Pipe Size (Flare piping)		inch inch	G (gas side) ; 1/2" L (liquid side) ; 1/4"	G (gas side) ; 1/2" L (liquid side) ; 1/4"

		Unit	CS-E15CKP	CU-E15CKP5	
Drain Hose	Inner diameter	mm	12	—	
	Length	m	0.65	—	
Power Cord Length			2.1 m	—	
Number of core-wire			3 core wires × 1.5 mm ²	—	
Dimensions	Height	inch (mm)	10 - 26/32 (275)	21 - 9/32 (540)	
	Width	inch (mm)	31 - 15/32 (799)	30 - 23/32 (780)	
	Depth	inch (mm)	8 - 9/32 (210)	11 - 3/8 (289)	
Net Weight		lb (kg)	20 (9.0)	82 (37)	
Compressor	Type		—	Involute scroll	
	Motor Type		—	Brushless (4-pole)	
	Rated Output	W	—	700	
Air Circulation	Type		Cross-flow Fan	Propeller Fan	
	Material		AS + Glass Fiber 20%	P.P	
	Motor Type		Transistor (8-poles)	Induction (6-poles)	
	Input	W	—	65.9	
	Rate Output	W	30	29	
	Fan Speed	Lo (Cool/Heat)	rpm	990 / 1,190	—
		Me (Cool/Heat)	rpm	1,160 / 1,310	—
Hi (Cool/Heat)		rpm	1,370 / 1,470	830	
Heat Exchanger	Description		Evaporator	Condenser	
	Tube material		Copper	Copper	
	Fin material		Aluminium (Pre Coat)	Aluminium (Blue Coated)	
	Fin Type		Slit Fin	Corrugated Fin	
	Row / Stage		(Plate fin configuration, forced draft)		
			2 / 15	2 / 24	
	FPI		21	17	
Size (W × H × L)	mm	610 × 315 × 25.4	703.8 × 504 × 36.4 735.0		
Refrigerant Control Device			—	Capillary Tube	
Refrigeration Oil		(c.c)	—	RB68A (360)	
Refrigerant (R410A)		g (oz)	—	1,130 (39.9)	
Thermostat			Electronic Control	—	
Protection Device			Electronic Control	Electronic Control	
Capillary Tube	Length	mm	—	C1, C2 ; 1,100, C3 ; 750	
	Flow Rate	l/min	—	C1, C2 ; 5.0, C3 ; 15.4	
	Inner Diameter	mm	—	C1, C2 ; 1.2, C3 ; 1.7	
Air Filter	Material		P.P.	—	
	Style		Honeycomb	—	
Fan Motor Capacitor		μF, VAC	—	2.0 μF, 400 VAC	

- Specifications are subject to change without notice for further improvement.

4 Dimensions

CS-E15CKP

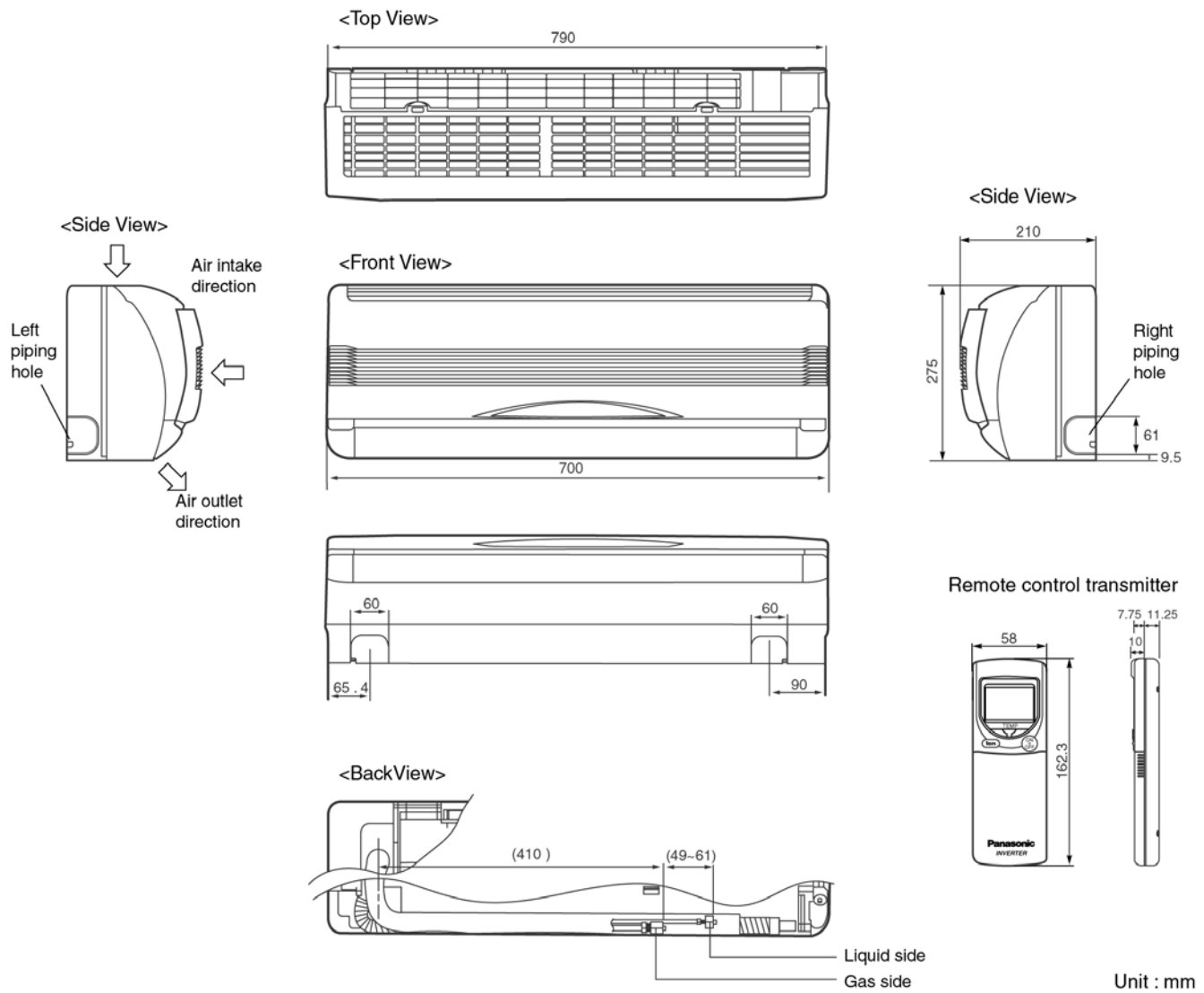

Relative position between the indoor unit and the installation plate <Front View>

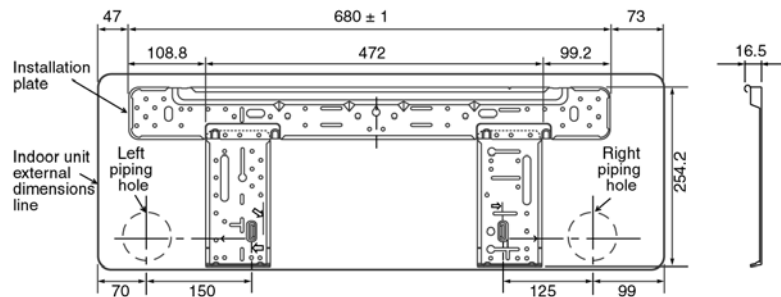

CU-E15CKP5

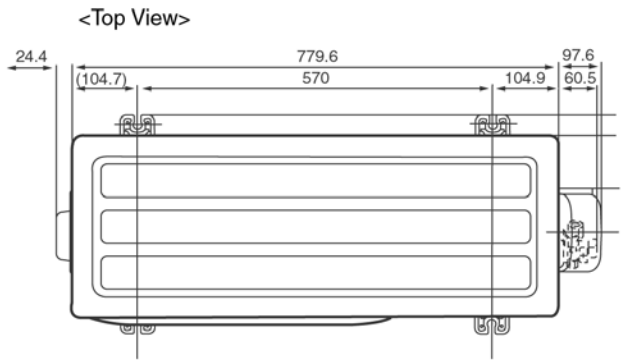
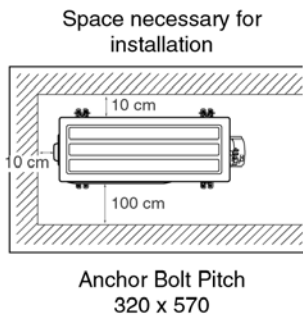

2-way valve at Liquid side
(High Pressure)

3-way valve at Gas side
(Low Pressure)

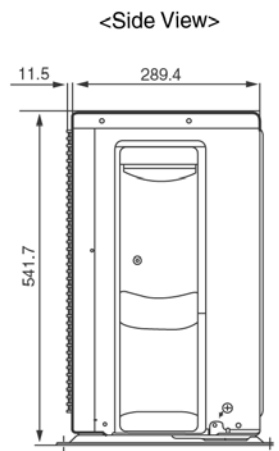
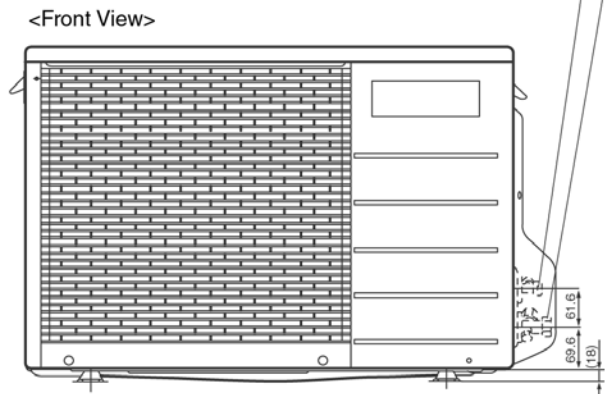
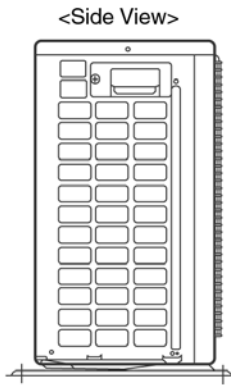

Unit: mm

5 Refrigeration Cycle Diagram

CS-E15CKP / CU-E15CKP5

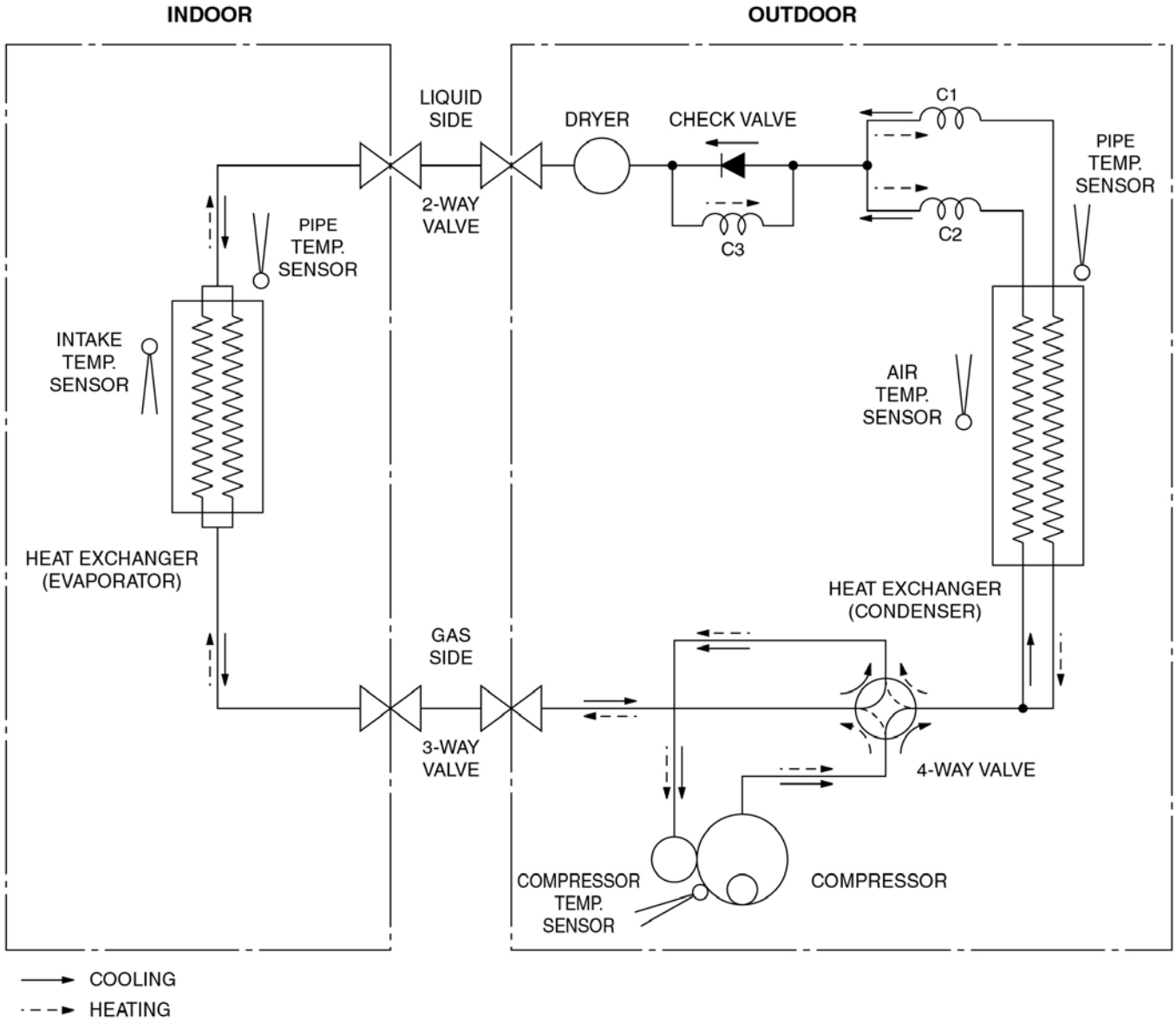

6 Block Diagram

CS-E15CKP / CU-E15CKP5

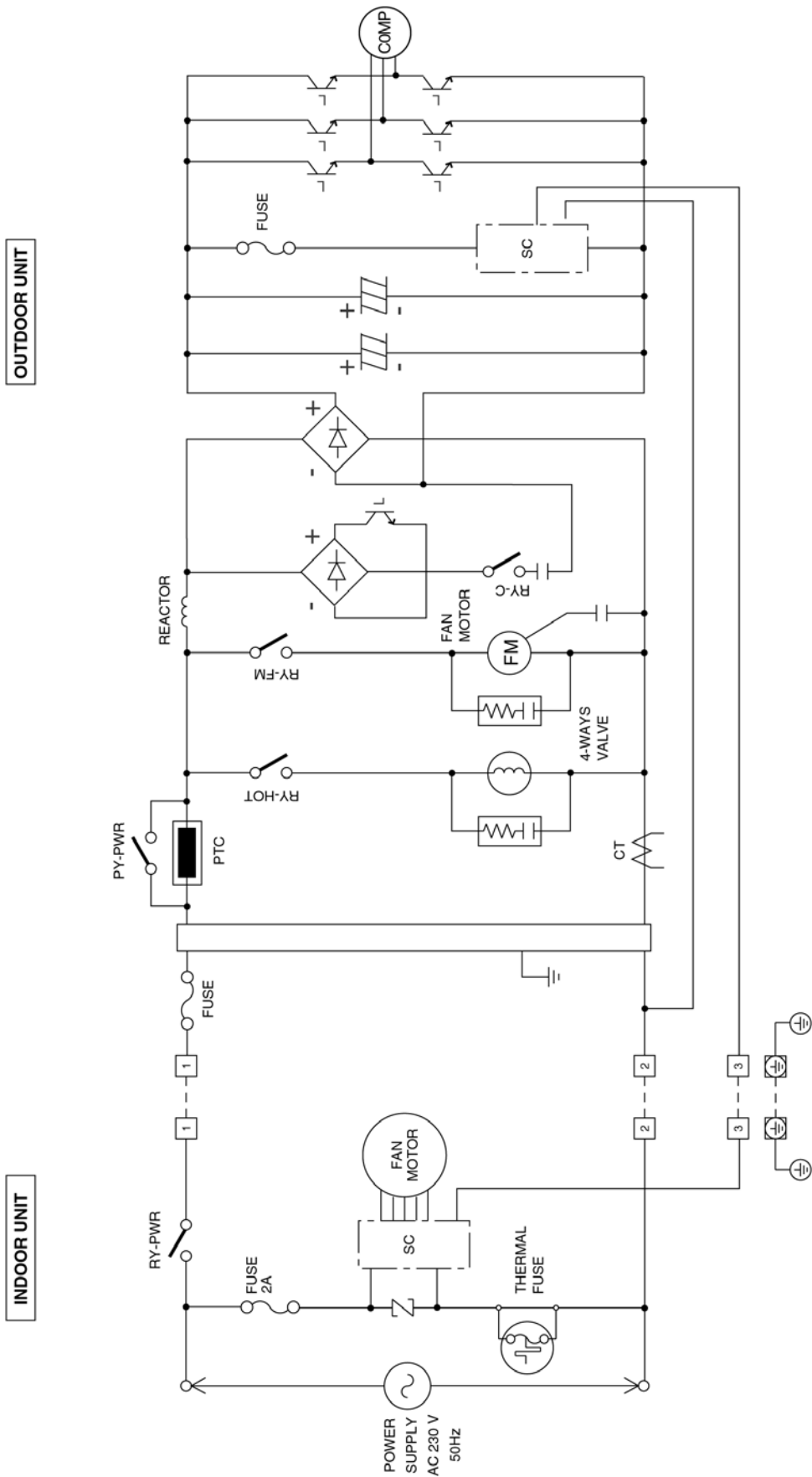

✳ [] Indicates the electronic control unit.

✳ "C" Indicates the number of core wires. (Example: 5C=5 core wires)

7 Wiring Diagram

CS-E15CKP / CU-E15CKP5

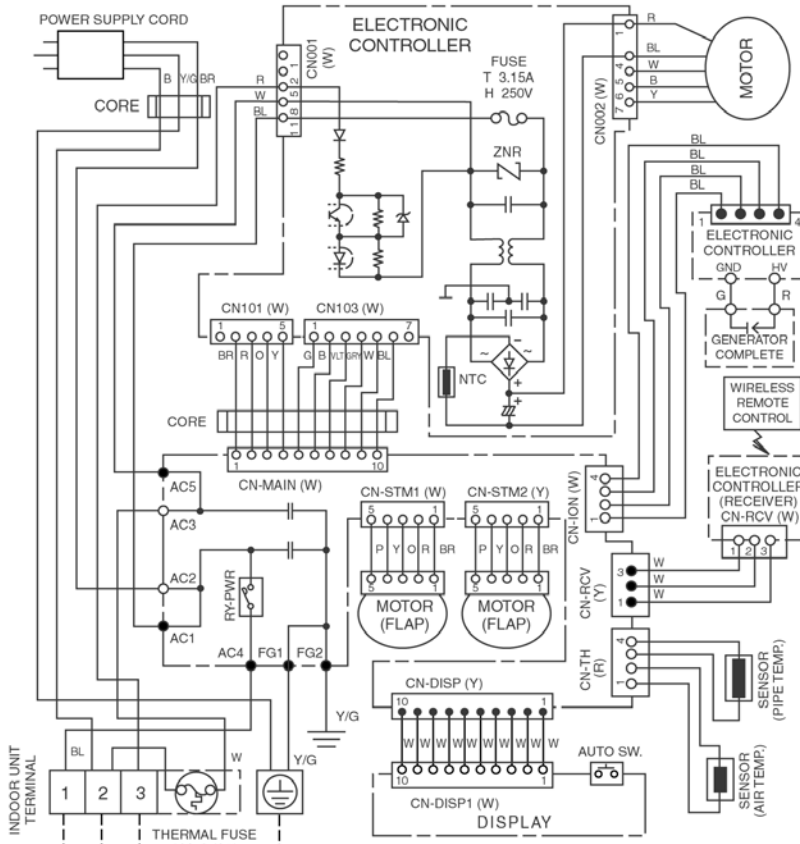

Remarks:

- B : BLUE
- BR : BROWN
- BL : BLACK
- W : WHITE
- GR : GREEN
- R : RED
- O : ORANGE
- V : VIOLET
- GRY : GRAY
- Y/G : YELLOW / GREEN

Resistance of Outdoor Fan Motor Windings

CONNECTION	CWA951126 (Ω)
BLUE - YELLOW	228.5
YELLOW - RED	245.4

Resistance of Compressor Windings

CONNECTION	5CS102XEC (Ω)
U - V	1.082
V - W	1.066
U - W	1.100

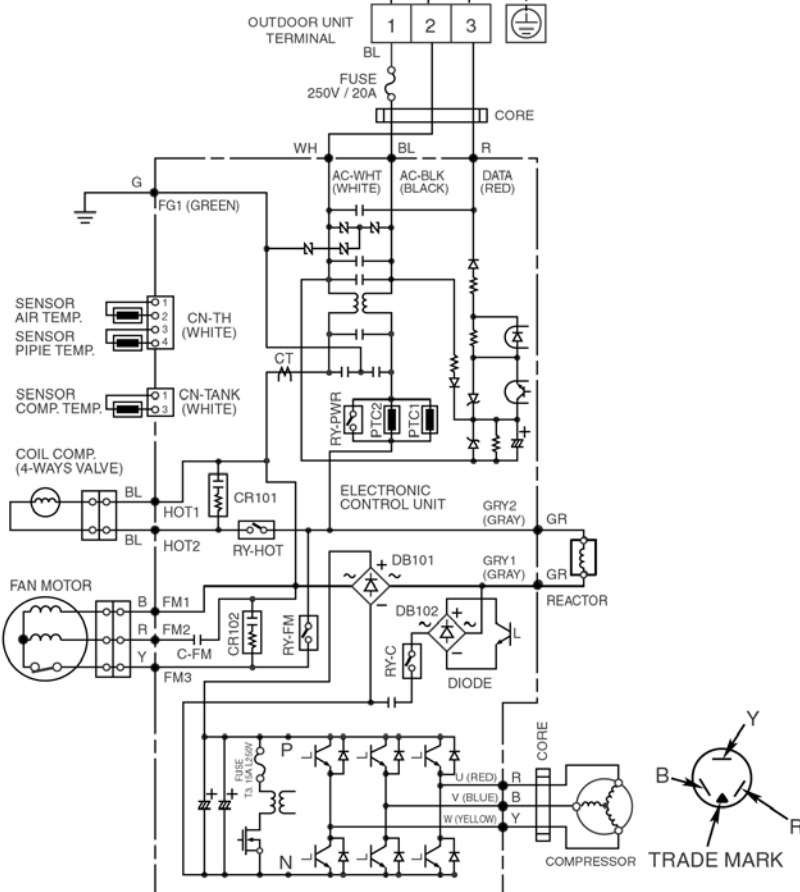

8 Operation Details

8.1. BASIC FUNCTION

Inverter control, which equipped with a microcomputer in determining the most suitable operating mode as time passes, automatically adjust output power for maximum comfort always. In order to achieve the suitable operating mode, the microcomputer maintains the set temperature by measuring the temperature of the environment and performing temperature shifting. The compressor at outdoor unit is operating following the frequency instructed by the microcomputer at indoor unit that judging the condition according to internal setting temperature and intake air temperature.

8.1.1. Internal Setting Temperature

Once the operation starts, remote controller setting temperature will be taken as base value for temperature shifting processes. These shifting processes are depending on the air conditioner settings and the operation environment. The final shifted value will be used as internal setting temperature and it is updated continuously whenever the electrical power is supplied to the unit.

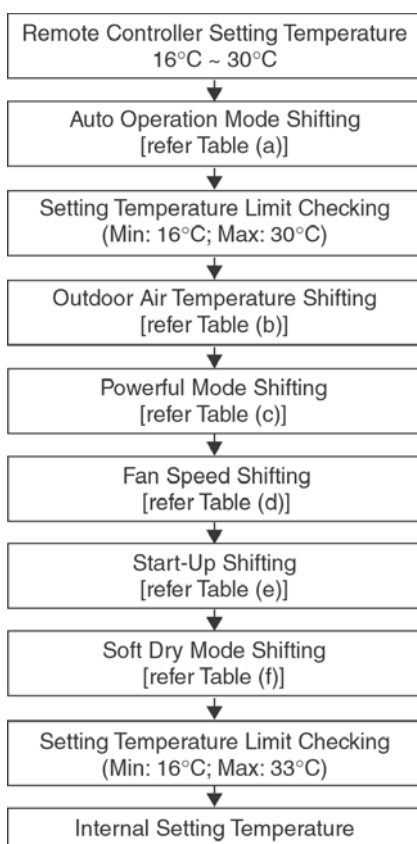

Table (a): Auto Operation Mode Setting

Mode Shift:	Temperature Shift (°C)		
	E9CKP	E12CKP	E15CKP
Cooling/Soft Dry → Heating	-2.0	-2.0	-2.0
Heating → Cooling/Soft Dry	+2.0	+2.0	+2.0

Table (b): Outdoor Air Temperature Shifting

Mode:	Outdoor Temperature, X (°C):	Temperature Shift (°C)		
		E9CKP	E12CKP	E15CKP
Cooling/Soft Dry	$X \geq 30$	0.0	0.0	0.0
	$X < 30$	+0.5	+0.5	+0.5
Heating	$X \geq 9$	0.0	0.0	0.0
	$5 \leq X < 9$	+0.5	+1.0	+1.0
	$1 \leq X < 5$	+1.0	+1.5	+1.5
	$X < 1$	+1.5	+2.0	+2.0

Table (c): Powerful Mode Shifting

Mode:	Period, X (min):	Temperature Shift (°C)		
		E9CKP	E12CKP	E15CKP
Cooling	$X < 20$	-2.0	-2.0	-2.0
	$X \geq 20$	0.0	0.0	0.0
Soft Dry	$X < 20$	-1.0	-1.0	-1.0
	$X \geq 20$	0.0	0.0	0.0
Heating	$X < 20$	+3.5	+3.5	+3.5
	$X \geq 20$	+3.5	+3.5	+3.5

Table (d): Fan Speed Shifting

Mode:	Fan Speed:	Temperature Shift (°C)		
		E9CKP	E12CKP	E15CKP
Cooling	All	+1.5	+1.5	+1.5
Soft Dry	All	+1.0	+1.0	+1.0
Heating	Lo	+1.0	+1.0	+1.0
	Me-, Me, Me+, Hi, Auto	+0.5	+0.5	+0.5

Table (e): Start-Up Shifting

Mode within 60 Minutes from Start-up:	Temperature Shift (°C)		
	E9CKP	E12CKP	E15CKP
Cooling/Soft Dry	-1.0	-1.0	-1.0
Heating	+2.0	+2.0	+2.0

Table (f): Soft Dry Mode Shifting

Mode:	Temperature Shift (°C)		
	E9CKP	E12CKP	E15CKP
Soft Dry	+1.0	+1.0	+1.0

8.1.2. Frequency Instruction for Compressor Operation

Operation of compressor is based on instructed frequency, continuously from indoor unit's microcomputer after performing temperature sampling and judgment.

There are total 30 different frequency values, which listed as Table on Frequency Number, to be instructed based on the temperature judgment

Table on Frequency Number

No.	Frequency (Hz)		Remarks
	E9CKP	E12CKP/E15CKP	
1	12.0	12.0	Freq. MIN
2	15.0	15.0	
3	18.0	18.0	
4	21.0	21.0	
5	23.0	23.0	
6	25.0	25.0	
7	26.0	28.0	
8	30.0	32.0	
9	33.0	36.0	
10	35.0	40.0	
11	36.0	44.0	
12	38.0	48.0	
13	39.0	52.0	Fc
14	40.0	57.0	
15	47.0	62.0	Fc max. (E9CKP)
16	49.0	67.0	Fc max. (E12CKP/E15CKP)
17	56.0	68.5	Fh
18	58.0	72.0	
19	63.0	76.0	
20	66.0	80.0	
21	70.0	85.0	
22	73.0	88.0	
23	77.0	91.0	
24	80.0	94.0	
25	83.0	98.0	
26	86.0	102.0	
27	87.0	104.0	
28	88.0	106.0	
29	89.0	108.0	
30	90.0	110.0	Fh max.

For normal start of operation, including Thermo-OFF, Deice-Resuming, and remote controller ON-OFF starts, the compressor starts to operate at frequency no. 8, values of 30Hz and 32Hz for E9CKP and E12CKP/E15CKP respectively, for 60 seconds.

The frequency to be judged and instructed, however, starts to judge once the air conditioner operated and the judgment will continue every 30 seconds until it is stopped by all kinds of compressor off conditions. This judgment is based on the internal temperature sampling that involving internal setting temperature and intake air temperature.

From the internal sampling, the temperature different (intake air temperature - internal setting temperature) will be used to judge the Zone on which the frequency to be instructed for the initial operation of compressor (refer to Table on Initial Frequency Zone).

Table on Initial Frequency Zone

Temperature, X (°C) (Intake Air - Internal Setting)	Zone	Freq. No. - E9CKP			Freq. No. - E12CKP/E15CKP		
		Cooling	Soft Dry	Heating	Cooling	Soft Dry	Heating
$X < -2.5$	0	1	4	30	1	4	30
$-2.5 \leq X < -1.5$	1	1	4	30	1	4	30
$-1.5 \leq X < -1.0$	2	1	4	10	1	4	10
$-1.0 \leq X < -0.5$	3	1	4	7	1	4	7
$-0.5 \leq X < +1.0$	4	4	4	4	4	4	4
$+0.5 \leq X < +1.0$	5	6	6	1	6	6	1
$+1.0 \leq X < +1.5$	6	9	7	1	9	8	1
$+1.5 \leq X < +2.5$	7	15	7	1	16	8	1
$X \geq +2.5$	8	15	7	1	16	8	1

After the initial operation, the instructed frequency will change or shift from initial frequency according to the judgment on temperature different from sampling (refer to the Table on Shifting Frequency Zone).

Table on Shifting Frequency Zone

Temperature, X (°C) (Intake Air - Internal Setting)	Zone	Frequency No. Shifting:	
		Cooling Mode / Soft Dry Mode	Heating Mode
$X < -2.5$	0	Shift to Freq. MIN	Shift to Freq. MAX
$-2.5 \leq X < -1.5$	1	Shift to Freq. MIN	Shift to Freq. MAX
$-1.5 \leq X < -1.0$	2	-2 Freq. No.	+2 Freq. No.
$-1.0 \leq X < -0.5$	3	-1 Freq. No.	+1 Freq. No.
$-0.5 \leq X < +1.0$	4	Same Freq. No.	Same Freq. No.
$+0.5 \leq X < +1.0$	5	+1 Freq. No.	-1 Freq. No.
$+1.0 \leq X < +1.5$	6	+2 Freq. No.	-2 Freq. No.
$+1.5 \leq X < +2.5$	7	Shift to Freq. MAX	Shift to Freq. MIN
$X \geq +2.5$	8	Shift to Freq. MAX	Shift to Freq. MIN

Besides, the range of operation frequency will change according to the setting environment as listed below:

Condition:	Freq. no. for E9CKP		Freq. no. for E12CKP/E15CKP		Remarks
	MIN	MAX	MIN	MAX	
Cooling Mode	1	15	1	16	(a)
- if remote controller set $\leq 28^\circ\text{C}$ & fan speed = Hi	7	15	7	16	(a), (c)
- if remote controller set $\leq 28^\circ\text{C}$ & fan speed = Me-, Me, Me+, Auto	5	15	6	16	(a), (c)
- if remote controller set $\leq 28^\circ\text{C}$ & fan speed = Lo	4	15	5	16	(a), (c)
- if Powerful Mode ON	7	15	7	16	(a), (c)
Soft Dry Mode	4	7	4	8	
Heating Mode	1	30	1	30	(b)
- if remote controller set $\geq 18^\circ\text{C}$ & fan speed = Hi	10	30	10	30	(b), (d)
- if remote control set $\geq 18^\circ\text{C}$ & fan speed = Me-, Me, Me+, Auto	9	30	9	30	(b), (d)
- if remote controller set $\geq 18^\circ\text{C}$ & fan speed = Lo	8	30	8	30	(b), (d)
- if Powerful Mode ON	10	30	10	30	(b), (d)

Remark:

- (a) If frequency decreases from MAX, the following frequency performed will be depending to outdoor temperature, as given in below table (for 30 seconds only) and then continues as normal rule.

Outdoor Temperature, X (°C)	Frequency No.
$X \geq 30$	13
$X < 30$	7

- (b) (If frequency increases from Freq. No. 17, the following frequency performed is as below (for 30 seconds only) and then continue as normal rule.

Outdoor Temperature, X (°C)	Frequency No.
$X \geq 10$	10
$X \leq X < 10$	13
$X < 4$	17

- (c) When temperature different (intake - setting) $< -1.0^\circ\text{C}$ or Thermo-Off activated and only valid for 120 seconds; not applicable during Soft Dry Mode, and Anti-freezing control.
- (d) When temperature different (intake - setting) $> +1.5^\circ\text{C}$ or Thermo-Off activated and only valid for 130 seconds.

The frequency judgment will perform every 30 seconds. Nevertheless, the frequency is instructed to outdoor compressor after every 90 seconds except when either one of the below conditions is met:

- (a) The frequency judged changes from frequency number decreasing zones (Zone No. 0 or 1 or 2 or 3) to frequency number increasing zones (Zone No. 5 or 6 or 7 or 8) and vice versa.
- (b) The frequency judged falls on frequency shifting zone number 0 or 1 (shift to Frequency MIN) at Cooling mode operation.
- (c) The frequency judged falls on frequency shifting zone number 4 (no shifting in frequency number) at Cooling mode operation.
- (d) The frequency judged falls on frequency shifting zone number 7 or 8 (shift to Frequency MAX) at automatic fan speed.

The instructed frequency is the value referred by the frequency number, which resulted from previous instructed frequency number with the numbers of frequency numbers to be shifted, in Table on Frequency Number.

Time (s)	0	30	60	90	120	150	180	210	240	270	300	330
Zone (+/-)		+	+	+	+	+	+/-	+	-	-	+/-	+
Freq. zone based on temp. diff.	8	7	7	6	6	6	4	5	3	1	4	5
Frequency shift		Max	Max	+2	+2	+2	0	+1	-1	Min	0	+1
Freq. no. judged based on previous	15	30	30	17	17	17	15	16	14	5	4	6
Freq. instruction (Y/N) & its condition	Y (a)	Y (a)	Y (b)	N	N	Y (c)	Y (d)	N	Y (e)	Y (f)	Y (d)	N
Freq. control condition	(g)	(g)	(h)			(h)				(i)		
Instructed freq.	8	8	15			15	15		14	5	5	5
Operation freq.	8	8	15	15	15	15	15	15	14	5	5	5

Note:

- (a) Starting frequency.
- (b) Frequency judged falls on Zone 7 or 8 (shift to Frequency MAX).
- (c) 90 seconds frequency instruction limit.
- (d) Frequency judged falls on Zone 4 (no shifting).
- (e) Frequency no. changes from no. increasing zones to no. decreasing zones.
- (f) Frequency judged falls on Zone 0 or 1 (shift to Frequency MIN).
- (g) Normal initial operation starts (60 s).
- (h) Maximum frequency for normal cooling operation
- (i) Minimum frequency for normal cooling operation.

8.1.3. Indoor Fan Motor Operation

There are 31 fan speed numbers assigned for different fan speed operation at designed conditions, as shown in below table. The fan speed can be set manually using remote control (5 speeds for cooling mode: Lo, Me-, Me, Me+, Hi; 5 speeds for heating: Lo, Me-, Me, Me+, Shi) or let it automatically changes depending on the operation and its environment.

Fan Speed No.	CS-E9CKP				CS-E12CKP/E15CKP				Remark
	Voltage (V)	Cooling	Dry	Heating	Voltage (v)	Cooling	Dry	Heating	
0		OFF	OFF	OFF		OFF	OFF	OFF	- Hot start control. - Deice control.
1									
2	3.03				3.03				
3	3.05		SLo		3.05		SLo		- Soft Dry operation mode. - ON timer pre-operation (D).
4	3.13				3.13				- Auto operation mode judgment (C/D). - ON timer preparation sampling (C/D).
5	3.15				3.23				- Auto operation mode judgment (H). - ON timer preparation sampling (H).
6	3.16	Lo			3.29	Lo			- ON timer pre-operation at Auto fan (C).
7	3.23			Lo	3.34				- ON timer pre-operation at Auto fan for E9CKP (H).
8	3.24				3.40				
9	3.31	Me-			3.44	Me-			
10	3.36				3.53				
11	3.39			Me-	3.60	Me			- Powerful Mode at Lo fan for E12CKP/E15CKP (C).
12	3.44				3.63				
13	3.47	Me			3.66			Lo	- Powerful Mode at Lo fan for E9CKP (C). - ON timer pre-operation at Auto fan for E12CKP/E15CKP (H).
14	3.55			Me	3.68				- Powerful Mode at Lo fan for E9CKP (H).
15	3.57				3.71				
16	3.60				3.75			Me-	
17	3.63	Me+			3.77	Me+			- Powerful Mode at Me- fan (C).
18	3.66				3.83				
19	3.68				3.85				
20	3.71				3.86			Me	- Powerful Mode at Lo fan for E12CKP/E15CKP (H).
21	3.73			Me+	3.91				- Powerful Mode at Me- fan for E9CKP (H).
22	3.77				3.94				
23	3.79				3.98			Me+	- Powerful Mode at Me- fan for E12CKP/E15CKP (H).
24	3.80				4.00				
25	3.82	Hi			4.00	Hi			- Powerful mode at Me, Me+ or Hi fan (C).
26	3.85				4.01				
27	3.89				4.05	SHi			
28	3.90	SHi			4.08				
29	3.91				4.11				
30	3.93			SHi	4.16			SHi	- Powerful mode at Me, Me+ or Hi fan (H).
31	4.07				4.30				

8.1.4. Cooling Mode Automatic Indoor Fan Speed

The automatic fan speed for cooling operation is as shown in below patterns (a → b → c → → h) with each pattern 10 seconds. The fan speed for each level (X or Y or Z) is as below table.

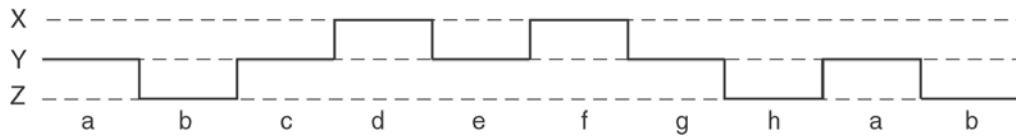

Model No.	E9CKP			E12CKP/E15CKP		
Level	X	Y	Z	X	Y	Z
Normal Operation Fan Speed No.	11	9	7	10	9	7
Powerful Mode Fan Speed No.	13	11	9	12	10	9

(a) During cooling operation, if all the following conditions occur, indoor fan speed will be shifted to Shi internally.

- (i) Indoor intake air temperature $\leq 24^{\circ}\text{C}$.
- (ii) Instructed frequency = 39 Hz (E9CKP) or 52 Hz (E12CKP/E15CKP).
- (iii) Remote controller setting temperature = 16°C .
- (iv) Remote controller setting fan speed = Hi.
- (v) Outdoor air temperature $\geq 30^{\circ}\text{C}$.
- (vi) Operation starts ≤ 30 minutes.

8.1.5. Heating Mode Indoor Fan Motor Operation (Anti Cold draft Control)

Indoor fan speed varies in accordance to indoor heat exchanger temperature, based on type of air volume and direction, as shown below.

1. Manual Fan Speed

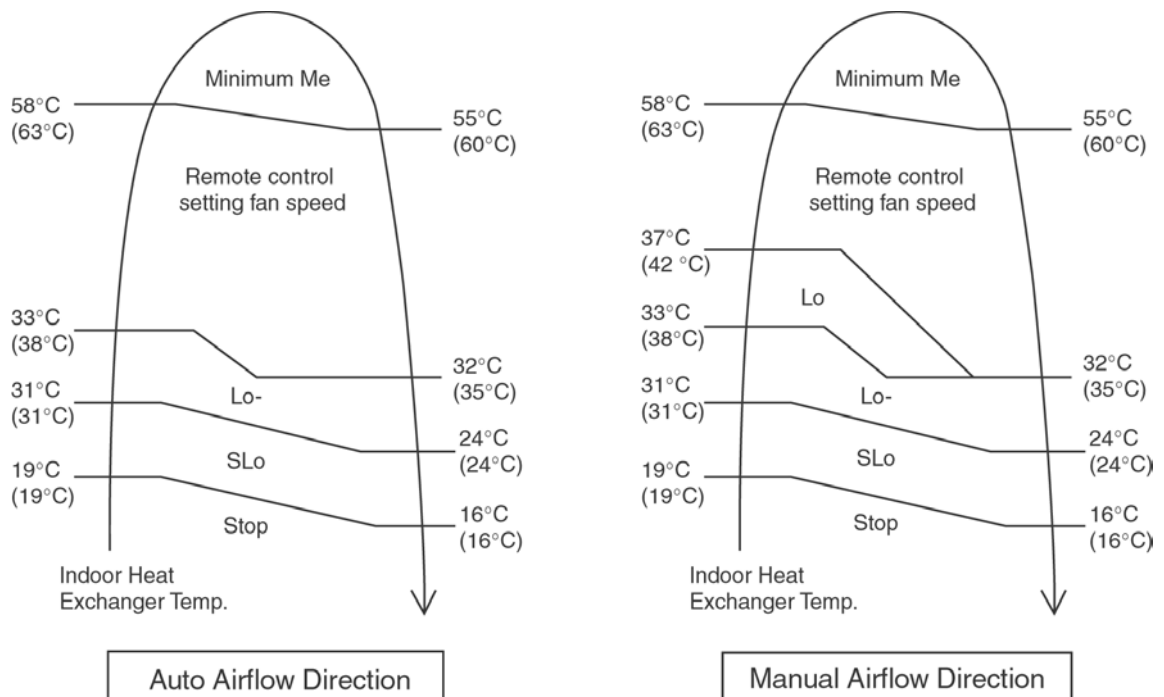

2. Auto Fan Speed

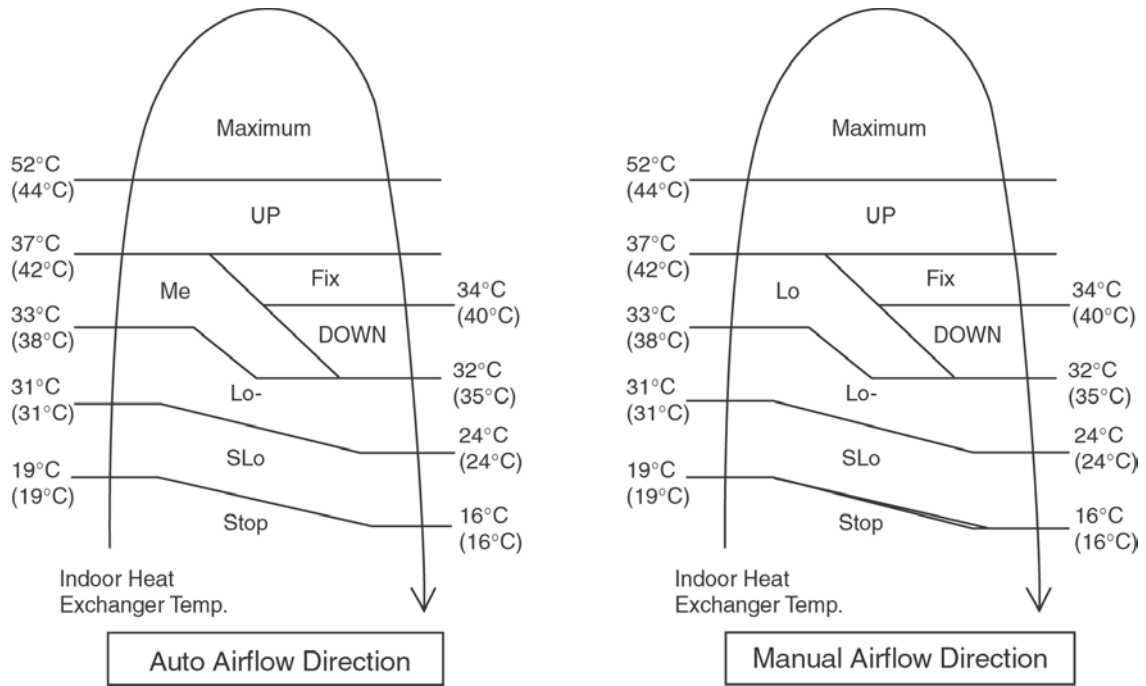

Note:

a. UP:

- If move from Lo or Lo-, the fan speed will be shifted to Maximum.
- If move from Maximum, the fan speed no change.
- Other than that, the fan speed will be increased one Fan Speed No.

b. DOWN:

- The fan speed will be decreased one Fan Speed No.

c. Fix:

- No change in fan speed.

d. Maximum:

- Fan speed will be increased to maximum auto fan speed.

e. Temperature in () is for Powerful Mode operation.

8.1.6. Outdoor Fan Motor Operation

Outdoor fan motor is operated with one fan speed only. It starts when compressor starts operation and it stops 30 seconds after compressor stops operation.

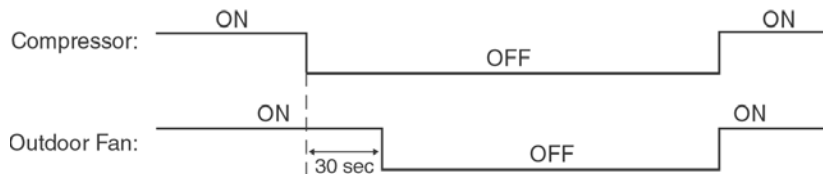

8.1.7. Airflow Direction

1. There are two types of airflow, vertical airflow (directed by horizontal vane) and horizontal airflow (directed by vertical vanes).
2. Control of airflow direction can be automatic (angles of direction is determined by operation mode, heat exchanger temperature and intake air temperature) and manual (angles of direction can be adjusted using remote controller).

Vertical Airflow

Operation Mode	Airflow Direction		Vane Angle (°)				
			1	2	3	4	5
Heating	Auto, with Heat Exchanger Temperature	A	17				
		B	58				
		C	7				
	Manual		7	17	33	49	67
Cooling, Soft Dry and Fan, Ion	Auto	7 ~ 37					
	Manual		7	17	25	33	41
Mode Judgment in Auto	Auto	7					
	Manual		7	17	25	33	41

1. Automatic vertical airflow direction can be set using remote controller; the vane swings up and down within the angles as stated above. For heating mode operation, the angle of the vane depends on the indoor heat exchanger temperature as Figure 1 below. When the air conditioner is stopped using remote controller, the vane will shift to close position.
2. Manual vertical airflow direction can be set using remote controller; the angles of the vane are as stated above and the positions of the vane are as Figure 2 below. When the air conditioner is stopped using remote controller, the vane will shift to close position.

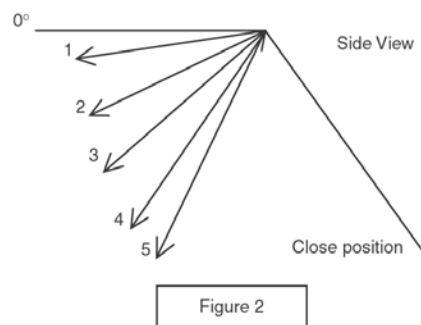
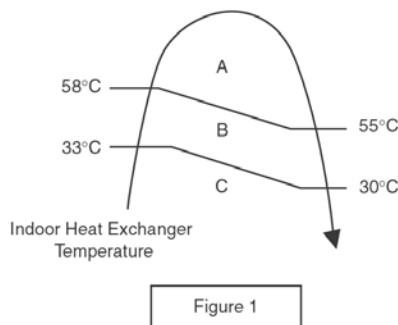

Horizontal Airflow

1. Automatic horizontal airflow direction can be set using remote controller; the vane swings left and right within the angles as stated below. For heating mode operation, the angle of the vane depends on the indoor heat exchanger temperature as Figure 1 below.

Operation Mode		Vane Angle (°)
Heating, with heat exchanger temperature	A	55 ~ 125
	B	90
Cooling, Soft Dry and Fan, Ion		55 ~ 125

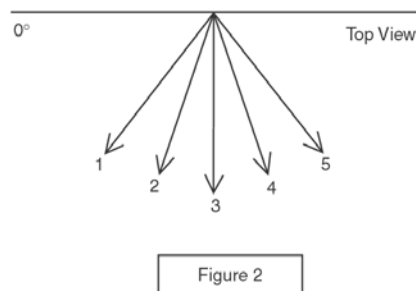
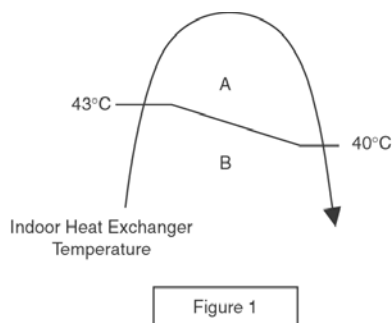

2. Manual horizontal airflow direction can be set using remote controller; the angles of the vane are as stated below and the positions of the vane are as Figure 2 above.

Pattern	1	2	3	4	5
Airflow Direction Patterns at Remote Controller					
Vane Angle (°)	90	55	70	110	125

8.1.8. Automatic Mode Operation

This mode can be set using remote controller and the operation is decided by remote controller setting temperature, indoor intake air temperature and outdoor air temperature.

During operation mode judgment, indoor fan motor (with speed of Lo-) and outdoor fan motor are running for 20 seconds to detect the indoor intake and outdoor air temperature. The operation mode is decided based on below chart.

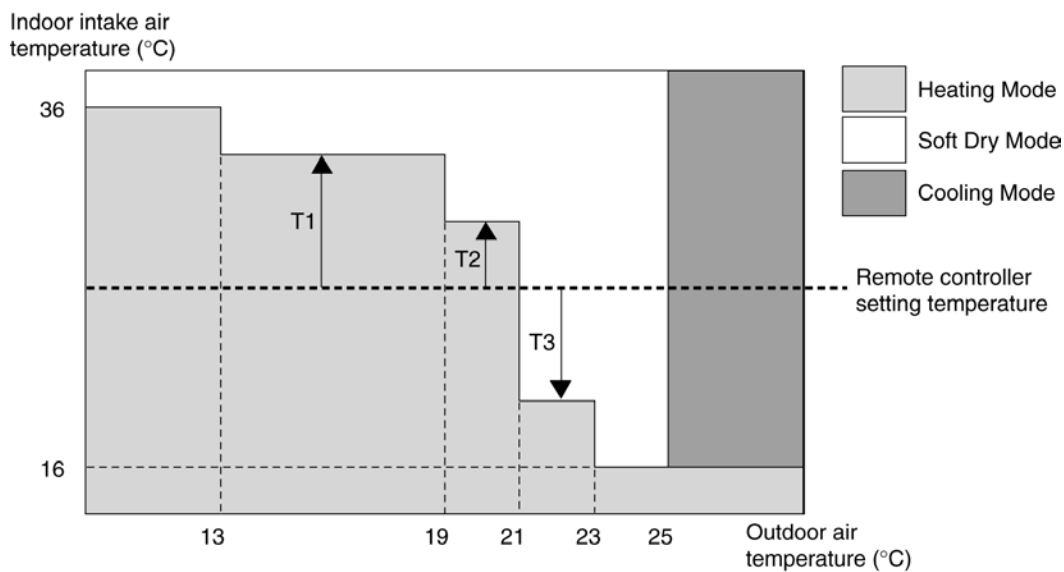

Values of T1, T2, and T3 depend on remote controller setting temperature, as shown in below table. After the adjustment of T1, T2 and T3 values, the operation mode for that particular environment and remote controller setting is judged and performed, based on the above operation mode chart, every 30 minutes. Heating mode operation will be performed, however, if deice operation is detected.

Remote Controller Setting Temperature (°C)	T1	T2	T3
16 ~ 18	+10	+8	-5
19 ~ 22	+8	+7	-7
23 ~ 26	+7	+6	-7
27 ~ 30	+6	+5	-8

There is a temperature shifting on T1, T2, and T3 if the operation mode judged is changed from Cooling/Soft Dry to Heating or vice verse.

Operation Mode change from	Temperature shifts (°C)
Cooling/Soft Dry → Heating	-2
Heating → Cooling/Soft Dry	+2

Example of operation mode chart adjustment:

From the above table, if remote controller setting temperature = 25,

T1 = 25 + 7 = 32; T2 = 25 + 6 = 31; T3 = 25 - 7 = 18

The operation mode chart for this example is as shown in below figure and the operation mode to be performed will depend on indoor intake air temperature and outdoor air temperature at the time when the judgment is made.

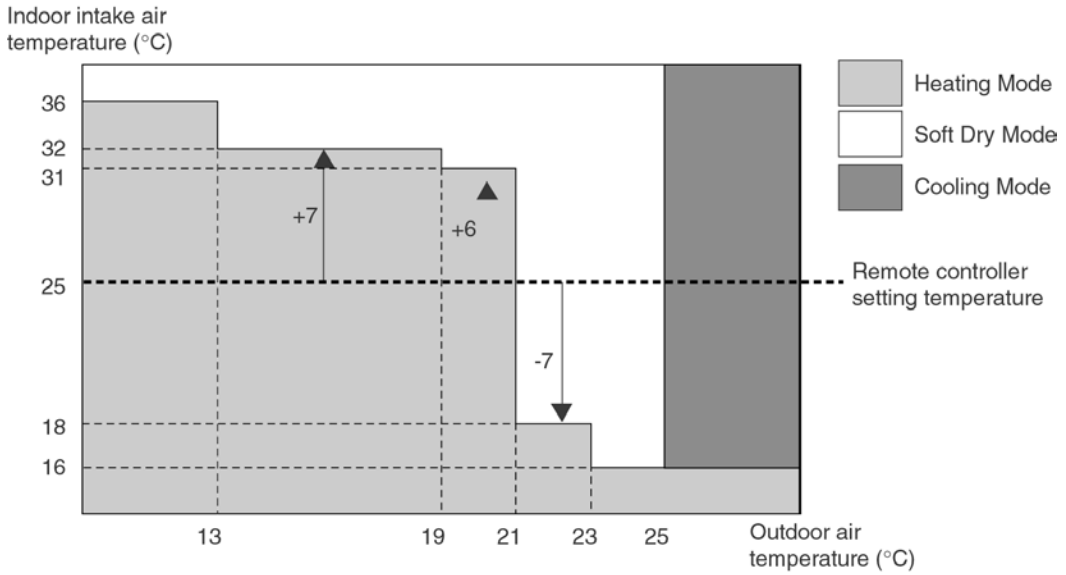

8.2. Protection Control Features

8.2.1. Delay ON Timer Control

This control is applicable to all kinds of operation mode.

Delay ON timer can be set using remote controller, the unit with timer set will start operate earlier than the setting time. This is to provide a comfortable environment when reaching the set ON time.

Seventy minutes before the set time, indoor (at fan speed of Lo-) and outdoor fan motor start operate for 20 seconds to determine the indoor intake air temperature and outdoor air temperature in order to judge the operation mode.

From the above judgment, the decided operation will start operate earlier than the set time as shown below.

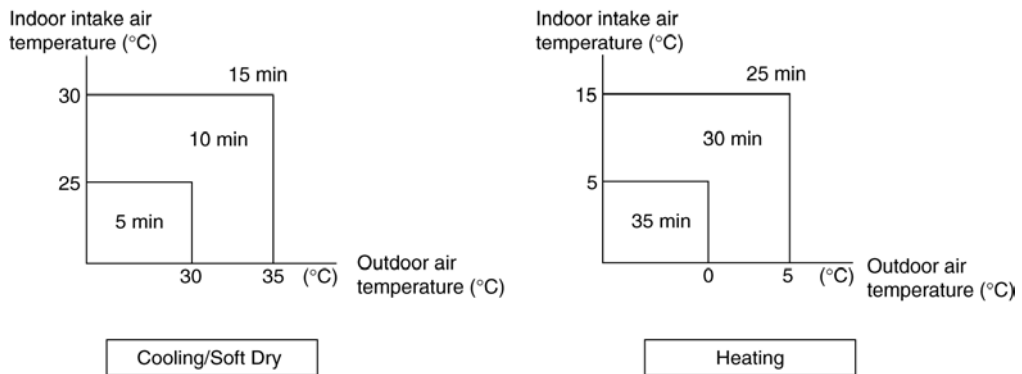

8.2.2. OFF Timer Control

This control is applicable to all kinds of operation mode.

OFF timer can be set using remote controller, the unit with timer set will stop operate at set time.

8.2.3. Indoor Power Relay Control

Power relay will turn on during operation or in progress of stopping operation. Although operation stops, the power relay continues on for three minutes.

However, during instantaneous power failure ($< 0.5s$), power relay will turn off. Then, it will turn on 3 minutes after power recover and the unit will operate as previous operation condition.

8.2.4. Time Delay Safety Control

This control is applicable to all kinds of operation mode.

1. The compressor will not start for three minutes after stop of operation.
2. This control is not applicable if the power supply is cut off and on again or after 4-way valve deices condition.

8.2.5. 30 Seconds Forced Operation

This control is applicable to all kinds of operation mode.

1. Once the compressor starts operation, it will not stop its operation for 30 seconds.
2. However, it can be stopped using remote control or Auto Switch at indoor unit.

8.2.6. Total Running Current Control

This control is applicable to all kinds of operation mode.

1. When the total outdoor unit running current (AC) exceeds X value, the frequency instructed for compressor operation will be decreased a step to smaller frequency number.
2. If the running current does not exceed X value for five seconds, the frequency instructed will be increased a step at one time to bigger frequency number.
3. However, if total outdoor unit running current exceeds Y value, compressor will be stopped immediately for three minutes.

Operation Mode	E9CKP		E12CKP/E15CKP	
	X (A)	Y (A)	X (A)	Y (A)
Cooling/Soft Dry (I)	4.5	17.0	6.5	17.0
Cooling/Soft Dry (II)	4.0	17.0	6.0	17.0
Heating	6.1	17.0	9.2	17.0

4. The first 30 minutes of cooling operation, (I) will be applied.

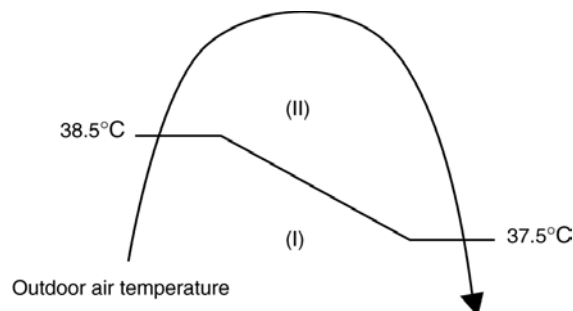

8.2.7. IPM (Power transistor) Prevention Control

This control is applicable to all kinds of operation mode.

A. DC Peak Current Control

1. When electric current to IPM exceeds set value of 22.5 ± 3.5 A, the compressor will stop operate. Then, operation will restart after three minutes.
2. If the set value is exceeded again within 30 seconds after the compressor starts, the operation will restart after one minute. If this condition repeats continuously for seven times, all indoor and outdoor relays will be cut off.

B. Overheating Prevention Control

1. When the IPM temperature rises to 110°C , compressor operation will stop immediately.
2. Compressor operation restarts after three minutes the temperature decreases to 95°C .

8.2.8. Compressor Overheating Prevention Control

This control is applicable to all kinds of operation mode.

Instructed frequency for compressor operation will be regulated by compressor discharge temperature. The changes of frequency are as below figure.

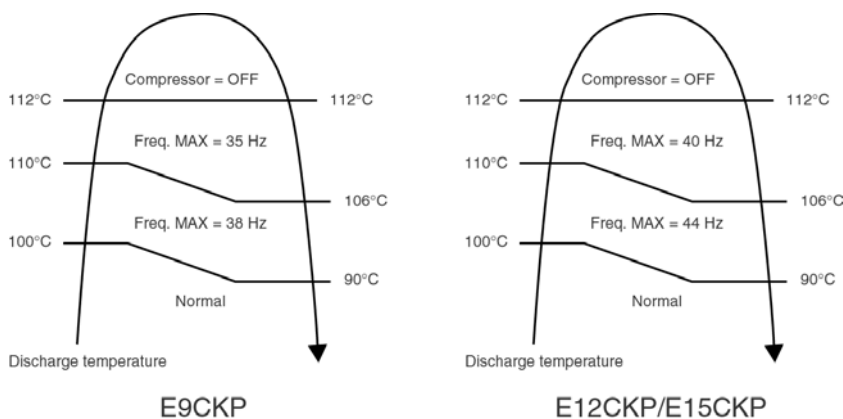

8.2.9. Low Pressure Control (Gas Leakage Detection)

This control is applicable to all kinds of operation mode.

1. When the conditions listed in below table occur, the compressor stops and restarts after three minutes.
2. If this phenomenon is continuously occurring for twice within 20 minutes, all indoor and outdoor relays will be cut off.
3. This control is not applicable for deice operation.

Conditions	E9CKP		E12CKP/E15CKP	
	Cooling/Soft Dry	Heating	Cooling/Soft Dry	Heating
1. Compressor frequency (Hz)	≥ 47	≥ 56	≥ 67	≥ 68.5
2. Outdoor total running current (A)	< 1.21	< 1.21	< 1.21	< 1.21
3. Indoor heat exchanger temperature	> 25	< 25	> 25	< 25

Note: Conditions 1 and 2 needed to be happened continuously for 5 minutes.

8.2.10. Minimum Operation Frequency Protection Control

This control is applicable to all kinds of operation mode.

When the compressor operate at frequency lower than 26 Hz (E9CKP) or 28 Hz (E12CKP/E15CKP) for 240 minutes, the operation frequency will be increased to 26 Hz (E9CKP) or 28 Hz (E12CKP/E15CKP) for two minutes.

8.2.11. Low Operation Frequency Protection Control

This control is applicable to all kinds of operation mode.

When all the below conditions occur, minimum value (Freq. MIN) for the frequency instructed to compressor will change to 30 Hz (E9CKP) and 32 Hz (E12CKP/E15CKP) for cooling mode operation, and 21 Hz (E9CKP & E12CKP/E15CKP) for heating mode operation.

Temperature, T, for:	Cooling/Soft Dry	Heating
Indoor intake air (°C)	$T < 15$ or $T \geq 30$	—
Outdoor air (°C)	$T < 16$ or $T \geq 38$	$T < 4$ or $T \geq 24$
Indoor heat exchanger (°C)	$T < 30$	$T \geq 0$

8.2.12. Auto Restart Control

This control is applicable to all kinds of operation mode.

1. When the power supply is cut off during the operation of air conditioner, the compressor will re-operate within three to four minutes (there are 10 patterns between 2 minutes 58 seconds and 3 minutes 52 seconds to be selected randomly) after power supply resumes.
2. This type of control is not applicable during ON/OFF Timer setting.

8.2.13. Outdoor Air Temperature Control

1. For Cooling Mode and Soft Dry Mode operation, the compressor operating frequency is regulated in accordance to the outdoor air temperature as shown in the diagram below. This control will begin one minute after the compressor starts.

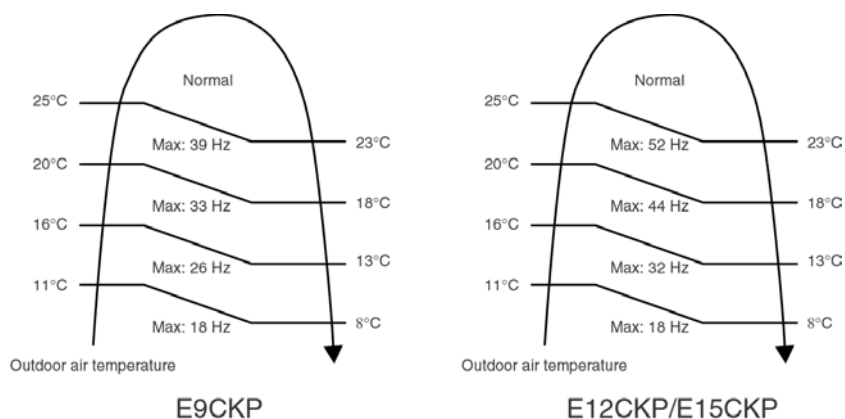

2. For Heating Mode operation, the compressor operating frequency is regulated in accordance to outdoor air temperature as shown in the below figures. This control will begin 50 seconds after the compressor starts.

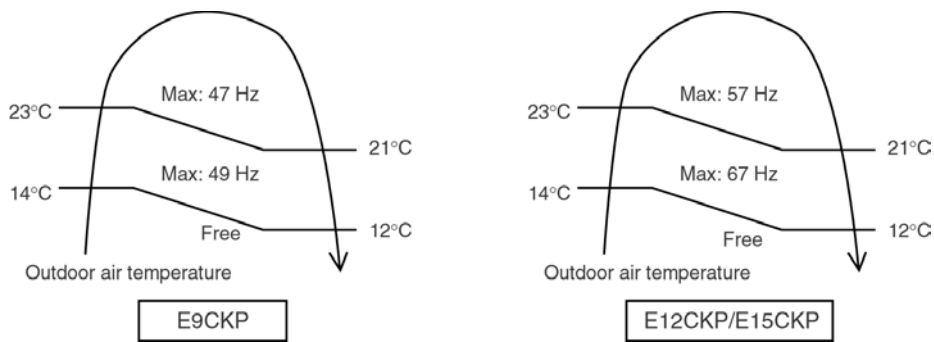

8.2.14. Deodorizing Control

This type of control is applicable on Cooling Mode and Soft Dry Mode operation only.

1. During cooling or soft dry operation with automatic fan speed, the unit will operate as state below for deodorizing purpose.

Step No.	1	2	3	4	5	4, 5, 4, 5...	1
Compressor status	ON			OFF			ON
Period (sec)	40	50	...	20	90	40
Indoor fan speed	OFF	SLo	Note*	SLo	OFF	OFF

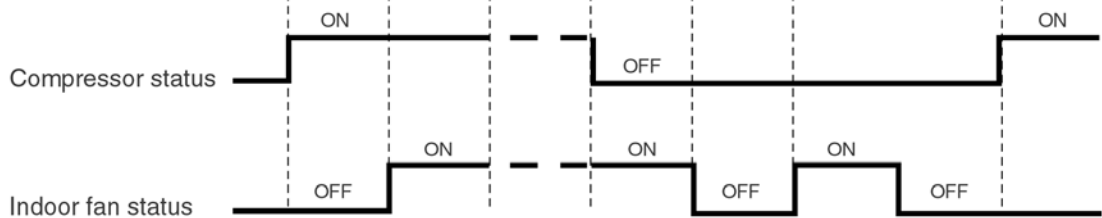

Note*: Fan speed is automatic for cooling mode and SLo for soft dry mode.

2. When compressor is in operation, the steps follow: 1 → 2 → 3.

3. When compressor stops operation, the steps follow: 4 → 5 → 4 → 5

4. If the compressor still stops operation after three minutes, the step will start from 4.

5. This control is not applicable during sleep shift operation, ON timer preparation and anti-freezing control.

8.2.15. High Pressure at Minimum Frequency Control

This type of control is applicable on Cooling Mode and Soft Dry Mode operation only.

1. When outdoor air temperature increases to 38.6°C, compressor operating frequency reduces to minimum of 30 Hz and 32 Hz for E9CKP and E12CKP/E15CKP respectively.
2. Compressor operating frequency will resume to normal when outdoor air temperature decrease to 37.8°C.

8.2.16. Anti-Freezing Control

This type of control is applicable on Cooling Mode and Soft Dry Mode operation only.

1. When indoor heat exchanger temperature is lower than 2°C continuously for six minutes, compressor will stop operating.
2. Compressor will resume its operation three minutes after the indoor heat exchanger is higher than 10°C.
3. At the same time, indoor fan speed increase its frequency as value of two steps up in Fan Speed Number compared to its normal operation. (Refer Table on Fan Speed Level and Supplied Voltage).
4. If indoor heat exchanger temperature is higher than 10°C for five minutes, the fan speed will return to its normal operation.

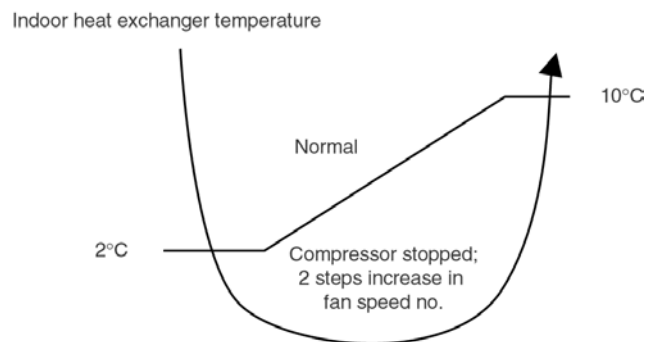

8.2.17. Anti-Fog Discharge Control

This type of control is applicable on Cooling Mode and Soft Dry Mode operation only.

1. When indoor fan speed is set at Me- or slower, the compressor operating frequency is regulated by operation time to prevent fog discharged from indoor as shown in below table.

Operation time, T (min)	E9CKP	E12CKP/E15CKP
$0 < T \leq 30$	Max 33 Hz	Max 44 Hz
$30 < T \leq 90$	Max 26 Hz	Max 36 Hz
$90 < T \leq 420$	Max 26 Hz	Max 36 Hz

2. After 420 minutes, the operation restarts again from the beginning.
3. The operation will restart the above control whenever remote controller setting temperature or fan speed setting is changed.

8.2.18. Indoor Heat Exchanger Temperature Control

This control is applicable for Heating Mode operation only.

The compressor operating frequency is regulated in accordance to indoor heat exchanger temperature as shown in below figures.

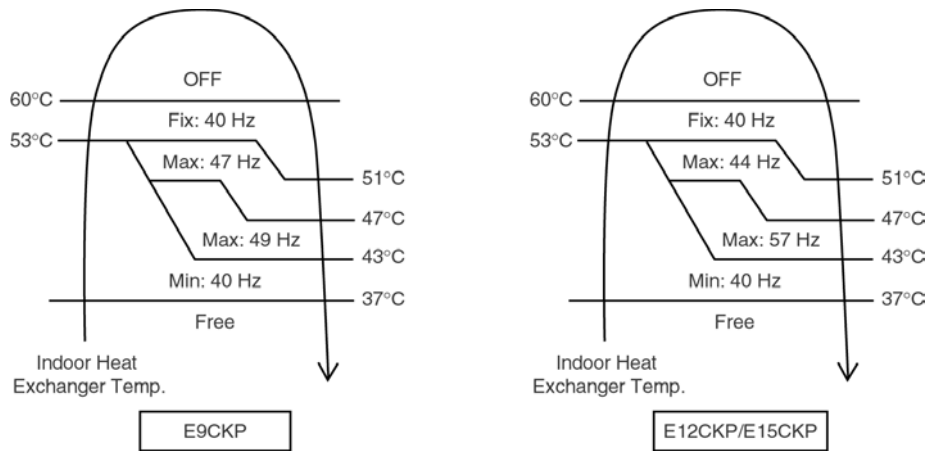

8.2.19. Intake Air Temperature Control

This control is applicable for Heating Mode operation only.

Compressor will operate at maximum of 56 Hz or 68.5 Hz for E9CKP and E12CKP/E15CKP respectively if either one of the below conditions occur:

1. When the intake air temperature is 10°C or above and remote controller setting fan speed is Lo or lower.
2. When the intake air temperature is 30°C or above.

8.2.20. Deice Operation Control

This control is applicable for Heating Mode operation only.

Deice operation occurs when the deice operation starting signal is generated. This happens when one of the following condition occurs. However, the first deice operation will begin one hour after the start of heating mode operation.

Condition	Outdoor heat exchanger temp. $T_h < 3^\circ\text{C}$	In between, for 3 minutes, outdoor heat exchanger temp. T_h	Provided, compressor is ON and outdoor air temp. T_o
1	For 120 minutes	$< -6^\circ\text{C}$	$> -1^\circ\text{C}$
2	For 80 minutes	$< -7^\circ\text{C}$	$> -1^\circ\text{C}$
3	For 40 minutes	$< -9^\circ\text{C}$	$\geq -3^\circ\text{C}$
4	For 40 minutes	$< -11^\circ\text{C}$	$> -3^\circ\text{C}$

Once the deice operation signal produced, the instructed frequency for the operation of compressor will be set to zero hertz (0 Hz) for 30 seconds. Then, deice operation starts with both indoor and outdoor fan motor, and 4-way valve turn off for 30 seconds. The compressor operates following the frequency as shown in below chart that depending on outdoor heat exchanger temperature and operation period, with a maximum of 10 minutes and 30 seconds. When the deice operation ends, before back to normal operation, the instructed frequency for compressor will be set to zero hertz (0 Hz) again and outdoor fan motor will turn on for a period of 59 seconds.

Deice Operation Chart

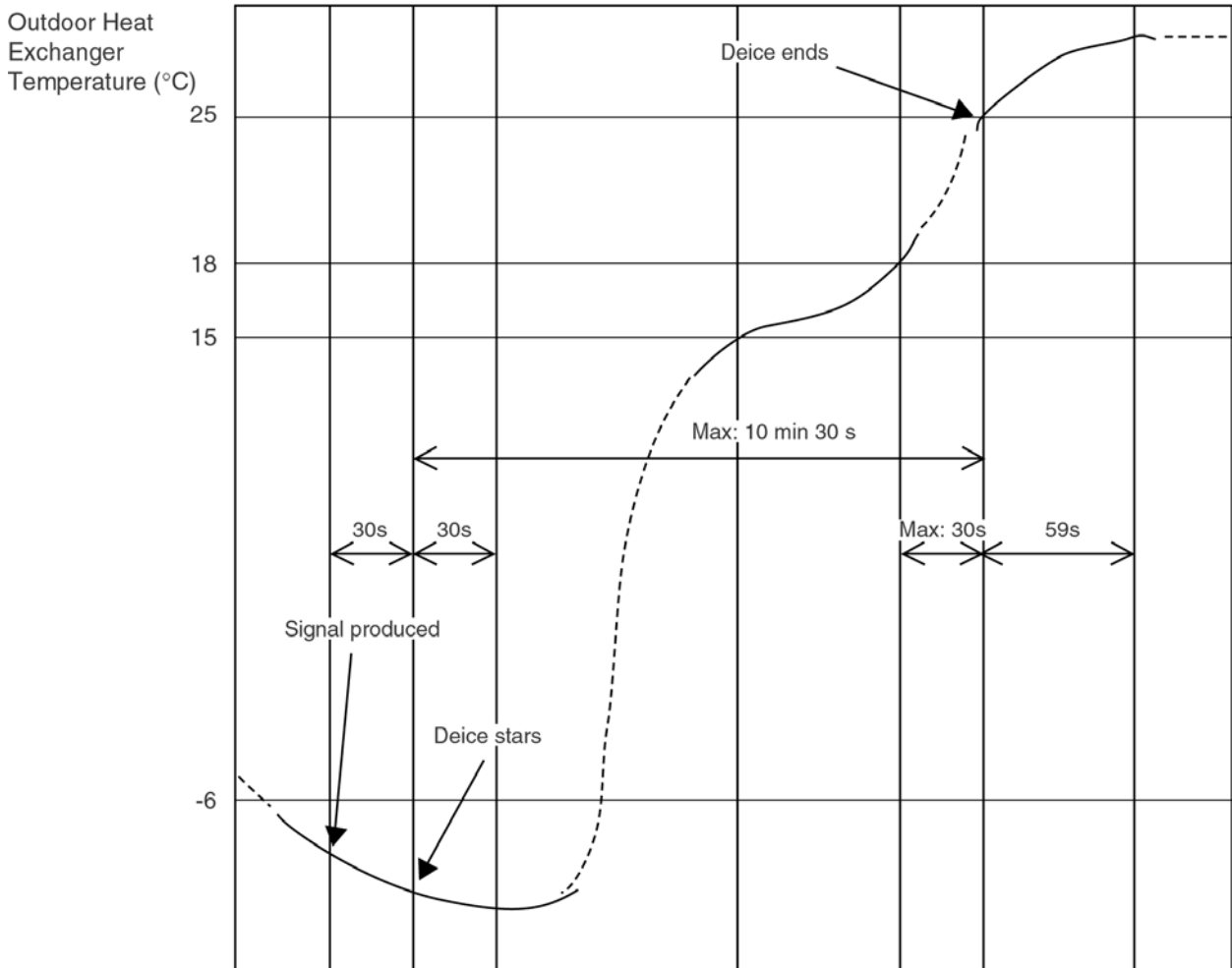

Freq. (Hz)	E9CKP	Free	0	47	58	35	35	0	Free
	E12CKP/ E15CKP	Free	0	62	67	40	40	0	Free
Indoor fan motor		Free	Free	OFF	OFF	OFF	OFF	OFF	Free
Outdoor fan motor		ON	ON	OFF	OFF	OFF	OFF	ON	ON
4-way valve		ON	ON	OFF	OFF	OFF	OFF	OFF	ON

8.2.21. Auto Clean Deice Control

This control is applicable for Heating Mode operation only and before operation starting time set by ON Timer control to improve heating start-up operation if residual ice on outdoor heat exchanger detected.

Fifteen minutes before Standby operation, pre-deice heating operation will be performed to determine the operation decision as shown in below figure. Auto Clean Deice operation starts to operate as soon as the pre-deice operation if all the below conditions occur.

- (a) Outdoor air temperature $\leq 0^{\circ}\text{C}$,
- (b) Outdoor heat exchanger temperature $< 0^{\circ}\text{C}$ for 14 minutes, and
- (c) Outdoor heat exchanger temperature $< -8^{\circ}\text{C}$ for 10 minutes.

The Auto Clean Deice is operated for a maximum of 12 minutes as normal Deice operation, and the period of Standby operation is maintained including the 12-minute Auto Clean Deice operation.

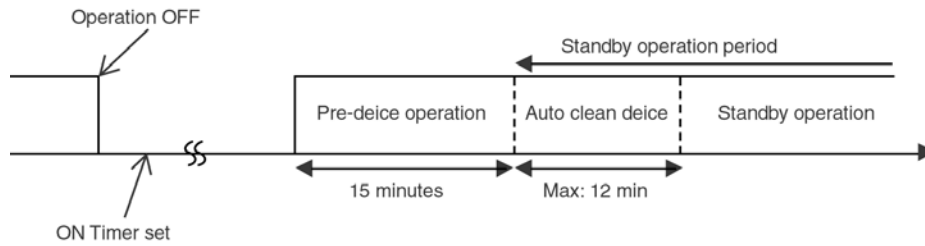

8.2.22. Indication Panel



Led	POWER MONITOR	POWER	QUIET	TIMER	POWERFUL	ION
Color	Green	Green	Orange	Orange	Orange	Green
Light ON	Operation ON	Operation ON	Quiet Mode ON	Timer Setting ON	Powerful Mode ON	Ion Mode ON
Light OFF	Operation OFF	Operation OFF	Quiet Mode OFF	Timer Setting OFF	Powerful Mode OFF	Ion Mode OFF

Note:

- If POWER LED is blinking, the possible operations of the unit are Hot Start, during Deice operation, operation mode judgment, or delay ON timer sampling.
- If Timer LED is blinking, there is an abnormality operation occurs.

LED Control Frequency

Lighting of 3 LED base on instructed running frequency from indoor unit to compressor at cool, dry & heating operation.

Position of LED	☀️•••••C	☀️•••☀️•••C	☀️•••☀️•••☀️
Cool, Dry Instructed Hz No	1 ~ 6	7 ~ 12	Fc ~ Fc max
Heat Instructed Hz No	1 ~ 7	8 ~ 16	Fh above
Ion only operation	—	—	—

8.2.23. Auto Operation Switch

Number of "beep":	1	2	3	4
Function:	Auto Operation	Forced Cool	Forced Heat	Various Setting Mode
Duration (s):	0	5	8	11
				16
				21

1. When the switch is pressed between 0 to 5 seconds, Auto Mode operation starts to function.
2. When the switch is pressed between 5 to 8 seconds, the unit is forced to operate in Cooling Mode.
3. When the switch is pressed between 8 to 11 seconds, the unit is forced to operate in Heating Mode.
4. When the switch is pressed between 11 to 16 seconds and together with the signal from remote control, the unit can be changed to different controlling setting (A-B mode).
5. When the switch is pressed between 16 to 21 seconds, either "H14" error detection selection mode or the remote controller's signal receiving sound can be cancelled or turned on.

8.2.24. Quiet operation (Cooling Mode/Cooling area of Dry Mode)

A. Basic Policy

- There shall be some difference between actual listening of normal operation & quiet operation.
For Hi & Me, Sound level at quiet operation is set -3dB vs normal operation.
- For Lo Cool, if fan speed of quiet Lo is too low, refrigerant sound become obvious, therefore sound level of Quiet Lo is set -2dB vs Lo Cool.
- For Lo Heat, to prevent compressor overload, fan speed is not set too low, sound level at quiet Lo operation is set -2dB vs normal Lo operation.

B. Purpose

To provide quiet cooling operation compare to normal operation.

C. Control condition

- Quiet operation start condition
 - When "quiet" button at remote is pressed.
Quiet LED illuminates.
- Quiet operation stop condition
 - When one of the following conditions is satisfied, quiet operation stops:
 - Quiet powerful, button is pressed.
 - Stop by OFF/ON switch.
 - Timer "off" activates.
 - When change mode to fan only mode.
 - When quiet operation is stopped, operation is shifted to normal operation with previous setting.
Quiet LED off.
 - When fan speed is changed, quiet operation is shifted to quiet operation of the new fan speed.
 - When operation mode is changed, quiet operation is shifted to quiet operation of the new mode, except fan only mode.
 - During quiet operation, if timer "on" activates, quiet operation maintains.
 - After off, when on back, quiet operation is not memorised.

D. Control contents

a. Air flow volume manual

- Fan speed is changed from normal setting to quiet setting of respective fan speed.
This is to reduce sound of Hi & Me for 3dB & Lo for 2dB.
- Quiet setting of fan speed is as shown in the following table. (Cool and fan mode)

	E9CKP	E12CKP/E15CKP
RPM	1.0 HP	1.5 HP
Quiet Hi	Hi-100	Hi-100
Quiet Me	Me-100	Me-100
Quiet Lo	Lo-100	Lo-100

b. Air flow volume Auto

- Odor cut control at normal operation, except selected fan speed is the quiet setting of the respective speed.

Normal Operation

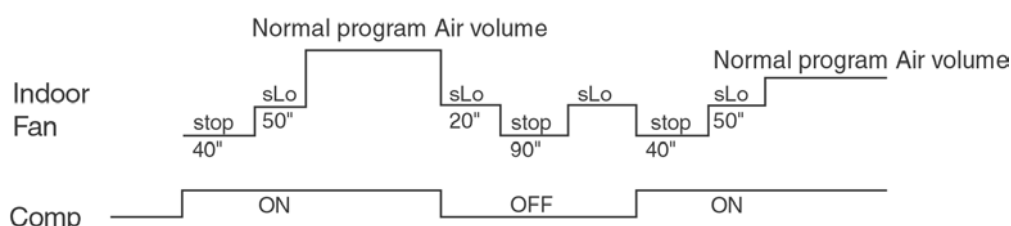

Quiet Operation

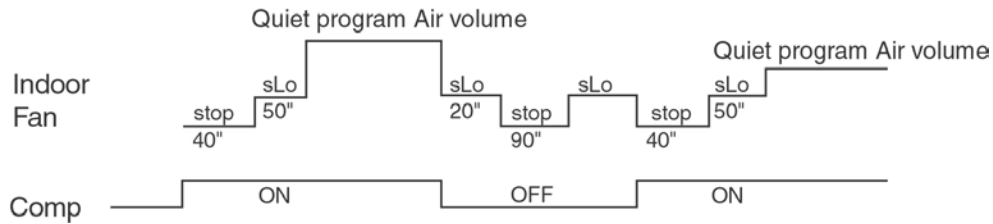

8.2.25. Quiet operation under Soft Dry operation (Dry area at Dry Mode)

Manual and Air Volume automatic (Normal operation)

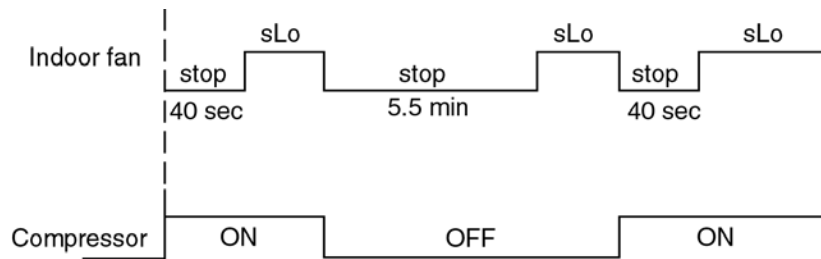

8.2.26. Quiet operation (Heating)

A. Purpose

To provide quiet heating operation compare to normal operation.

B. Control condition

a. Quiet operation start condition

- When "quiet" button at remocon is pressed.
Quiet LED illuminates.

b. Quiet operation stop condition

1. When one of the following conditions is satisfied, quiet operation stops:

- a. Quiet & Powerful button is pressed.
- b. Stop by OFF/ON switch.
- c. Timer "off" activates.
- d. When change mode to fan only mode.

2. When quiet operation is stopped, operation is shifted to normal operation with previous setting.

Quiet LED off.

3. When fan speed is changed, quiet operation is shifted to quiet operation of the new fan speed.

4. When operation mode is changed, quiet operation is shifted to quiet operation of the new mode, except fan only mode.

5. During quiet operation, if timer "on" activates, quiet operation maintains.

6. After off, when on back, quiet operation is not memorised.

C. Control contents

a. Air flow volume manual

1. Fan speed is changed from normal setting to quiet setting of respective fan speed.

This is to reduce sound of Hi & Me for 3dB & Lo for 2dB.

2. Quiet setting of fan speed is as shown in the following table.

	E9CKP	E12CKP/E15CKP
Quiet Hi	SHi-100	SHi-100
Quiet Me	Me-100	Me-100
Quiet Lo	HLo-100	HLo-100

b. Air flow volume Auto

- If $FM \geq Lo$

-100rpm shift

- If $FM < Lo$

maintain RPM

Indoor FM RPM depends on pipe temp sensor of indoor heat exchanger.

8.3. Ionizer Operation

Purpose

To provide fresh air effect to user by producing minus ion in discharge air.

Control Condition

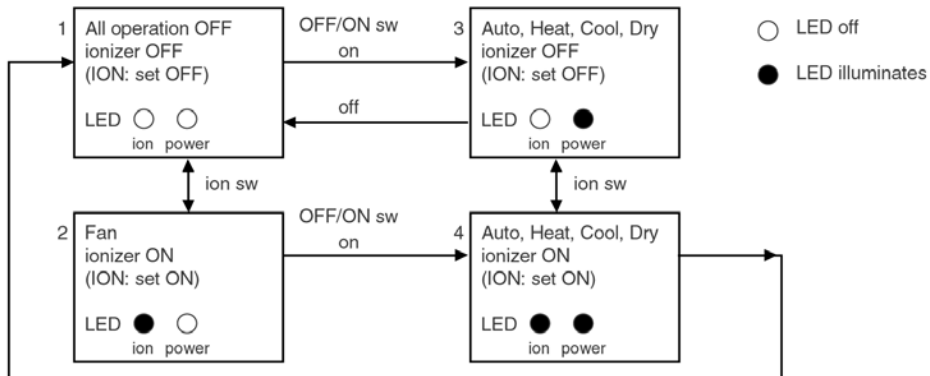

a. Ionizer Only Operation.

1. When air-conditioner unit is at “OFF” condition (standby) and ION operation button at remocon is pressed.

Fan & ionizer on, ION LED illuminates, but power LED maintain off. (1 → 2)

However, fan speed can be adjusted later by customer during this operation.

Fan speed	
manual	Remocon set fan tap
Auto	between A ~ C at the pattern shown below

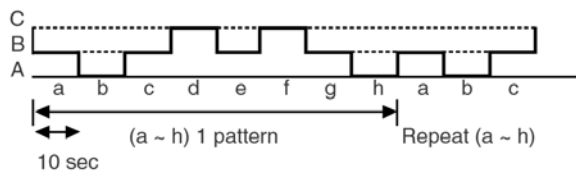

Air flow direction (Horizontal Vane) control:

Follow vane direction control at cooling mode.

Horizontal vane can be changed by customer during ion only operation.

2. Ion only operation can be off by pressed ION button again. (2 → 1)
3. It can be changed to remote setting mode (Auto, Heat, Cool, Dry, Fan) + ion operation by OFF/ON switch. (2 → 4)
4. During ion only operation, if power failure occur, after power resume, ionizer & air-conditioner resumes immediately.
5. After error = 24 times, (about 4h), ion & fan off with Ion LED blinks continuously.
(Detail refer to Ionizer Error detection control.)

b. Operation Mode + Ionizer Operation.

1. Ionising Operation Start Condition

When air-conditioner unit is in "ON" condition (Heat, Cool, Dry, Auto mode) and ION operation button at remote controller is pressed. Ionizer on & ION LED illuminates. (3 → 4)

Power LED also illuminates.

2. Ionising Operation Stop Condition

When one of the following condition is satisfied, ION operation stops.

- a. Stopped by ON/OFF switch.
- b. Timer OFF activates.
- c. ION operation button is pressed again.
- d. ION feedback signal shows error.

3. Ionizer operation status is not memorised after off. After OFF, when operation is "ON" again, air-conditioner operates without ionizer operation.

However, during Cool mode etc. + ionizer operation, if there is a power failure & then power resume, A/con shall on at that mode + ionizer operation.

c. Timer during ionizer operation

Refer to case study in next page for detail.

8.3.1. Ionizer Operation case study

Case 1a: Ionizer only operation (24h real time timer ON)

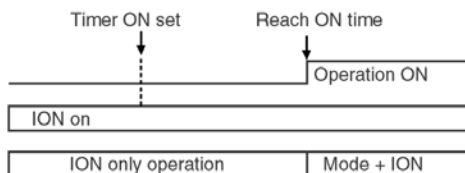

Case 1b: Ionizer only operation (24h real time timer OFF)



Case 2a: Operation Mode + Ionizer (24h real time timer ON)

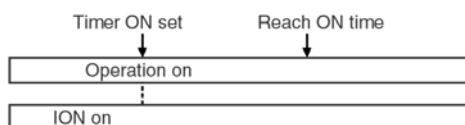

Case 2b: Operation Mode + Ionizer (24h real time timer OFF)

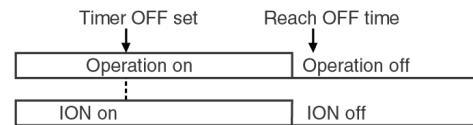

Case 3a: Ionizer only operation (24h real time timer ON)

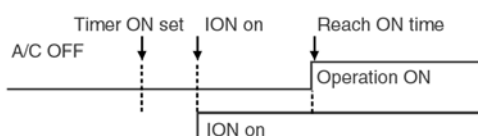

Case 3b: Ionizer only operation (24h real time timer OFF)

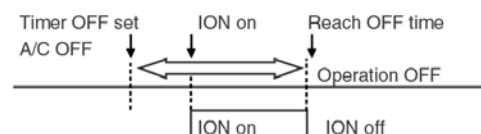

Case 4b: Ionizer only operation (24h real time timer ON)

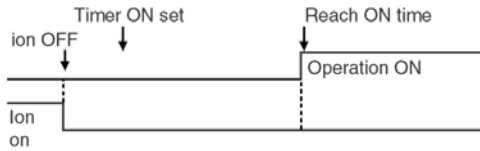

Case 5b: Operation Mode + Ionizer (24h real time timer ON)

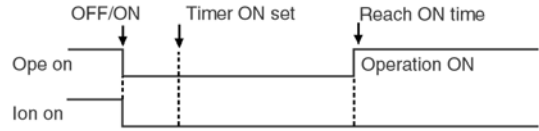

Case 6: Ionizer only operation (Auto Fan) & shift to Cool Mode

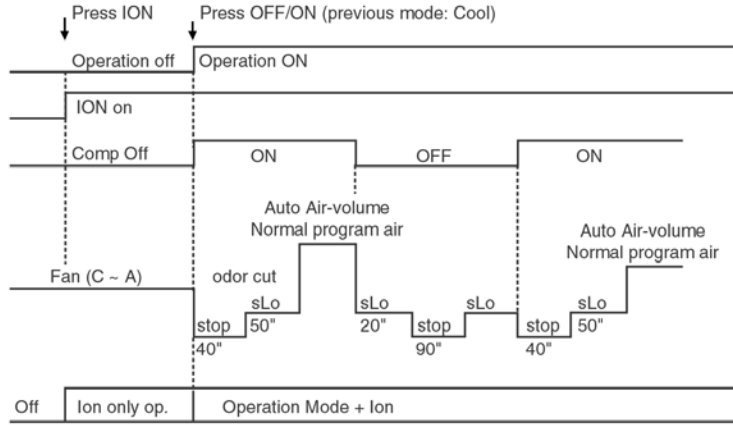

OUTPUT

Ionizer stand alone ON/OFF & protection control

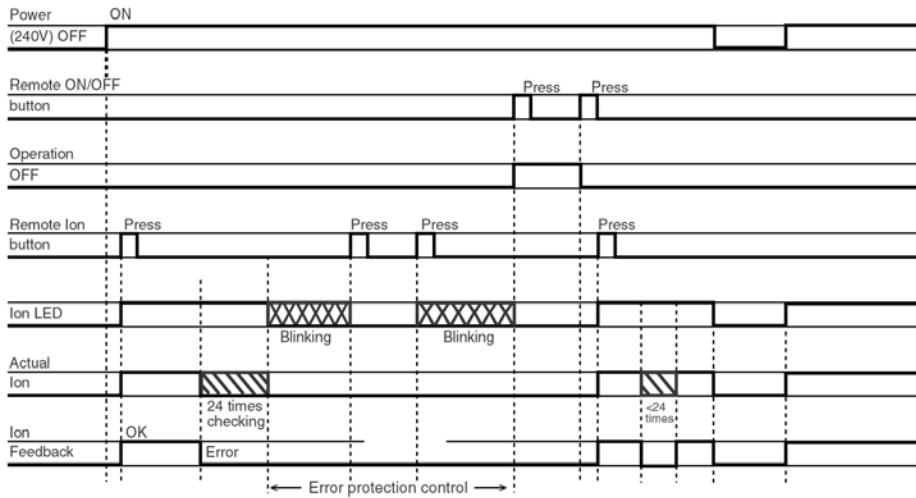

Ionizer + mode ON/OFF & protection control:

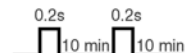
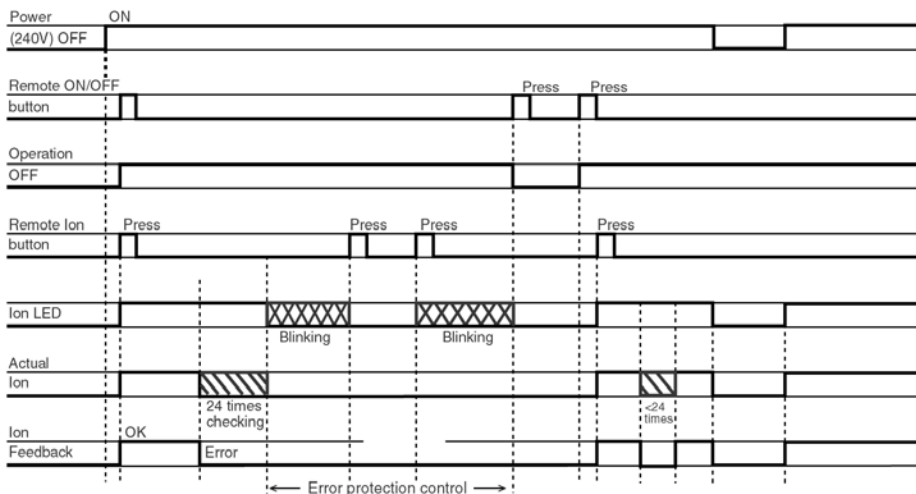

Note:

1. 24 times checking: Actual Ion ON for 10s & OFF for 10 min. continuously for 24 times.
2. 24 times count will be cleared when following conditions happen.
 - a) 24 times count over, b) Ionizer cancel if press Ion button or power reset, c) Ion f/b sgml OK.
3. Error protection will be cleared when following conditions happen.
 - a) Power reset, b) Remocon operation ON/OFF button press, c) Forcible operation press, d) Opt OFF due to Timer OFF
4. Ion auto restart: Ion will auto restart if Actual Ion was ON with no error protection control before power shutdown. Otherwise Ion will not auto restart.

OUTPUT

Ion breakdown protection control: (Only during Actual Ion OFF)

Case 1: Operation OFF & Ionizer OFF

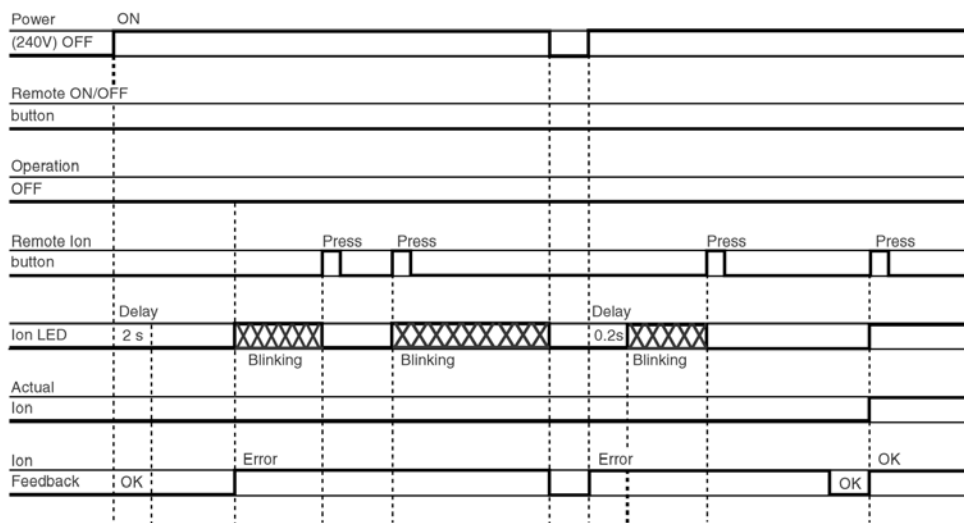

Case 2: Operation ON & Ionizer OFF

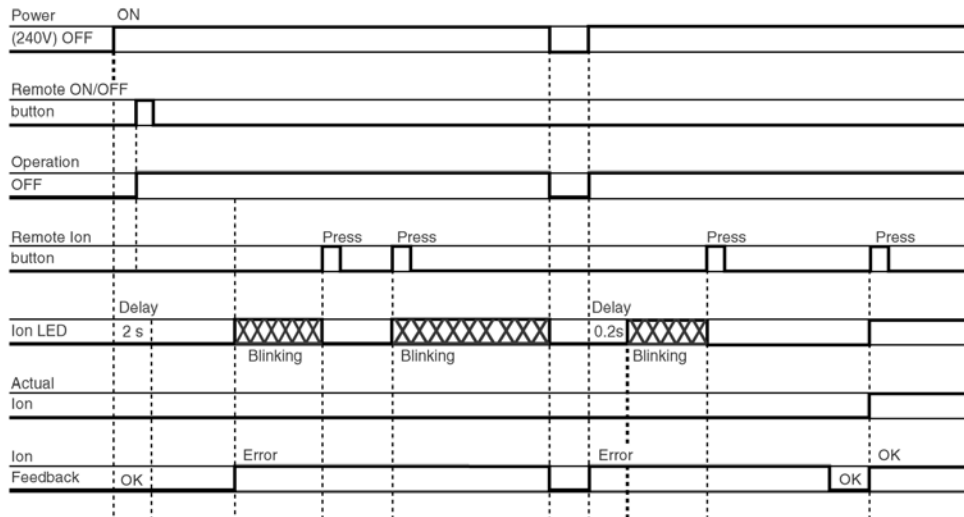

9 Operating Instructions

1 PRODUCT OVERVIEW

Your device can...



COOL
Cooling



HEAT
Heating







DRY
Dehumidifying

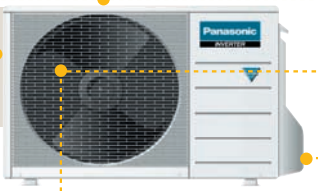

FAN
Air circulation

1.1 Outdoor Unit



-  Air intake
-  Air outlet
-  Piping, connecting cable

1.2 Indoor Unit

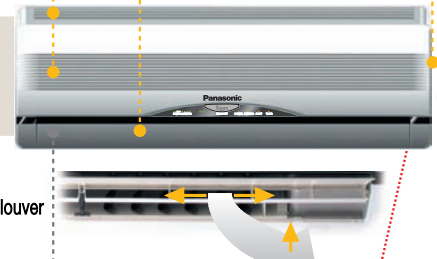

Filters under front panel, see page 41

Indicator & Auto operation button

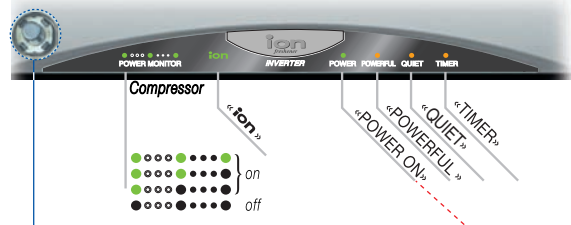

Compressor

"ion"

"POWERFUL"

"QUIET"

"TIMER"

"POWER ON"

● on

● off

! Under front panel

1.3 Remote Control

Fluorescent lights may interfere with signal transmission

0 - 10 m

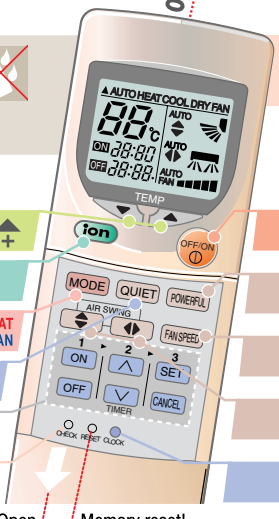

see page

39	Set TEMPERATURE	Switch OFF/ON of the device
40	Activate «ion»	Very fast cooling/heating 40
39	Select MODE	Select Fan speed 40
40	Activate «QUIET»	Select air flow direction 40
40	TIMER functions	
43	Check Malfunction code	Set CLOCK 42

Open

Memory reset!

If Remote Control malfunctions / is misplaced...

- 1 Open front panel
- 2 Press to START >>
- 3 Press again to STOP >>

Find on page

OPERATION

START

Switch on

Press button



AUTO

Automatic

Select...

min. 16 °C
max. 30 °C



Based on the outdoor, indoor and setting temperature, the system automatically chooses.

COOL
DRY
HEAT

HEAT

Heating

Select...

min. 16 °C
max. 30 °C

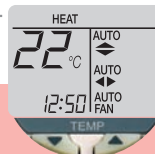

Choose the right temperature to be comfortably warm!

Recommended: **-20...24 °C**

COOL

Cooling

Select...

min. 16 °C
max. 30 °C

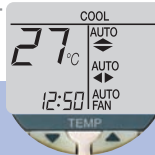

Choose the right temperature to be comfortably cool!

Recommended: **-26...28 °C**

DRY

Dehumidifying

Select...

min. 16 °C
max. 30 °C



Very gentle cooling and dehumidifying operation.

Recommended: Room temperature **-(1~2)°C**

FAN

Air circulation

Select...

min. 16 °C
max. 30 °C



Fan operation, to circulate air in the room

STOP

Switch off



Function

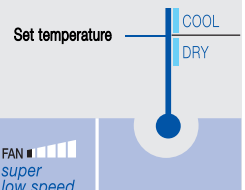
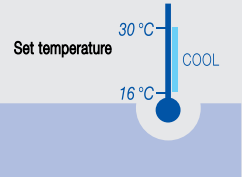
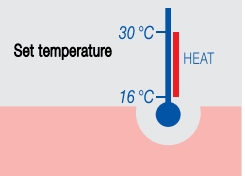
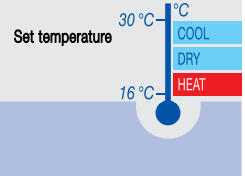

automatic during dehumidifying

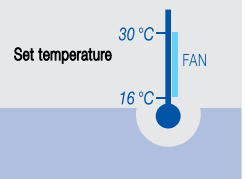

Additional comfort

42



PREPARATIONS

43



TROUBLE-SHOOTING

44



SAFETY PRECAUTIONS

41



HELPFUL INFORMATION

Press button

Air Flow

Direction / volume
Select automatic/manual

Vertical direction
Horizontal direction
Fan speed (air volume)

● Air still cold
● Air heated

TIMER Operation

Function... ON-Timer OFF-Timer
Select... Function Time Confirm/cancel
ON/OFF Timers: Active every day

Time OK? -> Setting: page 42
Start before «ON» time
Max 35 Min For your comfort

QUIET Operation

Provide quiet operation
Air flow sound will reduce during operation
3dB

IONIZER

Produce negative ion for fresh air

ON/OFF Activate / Deactivate

ON Provide negative ion during operation
OFF Provide negative ion with FAN operation

If Blinking -> Still Blinking - Call Service
press twice

POWERFUL

Activate / Deactivate

Function

Set temperature: + (3.5 °C) HEAT, - (1 °C) DRY, - (2 °C) COOL
Fan speed (air volume): Super high
Start 20 min.

CARE & CLEANING

Indoor unit



Wipe gently 40°C max.

Filters * **

Soaps Household detergents

Benzine / Thinner Scouring powder

Front Panel



Remove 40°C max. Wash gently... + dry 1 2 Reinstall

Ionizer

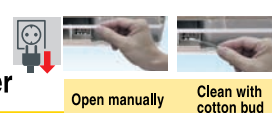

Open manually Clean with cotton bud

Purifying filters

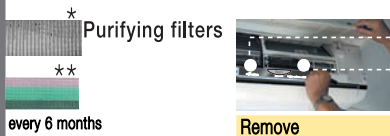

every 6 months * **

Remove Vacuum refresh 6 hrs Part No. CZ-SF70P CZ-SFD72P REPLACE every 3 years Expose to direct sunlight ? Reinstall

Damaged -> replace



Air filters

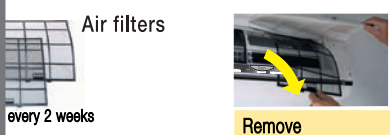

every 2 weeks

Remove Vacuum 40°C max. Wash Dry ? Part No. CWD 001047 Reinstall

Damaged -> replace



* Catechin ** Triple Deodorizing Filter

! DIRTY FILTERS cause: unpurified air, low cooling / heating capacity, more unpleasant smells, higher energy consumption!

HELPFUL INFORMATION

Automatic Operation

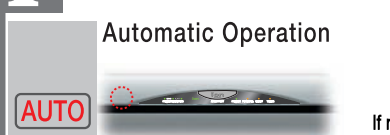

AUTO

If remote control malfunctions/ is misplaced see page 38

Thunder/Lightning



Built-in surge protection, BUT UNPLUG in case of very strong lightning!

Save cost

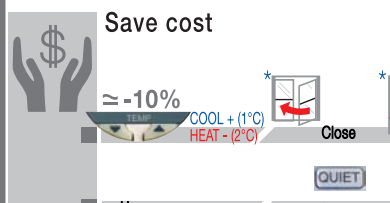

≈ -10% COOL + (1°C) HEAT - (2°C) Close Vacuum * Better performance

Use... QUIET! TIMER! see page 40

Power Failure

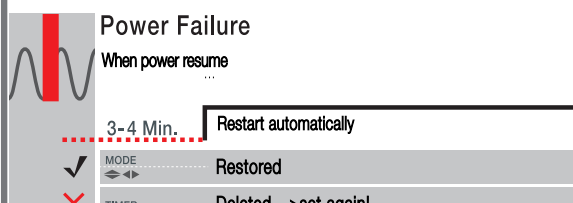

When power resume ...

3-4 Min. Restart automatically

MODE Restored

TIMER Deleted ->set again!

PREPARATIONS

Installation: see enclosed installation instruction!

Press button

Plug/breaker

refer page 45

OPEN front Panel → Remove AIR filters → Place PURIFYING filters → Place AIR filters → CLOSE front Panel

Indoor unit

Insert batteries

Set clock

Use ~1 Year

Same type! Rechargeable → Open/remove → Insert batteries/close → Press → Set time → Set current time immediately → Confirm

Pre-season inspection

check

1. Fans obstructed? → 2. Batteries OK? → START cooling or heating → ~15 Min. → Check performance → 8°C (COOL) / 14°C (HEAT) → Call Service

For extended non-operation

START → dry internal parts → 2-3[h] → OFF → Unplug → Remove batteries

Recommended Inspections

- ▶ After several seasons and due to operational conditions, performance may be reduced by dust or there may be unpleasant smells.
- ▶ Consult an authorized distributor for inspection!

42

TRUBLESHOOTING



OK?

✓ No problem

- 1 It sounds like water flowing... ▶ Caused by refrigerant flow inside ✓
- 2 Mist seems to emerge from the indoor unit ▶ Condensation effect due to cooling ✓
- 3 Outdoor unit emits water/steam ▶ Condensed moisture due to defrosting ✓
- 4 Delayed air discharging ▶ At COOL SOFT DRY (Auto Fan Speed): Prevent odors smell from blowing out ✓
▶ At HEAT (POWER LED flashes): Prevent cold air from blowing out ✓
- 5 Function stops suddenly ▶ At COOL SOFT DRY (Auto Fan Speed): Function interruptions to the internal temp measurement ✓
▶ At HEAT (POWER LED flashes): Iced up outer device is defrosted (approx. 10 min.) ✓



- 1 Remote control/display doesn't work ▶ Batteries empty? ▶ Batteries correctly inserted? See page 42
- 2 No Operation ▶ Circuit breaker tripped? ▶ Power plug OK? ▶ TIMER used correctly?
- 3 Noise too loud ▶ Installation work started? ▶ Front grille/panel closed properly?
- 4 Cooling/heating efficiency low ▶ Temperature set correctly? ▶ Windows/doors closed? ▶ Filters cleaned/replaced?
▶ Outdoor unit obstructed? ▶ Intake/outlet ventilators obstructed?

In case of...

- Abnormal noise during operation
- Water/foreign particles have entered the Remote Control
- Water leak from Indoor Unit
- Switches/buttons do not operate properly
- Circuit breaker switches off frequently
- Power plug/cord become unnaturally warm

• «TIMER» flashes



1. press 5 sec.



2. search code

if 4x beep



=Code (H23/H27/H28)

*Emergency operation (limited function)

 **TURN OFF / UNPLUG**

 **CALL authorized distributor**

* 1. Press MODE - 2. Select COOL/ HEAT - 3. Press OFF/ON



SAFETY PRECAUTIONS

Before operating, read the safety precautions thoroughly

EMERGENCY!

SOS Immediately isolate from the mains supply (e.g. if there is a smell of burning)

Use only for...

COOL Cooling **FAN** Air circulation

HEAT Heating NEVER use this unit for purposes other than those listed in these Operating Instructions. In particular, do not use it for the preservation of food.

DRY Dehumidifying

Installation

- Never install, remove or reinstall yourself
- Engage dealer/specialist
- NOT in potentially explosive atmosphere
- Connect drain hose properly

Mains connection

Engage dealer/specialist for mains connection including...

- Used connectors/breakers easy reachable
- NEVER shared
- Connect protective earth!
- Plug in properly

Australia (AS) Standard
The appliance is not intended for use by young children or infirm person without supervision. Young children should be supervised to ensure that they do not play with the appliance.

United Kingdom only
Replacement or installation of power plugs shall be performed by authorised/qualified personnel only. The wires in this mains lead are coloured in accordance with the following code:

L		live	brown
N		neutral	blue
E		earth	green- yellow
	Terminals	wires	colors

Operation

- NEVER use the plug to switch on/off
 - Do NOT stay long in the stream of cold air
 - Do NOT operate with wet hands
 - Ventilate the room periodically
 - NEVER modify/damage mains cables/connectors
 - Do not pull out the plug by the cable
 - Place nothing on the unit -> covered openings may cause overheating/fire
 - NO fingers or objects into the unit! -> especially dangerous for children!
 - Unused for a long time? -> OFF/unplug
- If the supply cord is damaged or needed to be replaced, it must be replaced by the manufacturer or its service agent or a similar qualified person in order to avoid a hazard

SAFETY PRECAUTIONS & FEATURES

Defects



Defect/suspicion of defect? → Attend defects before use!



Do NOT repair yourself



Engage dealer/specialist

Cleaning



OFF and unplug (connector or breaker)



Do NOT wash!

Waste disposal



Uninstalling and disposal of the unit ONLY by dealer/specialist.
Contains CHLORO-FLUORO-CARBONS (CFC)



Packaging recyclable



Wet Bulb ◀ Temperature ▶ Dry Bulb



Operational Condition

	min	max		min	max
□	11	23	Cooling	16	32
□	11	26		16	43
□	-	-	Heating	2	30
□	-6	18		-5	24

[°C]

TSM SUCCESS MANUAL® - safe to use - easy to understand due to TSM® - Total Security Management and ergonomic communication® - 060203 by SEV-ASE



10 Installation And Servicing Air Conditioner Using R410A

10.1. OUTLINE

10.1.1. About R410A Refrigerant

1. Converting air conditioners to R410A

Since it was declared in 1974 that chlorofluorocarbons (CFC), hydro chlorofluorocarbons (HCFC) and other substances pose a destructive danger to the ozone layer in the earth's upper stratosphere (20 to 40 km above the earth), measures have been taken around the world to prevent this destruction.

The R22 refrigerant which has conventionally been used in ACs is an HCFC refrigerant and, therefore, possesses this ozone-destroying potential. International regulations (the Montreal Protocol Ozone-Damaging Substances) and the domestic laws of various countries call for the early substitution of R22 by a refrigerant which will not harm the ozone layer.

- In ACs, the HFC refrigerant which has become the mainstream alternative called R410A. Compared with R22, the pressure of R410A is approximately 1.6 times as high at the same refrigerant temperature, but the energy efficiency is about the same. Consisting of hydrogen (H), fluorine (F) and carbon (C), R410A is an HFC refrigerant. Another typical HFC refrigerant is R407C. While the energy efficiency of R407C is somewhat inferior to that of R410A, it offers the advantage of having pressure characteristics which are about the same as those of R22, and is used mainly in packaged ACs.

2. The characteristics of HFC (R410A) refrigerants

a. Chemical characteristics

The chemical characteristics of R410A are similar to those of R22 in that both are chemically stable, non-flammable refrigerants with low toxicity.

However, just like R22, the specific gravity of R410A gas is heavier than that of air. Because of this, it can cause an oxygen deficiency if it leaks into a closed room since it collects in the lower area of the room. It also generates toxic gas when it is directly exposed to a flame, so it must be used in a well ventilated environment where it will not collect.

Table 1 Physical comparison of R410A and R22

	R410A	R22
Composition (wt%)	R32/R125 (50/50)	R22 (100)
Boiling point (°C)	-51.4	-40.8
Vaporizing pressure (25°C)	1.56 Mpa (15.9 kgf/cm ²)	0.94 Mpa (9.6 kgf/cm ²)
Saturated vapor density	64.0 kg/m ³	44.4 kg/m ³
Flammability	Non-flammable	Non-flammable
Ozone-destroying point (ODP)	0	0.005
Global-warming point (GWP)	1730	1700

b. Compositional change (pseudo-azeotropic characteristics)

R410A is a pseudo-azeotropic mixture comprising the two components R32 and R125. Multi-component refrigerants with these chemical characteristics exhibit little compositional change even from phase changes due to vaporization (or condensation), which means that there is little change in the circulating refrigerant composition even when the refrigerant leaks from the gaseous section of the piping.

Accordingly, R410A can be handled in almost the same manner as the single-component refrigerant R22. However, when charging, because there is a slight change in composition between the gas phase and the liquid phase inside a cylinder or other container, charging should basically begin with the liquid side.

c. Pressure characteristics

As seen in Table 2, the gas pressure of R410A is approximately 1.6 times as high as that of R22 at the same refrigerant temperature, which means that special R410A tools and materials with high-pressure specifications must be used for all refrigerant piping work and servicing.

Table 2 Comparison of R410A and R22 saturated vapor density

Refrigerant Temperature (°C)	Unit: MPa	
	R410A	R22
-20	0.30	0.14
0	0.70	0.40
20	1.35	0.81
40	2.32	1.43
60	3.73	2.33
65	4.15	2.60

d. R410A refrigerating machine oil

Conventionally, mineral oil or a synthetic oil such as alkylbenzene has been used for R22 refrigerating machine oil. Because of the poor compatibility between R410A and conventional oils like mineral oil, however, there is a tendency for the refrigerating machine oil to collect in the refrigerating cycle. For this reason, polyester and other synthetic oils which have a high compatibility with R410A are used as refrigerating machine oil.

Because of the high hygroscopic property of synthetic oil, more care must be taken in its handling than was necessary with conventional refrigerating machine oils. Also, these synthetic oils will degrade if mixed with mineral oil or alkylbenzene, causing clogging in capillary tubes or compressor malfunction. Do not mix them under any circumstances.

10.1.2. Safety Measure When Installing / Receiving Refrigerant Piping

Cause the gas pressure of R410A is approximately 1.6 times as high as that of R22, a mistake in installation or servicing could result in a major accident. It is essential that you use R410a tools and materials, and that you observe the following precautions to ensure safety.

1. Do not use any refrigerant other than R410A in ACs that have been used with R410A.
2. If any refrigerant gas leaks while you are working, ventilate the room. Toxic gas may be generated if refrigerant gas is exposed to a direct flame.
3. When installing or transferring an AC, do not allow any air or substance other than R410A to mix into the refrigeration cycle. If it does, the pressure in the refrigeration cycle can become abnormally high, possibly causing an explosion and/or injury.
4. After finishing the installation, check to make sure there is no refrigerant gas leaking.
5. When installing or transferring an AC, follow the instructions in the installation instructions carefully. Incorrect installation can result in an abnormal refrigeration cycle or water leakage, electric shock, fire, etc.
6. Do not perform any alterations on the AC unit under any circumstances. Have all repair work done by a specialist. Incorrect repairs can result in a water leakage, electric shock, fire, etc.

10.2. TOOL FOR INSTALLING / SERVICING REFRIGERANT PIPING

10.2.1. Necessary Tools

In order to prevent an R410A AC from mistakenly being charged with any other refrigerant, the diameter of the 3-way valve service port on the outdoor unit has been changed. Also, to increase its ability to withstand pressure, the opposing dimensions have been changed for the refrigerant pipe flaring size and flare nut. Accordingly, when installing or servicing refrigerant piping, you must have both the R410A and ordinary tools listed below.

Table 3 Tools for installation, transferring or replacement

Type of work	Ordinary tools	R410A tools
Flaring	Flaring tool (clutch type), pipe cutter, reamer	Copper pipe gauge for clearance Adjustment, flaring tool (clutch type)*1)
Bending, connecting pipes	Torque wrench (nominal diameter 1/4, 3/8, 1/2) Fixed spanner (opposing sides 12 mm, 17 mm, 19 mm) Adjustable wrench, Spring bender	
Air purging	Vacuum pump Hexagonal wrench (opposing sides 4 mm)	Manifold gauge, charging hose, vacuum pump adaptor
Gas leak inspection	Gas leak inspection fluid or soapy water	Electric gas leak detector for HFC refrigerant*2)

*1) You can use the conventional (R22) flaring tool. If you need to buy a new tool, buy the R410A type.

*2) Use when it is necessary to detect small gas leaks.

For other installation work, you should have the usual tools, such as screwdrivers (+,-), a metal-cutting saw, an electrical drill, a hole core drill (65 or 70 dia.), a tape measure, a level, a thermometer, a clamp meter, an insulation tester, a voltmeter, etc.

Table 4 Tools for serving

Type of work	Ordinary tools	R410A tools
Refrigerant charging		Electronic scale for refrigerant charging Refrigerant cylinder Charging orifice and packing for refrigerant cylinder
Brazing (Replacing refrigerating cycle part*1)	Nitrogen blow set (be sure to use nitrogen blowing for all brazing), and brazing), and brazing machine	

*1) Always replace the dryer of the outdoor unit at the same time. The replacement dryer is wrapped in a vacuum pack. Replace it last among the refrigerating cycle parts. Start brazing as soon as you have opened the vacuum pack, and begin the vacuuming operation within 2 hours.

10.2.2. R410A Tools

1. Cooper tube gauge for clearance adjustment
(used when flaring with the conventional flaring tool (clutch type))

- This gauge makes it easy to set the clearance for the copper tube to 1.0-1.5 mm from the clamp bar of the flaring tool.

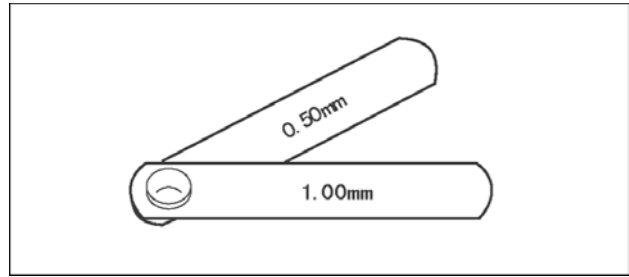

Fig. 1 Copper tube gauge for clearance adjustment

2. Flaring tool (clutch type)

- In the R410A flaring tool, the receiving hole for the clamp bar is enlarged so the clearance from the clamp bar can be set to 0-0.5 mm, and the spring inside the tool is strengthened to increase the strength of the pipe-expanding torque. This flaring tools can also be used with R22 piping, so we recommend that you select it if you are buying a new flaring tool.

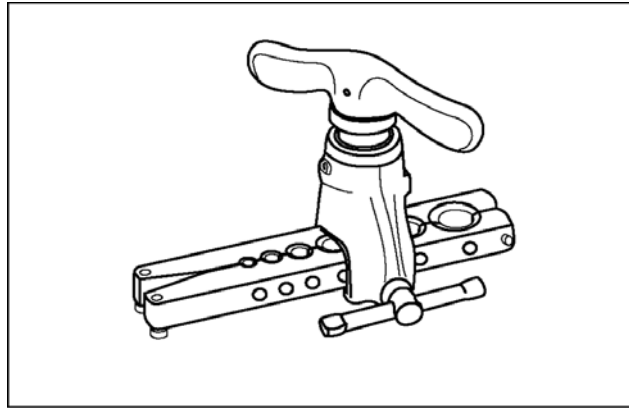

Fig. 2 Flaring tool (clutch type)

3. Torque wrenches

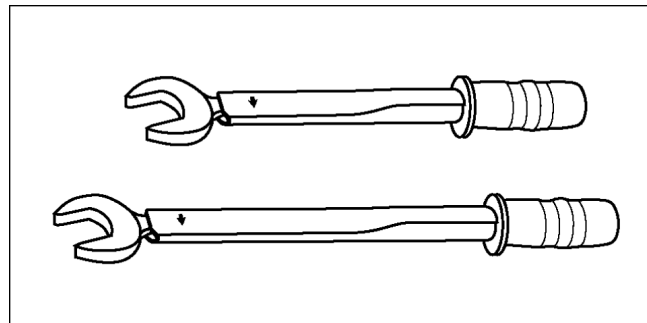

Fig. 3 Torque wrenches

Table 5

	Conventional wrenches	R410A wrenches
For 1/4 (opposite side x torque)	17 mm x 18 N.m (180 kgf.cm)	17 mm x 18 N.m (180 kgf.cm)
For 3/3 (opposite side x torque)	22 mm x 42 N.m (180 kgf.cm)	22 mm x 42 N.m (180 kgf.cm)
For 1/2 (opposite side x torque)	24 mm x 55 N.m (180 kgf.cm)	26 mm x 55 N.m (180 kgf.cm)

4. Manifold gauge

- Because the pressure is higher for the R410A type, the conventional type cannot be used.

Table 6 Difference between R410A and conventional high / low-pressure gauges

	Conventional wrenches	R410A wrenches
High-pressure gauge (red)	-76 cmHg - 35 kgf/cm ³	-0.1 - 5.3 Mpa -76 cmHg - 53 kgf/cm ³
High-pressure gauge (blue)	-76 cmHg - 17 kgf/cm ³	-0.1 - 3.8 Mpa -76 cmHg - 38 kgf/cm ³

- The shape of the manifold ports has been changed to prevent the possibility of mistakenly charging with another type of refrigerant.

Table 7 Difference between R410A and conventional manifold port size

	Conventional gauges	R410A gauges
Port size	7/6 UNF 20 threads	1/2 UNF 20 threads

5. Charging hose

- The pressure resistance of the charging hose has been raised to match the higher pressure of R410A. The hose material has also been changed to suit HFC use, and the size of the fitting has been changed to match the manifold ports.

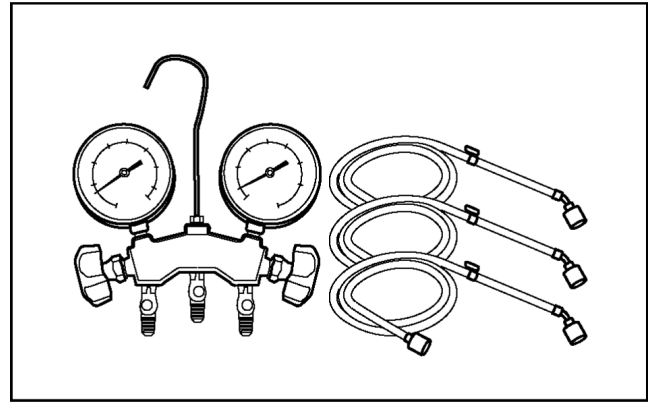

Fig. 4 Manifold gauge charging hose

Table 8 Difference between R410A and conventional charging hoses

		Conventional hoses	R410A hoses
Pressure resistance	Working pressure	3.4 MPa (35 kgf/cm ³)	5.1 MPa (52 kgf/cm ³)
	Bursting pressure	17.2 MPa (175 kgf/cm ³)	27.4 MPa (280 kgf/cm ³)
Material		NBR rubber	HNBR rubber Nylon coating inside

6. Vacuum pump adaptor

- When using a vacuum pump for R410A, it is necessary to install an electromagnetic valve to prevent the vacuum pump oil from flowing back into the charging hose. The vacuum pump adaptor is installed for that purpose. If the vacuum pump oil (mineral oil) becomes mixed with R410A, it will damage the unit.

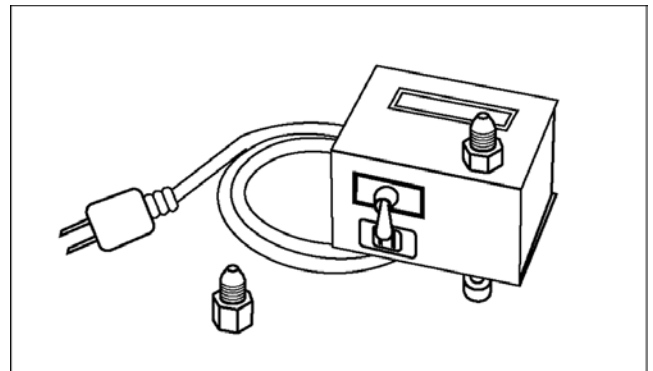

Fig. 5 Vacuum pump adaptor

7. Electric gas leak detector for HFC refrigerant

- The leak detector and halide torch that were used with CFC and HCFC cannot be used with R410A (because there is no chlorine in the refrigerant).
- The present R134a leak detector can be used, but the detection sensitivity will be lower (setting the sensitivity for R134a at 1, the level for R410A will drop to 0.6).
- For detecting small amounts of gas leakage, use the electric gas leak detector for HFC refrigerant. (Detection sensitivity with R410A is about 23 g/year).

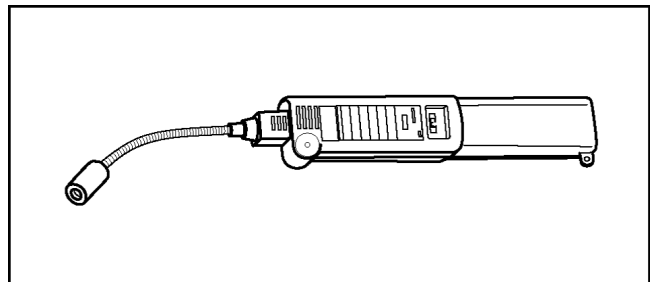

Fig. 6 Electric gas leak detector for HFC refrigerant

8. Electronic scale for refrigerant charging

- Because of the high pressure and fast vaporizing speed of R410A, the refrigerant cannot be held in a liquid phase inside the charging cylinder when charging is done using the charging cylinder method, causing bubbles to form in the measurement scale glass and making it difficult to see the reading. (Naturally, the conventional R22 charging cylinder cannot be used because of the differences in the pressure resistance, scale gradation, connecting port size, etc.)
- The electronic scale has been strengthened by using a structure in which the weight detector for the refrigerant cylinder is held by four supports. It is also equipped with two connection ports, one for R22 (*7/16 UNF, 20 threads) and one for R410A (1/2 UNF, 20 threads), so it can also be used for conventional refrigerant charging.
- There are two types of electronic scales, one for 10-kg cylinders and one for 20-kg cylinders. (The 10-kg cylinder is recommended.)

Refrigerant charging is done manually by opening and closing the valve.

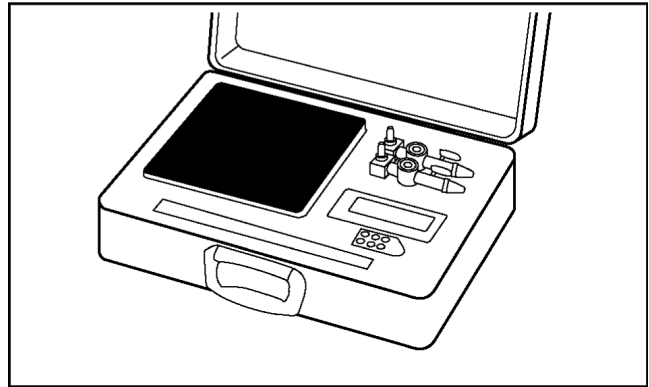

Fig. 7 Electronic scale for refrigerant charging

9. Refrigerant cylinders

- The R410A cylinders are labeled with the refrigerant name, and the coating color of the cylinder protector is pink, which is the color stipulated by ARI of the U.S.
- Cylinder equipped with a siphon tube are available to allow the cylinder to stand upright for liquid refrigerant charging.

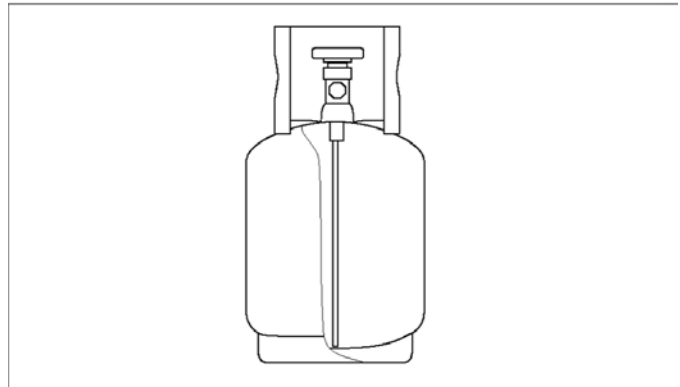

Fig. 8 Refrigerant cylinders

10. Charging orifice and packing for refrigerant cylinders

- The charging orifice must match the size of the charging hose fitting (1/2 UNF, 20 threads).
- The packing must also be made of an HFC-resistant material.

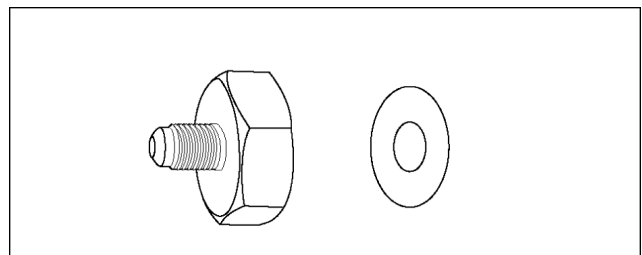

Fig. 9 Charging orifice and packing

10.2.3. R410A Tools Which Are Usable for R22 Models

Table 9 R410A tools which are usable for R22 models

	R410A tools	Usable for R22 models
(1)	Copper tube gauge for clearance adjustment	OK
(2)	Flaring tool (clutch type)	OK
(3)	Manifold gauge	NG
(4)	Charging hose	NG
(5)	Vacuum pump adaptor	OK
(6)	Electric gas leak detector for HFC refrigerant	NG
(7)	Electronic scale for refrigerant charging	OK
(8)	Refrigerant cylinder	NG
(9)	Charging orifice and packing for refrigerant cylinder	NG

10.3. REFRIGERANT PIPING WORK

10.3.1. Piping Materials

It is recommended that you use copper and copper alloy jointless pipes with a maximum oil adherence of 40 mg/10m. Do not use pipes that are crushed, deformed, or discolored (especially the inside surface). If these inferior pipes are used, impurities may clog the expansion valves or capillaries.

Because the pressure of ACs using R410A is higher than those using R22, it is essential that you select materials that are appropriate for these standards.

The thickness of the copper tubing used for R410A is shown in Table 10. Please be aware that tubing with a thickness of only 0.7 mm is also available on the market, but this should never be used.

Table 8 Difference between R410A and conventional charging hoses

Soft pipe		Thickness (mm)	
Nominal diameter	Outside diameter (mm)	R410A	(Reference) R22
1/4	6.35	0.80	0.80
3/8	9.52	0.80	0.80
1/2	12.7	0.80	0.80

10.3.2. Processing and Connecting Piping Materials

When working with refrigerant piping, the following points must be carefully observed: no moisture or dust must be allowed to enter the piping, and there must be no refrigerant leaks.

1. Procedure and precautions for flaring work

a. Cut the pipe

Use a pipe cutter, and cut slowly so the pipe will not be deformed.

b. Remove burrs and clean shavings from the cut surface

If the shape of the pipe end is poor after removing burrs, or if shavings adhere to the flared area, it may lead to refrigerant leaks.

To prevent this, turn the cut surface downward and remove burrs, then clean the surface, carefully.

c. Insert the flare nut (be sure to use the same nut that is used on the AC unit)

d. Flaring

Check the clamp bar and the cleanliness of the copper pipe.

Be sure to use the clamp bar to do the flaring with accuracy. Use either an R410A flaring tool, or a conventional flaring tool. Flaring tools come in different sizes, so be sure to check the size before using. When using a conventional flaring tool, use the copper pipe gauge for clearance adjustment, etc., to ensure the correct A dimension (see Fig. 10)

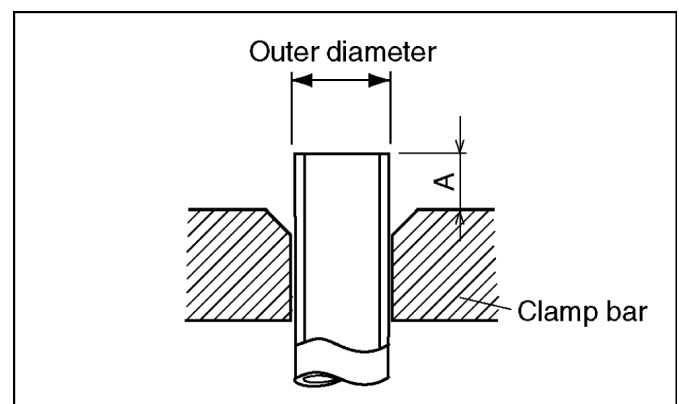

Fig. 10 Flaring dimensions

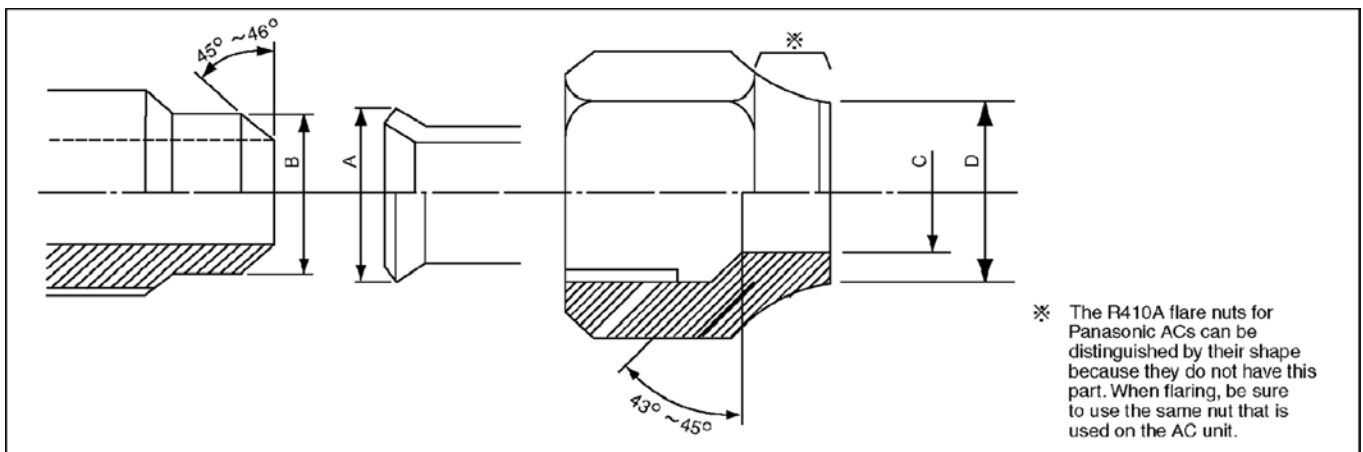

Fig. 11 Relation between the flare nut structure and flaring tool end

Table 11 R410A flaring dimensions

Nominal diameter	Outside diameter (mm)	Wall thickness (mm)	A (mm)		
			R410A flaring tool, clutch type	Conventional flaring tool	
				Clutch type	Wing-nut type
1/4	6.35	0.8	0 - 0.5	1.0 - 1.5	1.5 - 2.0
3/8	9.52	0.8	0 - 0.5	1.0 - 1.5	1.5 - 2.0
1/2	12.70	0.8	0 - 0.5	1.0 - 1.5	2.0 - 2.5

Table 12 R410A flaring dimensions

Nominal diameter	Outside diameter (mm)	Wall thickness (mm)	A (mm)		
			R410A flaring tool, clutch type	Conventional flaring tool	
				Clutch type	Wing-nut type
1/4	6.35	0.8	0 - 0.5	0.5 - 1.0	1.0 - 1.5
3/8	9.52	0.8	0 - 0.5	0.5 - 1.0	1.0 - 1.5
1/2	12.70	0.8	0 - 0.5	0.5 - 1.0	1.5 - 2.0

Table 13 R410A flaring and flare nut dimensions Unit: mm

Nominal diameter	Outside diameter (mm)	Wall thickness (mm)	A +0, -0.4	B dimension	C dimension	D dimension	Flare nut width
1/4	6.35	0.8	9.1	9.2	6.5	13	17
3/8	9.52	0.8	13.2	13.5	9.7	20	22
1/2	12.70	0.8	16.6	16.0	12.9	23	26

Table 14 R410A flaring and flare nut dimensions Unit: mm

Nominal diameter	Outside diameter (mm)	Wall thickness (mm)	A +0, -0.4	B dimension	C dimension	D dimension	Flare nut width
1/4	6.35	0.8	9.0	9.2	6.5	13	17
3/8	9.52	0.8	13.0	13.5	9.7	20	22
1/2	12.70	0.8	16.2	16.0	12.9	20	24

2. Procedure and precautions for flare connection

- a. Check to make sure there are no scratches, dust, etc., on the flare and union.
- b. Align the flared surface with the axial center of the union.
- c. Use a torque wrench, and tighten to the specified torque. The tightening torque for R410A is the same as the conventional torque value for R22. Be careful, because if the torque is too weak, it may lead to a gas leak. If it is too strong, it may split the flare nut or make it impossible to remove the flare nut.

Table 15 R410A tightening torque

Nominal diameter	Outside diameter (mm)	Tightening torque N.m (kgf.cm)	Torque wrench tightening torque N.m (kgf.cm)
1/4	6.35	14 - 18 (140 - 180)	18 (180)
3/8	9.52	33 - 42 (330 - 420)	42 (420)
1/2	12.70	55 (550)	55 (550)

10.3.3. Storing and managing Piping Materials

1. Types of piping and their storage

The following is a general classification of the refrigerant pipe materials used for ACs.

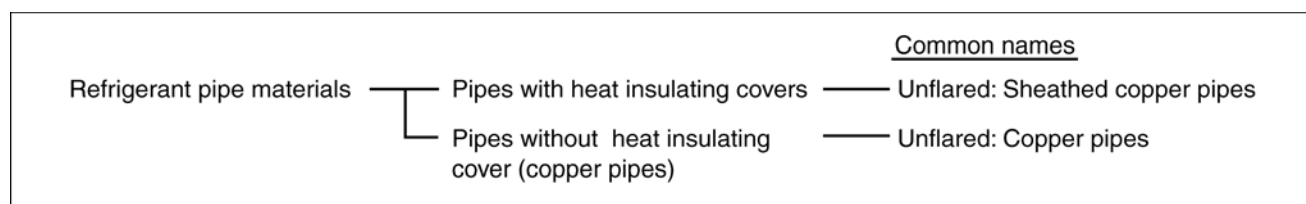

Because the gas pressure of R410A is approximately 1.6 times as high as that of R22, copper pipes with the thickness shown in Table 10, and with minimal impurities must be used. Care must also be taken during storage to ensure that pipes are not crushed, deformed, or scratched, and that no dust, moisture or other substance enters the pipe interior. When storing sheathed copper pipes or plain copper pipes, seal the openings by pinching or taping them securely.

2. Makings and management

a. Sheathed copper pipes and copper-element pipes

When using these pipes, check to make sure that they are the stipulated thickness. For flare nuts, be sure to use the same nut that is used on the AC unit.

b. Copper pipes

Use only copper pipes with the thickness given in table 10, and with minimal impurities. Because the surface of the pipe is exposed, you should take special care, and also take measures such as marking the pipes to make sure they are easily distinguished from other piping materials, to prevent mistaken use.

3. Precautions during refrigerant piping work

Take the following precautions on-site when connecting pipes. (Keep in mind that the need to control the entry of moisture and dust is even more important than in conventional piping).

- a. Keep the open ends of all pipes sealed until connection with AC equipment is complete.
- b. Take special care when doing piping work on rainy days. The entering of moisture will degrade the refrigerating machine oil, and lead to malfunctions in the equipment.
- c. Complete all pipe connections in as short a time as possible. If the pipe must be left standing for a long time after removing the seal, it must be thoroughly purged with nitrogen, or dried with a vacuum pump.

10.4. INSTALLATION, TRANSFERRING, SERVICING

10.4.1. Inspecting Gas Leaks with a Vacuum Pump for New Installations (Using New Refrigerant Piping)

1. From the viewpoint of protecting the global environment, please do not release refrigerant into the atmosphere.
 - a. Connect the projecting side (pin-pushing side) of the charging hose for the manifold gauge to the service port of the 3-way valve. (1)
 - b. Fully open the handle Lo of the manifold gauge and run the vacuum pump. (2) (If the needle of the low-pressure gauge instantly reaches vacuum, re-check step a.)
 - c. Continue the vacuum process for at least 15 minutes, then check to make sure the low-pressure gauge has reached -0.1 MPa (-76 cmHg). Once the vacuum process has finished, fully close the handle Lo of the manifold gauge and stop the vacuum pump operation, then remove the charging hose that is connected to the vacuum pump adaptor. (Leave the unit in that condition for 1-2 minutes, and make sure that the needle of the manifold gauge does not return.) (2) and (3)
 - d. Turn the valve stem of the 2-way valve 90 counter-clockwise to open it, then, after 10 seconds, close it and inspect for a gas leak (4)
 - e. Remove the charging hose from the 3-way valve service port, then open both the 2-way valve and 3-way valve. (1) (4) (Turn the valve stem in the counter-clockwise direction until it gently makes contact. Do not turn it forcefully).
 - f. Tighten the service port cap with a torque wrench (18 N.m (1.8 kgf.m)). (5) Then tighten the 2-way valve and 3-way valve caps with a torque wrench (42 N.m (4.2 kgf.m)) or (55 N.m (5.5 kgf.m)).
 - g. After attaching each of the caps, inspect for a gas leak around the cap area. (5) (6)

Precautions

- Be sure to read the instructions for the vacuum pump, vacuum pump adaptor and manifold gauge prior to use, and follow the instructions carefully.
- Make sure that the vacuum pump is filled with oil up to the designated line on the oil gauge.
- The gas pressure back flow prevention valve on the charging hose is generally open during use. When you are removing the charging hose from the service port, it will come off more easily if you close this valve.

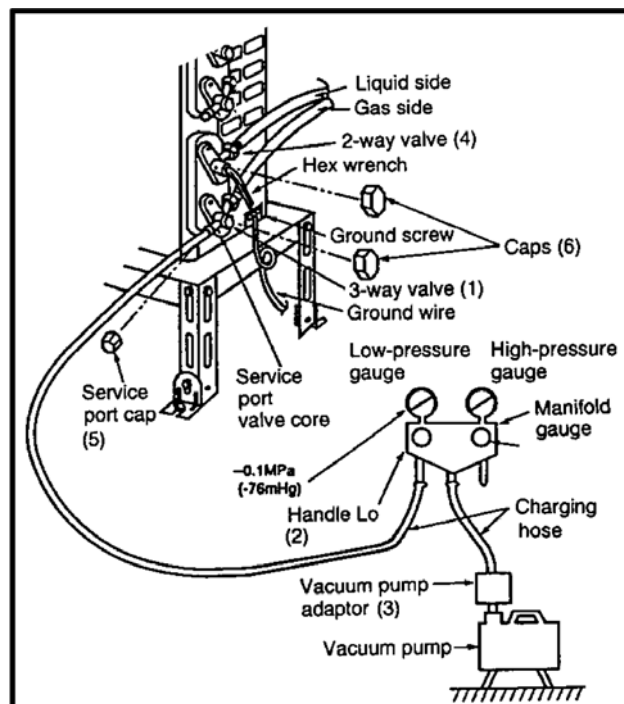

Fig. 12 Vacuum pump air purging configuration

10.4.2. Transferring (Using New Refrigerant Piping)

1. Removing the unit

a. Collecting the refrigerant into the outdoor unit by pumping down

The refrigerant can be collected into the outdoor unit (pumping down) by pressing the TEST RUN button, even when the temperature of the room is low.

- Check to make sure that the valve stems of the 2-way valve and 3-way valve have been opened by turning them counter-clockwise. (Remove the valve stem caps and check to see that the valve stems are fully opened position. Always use a hex wrench (with 4-mm opposing sides) to operate the valve stems.)
- Press the TEST RUN button on the indoor unit, and allow preliminary for 5-6 minutes. (TEST RUN mode)
- After stopping the operation, let the unit sit for about 3 minutes, then close the 2-way valve by turning the valve stem in the clockwise direction.
- Press the TEST RUN button on the indoor unit again, and after 2-3 minutes of operation, turn the valve stem of the 3-way valve quickly in the clockwise direction to close it, then stop the operation.
- Tighten the caps of the 2-way valve and 3-way valve to the stipulated torque.
- Remove the connection pipes (liquid side and gas side).

2. Installing the unit

Install the unit using new refrigerant piping. Follow the instructions in section 4.1 to evacuate the pipes connecting the indoor and outdoor units, and the pipes of the indoor unit, and check for gas leaks.

10.4.3. AC Units Replacement (Using Existing Refrigerant Piping)

When replacing an R410A AC unit with another R410A AC unit, you should re-flare the refrigerant piping. Even though the replacement AC unit uses the R410A, problems occur when, for example, either the AC unit maker or the refrigerating machine oil is different.

When replacing an R22 AC unit with an R410A AC unit, the following checks and cleaning procedures are necessary but are difficult to do because of the chemical characteristics of the refrigerating machine oil (as described in items c) and d) of section 10.1.1.(2)). In this case, you should use new refrigerant piping rather than the existing piping.

1. Piping check

Because of the different pressure characteristics of R22 and R410A, the design pressure for the equipment is 1.6 times different. The wall thickness of the piping must comply with that shown in Table 10, but this is not easy to check. Also, even if the thickness is correct, there may be flattened or bent portions midway through the piping due to sharp curves. Buried sections of the piping also cannot be checked.

2. Pipe cleaning

A large quantity of refrigerating machine oil (mineral oil) adheres to existing pipes due to the refrigeration cycle circulation. If the pipes are used just as they are for the R410A cycle, the capacity will be lowered due to the incompatibility of this oil with the R410A, or irregularities may occur in the refrigeration cycle. For this reason, the piping must be thoroughly cleaned, but this is difficult with the present technology.

10.4.4. Refrigerant Compatibility (Using R410A Refrigerant in R22 ACs and Vice Versa)

Do not operate an existing R22 AC with the new R410A refrigerant. Doing so would result in improper functioning of the equipment or malfunction, and might lead to a major accident such as an explosion in the refrigeration cycle. Similarly, do not operate an R410A AC with R22 refrigerant. The chemical reaction between the refrigerating machine oil used in R410A ACs and the chlorine that is contained in R22 would cause the refrigerating machine oil to degrade and lead to malfunction.

10.4.5. Recharging Refrigerant During Servicing

When recharging is necessary, insert the specified amount of new refrigerant in accordance with the following procedure.

1. Connect the charging hose to the service port of the outdoor unit.
2. Connect the charging hose to the vacuum pump adaptor. At this time, fully open the 2-way valve and 3-way valve.
3. Fully open the handle Lo of the manifold gauge, turn on the power of the vacuum pump and continue the vacuum process for at least one hour.
4. Confirm that the low pressure gauge shows a reading of -0.1 Mpa (-76 cmHg), then fully close the handle Lo, and turn off the vacuum pump. Wait for 1-2 minutes, then check to make sure that the needle of the Low pressure gauge has not returned. See Fig. 13 for the remaining steps of this procedure.

5. Set the refrigerant cylinder onto the electronic scale, then correct the hose the cylinder and to the connection port for the electronic scale. (1)(2)

Precaution:

Be sure to set up the cylinder for liquid charging. If you use a cylinder equipped with a siphon tube, you can charge the liquid without having to turn the cylinder around

6. Remove the charging hose of the manifold gauge from the vacuum pump adaptor, and connect it to the connection port of the electronic scale. (2)(3)
7. Open the valve of the refrigerant cylinder, then open the charging valve slightly and close it. Next, press the check valve of the manifold gauge and purge the air. (2)(4) (Watch the liquid refrigerant closely at this point.)
8. After adjusting the electronic scale to zero, open the charging valve, then open the valve Lo of the manifold gauge and charge with the liquid refrigerant. (2)(5) (Be sure to read the operating instructions for the electronic scale.)
9. If you cannot charge the stipulated amount, operate the unit in the cooling mode while charging a little of the liquid at a time (about 150 g/time as a guideline). If the charging amount is insufficient from one operation, wait about one minute, then use the same procedure to do the liquid charging again.

Precaution:

Never use the gas side to allow a larger amount of liquid refrigerant to be charged while operating the unit.

10. Close the charging valve, and after charging the liquid refrigerant inside the charging hose, fully close the valve Lo of the manifold gauge, and stop the operation of the unit. (2)(5)
11. Quickly remove the charging hose from the service port. (6) If you stop midway through, the refrigerant that is in the cycle will be discharged.
12. After putting on the caps for the service port and operating valve, inspect around the caps for a gas leak. (6)(7)

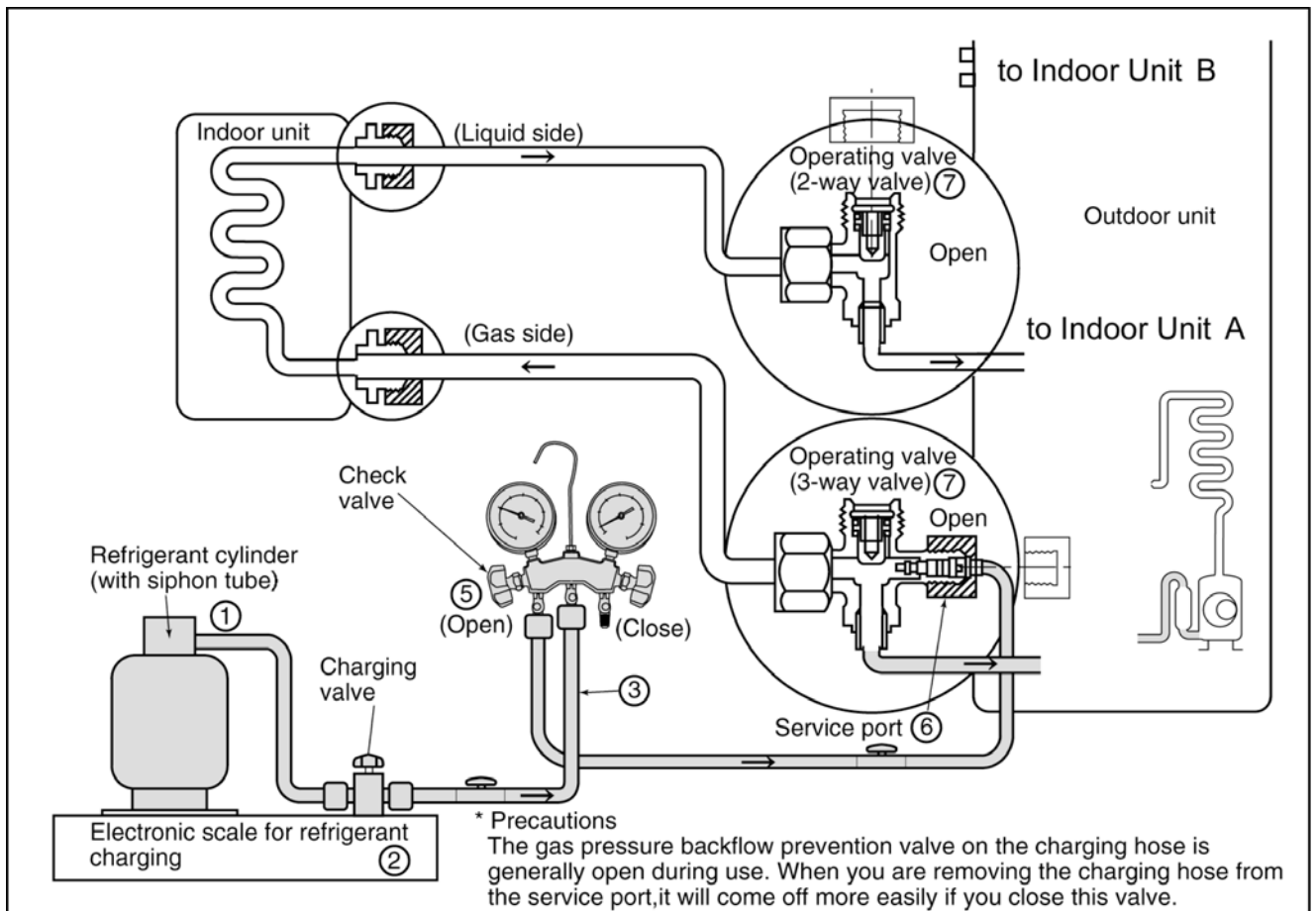

Fig. 13 Re-charging refrigerant

10.4.6. Brazing

As brazing requires sophisticated techniques and experiences, it must be performed by a qualified person.

In order to prevent the oxide film from occurring in the pipe interior during brazing, it is effective to proceed with brazing while letting dry nitrogen gas (N₂) flow.

<Brazing Method for Preventing Oxidation>

1. Attach a reducing valve to the nitrogen gas cylinder.
2. Attach a reducing valve to the nitrogen gas cylinder.
3. Apply a seal onto the clearance between the piping and inserted pipe for the nitrogen gas in order to prevent the nitrogen gas from flowing backward.
4. When the nitrogen gas is flowing, be sure to keep the piping end open.
5. Adjust the flow rate of nitrogen gas so that it is lower than 0.05 m³/h, or 0.02 MPa (0.2 kgf/cm²) by means of the reducing valve.
6. After taking the steps above, keep the nitrogen gas flowing until the piping cools down to a certain extent (i.e. temperature at which pipes are touchable with finger).
7. Completely remove the flux after brazing.

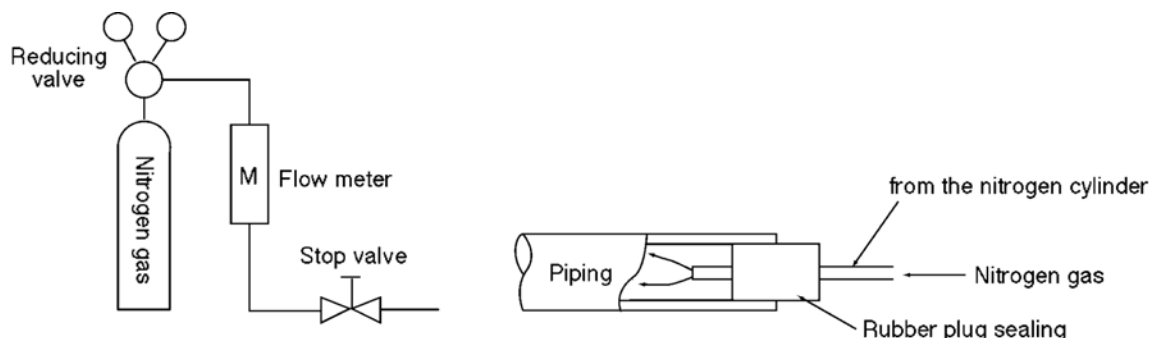

Cautions during brazing

1. General Cautions

- a. The brazing strength should be high as required.
- b. After operation, airtightness should be kept under pressurized condition.
- c. During brazing do not allow component materials to become damaged due to overheating.
- d. The refrigerant pipe work should not become blocked with scale or flux.
- e. The brazed part should not restrict the flow in the refrigerant circuit.
- f. No corrosion should occur from the brazed part.

2. Preventing of Overheating

Due to heating, the interior and exterior surfaces of treated metal may oxidize. Especially, when the interior of the refrigerant circuit oxidizes due to overheating, scale occurs and stays in the circuit as dust, thus exerting a fatally adverse effect. So, make brazing at adequate brazing temperature and with minimum of heating area.

3. Overheating Protection

In order to prevent components near the brazed part from overheating damaged or quality deterioration due to flame or heat, take adequate steps for protection such as (1) by shielding with a metal plate, (2) by using a wet cloth, and (3) by means of heat absorbent.

4. Movement during Brazing

Eliminate all vibration during brazing to protect brazed joints from cracking and breakage.

5. Oxidation Preventative

In order to improve the brazing efficiency, various types of antioxidant are available on the market. However, the constituents of these are widely varied, and some are anticipated to corrode the piping materials, or adversely affect HFC refrigerant, lubricating oil, etc. Exercise care when using an oxidation preventative.

10.4.7. Servicing Tips

The drier must also be replaced whenever replacing the refrigerant cycle parts. Replacing the refrigerant cycle parts first before replacing the drier. The drier is supplied in a vacuum pack. Perform brazing immediately after opening the vacuum pack, and then start the vacuum within two hours. In addition, the drier also needs to be replaced when the refrigerant has leaked completely.

11 Installation Instructions

Required tools for Installation Works			
1. Philips screw driver	5. Spanner	9. Gas leak detector	13. Multimeter
2. Level gauge	6. Pipe cutter	10. Measuring tape	14. Torque wrench 18 N.m (1.8 kgf.m) 42 N.m (4.2 kgf.m) 55 N.m (5.5 kgf.m)
3. Electric drill, hole core drill (ø70 mm)	7. Reamer	11. Thermometer	15. Vacuum pump
4. Hexagonal wrench (4 mm)	8. Knife	12. Megameter	16. Gauge manifold

11.1. Safety Precautions

- Read the following “SAFETY PRECAUTIONS” carefully before installation.
- Electrical work must be installed by a licensed electrician. Be sure to use the correct rating of the power plug and main circuit for the model to be installed.
- The caution items stated here must be followed because these important contents are related to safety. The meaning of each indication used is as below. Incorrect installation due to ignoring of the instruction will cause harm or damage, and the seriousness is classified by the following indications.





 WARNING	This indication shows the possibility of causing death or serious injury.
--	---

 CAUTION	This indication shows the possibility of causing injury or damage to properties only.
--	---

The items to be followed are classified by the symbols:

	Symbol with background white denotes item that is PROHIBITED from doing.
---	--

- Carry out test running to confirm that no abnormality occurs after the installation. Then, explain to user the operation, care and maintenance as stated in instructions. Please remind the customer to keep the operating instructions for future reference.

 WARNING	
1. Engage dealer or specialist for installation. If installation done by the user is defective, it will cause water leakage, electrical shock or fire.	
2. Install according to this installation instruction strictly. If installation is defective, it will cause water leakage, electrical shock or fire.	
3. Use the attached accessories parts and specified parts for installation. Otherwise, it will cause the set to fall, water leakage, fire or electrical shock.	
4. Install at a strong and firm location which is able to withstand the set's weight. If the strength is not enough or installation is not properly done, the set will drop and cause injury.	
5. For electrical work, follow the local national wiring standard, regulation and this installation instruction. An independent circuit and single outlet must be used. If electrical circuit capacity is not enough or defect found in electrical work, it will cause electrical shock or fire.	
6. Use the specified cable (1.5 mm ²) and connect tightly for indoor/outdoor connection. Connect tightly and clamp the cable so that no external force will be acted on the terminal. If connection or fixing is not perfect, it will cause heat-up or fire at the connection.	
7. Wire routing must be properly arranged so that control board cover is fixed properly. If control board cover is not fixed perfectly, it will cause heat-up at connection point of terminal, fire or electrical shock.	
8. When carrying out piping connection, take care not to let air substances other than the specified refrigerant go into refrigeration cycle. Otherwise, it will cause lower capacity, abnormal high pressure in the refrigeration cycle, explosion and injury.	
9. When connecting the piping, do not allow air or any substances other than the specified refrigerant (R410A) to enter the refrigeration cycle. Otherwise, this may lower the capacity, cause abnormally high pressure in the refrigeration cycle, and possibly result in explosion and injury.	
10. <ul style="list-style-type: none"> • When connecting the piping, do not use any existing (R22) pipes and flare nuts. Using such same may cause abnormally high pressure in the refrigeration cycle (piping), and possibly result in explosion and injury. Use only R410A materials. • Thickness of copper pipes used with R410A must be more than 0.8 mm. Never use copper pipes thinner than 0.8 mm. • It is desirable that the amount of residual oil is less than 40 mg/10 m. 	
11. Do not modify the length of the power supply cord or use of the extension cord, and do not share the single outlet with other electrical appliances. Otherwise, it will cause fire or electrical shock.	











CAUTION

1. The equipment must be earthed. It may cause electrical shock if grounding is not perfect.
2. Do not install the unit at place where leakage of flammable gas may occur. In case gas leaks and accumulates at surrounding of the unit, it may cause fire. 
3. Carry out drainage piping as mentioned in installation instructions. If drainage is not perfect, water may enter the room and damage the furniture.

ATTENTION

1. Selection of the installation location.
Select a installation location which is rigid and strong enough to support or hold the unit, and select a location for easy maintenance.
2. Power supply connection to the room air conditioner.
Connect the power supply cord of the room air conditioner to the mains using one of the following method.
Power supply point shall be the place where there is ease for access for the power disconnection in case of emergency.
In some countries, permanent connection of this room air conditioner to the power supply is prohibited.
 1. Power supply connection to the receptacle using a power plug.
Use an approved 15A/16A power plug with earth pin for the connection to the socket.
 2. Power supply connection to a circuit breaker for the permanent connection. Use an approved 16A circuit breaker for the permanent connection. It must be a double pole switch with a minimum 3 mm contact gap.
3. Do not release refrigerant.
Do not release refrigerant during piping work for installation, reinstallation and during repairing a refrigeration parts. Take care of the liquid refrigerant, it may cause frostbite.
4. Installation work.
It may need two people to carry out the installation work.
5. Do not install this appliance in a laundry room or other location where water may drip from the ceiling, etc.

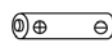
Attached accessories

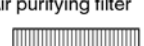
No.	Accessories part	Qty.	No.	Accessories part	Qty.
1	Installation plate 	1	6	Triple Deodorizing filter 	1
2	Installation plate fixing screw 	6	7	Remote Control holder 	1
3	Remote control 	1	8	Remote Control holder fixing screw 	2
4	Battery 	2	9	Drain elbow (E9CK, E12CK, E15CK) 	1
5	Air purifying filter 	1			

Applicable piping kit
 CZ-3F5, 7AEN (E9CK)
 CZ-4F5, 7, 10AN (E12CK, E15CK)

SELECT THE BEST LOCATION

INDOOR UNIT

- There should not be any heat source or steam near the unit.
- There should not be any obstacles blocking the air circulation.
- A place where air circulation in the room is good.
- A place where drainage can be easily done.
- A place where noise prevention is taken into consideration.
- Do not install the unit near the door way.
- Ensure the spaces indicated by arrows from the wall, ceiling, fence or other obstacles.
- Recommended installation height for indoor unit shall be at least 2.3 m.

OUTDOOR UNIT

- If an awning is built over the unit to prevent direct sunlight or rain, be careful that heat radiation from the condenser is not obstructed.
- There should not be any animal or plant which could be affected by hot air discharged.
- Keep the spaces indicated by arrows from wall, ceiling, fence or other obstacles.
- Do not place any obstacles which may cause a short circuit of the discharged air.
- If piping length is over the common length, additional refrigerant should be added as shown in the table.

Model	Piping size		Common Length (m)	Max. Elevation (m)	Max. Piping Length (m)	Additional Refrigerant (g/m)
	Gas	Liquid				
E9CK	3/8"	1/4"	7.5	5	15	20
E12CK, E15CK	1/2"	1/4"	7.5	5	15	20

Indoor/Outdoor Unit Installation Diagram

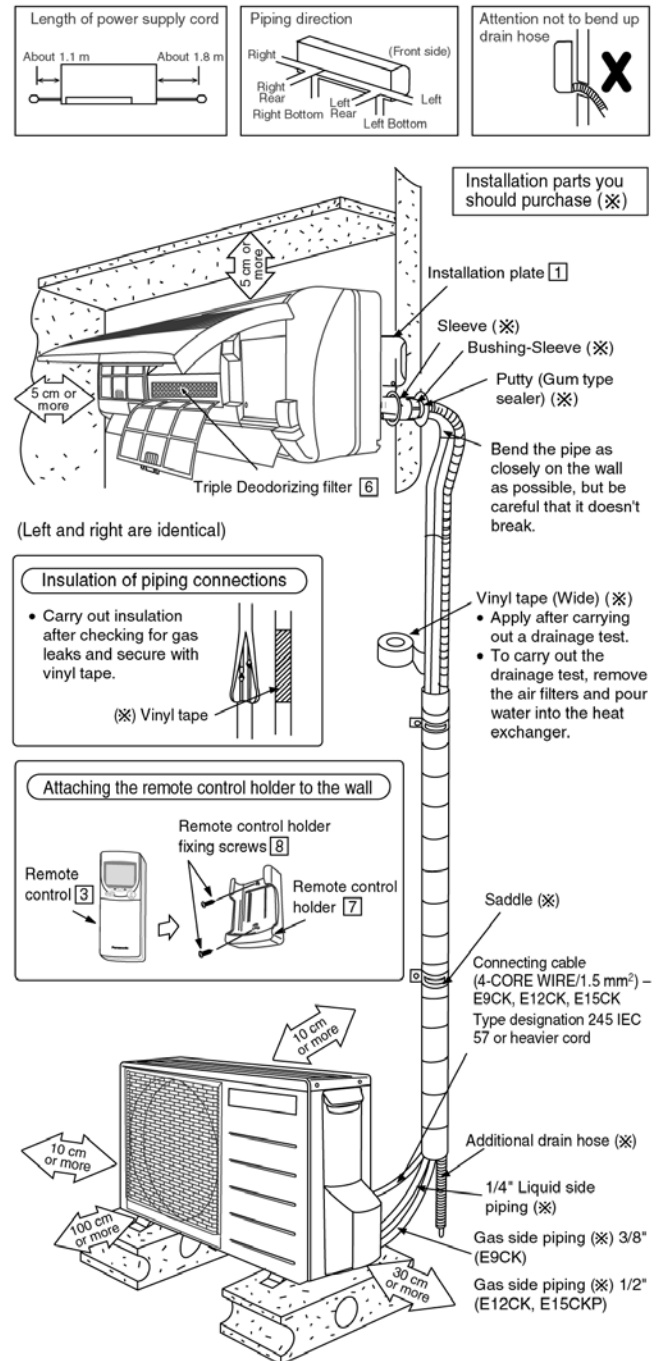

• This illustration is for explanation purposes only. The indoor unit will actually face a different way.

11.2. INDOOR UNIT

11.2.1. SELECT THE BEST LOCATION (Refer to “Select the best location” section)

11.2.2. HOW TO FIX INSTALLATION PLATE

The mounting wall is strong and solid enough to prevent it from the vibration.

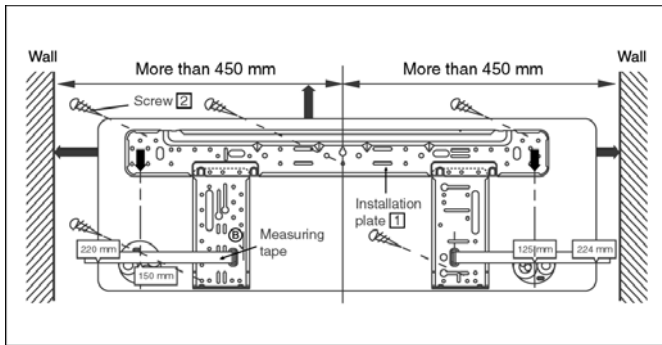

The centre of installation plate should be at more than 450 mm at right and left of the wall.

The distance from installation plate edge to ceiling should more than 67 mm.

From installation plate left edge to unit's left side is 47 mm.

From installation plate right edge to unit's right is 73 mm.

- Ⓑ :
- For left side piping, piping connection for liquid should be about 14 mm from this line.
 - For left side piping, piping connection for gas should be about 56 mm from this line.
 - For left side piping, piping connecting cable should be about 785 mm from this line.

1. Mount the installation plate on the wall with 5 screws or more.

(If mounting the unit on the concrete wall consider using anchor bolts.)

- Always mount the installation plate horizontally by aligning the marking-off line with the thread and using a level gauge.

2. Drill the piping plate hole with $\phi 70$ mm hole-core drill.

- Line according to the arrows marked on the lower left and right side of the installation plate. The meeting point of the extended line is the centre of the hole. Another method is by putting measuring tape at position as shown in the diagram above. The hole centre is obtained by measuring the distance namely 150 mm and 125 mm for left and right hole respectively.
- Drill the piping hole at either the right or the left and the hole should be slightly slanted to the outdoor side.

11.2.3. TO DRILL A HOLE IN THE WALL AND INSTALL A SLEEVE OF PIPING

1. Insert the piping sleeve to the hole.
2. Fix the bushing to the sleeve.
3. Cut the sleeve until it extrudes about 15 mm from the wall.

Caution

When the wall is hollow, please be sure to use the sleeve for tube ass'y to prevent dangers caused by mice biting the connecting cable.

4. Finish by sealing the sleeve with putty or caulking compound at the final stage.

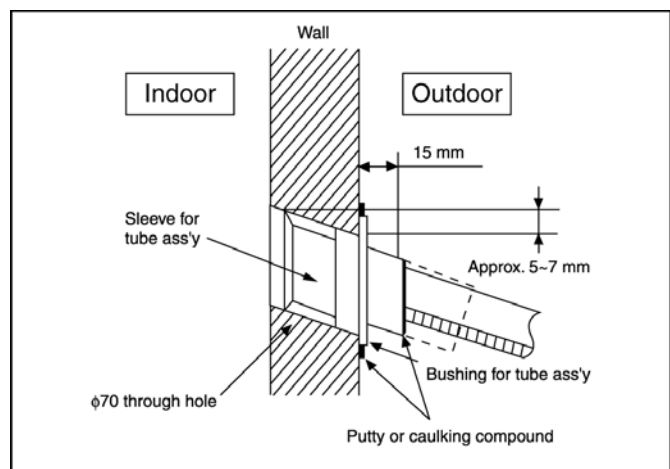

11.2.4. INDOOR UNIT INSTALLATION

1. For the right rear piping

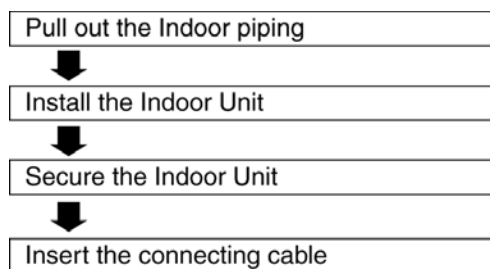

2. For the right and right bottom piping

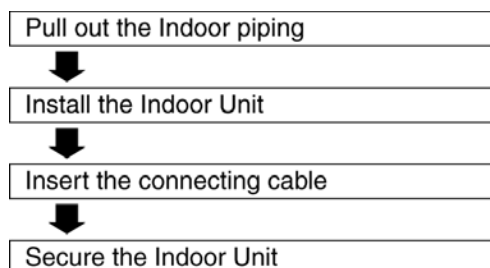

3. For the embedded piping

- Replace the drain hose
- ↓
- Bend the embedded piping
 - Use a spring bender or equivalent to bend the piping so that the piping is not crushed.
- ↓
- Install the Indoor Unit
- ↓
- Cut and flare the embedded piping
 - When determining the dimension of the piping, slide the unit all the way to the left on the installation plate.
 - Refer to the section "Cutting and flaring the piping".
- ↓
- Pull the connecting cable into Indoor Unit
 - The inside and outside connecting cable can be connected without removing the front grille.
- ↓
- Connect the piping
 - Please refer to "Connecting the piping" column in outdoor unit section. (Below steps are done after connecting the outdoor piping and gas-leakage confirmation.)
- ↓
- Insulate and finish the piping
 - Please refer to "Piping and finishing" column of outdoor section and "Insulation of piping connections" column as mentioned in Indoor/Outdoor Unit Installation.
- ↓
- Secure the Indoor Unit

Install the Indoor Unit

Hook the indoor unit onto the upper portion of installation plate (Engage the indoor unit with the upper edge of the installation plate). Ensure the hooks are properly seated on the installation plate by moving in left and right.

Secure the Indoor Unit

1. Tape the extra power supply cord in a bundle and keep it behind the chassis.
 - Ensure that the power supply cord is not clamped in between the unit's hook (2 positions) and installation plate.
2. Press the lower left and right side of the unit against the installation plate until hooks engages with their slots (sound click).

Pull out the piping and drain hose

Move the drain hose near to arrow mark and tape it with piping in a position as mentioned in Fig. below

↓ Centre of the piping hole (left rear side of piping)

To take out the unit, push the **[PUSH]** marking at the bottom unit, and pull it slightly towards you to disengage the hooks from the unit.

(This can be used for left rear piping & left bottom piping also.)

How to keep the cover

In case of the cover is cut, keep the cover at the rear of chassis as shown in the illustration for future reinstallation.

(Left, right and 2 bottom covers for piping)

Exchange the drain hose and the cap

Refer view for left piping installation

Adjust the piping slightly downwards

Insert the connecting cable

Length of connecting cable	77 cm	
Cable	Gas side piping	Liquid side piping

More than approx. 95 cm

- How to pull the piping and drain hose out, in case of the embedded piping.

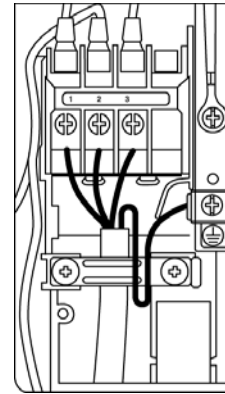
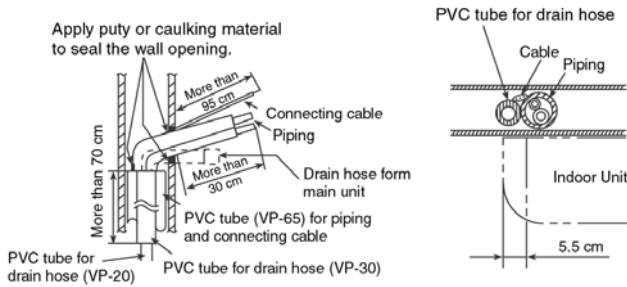

- In case of left piping how to insert the connecting cable and drain hose.

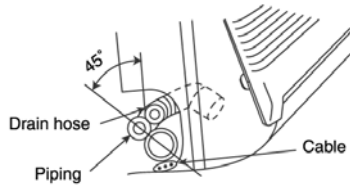

(For the right piping, follow the same procedure)

INSTALLATION OF AIR PURIFYING FILTERS

1. Open the front panel.
2. Remove the air filters.
3. Put air purifying filters (left) and triple deodorizing filter (right) into place as shown in illustration below.

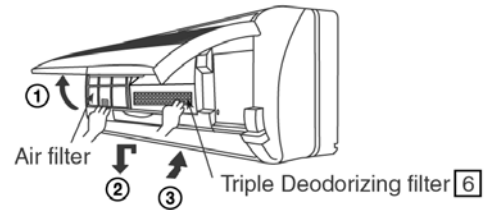

HOW TO TAKE OUT FRONT GRILLE

Please follow the steps below to take out front grille if necessary such as when servicing.

1. Set the vertical airflow direction louver to the horizontal position.
2. Slide down the two caps on the front grille as shown in the illustration below, and then remove the two mounting screws.
3. Pull the lower section of the front grille towards you to remove the front grille.

When reinstalling the front grille, first set the vertical airflow direction louver to the horizontal position and then carry out above steps 2 - 3 in the reverse order.

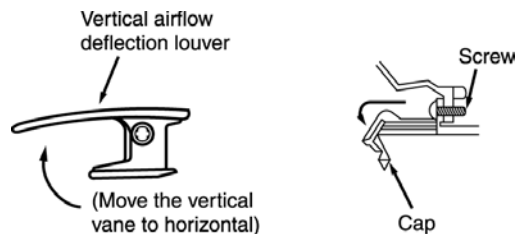

11.2.5. CONNECT THE CABLE TO THE INDOOR UNIT

1. The inside and outside connecting cable can be connected without removing the front grille.
2. Connecting cable between indoor unit and outdoor unit shall be approved polychloroprene sheathed 4 (E9CK, E12CK, E15CK) × 1.5 mm² flexible cord, type designation 245 IEC 57 or heavier cord.
 - Ensure the color of wires of outdoor unit and the terminal Nos. are the same to the indoor's respectively.
 - Earth lead wire shall be longer than the other lead wires as shown in the figure for the electrical safety in case of the slipping out of the cord from the anchorage.

Terminals on the indoor unit	1	2	3	
Color of wires				
Terminals on the outdoor unit	1	2	3	

- Secure the cable onto the control board with the holder (clamper).

AUTO SWITCH OPERATION

The below operations will be performed by pressing the "AUTO" switch.

1. AUTO OPERATION MODE

The Auto operation will be activated immediately once the Auto Switch is pressed.

2. TEST RUN OPERATION (FOR PUMP DOWN/SERVICING PURPOSE)

The Test Run operation will be activated if the Auto Switch is pressed continuously for more than 5 sec. to below 10 sec.. A "pep" sound will occur at the fifth sec., in order to identify the starting of Test Run operation

3. HEATING CONTROLLER RECEIVING SOUND ON/OFF

The ON/OFF of remote controller receiving sound can be changed over by following steps:

4. REMOTE CONTROLLER RECEIVING SOUND ON/OFF

The ON/OFF of remote controller receiving sound can be changed over by following steps:

- a. Press "AUTO" switch continuously for more than 16 sec. to below 21 sec. A "pep" "pep" sound will occur at sixteenth sec..
- b. Press the "Check" button once at remote controller. A "pep" sound will occur.
- c. Press the "AUTO" switch once to select remote controller receiving sound ON/OFF. A "pep" sound indicates receiving sound ON, and a "pep" sound indicates receiving sound OFF.

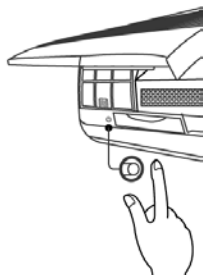

11.3. OUTDOOR UNIT

11.3.1. SELECT THE BEST LOCATION (Refer to "Select the best location" section)

11.3.2. INSTALL THE OUTDOOR UNIT

- After selecting the best location, start installation according to Indoor/Outdoor Unit Installation Diagram.

1. Fix the unit on concrete or rigid frame firmly and horizontally by bolt nut. ($\phi 10$ mm).
2. When installing at roof, please consider strong wind and earthquake. Please fasten the installation stand firmly with bolt or nails.

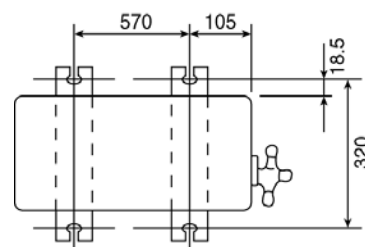

11.3.3. CONNECTING THE PIPING

Connecting The Piping To Indoor Unit

Please make flare after inserting flare nut (locate at joint portion of tube assembly) onto the copper pipe. (In case of using long piping)

Connect the piping

- Align the center of piping and sufficiently tighten the flare nut with fingers.
- Further tighten the flare nut with torque wrench in specified torque as stated in the table.

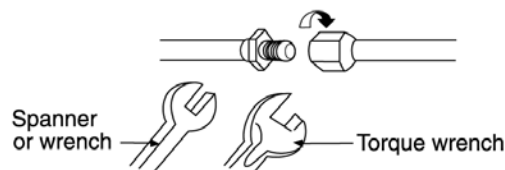

MODEL	Piping size (Torque)	
	Gas	Liquid
E9CK	3/8" (42 N.m)	1/4" (18 N.m)
E12CK, E15CK	1/2" (55 N.m)	1/4" (18 N.m)

Connecting The Piping To Outdoor Unit

Decide piping length and then cut by using pipe cutter. Remove burrs from cut edge. Make flare after inserting the flare nut (located at valve) onto the copper pipe.

Align center of piping to valves and then tighten with torque wrench to the specified torque as stated in the table.

CUTTING AND FLARING THE PIPING

1. Please cut using pipe cutter and then remove the burrs.
2. Remove the burrs by using reamer. If burrs is not removed, gas leakage may be caused.
Turn the piping end down to avoid the metal powder entering the pipe.
3. Please make flare after inserting the flare nut onto the copper pipes.

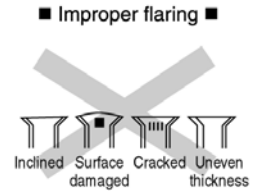
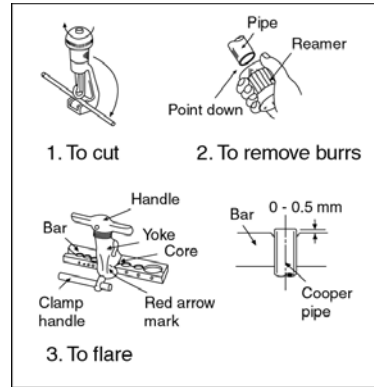

When properly flared, the internal surface of the flare will evenly shine and be of even thickness. Since the flare part comes into contact with the connections, carefully check the flare finish.

11.3.4. (a) EVACUATION OF THE EQUIPMENT (FOR EUROPE & OCEANIA DESTINATION)

WHEN INSTALLING AN AIR CONDITIONER, BE SURE TO EVACUATE THE AIR INSIDE THE INDOOR UNIT AND PIPES in the following procedure.

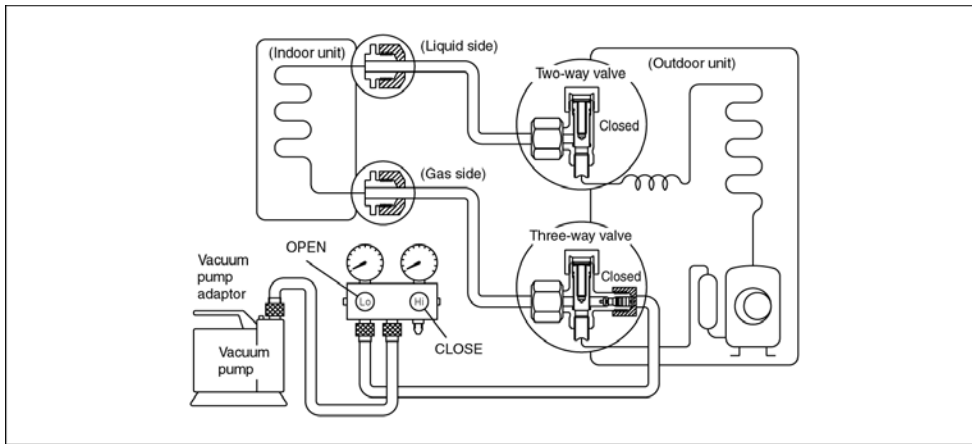

1. Connect a charging hose with a push pin to the Low and High side of a charging set and the service port of the 3-way valve.
 - Be sure to connect the end of the charging hose with the push pin to the service port.
2. Connect the center hose of the charging set to a vacuum pump with check valve, or vacuum pump and vacuum pump adaptor.
3. Turn on the power switch of the vacuum pump and make sure that the needle in the gauge moves from 0 cmHg (0 MPa) to -76 cmHg (-0.1 MPa). Then evacuate the air approximately ten minutes.
4. Close the Low side valve of the charging set and turn off the vacuum pump. Make sure that the needle in the gauge does not move after approximately five minutes.







Note: BE SURE TO FOLLOW THIS PROCEDURE IN ORDER TO AVOID REFRIGERANT GAS LEAKAGE.
5. Disconnect the charging hose from the vacuum pump and from the service port of the 3-way valve.
6. Tighten the service port caps of the 3-way valve at torque of 18 N.m with a torque wrench.
7. Remove the valve caps of both of the 2-way valve and 3-way valve. Position both of the valves to "OPEN" using a hexagonal wrench (4 mm).
8. Mount valve caps onto the 2-way valve and the 3-way valve.
 - Be sure to check for gas leakage.

CAUTION

- If gauge needle does not move from 0 cmHg (0 MPa) to -76 cmHg (-0.1 MPa), in step 3 above take the following measure:
 - If the leak stops when the piping connections are tightened further, continue working from step 3.
 - If the leak does not stop when the connections are retightened, repair the location of leak.
 - Do not release refrigerant during piping work for installation and reinstallation. Take care of the liquid refrigerant, it may cause frostbite.

11.3.5. CONNECT THE CABLE TO THE OUTDOOR UNIT

1. Remove the control board cover from the unit by loosening the screw.
2. Connecting cable between indoor unit and outdoor unit shall be approved polychloroprene sheathed 4 (E9CK, E12CK, E15CK) × 1.5 mm² flexible cord, type designation 245 IEC 57 or heavier cord.

Terminals on the indoor unit	1	2	3	
Color of wires				
Terminals on the outdoor unit	1	2	3	

3. Secure the cable onto the control board with the holder (clamper).
4. Attach the control board cover back to the original position with the screw.

11.3.6. PIPE INSULATION

1. Please carry out insulation at pipe connection portion as mentioned in Indoor/Outdoor Unit Installation Diagram. Please wrap the insulated piping end to prevent water from going inside the piping.
2. If drain hose or connecting piping is in the room (where dew may form), please increase the insulation by using POLY-E FOAM with thickness 6 mm or above.

DISPOSAL OF OUTDOOR UNIT DRAIN WATER

- If a drain elbow is used, the unit should be placed on a stand which is taller than 3 cm.
- If the unit is used in an area where temperature falls below 0°C for 2 or 3 days in succession, it is recommended not to use a drain elbow, for the drain water freezes and the fan will not rotate.

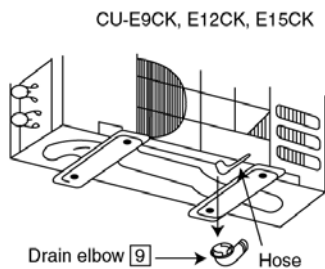

Install the hose at an angle so that the water smoothly flows out.

CHECK THE DRAINAGE

- Open front panel and remove air filters. (Drainage checking can be carried out without removing the front grille.)
- Pour a glass of water into the drain tray-styrofoam.
- Ensure that water flows out from drain hose of the indoor unit.

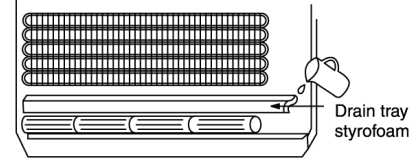

EVALUATION OF THE PERFORMANCE

- Operate the unit at cooling operation mode for fifteen minutes or more.
- Measure the temperature of the intake and discharge air.
- Ensure the difference between the intake temperature and the discharge is more than 8°C.

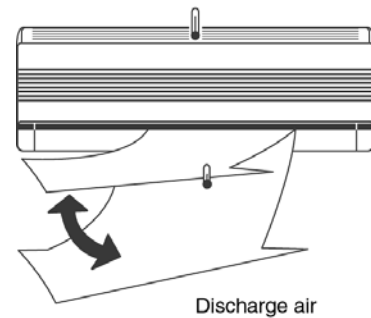

CHECK ITEMS

- Is there any gas leakage at flare nut connections?
- Has the heat insulation been carried out at flare nut connection?
- Is the connecting cable being fixed to terminal board firmly?
- Is the connecting cable being clamped firmly?
- Is the drainage OK?
(Refer to "Check the drainage" section)
- Is the earth wire connection properly done?
- Is the indoor unit properly hooked to the installation plate?
- Is the power supply voltage complied with rated value?
- Is there any abnormal sound?
- Is the cooling operation normal?
- Is the thermostat operation normal?
- Is the remote control's LCD operation normal?
- Is the air purifying filter installed?

12 Servicing Information

Caution:

- Pb free solder has a higher melting point than standard solder; Typically the melting point is 50 - 70°F (30 - 40°C) higher. Please use a high temperature soldering iron. In case of the soldering iron with temperature control, please set it to 700 ± 20°F (370 ± 10°C).
- Pb free solder will tend to splash when heated too high (about 1100° F/600°C).

12.1. Troubleshooting

1. Rated Frequency Operation

During troubleshooting and servicing, rated compressor operating frequency must be obtained in order to check the specification and technical data. Below are the methods used to obtain rated compressor operating specification.

(a) Cooling

- Press the Auto button continuously for 5 seconds or less than 8 seconds, the air conditioner starts operation at Cooling rated frequency. ("beep" will be heard at the 5th second.)

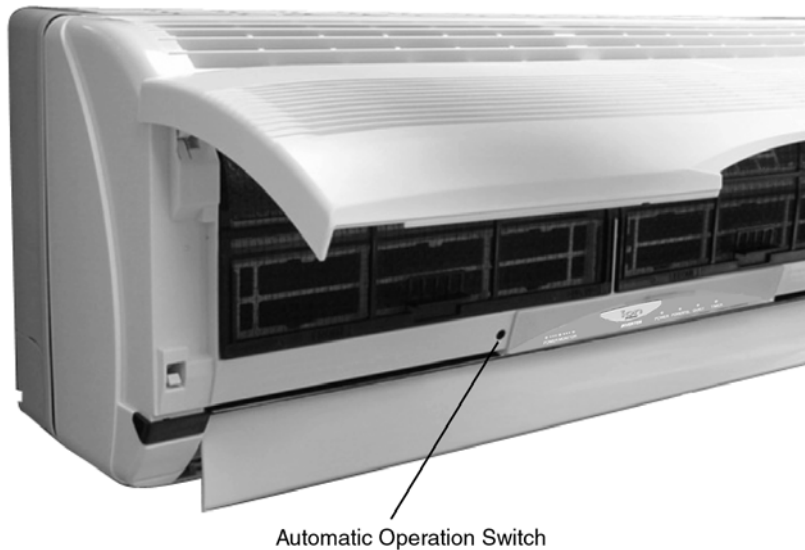

- Short the service terminal (CN-S) of the outdoor printed circuit board. The operation of air conditioner is Cooling rated frequency.

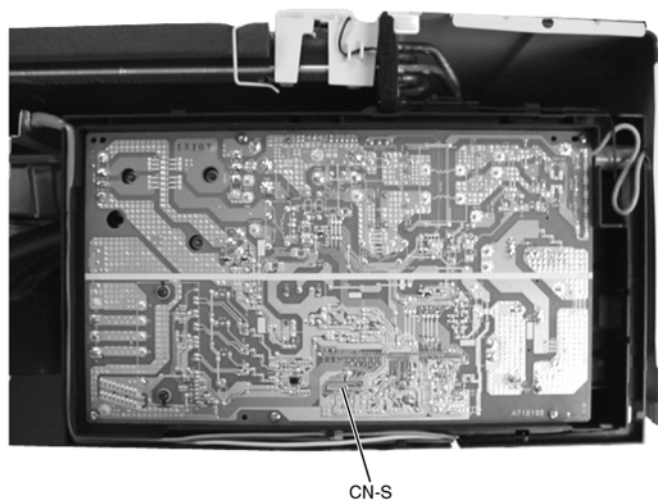

(b) Heating

Press the Auto button continuously for 8 seconds or less than 11 seconds, the air conditioner starts operation at Heating rated frequency. ("beep" "beep" will be heard at the 8th second.)

2. Troubleshooting Air Conditioner

Refrigeration cycle system

In order to diagnose malfunctions, make sure that there are no electrical problems before inspecting the refrigeration cycle. Such problems include insufficient insulation, problem with the power source, malfunction of a compressor and a fan.

The normal outlet air temperature and pressure of the refrigeration cycle depends on various conditions, the standard values for them are shown in the table to the right.

Normal Pressure and Outlet Air Temperature (Standard)

	Gas pressure MPa (kg/cm ² G)	Outlet air temperature (°C)
Cooling Mode	0.9 ~ 1.2 (9 ~ 12)	12 ~ 16
Heating Mode	2.3 ~ 2.9 (23 ~ 29)	36 ~ 45

- ★ Condition:
- Indoor fan speed; High
 - Outdoor temperature 35°C at cooling mode and 7°C at heating mode.
 - Compressor operates at rated frequency

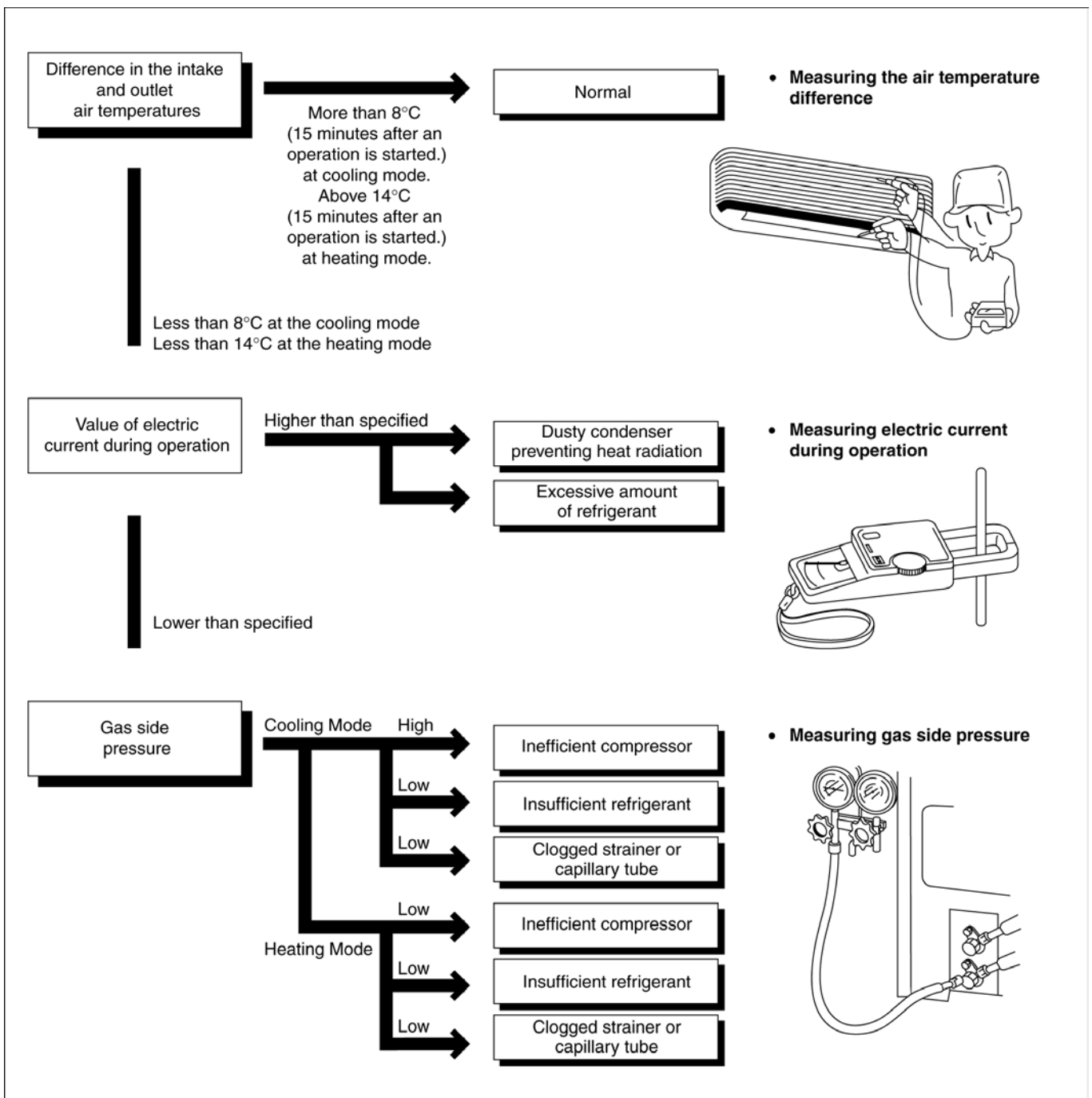

1. Relationship between the condition of the air conditioner and pressure and electric current

Condition of the air conditioner	Cooling Mode			Heating Mode		
	Low Pressure	High Pressure	Electric current during operation	Low Pressure	High Pressure	Electric current during operation
Insufficient refrigerant (gas leakage)	↘	↘	↘	↘	↘	↘
Clogged capillary tube or Strainer	↘	↘	↘	↗	↗	↗
Short circuit in the indoor unit	↘	↘	↘	↗	↗	↗
Heat radiation deficiency of the outdoor unit	↗	↗	↗	↘	↘	↘
Inefficient compression	↗	↘	↘	↗	↘	↘

- Carry on the measurements of pressure, electric current, and temperature fifteen minutes after an operation is started.

12.2. Breakdown Self Diagnosis Function

Once abnormality detected during operation, the unit will immediately stop its operation (Timer LED is blinking) and maximum of three error codes (abnormality) will be saved in memory. The abnormality of the operation can be identified through the below breakdown diagnosis method:

- Press "CHECK" button at remote controller continuously for more than five seconds to turn on the diagnosis mode, "H11" will be displayed at remote controller.
- By pressing the TMER "Λ" button once, next error code will be displayed; press "V" button once, previous error code will be displayed.
- If error code displayed matches the error code saved in unit memory (abnormality detected), four "beep" sounds will be heard and Power LED will light on. Otherwise, one "beep" sound is heard.

If "CHECK" button is press again or without any operation for 30 seconds, the diagnosis mode will turn off.

Error Codes Table

Diagnosis display	Abnormality / Protection control	Abnormality Judgement	Emergency operation	Primary location to verify
H11	Indoor / outdoor abnormal communication	> 1 min after starting operation	Indoor fan operation only	<ul style="list-style-type: none"> • Internal / external cable connections • Indoor / Outdoor PCB
H14	Indoor intake air temperature sensor abnormality	—	—	<ul style="list-style-type: none"> • Intake air temperature sensor (defective or disconnected)
H15	Outdoor compressor temperature sensor abnormality	Continue for 5 sec.	—	<ul style="list-style-type: none"> • Compressor temperature sensor (defective or disconnected)
H16	Outdoor Current Transformer open circuit	—	—	<ul style="list-style-type: none"> • Outdoor PCB • IPM (Power transistor) module
H19	Indoor fan motor mechanism lock	—	—	<ul style="list-style-type: none"> • Indoor PCB • Fan motor
H23	Indoor heat exchanger temperature sensor abnormality	Continue for 5 sec.	O (Cooling only)	<ul style="list-style-type: none"> • Heat exchanger temperature sensor (defective or disconnected)
H27	Outdoor air temperature sensor abnormality	Continue for 5 sec.	O	<ul style="list-style-type: none"> • Outdoor temperature sensor (defective or disconnected)
H28	Outdoor heat exchanger temperature sensor abnormality	Continue for 5 sec.	O	<ul style="list-style-type: none"> • Outdoor heat exchanger temperature sensor (defective or disconnected)
H33	Indoor/Outdoor wrong connection	—	—	<ul style="list-style-type: none"> • Indoor/Outdoor supply voltage
H98	Indoor high pressure protection	—	—	<ul style="list-style-type: none"> • Air filter dirty • Air circulation short circuit
H99	Indoor heat exchanger anti-freezing protection	—	—	<ul style="list-style-type: none"> • Insufficient refrigerant • Air filter dirty
F11	Cooling / Heating cycle changeover abnormality	4 times occurrence within 30 minutes	—	<ul style="list-style-type: none"> • 4-way valve • V-coil
F90	PFC control	4 times occurrence within 10 minutes	—	<ul style="list-style-type: none"> • Voltage at PFC
F91	Refrigeration cycle abnormality	2 times occurrence within 20 minutes	—	<ul style="list-style-type: none"> • No refrigerant (3-way valve is closed)
F95	Cool high pressure protection	4 times occurrence within 20 minutes	—	<ul style="list-style-type: none"> • Outdoor refrigerant circuit
F96	IPM (power transistor) overheating protection	—	—	<ul style="list-style-type: none"> • Excess refrigerant • Improper heat radiation • IPM (Power transistor)
F97	Outdoor compressor overheating protection	4 times occurrence within 10 minutes	—	<ul style="list-style-type: none"> • Insufficient refrigerant • Compressor
F98	Total running current protection	3 times occurrence within 20 minutes	—	<ul style="list-style-type: none"> • Excess refrigerant • Improper heat radiation
F99	Outdoor Direct Current (DC) peak detection	7 times occurrence continuously	—	<ul style="list-style-type: none"> • Outdoor PCB • IPM (Power transistor) • Compressor

Note:

“O” - Frequency measured and fan speed fixed.

The memory data of error code is erased when the power supply is cut off, or press the Auto Switch until “beep” sound heard following by pressing the “RESET” button at remote controller.

Although operation forced to stop when abnormality detected, emergency operation is possible for certain errors (refer to Error Codes Table) by using remote controller or Auto Switch at indoor unit. However, the remote controller signal receiving sound is changed from one “beep” to four “beep” sounds.

12.3. Remote Control

• Remote Control Reset

When the batteries are inserted for the first time, or the batteries are replaced, all the indications will blink and the remote control might not work.

If this happen, remove the cover of the remote control and push the reset point once to clear the memory data.

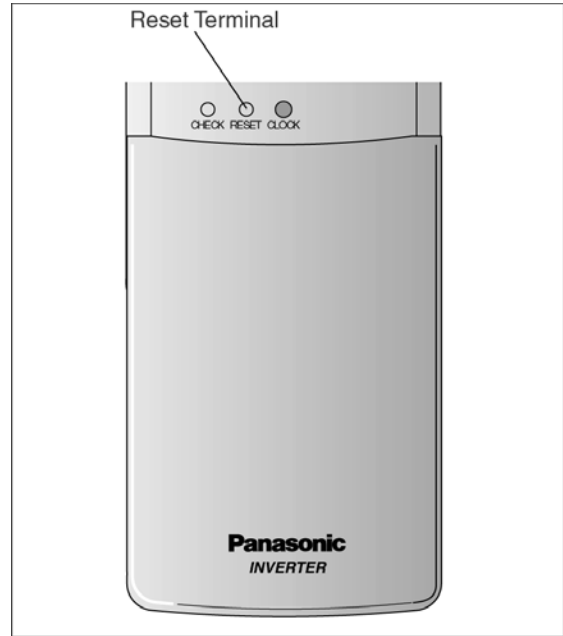

• Changing the wireless remote control transmission code

When there are more than one indoor units installed in the same room, it is possible to set different remote control receiving signal by modifying the jumpers inside remote controller.

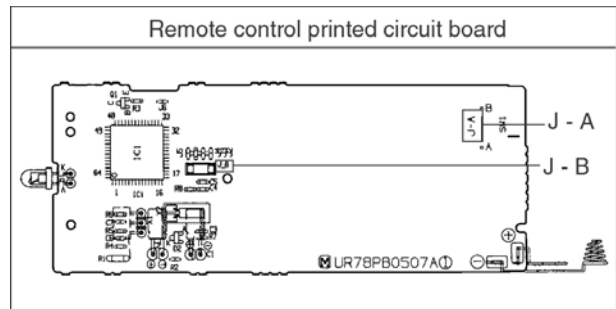

	Remote control printed circuit board		Note
	J - A	J - B	
0	SHORT	OPEN	At product delivery
1	OPEN	OPEN	
2	SHORT	SHORT	
3	OPEN	SHORT	

12.4. Disassembly of Parts

a. Indoor Control Board Removal Procedures

1. Remove the Front Grille



Remove caps and screws

Fig. 1



Remove the Front Grille

Fig. 2

2. Remove the Indoor Control Board

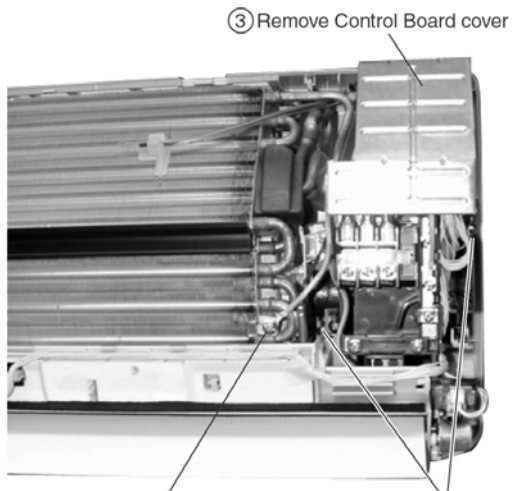

③ Remove Control Board cover

② Remove Earth Wire screw

① Remove screws

Fig. 3

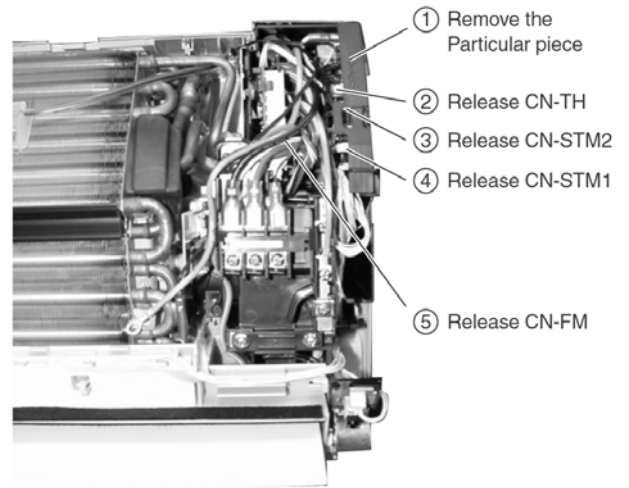

① Remove the Particular piece

② Release CN-TH

③ Release CN-STM2

④ Release CN-STM1

⑤ Release CN-FM

Fig. 4

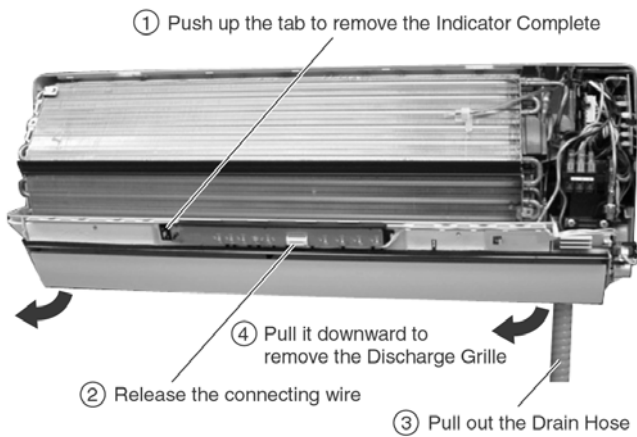

① Push up the tab to remove the Indicator Complete

② Release the connecting wire

④ Pull it downward to remove the Discharge Grille

③ Pull out the Drain Hose

Fig. 5

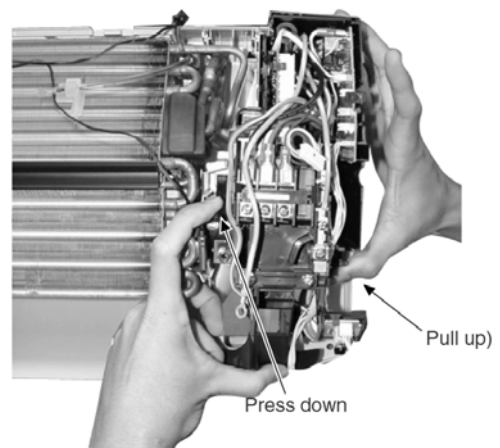

Pull up)

Press down

Fig. 6

b. Electronic Controller Removal Procedures

1. Remove Main Electronic Controller

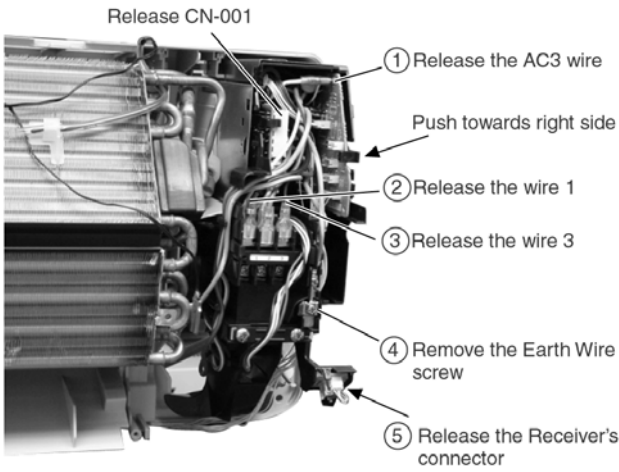

Fig. 7

2. Remove Power Electronic Controller

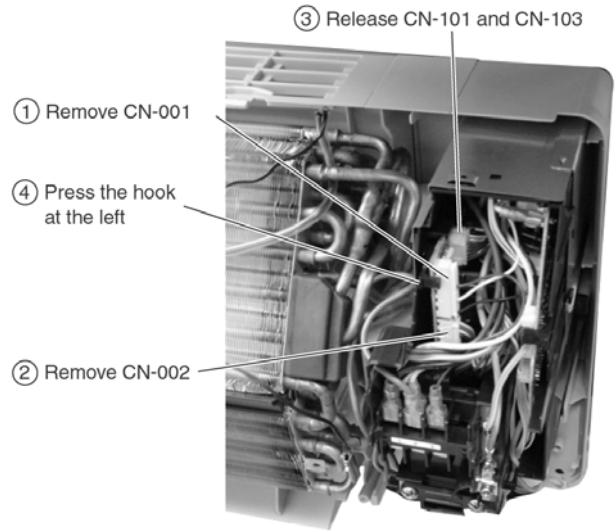
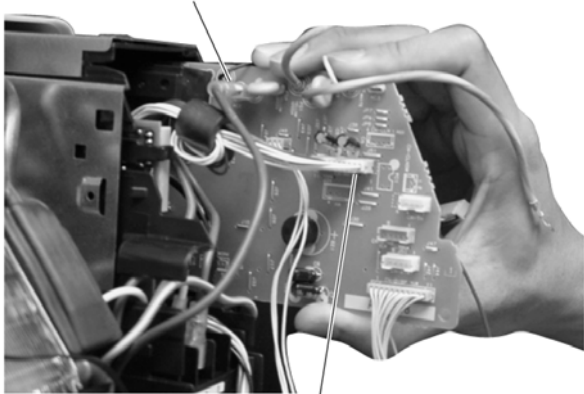

Fig. 10

① Pull the Electronic Controller partially out until you are able to remove the wire



② Release CN-MAIN

Fig. 8

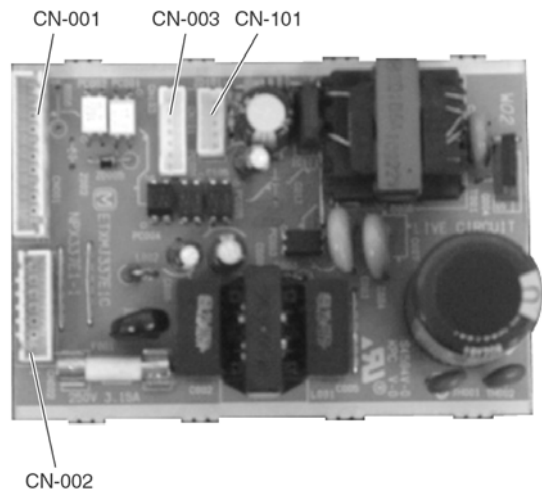

Fig. 11

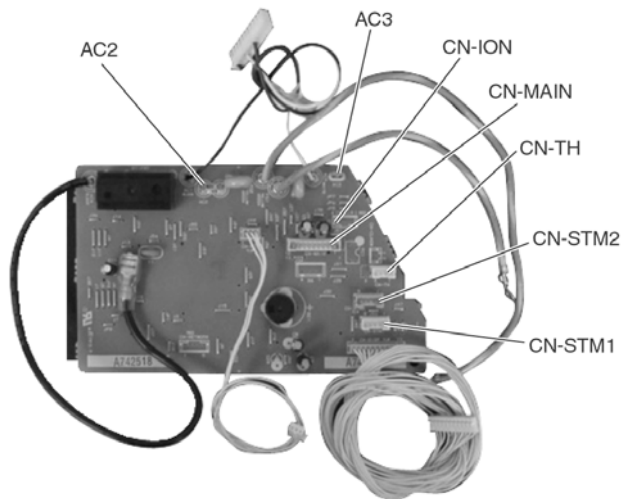

Fig. 9

c. Cross Flow Fan and Fan Motor Removal Procedures

1. Remove Cross Flow Fan

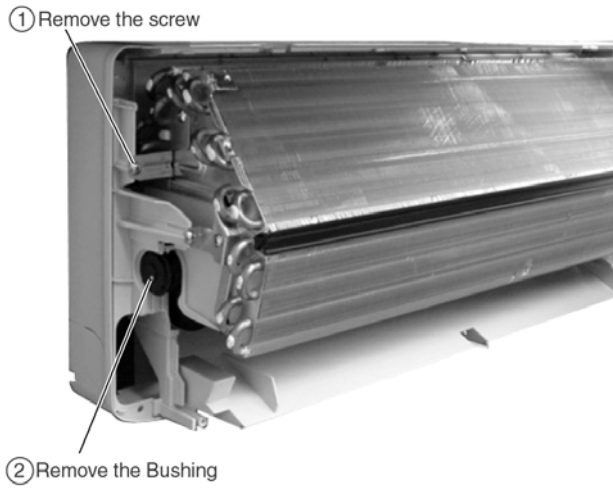
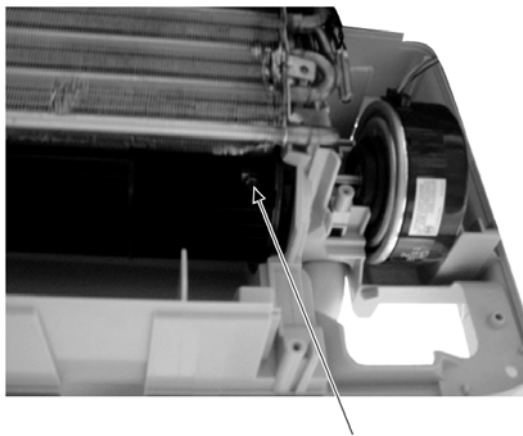

Fig. 12



Fig. 13

2. Remove the Fan Motor



Remove the screw that holding the Fan Motor and Cross Flow Fan

Fig. 14

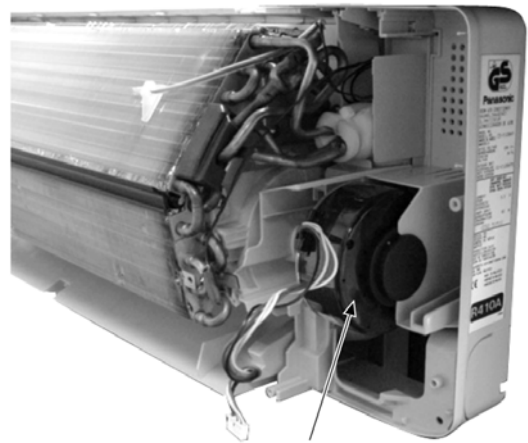

Fan Motor

Fig. 15

c. Outdoor Electronic Controller Removal Procedure

1. Remove the top panel and front panel

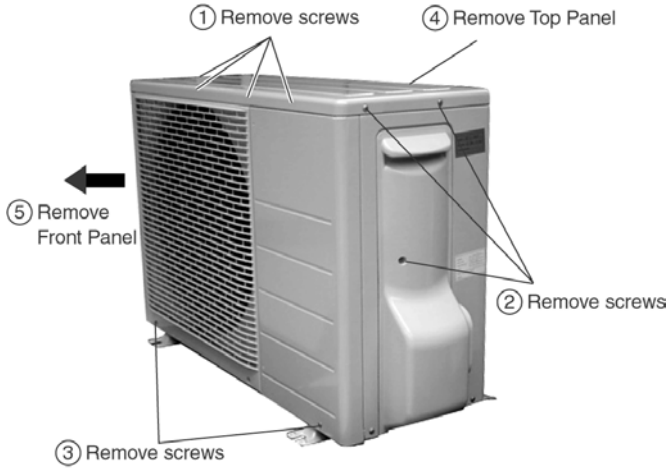

Fig. 16

! WARNING

- Be save to return the wiring to its original position
- There are many high voltage components within the heat sink cover so never touch the interior during operation. Wait at least two minutes after power has been turned off.

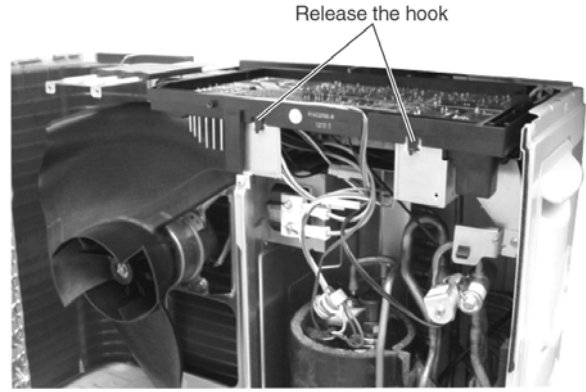

Fig. 17

2. Remove the Outdoor Electronic Controller

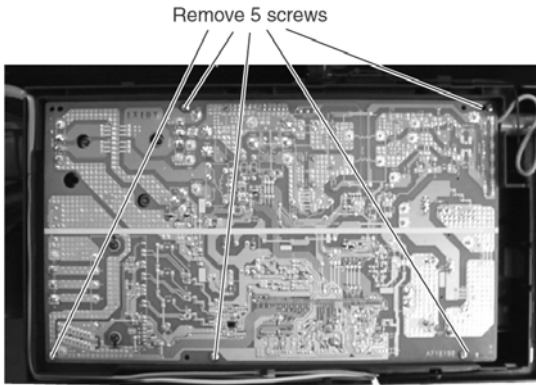

Fig. 18

! Caution! When handling electronic controller, be careful of electrostatic discharge.

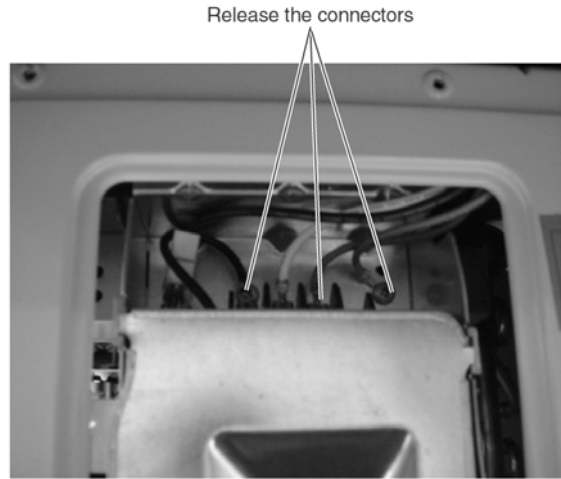

Fig.20



Fig. 19

13 Technical Data

■ Operation characteristics

CS-E15CKP / CU-E15CKP5

• Cooling Characteristic

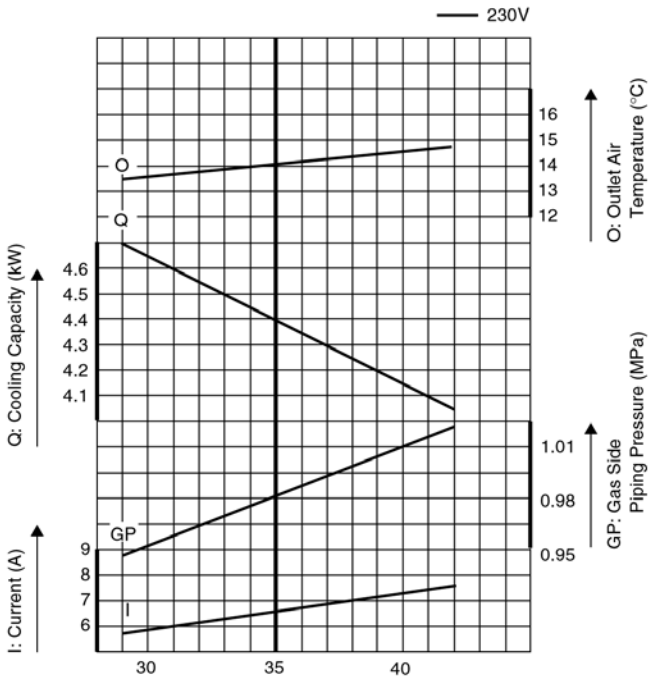

OUTDOOR AIR TEMPERATURE (°C)
 [Condition] Room temperature: 27/19°C
 Cooling Operation: at High Fan
 Piping length: 5m
 Rated Frequency Operation

• Piping Length Characteristic (Cooling)

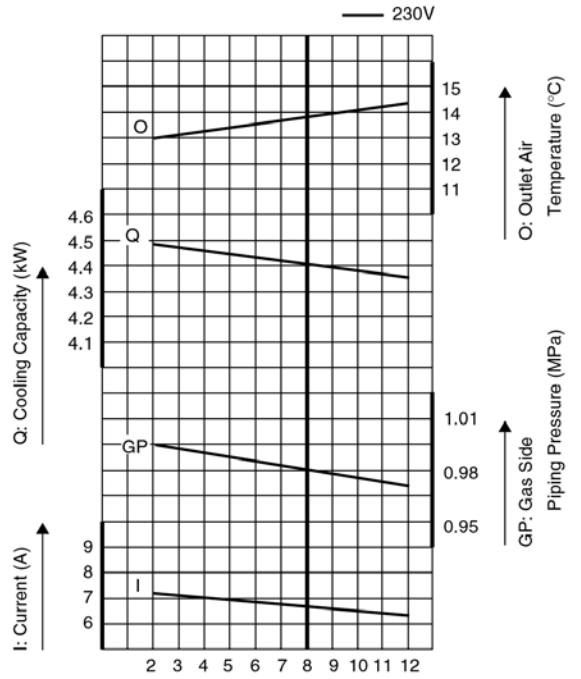

PIPING LENGTH (m)
 [Condition] Room temperature: 27/19°C
 Cooling Operation: at High Fan
 Piping length: 5m
 Rated Frequency Operation

• Heating Characteristic

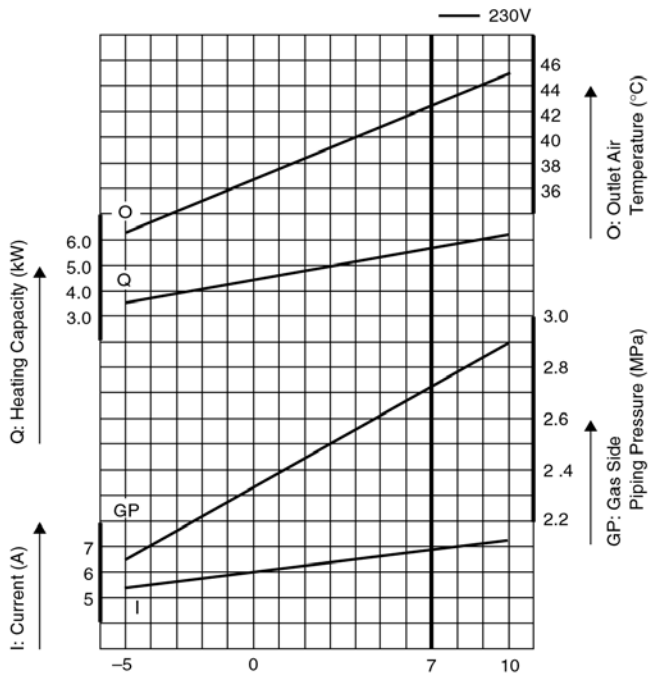

OUTDOOR AIR TEMPERATURE (°C)
 [Condition] Room temperature: 20°C
 Heating Operation: at High Fan
 Piping length: 5m
 Rated Frequency Operation

• Piping Length Characteristic (Heating)

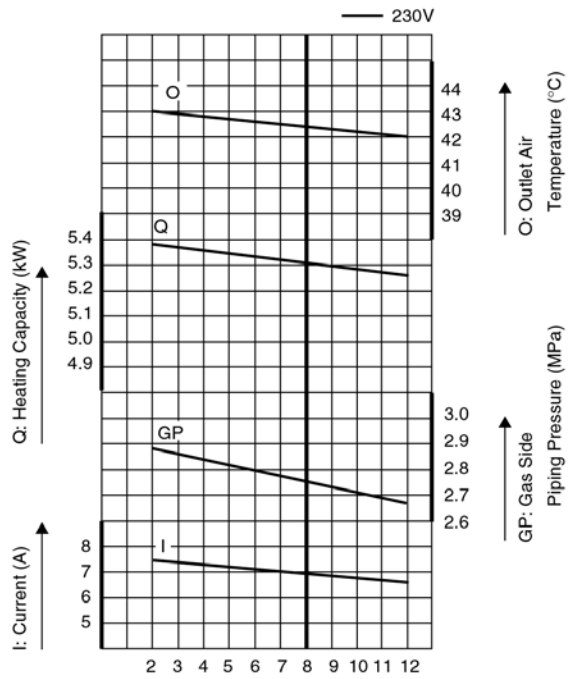

PIPING LENGTH (m)
 [Condition] Room temperature: 20°C
 Heating Operation: 7/6°C
 Piping length: at High Fan
 Rated Frequency Operation

■ Sensible Capacity Chart

• CS-E15CKP / CU-E15CKP5

230V Indoor wet bulb temp.	Outdoor Temp. (°C)											
	30			35			40			46		
	TC	SHC	IP	TC	SHC	IP	TC	SHC	IP	TC	SHC	IP
17.0°C	4.36	3.31	1.28	4.08	3.17	1.38	3.79	3.05	1.48	3.45	2.90	1.59
19.0°C				4.40		1.40						
19.5°C	4.79	3.46	1.31	4.48	3.33	1.41	4.17	3.20	1.50	3.79	3.05	1.62
22.0°C	5.22	3.59	1.33	4.88	3.45	1.43	4.54	3.33	1.53	4.13	3.18	1.65

14 Exploded View

CS-E15CKP

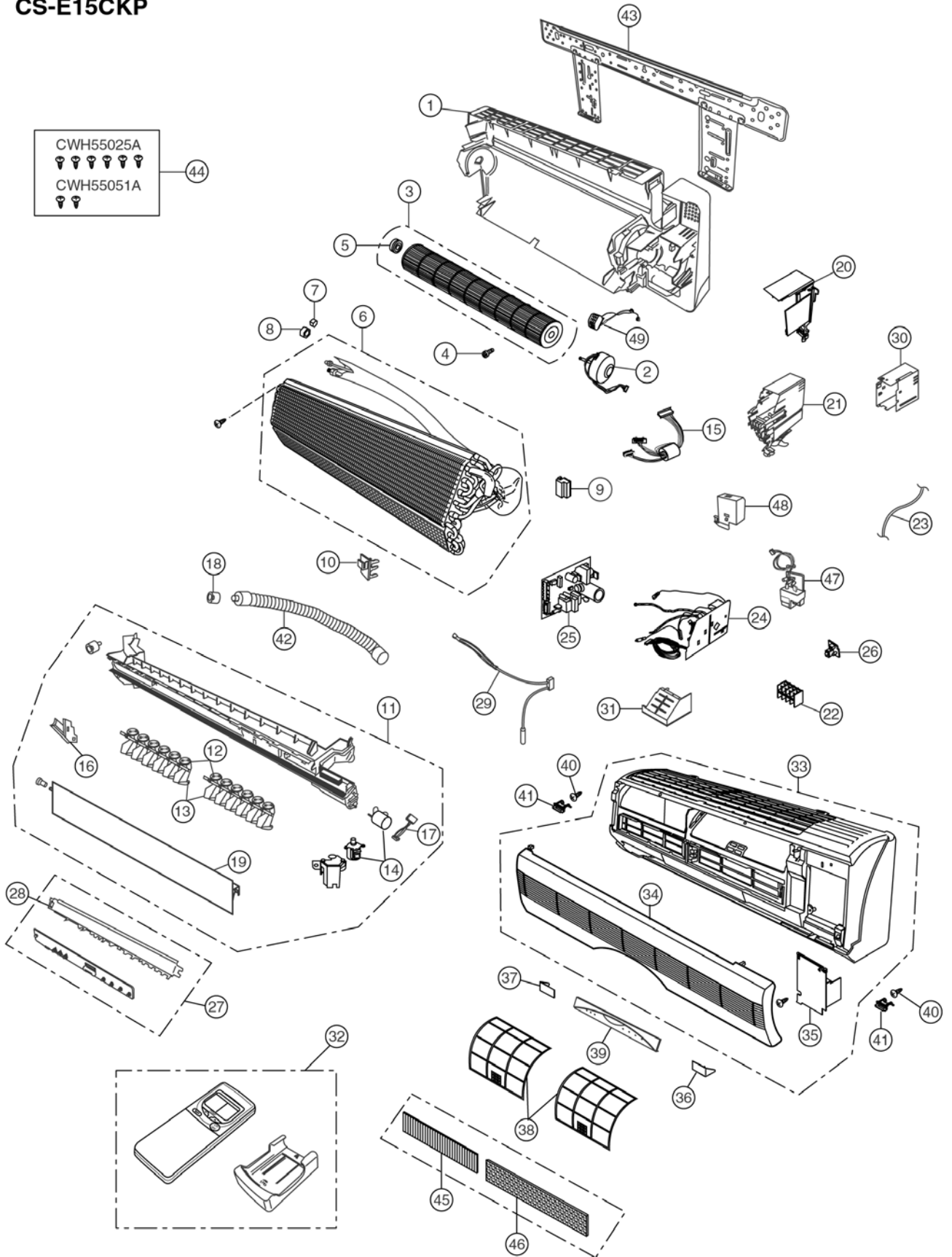

Note:

The above exploded view is for the purpose of parts disassembly and replacement.

The non-numbered parts are not kept as standard service parts.

15 Replacement Parts List

<Model: CS-E15CKP>

REF NO.	DESCRIPTION & NAME	QTY.	CS-E15CKP	REMARKS
1	CHASSY COMPLETE	1	CWD50C1246	
2	FAN MOTOR	1	CWA981056	O
3	CROSS-FLOW FAN COMPLETE	1	CWH02C1012	
4	SCREW - CROSS-FLOW FAN	1	CWH4580304	
5	BEARING ASSY	1	CWH64K007	
6	EVAPORATOR	1	CWB30C1260	
7	FLARE NUT (1/4)	1	CWH6002140	
8	FLARE NUT	1	CWT25007 (1/2)	
9	ANTI-VIBRATION BUSHING	1	-	
10	INTAKE AIR SENSOR HOLDER	1	CWH32142	
11	DISCHARGE GRILLE COMPLETE	1	CWE20C2120	
12	VANE	12	CWE241088	
13	CONNECTING BAR	2	CWE261035	
14	AIR SWING MOTOR	2	CWA98260	O
15	LEADWIRE	1	CWA67C3849	
16	FULCRUM	1	CWH621013	
17	LEADWIRE - AIR SWING MOTOR	1	CWA67C3977	
18	CAP COMPLETE	1	CWH52C1001	
19	VANE	1	CWE241070	
20	PARTICULAR PIECE	1	CWD932162	
21	CONTROL BOARD	1	CWH102103	
22	TERMINAL BOARD COMPLETE	1	CWA28C2128	O
23	POWER SUPPLY CORD	1	CWA20C2238	
24	ELECTRONIC CONTROLLER-MAIN	1	CWA73C1409	O
25	ELECTRONIC CONTROLLER -P.SUPPLY	1	CWA742616	O
26	PCB RECEIVER	1	CWA742724	
27	INDICATOR COMPLETE	1	CWE39C1067	
28	INDICATOR HOLDER	1	CWD932163	
29	SENSOR COMPLETE	1	CWA50C2122	O
30	CONTROL BOARD COVER (TOP)	1	CWH131091	
31	CONTROL BOARD COVER (FRONT)	1	CWH131090	
32	REMOTE CONTROL COMPLETE	1	CWA75C2295	O
33	FRONT GRILLE COMPLETE	1	CWE11C2756	
34	INTAKE GRILLE	1	CWE22C1081	
35	GRILLE DOOR	1	CWE141033	
36	DECORATION BASE (RIGHT)	1	CWE351067	
37	DECORATION BASE (LEFT)	1	CWE351068	
38	AIR FILTER	2	CWD001047	
39	CONTROL PANEL	1	CWE312291	
40	SCREW FOR FRONT GRILLE	2	XTN4+16C	
41	CAP FOR FRONT GRILLE	2	CWH521062	
42	DRAIN HOSE	1	CWH85285	
43	INSTALLING HOLDER ASSY	1	CWH36K1006	
44	BAG COMPLETE FOR INSTALLATION	1	CWH82C067	
45	AIR PURIFYING FILTER	1	CWMD00C0001	O
46	TRIPLE DEODORIZING FILTER	1	CWMD00C0004	O
47	ELECTRONIC CONTROLLER - IONIZER	1	CWA743099	
48	CASING - IONIZER	1	CWD932228	
49	ION GENERATOR	1	CWH94C0001	

(Note)

- All parts are supplied from MAICO, Malaysia (Vendor Code: 061).
- "O" marked parts are recommended to be kept in stock.

16 Exploded View

CU-E15CKP5

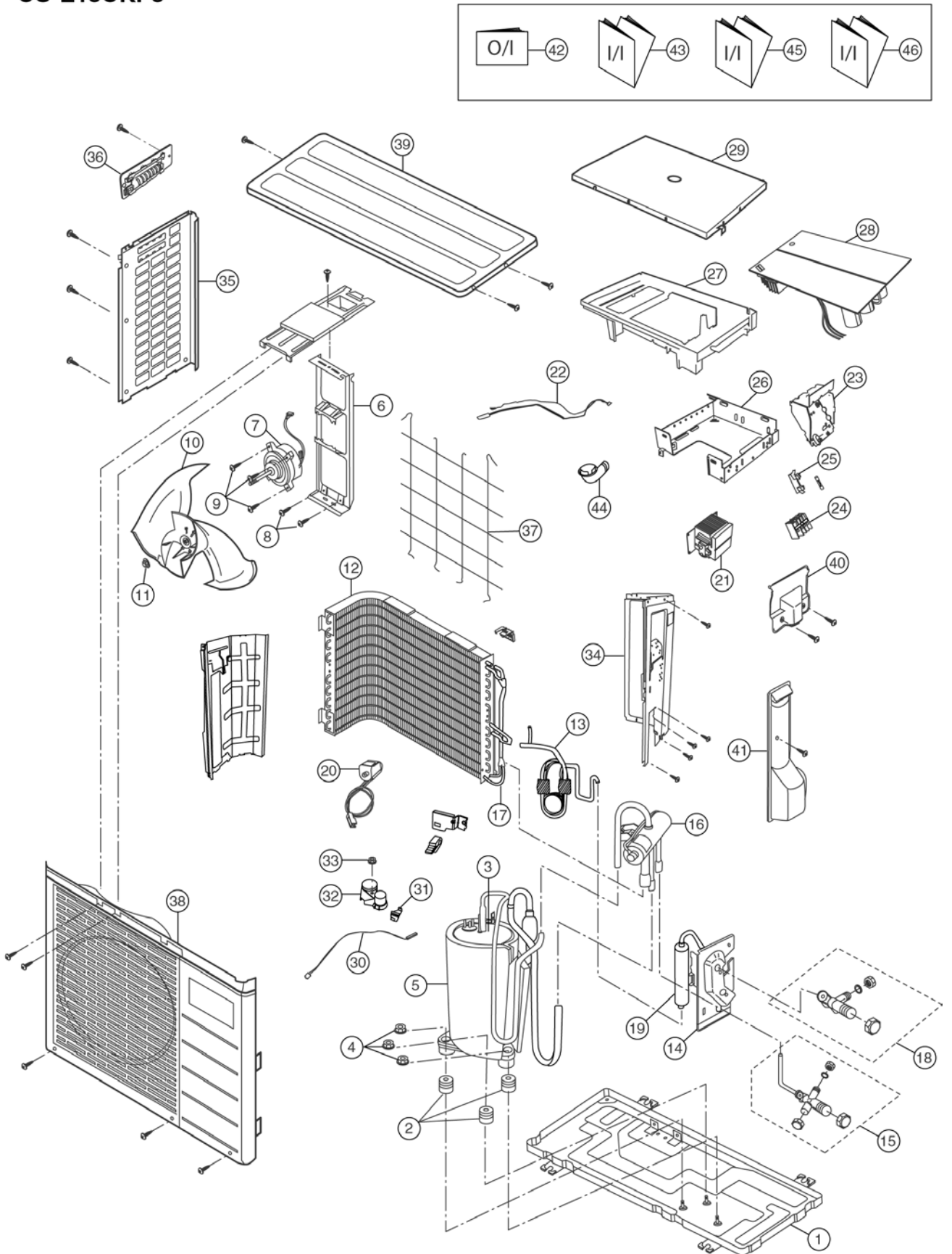

Note:

The above exploded view is for the purpose of parts disassembly and replacement.

The non-numbered parts are not kept as standard service parts.

17 Replacement Parts List

<Model: CU-E15CKP5>

REF NO.	DESCRIPTION & NAME	QTY.	CU-E15CKP5	REMARKS
1	CHASSY ASSY	1	CWD50K2073	
2	ANTI-VIBRATION BUSHING	3	CWH50077	
3	COMPRESSOR	1	5CS102XEC	O
4	NUT-COMPRESSOR MOUNT	3	CWH56000	
5	SOUND PROOF MATERIAL	1	CWG302111	
6	FAN MOTOR BRACKET	1	CWD541030	
7	FAN MOTOR	1	CWA951126	O
8	SCREW - FAN MOTOR BRACKET	2	CWH551060	
9	SCREW - FAN MOTOR MOUNT	4	CWH55406	
10	PROPELLER FAN ASSY	1	CWH03K1006	
11	NUT - PROPELLER FAN	1	CWH56053	
12	CONDENSER	1	CWB32C1146	
13	TUBE ASS'Y CO (CAP./CHK VALVE)	1	CWT01C2361	
14	HOLDER-COUPLING COMPLETE	1	CWT01C2622	O
15	3 WAYS VALVE	1	CWB011075	O
16	4 WAYS VALVE	1	CWB001011	
17	STRAINER	1	CWMB110002	
18	2 WAYS VALVE	1	CWB021065	O
19	DRYER	1	CWB101015	
20	V-COIL COMPLETE	1	CWA43C2072	
21	REACTOR	1	CWA421051	
22	SENSOR COMPLETE	1	CWA50C2115	
23	CONTROL BOARD	1	CWH102122	
24	TERMINAL BOARD ASSY	1	CWA28K1036	
25	FUSE HOLDERS	1	K5D203BBA002	
26	CONTROL BOARD	1	CWH102114	
27	CONTROL BOARD	1	CWH102115	
28	ELECTRONIC CONTROLLER	1	CWA73C1410	
29	CONTROL BOARD COVER	1	CWH131104	
30	SENSOR COMPLETE	1	CWA50C2066	
31	HOLDER SENSOR	1	CWH321010	
32	TERMINAL COVER	1	CWH171001	
33	NUT-TERMINAL COVER	1	CWH7080300	
34	CABINET SIDE PLATE CO.	1	CWE04C1011	
35	CABINET SIDE PLATE (LEFT)	1	CWE041031A	
36	HANDLE	1	CWE161010	
37	WIRE NET	1	CWD041027	
38	CABINET FRONT PLATE CO.	1	CWE06C1039	
39	CABINET TOP PLATE	1	CWE031014A	
40	CONTROL BOARD COVER	1	CWH131110	
41	CONTROL BOARD COVER	1	CWH131093	
42	OPERATING INSTRUCTION	1	CWF563698	
43	INSTALLATION INSTRUCTION	1	CWF612334	
44	L-TUBE	1	CWH5850080	
45	INSTALLATION INSTRUCTION	1	CWF612335	
46	INSTALLATION INSTRUCTION	1	CWF612336	

(Note)

- All parts are supplied from MAICO, Malaysia (Vendor Code: 061).
- "O" marked parts are recommended to be kept in stock.

18 Electronic Circuit Diagram

• CS-E15CKP

SCHEMATIC DIAGRAM 1/3

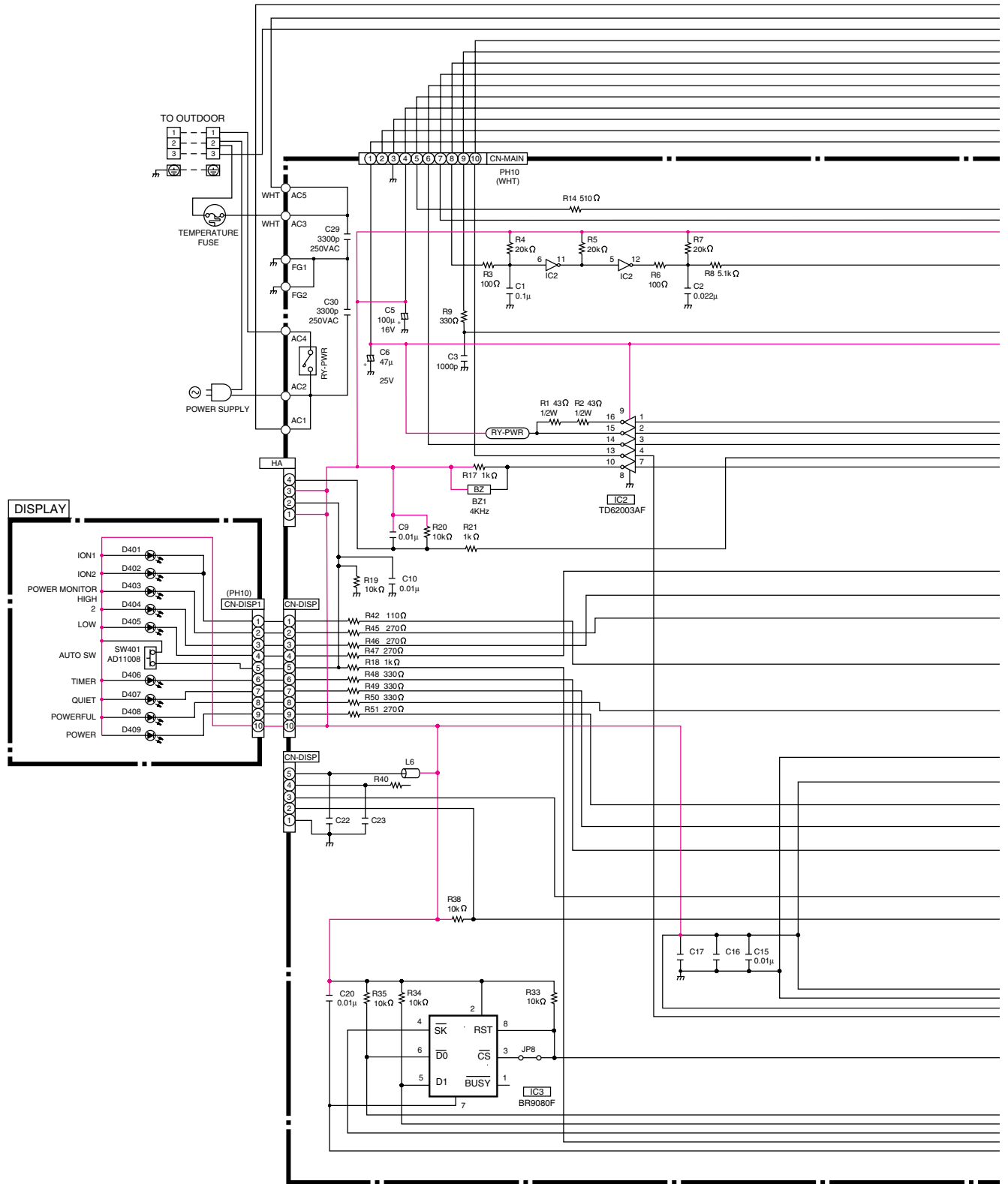

SCHEMATIC DIAGRAM 2/3

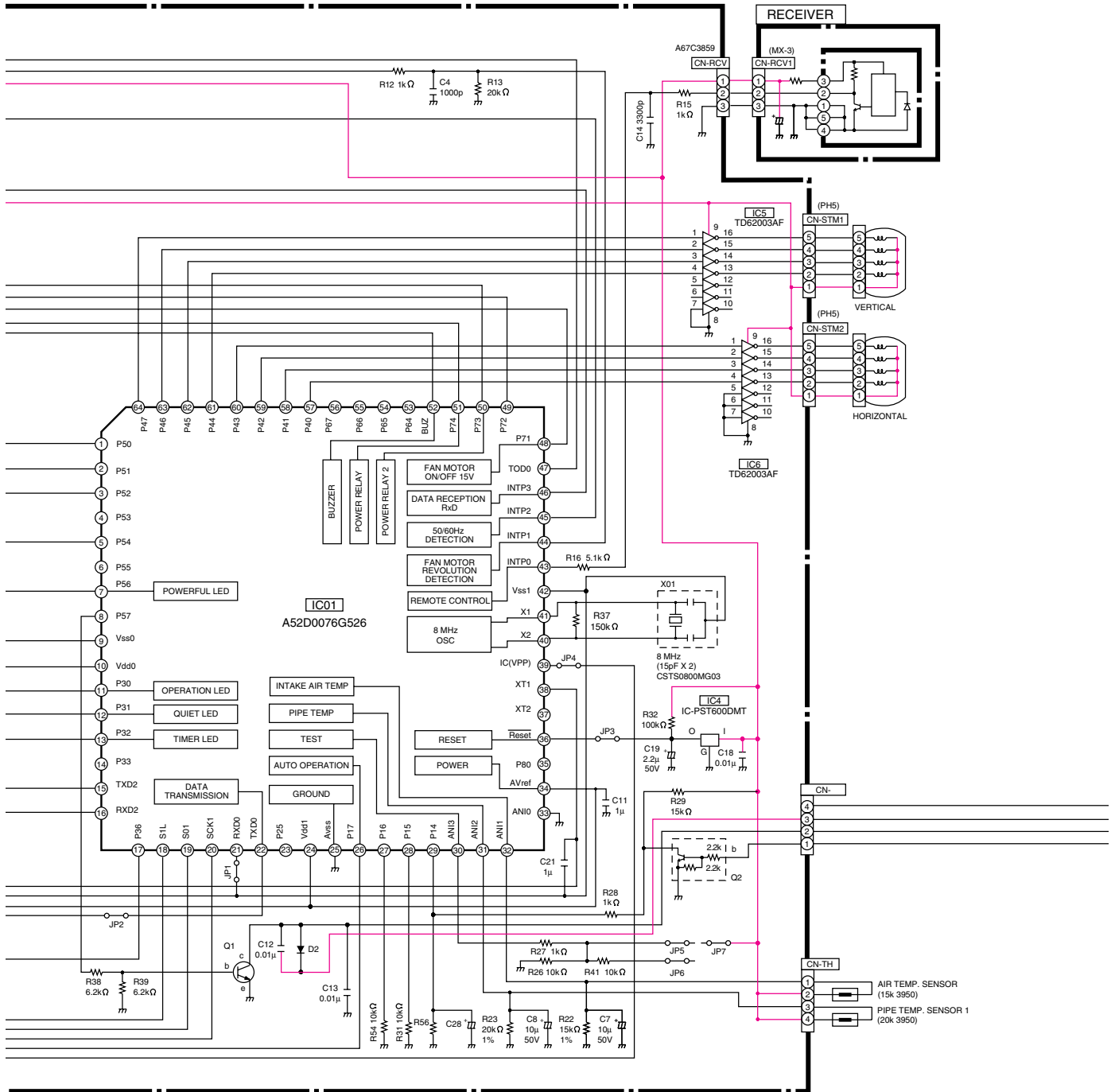

SCHEMATIC DIAGRAM 3/3

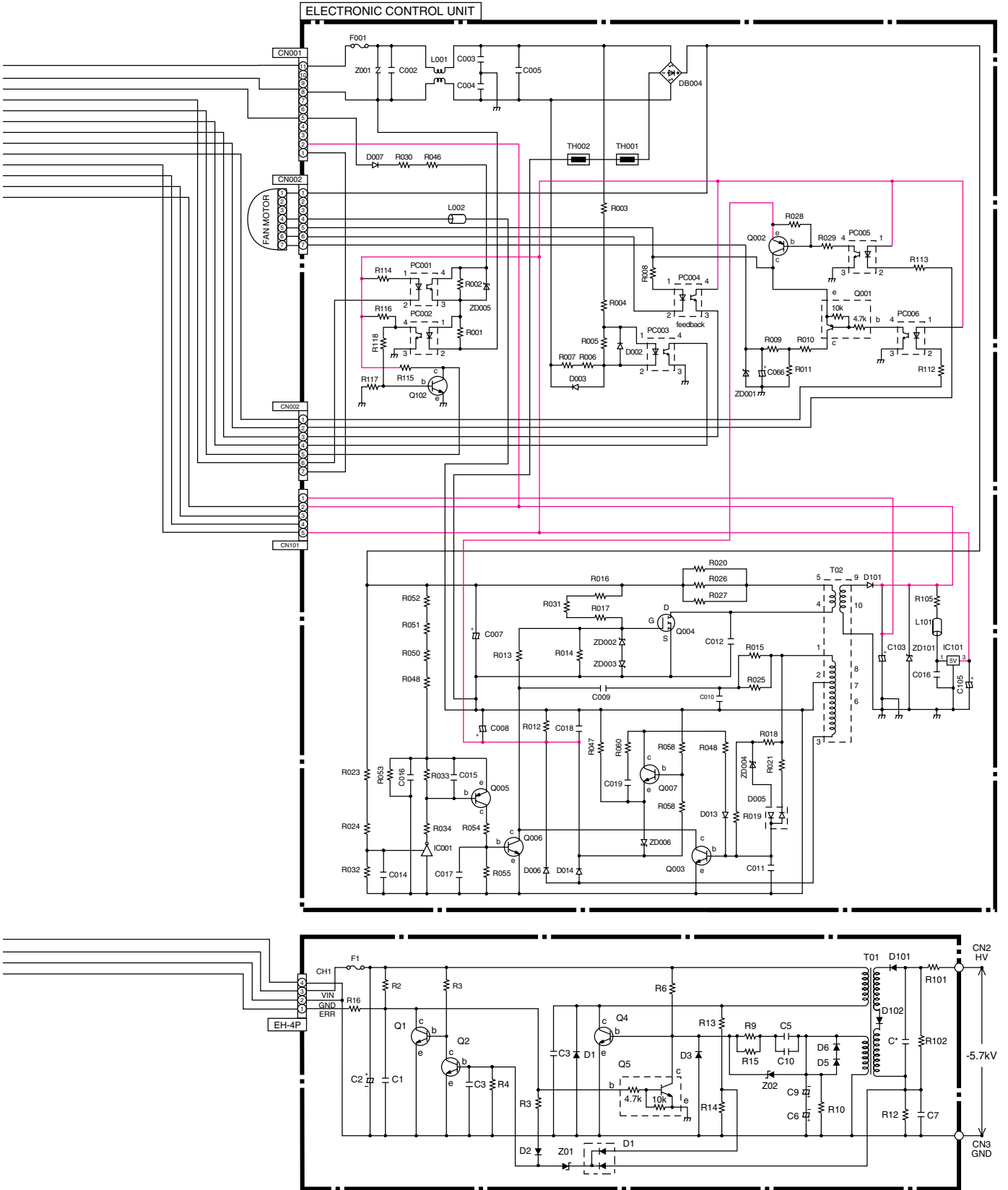

• CU-E15CKP5

SCHEMATIC DIAGRAM 1/3

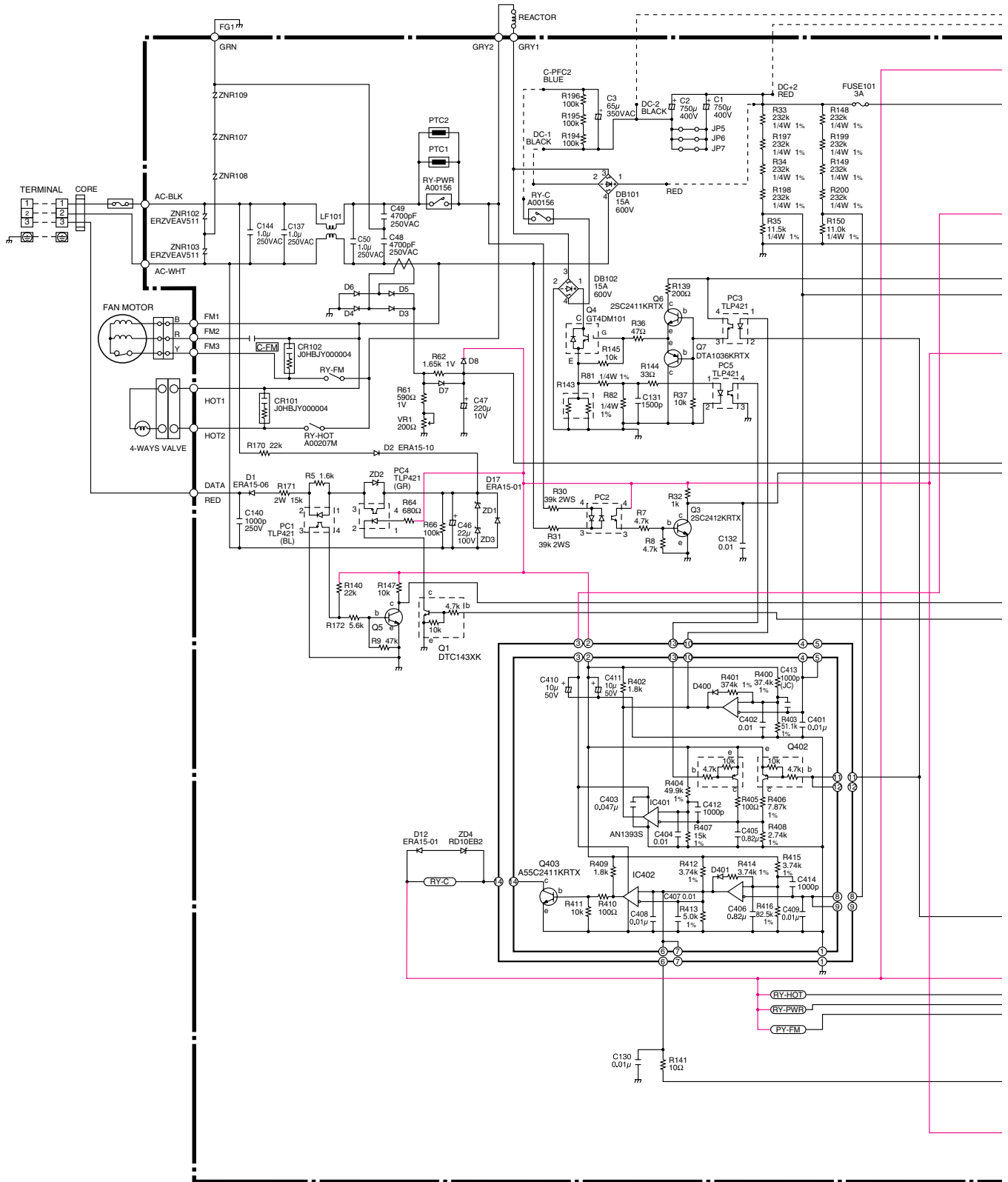

SCHEMATIC DIAGRAM 2/3

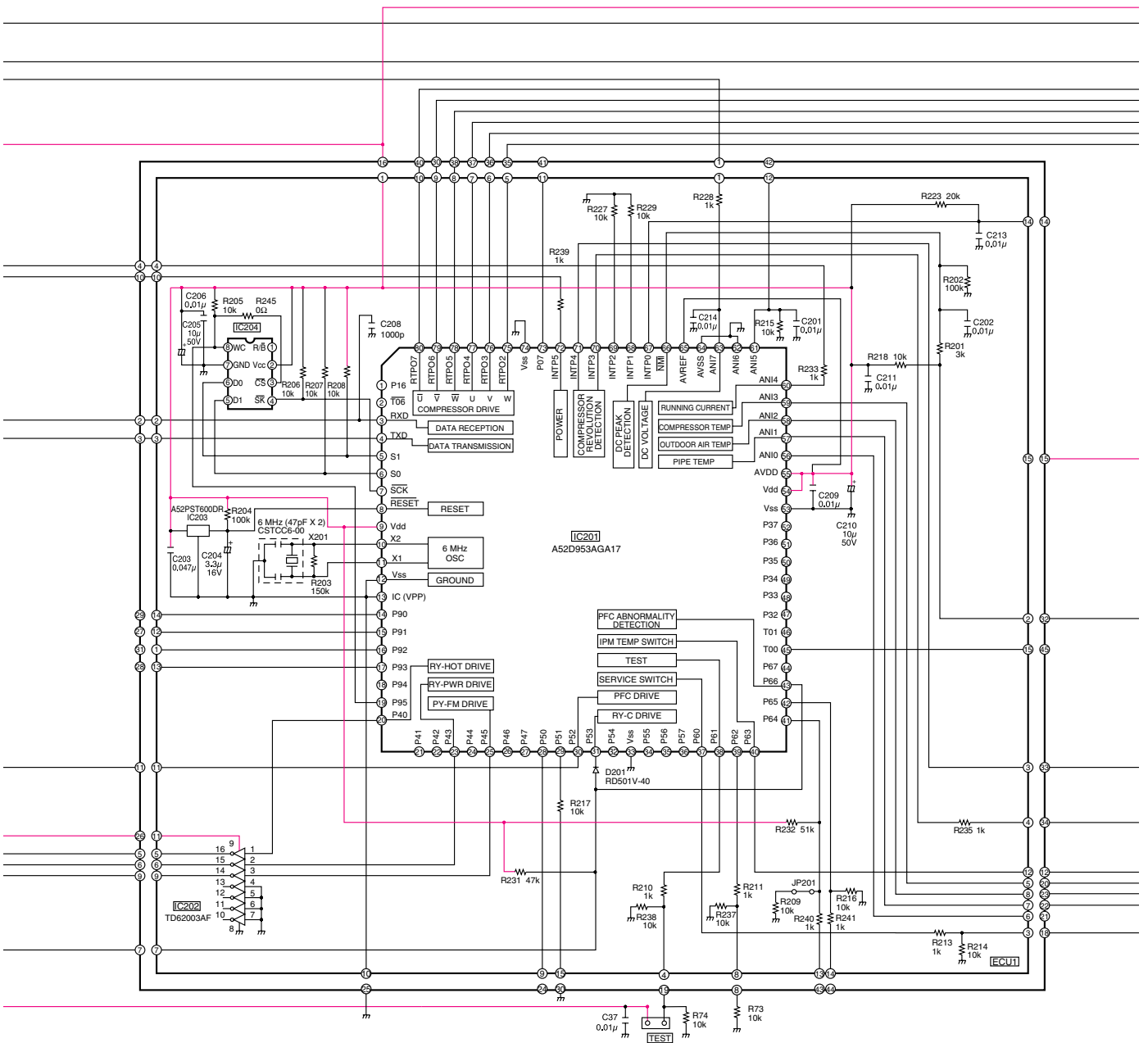

SCHEMATIC DIAGRAM 3/3

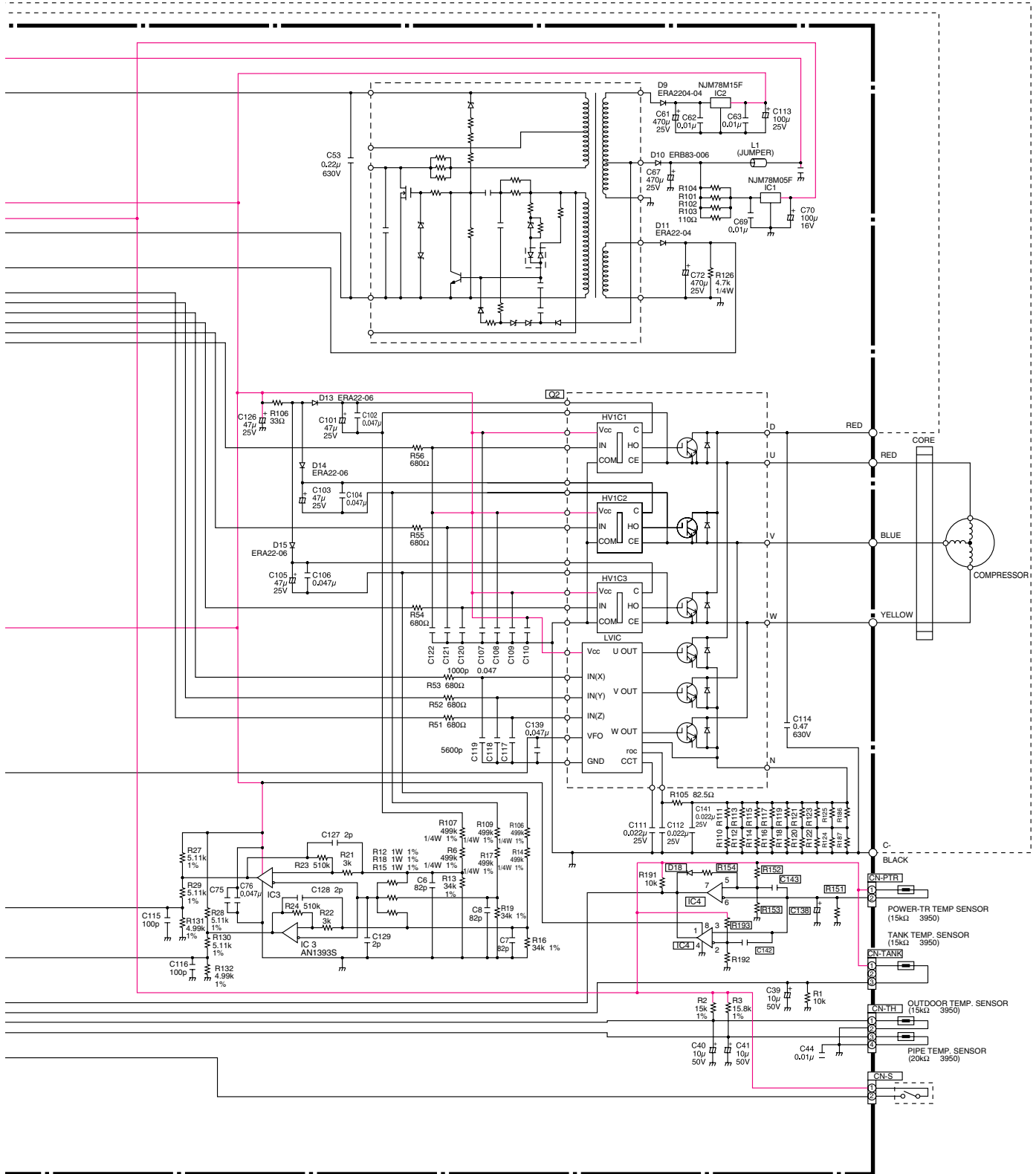

CS-E15CKP

Fig. 1

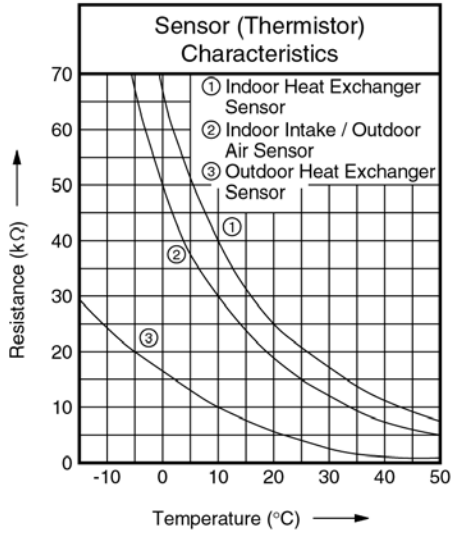
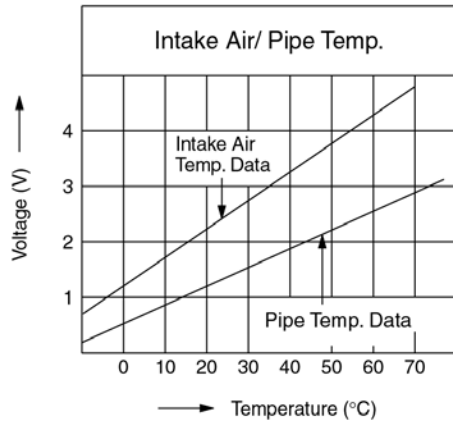

Fig. 2



CU-E15CKP5

Fig. 3

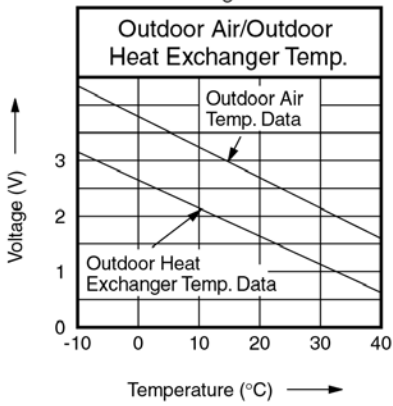

Fig. 4

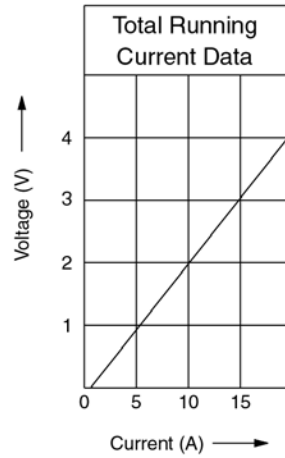

Fig. 5

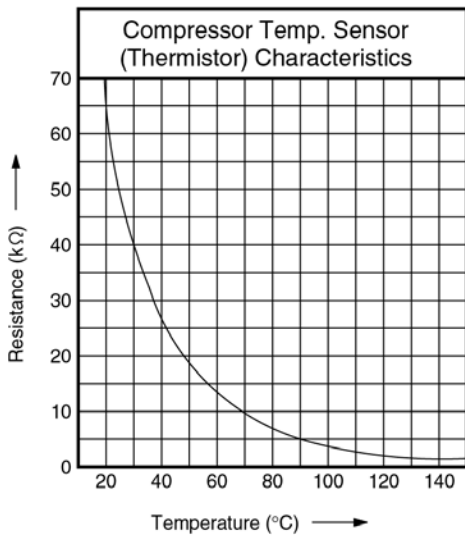
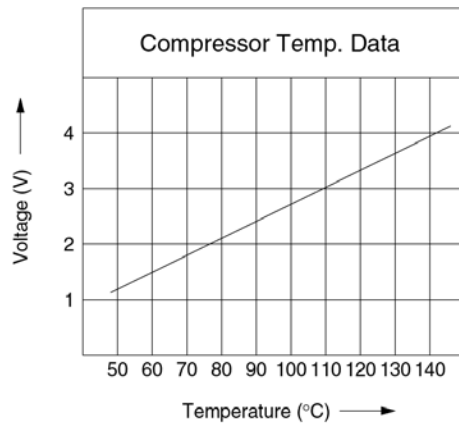

Fig. 6



How to use electronic circuit diagram

Before using the circuit diagram, read the following carefully.

* Voltage measurement

Voltage has been measured with a digital tester when the indoor fan is set at high fan speed under the following conditions without setting the timer.

Use them for servicing.

Voltage indication is in Red at all operations.

* Indications for resistance

a. K....k Ω M....M Ω
W...watt Not indicated....1/4W

b. Type

Not indicated.....carbon resister

Tolerance \pm 5%



.....metal oxide resister

Tolerance \pm 1%

* Indications for capacitor

a. Unit μ μ F P....pF

b. Type Not indicated....ceramic capacitor
(S).....S series aluminium

electrolytic capacitor

(Z).....Z series aluminium

electrolytic capacitor

(SU).....SU series aluminium

electrolytic capacitor

(P).....P series polyester system

(SXE).....SXE series aluminium

electrolytic capacitor

(SRA).....SRA series aluminium

electrolytic capacitor

(KME).....KME series aluminium

electrolytic capacitor

* Diode without indication.....MA165

※ Circuit Diagram is subject to change without notice for further development.

18.1. REMOTE CONTROL

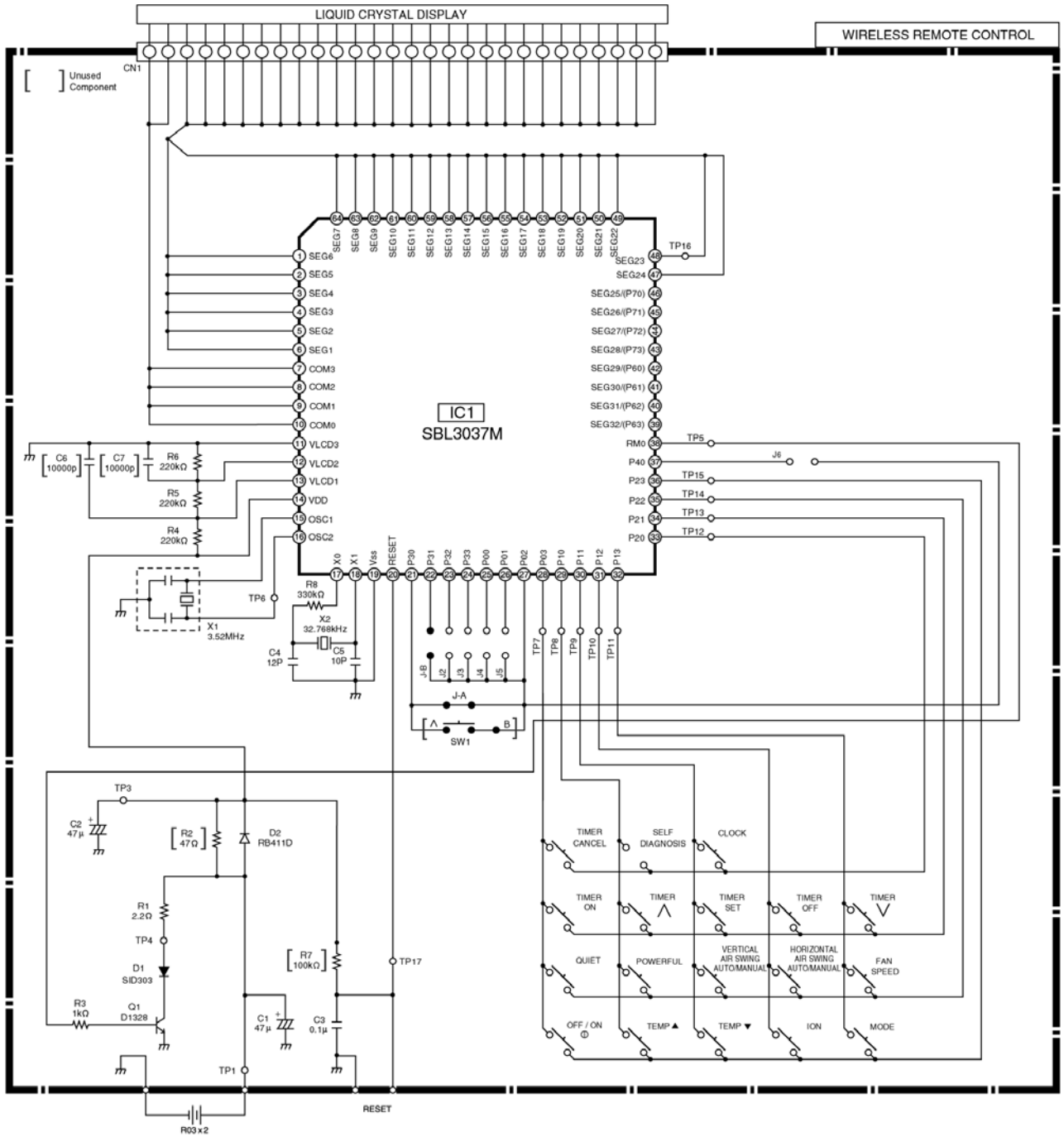

18.2. PRINT PATTERN INDOOR UNIT PRINTED CIRCUIT BOARD

● MAIN

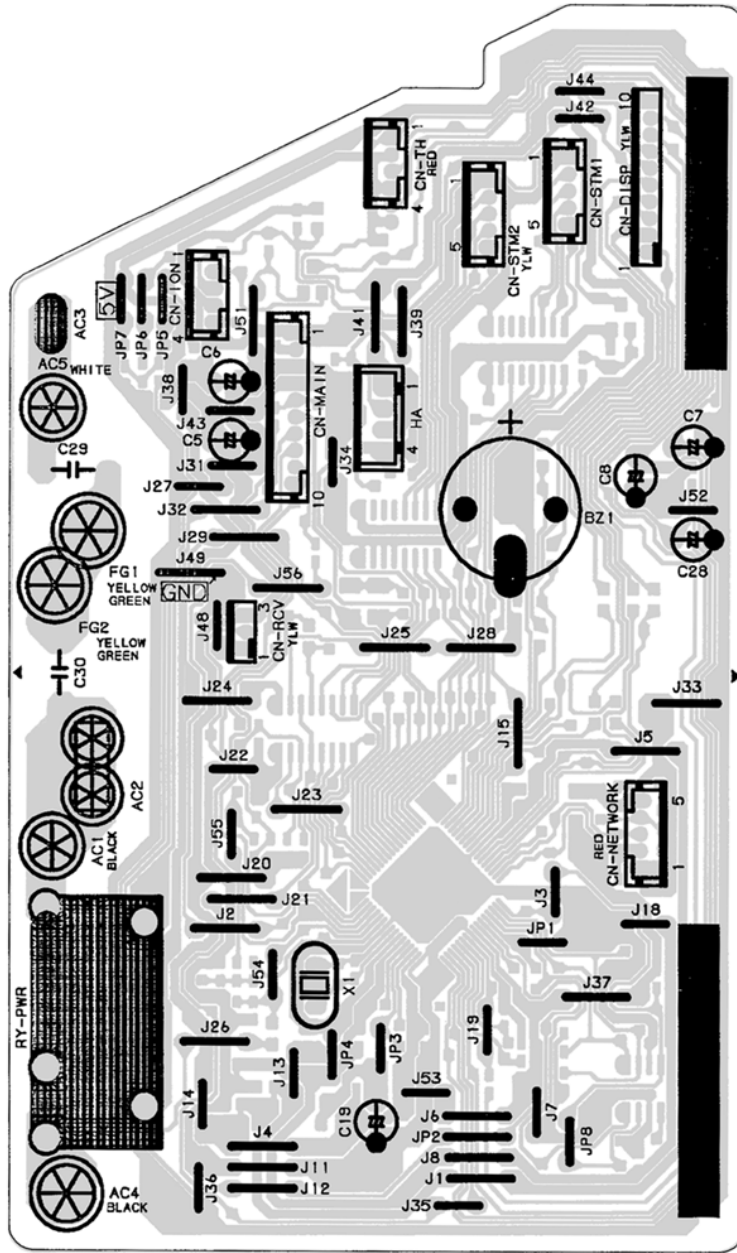

● INDICATOR

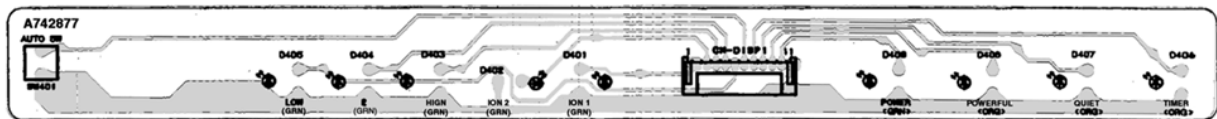

18.3. PRINT PATTERN OUTDOOR UNIT PRINTED CIRCUIT BOARD VIEW

- MAIN

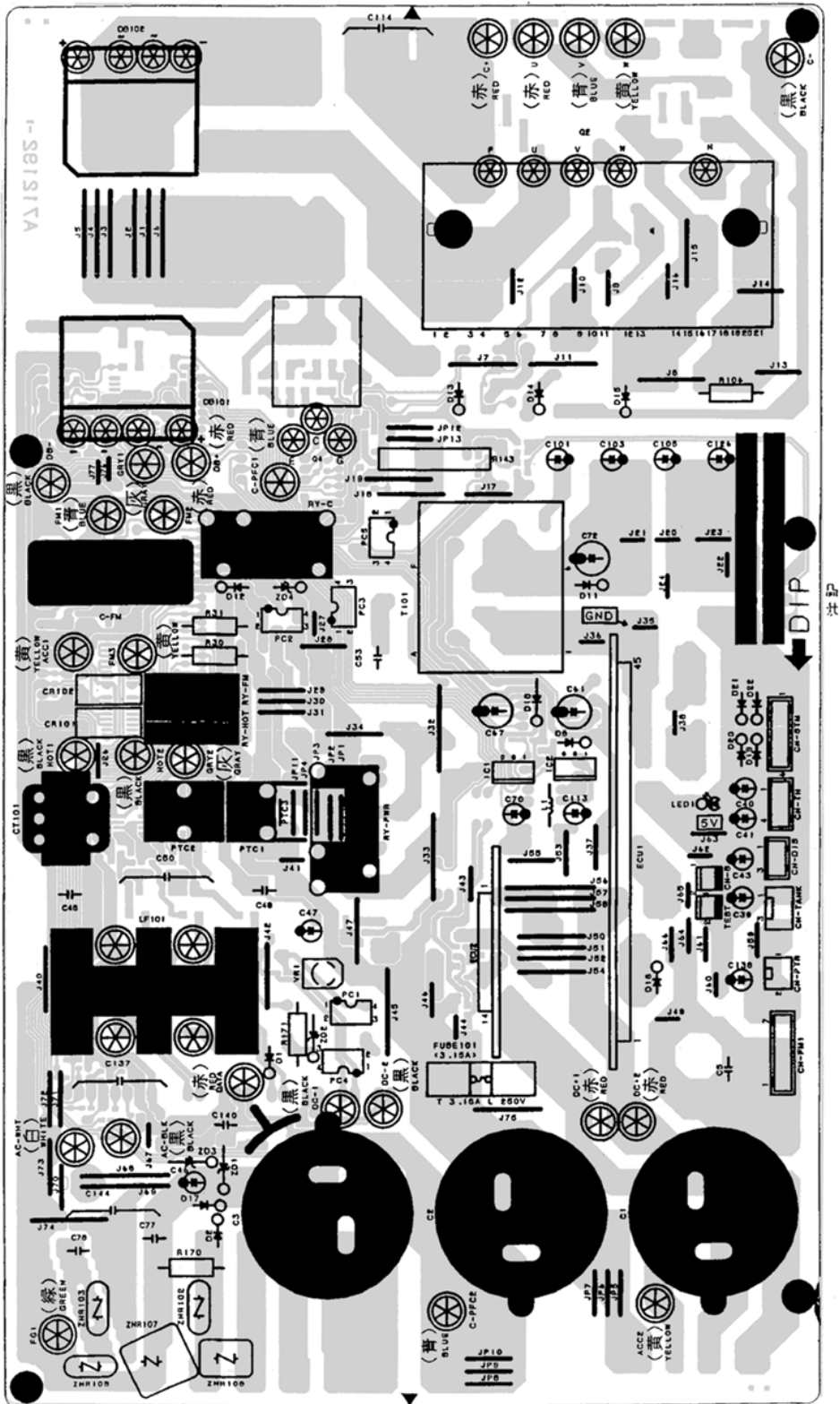

● PFC

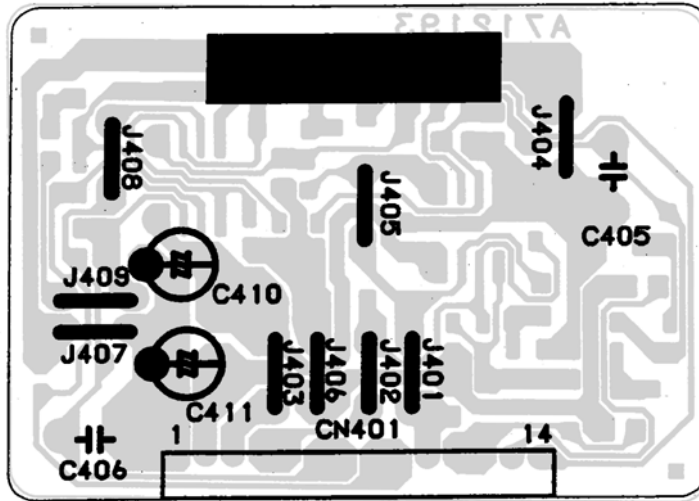

● CPU

TOP VIEW

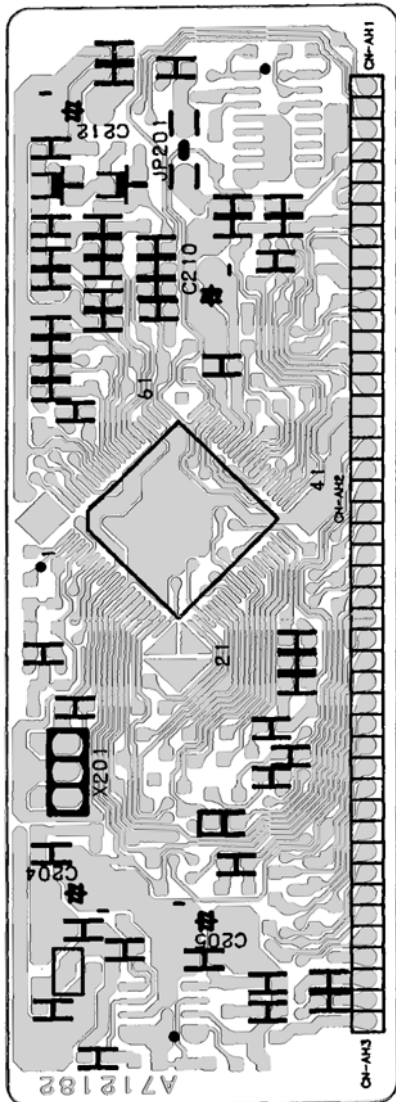

BOTTOM VIEW

