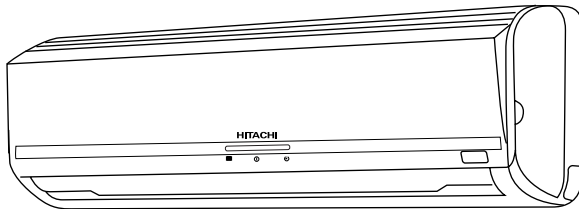
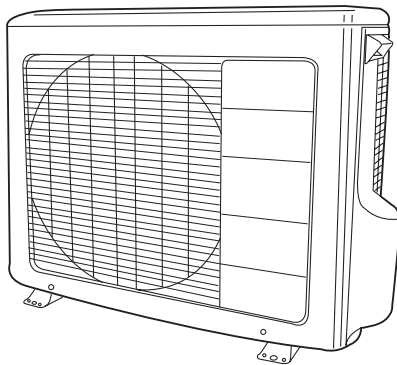

## SERVICE MANUAL TECHNICAL INFORMATION

**REFER TO THE FOUNDATION MANUAL**
**FOR SERVICE PERSONNEL ONLY**

**RAS-60YH5**

**RAC-60YH5**
**CONTENTS**

SPECIFICATIONS .....	4
HOW TO USE .....	6
CONSTRUCTION AND DIMENSIONAL DIAGRAM .....	28
MAIN PARTS COMPONENT .....	30
WIRING DIAGRAM .....	33
CIRCUIT DIAGRAM .....	35
PRINTED WIRING BOARD LOCATION DIAGRAM .....	41
BLOCK DIAGRAM .....	43
BASIC MODE .....	45
REFRIGERATING CYCLE DIAGRAM .....	59
AUTO SWING FUNCTION .....	60
DESCRIPTION OF MAIN CIRCUIT OPERATION .....	61
SERVICE CALL Q & A .....	92
TROUBLE SHOOTING .....	95
PARTS LIST AND DIAGRAM .....	115

**SPECIFICATIONS**

TYPE		DC INVERTER (WALL TYPE)	
		INDOOR UNIT	OUTDOOR UNIT
MODEL		RAS-60YH5	RAC-60YH5
POWER SOURCE		1 PHASE, 50 Hz, 220 – 240V	
COOLING	TOTAL INPUT (W)	2,300	
	TOTAL AMPERES (A)	10.60 – 9.70	
	CAPACITY	(kW)	6.05 (0.90 – 6.50)
(B.T.U./h)		20,660	
HEATING	TOTAL INPUT (W)	2,400	
	TOTAL AMPERES (A)	11.0 – 10.10	
	CAPACITY	(kW)	7.05
(B.T.U./h)		24,060	
DIMENSIONS (mm)	W	1,030	850
	H	295	650
	D	191	298
NET WEIGHT	(kg)	12	45

※ After installation

**SPECIFICATIONS AND PARTS ARE SUBJECT TO CHANGE FOR IMPROVEMENT**

# ROOM AIR CONDITIONER

**INDOOR UNIT + OUTDOOR UNIT**

## SAFETY DURING REPAIR WORK

1. In order to disassemble and repair the unit in question, be sure to disconnect the power cord plug from the power outlet before starting the work.

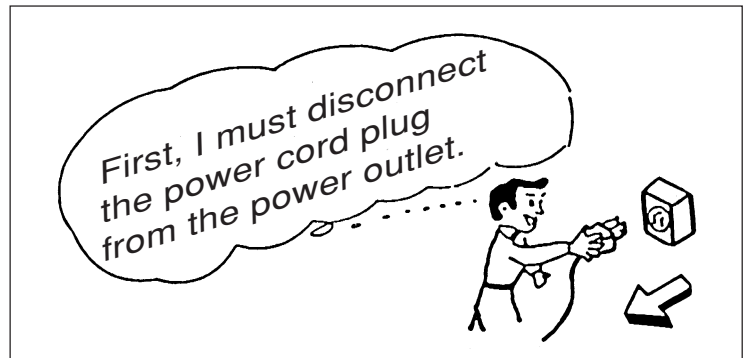

2. If it is necessary to replace any parts, they should be replaced with respective genuine parts for the unit, and the replacement must be effected in correct manner according to the instructions in the Service Manual of the unit.

If the contacts of electrical parts are defective, replace the electrical parts without trying to repair them.



3. After completion of repairs, the initial state should be restored.
4. Lead wires should be connected and laid as in the initial state.
5. Modification of the unit by user himself should absolutely be prohibited.
6. Tools and measuring instruments for use in repairs or inspection should be accurately calibrated in advance.
7. In installing the unit having been repaired, be careful to prevent the occurrence of any accident such as electrical shock, leak of current, or bodily injury due to the drop of any part.
8. To check the insulation of the unit, measure the insulation resistance between the power cord plug and grounding terminal of the unit. The insulation resistance should be  $1M\Omega$  or more as measured by a 500V DC megger.
9. The initial location of installation such as window, floor or the other should be checked for being and safe enough to support the repaired unit again. If it is found not so strong and safe, the unit should be installed at the initial location reinforced or at a new location.
10. Any inflammable thing should never be placed about the location of installation.
11. Check the grounding to see whether it is proper or not, and if it is found improper, connect the grounding terminal to the earth.



## WORKING STANDARDS FOR PREVENTING BREAKAGE OF SEMICONDUCTORS

### 1. Scope

The standards provide for items to be generally observed in carrying and handling semiconductors in relative manufacturers during maintenance and handling thereof. (They apply the same to handling of abnormal goods such as rejected goods being returned).

### 2. Object parts

- (1) Micro computer
- (2) Integrated circuits (IC)
- (3) Field-effect transistors (FET)
- (4) P.C. boards or the like on which the parts mentioned in (1) and (2) of this paragraph are equipped.

### 3. Items to be observed in handling

- (1) Use a conductive container for carrying and storing of parts. (Even rejected goods should be handled in the same way).

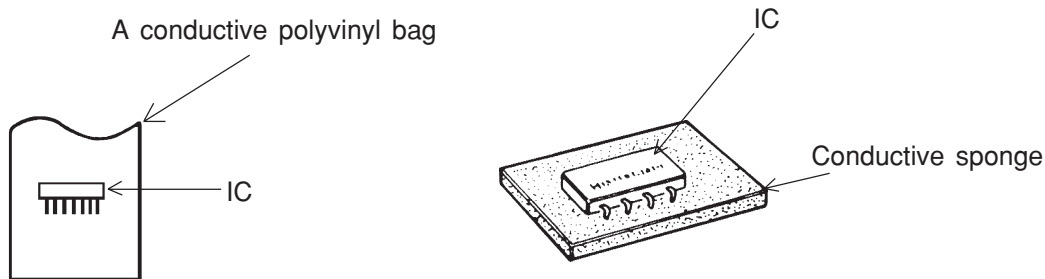

Fig. 1. Conductive Container

- (2) When any part is handled uncovered (in counting, packing and the like), the handling person must always use himself as a body earth. (Make yourself a body earth by passing one M ohm earth resistance through a ring or bracelet).
- (3) Be careful not to touch the parts with your clothing when you hold a part even if a body earth is being taken.
- (4) Be sure to place a part on a metal plate with grounding.
- (5) Be careful not to fail to turn off power when you repair the printed circuit board. At the same time, try to repair the printed circuit board on a grounded metal plate.

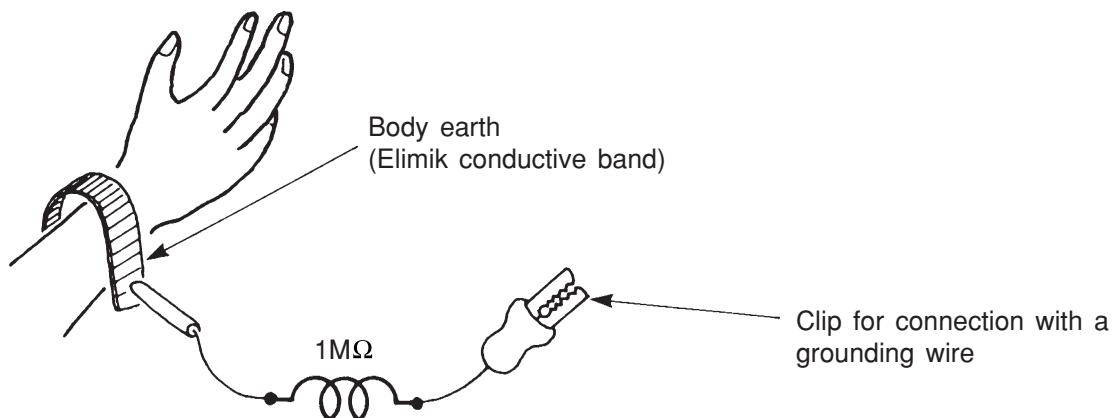

Fig. 2. Body Earth

(6) Use a three wire type soldering iron including a grounding wire.

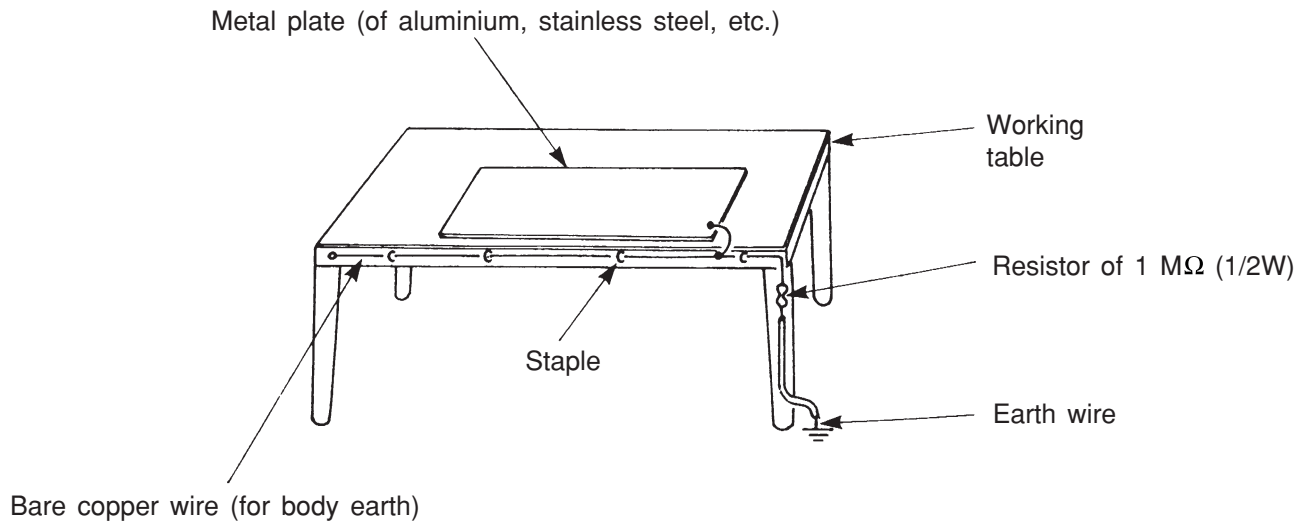

Fig. 3. Grounding of the working table

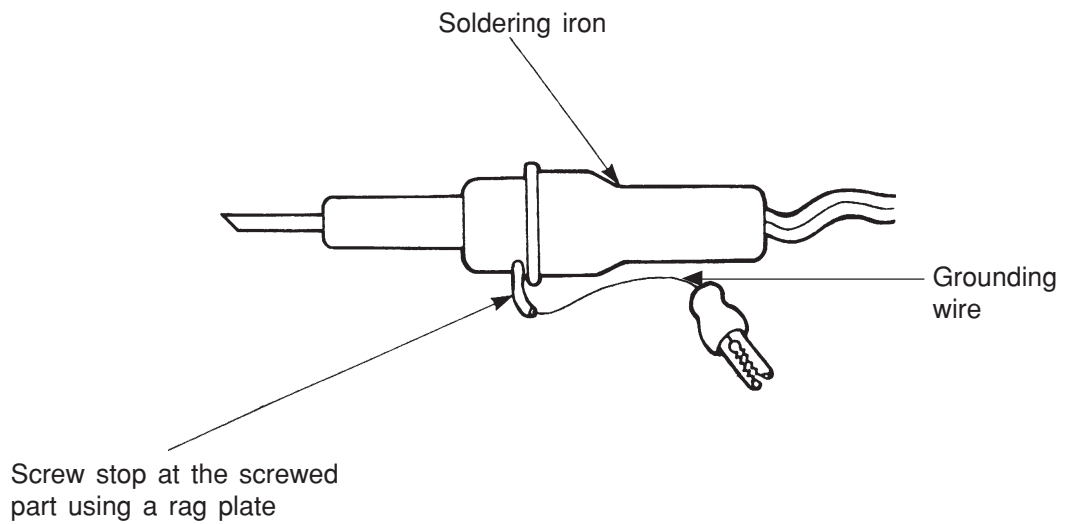

Fig. 4. Grounding a soldering iron

Use a high insulation mode (100V, 10MΩ or higher) when ordinary iron is to be used.

(7) In checking circuits for maintenance, inspection or some others, be careful not to have the test probes of the measuring instrument shortcircuit a load circuit or the like.

 **CAUTION**

1. In quiet or stopping operation, slight flowing noise of refrigerant in the refrigerating cycle is heard occasionally, but this noise is not abnormal for the operation.
2. When it thunders near by, it is recommend to stop the operation and to disconnect the power cord plug from the power outlet for safety.
3. In the event of power failure, the air conditioner will restart automatically in the previously selected mode once the power is restored. In the event of power failure during TIMER operation, the timer will be reset and the unit will begin or stop operating under a new timer setting.
4. If the room air conditioner is stopped by adjusting thermostat, or missoperation, and re-start in a moment, there is occasion that the cooling and heating operation does not start for 3 minutes, it is not abnormal and this is the result of the operation of IC delay circuit. This IC delay circuit ensures that there is no danger of blowing fuse or damaging parts even if operation is restarted accidentally.
5. This room air conditioner should not be used at the cooling operation when the outside temperature is below  $-10^{\circ}\text{C}$  ( $14^{\circ}\text{F}$ ).
6. This room air conditioner (the reverse cycle) should not be used when the outside temperature is below  $-15^{\circ}\text{C}$  ( $5^{\circ}\text{F}$ ).  
If the reverse cycle is used under this condition, the outside heat exchanger is frosted and efficiency falls.
7. When the outside heat exchanger is frosted, the frost is melted by operating the hot gas system, it is not trouble that at this time fan stops and the vapour may rise from the outside heat exchanger.

## SPECIFICATIONS

MODEL		RAS-60YH5	RAC-60YH5
FAN MOTOR		PWM DC35V	40 W
FAN MOTOR CAPACITOR		NO	NO
FAN MOTOR PROTECTOR		NO	NO
COMPRESSOR		–	JU1013D5
COMPRESSOR MOTOR CAPACITOR		NO	NO
OVERLOAD PROTECTOR		NO	YES (INTERNAL)
OVERHEAT PROTECTOR		NO	YES
FUSE (for MICROPROCESSOR)		NO	3.0A
POWER RELAY		NO	G4A
POWER SWITCH		NO	NO
TEMPORARY SWITCH		YES	NO
SERVICE SWITCH		NO	YES
TRANSFORMER		NO	NO
VARISTOR		NO	450NR
NOISE SUPPRESSOR		NO	YES
THERMOSTAT		YES(IC)	YES(IC)
REMOTE CONTROL SWITCH (LIQUID CRYSTAL)		YES	NO
REFRIGERANT CHARGING VOLUME (Refrigerant R410A)	UNIT	-----	1420g
	PIPES (MAX. 30m)	WITHOUT REFRIGERANT BECAUSE COUPLING IS FLARE TYPE.	

Chargeless upto 20m, above 20m upto max 30m, charge refrigerant R410A 5 g/m.

Figure showing the installation of Indoor and Outdoor unit



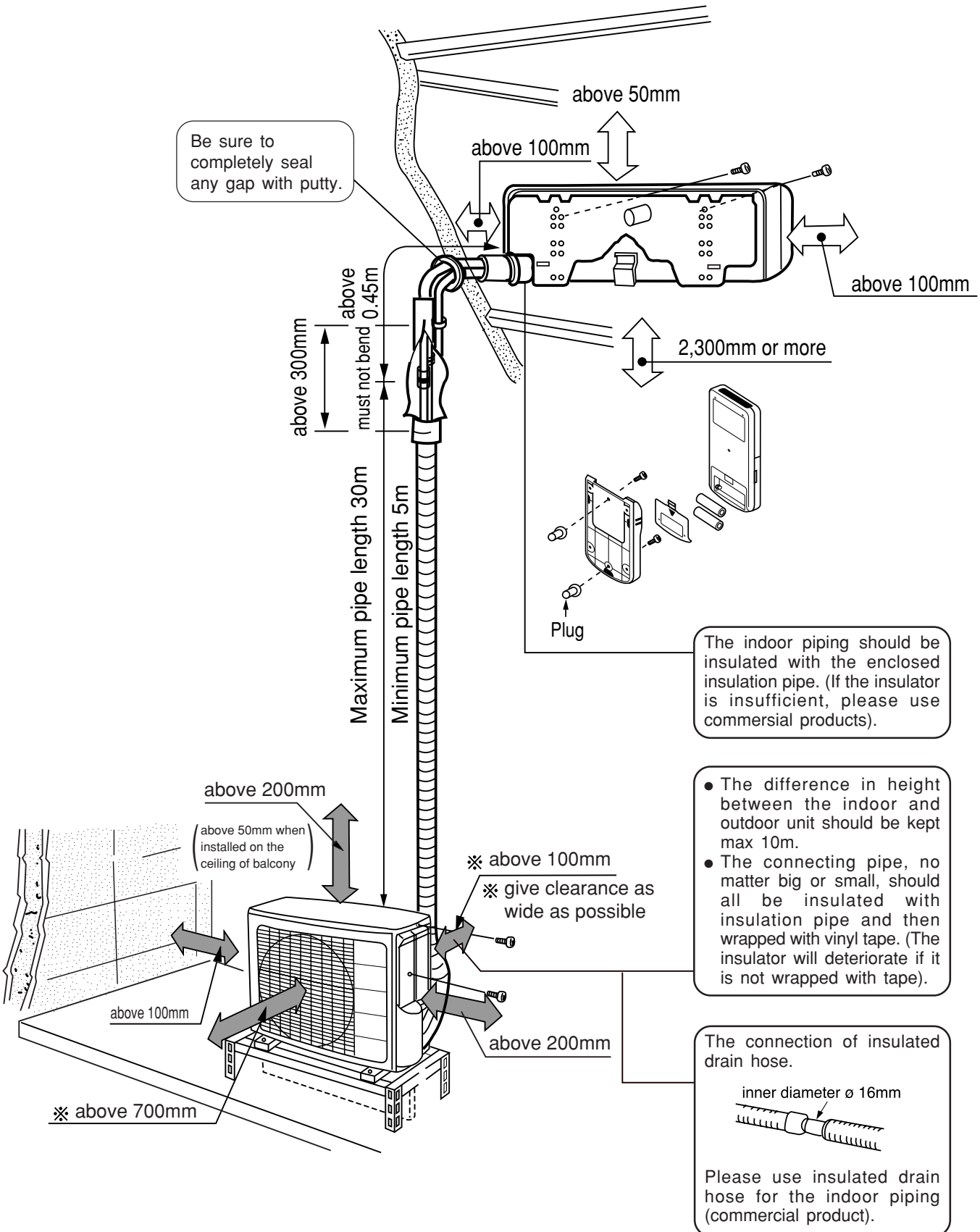

The installation height of indoor unit must be 2.3m or more.











# SAFETY PRECAUTION





- Please read the “Safety Precaution” carefully before operating the unit to ensure correct usage of the unit.
- Pay special attention to signs of “**▲ Warning**” and “**▲ Caution**”. The “Warning” section contains matters which, if not observed strictly, may cause death or serious injury. The “Caution” section contains matters which may result in serious consequences if not observed properly. Please observe all instructions strictly to ensure safety.
- The sign indicate the following meanings.

 Make sure to connect earth line.	 The sign in the figure indicates prohibition.
 Indicates the instructions that must be followed.	

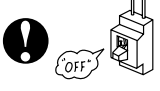
- Please keep this manual after reading.

PRECAUTIONS DURING INSTALLATION		
 <b>WARNING</b>	<ul style="list-style-type: none"> <li>● Do not reconstruct the unit. Water leakage, fault, short circuit or fire may occur if you reconstruct the unit by yourself.</li> </ul>	
	<ul style="list-style-type: none"> <li>● Please ask your sales agent or qualified technician for the installation of your unit. Water leakage, short circuit or fire may occur if you install the unit by yourself.</li> </ul>	
	<ul style="list-style-type: none"> <li>● Please use earth line. Do not place the earth line near water or gas pipes, lightning-conductor, or the earth line of telephone. Improper installation of earth line may cause electric shock.</li> </ul>	
 <b>CAUTION</b>	<ul style="list-style-type: none"> <li>● A circuit breaker should be installed depending on the mounting site of the unit. Without a circuit breaker, the danger of electric shock exists.</li> </ul>	
	<ul style="list-style-type: none"> <li>● Do not install the unit near a location where there is flammable gas. The outdoor unit may catch fire if flammable gas leaks around it.</li> </ul>	
	<ul style="list-style-type: none"> <li>● Please ensure smooth flow of water when installing the drain hose.</li> </ul>	

PRECAUTIONS DURING SHIFTING OR MAINTENANCE		
 <b>W A R N I N G</b>	<ul style="list-style-type: none"> <li>● Should abnormal situation arises (like burning smell), please stop operating the unit and turn off the circuit breaker. Contact your agent. Fault, short circuit or fire may occur if you continue to operate the unit under abnormal situation.</li> </ul>	
	<ul style="list-style-type: none"> <li>● Please contact your agent for maintenance. Improper self maintenance may cause electric shock and fire.</li> </ul>	
	<ul style="list-style-type: none"> <li>● Please contact your agent if you need to remove and reinstall the unit. Electric shock or fire may occur if you remove and reinstall the unit yourself improperly.</li> </ul>	

PRECAUTIONS DURING OPERATION		
 <b>W A R N I N G</b>	<ul style="list-style-type: none"> <li>● Avoid an extended period of direct air flow for your health.</li> </ul>	
	<ul style="list-style-type: none"> <li>● Do not insert a finger, a rod or other objects into the air outlet or inlet. As the fan is rotating at a high speed, it will cause injury. Before cleaning, be sure to stop the operation and turn the breaker OFF.</li> </ul>	
	<ul style="list-style-type: none"> <li>● Do not use any conductor as fuse wire, this could cause fatal accident.</li> </ul>	
	<ul style="list-style-type: none"> <li>● During thunder storm, disconnect and turn off the circuit breaker.</li> </ul>	



## PRECAUTIONS DURING OPERATION

- The product shall be operated under the manufacturer specification and not for any other intended use.



- Do not attempt to operate the unit with wet hands, this could cause fatal accident.

- When operating the unit with burning equipments, regularly ventilate the room to avoid oxygen insufficiency.

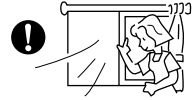

- Do not direct the cool air coming out from the air-conditioner panel to face household heating apparatus as this may affect the working of apparatus such as the electric kettle, oven etc.

- Please ensure that outdoor mounting frame is always stable, firm and without defect. If not, the outdoor unit may collapse and cause danger.



- Do not splash or direct water to the body of the unit when cleaning it as this may cause short circuit.

- Do not use any aerosol or hair sprays near the indoor unit. This chemical can adhere on heat exchanger fin and blocked the evaporation water flow to drain pan. The water will drop on tangential fan and cause water splashing out from indoor unit.

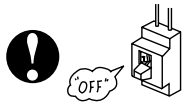

- Please switch off the unit and turn off the circuit breaker during cleaning, the high-speed fan inside the unit may cause danger.

- Turn off the circuit breaker if the unit is not to be operated for a long period.

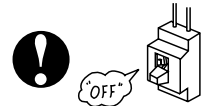

- Do not climb on the outdoor unit or put objects on it.

- Do not put water container (like vase) on the indoor unit to avoid water dripping into the unit. Dripping water will damage the insulator inside the unit and causes short-circuit.

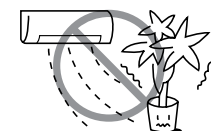
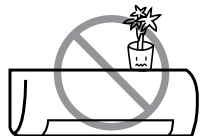

- Do not place plants directly under the air flow as it is bad for the plants.

- When operating the unit with the door and windows opened, (the room humidity is always above 80%) and with the air deflector facing down or moving automatically for a long period of time, water will condense on the air deflector and drips down occasionally. This will wet your furniture. Therefore, do not operate under such condition for a long time.

- If the amount of heat in the room is above the cooling or heating capability of the unit (for example: more people entering the room, using heating equipments and etc.), the preset room temperature cannot be achieved.

- This appliance is not intended for use by young children or infirm persons unless they have been adequately supervised by a responsible person to ensure that they can use the appliance safely.

- Young children should be supervised to ensure that they do not play with the appliance.



C  
A  
U  
T  
I  
O  
N

# NAMES AND FUNCTIONS OF EACH PART

## INDOOR UNIT

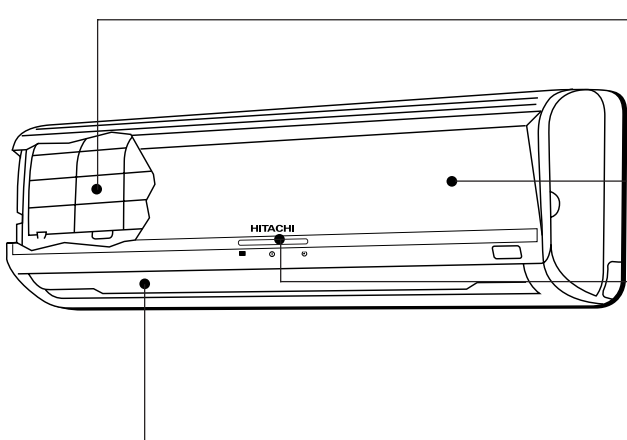

### Air filter

To prevent dust from coming into the indoor unit. (Refer page 25)

### Front panel

### Indoor unit indicators

Light indicator showing the operating condition. (Refer page 9)

### Horizontal deflector • Vertical deflector (Air Outlet)

(Refer page 20)

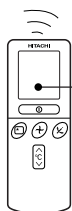

### Remote controller

Send out operation signal to the indoor unit. So as to operate the whole unit. (Refer page 10)

## OUTDOOR UNIT

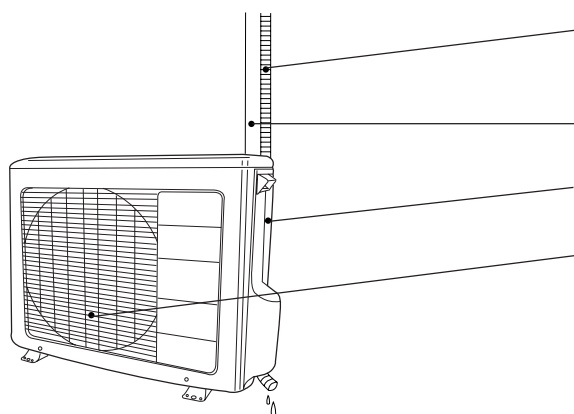

### Drain pipe

Condensed water drain to outside.

### Connecting cord and insulation pipe for piping

### Air inlet (Back and Left side)

### Air outlet

### CAUTION

- When heating operation, drain or defrosted water flows out from outdoor unit. Don't close drain outlet portion in chilly area so as not to freeze these.

## MODEL NAME AND DIMENSIONS

MODEL	WIDTH (mm)	HEIGHT (mm)	DEPTH (mm)
RAS-60YH5	1030	295	191
RAC-60YH5	850	650	298

## INDOOR UNIT INDICATORS

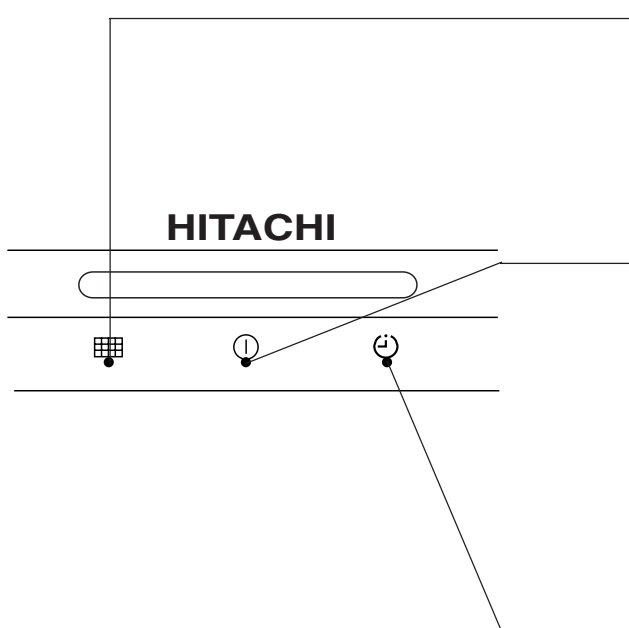

### FILTER LAMP

When the device is operated for a total of about 200 hours, the FILTER lamp lights to indicate that it is time to clean the filter. The lamp goes out when the "  (AUTO SWING)" button is pressed while the device is on "STANDBY MODE".

### OPERATION LAMP

This lamp lights during operation.

The OPERATION LAMP flashes in the following cases during heating.

#### (1) During preheating

For about 2–3 minutes after starting up.

#### (2) During defrosting

Defrosting will be performed about once an hour when frost forms on the heat exchanger of the outdoor unit, for 5–10 minutes each time.

### TIMER LAMP

This lamp lights when the timer is working.

## OPERATION INDICATOR

- This figure shows the opening condition of front panel. Refer to page 20 in relation to how to open or close the front panel.

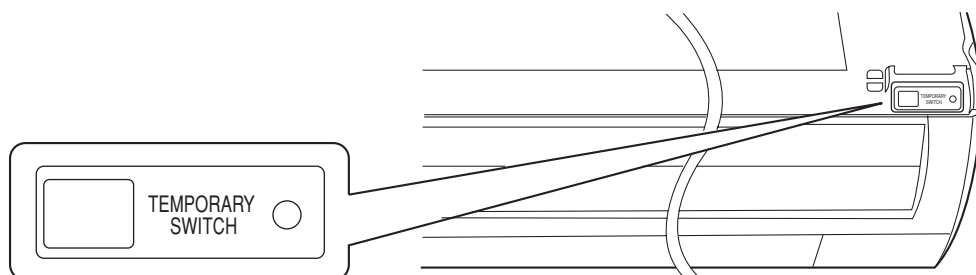

### TEMPORARY SWITCH

- Use this switch to start and stop when the remote controller does not work.
- By pressing the temporary switch, the operation is done in automatic mode.

# NAMES AND FUNCTIONS OF REMOTE CONTROL UNIT

## REMOTE CONTROLLER

- This controls the operation of the indoor unit. The range of control is about 7 meters. If indoor lighting is controlled electronically, the range of control may be shorter.  
This unit can be fixed on a wall using the fixture provided. Before fixing it, make sure the indoor unit can be controlled from the remote controller.
- Handle the remote controller with care. Dropping it or getting it wet may compromise its signal transmission capability.
- After new batteries are inserted into the remote controller, the unit will initially require approximately 10 seconds to respond to commands and operate.

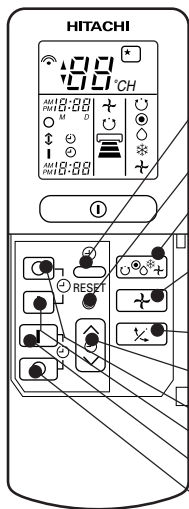
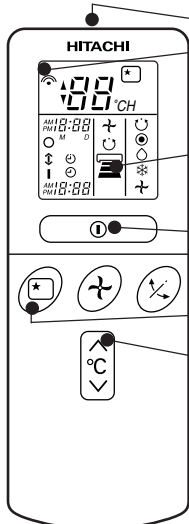

- **Signal emitting window/transmission sign**  
Point this window toward the indoor unit when controlling it. The transmission sign blinks when a signal is sent.
- **Display**  
This indicates the room temperature selected, current time, timer status, function and intensity of circulation selected.
- **START/STOP button**  
Press this button to start operation. Press it again to stop operation.
- **SLEEP button**  
Use this button to set the sleep timer.
- **TEMPERATURE buttons**  
Use these buttons to raise or lower the temperature setting. (Keep pressed, and the value will change more quickly.)
- **TIME button**  
Use this button to set and check the time and date.
- **RESET buttons**
- **FUNCTION selector**  
Use this button to select the operating mode. Every time you press it, the mode will change from ☺ (AUTO) to ● (HEAT) to ○ (DEHUMIDIFY) to ❄ (COOL) and to ✈ (FAN) cyclically.
- **FAN SPEED selector**  
This determines the fan speed. Every time you press this button, the intensity of circulation will change from ☺ (AUTO) to 🌀 (HI) to 🌀 (MED) to 🌀 (LOW) (This button allows selecting the optimal or preferred fan speed for each operation mode).
- **AUTO SWING button**  
Controls the angle of the horizontal air deflector.
- **TIMER control**  
Use this button to set the timer.
- **OFF-TIMER button** Select the turn OFF time.
- **ON-TIMER button** Select the turn ON time.
- **RESERVE button** Time setting reservation.
- **CANCEL button** Cancel time reservation.

☺	AUTO
●	HEAT
○	DEHUMIDIFY
❄	COOL
✈	FAN
🌀	FAN SPEED LOW MED HI
★	SLEEPING
○	STOP (CANCEL)
I	START (RESERVE)
Ⓜ	START/STOP
⌚	TIME
⌚	TIMER SET
⌚	TIMER SELECTOR ON TIMER OFF TIMER
✈	AUTO SWING

## Precautions for Use

- Do not put the remote controller in the following places.
  - Under direct sunlight.
  - In the vicinity of a heater.
- Handle the remote controller carefully. Do not drop it on the floor, and protect it from water.
- Once the outdoor unit stops, it will not restart for about 3 minutes (unless you turn the power switch off and on or unplug the power cord and plug it in again).  
This is to protect the device and does not indicate a failure.
- If you press the FUNCTION selector button during operation, the device may stop for about 3 minutes for protection.

## VARIOUS FUNCTIONS

### ■ Auto Restart Control

- If there is a power failure, operation will be automatically restarted when the power is resumed with previous operation mode and airflow direction.  
(As the operation is not stopped by remote controller.)
- If you intend not to continue the operation when the power is resumed, switch off the power supply. When you switch on the circuit breaker, the operation will be automatically restarted with previous operation mode and airflow direction.  
Note: 1. If you do not require Auto Restart Control, please consult your sales agent or OFF by remote control.  
2. Auto Restart Control is not available when Timer or Sleep Timer mode is set.

## AUTOMATIC OPERATION

The device will automatically determine the mode of operation, HEAT, COOL or DEHUMIDIFY depending on the current room temperature. The selected mode of operation will change when the room temperature varies.

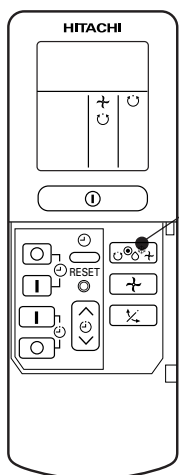



1

Press the FUNCTION selector so that the display indicates the  (AUTO) mode of operation.

- When AUTO has been selected, the device will automatically determine the mode of operation, HEAT, COOL or DEHUMIDIFY depending on the current room temperature.
- If the mode automatically selected by the unit is not satisfactory, manually change the mode setting (heat, dehumidify, cool or fan).

START  
STOP

Press the  (START/STOP) button.  
Operation starts with a beep.  
Press the button again to stop operation.

- As the settings are stored in memory in the remote controller, you only have to press the  (START/STOP) button next time.

You can raise or lower the temperature setting as necessary by maximum of 3°C.

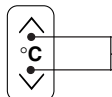

Press the temperature button and the temperature setting will change by 1°C each time.

- The preset temperature and the actual room temperature may vary somewhat depending on conditions.
- The display does not indicate the preset temperature in the AUTO mode. If you change the setting, the indoor unit will produce a beep.

Press the  (FAN SPEED) button, AUTO and LOW is available.

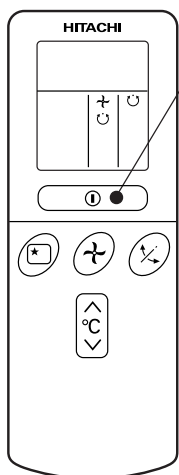

# HEATING OPERATION

- Use the device for heating when the outdoor temperature is under 21°C. When it is too warm (over 21°C), the heating function may not work in order to protect the device.
- In order to keep reliability of the device, please use this device above -15°C of the outdoor temperature.

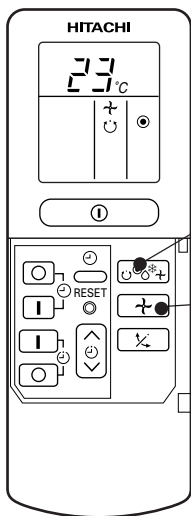



**1**

Press the FUNCTION selector so that the display indicates ● (HEAT).

**2**

Set the desired FAN SPEED with the  (FAN SPEED) button (the display indicates the setting).

 (AUTO): The fan speed is HI at first and varies to MED or LOW automatically when the preset temperature has been reached.

 (HI) : Economical as the room will become warm quickly. But you may feel a chill at the beginning.

 (MED) : Fan speed slow.

 (LOW) : Fan speed slower.

**3**

Set the desired room temperature with the TEMPERATURE buttons (the display indicates the setting).

The temperature setting and the actual room temperature may vary somewhat depending on conditions.

**START  
STOP**

Press the  (START/STOP) button. Heating operation starts with a beep. Press the button again to stop operation.

- As the settings are stored in memory in the remote controller, you only have to press the  (START/STOP) button next time.

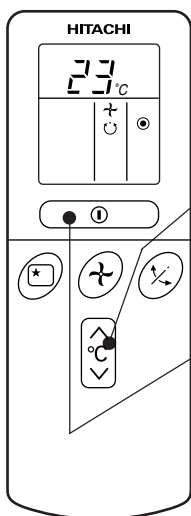

# DEHUMIDIFYING OPERATION

Use the device for dehumidifying when the room temperature is over 16°C.  
When it is under 15°C, the dehumidifying function will not work.

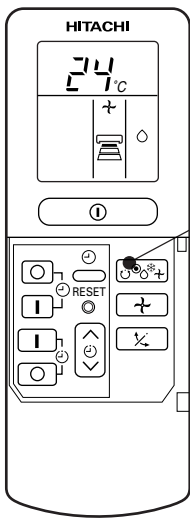

**1**

Press the FUNCTION selector so that the display indicates ◊ (DEHUMIDIFY).  
The FAN SPEED is set at LOW automatically.  
The FAN SPEED button does not work.

**2**

Set the desired room temperature with the TEMPERATURE button (the display indicates the setting).



The range of 20-26°C is recommended as the room temperature for dehumidifying.

**START  
STOP**

Press the Ⓜ (START/STOP) button. Dehumidifying operation starts with a beep. Press the button again to stop operation.

- As the settings are stored in memory in the remote controller, you only have to press the Ⓜ (START/STOP) button next time.

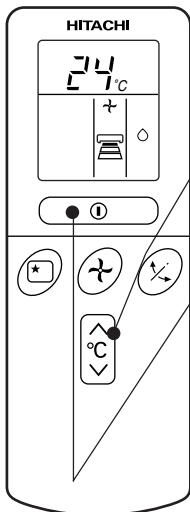

## ■ Dehumidifying Function

When the room temperature is higher than the temperature setting: The device will dehumidify the room, reducing the room temperature to the preset level.

When the room temperature is lower than the temperature setting: Dehumidifying will be performed at the temperature setting slightly lower than the current room temperature, regardless of the temperature setting. The function will stop (the indoor unit will stop emitting air) as soon as the room temperature becomes lower than the setting temperature.

# COOLING OPERATION

Use the device for cooling when the outdoor temperature is  $-10\sim 43^{\circ}\text{C}$ .  
 If in doors humidity is very high (80%), some dew may form on the air outlet grille of the indoor unit.

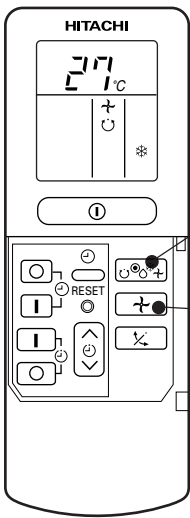

**1**

Press the FUNCTION selector so that the display indicates \* (COOL).

Set the desired FAN SPEED with the  $\updownarrow$  (FAN SPEED) button (the display indicates the setting).

**2**

$\updownarrow$  (AUTO): The FAN SPEED is HI at first and varies to MED or LOW automatically when the preset temperature has been reached.

(HI) : Economical as the room will become cool quickly.

(MED) : Fan speed slow.

(LOW) : Fan speed slower.

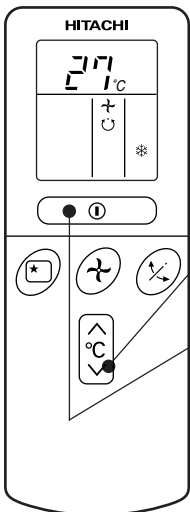

**3**

Set the desired room temperature with the TEMPERATURE button (the display indicates the setting).

The temperature setting and the actual room temperature may vary some how depending on conditions.

**START STOP**

Press the  $\text{O}$  (START/STOP) button. Cooling operation starts with a beep. Press the button again to stop operation. The cooling function does not start if the temperature setting is higher than the current room temperature (even though the  $\text{O}$  (OPERATION) lamp lights). The cooling function will start as soon as you set the temperature below the current room temperature.

■ As the settings are stored in memory in the remote controller, you only have to press the  $\text{O}$  (START/STOP) button next time.



# FAN OPERATION

You can use the device simply as an air circulator. Use this function to dry the interior of the indoor unit at the end of summer.

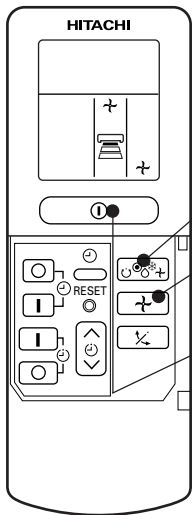

**1**

Press the FUNCTION selector so that the display indicates (FAN).

**2**

Press the (FAN SPEED) button.

**START  
STOP**

Press the (START/STOP) button. Fan operation starts with a beep. Press the button again to stop operation.

## FAN SPEED (AUTO)

..... When the AUTO fan speed mode is set in the cooling/heating operation:

For the heating operation	<ul style="list-style-type: none"> <li>● The fan speed will automatically change according to the temperature of discharged air.</li> <li>● When the difference of room temperature and setting temperature is large, fan starts to run at HI speed.</li> <li>● When the room temperature reaches setting temperature, fan speed changes to LOW automatically.</li> </ul>
For the cooling operation	<ul style="list-style-type: none"> <li>● When the difference of room temperature and setting temperature is large, fan starts to run at HI speed.</li> <li>● After room temperature reaches the preset temperature, the cooling operation, which changes the fan speed and room temperature to obtain optimum conditions for natural healthful cooling will be performed.</li> </ul>

# HOW TO SET THE TIMER

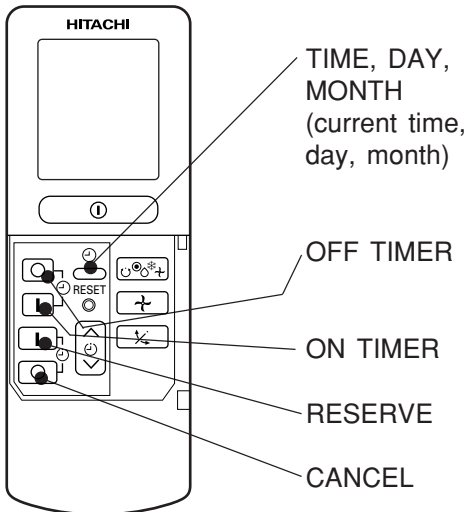

## Time, Day, Month

After you change the batteries;

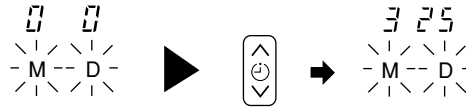

**1** Set the current month and day with the TIMER control button.

## OFF-Timer

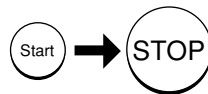

You can set the device to turn off at the present time.

**1** Press the (OFF-TIMER) button. The (OFF) mark blinks on the display.

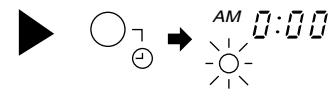

## ON-Timer

- The device will turn on at the designated times.

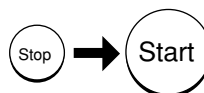

**1** Press the (ON-TIMER) button the (ON) mark blinks on the display.

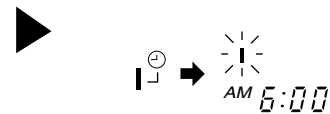

## ON/OFF-Timer

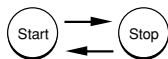

- The device will turn on (off) and off (on) at the designated times.
- The switching occurs first at the preset time that comes earlier.
- The arrow mark appearing on the display indicates the sequence of switching operations.

**1** Press the (ON-OFF) button so that the (OFF) mark blinks.

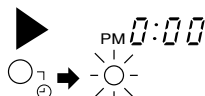

**2** Set the turn-off time with the TIMER control button. Press the (RESERVE) button.

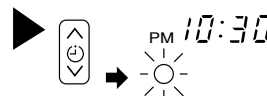

**3** Press the (ON-TIMER) button so that the (OFF) mark lights and the (ON) mark blinks.

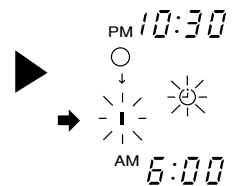

## How to Cancel Reservation

Point the signal window of the remote controller toward the indoor unit, and press the (CANCEL) button.

The (RESERVED) sign goes out with a beep and the (TIMER) lamp turns off on the indoor unit.

### NOTE

You can set only one of the OFF-timer, ON-timer and ON/OFF-timer.

**2** Press the  (TIME) button.

**3** Set the current time with the TIMER control button.

**4** Press the  (TIME) button again. The time indication starts lighting instead of flashing.

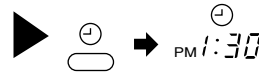
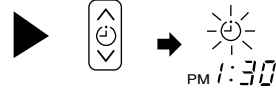
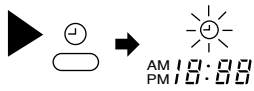



- The time indication will disappear automatically in 10 second.
- To check the current time setting, press the  (TIME) button twice.

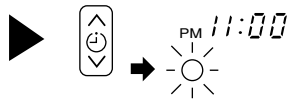

The setting of the current time is now complete.

Example: The current time is 1:30 p.m.

**2** Set the turn-off time with the TIMER control button.



**3** Point the signal window of the remote controller toward the indoor unit, and press the  (RESERVE) button.

The  (OFF) mark starts lighting instead of flashing and the sign  (RESERVED) lights. A beep occurs and the  (TIMER) lamp lights on the indoor unit.

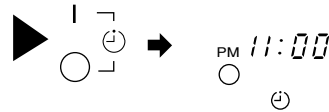



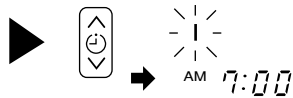

Example: The device will turn off at 11:00p.m.

The setting of turn-off time is now complete.

**2** Set the turn-on time with the TIMER control button.



**3** Point the signal window of the remote controller toward the indoor unit, and press the  (RESERVE) button.

The  (ON) mark starts lighting instead of flashing and the  (RESERVED) sign lights. A beep occurs and the  (TIMER) lamp lights on the indoor unit.

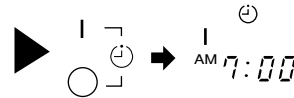

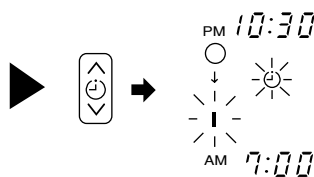

Example:  
The device will turn on at 7:00 a.m.  
The setting of the turn-on time is now complete.

**4** Set the turn-on time with the TIMER control button.



**5** Point the signal window of the remote controller toward the indoor unit, and press the  (RESERVE) button.

The  (ON) mark starts lighting instead of flashing and the  (RESERVED) sign lights. A beep occurs and the  (TIMER) lamp lights on the indoor unit.

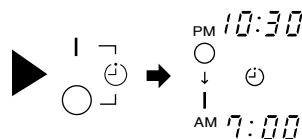

Example:  
The device will turn off at 10:30 p.m. and it will be turn on at 7:00 a.m.  
The settings of the turn-on/off times are now complete.

- The timer may be used in three ways: off-timer, on-timer, and ON/OFF (OFF/ON)-timer. Set the current time at first because it serves as a reference.
- As the time settings are stored in memory in the remote controller, you only have to press the  (RESERVE) button in order to use the same settings next time.

# HOW TO SET THE SLEEP TIMER

Set the current time at first if it is not set before (see the pages for setting the current time). Press the  (SLEEP) button, and the display changes as shown below.

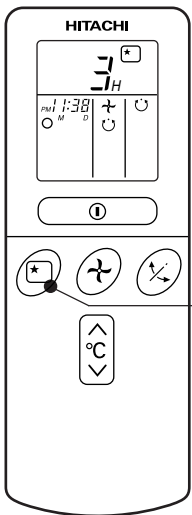

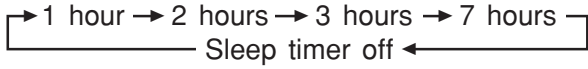
Mode	Indication
Sleep timer	

**Sleep Timer:** The device will continue working for the designated number of hours and then turn off. Point the signal window of the remote controller toward the indoor unit, and press the SLEEP button. The timer information will be displayed on the remote controller. The TIMER lamp lights with a beep from the indoor unit. When the sleep timer has been set, the display indicates the turn-off time.

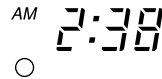

Example: If you set 3 hours sleep time at 11:38 p.m., the turn-off time is 2:38 a.m.

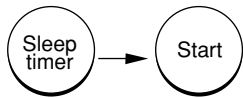

The device will be turned off by the sleep timer and turned on by on-timer.

**1** Set the ON-timer.

**2** Press the  (SLEEP) button and set the sleep timer.

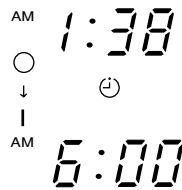
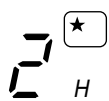

For heating:

In this case, the device will turn off in 2 hours (at 1:38 a.m.) and turn on early so that the preset temperature will be almost reached at 6:00 next morning.

## How to Cancel Reservation

Point the signal window of the remote controller toward the indoor unit, and press the  (CANCEL) button.

The  (RESERVED) sign goes out with a beep and the  (TIMER) lamp turns off on the indoor unit.

### NOTE

- If date or current time is not set, sleep timer can not be set.
- If you set the sleep timer after the off-, on/off- or off/on-timer has been set, the sleep timer becomes effective instead of the off-, on/off- or off/on-timer set earlier.
- You can not set other timer during sleep timer operation.
- After sleep timer time is up and when press sleep button again, the sleep timer will be set as last setting.
- Sleep timer effective only once.

# ADJUSTING THE AIR DEFLECTOR

- 1** Adjustment of the conditioned air in the upward and downward directions.

The horizontal air deflector is automatically set to the proper angle suitable for each operation. The deflector can be swung up and down continuously and also set to the desired angle using the “ (AUTO SWING)” button.

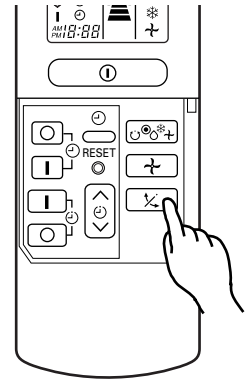

- If the “ (AUTO SWING)” button is pressed once, the horizontal air deflector swings up and down. If the button is pressed again, the deflector stops in its current position. Several seconds (about 6 seconds) may be required before the deflector starts to move.
- Use the horizontal air deflector within the adjusting range shown on the right.
- When the operation is stopped, the horizontal air deflector moves and stops at the position where the air outlet closes.

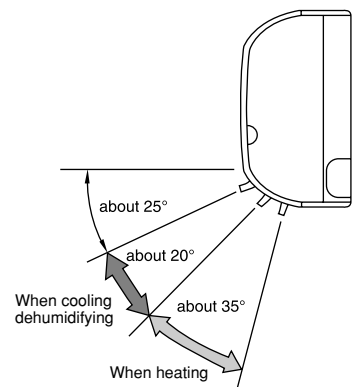

- CAUTION**
- In “Cooling” operation, do not keep the horizontal air deflector swinging for a long time. Some dew may form on the horizontal air deflector and dew may drop.

- 2** Adjustment of the conditioned air to the left and right.

Hold the vertical air deflector as shown in the figure and adjust the conditioned air to the left and right.

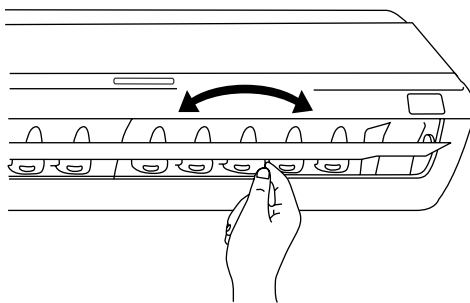

# HOW TO EXCHANGE THE BATTERIES IN THE REMOTE CONTROLLER

**1** Remove the cover as shown in the figure and take out the old batteries.



**2** Install the new batteries.  
The direction of the batteries should match the marks in the case.

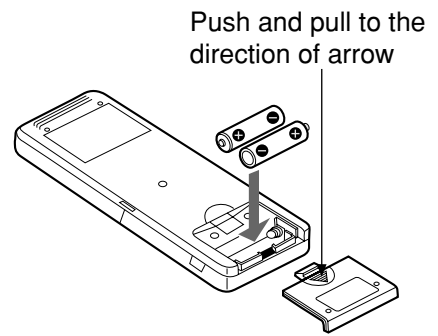

## **⚠ CAUTION**

1. Do not use new and old batteries, or different kinds of batteries together.
2. Take out the batteries when you do not use the remote controller for 2 or 3 months.

# THE IDEAL WAYS OF OPERATION

## Suitable Room Temperature

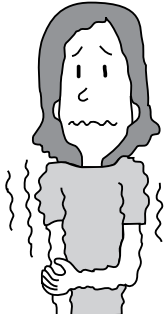

**⚠ Warning**  
Freezing temperature is bad for health and a waste of electric power.

## Install curtain or blinds

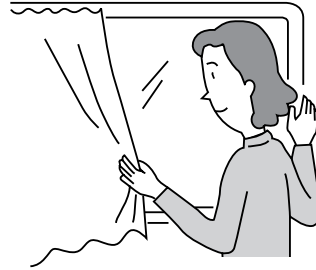

It is possible to reduce heat entering the room through windows.

## Ventilation

**⚠ Caution**  
Do not close the room for a long period of time. Occasionally open the door and windows to allow the entrance of fresh air.



## Effective Usage Of Timer

At night, please use the "OFF or ON timer operation mode", together with your wake up time in the morning. This will enable you to enjoy a comfortable room temperature. Please use the timer effectively.

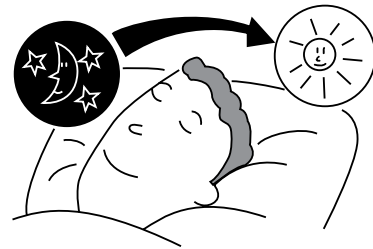

## Do Not Forget To Clean The Air Filter

Dusty air filter will reduce the air volume and the cooling efficiency. To prevent from wasting electric energy, please clean the filter every 2 weeks.

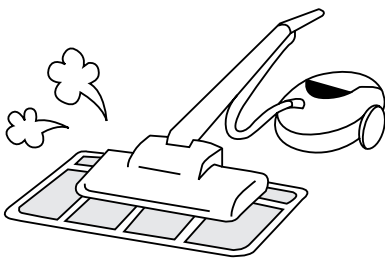

## Please Adjust Suitable Temperature For Baby And Children

Please pay attention to the room temperature and air flow direction when operating the unit for baby, children and old folks who have difficulty in movement.

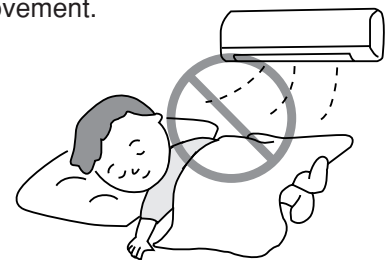

# FOR USER'S INFORMATION

## The Air Conditioner And The Heat Source In The Room

### ⚠ Caution

If the amount of heat in the room is above the cooling capability of the air conditioner (for example: more people entering the room, using heating equipments and etc.), the preset room temperature cannot be achieved.

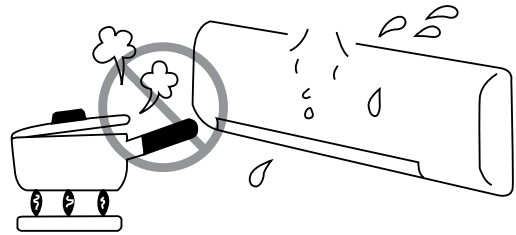

## Not Operating For A Long Time

When the indoor unit is not to be used for a long period of time, please switch off the power from the mains. If the power from mains remains "ON", the indoor unit still consumes about 8W in the operation control circuit even if it is in "OFF" mode.

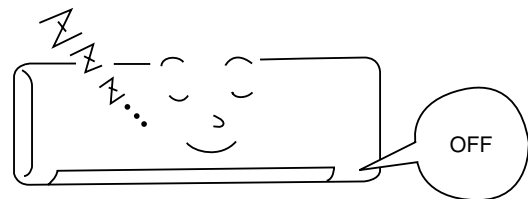

## When Lightning Occurs

### ⚠ Warning

To protect the whole unit during lightning, please stop operating the unit and remove the plug from the socket.

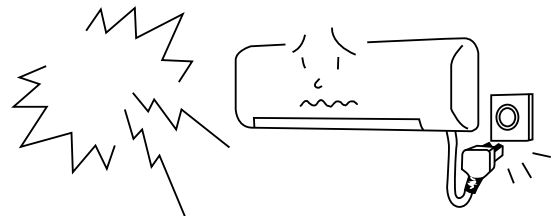

## Interference From Electrical Products

### ⚠ Caution

To avoid noise interference, please place the indoor unit and its remote controller at least 1m away from electrical products.

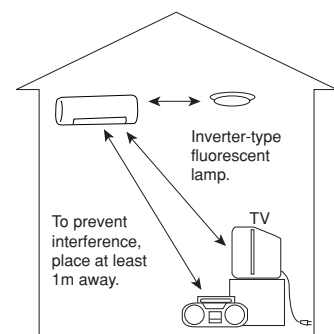



# ATTACHING THE AIR CLEANSING AND DEODORIZING FILTERS

## ⚠ CAUTION

Cleaning and maintenance must be carried out only by qualified service personal. Before cleaning, stop operation and switch off the power supply.

### 1 Open the front panel.

- Pull up the front panel by holding it at both sides with both hands.

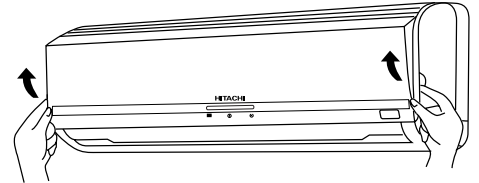

### 2 Remove the filter.

- Push upward to release the claws and pull out the filter.

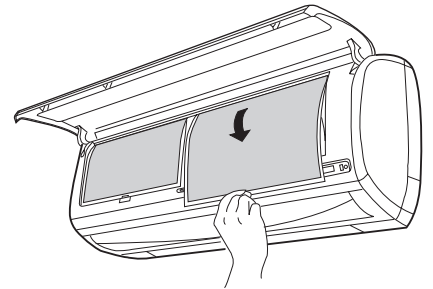

### 3 Attaching the air cleansing and deodorizing filters to the filter.

- Attach the air cleansing and deodorizing filters to the frame by gently compress its both sides and release after insertion into filter frame.

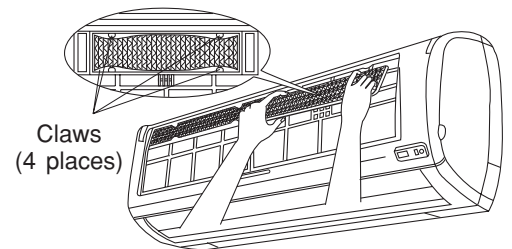

## ⚠ CAUTION

Do not bend the air cleansing and deodorizing filter as it may cause damage to the structure.

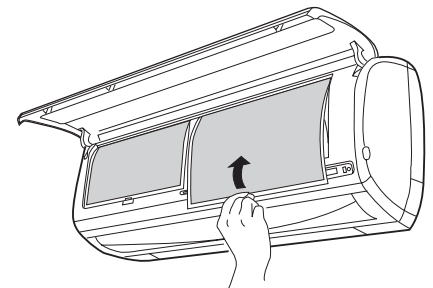

### 4 Attach the filters.

- Attach the filters by ensuring that the surface written "FRONT" is facing front.
- After attaching the filters, push the front panel at three arrow portion as shown in figure and close it.

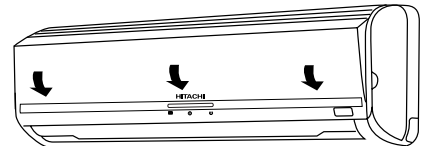

## NOTE

- In case of removing the air cleansing and deodorizing filters, please follow the above procedures.
- The cooling capacity is slightly weakened and the cooling speed becomes slower when the air cleansing and deodorizing filters are used. So, set the fan speed to "HIGH" when using it in this condition.
- Air cleansing and deodorizing filters are washable and reusable up to 20 times by using vacuum cleaner or water rinse under running tap water. Type number for this air cleansing filter is <SPX-CFH5>. Please use this number for ordering when you want to renew it.
- Do not operate the air conditioner without filter. Dust may enter the air conditioner and fault may occur.

# MAINTENANCE

## ⚠ CAUTION

Cleaning and maintenance must be carried out only by qualified service personal. Before cleaning, stop operation and switch off the power supply.

## 1. AIR FILTER

Clean the air filter, as it removes dust inside the room. In case the air filter is full of dust, the air flow will decrease and the cooling capacity will be reduced. Further, noise may occur. Be sure to clean the filter following the procedure below.

### PROCEDURE

- 1 Open the front panel and remove the filter
  - Gently lift and remove the air cleansing and deodorizing filter from the air filter frame.

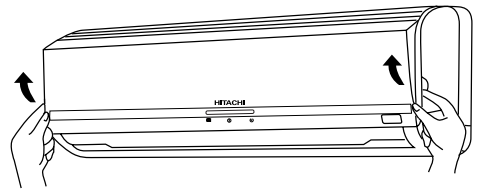

- 2 Vacuum dust from the air filter and air cleansing and deodorizing filter using vacuum cleaner. If there is too much dust, rinse under running tap water and gently brush it with soft bristle brush. Allow filters to dry in shade.

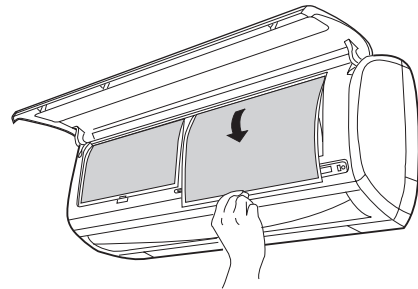
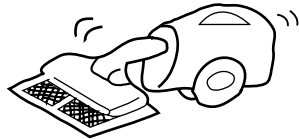

- 3
  - Re-insert the air cleansing and deodorizing filter to the filter frame. Set the filter with "FRONT" mark facing front, and slot them into the original state.
  - After attaching the filters, push the front panel at three arrow portions as shown in figure and close it.

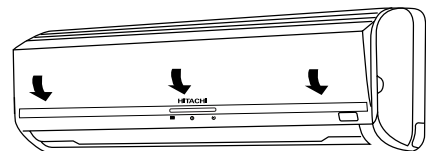

### NOTE:

- Air cleansing and deodorizing filter should be cleaned every month or sooner if noticeable loading occurs. When used overtime, it may loose its deodorizing function. For maximum performance, it is recommended to replace it every 3-6 months depending on application requirements.

## ⚠ CAUTION

- Do not wash with hot water at more than 40°C. The filter may shrink.
- When washing it, shake off moisture completely and dry it in the shade; do not expose it directly to the sun. The filter may shrink.
- Do not use detergent on the air cleansing and deodorizing filter as some detergent may deteriorate the filter electrostatic performance.

## 2. Washable Front Panel

- Remove the front panel and wash with clean water.  
Wash it with a soft sponge.  
After using neutral detergent, wash thoroughly with clean water.
- When front panel is not removed, wipe it with a soft dry cloth. Wipe the remote controller thoroughly with a soft dry cloth.
- Wipe the water thoroughly.  
If water remains at indicators or signal receiver of indoor unit, it causes trouble.



Method of removing the front panel.

Be sure to hold the front panel with both hands to detach and attach it.

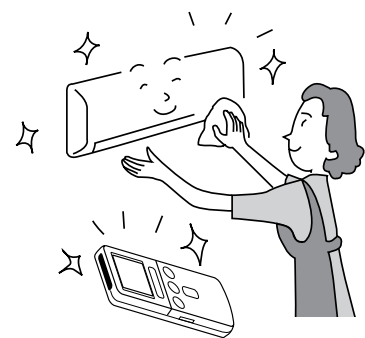

### Removing the Front Panel

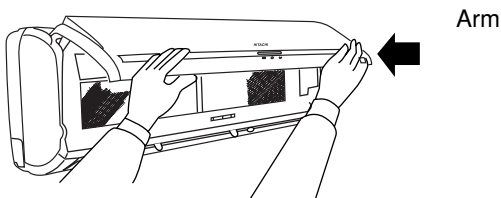

- When the front panel is fully opened with both hands, push the right arm to the inside to release it, and while closing the front panel slightly, put it out forward.

### Attaching the Front Panel

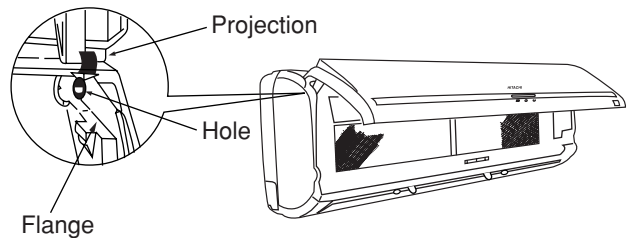

- Move the projections of the left and right arms into the **Flanges** in the unit and securely insert them into the holes.

### ▲ CAUTION

- Do not splash or direct water to the body of the unit when cleaning it as this may cause short circuit.
- Never use hot water (above 40°C), benzine, gasoline, acid, thinner or a brush, because they will damage the plastic surface and the coating.



**⚠ CAUTION**

Cleaning and maintenance must be carried out only by qualified service personal. Before cleaning, stop operation and switch off the power supply.

**3. MAINTENANCE AT BEGINNING OF LONG OFF PERIOD**

- Run the unit by setting the operation mode to ❄ (COOL), the temperature to 32°C and the fan speed to HI for about half a day on a fine day, and dry the whole of the unit.
- Switch off the power plug.

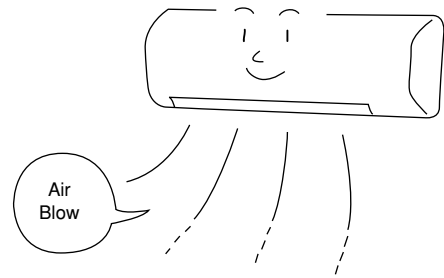

**REGULAR INSPECTION**

PLEASE CHECK THE FOLLOWING POINTS BY QUALIFIED SERVICE PERSONAL EITHER EVERY HALF YEARLY OR YEARLY. CONTACT YOUR SALES AGENT OR SERVICE SHOP.

1		Is the earth line disconnected or broken?
2		Is the mounting frame seriously affected by rust and is the outdoor unit tilted or unstable?
3		Is the plug of power line firmly plugged into the socket? (Please ensure no loose contact between them).

# AFTER SALE SERVICE AND WARRANTY

## WHEN ASKING FOR SERVICE, CHECK THE FOLLOWING POINTS.

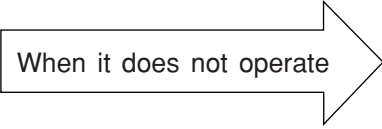
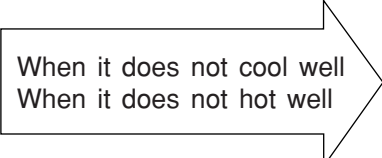
CONDITION	CHECK THE FOLLOWING POINTS
 <p>When it does not operate</p>	<ul style="list-style-type: none"> <li>● Is the fuse all right?</li> <li>● Is the voltage extremely high or low?</li> <li>● Is the circuit breaker "ON"?</li> </ul>
 <p>When it does not cool well When it does not hot well</p>	<ul style="list-style-type: none"> <li>● Was the air filter cleaned?</li> <li>● Does sunlight fall directly on the outdoor unit?</li> <li>● Is the air flow of the outdoor unit obstructed?</li> <li>● Are the doors or windows opened, or is there any source of heat in the room?</li> <li>● Is the set temperature suitable?</li> </ul>



### Notes

- In quiet operation or stopping the operation, the following phenomena may occasionally occur, but they are not abnormal for the operation.
  - (1) Slight flowing noise of refrigerant in the refrigerating cycle.
  - (2) Slight rubbing noise from the fan casing which is cooled and then gradually warmed as operation stops.
- The odor will possibly be emitted from the room air conditioner because the various odor, emitted by smoke, foodstuffs, cosmetics and so on, sticks to it. So the air filter and the evaporator regularly must be cleaned to reduce the odor.

- Please contact your sales agent immediately if the air conditioner still fails to operate normally after the above inspections. Inform your agent of the model of your unit, production number, date of installation. Please also inform him regarding the fault.
- Power supply shall be connected at the rated voltage, otherwise the unit will be broken or could not reach the specified capacity.

### Please note:

On switching on the equipment, particularly when the room light is dimmed, a slight brightness fluctuation may occur. This is of no consequence.  
The conditions of the local Power Supply Companies are to be observed.

### Note

- Avoid to use the room air conditioner for cooling operation when the outside temperature is below 21°C (70°F).  
The recommended maximum and minimum operating temperatures of the hot and cold sides should be as below:

		Cooling		Heating	
		Minimum	Maximum	Minimum	Maximum
Indoor	Dry bulb °C	21	32	20	27
	Wet bulb °C	15	23	12	19
Outdoor	Dry bulb °C	21	43	2	21
	Wet bulb °C	15	26	1	15

# CONSTRUCTION AND DIMENSIONAL DIAGRAM

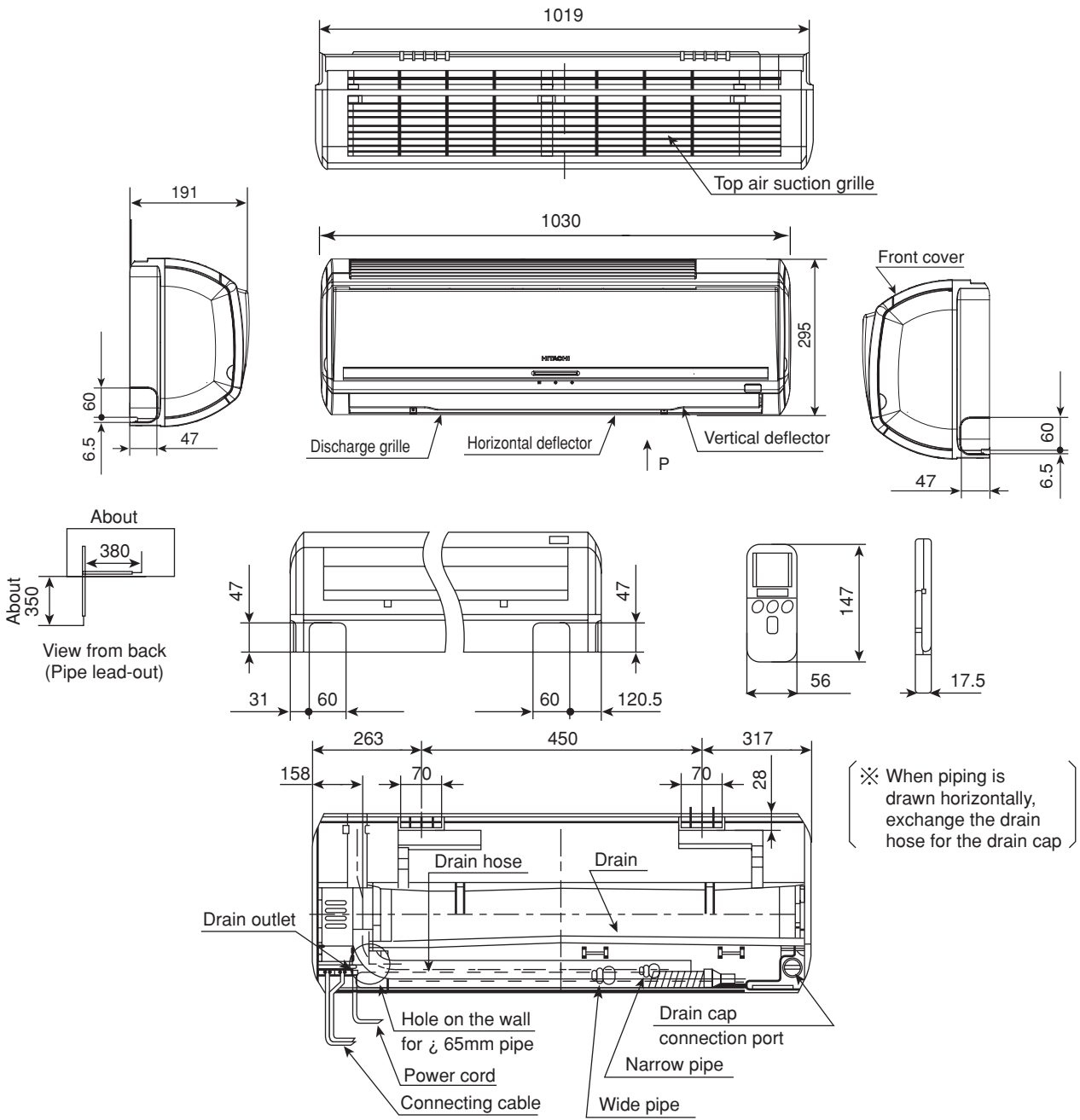

# CONSTRUCTION AND DIMENSIONAL DIAGRAM FOR OUTDOOR

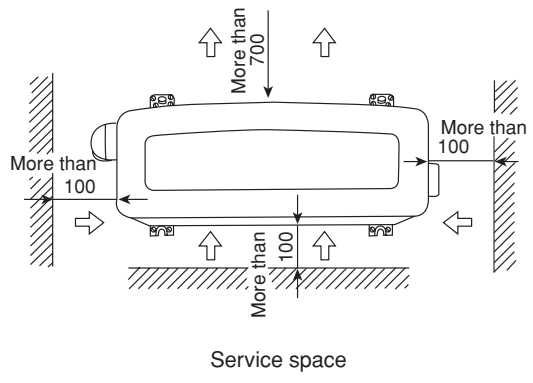
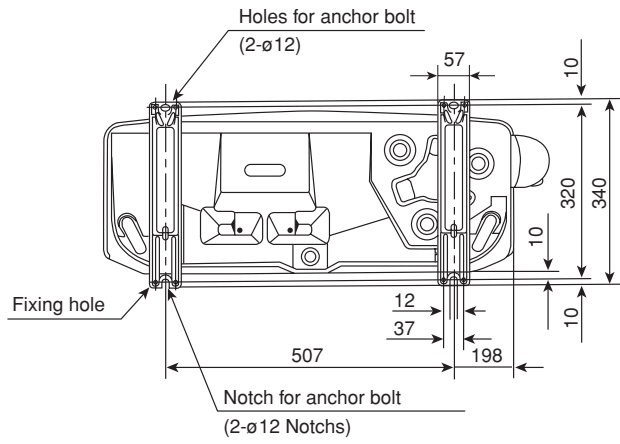
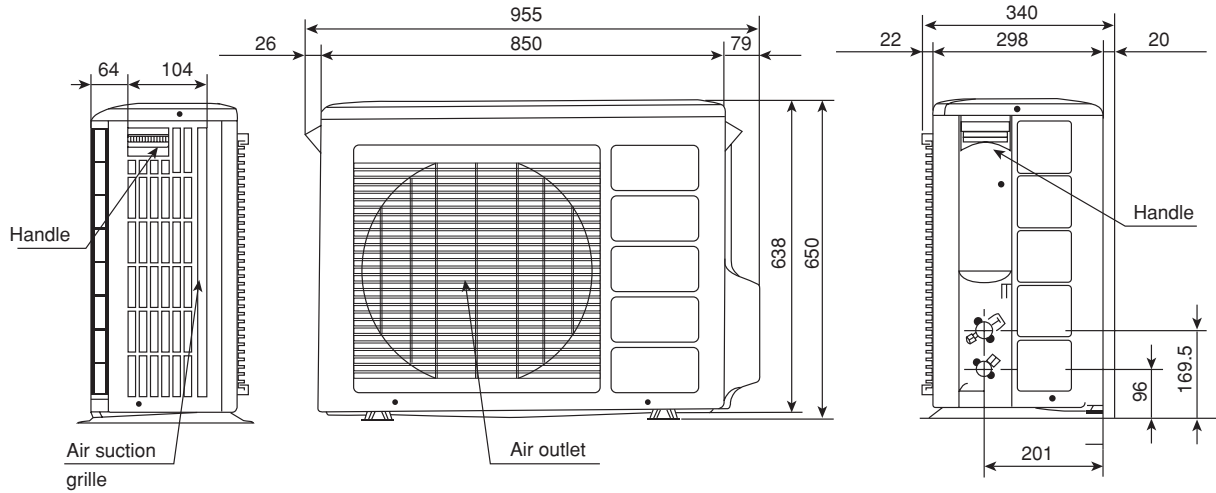

# MAIN PARTS COMPONENT

## THERMOSTAT

Thermostat Specifications

MODEL			RAS-60YH5/RAC-60YH5	
THERMOSTAT MODEL			IC	
OPERATION MODE			COOL	HEAT
TEMPERATURE °C (°F)	INDICATION 16	ON	15.6 (60.1)	20.0 (68.0)
		OFF	15.3 (59.5)	20.7 (69.3)
	INDICATION 24	ON	23.6 (74.5)	28.0 (82.4)
		OFF	23.3 (73.9)	28.7 (83.7)
	INDICATION 32	ON	31.6 (88.9)	36.0 (96.8)
		OFF	31.3 (88.3)	36.7 (98.1)

## FAN MOTOR

Fan Motor Specifications

MODEL	RAS-60YH5	RAC-60YH5
POWER SOURCE	DC: 0 ~ 35V	DC360V
OUTPUT	23W	40W
CONNECTION	<p>(Control circuit built in)</p>	

BLU : BLUE

YEL : YELLOW

BRN : BROWN

WHT : WHITE

GRY : GRAY

ORN : ORANGE

GRN : GREEN

RED : RED

BLK : BLACK

PNK : PINK

VIO : VIOLET



# COMPRESSOR MOTOR

## Compressor Motor Specifications

MODEL		RAC-60YH5
COMPRESSOR MODEL		JU1013D5
PHASE		SINGLE
RATED VOLTAGE		AC 220 ~ 240 V
RATED FREQUENCY		50 Hz
POLE NUMBER		4
CONNECTION		
RESISTANCE VALUE ( $\Omega$ )	20°C (68°F)	2M = 1.05
	75°C (167°F)	2M = 1.28

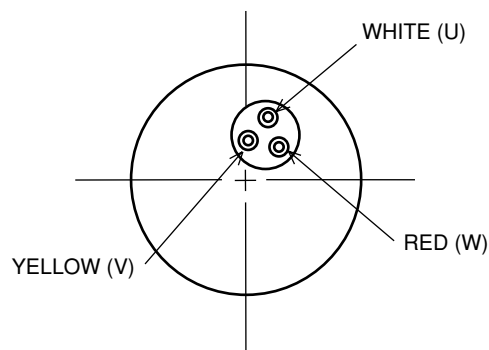

### **CAUTION**

When the refrigerating cycle has been operated for a long time with the capillary tubes clogged or crushed or with too little refrigerant, check the color of the refrigerating machine oil inside the compressor. If the color has been changed conspicuously, replace the compressor.

# WIRING DIAGRAM

MODEL RAS-60YH5 / RAC-60YH5

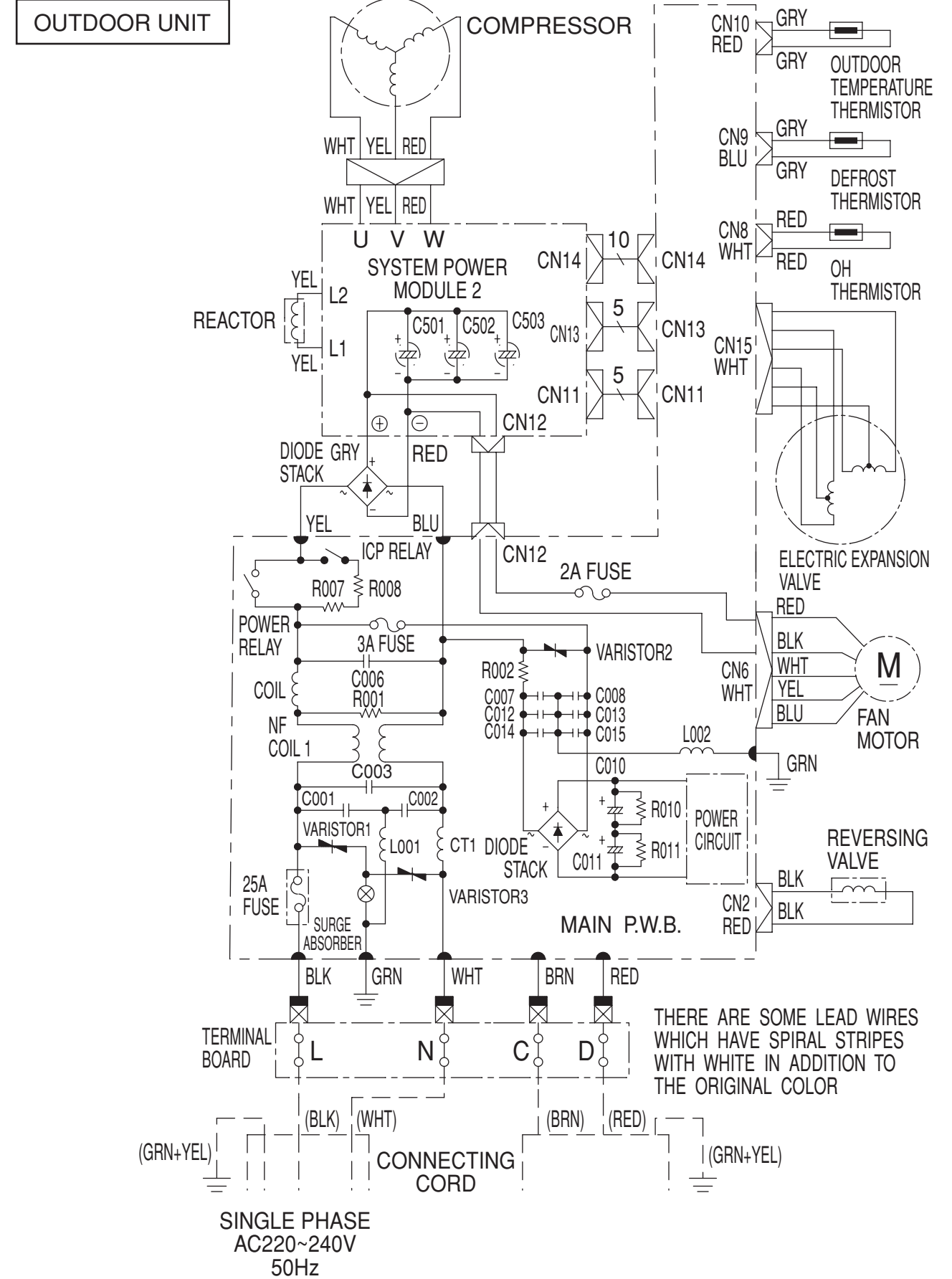
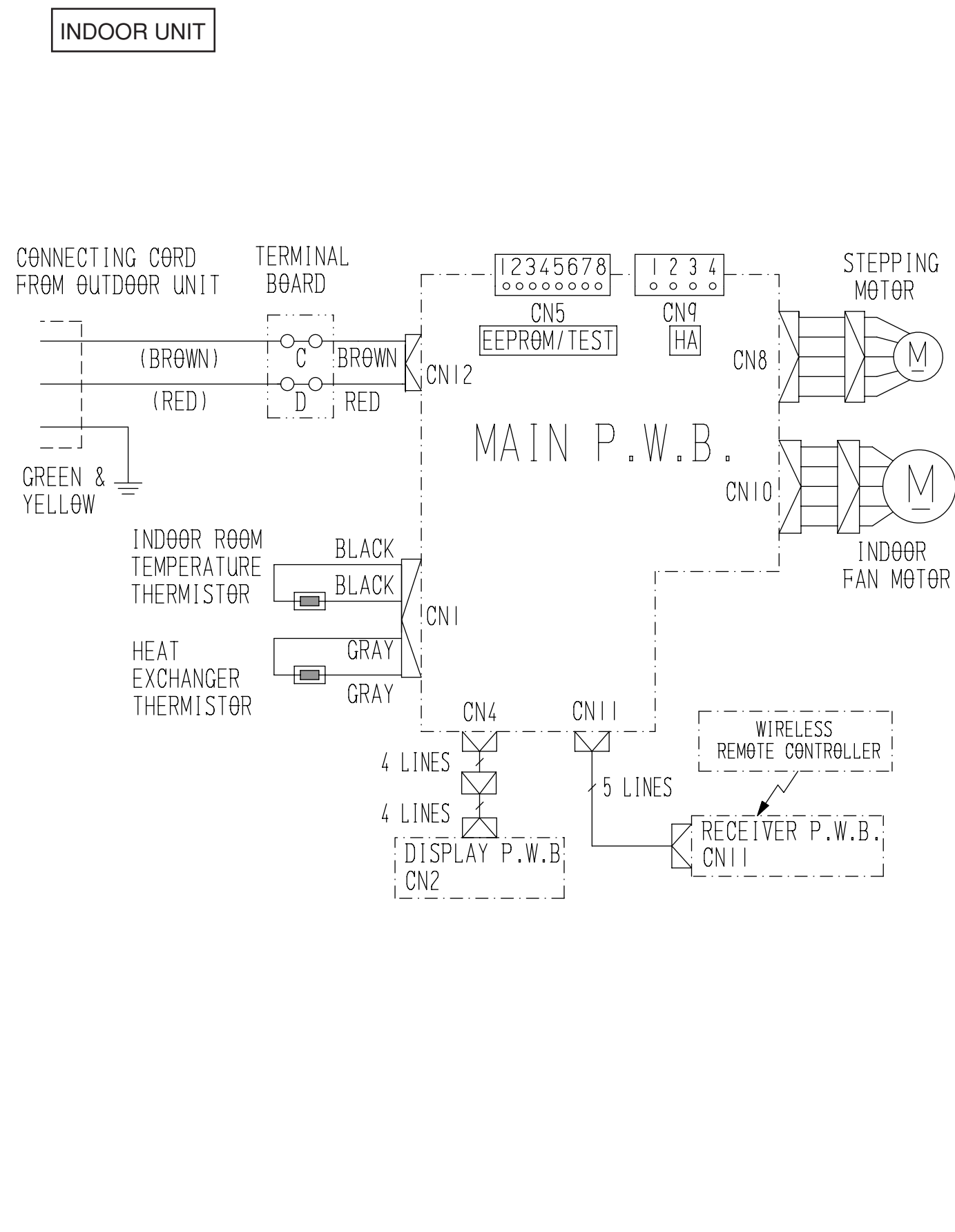

# CIRCUIT DIAGRAM

Remote Control

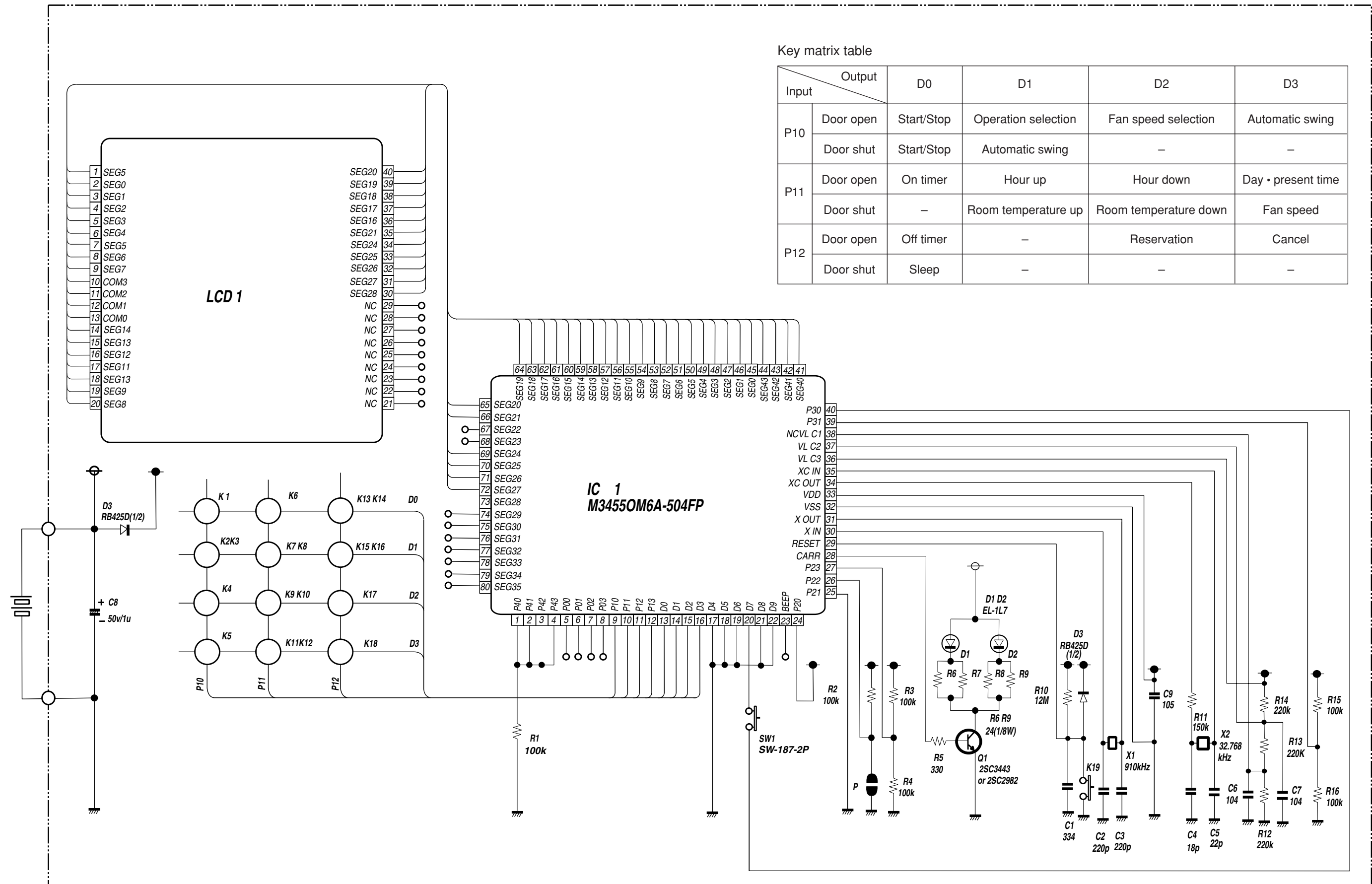

Key matrix table

Input \ Output		D0	D1	D2	D3
		D0	D1	D2	D3
P10	Door open	Start/Stop	Operation selection	Fan speed selection	Automatic swing
	Door shut	Start/Stop	Automatic swing	-	-
P11	Door open	On timer	Hour up	Hour down	Day · present time
	Door shut	-	Room temperature up	Room temperature down	Fan speed
P12	Door open	Off timer	-	Reservation	Cancel
	Door shut	Sleep	-	-	-

CIRCUIT DIAGRAM

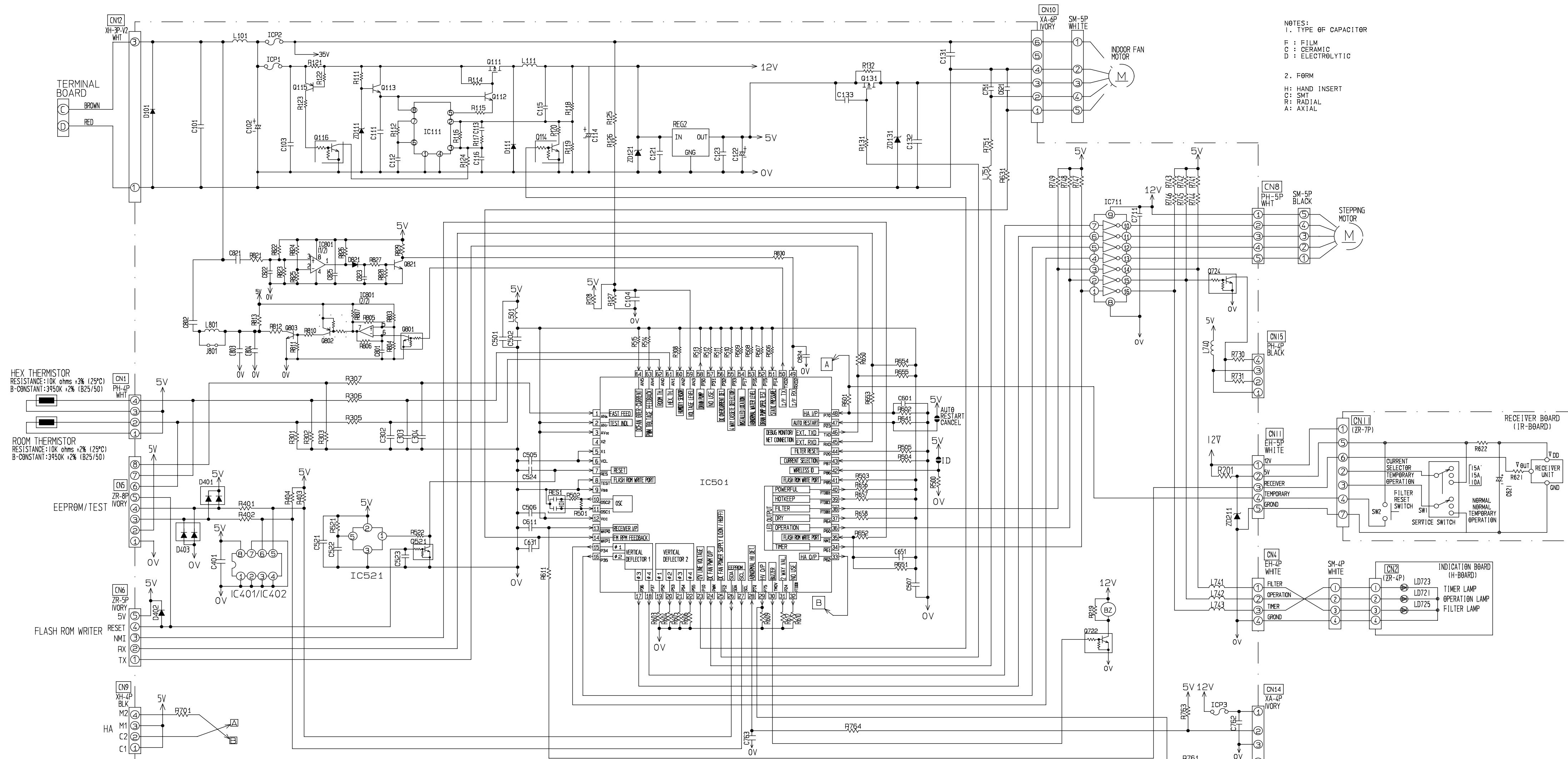

NOTES:  
 1. TYPE OF CAPACITOR  
 F : FILM  
 C : CERAMIC  
 D : ELECTROLYTIC  
 2. FORM  
 H: HAND INSERT  
 C: SMT  
 R: RADIAL  
 A: AXIAL

**RESISTOR**

SYMBOL	RESISTANCE	TOL.	POWER	FORM
R111	27K	±5%	1/10W	C
R112	30K	±5%	1/16W	C
R114	750	±5%	1/8W	C
R115	550	±5%	1/8W	C
R116	68K	±5%	1/16W	C
R117	75K	±2%	1/16W	C
R118	75K	±2%	1/16W	C
R119	6.98K	±2%	1/16W	C
R120				
R121	0.56	±5%	1/8W	C
R122	100	±5%	1/16W	C
R123	33K	±5%	1/16W	C
R124	100	±5%	1/16W	C
R125				
R126				
R127				
R128	10K	±5%	1/16W	C
R131				
R132	JUMPER	-	1/16W	C
R201	1K	±5%	1/10W	C
R219	3.3K	±5%	1/10W	C
R301	12.7K	±1%	1/16W	C
R302	12.7K	±1%	1/16W	C
R303	10K	±5%	1/16W	C
R305	1K	±5%	1/16W	C
R306	1K	±5%	1/16W	C

**RESISTOR**

SYMBOL	RESISTANCE	TOL.	POWER	FORM
R307	1K	±5%	1/16W	C
R308	10K	±5%	1/16W	C
R401	390	±5%	1/16W	C
R402	390	±5%	1/16W	C
R403	5.1K	±5%	1/16W	C
R404	5.1K	±5%	1/16W	C
R500	10K	±5%	1/16W	C
R501	1M	±5%	1/16W	C
R502	0			
R503	10K	±5%	1/16W	C
R504	10K	±5%	1/16W	C
R505	10K	±5%	1/16W	C
R506	10K	±5%	1/16W	C
R507	10K	±5%	1/16W	C
R508	10K	±5%	1/16W	C
R509	10K	±5%	1/16W	C
R510	10K	±5%	1/16W	C
R511	10K	±5%	1/16W	C
R512	10K	±5%	1/16W	C
R513	10K	±5%	1/16W	C
R514	10K	±5%	1/16W	C
R515	10K	±5%	1/16W	C
R521	1M	±5%	1/16W	C
R522	1K	±5%	1/16W	C
R601	1K	±5%	1/16W	C
R602	10K	±5%	1/16W	C
R603	10K	±5%	1/16W	C

**RESISTOR**

SYMBOL	RESISTANCE	TOL.	POWER	FORM
R604	10K	±5%	1/16W	C
R605	10K	±5%	1/16W	C
R606	10K	±5%	1/16W	C
R609				
R610	10K	±5%	1/16W	C
R611	1K	±5%	1/16W	C
R612	10K	±5%	1/16W	C
R621	10K	±5%	1/16W	C
R622	10K	±5%	1/16W	A
R631	1K	±5%	1/16W	C
R641	10K	±5%	1/16W	C
R650	1K	±5%	1/16W	C
R651	1K	±5%	1/16W	C
R652	10K	±5%	1/16W	C
R653	1K	±5%	1/16W	C
R654	10K	±5%	1/16W	C
R655	10K	±5%	1/16W	C
R656	10K	±5%	1/16W	C
R657	10K	±5%	1/16W	C
R658	10K	±5%	1/16W	C
R701	1K	±5%	1/16W	C
R730	390	±5%	1/16W	C
R731	390	±5%	1/16W	C
R741	10	±5%	1/10W	C
R742	10	±5%	1/10W	C
R743	10	±5%	1/10W	C

**RESISTOR**

SYMBOL	RESISTANCE	TOL.	POWER	FORM
R744	130	±5%	1/10W	C
R745	130	±5%	1/10W	C
R746	130	±5%	1/10W	C
R747	5.1K	±5%	1/16W	C
R748				
R749	5.1K	±5%	1/16W	C
R751	2.7K	±5%	1/16W	C
R761	100	±5%	1/16W	C
R763	10K	±5%	1/16W	C
R764	1K	±5%	1/16W	C
R803	120K	±5%	1/16W	C
R804	120K	±5%	1/16W	C
R805	120K	±5%	1/16W	C
R806	120K	±5%	1/16W	C
R807	4.3K	±5%	1/16W	C
R810	680	±5%	1/10W	C
R811	2K	±5%	1/16W	C
R812	39	±5%	1/8W	C
R813	39	±5%	1/8W	C
R821	1K	±5%	1/16W	C
R822	10K	±5%	1/16W	C
R823	10K	±5%	1/16W	C
R824	8.25K	±1%	1/16W	C
R825	10K	±5%	1/16W	C
R826	1K	±5%	1/16W	C
R827	3K	±5%	1/16W	C
R828	10K	±5%	1/16W	C
R829	5.1K	±5%	1/16W	C
R830	1K	±5%	1/16W	C

**CAPACITOR**

SYMBOL	CAPACITANCE	TOL.	TYPE	FORM
C101	0.22μ	50V	F	H
C102	330μ	63V	D	H
C103	470P	630V	C	C
C104				
C111	2.2μ	10V	D	H
C112	1000P	50V	D	H
C113	0.047μ	25V	D	H
C114	220μ	35V	D	H
C115				
C116				
C121	0.1μ	25V	D	H
C122	100μ	10V	D	H
C123	0.1μ	25V	D	H
C131	0.22μ	50V	D	H
C132	0.1μ	25V	D	H
C133				
C302	0.1μ	25V	D	H
C303	0.1μ	25V	D	H
C304	0.1μ	25V	D	H
C401	0.1μ	25V	D	H
C501	0.1μ	25V	D	H
C502	0.1μ	25V	D	H
C505	0.1μ	25V	D	H
C506	0.1μ	25V	D	H
C507	0.1μ	25V	D	H
C621	47μ	16V	D	H

**CAPACITOR**

SYMBOL	CAPACITANCE	TOL.	TYPE	FORM
C521	0.1μ	25V	D	H
C522	0.22μ	10V	D	H
C523	0.1μ	25V	D	H
C524	0.1μ	25V	D	H
C601	0.1μ	25V	D	H
C611	1000P	50V	D	H
C621				
C631	1000P	50V	D	H
C651	0.1μ	25V	D	H
C711	0.1μ	25V	D	H
C751	1μ	16V	D	H
C762				
C763	0.1μ	25V	D	H
C801	150P	50V	D	H
C802	0.22μ	50V	F	H
C803	0.1μ	25V	D	H
C804				
C821	0.01μ	50V	F	H
C822	1000P	50V	D	H
C823	0.047μ	25V	D	H
C824	0.01μ	50V	D	H
C825	0.1μ	25V	D	H

**TRANSISTOR**

SYMBOL	MODEL	FORM
Q111	2S5J18	C
Q112	2SC5209H	C
Q113	2SC5209H	C
Q114		
Q115	2SA1162Y	C
Q116	RN1102	C
Q131		
Q521	RN1102	C
Q722	RN1102	C
Q724	RN1102	C
Q801	RN1102	C
Q802	RN2102	C
Q803	2SC3441E	C
Q821	2SC4738GRY	C

**DIODE**

SYMBOL	MODEL	FORM
D101	G4DL-6140	H
D111	D1E55	C
D401		
D403		
D402	1SS355	C
D821	1SS355	C

**LED**

SYMBOL	MODEL	COLOR	FORM
LD721	SEL6914A	YEL	H
LD723	SEL6214S	RED	H
LD725	SEL6414E	GRN	H
LD726			
LD727			
LD728			
LD729			
LD730			
LD731			
LD732			
LD733			
LD734			
LD735			
LD736			
LD737			
LD738			
LD739			
LD740			
LD741			
LD742			
LD743			
LD744			
LD745			
LD746			
LD747			
LD748			
LD749			
LD750			
LD751			
LD752			
LD753			
LD754			
LD755			
LD756			
LD757			
LD758			
LD759			
LD760			
LD761			
LD762			
LD763			
LD764			
LD765			
LD766			
LD767			
LD768			
LD769			
LD770			
LD771			
LD772			
LD773			
LD774			
LD775			
LD776			
LD777			
LD778			
LD779			
LD780			
LD781			
LD782			
LD783			
LD784			
LD785			
LD786			
LD787			
LD788			
LD789			
LD790			
LD791			
LD792			
LD793			
LD794			
LD795			
LD796			
LD797			
LD798			
LD799			
LD800			

**INDUCTOR**

SYMBOL	INDUCTANCE	C. RATING	FORM
L101	B2μ	1.3A	H
L111	560μ	0.4A	H
L501	CHP JUMPER	-	C
L740	EXCELSA35V	-	H
L741	CHP JUMPER	-	C
L742	CHP JUMPER	-	C
L743	CHP JUMPER	-	C
L751	CHP JUMPER	-	C
L801	100μ	55mA	C

**IC**

SYMBOL	MODEL	FORM
IC111	NUM2340M	C
REG2	MC7805CT	H
IC401	BR24C02F	C
IC402	S24C010P	H
IC501	AX-7810	C
IC521	FN5V042C	C
IC711	LVN3003ANS	C
IC801	NUM2303M	C
IC802	RECEIVER SBK935-F	H

# CIRCUIT DIAGRAM

MODEL RAC-60YH5

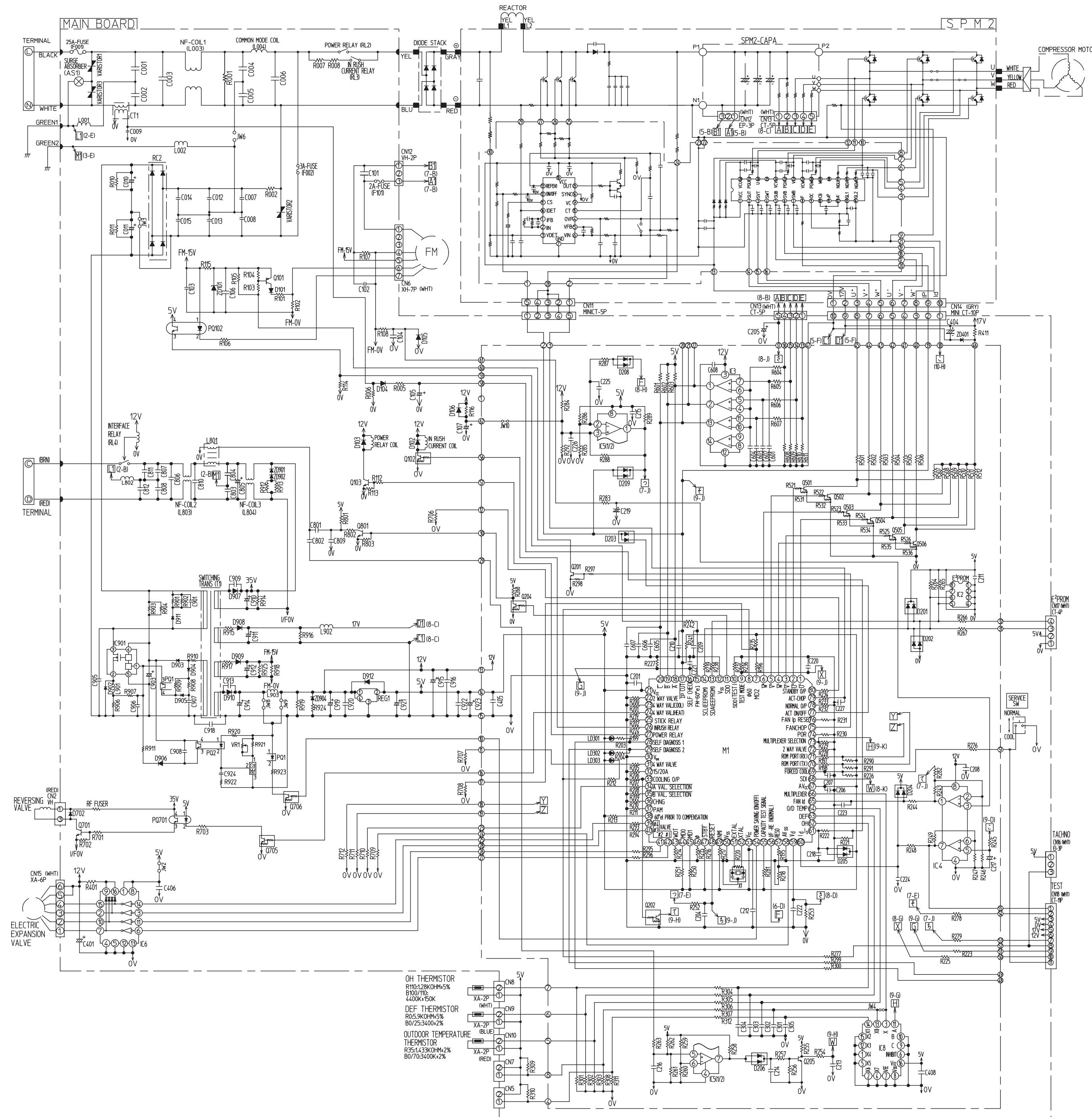

MOUNTING		BOARD	
A: AXIAL	HIC: HYBRID IC		
R: RADIAL (R1,R2)	M: MAIN BOARD		
P: RADIAL (7.5MM PITCH)			
H: MANUAL INSERT			

COMPONENT TYPE	
C: CERAMIC	
F: FILM	
E: ELECTROLYTIC	

RESISTORS				
MARK	RATING (TR)	(%T/W)	MOUNTING	REMARK
R001	470K	5%	A	M
R002	2.2	5%	H	M
R003	169K	5%	H	M
R004	10K	5%	H	M
R005	100	5%	H	M
R006	100	5%	H	M
R007	100	5%	H	M
R008	100	5%	H	M
R009	100	5%	H	M
R010	470K	5%	H	M
R011	470K	5%	H	M
R012	3K	5%	H	M
R013	30K	5%	H	M
R014	3.9K	5%	H	M
R015	7.5K	5%	H	M
R016	2.4K	5%	H	M
R017	1	5%	H	M
R018	510	5%	H	M
R019	10K	5%	H	M
R020	10K	5%	H	M
R021	10K	5%	H	M
R022	10K	5%	H	M
R023	10K	5%	H	M
R024	10K	5%	H	M
R025	10K	5%	H	M
R026	10K	5%	H	M
R027	10K	5%	H	M
R028	10K	5%	H	M
R029	10K	5%	H	M
R030	10K	5%	H	M
R031	10K	5%	H	M
R032	10K	5%	H	M
R033	10K	5%	H	M
R034	10K	5%	H	M
R035	10K	5%	H	M
R036	10K	5%	H	M
R037	10K	5%	H	M
R038	10K	5%	H	M
R039	10K	5%	H	M
R040	10K	5%	H	M
R041	10K	5%	H	M
R042	10K	5%	H	M
R043	10K	5%	H	M
R044	10K	5%	H	M
R045	10K	5%	H	M
R046	10K	5%	H	M
R047	10K	5%	H	M
R048	10K	5%	H	M
R049	10K	5%	H	M
R050	10K	5%	H	M
R051	10K	5%	H	M
R052	10K	5%	H	M
R053	10K	5%	H	M
R054	10K	5%	H	M
R055	10K	5%	H	M
R056	10K	5%	H	M
R057	10K	5%	H	M
R058	10K	5%	H	M
R059	10K	5%	H	M
R060	10K	5%	H	M
R061	10K	5%	H	M
R062	10K	5%	H	M
R063	10K	5%	H	M
R064	10K	5%	H	M
R065	10K	5%	H	M
R066	10K	5%	H	M
R067	10K	5%	H	M
R068	10K	5%	H	M
R069	10K	5%	H	M
R070	10K	5%	H	M
R071	7.5K	5%	H	M
R072	10K	5%	H	M
R073	470	5%	H	M
R074	10K	5%	H	M
R075	10K	5%	H	M
R076	10K	5%	H	M
R077	10K	5%	H	M
R078	10K	5%	H	M
R079	10K	5%	H	M
R080	10K	5%	H	M
R081	10K	5%	H	M
R082	10K	5%	H	M
R083	10K	5%	H	M
R084	10K	5%	H	M
R085	10K	5%	H	M
R086	10K	5%	H	M
R087	10K	5%	H	M
R088	10K	5%	H	M
R089	10K	5%	H	M
R090	10K	5%	H	M
R091	10K	5%	H	M
R092	10K	5%	H	M
R093	10K	5%	H	M
R094	10K	5%	H	M
R095	10K	5%	H	M
R096	10K	5%	H	M
R097	10K	5%	H	M
R098	10K	5%	H	M
R099	10K	5%	H	M
R100	10K	5%	H	M
R101	10K	5%	H	M
R102	10K	5%	H	M
R103	10K	5%	H	M
R104	10K	5%	H	M
R105	10K	5%	H	M
R106	10K	5%	H	M
R107	10K	5%	H	M
R108	10K	5%	H	M
R109	10K	5%	H	M
R110	10K	5%	H	M
R111	10K	5%	H	M
R112	10K	5%	H	M
R113	10K	5%	H	M
R114	10K	5%	H	M
R115	10K	5%	H	M
R116	10K	5%	H	M
R117	10K	5%	H	M
R118	10K	5%	H	M
R119	10K	5%	H	M
R120	10K	5%	H	M
R121	10K	5%	H	M
R122	10K	5%	H	M
R123	10K	5%	H	M
R124	10K	5%	H	M
R125	10K	5%	H	M
R126	10K	5%	H	M
R127	10K	5%	H	M
R128	10K	5%	H	M
R129	10K	5%	H	M
R130	10K	5%	H	M
R131	10K	5%	H	M
R132	10K	5%	H	M
R133	10K	5%	H	M
R134	10K	5%	H	M
R135	10K	5%	H	M
R136	10K	5%	H	M
R137	10K	5%	H	M
R138	10K	5%	H	M
R139	10K	5%	H	M
R140	10K	5%	H	M
R141	10K	5%	H	M
R142	10K	5%	H	M
R143	10K	5%	H	M
R144	10K	5%	H	M
R145	10K	5%	H	M
R146	10K	5%	H	M
R147	10K	5%	H	M
R148	10K	5%	H	M
R149	10K	5%	H	M
R150	10K	5%	H	M
R151	10K	5%	H	M
R152	10K	5%	H	M
R153	10K	5%	H	M
R154	10K	5%	H	M
R155	10K	5%	H	M
R156	10K	5%	H	M
R157	10K	5%	H	M
R158	10K	5%	H	M
R159	10K	5%	H	M
R160	10K	5%	H	M
R161	10K	5%	H	M
R162	10K	5%	H	M
R163	10K	5%	H	M
R164	10K	5%	H	M
R165	10K	5%	H	M
R166	10K	5%	H	M
R167	10K	5%	H	M
R168	10K	5%	H	M
R169	10K	5%	H	M
R170	10K	5%	H	M
R171	10K	5%	H	M
R172	10K	5%	H	M
R173	10K	5%	H	M
R174	10K	5%	H	M
R175	10K	5%	H	M
R176	10K	5%	H	M
R177	10K	5%	H	M
R178	10K	5%	H	M
R179	10K	5%	H	M
R180	10K	5%	H	M
R181	10K	5%	H	M
R182	10K	5%	H	M
R183	10K	5%	H	M
R184	10K	5%	H	M
R185	10K	5%	H	M
R186	10K	5%	H	M
R187	10K	5%	H	M
R188	10K	5%	H	M
R189	10K	5%	H	M
R190	10K	5%	H	M
R191	10K	5%	H	M
R192	10K	5%	H	M
R193	10K	5%	H	M
R194	10K	5%	H	M
R195	10K	5%	H	M
R196	10K	5%	H	M
R197	10K	5%	H	M
R198	10K	5%	H	M
R199	10K	5%	H	M
R200	10K	5%	H	M
R201	10K	5%	H	M
R202	10K	5%	H	M
R203	10K	5%	H	M
R204	10K	5%	H	M
R205	10K	5%	H	M
R206	10K	5%	H	M
R207	10K	5%	H	M
R208	10K	5%	H	M
R209	10K	5%	H	M
R210	10K	5%	H	M
R211	10K	5%	H	M
R212	10K	5%	H	M
R213	10K	5%	H	M
R214	10K	5%	H	M
R215	10K	5%	H	M
R216	10K	5%	H	M
R217	10K	5%	H	M
R218	10K	5%	H	M
R219	10K	5%	H	M
R220	10K	5%	H	M
R221	10K	5%	H	M
R222	10K	5%	H	M
R223	10K	5%	H	M
R224	10K	5%	H	M
R225	10K	5%	H	M
R226	10K	5%	H	M
R227	10K	5%	H	M
R228	10K	5%	H	M
R229	10K	5%	H	M
R230	10K	5%	H	M
R231	10K	5%	H	M
R232	10K	5%	H	M
R233	10K	5%	H	M
R234	10K	5%	H	M
R235	10K	5%	H	M
R236	10K	5%	H	M
R237	10K	5%	H	M
R238	10K	5%	H	M
R239	10K	5%	H	M
R240	10K	5%	H	M
R241	10K	5%	H	M
R242	10K	5%	H	M
R243	10K	5%	H	M
R244	10K	5%	H	M
R245	10K	5%	H	M
R246	10K	5%	H	M
R247	10K	5%	H	M
R248	10K	5%	H	M
R249	10K	5%	H	M
R250	10K	5%	H	M
R251	10K	5%	H	M
R252	10K	5%	H	M
R253	10K	5%	H	M
R254	10K	5%	H	M
R255	10K	5%	H	M
R256	10K	5%	H	M
R257	10K	5%	H	M
R258	10K	5%	H	M
R259	10K	5%	H	M

# PRINTED WIRING BOARD LOCATION DIAGRAM

## MAIN P.W.B.

Marking on P.W.B.

COMPONENT SIDE

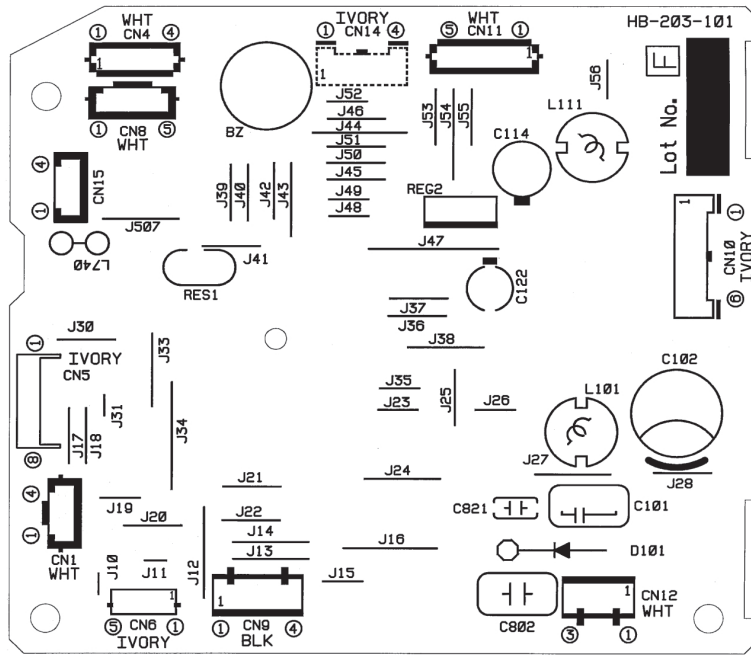

SOLDERING SIDE

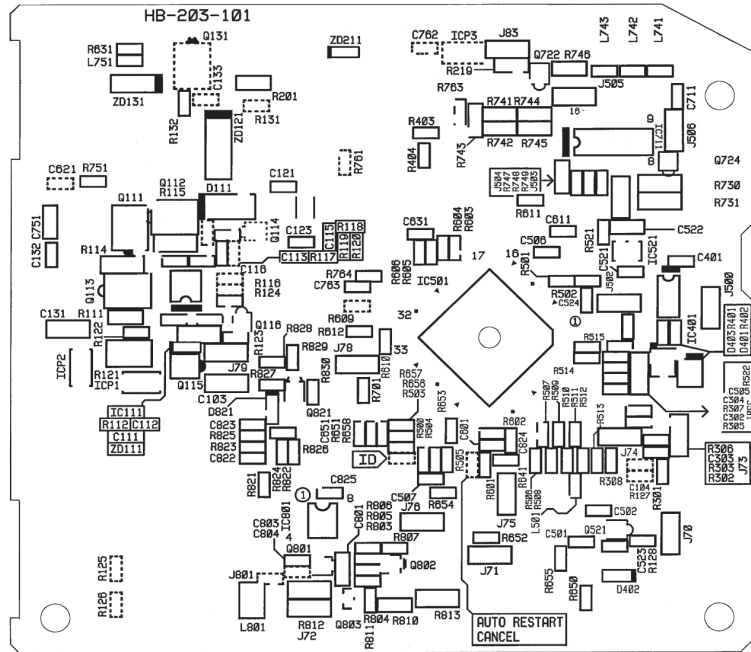

## RECEIVING P.W.B.

Marking on P.W.B.

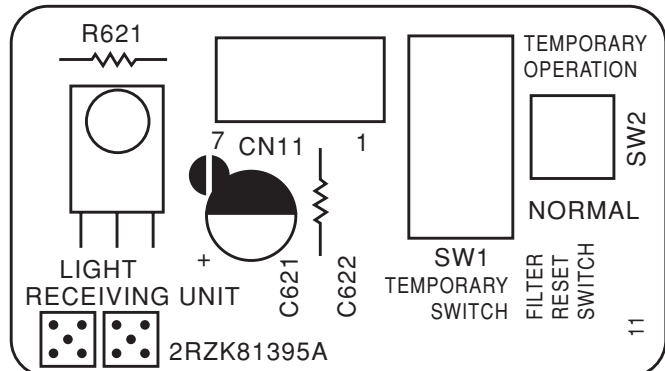

**BLOCK DIAGRAM**

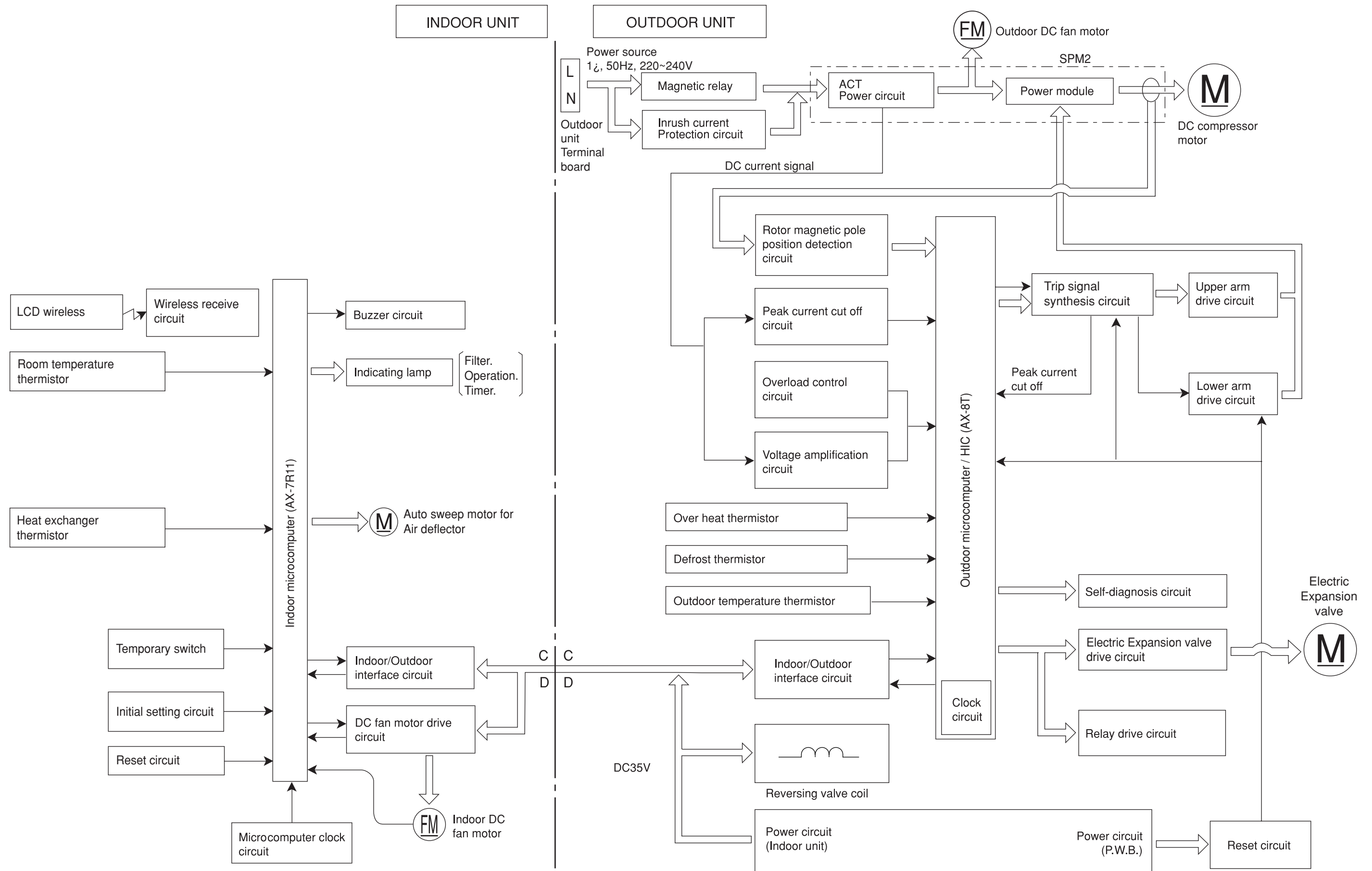

# BASIC MODE

Operation mode	Fan	Cooling	Dehumidifying (dehumidifying operation by the function select button only, not including that engaged by the dehumidify button)	Heating	Auto										
Basic operation of start/stop switch															
Timer functions	Off-timer														
	On-timer														
	Off -> On On -> Off timer														
Fan speed mode (indoor fan)	Auto	<p>Changes from "Hi" to "Med" or "Lo" depending on room temperature.</p> <p>1. Runs at "Hi" until first thermo off after operation is started. 2. Runs at "Lo" when thermo is off.</p>	<p>Changes between "Lo" and "Med" depending on the room temperature.</p> <table border="1"> <thead> <tr> <th>Temperature division</th> <th>Fan speed</th> </tr> </thead> <tbody> <tr> <td>Division 1</td> <td>Lo</td> </tr> <tr> <td>Division 2</td> <td>Lo</td> </tr> <tr> <td>Division 3</td> <td>Med</td> </tr> <tr> <td>Division 4</td> <td>Med</td> </tr> </tbody> </table> <p>1. The indoor fan also stops when the compressor is in stop status.</p>	Temperature division	Fan speed	Division 1	Lo	Division 2	Lo	Division 3	Med	Division 4	Med	<p>Set to "ultra-Lo", "Lo", "Med", "Hi", "ultra-Hi" or "stop" depending on the room temperature, time and heat exchange temperature. Set to "stop" if the room temperature is 18°C in the "ultra-Lo" mode other than during preheating (cooling is recovered at 18.33°C).</p> <p>When the compressor is running at maximum speed during hot dash or when recovered from defrosting. In modes other than left</p>	<p>Operating mode is judged by room temperature and outdoor temperature.</p> <p>(1) Judging by outdoor temperature</p> <ul style="list-style-type: none"> <li>Operating mode is judged by outdoor temperature. Only when the mode is not restricted by this judgment, the judgment by room temperature in the next paragraph will be performed.</li> <li>(a) Outdoor temperature <math>\geq 30^{\circ}\text{C}</math> : Restricted to cooling</li> <li>(b) Outdoor temperature <math>\leq 9^{\circ}\text{C}</math> : Restricted to heating</li> </ul> <p>(2) Judging by room temperature</p> <p>Operating mode at start up is judged (initial judgment)</p> <p>(a) Conditions for judgment (any of the followings)</p> <ul style="list-style-type: none"> <li>When auto operation is started after 1 hour has elapsed since the operation was stopped.</li> <li>When auto operation is started after the previous manual mode operation.</li> <li>When the operating mode is switched to auto while operating at manual mode.</li> </ul> <p>(b) Judging method</p> <ul style="list-style-type: none"> <li>Room temperature <math>\geq 23^{\circ}\text{C} \pm 3^{\circ}\text{C}</math> : Cooling</li> <li>Room temperature <math>&lt; 23^{\circ}\text{C} \pm 3^{\circ}\text{C}</math> : Heating</li> <li>※ <math>\pm 3^{\circ}\text{C}</math> is the fine adjustment value from the remote controller.</li> </ul> <p>Judging operating mode change during operation (Continuous judgment)</p> <p>(a) Conditions for judgment (any of the followings)</p> <ul style="list-style-type: none"> <li>The mode is reviewed at every interval time.</li> <li>When auto operation is started again before 1 hour has elapsed since the operation was stopped.</li> </ul> <p>(b) Judging method</p> <ul style="list-style-type: none"> <li>Judge by setting the hysteresis on the final preset temperature.</li> <li>The final preset temperature is the actually targeted preset temperature which is the sum of the basic preset temperature and each type of shift value (e.g. <math>\pm 3^{\circ}\text{C}</math> by remote controller, preset temperature correction value, powerful shift value, etc.).</li> </ul> <p>[Currently cooling]</p> <ul style="list-style-type: none"> <li>Room temperature <math>\leq</math> Final preset temperature <math>-3^{\circ}\text{C}</math> Change to heating</li> <li>Room temperature <math>&lt;</math> Final preset temperature <math>-3^{\circ}\text{C}</math> Continue cooling</li> </ul> <p>[Currently heating]</p> <ul style="list-style-type: none"> <li>Room temperature <math>\geq</math> Final preset temperature <math>+2^{\circ}\text{C}</math> Change to cooling</li> <li>Room temperature <math>&lt;</math> Final preset temperature <math>+2^{\circ}\text{C}</math> Continue heating</li> </ul>
	Temperature division	Fan speed													
	Division 1	Lo													
	Division 2	Lo													
Division 3	Med														
Division 4	Med														
Hi	Operates at "Hi" regardless of the room temperature.	Set to "ultra-Hi" when the compressor runs at maximum speed, and to "Hi" in other modes.	Set to "Hi" in modes other than when the compressor stops.	Set to "ultra-Lo", "Lo", "Med", "Hi", "ultra-Hi" or "stop" depending on the room temperature, and time. Set to "stop" if the room temperature is 18°C in the "ultra-Lo" mode other than during preheating (cooling is recovered at 18.33°C). Set to "ultra-Hi" when the compressor is running at maximum speed during hot dash or when recovered from defrosting.											
Med	Operates at "Med" regardless of the room temperature.	Same as at left.	Set to "Med" in modes other than when the compressor stops.	Set to "ultra-Lo", "Lo", "Med" or "stop" depending on the room temperature and time. Set to "stop" if the room temperature is 18°C in the "ultra-Lo" mode other than during preheating (cooling is recovered at 18.33°C).											
Lo	Operates at "Lo" regardless of the room temperature.	Same as at left.	Set to "Lo" in modes other than when the compressor stops.	Set to "ultra-Lo", "Lo", or "stop" depending on the room temperature and time. Set to "stop" if the room temperature is 18°C in the "ultra-Lo" mode other than during preheating (cooling is recovered at 18.33°C). The fan speed is controlled by the heat exchanger temperature; the overload control is executed as in the following diagram:											
Basic operation of temperature controller	Performs only fan operation at the set speed regardless of the room temperature.	See page 49.	See page 53.	See page 55.											
Sleep operation (with sleep button ON)	<ul style="list-style-type: none"> <li>Enters sleep operation after set as on the left.</li> <li>Action during sleep operation Lo (sleep) operation</li> </ul>	<ul style="list-style-type: none"> <li>Same as at left</li> <li>See page 51.</li> </ul>	<ul style="list-style-type: none"> <li>Same as at left</li> <li>See page 53.</li> </ul>	<ul style="list-style-type: none"> <li>Same as at left</li> <li>See page 57.</li> </ul>	<ul style="list-style-type: none"> <li>Same as at left.</li> <li>Performs the sleep operation of each operation mode.</li> </ul>										



**Table 1 Mode data file**

	<b>RAS-60YH5</b>
<b>LABEL NAME</b>	<b>VALUE</b>
WMAX	6300 min <sup>-1</sup>
WMAX2	6300 min <sup>-1</sup>
WSTD	5900 min <sup>-1</sup>
WBEMAX	3600 min <sup>-1</sup>
CMAX	6300 min <sup>-1</sup>
CMAX2	6300 min <sup>-1</sup>
CSTD	5850 min <sup>-1</sup>
CKYMAX	4550 min <sup>-1</sup>
CJKMAX	3700 min <sup>-1</sup>
CBEMAX	3000 min <sup>-1</sup>
WMIN	1200 min <sup>-1</sup>
CMIN	1500 min <sup>-1</sup>
STARTMC	60 Seconds
DWNRATEW	80%
DWNRATEC	80%
SHIFTW	3.33°C
SHIFTC	0.33°C
CLMXTP	30.00°C
YNEOF	28.00°C
TEION	2.00°C
TEIOF	9.00°C
SFTDSW	1.00°C
DFTIM1	45 Minutes
DFTIM2	60 Minutes

## Basic Cooling Operation

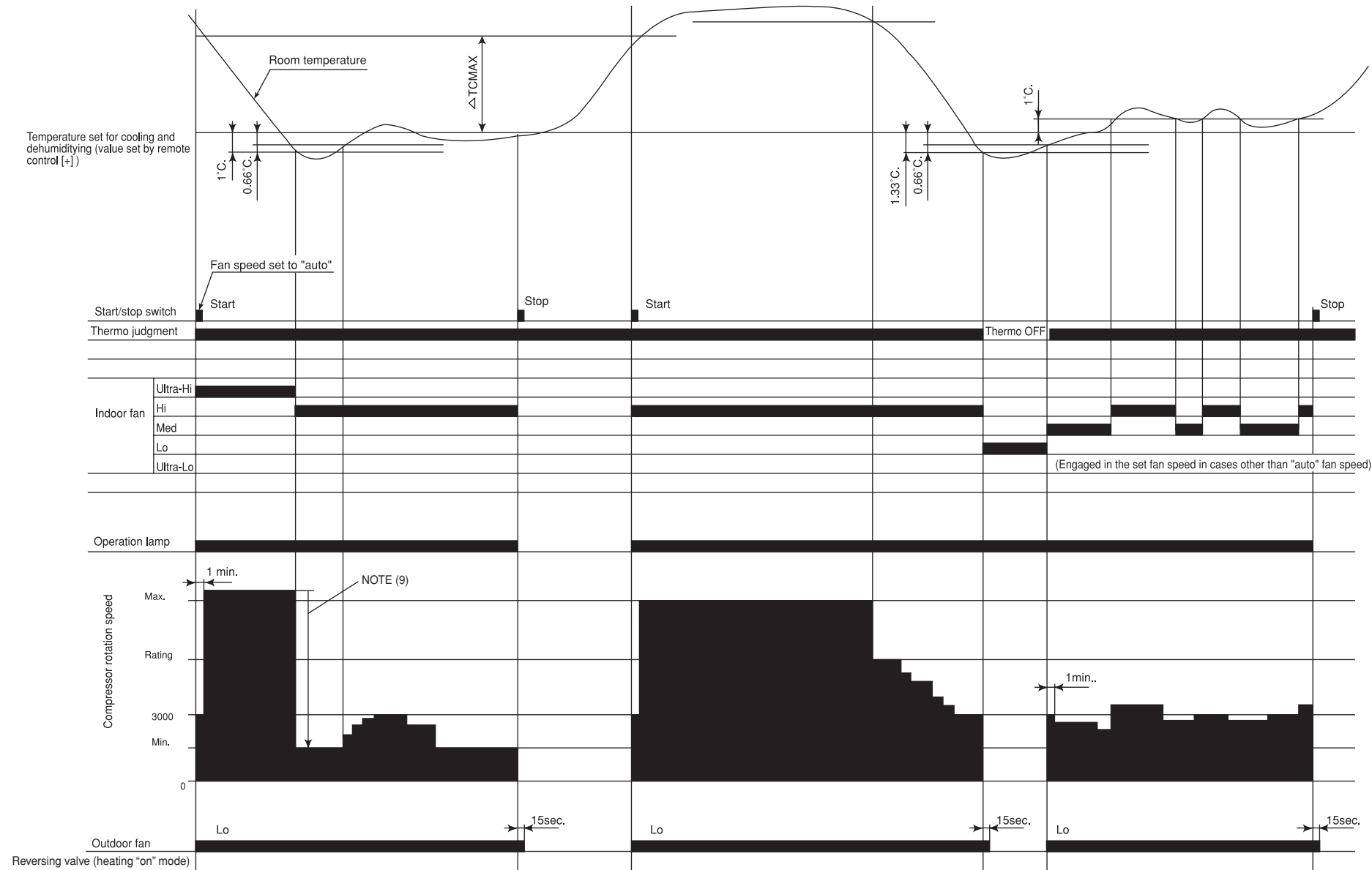

**Notes:**

- (1) Condition for entering into Cool Dashed mode. When fan set to "Hi" or "Auto mode" and temperature difference between indoor temperature and set temperature has a corresponding compressor rpm (calculated value in Table 2) larger than WMAX.
- (2) Cool Dashed will release when i) a maximum 25 minutes is lapsed and ii) room temperature is lower than set temperature  $-3^{\circ}\text{C}$  (thermo off) and iii) when room temperature has achieved setting temperature  $-1^{\circ}\text{C}$  then maximum Cool Dashed time will be revised to 20 minutes. And iv) indoor fan is set to Lo and Med fan mode and v) change operation mode.
- (3) During Cool Dashed operation, thermo off temperature is set temperature (with shift value)  $-3^{\circ}\text{C}$ . After thermo off, operation continue in Fuzzy control mode.
- (4) Compressor minimum "ON" time and "OFF" time is 3 minutes.
- (5) During normal cooling mode, compressor maximum rpm CMAX will maintain for 60 minutes if indoor temperature is lower than CLMXTTP. No time constrain if indoor temperature is higher than CLMXTTP.
- (6) When fan is set to "Hi", compressor rpm will be limited to CKYMAX.
- (7) When fan is set to "Med", compressor rpm will be limited to CJKMAX.
- (8) When fan is set to "Lo", compressor rpm will be limited to CBEMAX.
- (9) During Cool Dashed, when room temperature reaches set temperature  $-1^{\circ}\text{C}$  compressor rpm is actual rpm x DWRATEC.

Table 2  $\Delta\text{TCMAX}$

Temperature difference	Calculated compressor rpm
1.66	2265 $\text{min}^{-1}$
2	2435 $\text{min}^{-1}$
2.33	2600 $\text{min}^{-1}$
2.66	2765 $\text{min}^{-1}$
3	2935 $\text{min}^{-1}$
3.33	3100 $\text{min}^{-1}$
3.66	3265 $\text{min}^{-1}$
4	3435 $\text{min}^{-1}$
4.33	3600 $\text{min}^{-1}$
4.66	3765 $\text{min}^{-1}$
5	3935 $\text{min}^{-1}$
5.33	4100 $\text{min}^{-1}$
5.66	4265 $\text{min}^{-1}$
6	4435 $\text{min}^{-1}$
6.33	4600 $\text{min}^{-1}$
6.66	4765 $\text{min}^{-1}$
7	4935 $\text{min}^{-1}$
7.33	5100 $\text{min}^{-1}$
7.66	5265 $\text{min}^{-1}$
8	5435 $\text{min}^{-1}$
8.33	5600 $\text{min}^{-1}$
8.66	5765 $\text{min}^{-1}$
9	5935 $\text{min}^{-1}$
9.33	6100 $\text{min}^{-1}$
9.66	6265 $\text{min}^{-1}$
10	6435 $\text{min}^{-1}$
10.33	6600 $\text{min}^{-1}$
10.66	6765 $\text{min}^{-1}$
11	6935 $\text{min}^{-1}$

## Cooling Defrost

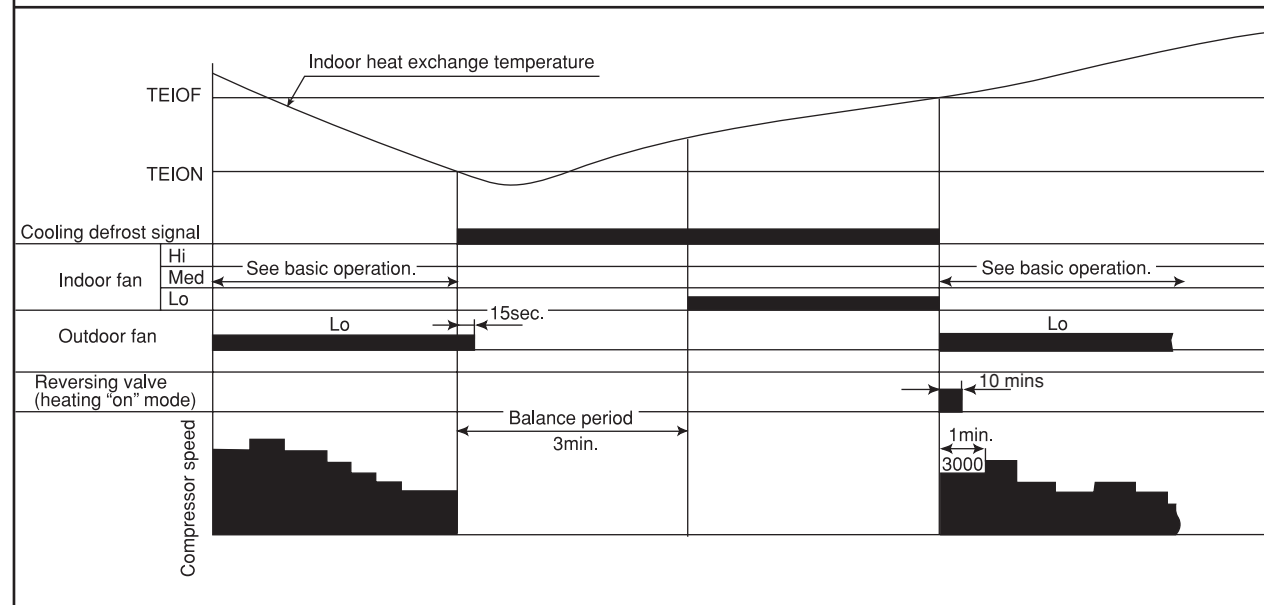

## Cooling Sleep Operation

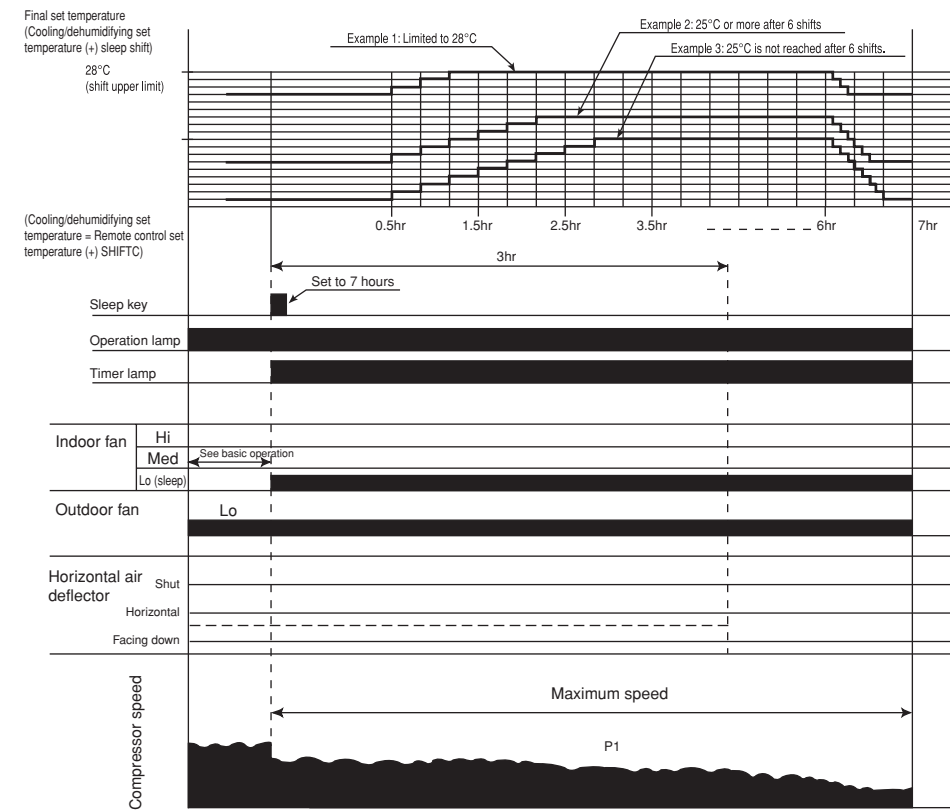

### Notes:

- (1) The sleep operation starts when the sleep key is pressed.
- (2) When the sleep key is set, the maximum compressor speed is limited, and the indoor fan is set to "sleep Lo".
- (3) 30 minutes after the sleep key is set, the sleep shift of temperature starts, and upper shift is made at least 6 times. If 25°C is not reached after 6 shifts, shifts repeat until 25°C is reached.
- (4) The sleep shift upper value of set temperature is 28°C.
- (5) After 6 hours, a shift down to the initial set temperature is made at a rate of 0.33°C/5 min.
- (6) If the operation mode is changed during sleep operation, the set temperature is cleared, and shift starts from the point when switching is made.
- (7) The indoor fan speed does not change even when the fan speed mode is changed.
- (8) When operation is stopped during sleep operation, the set temperature when stopped, as well as the time, continue to be counted.
- (9) If the set time is changed during sleep operation, all data including set temperature, time, etc. is cleared and restarted.
- (10) If sleep operation is canceled by the cancel key or sleep key, all data is cleared.

# Dehumidifying

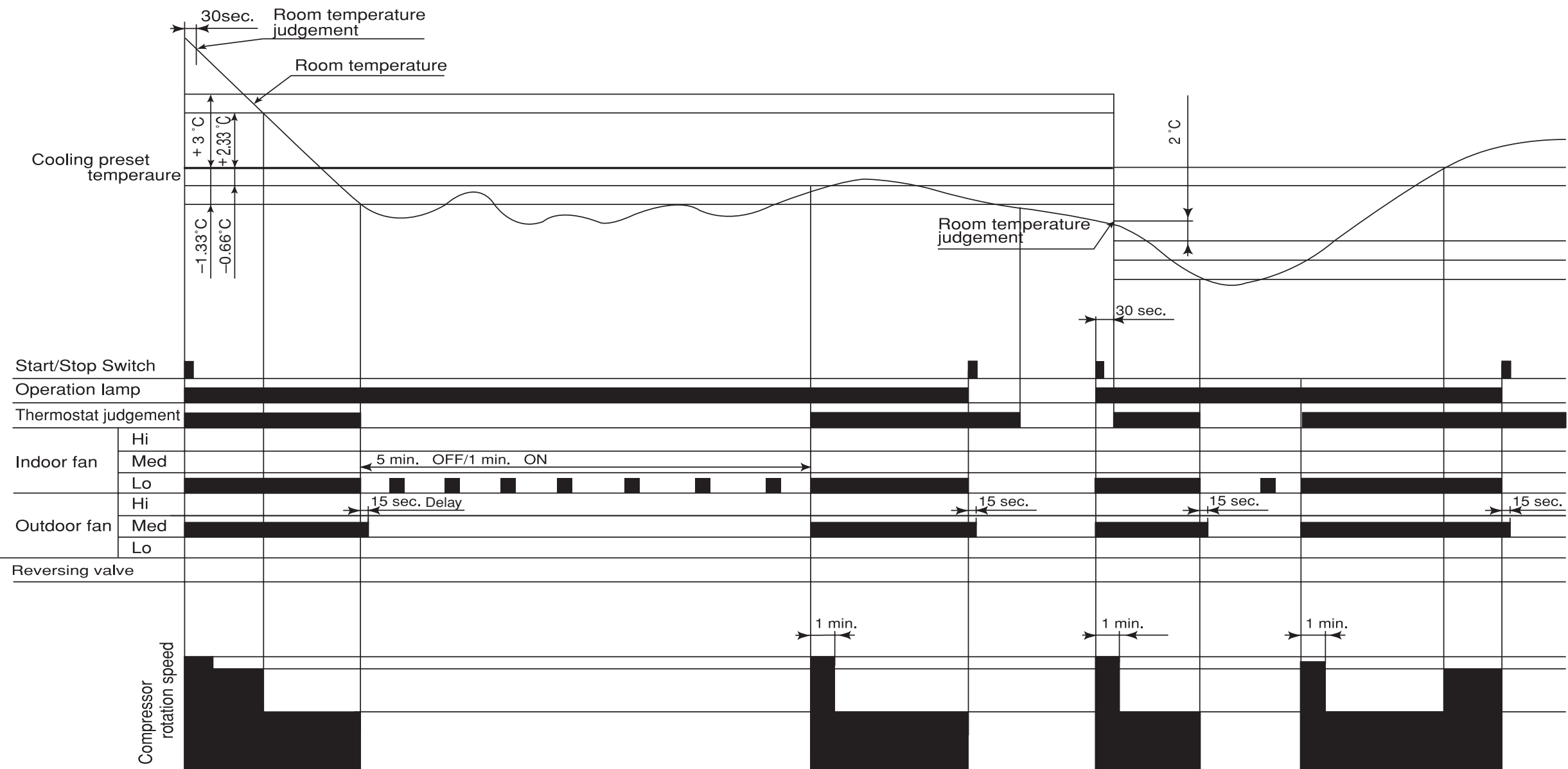

**Notes:**

- (1) If the room temperature is (cooling preset temperature) - (1.33°C) or less after 30 seconds from starting the operation, the operation is done assuming as the preset temperature = (room temperature at the time) - (2°C).
- (2) The indoor fan is operated in the "Lo" mode. During thermo OFF indoor fan will be OFF for 5 minutes and ON for 1 minute.
- (3) When the operation is started by the thermostat turning ON, the start of the indoor fan is delayed 32 seconds after the start of compressor operation.
- (4) The compressor is operated forcedly for 3 minutes after operation is started.
- (5) The minimum ON time and OFF time of the compressor are 3 minutes.

## Basic Heating Operation

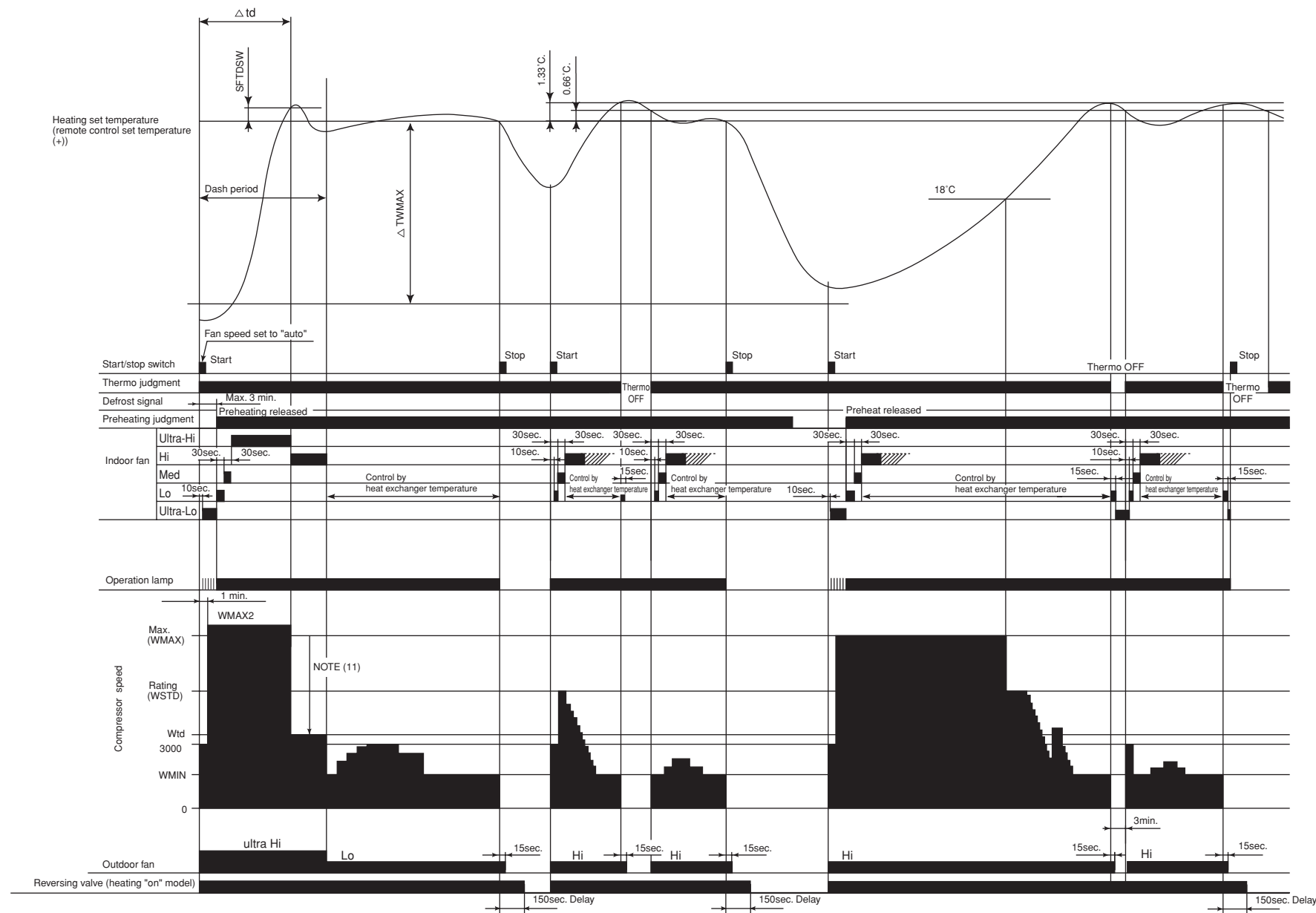

**Notes:**

- (1) Condition for entering into Hot Dashed mode. When fan set to "Hi" or "Auto mode" and i) Indoor temperature is lower than 18°C, and ii) outdoor temperature is lower than 10°C, and iii) Temperature difference between indoor temperature and set temperature has a corresponding compressor rpm (calculated value in Table 3) larger than WMAX.
- (2) Hot Dashed will release when i) Room temperature has achieved the set temperature + SFTDSW. ii) Thermo off.
- (3) During Hot Dashed operation, thermo off temperature is set temperature (with shift value) +3°C. After thermo off, operation continue in Fuzzy control mode.
- (4) Compressor minimum "ON" time and "OFF" time is 3 minutes.
- (5) During normal heating mode, compressor maximum rpm WMAX will maintain for 120 minutes if indoor temperature is higher than 18°C. No time limit constrain if indoor temperature is lower than 18°C and outdoor temperature is lower than 2°C.
- (6) During Hotkeep or Defrost mode, indoor operation lamp will blink at interval of 3 seconds "ON" and 0.5 second "OFF".
- (7) When heating mode starts, it will enter into Hotkeep mode if indoor heat exchanger temperature is lower than YNEOF + 0.33°C.
- (8) When fan is set to "Med" or "Lo", compressor rpm will be limited to WBEMAX.
- (9) In "Ultra-Lo" fan mode, if indoor temperature is lower than 18°C, indoor fan will stop. If indoor temperature is higher than 18°C + 0.33°C, fan will continue in "Ultra-Lo" mode. During Hotkeep or Defrost mode, fan will continue in "Ultra-Lo" mode.
- (10) During Hot Dashed or outdoor temperature is lower than -5°C, compressor rpm is WMAX2.
- (11) During Hot Dashed, when room temperature reaches set temperature + SFTDSW compressor rpm is actual rpm x DWNRATEW.

Table 3 ΔTWMAX

Temperature difference	Calculated compressor rpm
1.66	1965 min <sup>-1</sup>
2	2135 min <sup>-1</sup>
2.33	2300 min <sup>-1</sup>
2.66	2465 min <sup>-1</sup>
3	2635 min <sup>-1</sup>
3.33	2800 min <sup>-1</sup>
3.66	2965 min <sup>-1</sup>
4	3135 min <sup>-1</sup>
4.33	3300 min <sup>-1</sup>
4.66	3465 min <sup>-1</sup>
5	3635 min <sup>-1</sup>
5.33	3800 min <sup>-1</sup>
5.66	3965 min <sup>-1</sup>
6	4135 min <sup>-1</sup>
6.33	4300 min <sup>-1</sup>
6.66	4465 min <sup>-1</sup>
7	4635 min <sup>-1</sup>
7.33	4800 min <sup>-1</sup>
7.66	4965 min <sup>-1</sup>
8	5135 min <sup>-1</sup>
8.33	5300 min <sup>-1</sup>
8.66	5465 min <sup>-1</sup>
9	5635 min <sup>-1</sup>
9.33	5800 min <sup>-1</sup>
9.66	5965 min <sup>-1</sup>
10	6135 min <sup>-1</sup>
10.33	6300 min <sup>-1</sup>
10.66	6465 min <sup>-1</sup>
11	6635 min <sup>-1</sup>

**Notes:**

1. See the data in Table 1 on page 47 for each constant in capital letters in the diagrams.

## Reversing Valve Defrosting

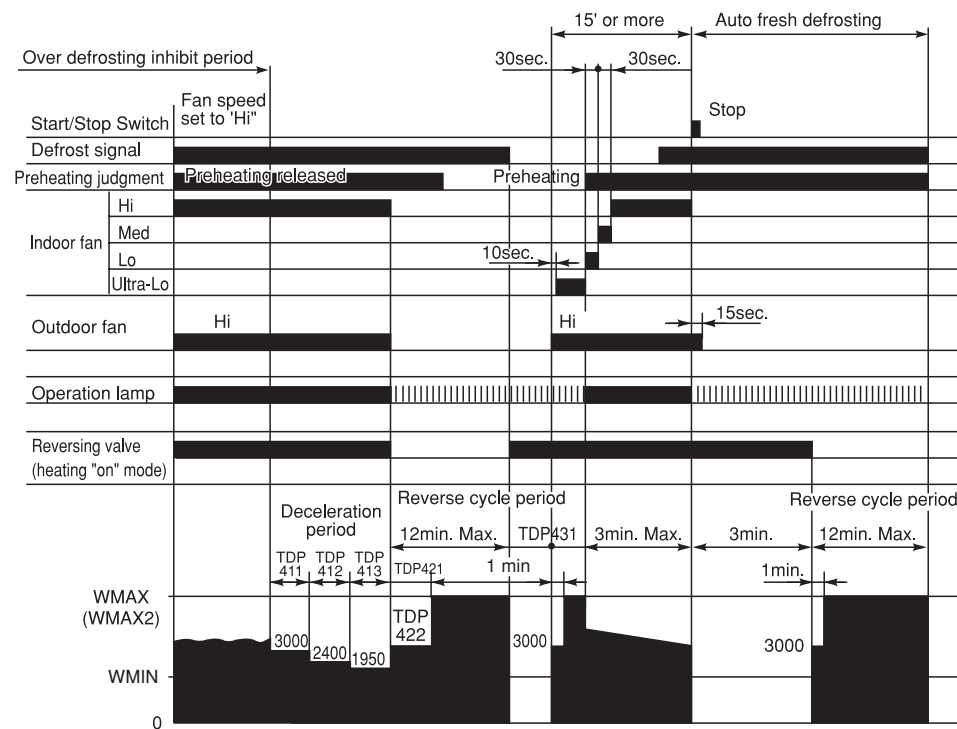

### Notes:

- (1) The defrosting inhibit period is set as shown in the diagram below. When defrosting has finished once, the inhibit period is newly set, based on the outdoor temperature when the compressor was started. During this period, the defrost signal is not accepted.
- (2) If the difference between the room and outdoor temperature is large when defrosting is finished, the maximum compressor speed (WMAX) or (WMAX2) can be continued for 120 minutes maximum.
- (3) The defrosting period is 12 minutes maximum.
- (4) When operation is stopped during defrosting, it is switched to auto refresh defrosting.
- (5) Auto refresh defrosting cannot be engaged within 15 minutes after operation is started or defrosting is finished.

## Setting Defrosting Inhibit Period

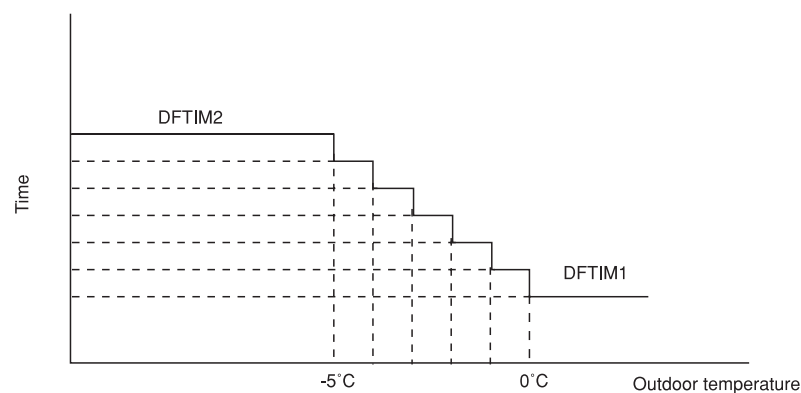

### Notes:

- (1) The time is set according to the outdoor temperature when it is between 0°C and -5°C.
- (2) DFTIM1 is used when the outdoor temperature  $\geq 0^\circ\text{C}$ .
- (3) DFTIM2 is used when the outdoor temperature  $\leq -5^\circ\text{C}$ .

## Heating Sleep Operation

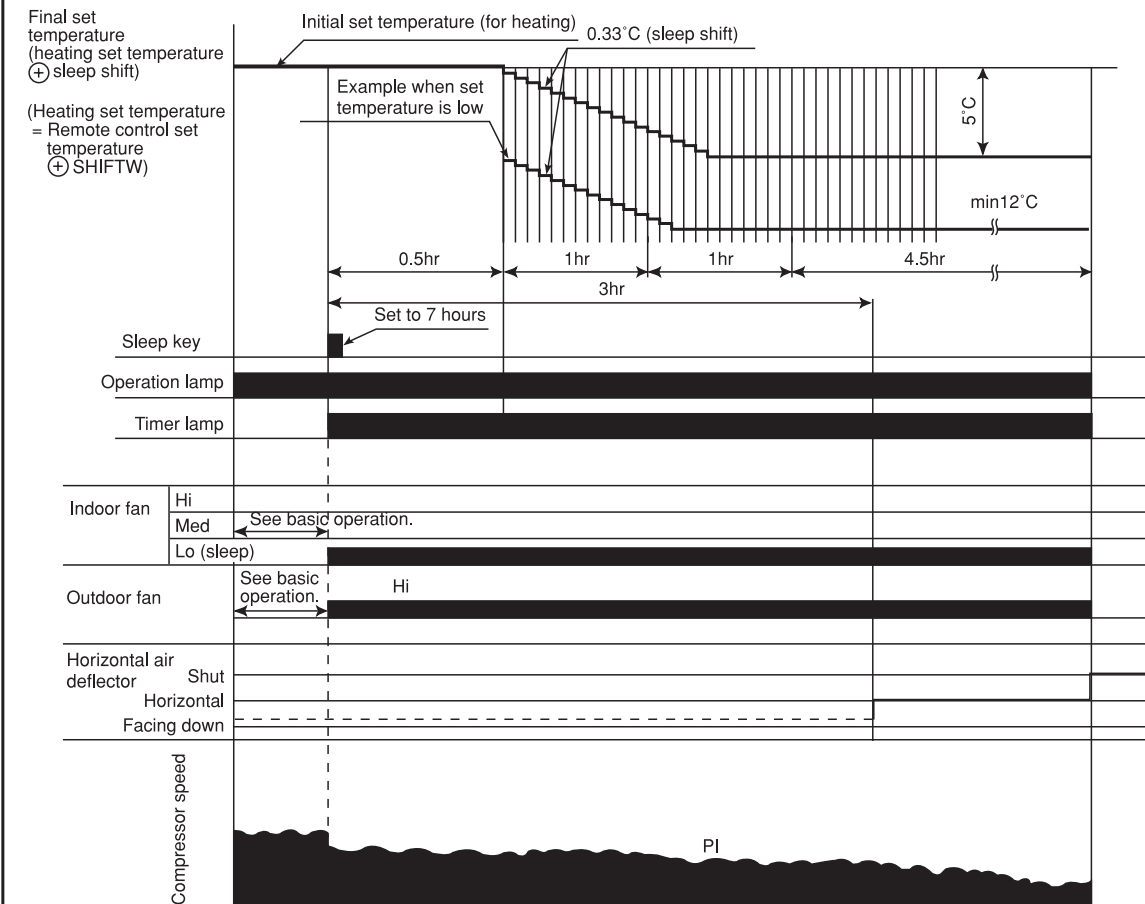

### Notes:

- (1) The sleep operation starts when the sleep key is pressed.
- (2) When the sleep key is set, the maximum compressor speed is limited to WSTD+2000/2, and the indoor fan is set to "sleep Lo".
- (3) 30 minutes after the sleep key is set, the sleep shift of set temperature starts.
- (4) The maximum sleep shift of set temperature is 5°C, and the minimum is 12°C.
- (5) If the operation mode is changed during sleep operation, the changed operation mode is set and sleep control starts.
- (6) The indoor fan speed does not change even when the fan speed mode is changed. (Lo)
- (7) When defrosting is to be set during sleep operation, defrosting is engaged and sleep operation is restored after defrosting.
- (8) When operation is stopped during sleep operation, the set temperature when stopped, as well as the time, continue to be counted.
- (9) If the set time is changed during sleep operation, all data including set temperature, time, etc. is cleared and restarted.
- (10) If sleep operation is canceled by the cancel key or sleep key, all data is cleared.

# REFRIGERATING CYCLE DIAGRAM

MODEL RAS-60YH5 / RAC-60YH5

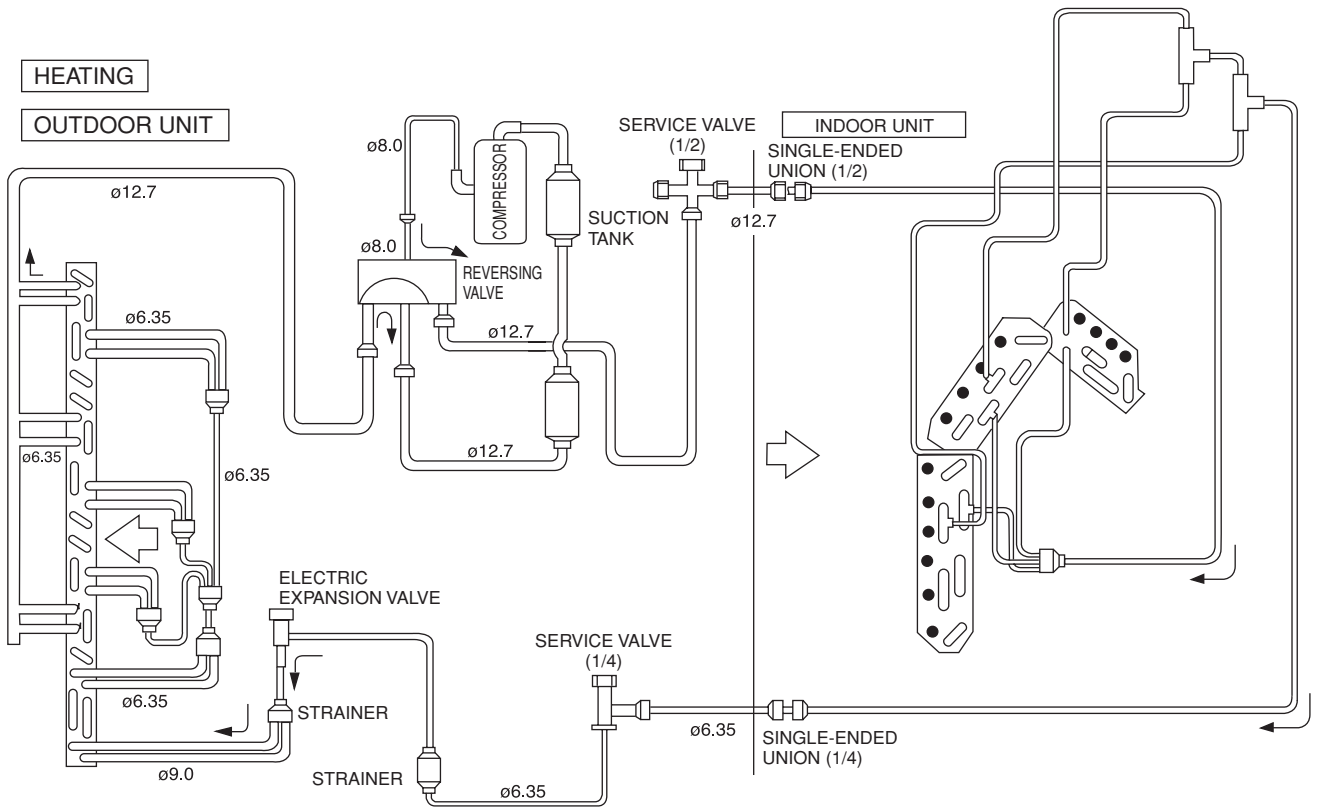
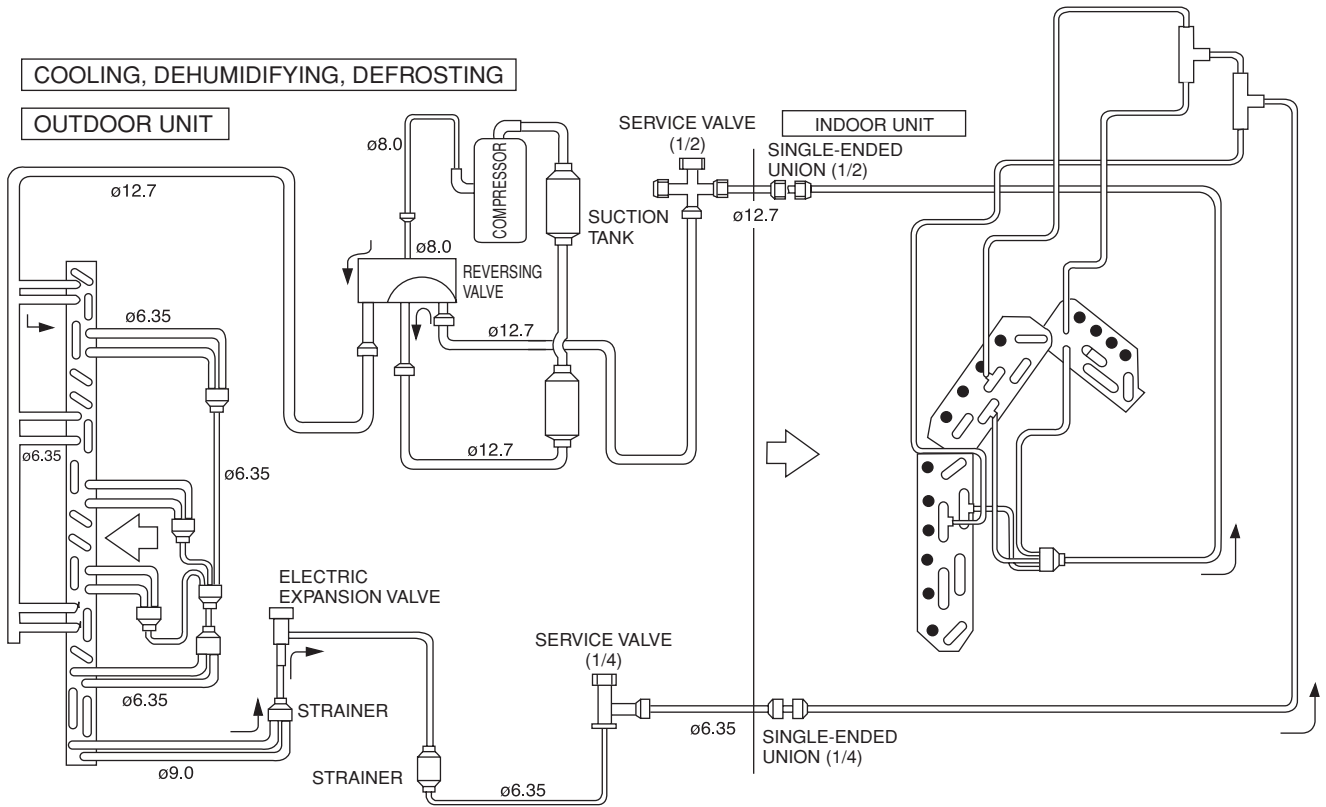

## AUTO SWING FUNCTION

INPUT SIGNAL	OPERATION	PRESENT CONDITION		OPERATING SPECIFICATION	REFERENCE
		OPERATION MODE	AIR DEFLECTOR		
KEY INPUT	STOP	EACH MODE	STOP	ONE SWING (CLOSING AIR DEFLECTOR) ① DOWNWARD ② UPWARD	INITIALIZE AT NEXT OPERATION.
	DURING OPERATION	AUTO COOL COOL FAN AUTO DRY DRY	DURING ONE SWING	STOP AT THE MOMENT.	
THERMO. ON (INTERNAL FAN ON)	DURING OPERATION	AUTO HEAT HEAT CIRCULATOR	STOP	START SWINGING ① DOWNWARD ② UPWARD ③ DOWNWARD	
			DURING SWINGING	STOP AT THE MOMENT.	
THERMO. ON (INTERNAL FAN OFF)	DURING OPERATION	AUTO DRY DRY AUTO HAET HEAT CIRCULATOR	TEMPORARY STOP	START SWING AGAIN.	
			DURING SWINGING	STOP SWINGING TEMPORARILY. (SWING MODE IS CLEARED IF SWING COMMAND IS TRANSMITTED DURING TEMPORARY STOP.)	
MAIN SWITCH ON	STOP	COOL FAN DRY	STOP DURING ONE SWING	INITIALIZE ① DOWNWARD ② UPWARD	
		HEAT CIRCULATOR	STOP DURING ONE SWING	INITIALIZE ① DOWNWARD	
MAIN SWITCH OFF	DURING OPERATION	EACH MODE	STOP DURING SWINGING	ONE SWING (CLOSING AIR DEFLECTOR) ① DOWNWARD ② UPWARD	INITIALIZE AT NEXT OPERATION.
			DURING INITIALIZING	INITIALIZING CONDITION OF EACH MODE.	
CHANGE OF OPERATION	DURING OPERATION	EACH MODE	STOP	STOP SWINGING AND MODE BECOMES INITIALIZING CONDITION.	
			DURING SWINGING		



# DESCRIPTION OF MAIN CIRCUIT OPERATION

## 1. Reset Circuit

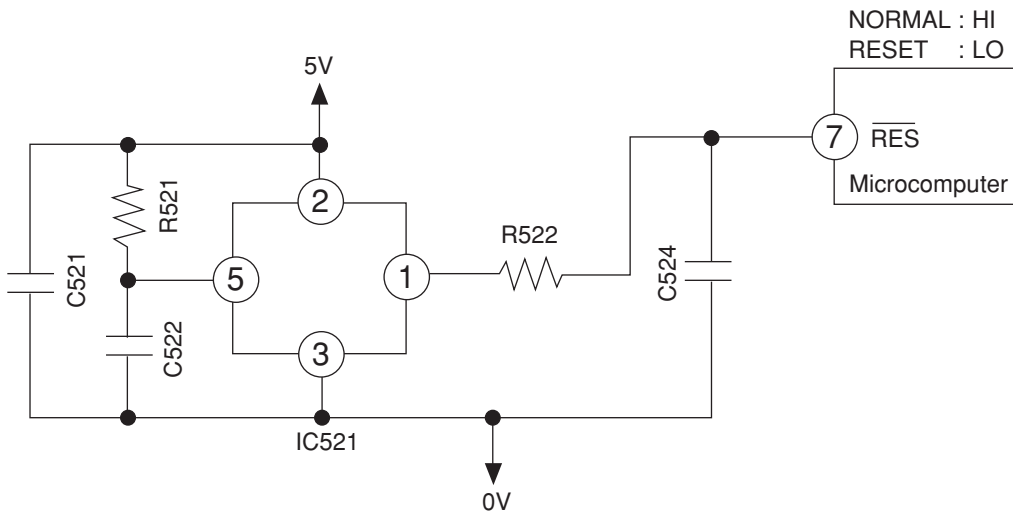

Fig. 1-1

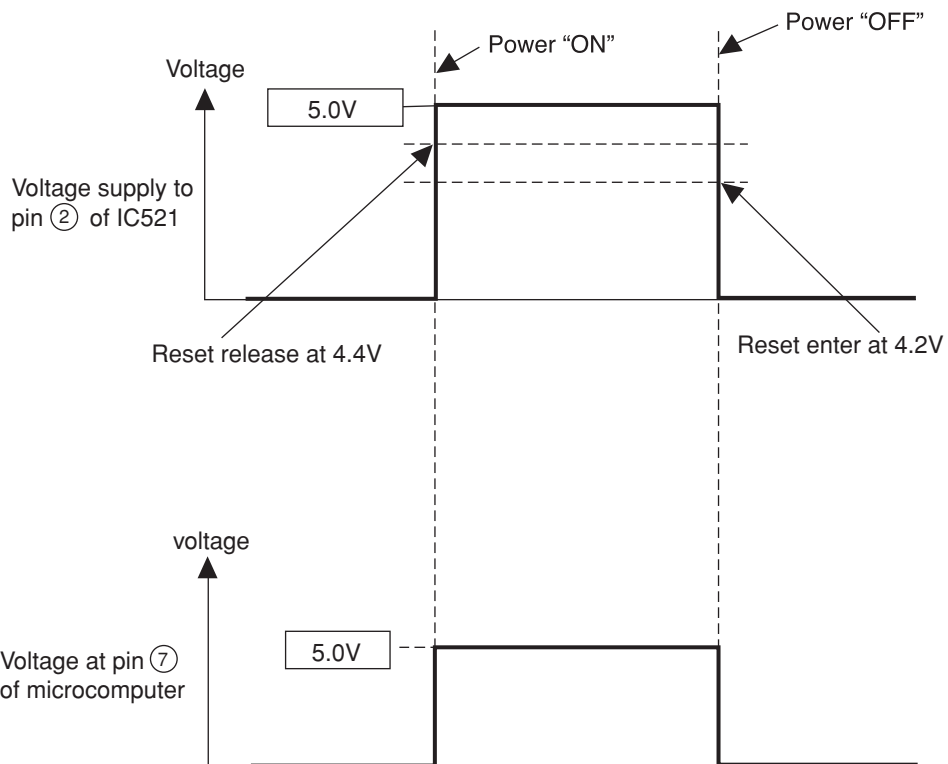

Fig. 1-2

- The reset circuit initializes the microcomputer program when power is ON or OFF.
- Low voltage at pin ⑦ resets the microcomputer and Hi activates the microcomputer.
- When power "ON" 5V voltage rises and reaches 4.4V, pin ① of IC521 is set to "Hi". At this time the microcomputer starts operation.
- When power "OFF" voltage drops and reaches 4.2V, pin ① of IC521 is set to "Low". This will RESET the microcomputer.

## 2. Receiver Circuit

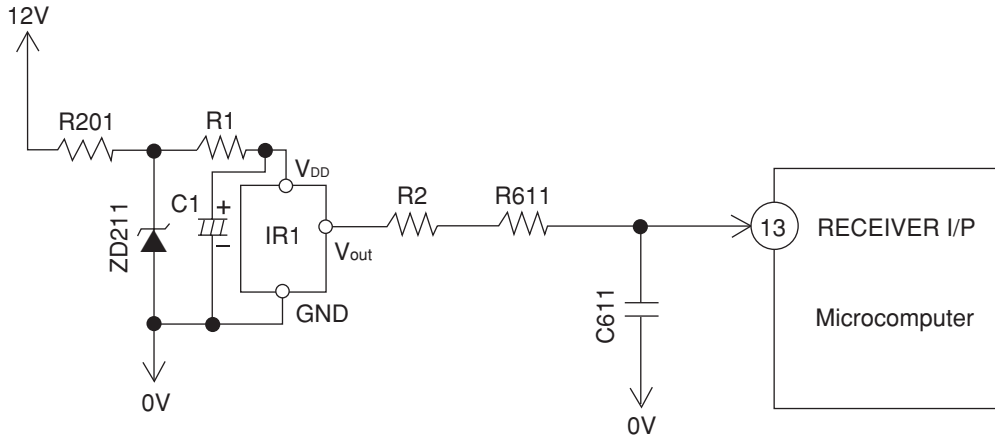

Fig. 2-1

- The light receiver unit receives the infrared signal from the wireless remote control. The receiver amplifies and shapes the signal and outputs it.

## 3. Buzzer Circuit

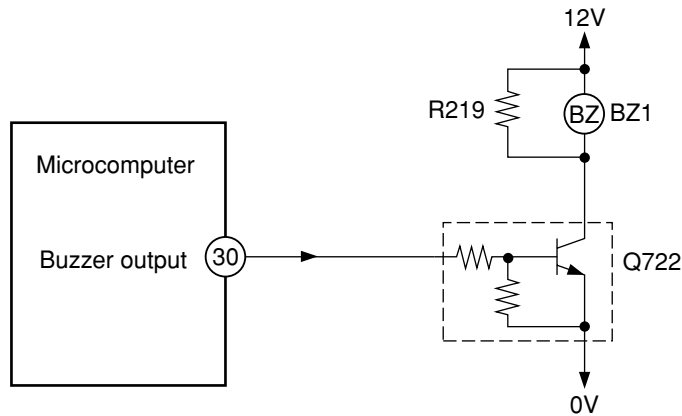

Fig. 3-1 Buzzer Circuit

- When the buzzer sounds, an approx. 3.9kHz square signal is output from buzzer output pin (30) of the microcomputer. After the amplitude of this signal has been set to 12Vp-p by a transistor, it is applied to the buzzer. The piezoelectric element in the buzzer oscillates to generate the buzzer's sound.

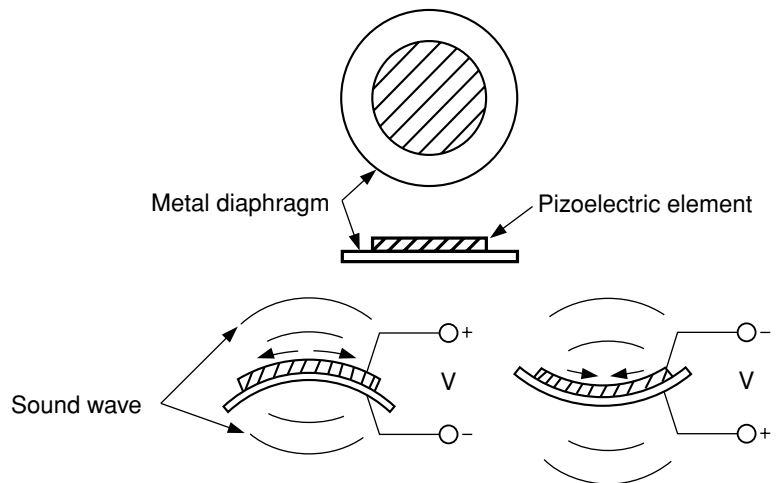

Fig. 3-2 Buzzer Operation

#### 4. Auto Sweep Motor Circuit

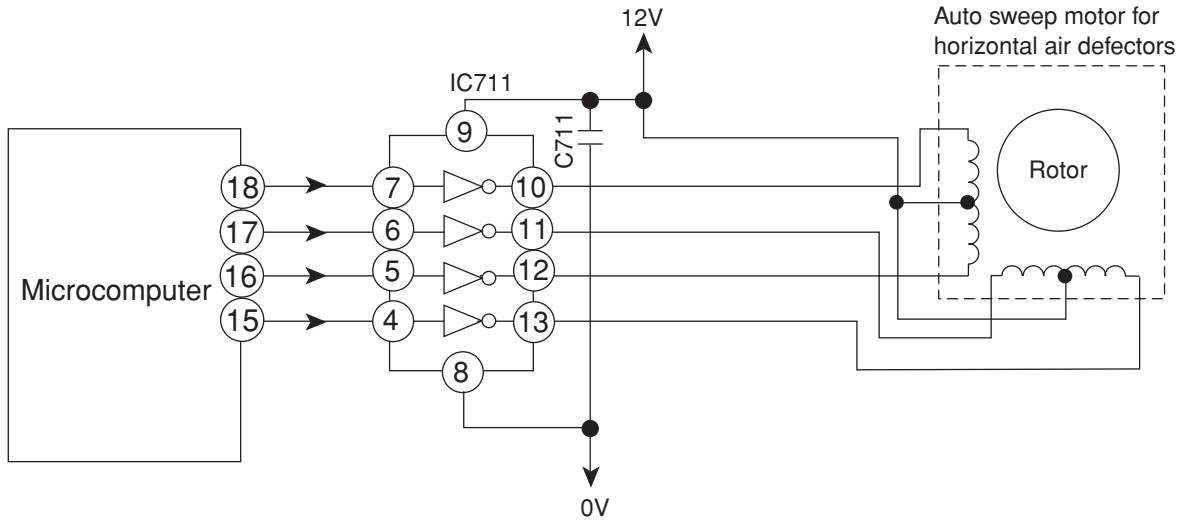

Fig.4-1

- Fig. 4-1 shows the Auto sweep motor drive circuit; the signals shown in Fig.4-2 are output from pins ⑮ – ⑱ of microcomputer.

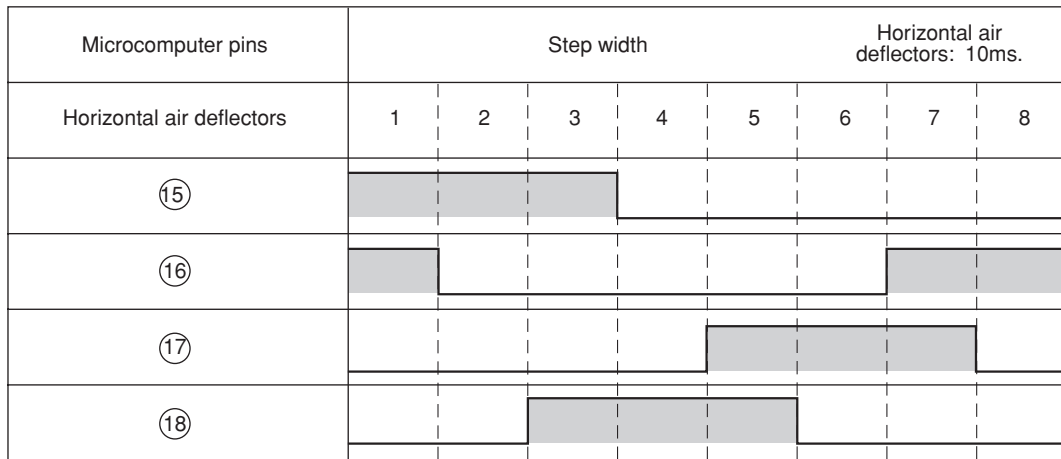

Fig.4-2 Microcomputer Output Signals

- As the microcomputer's outputs change as shown in Fig.4-2, the core of the auto sweep motor is excited to turn the rotor. Table 4-1 shows the rotation angle of horizontal air deflectors.

Table 4-1 Auto sweep Motor Rotation

	Rotation angle per step (°)	Time per step (ms.)
Horizontal air deflectors	0.0882	10

## 5. Room Temperature Thermistor Circuit

- Fig. 5-1 shows the room temperature thermistor circuit.

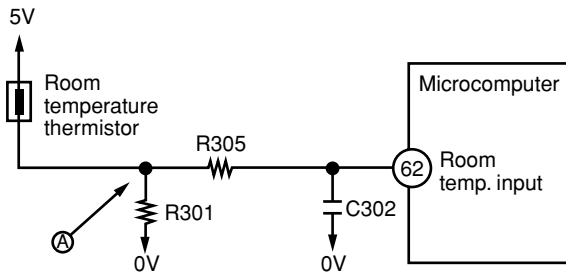

Fig. 5-1

- The voltage at Ⓐ depends on the room temperature as shown in Fig. 5-2.

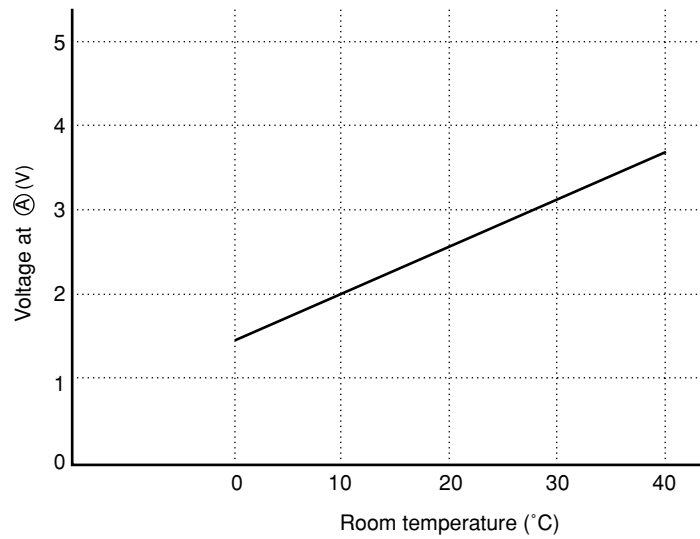

Fig. 5-2

## 6. Heat exchanger temperature thermistor circuit

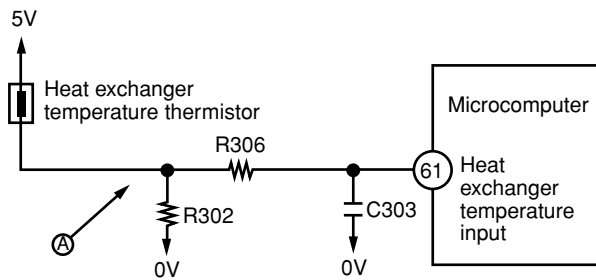

Fig. 6-1

- The circuit detects the indoor heat exchanger temperature and controls the following.

- (1) Preheating.
- (2) Low-temperature defrosting during cooling and dehumidifying operation.
- (3) Detection of the reversing valve non-operation or heat exchanger temperature thermistor open.

The voltage at Ⓐ depends on the heat exchanger temperature as shown in Fig. 6-2.

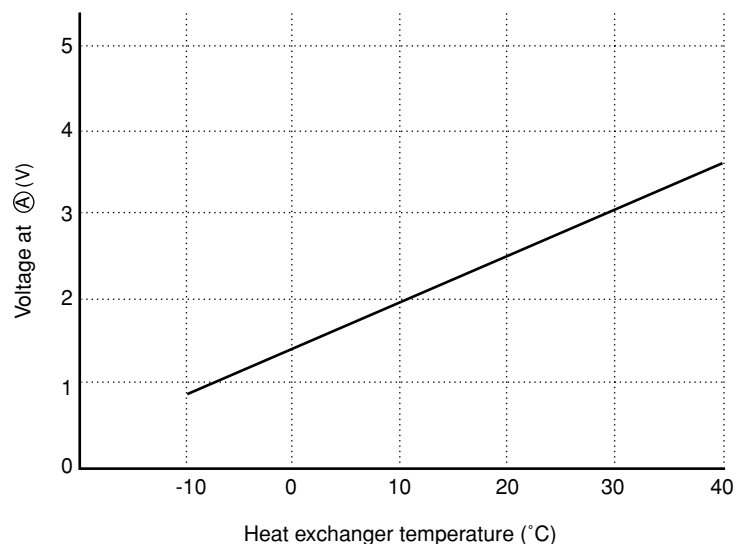

Fig. 6-2

## 7. Initial Setting Circuit (IC401)

- When power is supplied, the microcomputer reads the data in IC401 or IC402 (E<sup>2</sup>PROM) and sets the preheating activation value and the rating and maximum speed of the compressor, etc. to their initial values.
- Data of self-diagnosis mode is stored in IC401 or IC402; data will not be erased even when power is turned off.

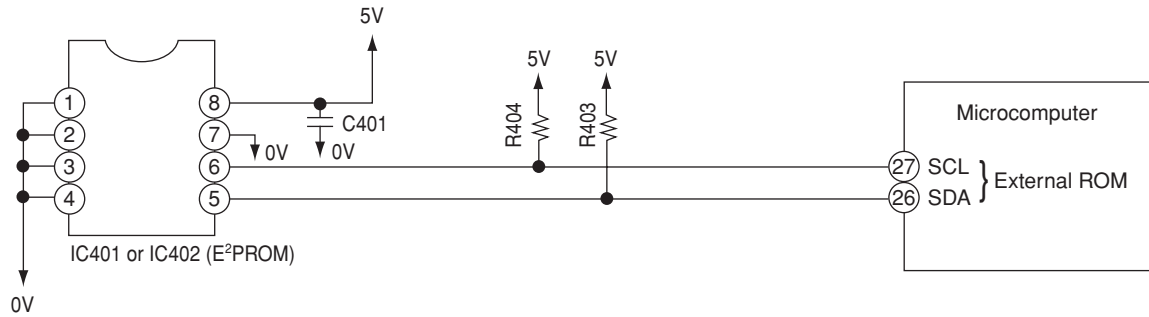

Fig. 7-1

# 1. Power Circuit

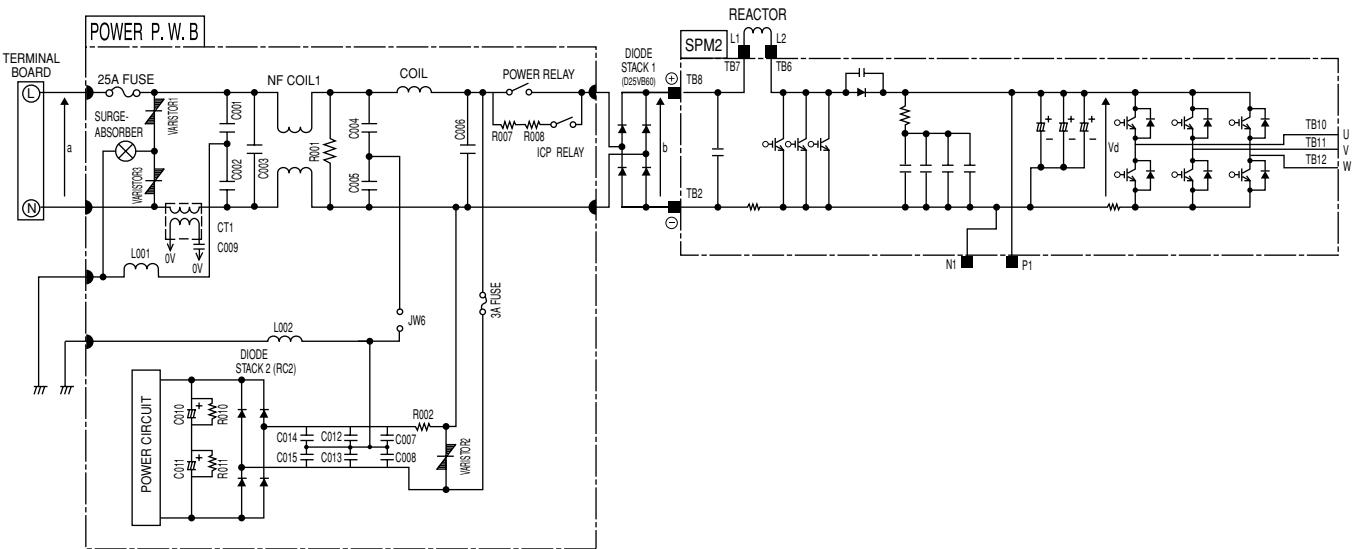

Fig. 1-1

- This circuit full-wave rectifies 220-240V AC applied between terminals L and N, and boosts it to a required voltage with the active module, to create a DC voltage.

The voltage becomes 260-360V when the compressor is operated

(1) Active module

The active filter, consisting of a reactor and switching element, eliminates higher harmonic components contained in the current generated when the compressor is operated, and improves the power-factor.

(2) Diode stacks

These rectify the 220-240V AC from terminals L and N to a DC power supply.

< Reference >

- In case of malfunction or defective connection: Immediately after the compressor starts, it may stop due to “abnormally low speed” active error, etc.

The compressor may continue to operate normally, but the power-factor will decrease, the operation current will increase, and the overcurrent breaker of the household power board will probably activate.

- In case of active module faulty or defective connection:

Although the compressor continues to operate normally, the power-factor will decrease, the operation current will increase, and the overcurrent breaker of the household power board will probably activate.

< Reference >

- If diode stack 1 is faulty, the compressor may stop due to “lp”, “anbormally low speed”, etc. immediately after it starts, or it may not operate at all because no DC voltage is generated between the positive ⊕ and negative ⊖ terminals.

If diode stack 1 is faulty, be aware that the 25A fuse might also have blown.

- If diode stack 2 is faulty, DC voltage may not be generated and the compressor may not operate at all. Also, be aware that the 3A fuse might have blown.

(3) Smoothing capacitor (C501, C502, C503)

This smoothes (averages) the voltage rectified by the diode stacks.

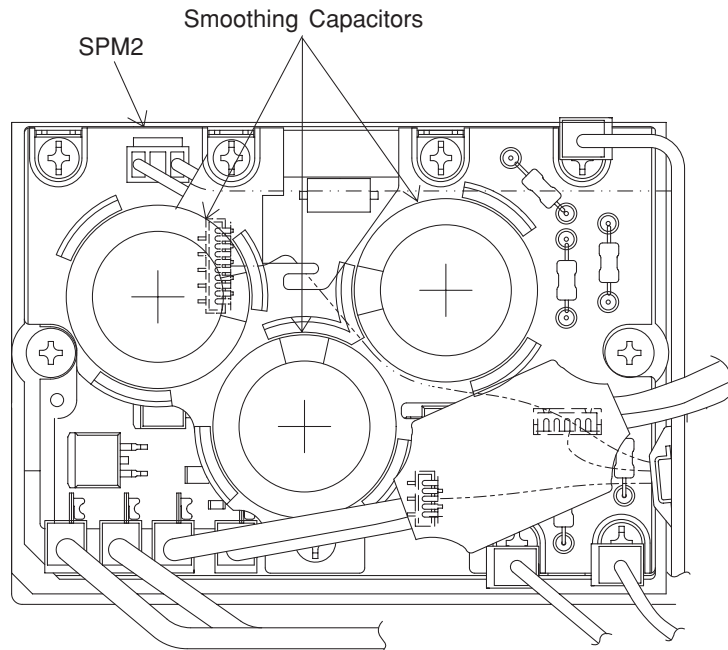

Fig. 1-2

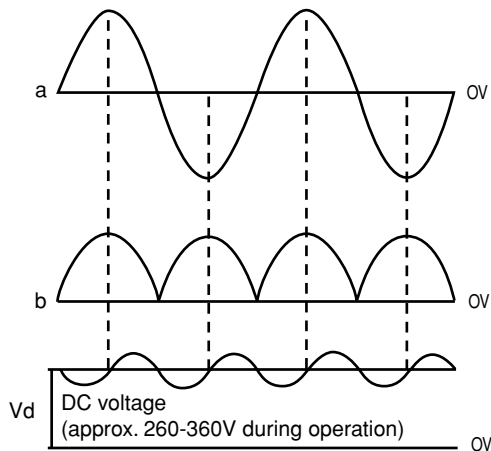

Fig. 1-3

- Be careful to avoid an electric shock as a high voltage is generated. Also take care not to cause a short-circuit through incorrect connection of test equipment terminals. The circuit board could be damaged.

(4) Smoothing capacitor (C010, C011)

This smoothes (averages) the voltage rectified by the diode stack2. A DC voltage is generated in the same way as in Fig. 1-3.

Voltage between + side of C010 and – side of C011 is about 330V.

(5) C001 to C003, C012 to C015, C007, C008, NF COIL1, COIL, absorb electrical noise generated during operation of compressor, and also absorb external noise entering from power line to protect electronic parts.

(6) Surge absorber, Varistor 1, 2, 3, absorbs external power surge.

(7) Inrush protective resistor (R007, R008)

This works to protect from overcurrent when power is turned on.

< Reference >

- When inrush protective resistor is defective, diode stack may malfunction. As a result, DC voltage is not generated and no operation can be done.

## 2. Indoor/Outdoor Interface Circuit

- The interface circuit superimposes an interface signal on the DC 35V line supplied from the outdoor unit to perform communications between indoor and outdoor units. This circuit consists of a transmitting circuit which superimposes an interface signal transmit from the microcomputer on the DC 35V line and a transmitting circuit which detects the interface signal on the DC 35V line and outputs it to the microcomputer.
- Communications are performed by mutually transmitting and receiving the 4-frame outdoor request signal one frame of which consists of a leader of approx. 100 ms., start bit, 8-bit data and stop bit and the command signal with the same format transmit from the indoor unit.
- Communication signal from outdoor microcomputer to indoor microcomputer. At first outdoor microcomputer will send a request signal (SDO) to indoor microcomputer. A high-frequency IF signal approx. 38 KHz is generated and modulated by the request signal (SDO) inside the outdoor microcomputer then output to pin (11) of microcomputer. This modulated IF signal is output to pin (30) of HIC and amplified by amp. This signal is superimposed to DC 35V line via C801 and L801.  
To prevent erroneous reception, the outdoor microcomputer is designed so that it cannot receive a signal while it is outputting a request signal.  
The receiving circuit in the indoor unit consists of a comparator and transistor. The interface signal from the outdoor unit on the DC 35V line is supplied to C821, where DC components are eliminated, and is then shaped by the comparator. The shaped signal is detected by diode, amplified by amp, and output to pin (49) of the indoor microcomputer.  
Fig. 2-2 shows the voltages at each component when data is transferred from the outdoor microcomputer to the indoor microcomputer.
- Communication signal from indoor microcomputer to outdoor microcomputer. The request signal (SDO) generates by indoor microcomputer is output to pin (50), and amplifies by C801. IF signal approx. 38 kHz is generated by comparator, then modulate by the request signal from pin (50) of indoor microprocessor. This modulated IF signal is then amplified and superimposed to DC 35V line via L801 and C802 of indoor interface circuit.  
Fig. 2-3 shows the voltages at each component when data is transferred from outdoor microcomputer to indoor microcomputer.  
The circuit operation of the outdoor receiving circuit is same as indoor receiving circuit.



- Fig. 2-1 shows the interface circuit used for the indoor and outdoor microcomputers to communicate with each other.

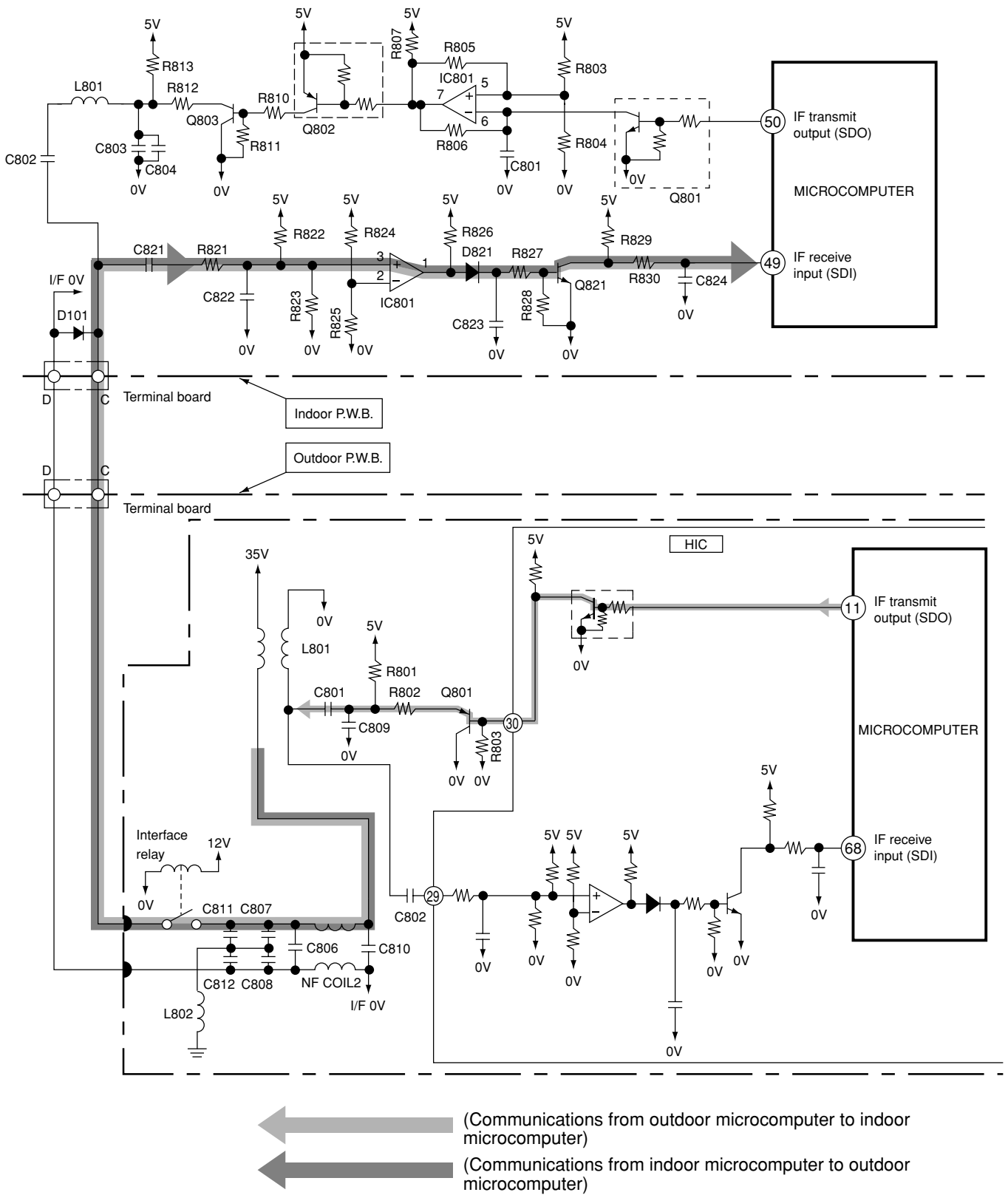

Fig. 2-1 Indoor/outdoor interface Circuit

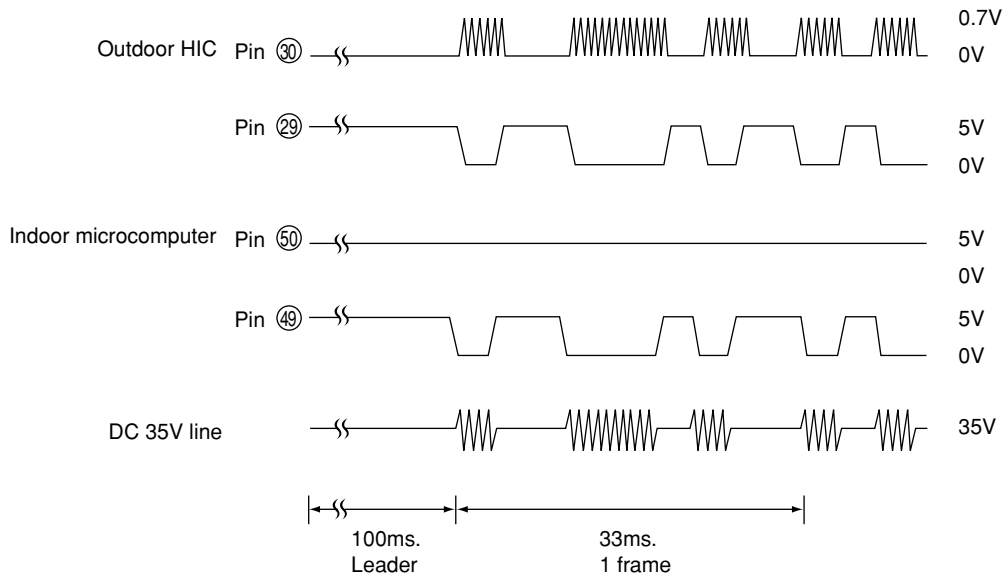

Fig. 2-2 Voltages Waveforms of indoor / Outdoor Microcomputers (Outdoor to Indoor Communications)

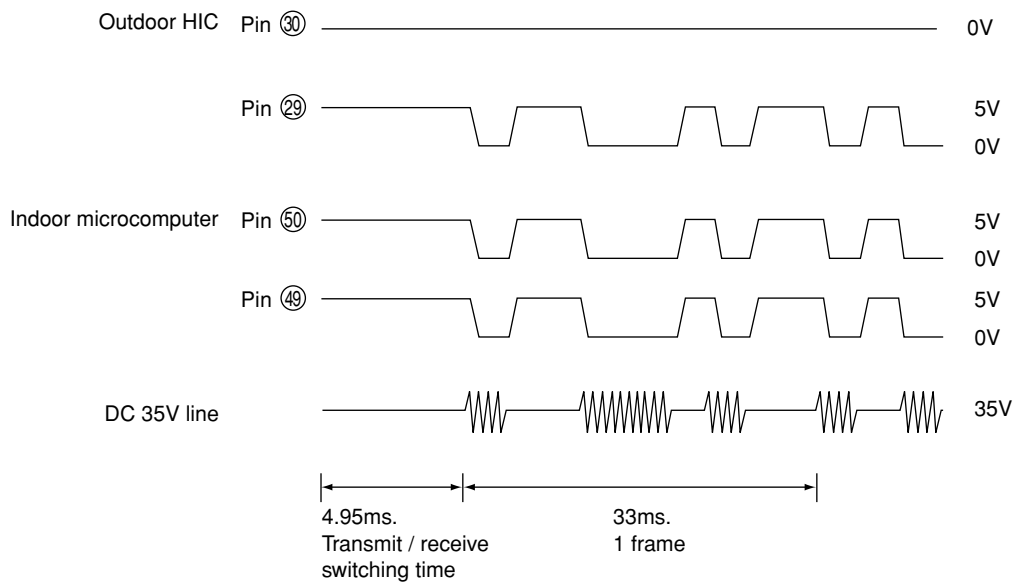
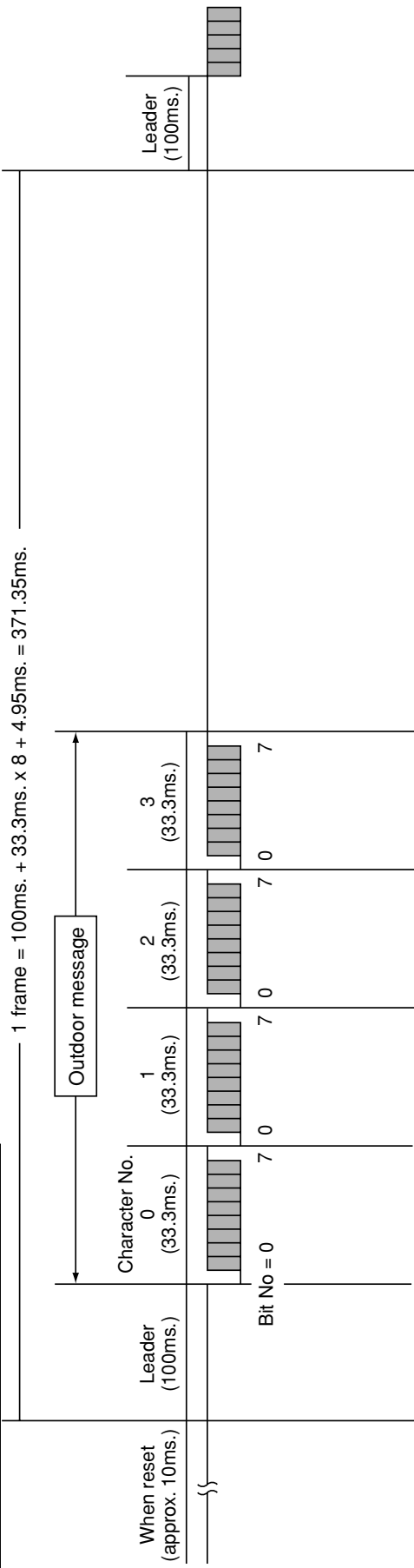

Fig. 2-3 Voltages Waveforms of indoor / Outdoor Microcomputers (Indoor to Outdoor Communications)

[Serial Communications Format during Normal Communications]

(1) Outdoor microcomputer (HIC) to indoor microcomputer



(2) Indoor microcomputer to outdoor microcomputer (HIC)

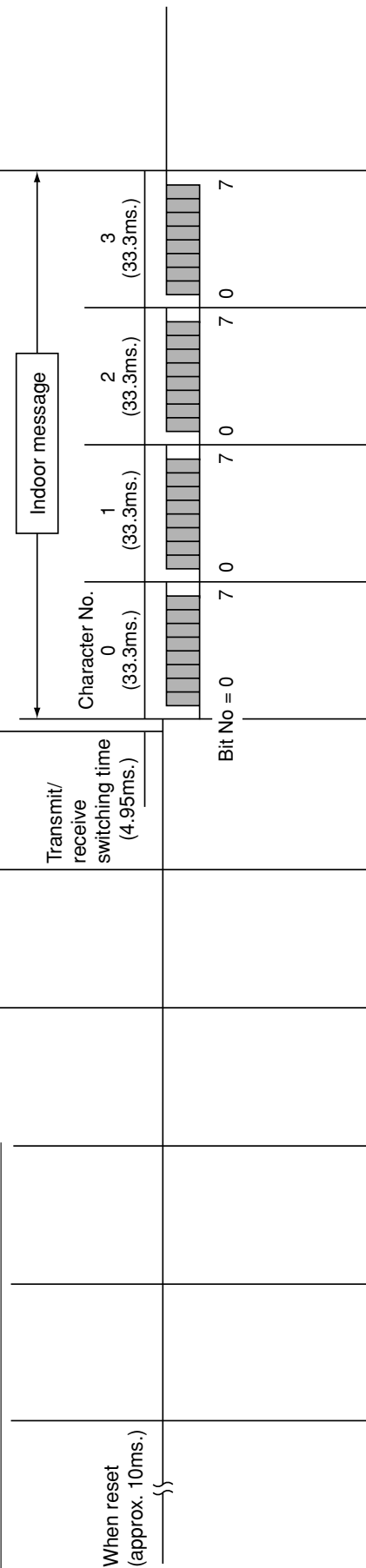

(3) Communications waveforms

[Example] When the outdoor message is all 0s and indoor message is all 1s:

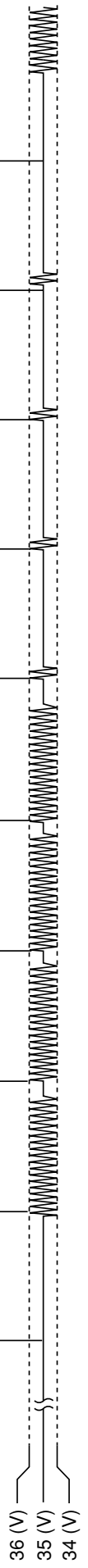

Fig. 2-4

[ Serial Communications Data ]

(1) Outdoor message

Character No.	0								1							2							3									
Bit No.	7	6	5	4	3	2	1	0	7	6	5	4	3	2	1	0	7	6	5	4	3	2	1	0	7	6	5	4	3	2	1	0
Contents																																
Data	1/0	0	1/0	1/0	1/0	1/0	1/0	1/0	1/0	1/0	1/0	1/0	1/0	1/0	1/0	1/0	1/0	1/0	1/0	1/0	1/0	1/0	1/0	1/0	1/0	1/0	1/0	1/0	1/0	1/0	1/0	1/0
0	Multi-bit																															
1																																
2	During forced operation																															
3	Defrost request signal																															
4	Self-diagnosis (0 LSB)																															
5	Self-diagnosis (1)																															
6	Self-diagnosis (2)																															
7	Self-diagnosis (3 MSB)																															
0	Outside temperature (0 LSB)																															
1	Outside temperature (1)																															
2	Outside temperature (2)																															
3	Outside temperature (3)																															
4	Outside temperature (4)																															
5	Outside temperature (5)																															
6	Outside temperature (6)																															
7	Outside temperature (7 MSB)																															
0	Compressor during operation																															
1	Compressor during operation																															
2	Actual compressor rotation speed (0 LSB)																															
3	Actual compressor rotation speed (1)																															
4	Actual compressor rotation speed (2)																															
5	Actual compressor rotation speed (3)																															
6	Actual compressor rotation speed (4)																															
7	Actual compressor rotation speed (5 MSB)																															
0																																
1	Fan-7-step request																															
2																																
3																																
4																																
5																																
6																																
7																																

(2) Indoor message

Character No.	0								1							2							3									
Bit No.	7	6	5	4	3	2	1	0	7	6	5	4	3	2	1	0	7	6	5	4	3	2	1	0	7	6	5	4	3	2	1	0
Contents																																
Data	1/0	1/0	1/0	1/0	1/0	1/0	1/0	1/0	1/0	1/0	1/0	1/0	1/0	1/0	1/0	1/0	1/0	1/0	1/0	1/0	1/0	1/0	1/0	1/0	1/0	1/0	1/0	1/0	1/0	1/0	1/0	1/0
0	Operation mode (0 LSB)																															
1	Operation mode (1)																															
2	Operation mode (2 MSB)																															
3	Indoor in-operation bit																															
4	Capacity code (0 LSB)																															
5	Capacity code (1)																															
6	Capacity code (2)																															
7	Capacity code (3 MSB)																															
0	Fan (0 LSB)																															
1	Fan (1)																															
2	Fan (2 MSB)																															
3	2-way valve																															
4	Reversing valve																															
5																																
6																																
7	Compressor ON																															
0	Compressor command speed (0 LSB)																															
1	Compressor command speed (1)																															
2	Compressor command speed (2)																															
3	Compressor command speed (3)																															
4	Compressor command speed (4)																															
5	Compressor command speed (5)																															
6	Compressor command speed (6)																															
7	Compressor command speed (7 MSB)																															
0	15/20(A)																															
1	OVL up																															
2																																
3	Compressor minimum rotation speed (0 LSB)																															
4	Compressor minimum rotation speed (1)																															
5	Compressor minimum rotation speed (2)																															
6	Compressor minimum rotation speed (3)																															
7	Compressor minimum rotation speed (4 MSB)																															

### 3. Power Module Circuit

- Fig. 3-1 shows the system power module and its peripheral circuit. The three transistors on the positive ⊕ side are called the upper arm, and the three transistors on the negative ⊖ side are called the lower arm.

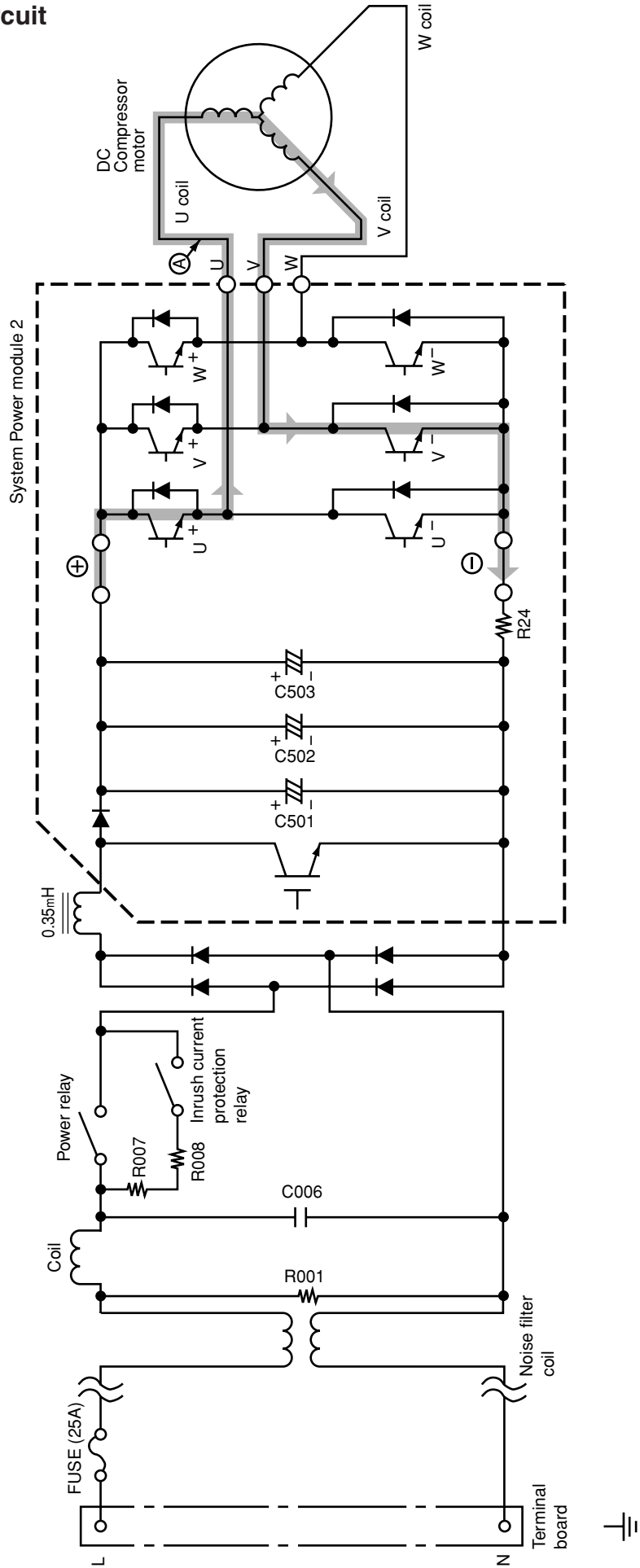

Fig. 3-1 Power module circuit (U<sup>+</sup> is ON, V<sup>-</sup> is ON)

- DC 260-360V is input to system power module and system power module switches power supply current according to rotation position of magnet rotor. The switching order is as shown in Fig. 3-2.

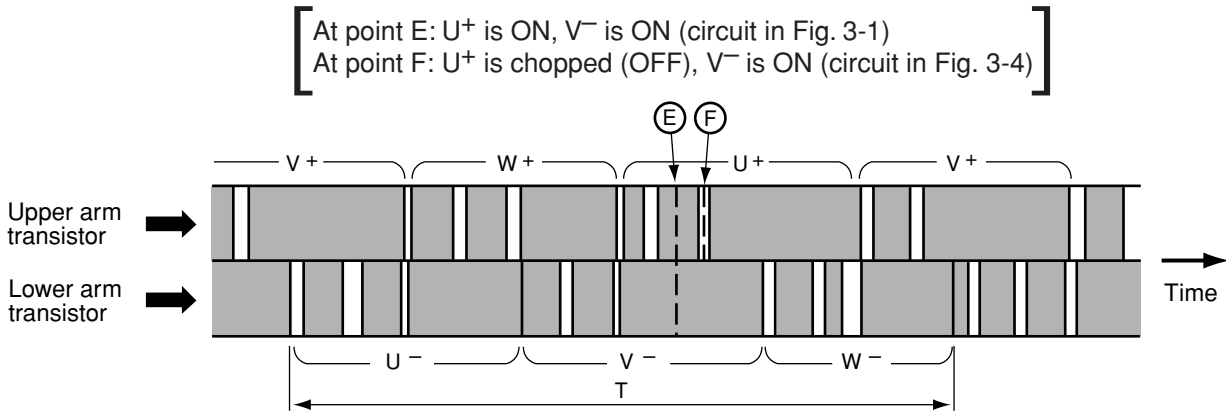

Fig. 3-2 Switching order of power module

- Upper arm transistor is controlled to ON/OFF by 3.3kHz chopper signal. Rotation speed of the compress is proportional to duty ratio (ON time/ ON time + OFF time) of this chopper signal.
- Time T in Fig. 3-2 shows the switching period, and relation with rotation speed (N) of the compressor is shown by formula below;

$$N = 60/2 \times 1/T$$

- Fig. 3-3 shows voltage waveform at each point shown in Figs. 3-1 and 3-4. First half of upper arm is chopper, second half is ON, and first half of lower arm is chopper, second half is ON.

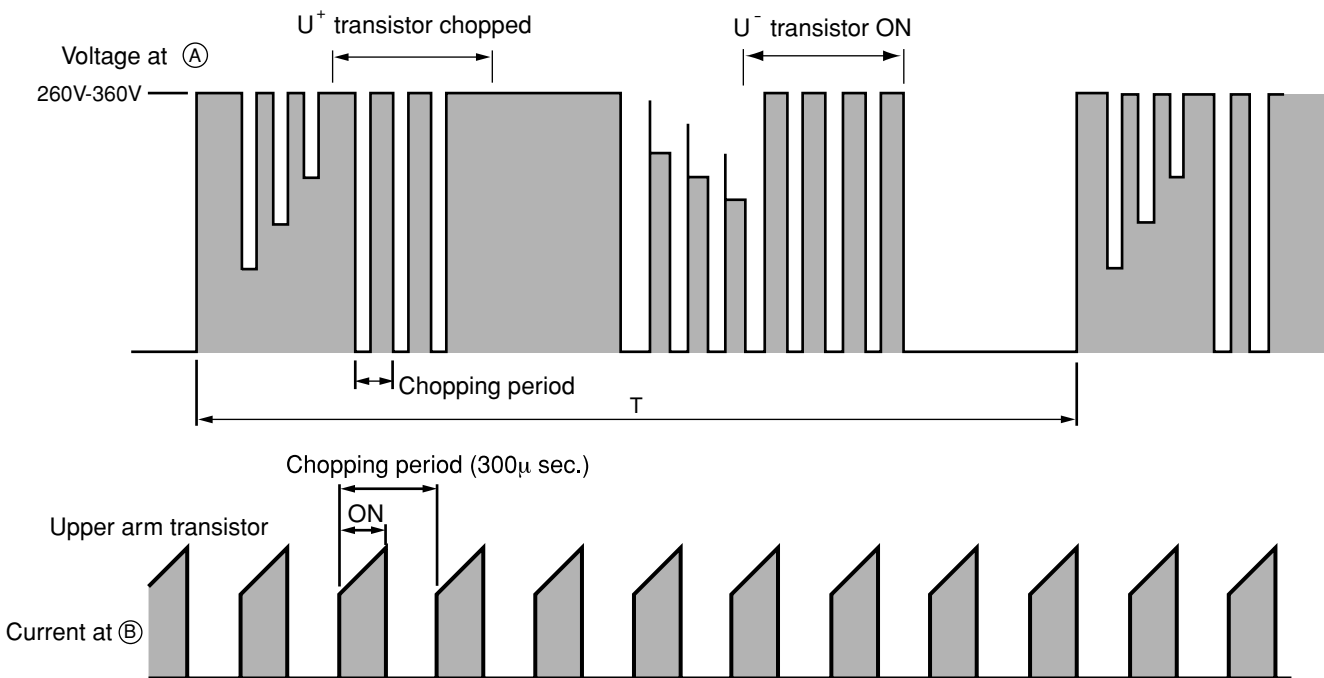

Fig. 3-3 Voltage waveform at each point

- When power is supplied U<sup>+</sup> → U<sup>-</sup>, because of that U<sup>+</sup> is chopped, current flows as shown below; (B)
  - (1) When U<sup>+</sup> transistor is ON: U<sup>+</sup> transistor → U coil → V coil → V<sup>-</sup> transistor → DC current detection resistor → Point (B) (Fig. 3-1)
  - (2) When U<sup>+</sup> transistor is OFF: (by inductance of motor coil) U coil → V coil → V<sup>-</sup> transistor → Return diode → Point (A) (Fig. 3-4)

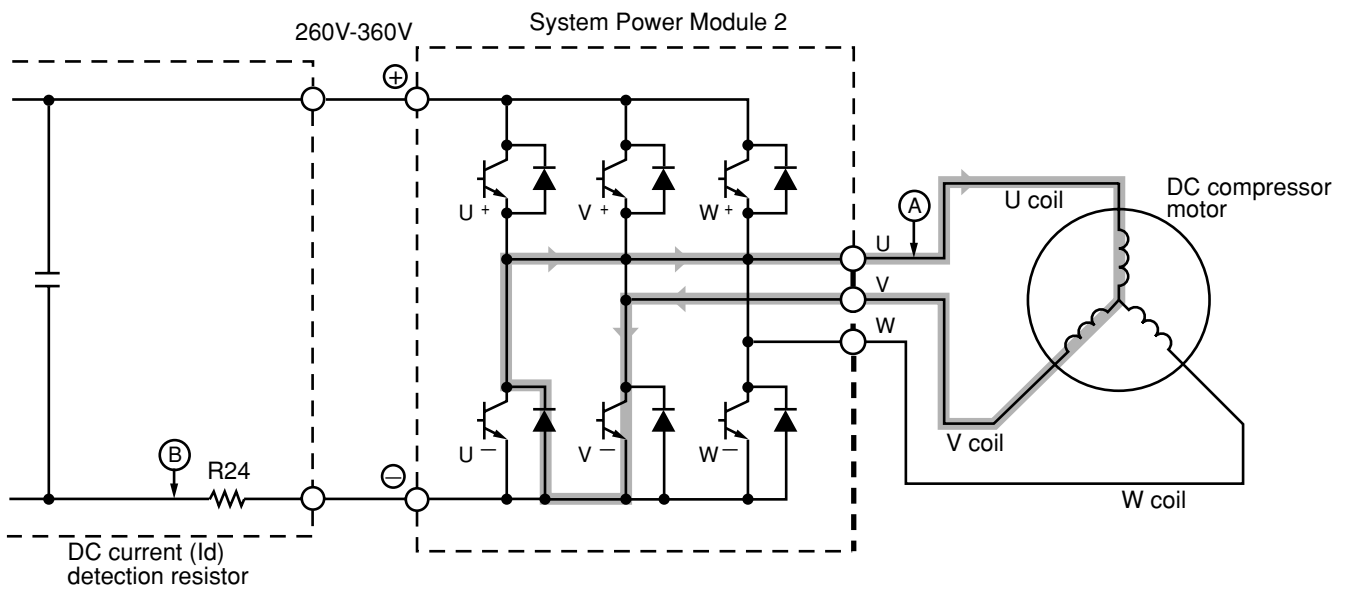

Fig. 3-4 Power module circuit (U<sup>+</sup> is ON, V<sup>-</sup> is ON)

- Since current flows at point B only when U<sup>+</sup> transistor is ON, the current waveform at point B becomes intermittent waveform as shown in Fig. 3-3. Since current at point B is approximately proportional to the input current of the air conditioner, input current is controlled by using DC current (I<sub>d</sub>) detection resistor.

<Reference>

If power module is defective, self diagnosis lamps on the control P.W.B. may indicate as shown below:

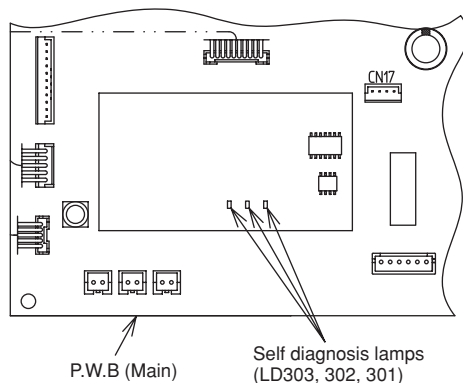

Fig. 3-5

Table 3-1

Self-diagnosis	Self-diagnosis lamp and mode	
I <sub>p</sub> (peak current cut)	LD301	Blinks 2 times
Abnormal low speed rotation	LD301	Blinks 3 times
Switching incomplete	LD301	Blinks 4 times

- Simplified check of power module (Lighting mode when operated with compressor leads disconnected)
  - (1) Disconnect connector of 3-pole (WHT, YEL, RED) lead wire connecting to compressor located at the lower part of electric parts box.
  - (2) Set to compressor operation state (other than FAN mode) and press Start/stop switch of remote control.
  - (3) If normal operation continues for more than 1 minute (LD303 lights), power module is considered normal.
- \* Refer to other item (troubleshooting on page 94) for independent checking of power module.

## 4. Power Circuit for P.W.B.

- Fig. 4-1 shows the power circuit for P.W.B. and waveform at each point.

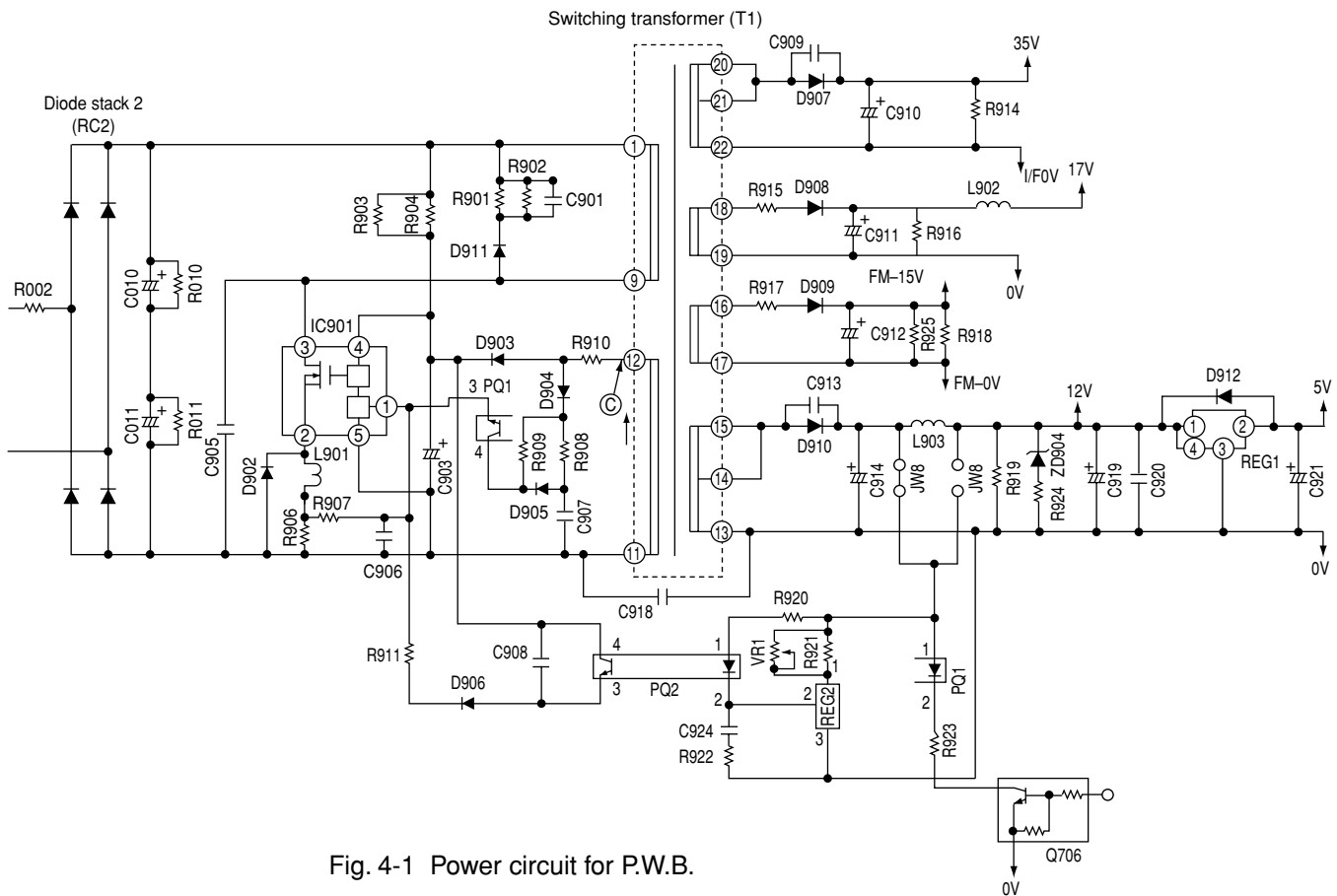

Fig. 4-1 Power circuit for P.W.B.

- In the power circuit for P.W.B., power supply for microcomputer, peripheral circuits, and system power module driver circuit and, as well as DC 35V, are produced by switching power circuit.
- Switching power circuit performs voltage conversion effectively by switching transistor IC901 to convert DC 330V voltage to high frequency of about 20kHz to 200kHz.
- Transistor IC901 operates as follows:

### (1) Shifting from OFF to ON

- DC about 330V is applied from smoothing capacitors C010 ⊕ and C011 ⊖ in the control power circuit. With this power, current flows to pin ④ of IC901 via R903 and R904 and IC901 starts to turn ON. Since voltage in the direction of arrow generates at point © at the same time, current passing through R910 and D903 is positive-fed back to IC901.



(2) During ON

- The drain current at IC901 increases linearly. During this period, the gate voltage and current become constant because of the saturation characteristics of the transformer.

(3) Shifting from ON to OFF

- This circuit applies a negative feedback signal from the 12V output. When the voltage across C919 reaches the specified value, REG2 turns on and current flows to PQ2 ①-②. This turns the secondary circuits on, sets IC901 pin ① to "Hi", and turns IC901 off.

(4) During OFF

- While IC901 is on, the following energy charges the primary windings of the transformer:

Energy= $LI^2/2$ . Here, L : Primary inductance

I : Current when IC1 is off

This energy discharges to the secondary windings during power off. That is, C910, C911, C912, C914 is charged according to the turn ratio of each winding.

- At the start, an overcurrent flows to IC901 because of the charged current at C910, C911, C912, C914.
- The drain current at IC901 generates a voltage across R906. If it exceeds the IC901 base voltage, it sets the IC901 gate voltage to "HI".
- R906 limits the gate voltage to prevent excessive collector current from flowing to IC901.

<Reference>

If the power circuit for P.W.B. seems to be faulty:

- (1) Make sure that 5V and 12V on the control P.W.B., upper arm U, V and W, and the lower arm power voltage are the specified values.

- (2) When only the 5V output is low:

REG 1 (regulator) faulty, 5V-0V shorted, output is too high, or REG 1 is abnormal.

- (3) When 12V and 5V are abnormal:

The following defects can be considered:

① Fan, operation, power, rush prevention relay (shorting in relay, etc.)

② Microcomputer is abnormal.

③ REG 1 (regulator is abnormal), etc.

Shorting on primary circuits.

When shorting occurs in the secondary circuits, there is no abnormality in the primary circuits because of overcurrent protection.

The voltage rises when an opening occurs in the primary circuits, or the feedback system is abnormal.

- (4) When 15V and 17V are abnormal:

D908, D909 or drive circuit is abnormal.

- (5) When all voltage are abnormal:

IC901, R906, etc. are possibly abnormal.

- \* If IC901 is abnormal, be aware that other components, such as the power module, REG (regulator), etc. are possibly defective.

[When the switching power supply seems to be abnormal, the voltage between IC901 pin ④ (to be measured at the leads of R904 and R903) and IC901 pin ⑤ (to be measured at R906 lead) may be between 11 and 16V. This is because the protection circuit of IC901 is operating.]

## 5. Reversing valve control circuit

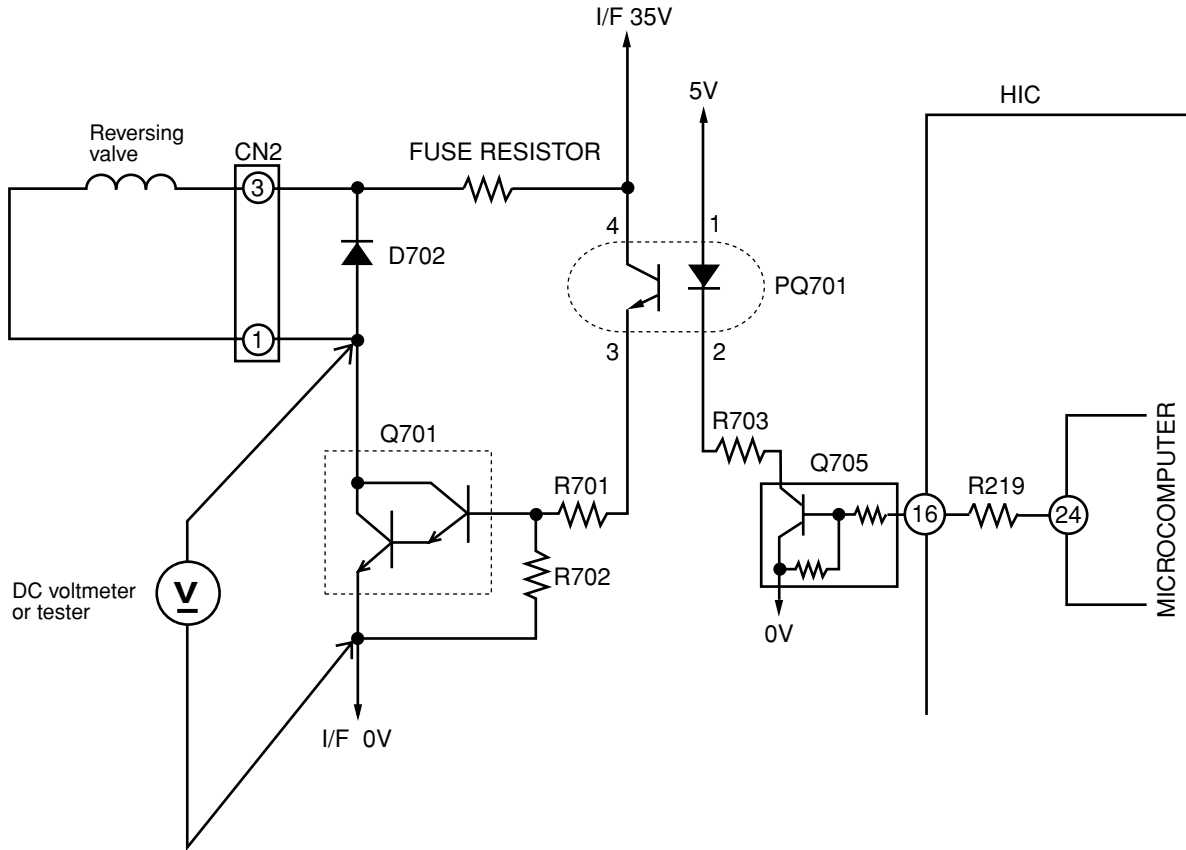

Fig. 5 - 1

- Reversing valve control circuit can switch reversing valve ON/OFF according to instruction from indoor microcomputer depending on the operation condition shows in Table 5-1. Voltage at each point in each operation condition is approximately as shown below when measured by tester. (When collector voltage of Q701 is measured)

Table 5-1

Operation condition		Collector voltage of Q701
Cooling	General operation of Cooling	About 35V
Heating	In normal heating operation	About 0.8V
	MAX. rotation speed instructed by indoor microcomputer after defrost is completed	About 0.8V
	Defrosting	About 35V
Dehumidifying	Sensor dry	About 35V

## 6. Rotor magnetic pole position detection circuit

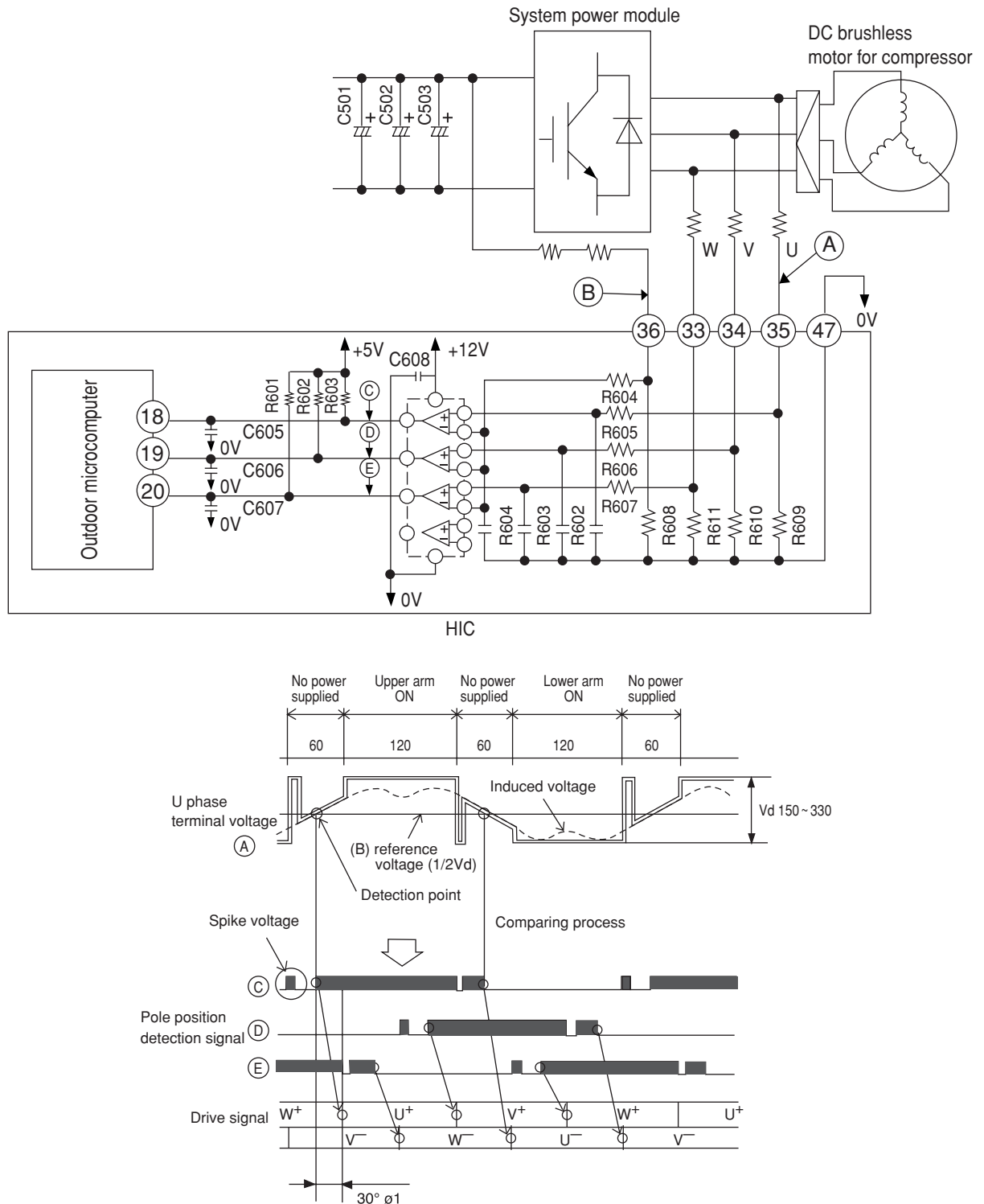

Fig. 6-1 Rotor magnetic pole position detection circuit and voltage waveform at each point

- To detect U phase, voltage at point © is produced by driving motor induced voltage signal (voltage at point ①) and 1/2 voltage of  $V_d$  (voltage at point ②), and comparing with comparator.
- For V phase and W phase, voltage at point ④ and voltage at point ⑤ are produced in the same way as above. Voltage at point © is taken into indoor unit microcomputer, switching timing to  $U^+$  transistor from  $W^+$  transistor is produced by delaying  $30^\circ$  from rise waveform, ignoring spike voltage. In addition, switching timing to U-transistor from W-transistor is produced by delaying  $30^\circ$  from fall waveform.
- For V phase and W phase, in the same way as above, drive signals are produced from voltages at point ④ and point ⑤. Phases are shifted by  $120^\circ$  and  $240^\circ$ , respectively, comparing with U phase.

## 7. Drive Circuit

Fig. 7-1 shows the drive circuit. The circuits for U phase, V phase and W phase have the same Configuration.

- In low speed rotation mode (PWM range), as shown in Fig. 7-2, 0-5V chopper signal is output from microcomputer for each phase. Signal output from microcomputer is output to IC1 and is inverted by active Lo to become 0-15V chopper signal; it is then drive the transistor of each phase.
- In high speed rotation mode (PWM range), as shown in Fig. 7-3, 0-5V drive signal is output from microcomputer for each phase (with no chopper because of full duty). Signal output from microcomputer is input to IC1 and is inverted by active Lo to become 0-15V drive signal; it is then drive the transistor of each phase.

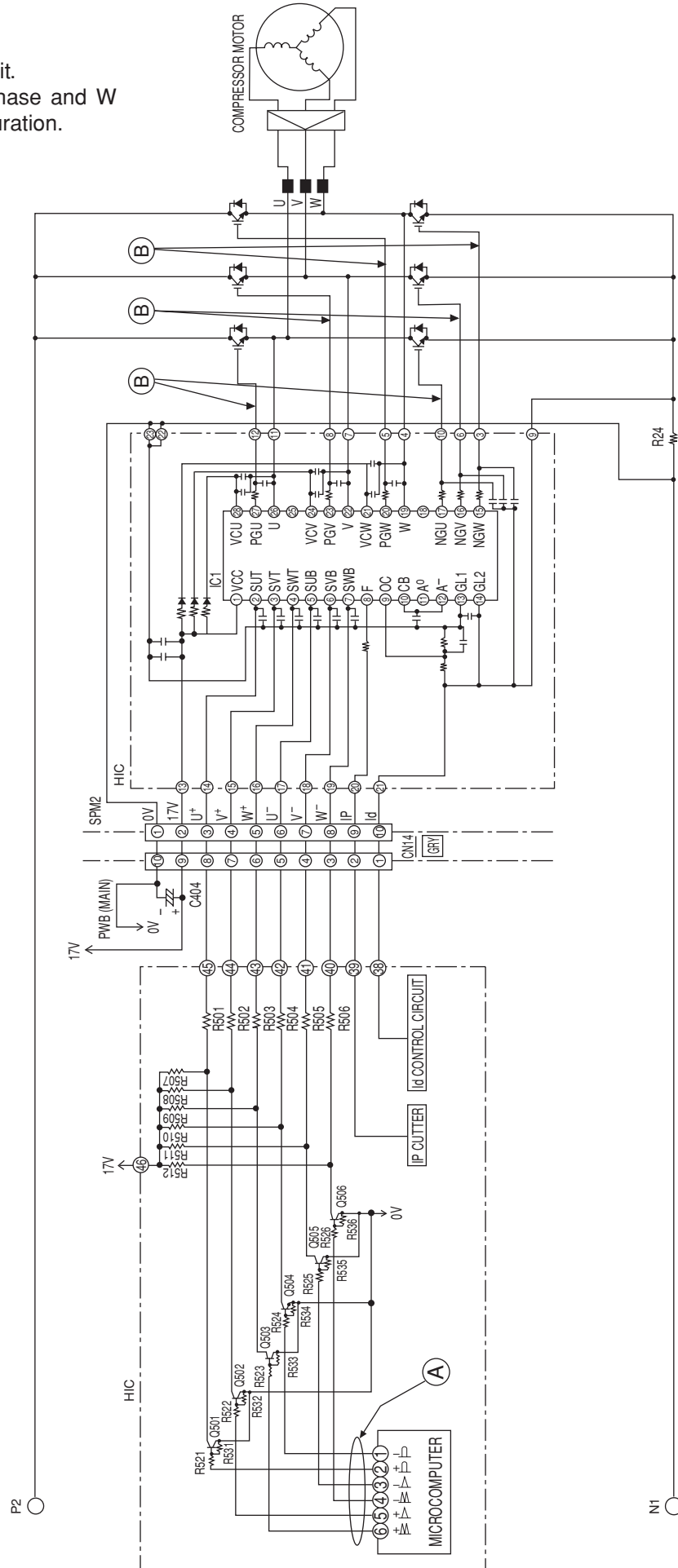

Fig.. 7-1

[Low speed rotation mode]

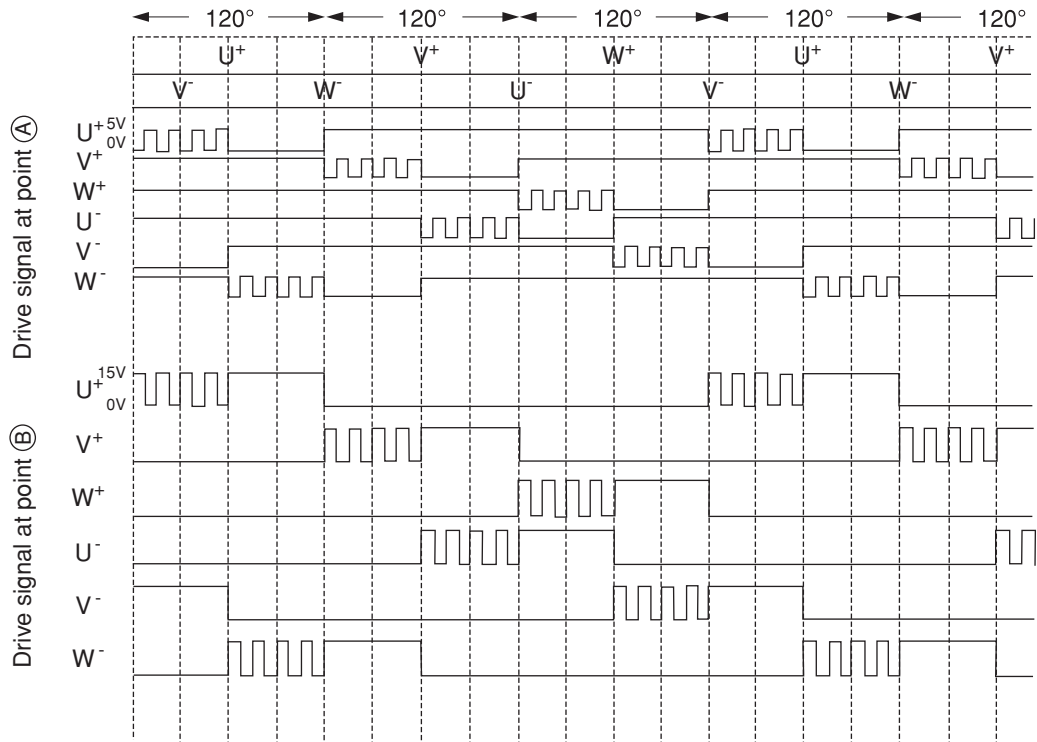

Fig. 7-2

[High speed rotation mode]

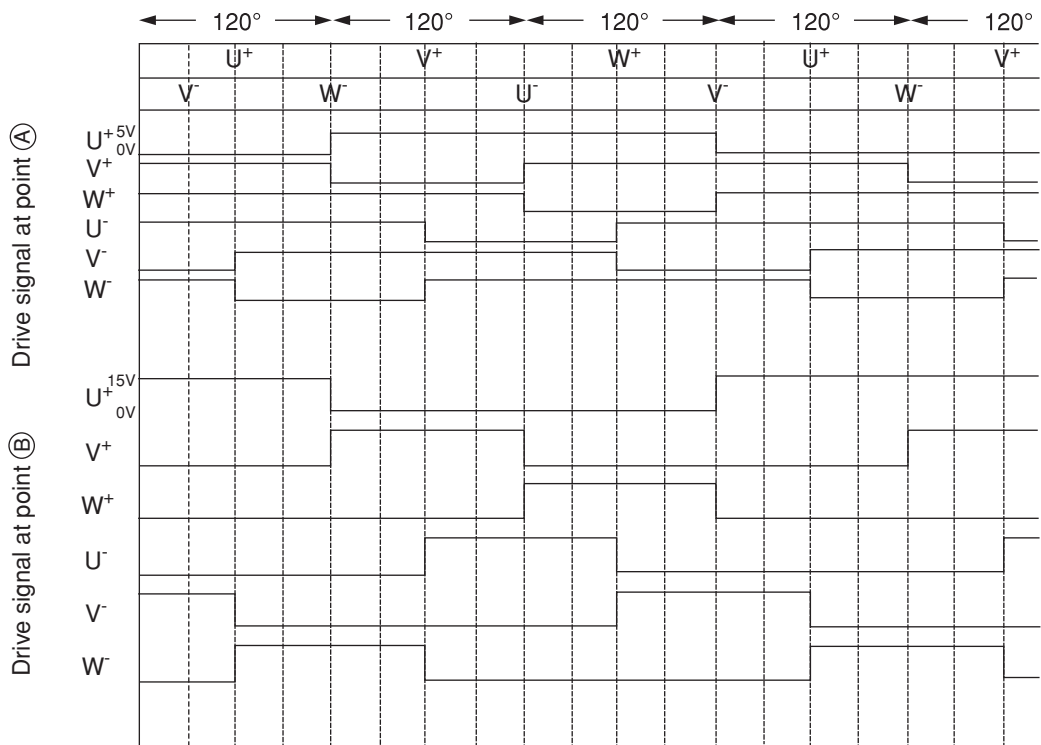

Fig. 7-3

## 8. HIC and Peripheral Circuits

- Fig. 8-1 shows the micro computer and its peripheral circuits, Table 8-1, the basic operations of each circuit block, and Fig. 8-2, the system configuration.

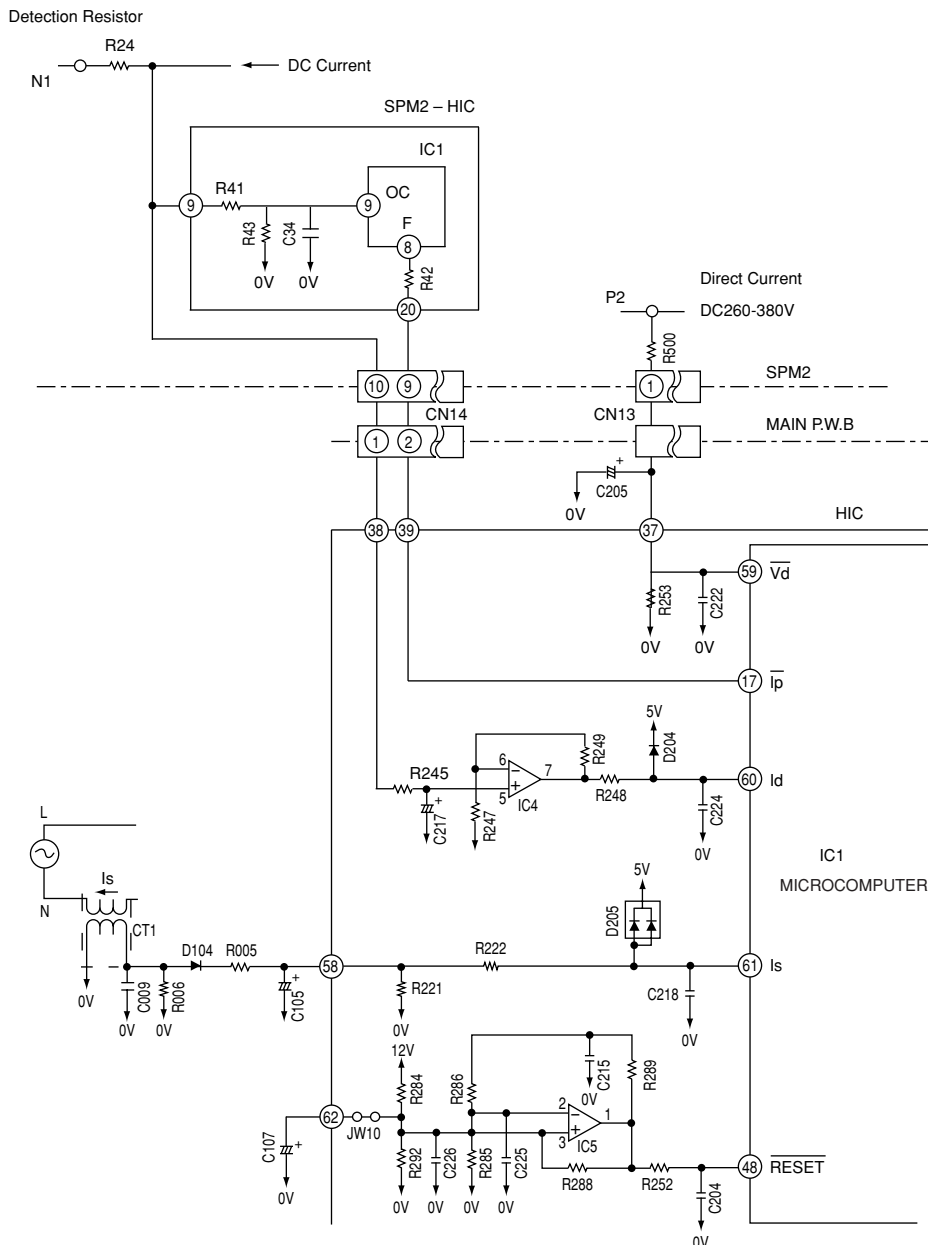

Fig. 8-1 Microcomputer and Peripheral Circuits

Table 8-1

Circuit block	Basic operation
Peak current cutoff circuit	Detects DC current flowing power module and during overcurrent (instantaneous value) flows, stops upper/lower arm drive circuits and also produces Ip signal by which drive signal output is stopped.
Set value circuit	Compares voltage detected, amplified and input to HIC with set voltage value in microcomputer, and controls overload when set value exceeds input voltage.
Voltage amplifier circuit	Voltage-amplifies DC current level detected by the detection resistor and inputs this to microcomputer. Internal or external overload is judged in microcomputer.
Reset circuit	Produces reset voltage.
Trip signal synthesis circuit	Modulates chopper signal to drive signal and stops according to presence/absence of Ip signal or reset signal.

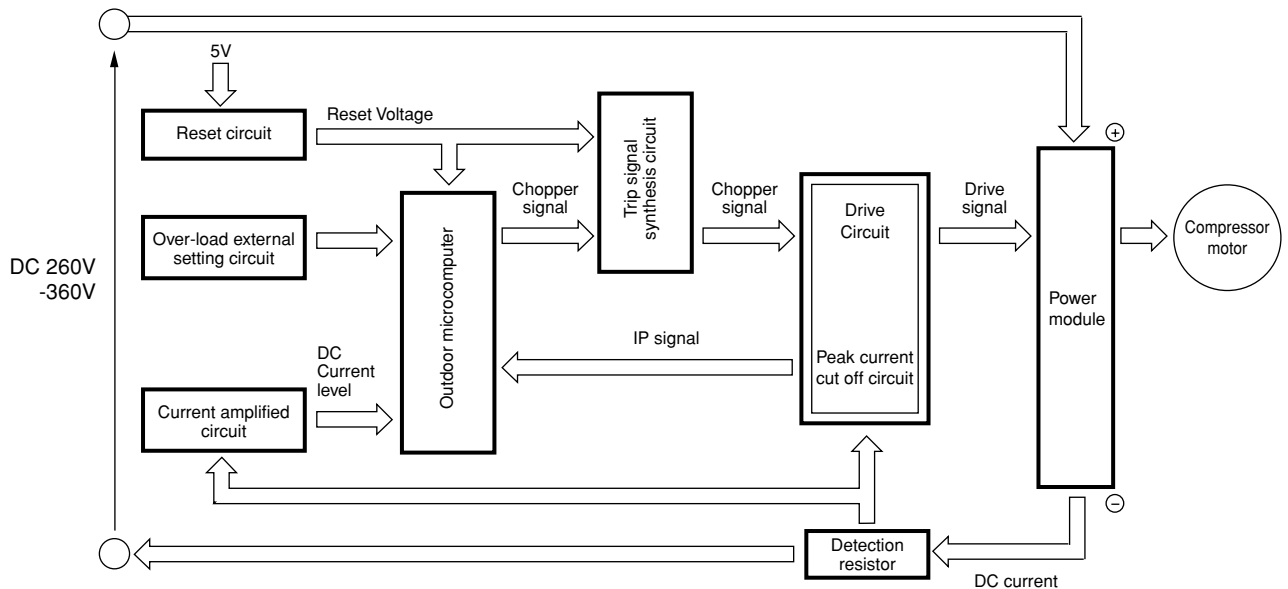

Fig. 8-2

- The following describes the operations of each circuit in detail.

(1) Peak current cut off circuit

Fig.8-3 Peak Current Cut off Circuit and Waveforms at Each Section.

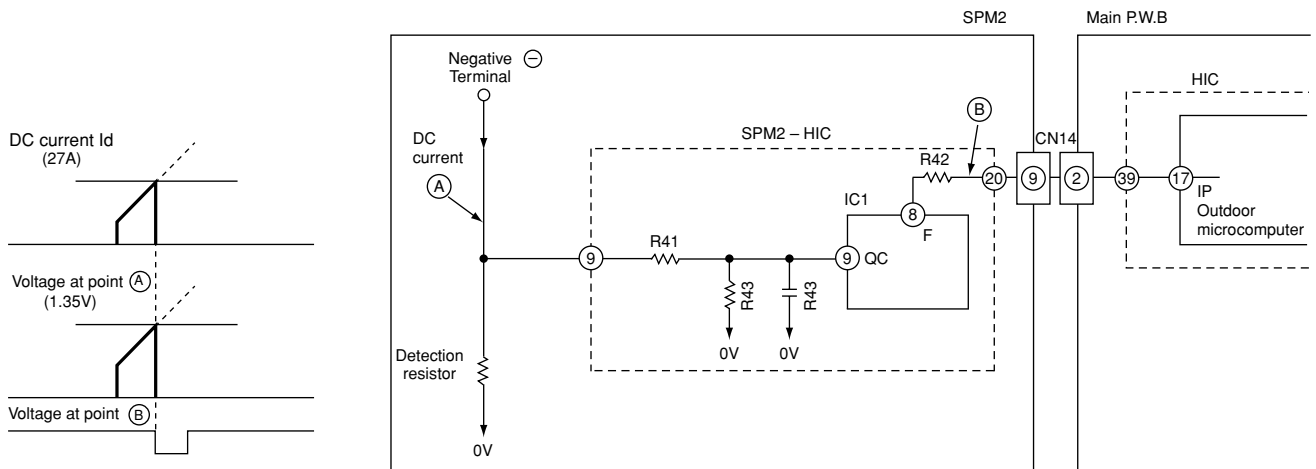

Fig.8-3

- The Ip cut off circuit detects an instantaneous excessive current and stops inverter to protect parts such as SPM2, etc.
- As shown in diagram, if current exceeding 27A flows, voltage at point (A) recognized by detecting resistor is input to pin (10) of SPM2 – HIC, and voltage divided by R41 and R43 is input to pin (9) of IC1. Since threshold of IC1 is exceeded in this case, Lo signal is input from pin (8) (Voltage at point (B) . When Lo signal is input to pin (17) of microcomputer, microcomputer stops drive output.
- When drive output from microcomputer is stopped, all drive output goes Hi, and microcomputer is initialized to enter drive signal standby mode. 3 minutes later, microcomputer outputs drive signal again, to start operation.

(2) Overload control circuit (OVL control circuit)

- Overload control is to decrease the speed of the compressor and reduce the load when the load on the air conditioner increases to an overload state, in order to protect the compressor, electronic components and power breaker.
- Overloads are judged by comparing the DC current level and set value.
- Fig. 8-4 shows the overload control system configuration and Fig. 8-5 is a characteristic diagram of overload judgement values. There are two judgement methods-external judgement which compares the externally set value with the DC current value regardless of the rotation speed and internal judgement which compares the set value that varies according to the rotation speed programmed in the microcomputer software with the DC current value.

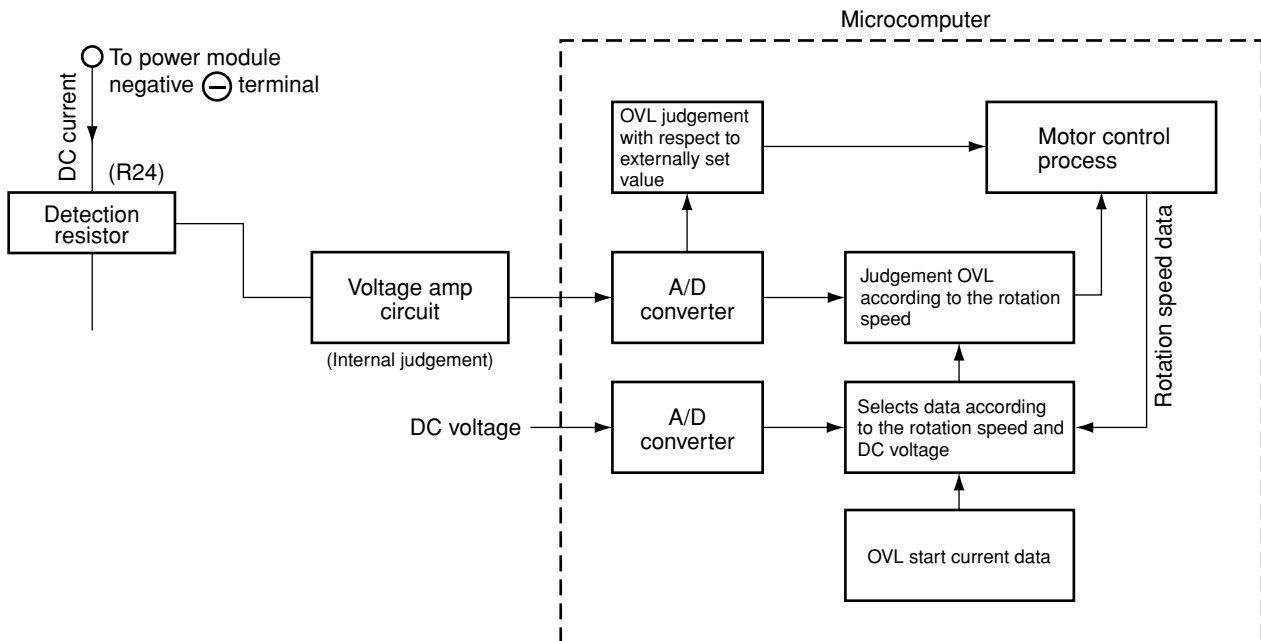

Fig. 8-4 Overload Control System Configuration

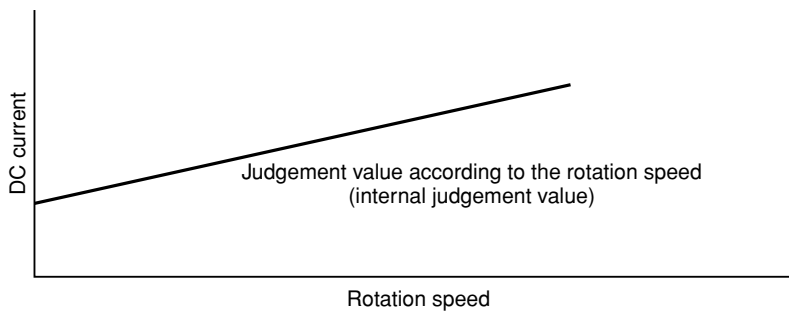

Fig. 8-5

①. Overload external judgement circuit

- Fig. 8-1. The filter consisting of R245 and C217 removes high harmonic components from the voltage generated by the current flowing to Detection resistor; R245 and C217 average the voltage. This voltage is then input to IC4 pin ⑤ is then amplified and supplied to microcomputer pin ⑩. The microcomputer compares this input with the internally set value, and if the input exceeds the set value, it enters overload control status.
- Fig. 8-7 shows the rotation speed control. When the voltage at pin ⑩ of the microcomputer exceeds the set value, the microcomputer decreases the rotation speed of the compressor and reduces the load regardless of the rotation speed commanded by the indoor microcomputer.



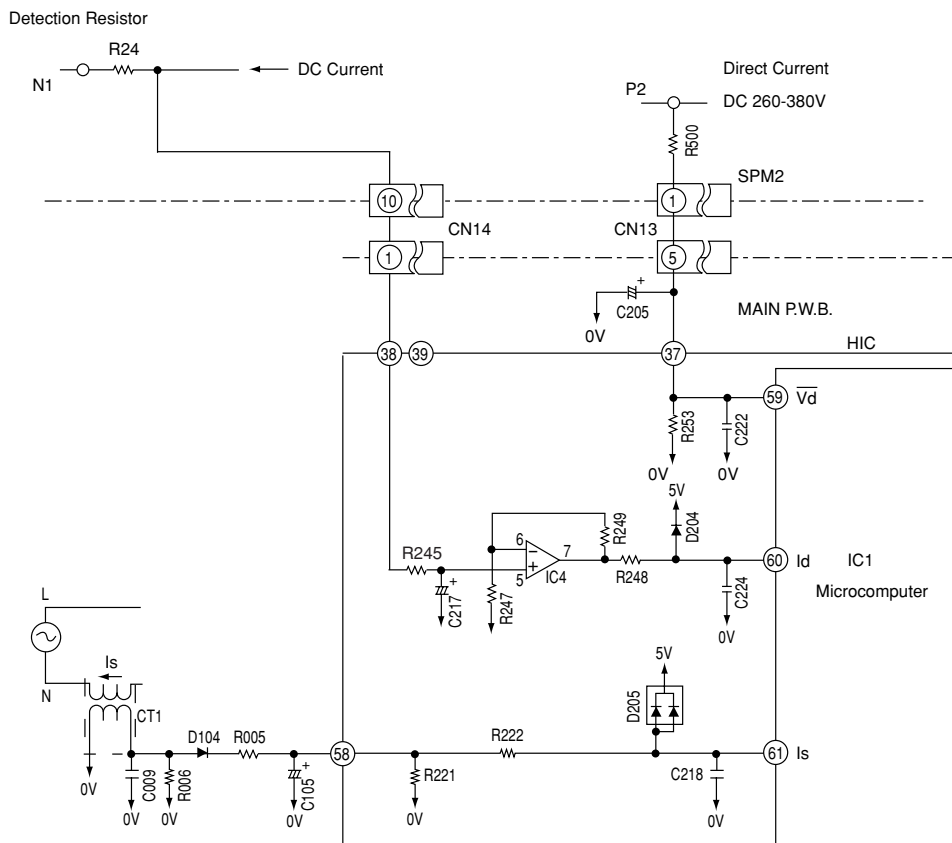

Fig. 8-6

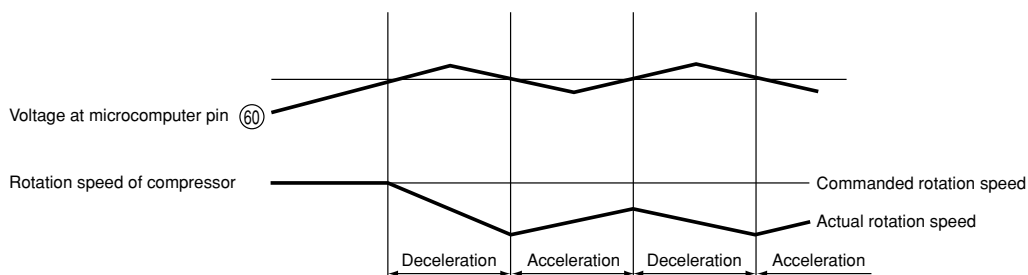

Fig. 8-7

②. Voltage amp. circuit

- The voltage amp. circuit amplifies the DC current level detected by the detection resistor after being converted to a voltage and supplies it to the microcomputer. Receiving this, the microcomputer converts it to a digital signal and compares it with the internal data to judge whether or not overload control is required.

< During overload control >

- The filter consisting of R245 and C217 removes high harmonic components from the voltage generated from the DC current flowing to the detection resistor, and supplies it to IC4 pin ⑤ IC4 forms a non-inverting voltage amp. circuit together with the peripheral elements.
- The microcomputer stores the set values which vary according to the rotation speed. When the DC current level exceeds the set value, the microcomputer enters the overload control state.
- The set Value is determined by the amplification of the voltage amp. circuit.

- Amplification : high → DC current : low
- Amplification : low → DC current: high

- R500, R253, detect the DC voltage at the power circuit. The microcomputer receives a DC voltage (260-380V) via HIC ⑳ and applies correction to the overload set value so the DC current is low (high) when the DC voltage is high (low).

(Since the load level is indicated by the DC voltage multiplied by DC current, R247, R248, R249 are provided to perform the same overload judgement even when the voltage varies.)

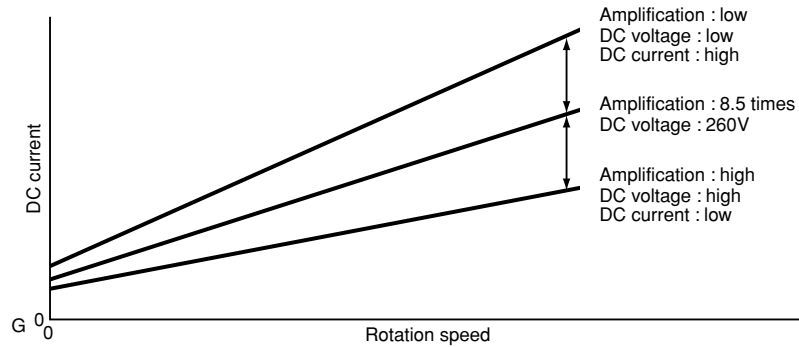

Fig. 8-8

< During start current control >

- It is required to maintain the start current (DC current) constant to smooth the start of the DC motor for the compressor.
- It is software to control the start current.
- The start current varies when the supply voltage varies. This control method copes with variations in the voltages as follows.

(1) Turns on the power module's U<sup>+</sup> and V<sup>-</sup> transistors so the current flows to the motor windings as shown in Fig8-9.

(2) Varies the turn-ON time of the W<sup>+</sup> transistor according to the DC voltage level and the start is controlled so the start current is approx. 10A as shown in Fig. 8-10.

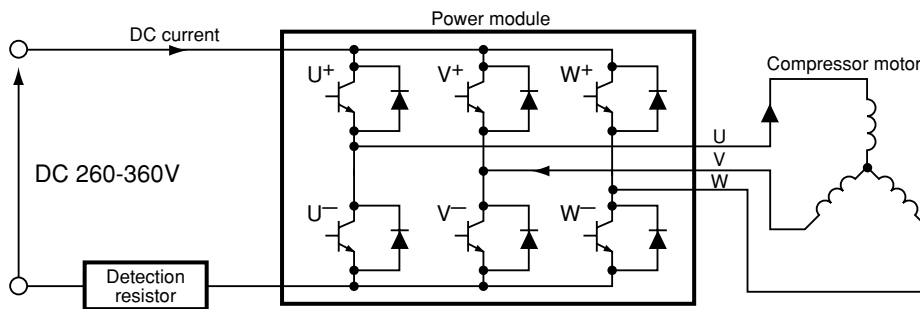

Fig. 8-9

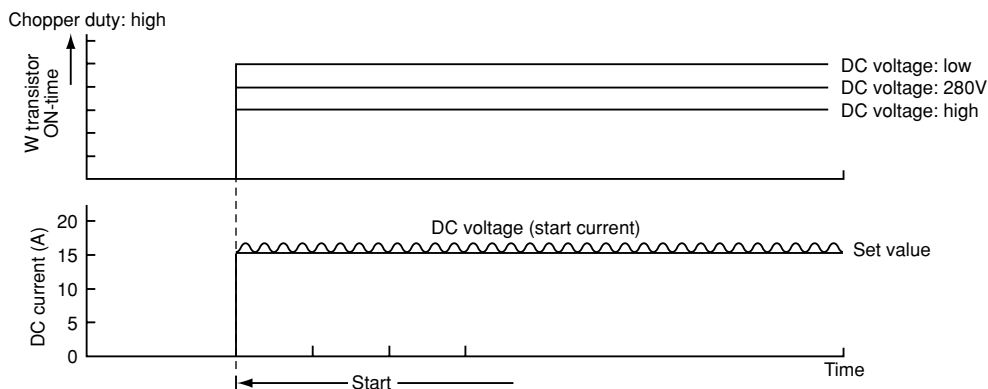

Fig. 8-10

## 9. Temperature Detection Circuit

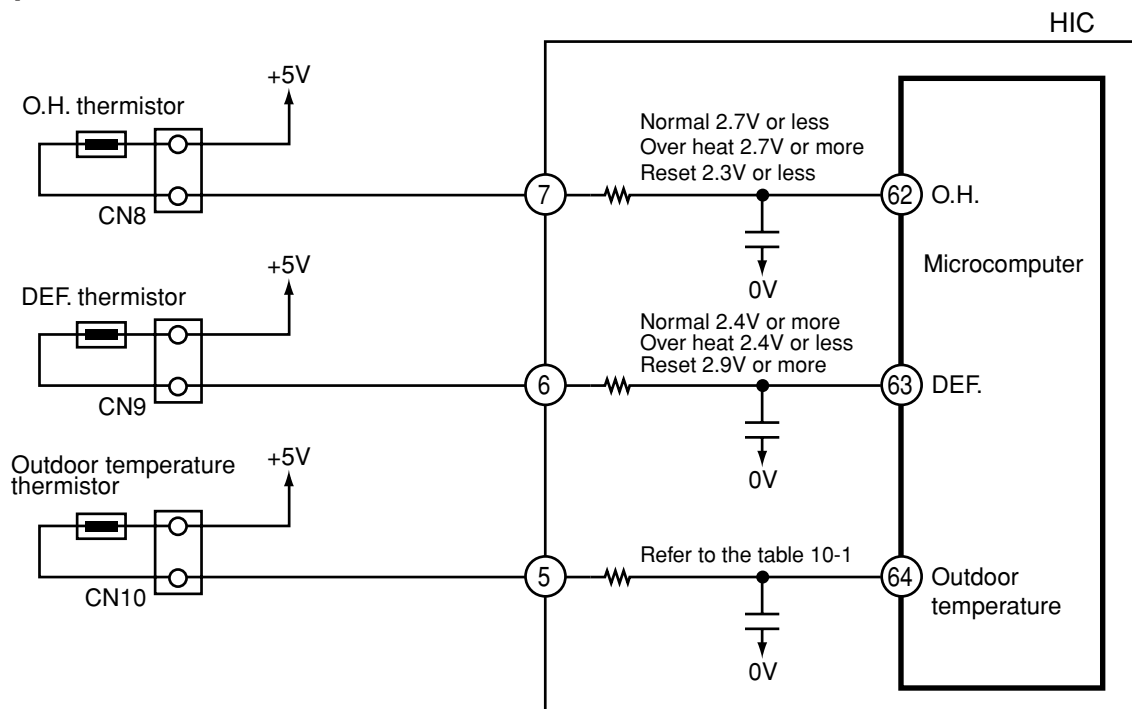

Fig. 9-1

- The Over heat thermistor circuit detects the temperature at the surface of the compressor head, the Defrost. thermistor circuit detects the defrosting operation temperature.
- A thermistor is a negative resistor element which has the characteristics that the higher (lower) the temperature, the lower (higher) the resistance.
- When the compressor is heated, the resistance of the Over heat thermistor becomes low and voltage at pin ⑥② of microcomputer is increased.
- Microcomputer compares the voltage present at pin ⑥② with the internal set value, if it is exceeded the set value microcomputer judges that the compressor is overheated and stops operation.
- When frost forms on the outdoor heat exchanger, the temperature at the exchanger drops abruptly. Therefore the resistance of the Defrost. thermistor becomes high and the voltage at pin ⑥③ of microcomputer drops. If this voltage becomes lower than the set value stored inside, the microcomputer starts defrosting control.
- During defrosting operation the microcomputer transfers the defrosting condition command to the indoor microcomputer via the circuit interface.
- The microcomputer always reads the outdoor temperature via a thermistor (microcomputer pin ⑥④), and transfers it to the indoor unit, thus controlling the compressor rotation speed according to the value set at the EEPROM in the indoor unit, and switching the operation status (outdoor fan on/off, etc.) in the dry mode.

The following shows the typical values of outdoor temperature in relation to the voltage:

Table 9-1

Outdoor temperature (°C)	-10	0	10	20	30	40
Microcomputer pin ⑤ voltage (V)	1.19	1.69	2.23	2.75	3.22	3.62

<Reference>

When the thermistor is open, in open status, or is disconnected, microcomputer pins ⑥②–⑥④ are approx. 0V; when the thermistor is shorted, they are approx. 5 V, and LD301 blinks seven times.

However, an error is detected only when the OH thermistor is shorted; in such a case, the blinking mode is entered 12 minutes after the compressor starts operation.

# 10. Reset Circuit

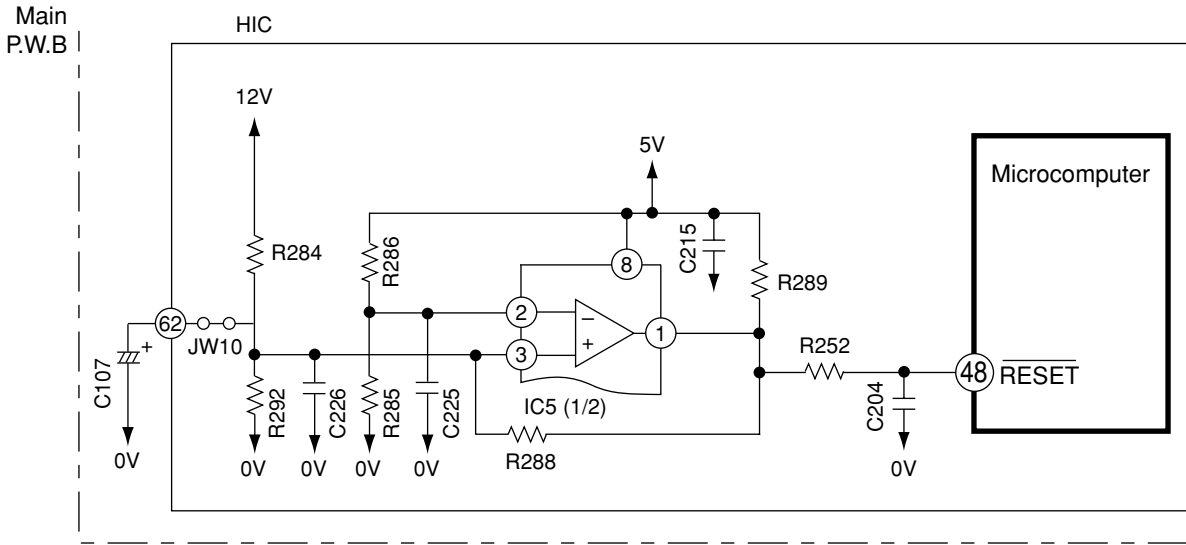

Fig. 10-1

- The reset circuit initializes the microcomputer program when Power is “ON” or “OFF”.
- Low voltage at pin (48) resets the microcomputer, and HI activates the microcomputer.
- Fig. 10-1 shows the reset circuit and Fig. 10-2 shows waveform at each point when power is turned on and off.
- When power is turned on, 12V line and 5V line voltages rise and 12V line voltage reaches 10.9V and reset voltage input to pin (48) of microcomputer is set to Hi.
- Reset voltage will be hold “Hi” until the 12V line voltage drops to 9.90V even though the power shuts down.

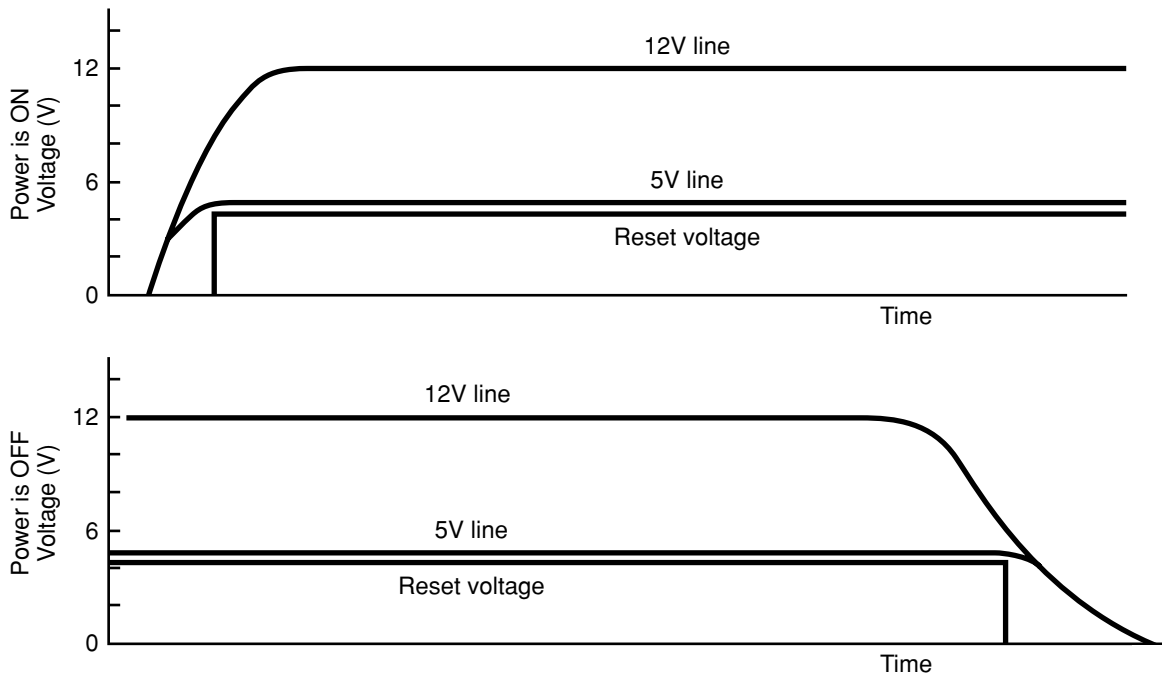

Fig. 10-2

## 11. Outdoor DC Fan Motor control circuit.

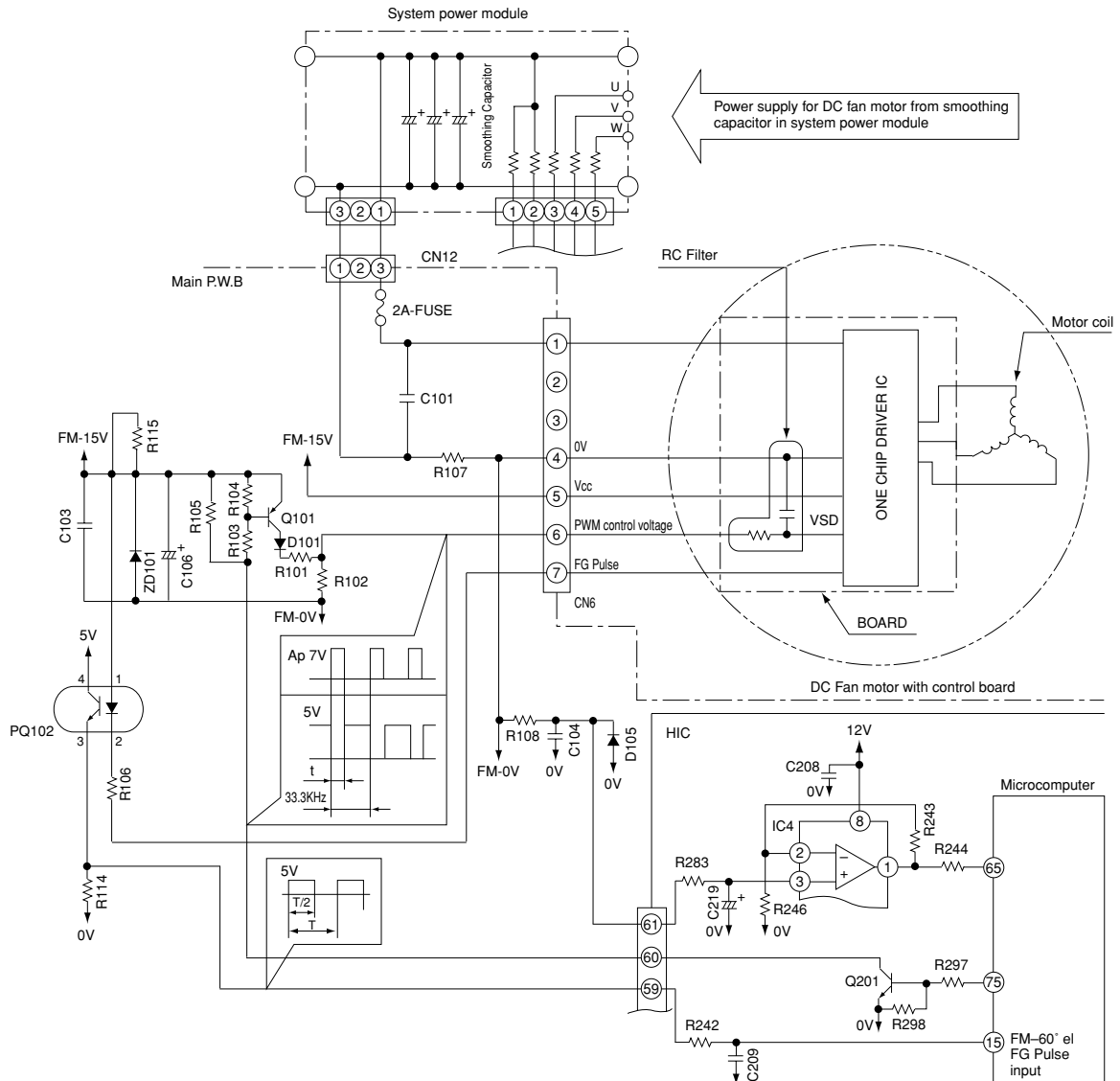

Fig. 11-1

- This model uses DC Fan Motor which has a controller circuit in the Motor.
- This DC Fan Motor will rotate by control voltage apply to Vsp input. (Voltage range: 1.7 to 7V DC)  
Vsp high : Faster ; Vsp low : slower ; Vsp lower than 1.7V : stop
- Motor will output FG pulse by following this motor revolution.
- Outdoor Microprocessor will output PWM control signal from FMCHOP terminal by following the instruction from indoor Microprocessor.
- This PWM control signal will convert to Vsp voltage by smoothing circuit (Q101 & RC filter)
- Fan motor will start to rotate when Vsp was proceeding over than 1.7V, and generate FG pulse by rotation speed.
- FG pulse will feed back to Outdoor Microprocessor through PQ102.
- PQ102 is the isolator between Microprocessor circuit and DC Fan Motor circuit, which has to match the Fan Motor revolution with instructed revolution. Such as...  
FG feedback: Faster – Instruction: Slower ... Decrease pulse width  
FG feedback: Slower – Instruction: Faster ... Increase pulse width
- FG pulse is also used for Fan Motor failure detection
- Microprocessor will monitor FG pulse 30 seconds after start the fan motor. If there is no signal detected, it will consider that the Fan Motor was malfunction and stop the operation. In this case, LD302 on control PWB will blink 12 times. (Fan Motor lock detected)
- R107 and IC4 are used for Fan Motor over current

< Reference >

- When operation stop with LD301 blinks 12 times, it may be caused by faulty DC fan motor.
- In this case, please check CN6 and CN12 connection first. It makes Fan Motor Lock also if those connectors are in misconnection.
- DC Fan Motor has broken when 2A Fuse was burned. Please replace both DC Fan Motor and 2A Fuse together.
- It will makes "Fan Lock Stop"when something has disturb the Fan rotation by inserting materials into propeller fan or ice has growing inside of outdoor unit by snowing.
- It may make "Fan Lock Stop" by strong wind (ex. 17m/sec or above) against the Fan rotation. In this case, unit will be restart again after a while.
- In case of "Fan Lock Stop" even though the DC Fan Motor is rotating correctly, the possible casue is Fan Motor problem or PQ102 on board or control board problem. Stop after the Fan motor runs 2 minutes, Fan Motor may be broken.

< Caution >

- Please take care for the electrical shock by high voltage of DC Fan Motor power source which is common with compressor when you are servicing this unit.
- You can not confirm the coil and wiring of Motor due to the built in control circuit in Fan Motor.

## 12. Power Factor Control Circuit

Power factor is controlled to almost 100%. (Effective use of power)

With IC in ACT module, control is performed so that input current waveform will be similar to waveform of input voltage

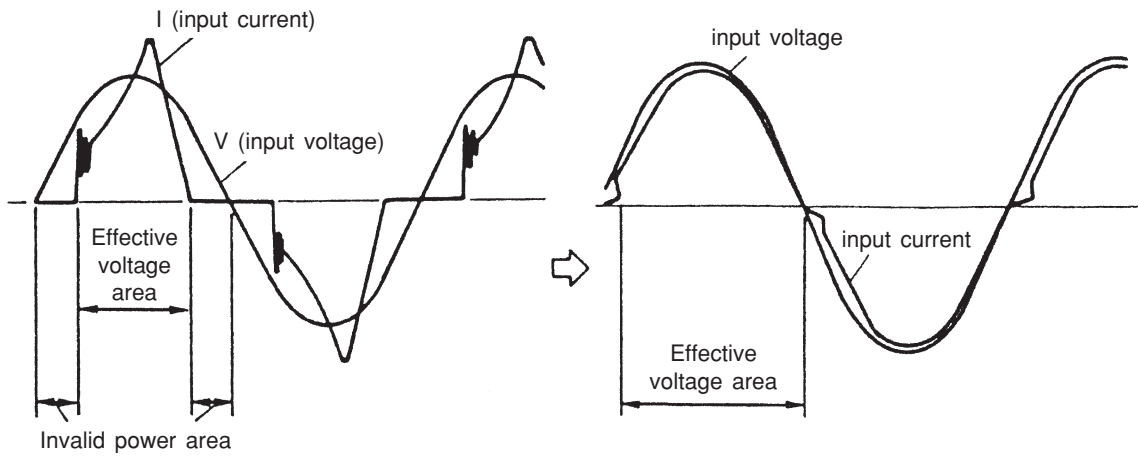

(Even if voltage is applied, current does not flow)

\* Assuming the same current capacity (20A), power can be used about 10% effective, comparing with current use (power factor of 90%), and maximum capacity is thereby improved.

# SERVICE CALL Q & A

## COOLING MODE

**Q1)** The compressor has stopped suddenly during cooling operation.



**A1)** Check if the indoor heat exchanger is frosted. Wait for 3-4 minutes until it is defrosted.

If the air conditioner operates in cooling mode when it is cold, the evaporator may get frosted.

## DEHUMIDIFYING MODE

**Q2)** Sound of running water is heard from indoor unit during dehumidifying.



**A2)** Normal sound when refrigerant flows in pipe.

**Q3)** Compressor occasionally does not operate during dehumidifying.



**A3)** Compressor may not operate when room temperature is 10°C or less. It also stops when the humidity is preset humidity or less.

## HEATING MODE

**Q4)** The circulation stops occasionally during Heating mode.



**A4)** It occurs during defrosting. Wait for 5-10 minutes until the condenser is defrosted.

**Q5)** When the fan speed is set at HIGH or MED, the flow is actually Weak.



**A5)** At the beginning of heating, the fan speed remains LOW for 30 seconds. If HIGH is selected, it switches to LOW and again to MED after additional 30 seconds.

**Q6)** Heating operation stops while the temperature is preset at "30".



**A6)** If temperature is high in the outdoor, heating operation may stop to protect internal devices.



## AUTO FRESH DEFROSTING

**Q7)** After the ON/OFF button is pressed to stop heating, the outdoor unit is still working with the OPERATION lamp lighting.



**A7)** Auto Fresh Defrosting is carried out : the system checks the outdoor heat exchanger and defrosts it as necessary before stopping operation.

## AUTO OPERATION

**Q8)** Fan speed does not change when fan speed selector is changed during auto operation.



**A8)** At this point fan speed is automatic.

## NICE TEMPERATURE RESERVATION

**Q9)** When on-timer has been programmed, operation starts before the preset time has been reached.



**A9)** This is because “Nice temperature reservation” function is operating. This function starts operation earlier so the preset temperature is reached at the preset time. Operation may start maximum 60 minutes before the preset time.

**Q10)** Does “Nice temperature reservation” function operate during dehumidifying?



**A10)** It does not work. It works only during cooling and heating.

**Q11)** Even if the same time is preset, the operation start time varies.



**A11)** This is because “Nice temperature reservation” function is operating. The start time varies according to the load of room. Since load varies greatly during heating, the operation start time is corrected, so it will vary each day.

## INFRARED REMOTE CONTROL

**Q12)** Timer cannot be set.



**A12)** Has the clock been set? Timer cannot be set unless the clock has been set.

**Q13)** The current time display disappears soon.



**A13)** The current time disappears in approx. 10 seconds. The time set display has priority.

When the current time is set the display flashes for approx 3 minutes.

**Q14)** The timer has been programmed, but the preset time disappears.



**A14)** Is the current time past the preset time? When the preset time reaches the current time, it disappears.

## OTHERS

**Q15** The indoor fan varies among high air flow, low air flow and breeze in the auto fan speed mode. (Heating operation)



**A15** This is because the cool wind prevention function is operating, and does not indicate a fault.

The heat exchanger temperature is sensed in the auto speed mode. When the temperature is low, the fan speed varies among high air flow, low air flow and breeze.

**Q16** Loud noise from the outdoor unit is heard when operation is started.



**A16** When operation is started, the compressor rotation speed goes to maximum to increase the heating or cooling capability, so noise becomes slightly louder. This does not indicate a fault.

**Q17** Noise from the outdoor unit occasionally changes.



**A17** The compressor rotation speed changes according to the difference between the thermostat set temperature and room temperature. This does not indicate a fault.

**Q18** There is a difference between the set temperature and room temperature.



**A18** There may be a difference between the set temperature and room temperature because of construction of room, air current, etc. Set the temperature at a comfortable for the space.

**Q19** Air does not flow immediately after operation is started.



**A19** Preliminary operation is performed for one minute when the power switch on and heating or dehumidifying is set. The operation lamp blinks during this time for heating. This does not indicate a fault.

# TROUBLE SHOOTING

## PRECAUTIONS FOR CHECKING



**DANGER**

1. Remember that the 0V line is biased to 155-170V in reference to the ground level.
2. Also note that it takes about 10 minutes until the voltage fall after the power switch is turned off.

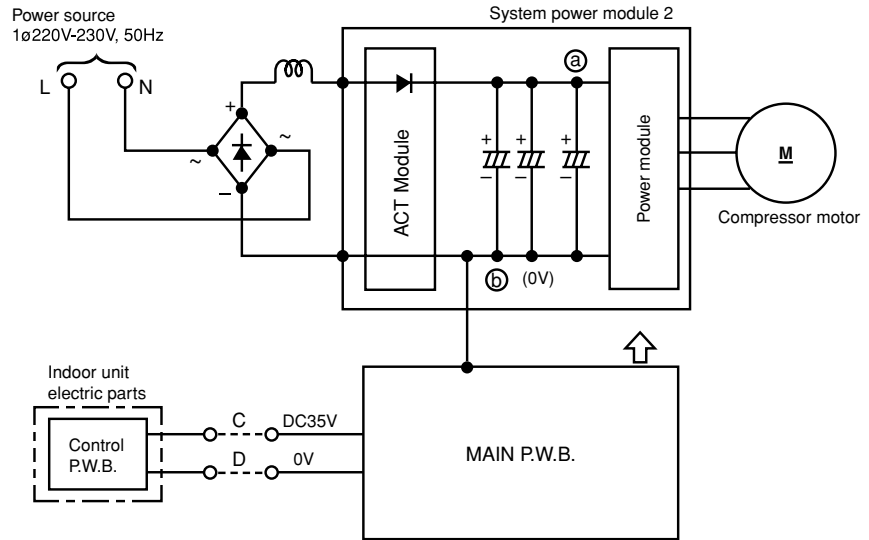

- Across (a) – (b) (0V line)..... approx 260-360V
- Across (a) – ground..... approx 155-170V
- Across (b) (0V line)– ground..... approx 155-170V



**DANGER**

When using an oscilloscope, never ground it. Don't forget that high voltages as noted above may apply to the oscilloscope.

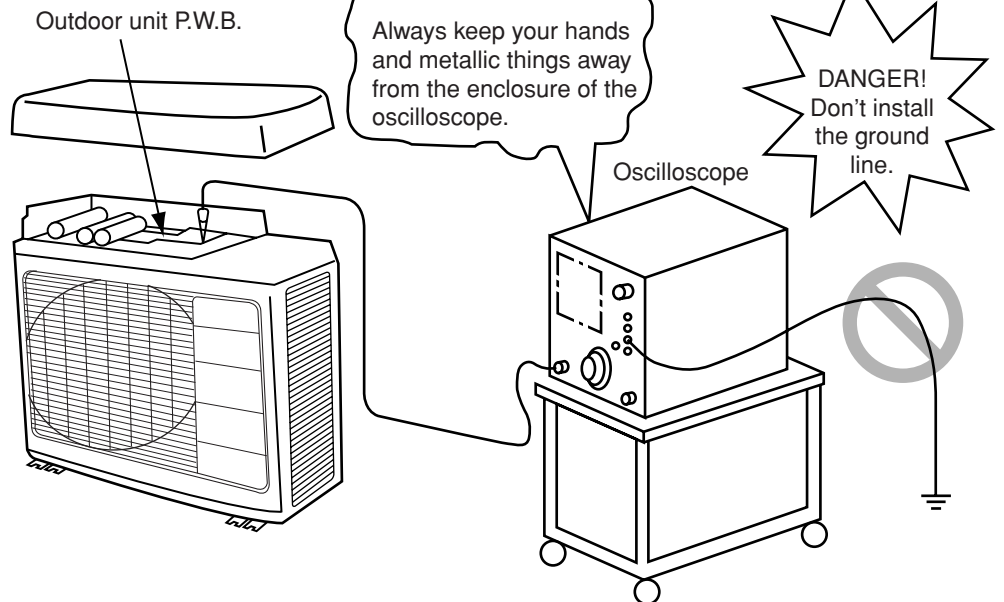

## DISCHARGE PROCEDURE AND POWER SHUT OFF METHOD FOR POWER CIRCUIT



WARNING

### Caution

- Voltage of about 300-330V is charged between both ends of smoothing capacitors
- During continuity check for each part of circuit in indoor unit electrical parts, disconnect red/gray lead wire connected from diode stack to system power module (SPM2) to prevent secondary trouble. (Be sure to discharge smoothing capacitor)

1. Turn OFF the Power supply to the outdoor unit.
2. After power is turned off, wait for 10 minutes or more. Then, remove electrical parts cover and apply soldering iron of 30 to 75W for 15 seconds or more to P2 and N1 terminals on system power module, in order to discharge voltage in smoothing capacitor.
3. Remove receptacle of red/gray lead wire connected to system power module from diode stack before performing operation check of each circuit.

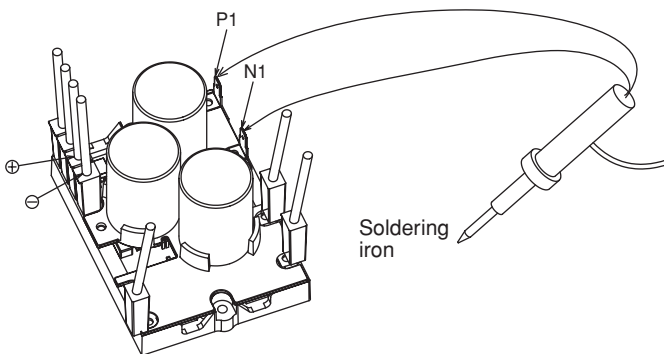

System power module

Do not use a soldering iron with transformer: If one is used, thermal fuse inside transformer will be blown

As shown above, apply soldering iron to metal parts (receptable) inside the sleeve corresponding to P1 and N1 terminals of system power module: Do this with smoothing capacitors kept connected. By removing red/gray lead wire from diode stack, power supply can be shut off. (corresponding to ⊕ and ⊖ terminals of system power module)

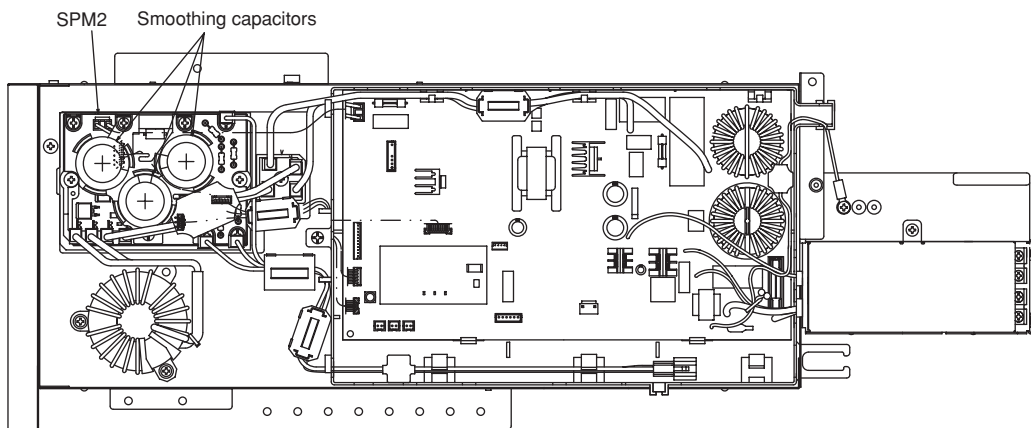



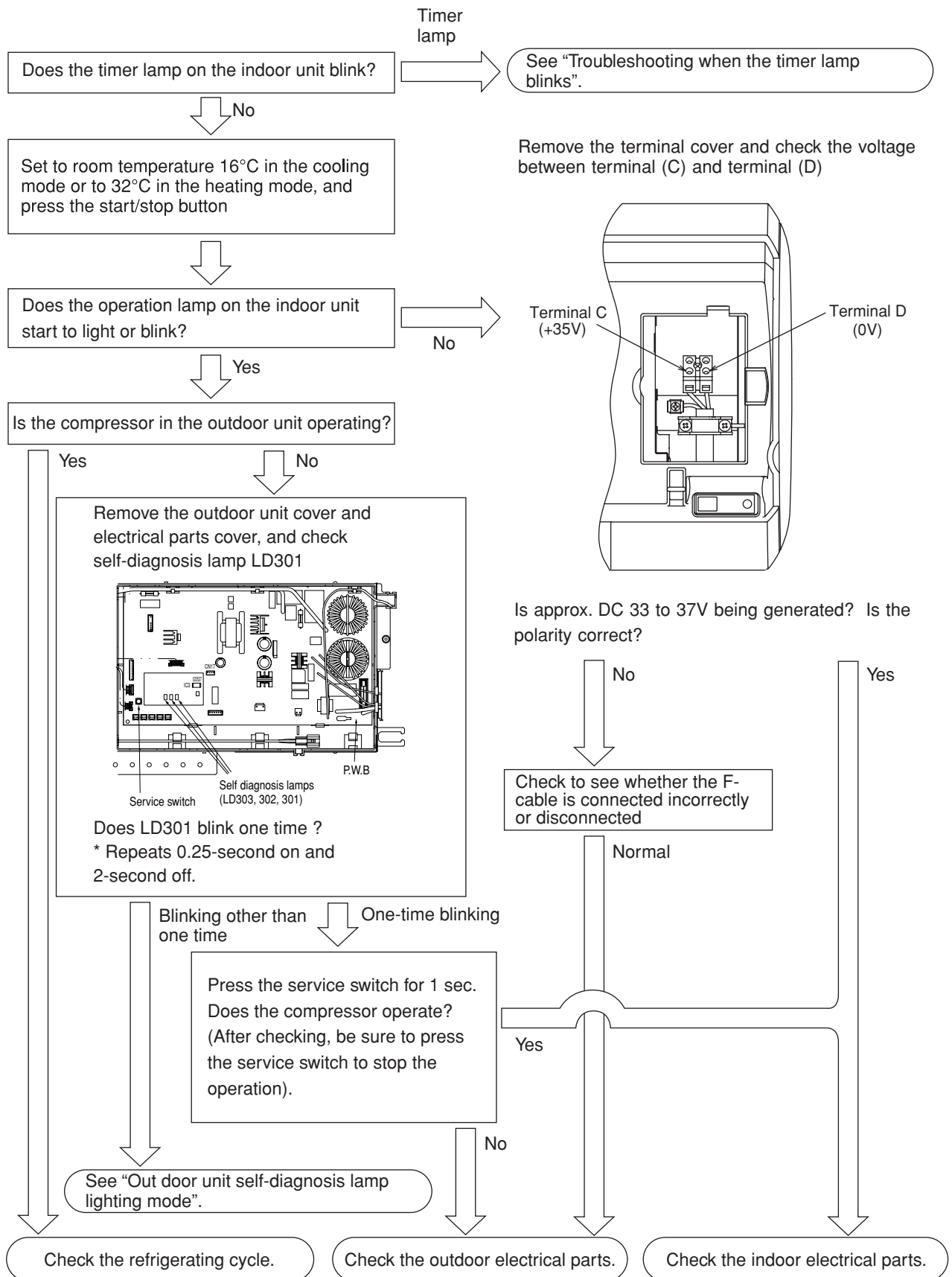

# CHECKING THE INDOOR/OUTDOOR UNIT ELECTRICAL PARTS AND REFRIGERATING CYCLE

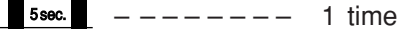
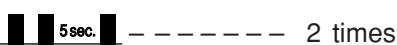
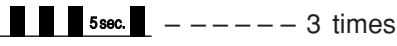

## TROUBLESHOOTING WHEN TIMER LAMP BLINKS.

Perform troubleshooting according to the number of times the indoor timer lamp and outdoor LD301 blink.

### SELF-DIAGNOSIS LIGHTING MODE

No.	Blinking of Timer lamp	Reason for indication	Possible cause
1	 1 time	<u>Reversing valve defective</u> When the indoor heat exchanger temperature is too low in the heating mode or it is too high in the cooling mode.	(1) Reversing valve defective (2) Heat exchanger thermistor disconnected (only in the heating mode) (Note) The malfunction mode is entered the 3rd time this abnormal indication appears (read every 3 minutes).
2	 2 times	<u>Outdoor unit forced operation</u> When the outdoor unit is in forced operation or balancing operation after forced operation	Electrical parts in the outdoor unit
3	 3 times	<u>Indoor/outdoor interface defective</u> When the interface signal from the outdoor unit is interrupted.	(1) Indoor interface circuit (2) Outdoor interface circuit
4	 4 times	Outdoor electrical assembly defective.	Please check at the outdoor electrical led lamp blinking (LD301) and refer to self diagnosis lighting mode for outdoor unit.
5	 9 times	<u>Room thermistor or heat exchanger thermistor is faulty</u> When room thermistor or heat exchanger thermistor is opened circuit or short circuit.	(1) Room thermistor (2) Heat exchanger thermistor
6	 10 times	<u>Over-current detection at the DC fan motor</u> when over-current is detected at the DC fan motor of the indoor unit.	(1) Indoor fan locked (2) Indoor fan motor (3) Indoor control P.W.B.
※1 7	 13 times	<u>IC401 or IC402 data reading error</u> When data read from IC401 or IC402 is incorrect.	IC401 or IC402 abnormal

(  -- Lights for 0.5 sec. at interval of 0.5 sec.)

#### <Cautions>

- (1) If the interface circuit is faulty when power is supplied, the self-diagnosis display will not be displayed.
- (2) If the indoor unit does not operate at all, check to see if the F-cable is connected or disconnected.
- (3) To check operation again when the timer lamp is blinking, you can use the remote control for operation (except for mode mark ※1).



# CHECKING INDOOR UNIT ELECTRICAL PARTS

## 1. Power does not come on (no operation)

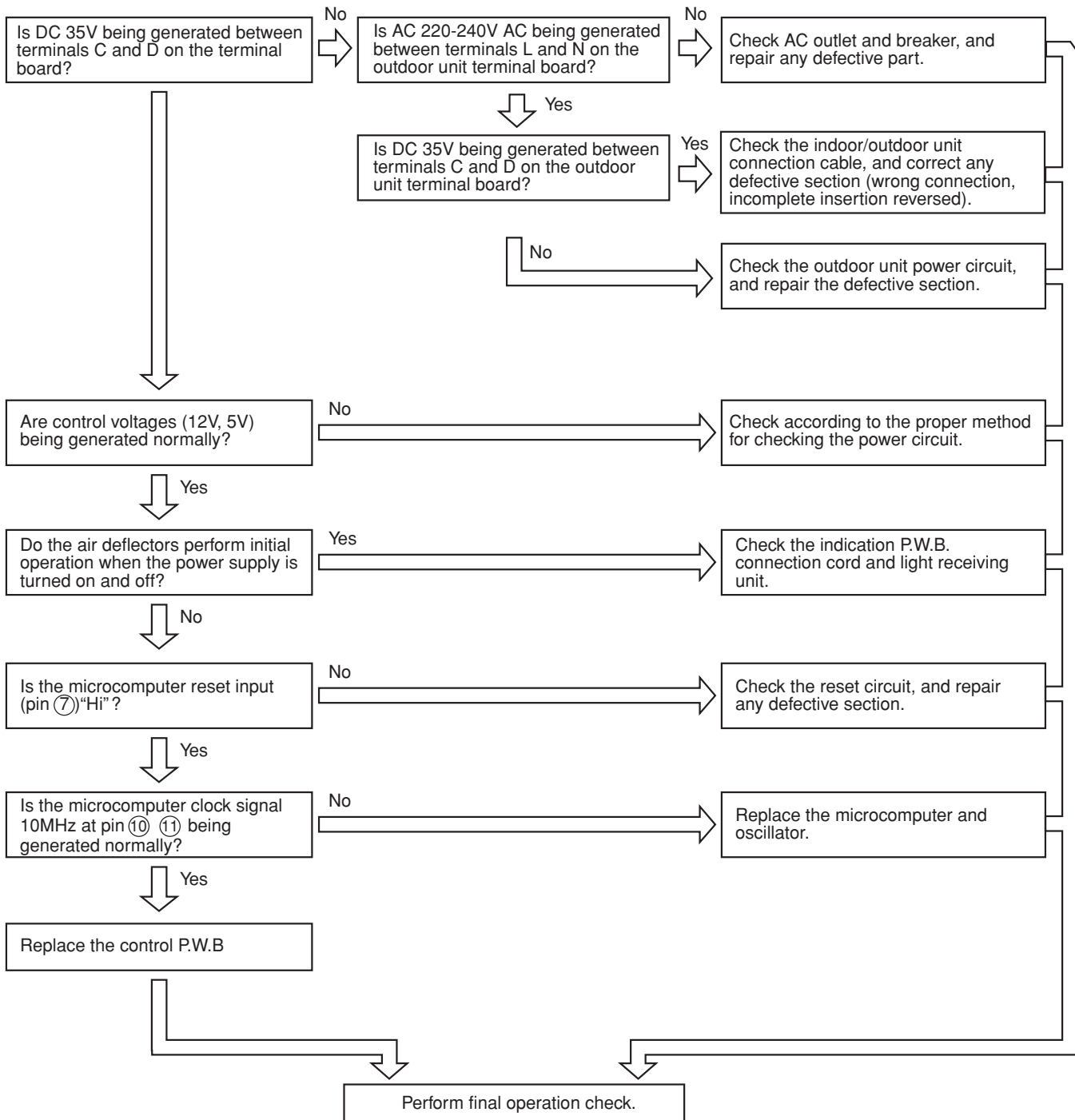



## 2. Outdoor unit does not operate (but receives remote infrared signal)

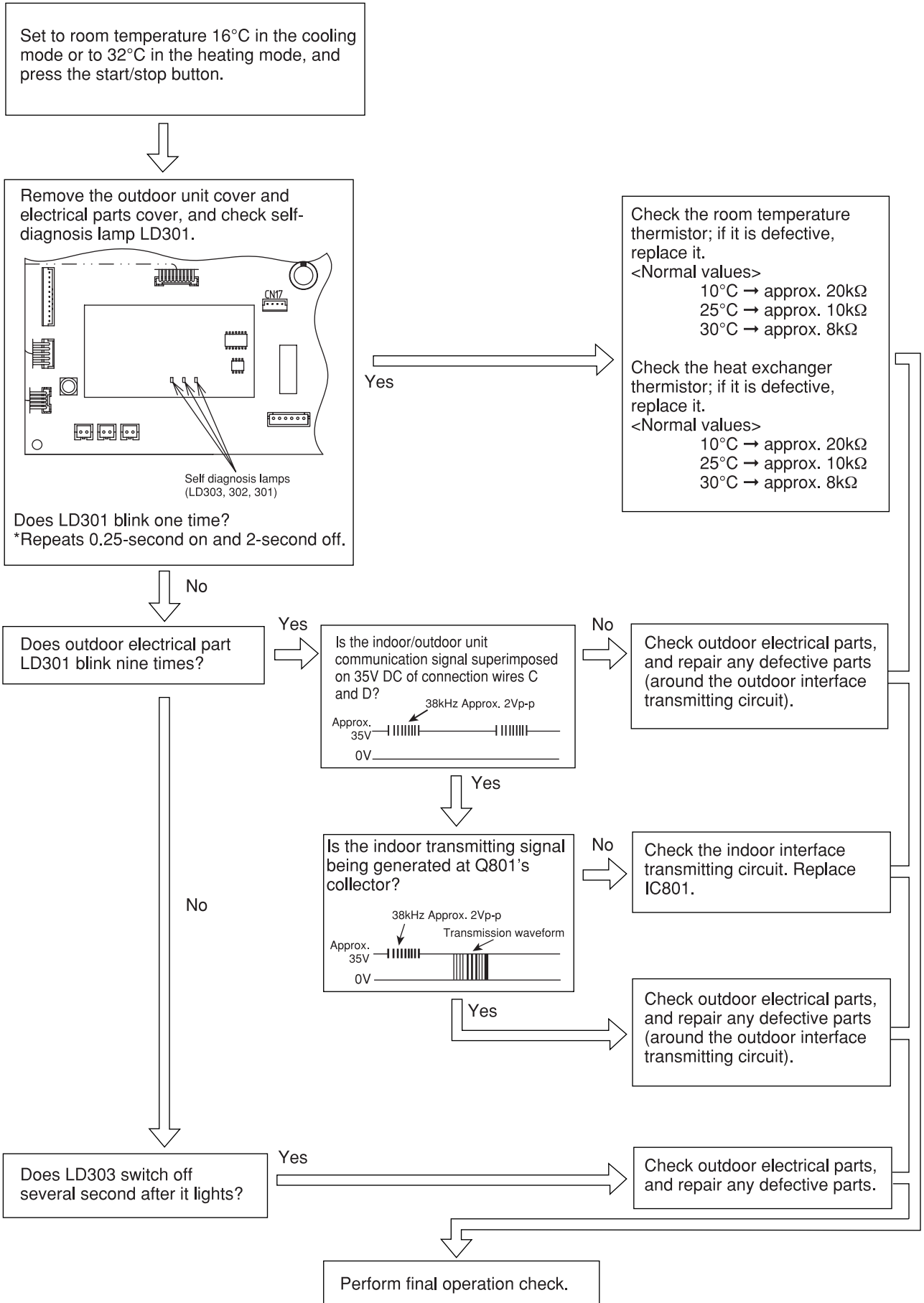

**3. Only indoor fan does not operate (other is normal)**

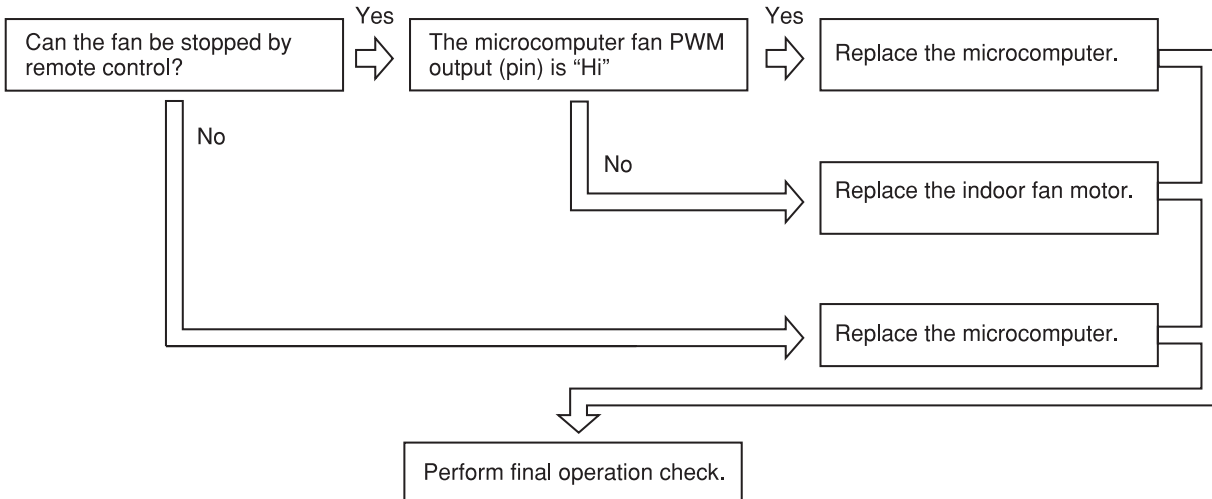

**4. Air deflector does not move (others are normal)**

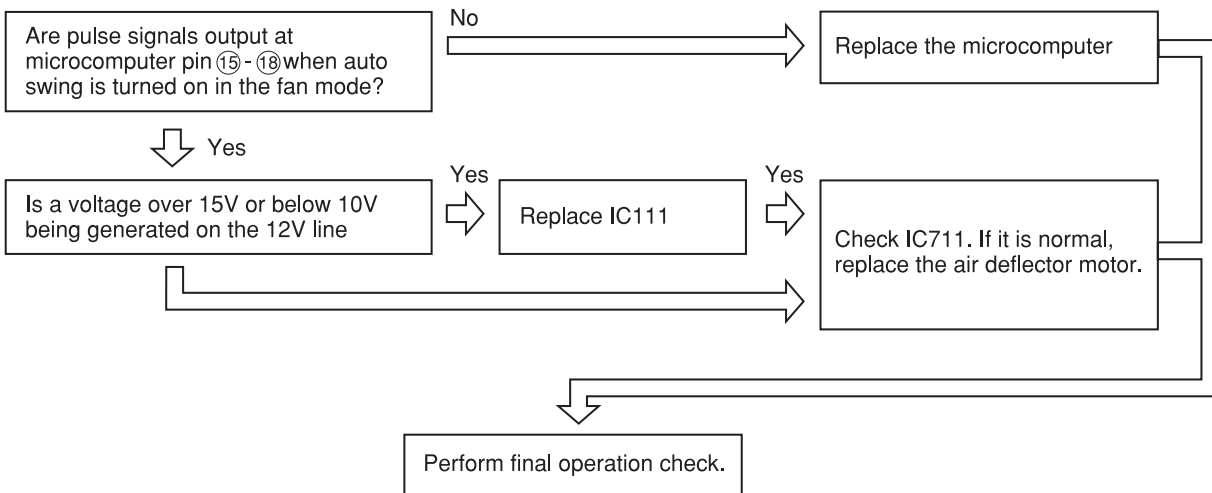

**5. All systems stop from several seconds to several minutes after operation is started (all indicators are also off)**

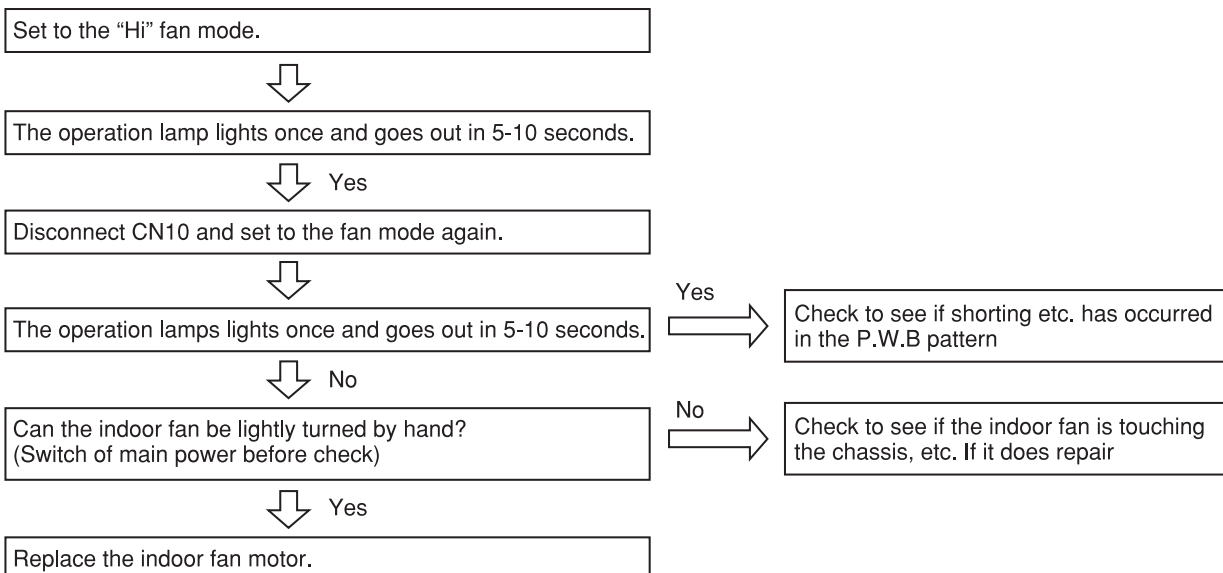

**6. Check the main P.W.B (power circuit)**

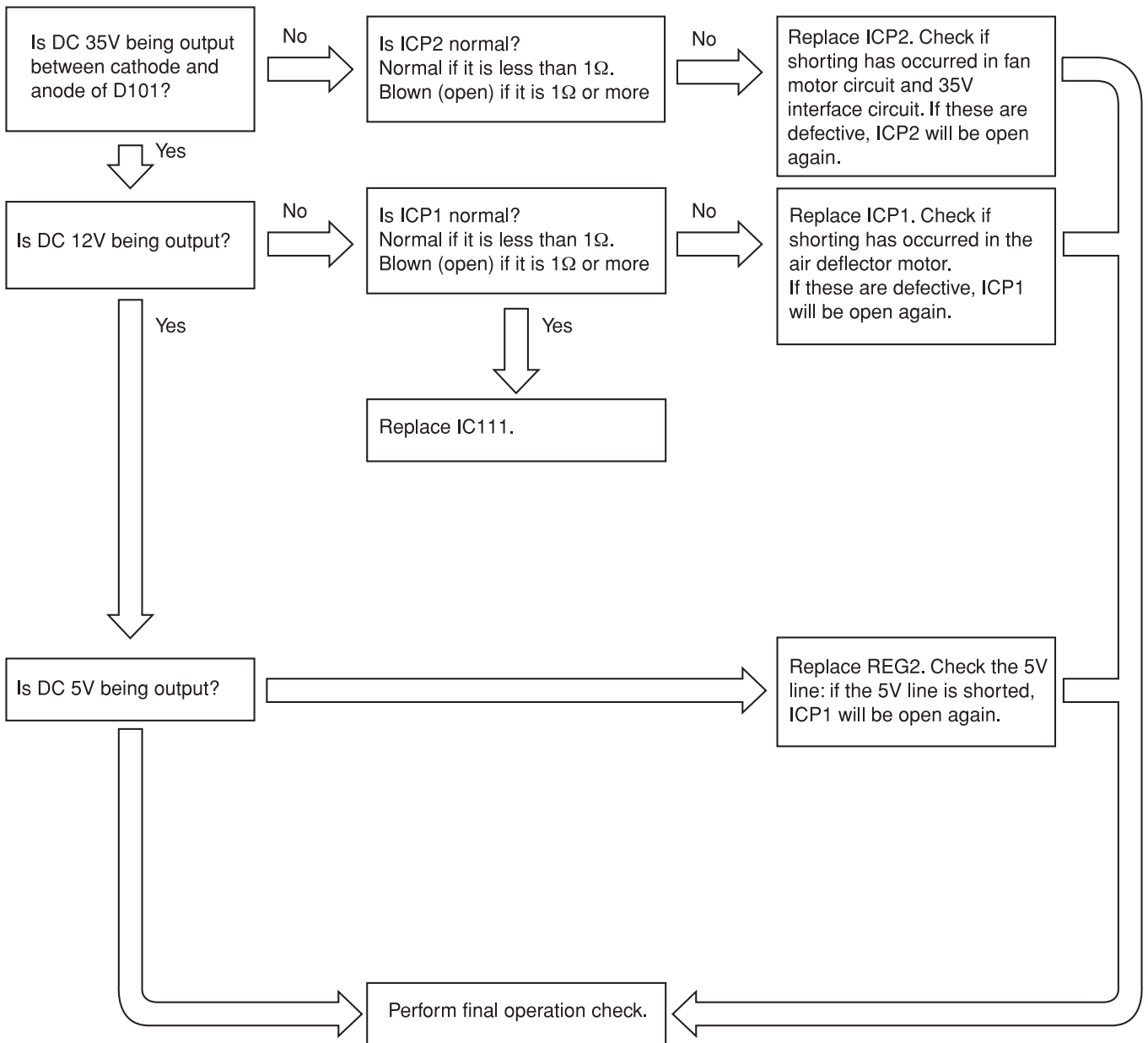

# CHECKING THE REMOTE CONTROLLER

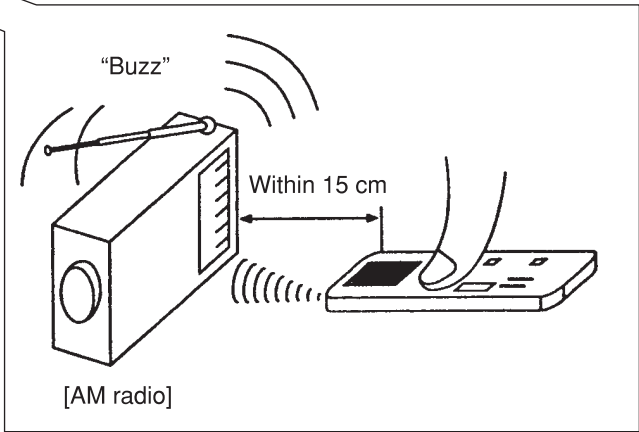
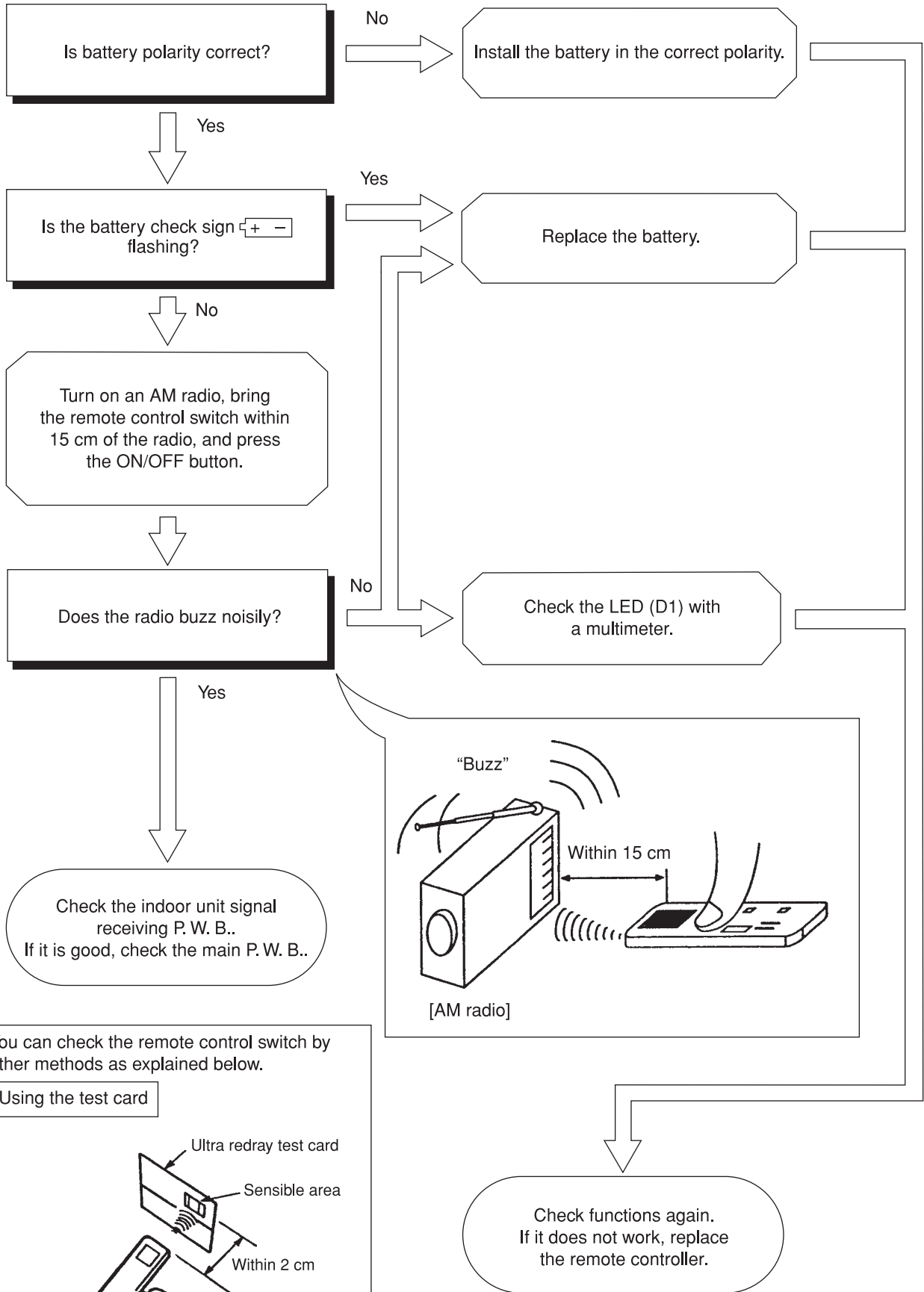

You can check the remote control switch by other methods as explained below.

## Using the test card

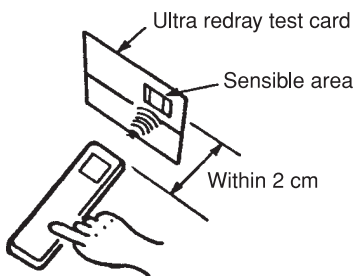

The sensible area should flash in orange when you operate the remote control unit if it is good.

# CHECKING THE OUTDOOR UNIT ELECTRICAL PARTS

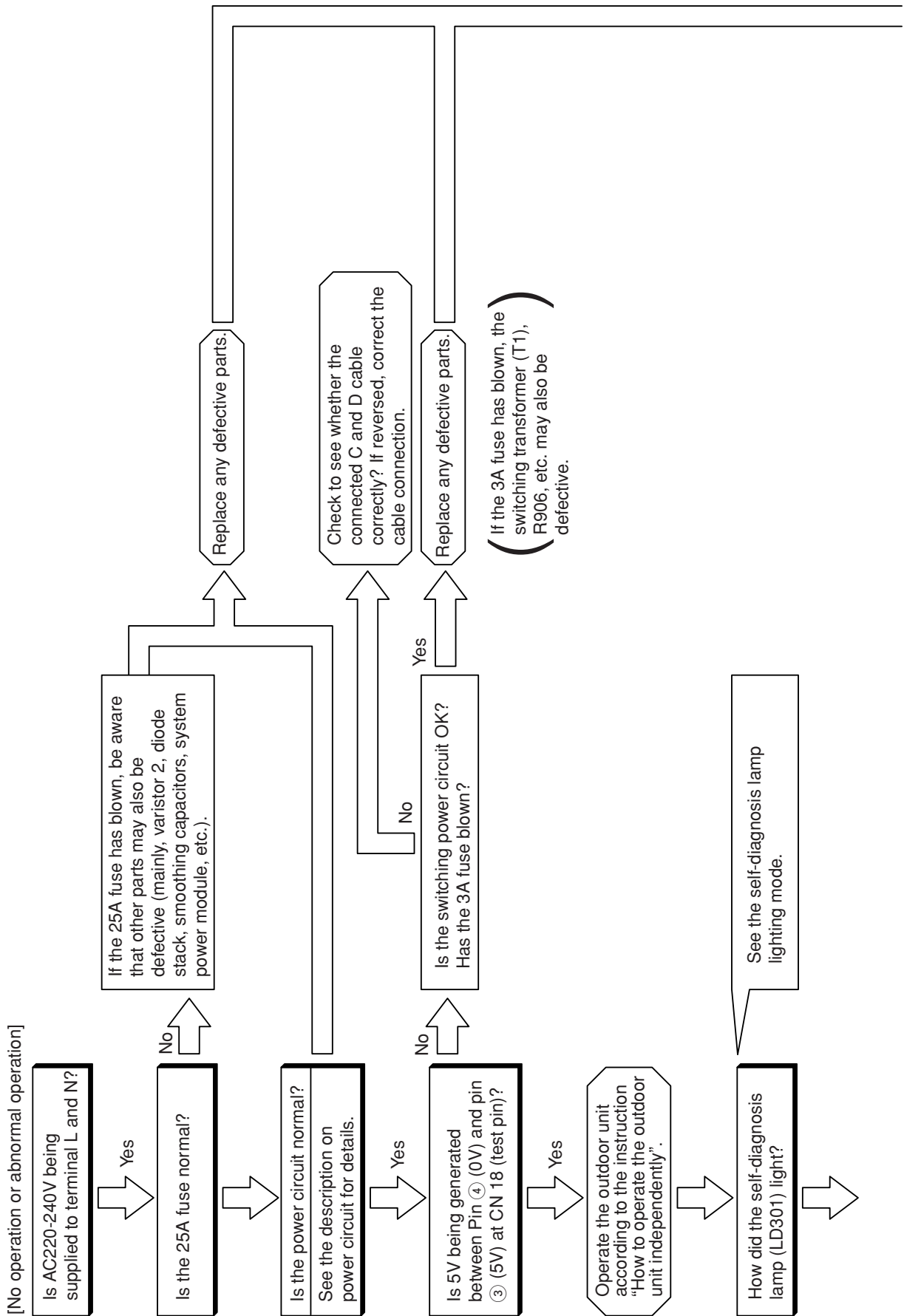

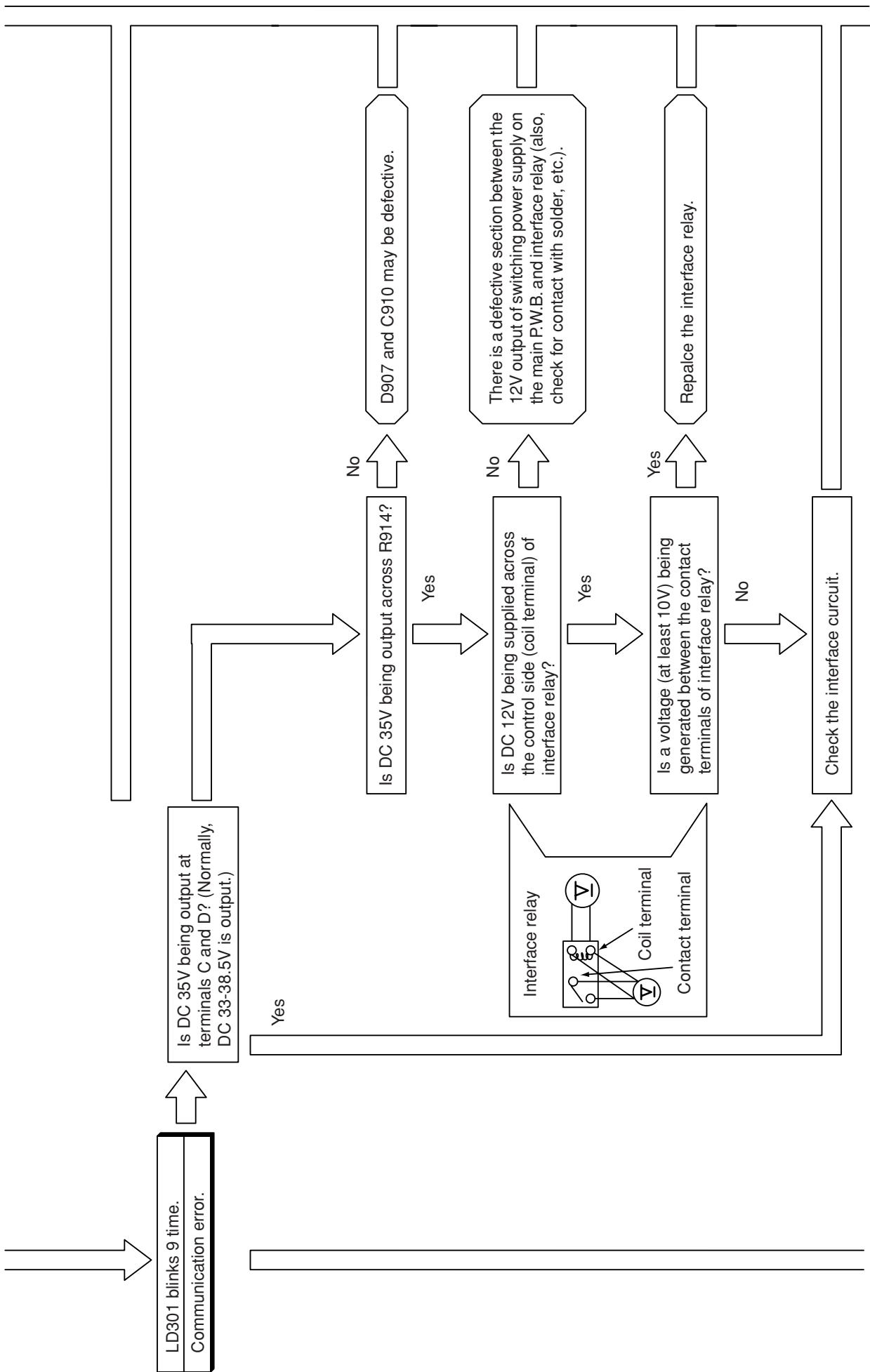

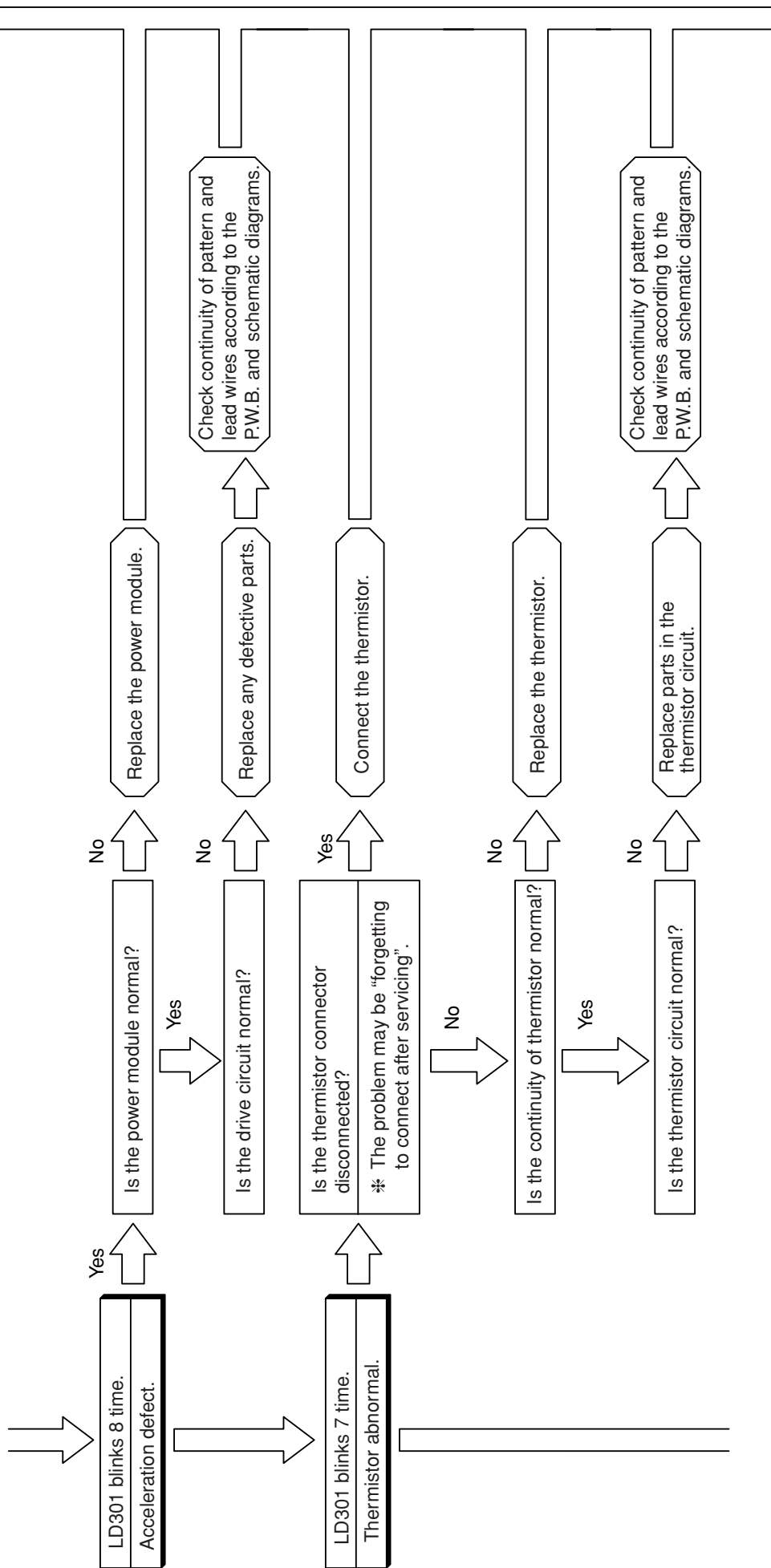

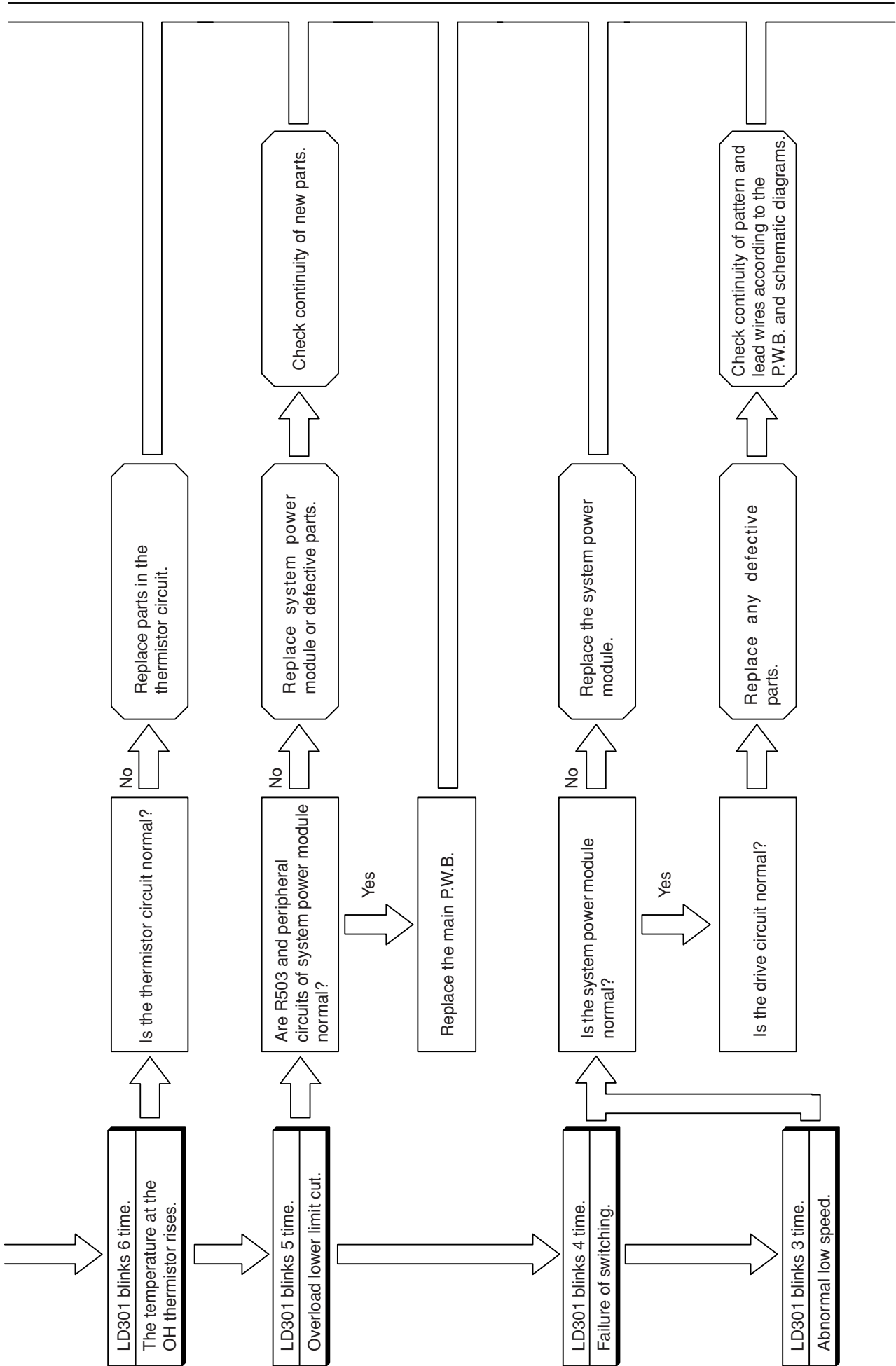



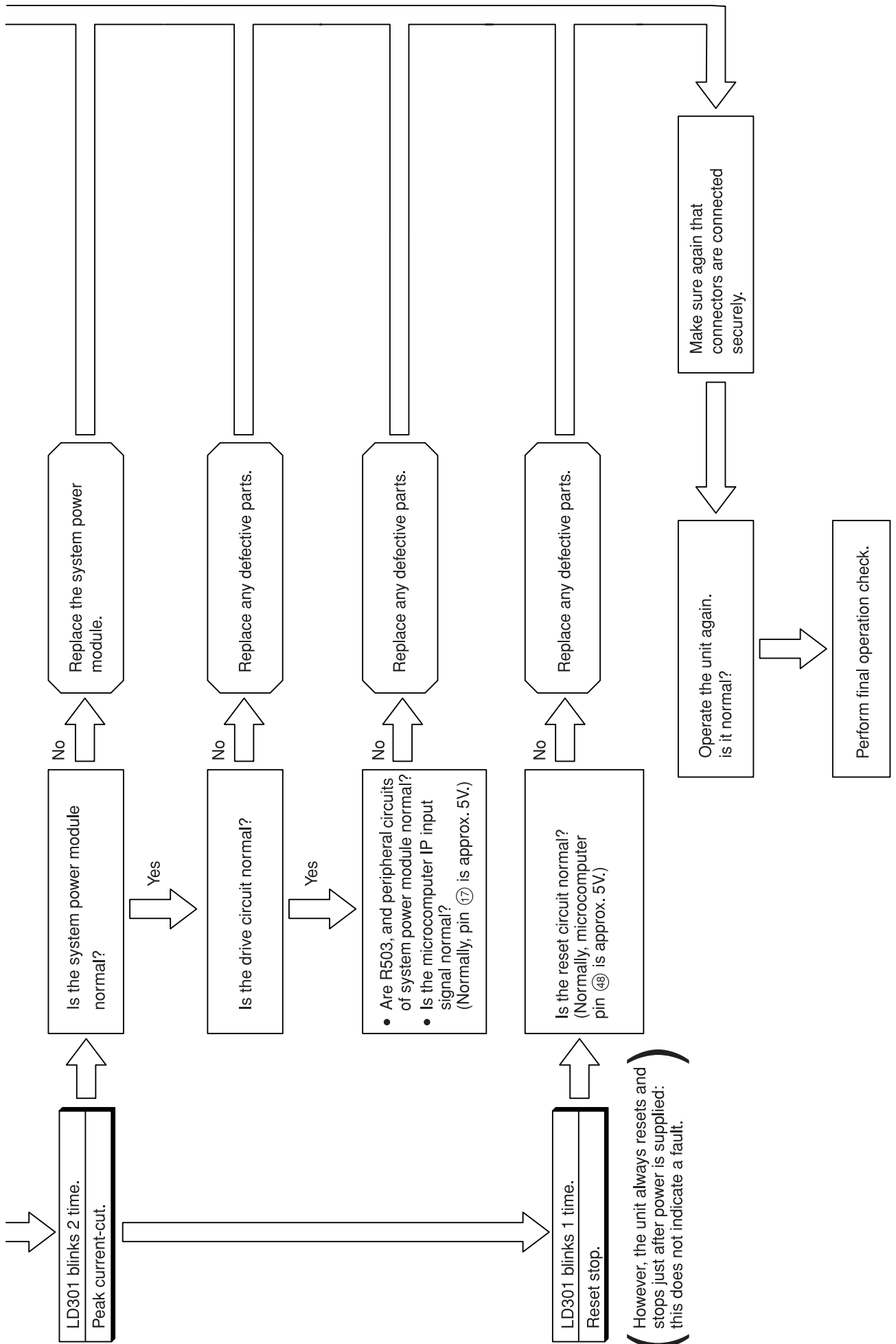

# POWER CIRCUIT

## Phenomenon 1 <Rotation speed does not increase>

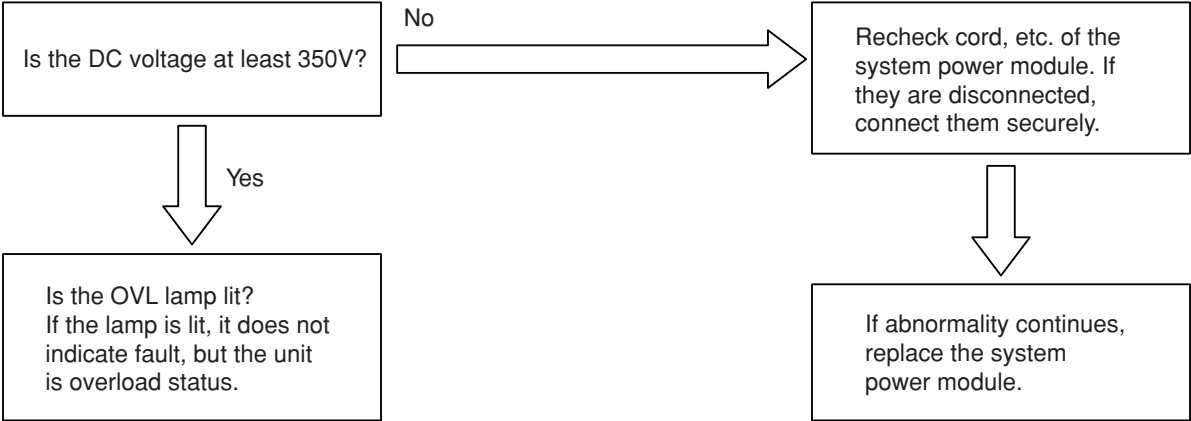

Overvoltage defect: system power module faulty (15-times blinking)

# CHECKING THE REFRIGERATING CYCLE

## (JUDGING BETWEEN GAS LEAKAGE AND COMPRESSOR DEFECTIVE)

### 1. Troubleshooting procedure (No operation, No heating, No cooling)

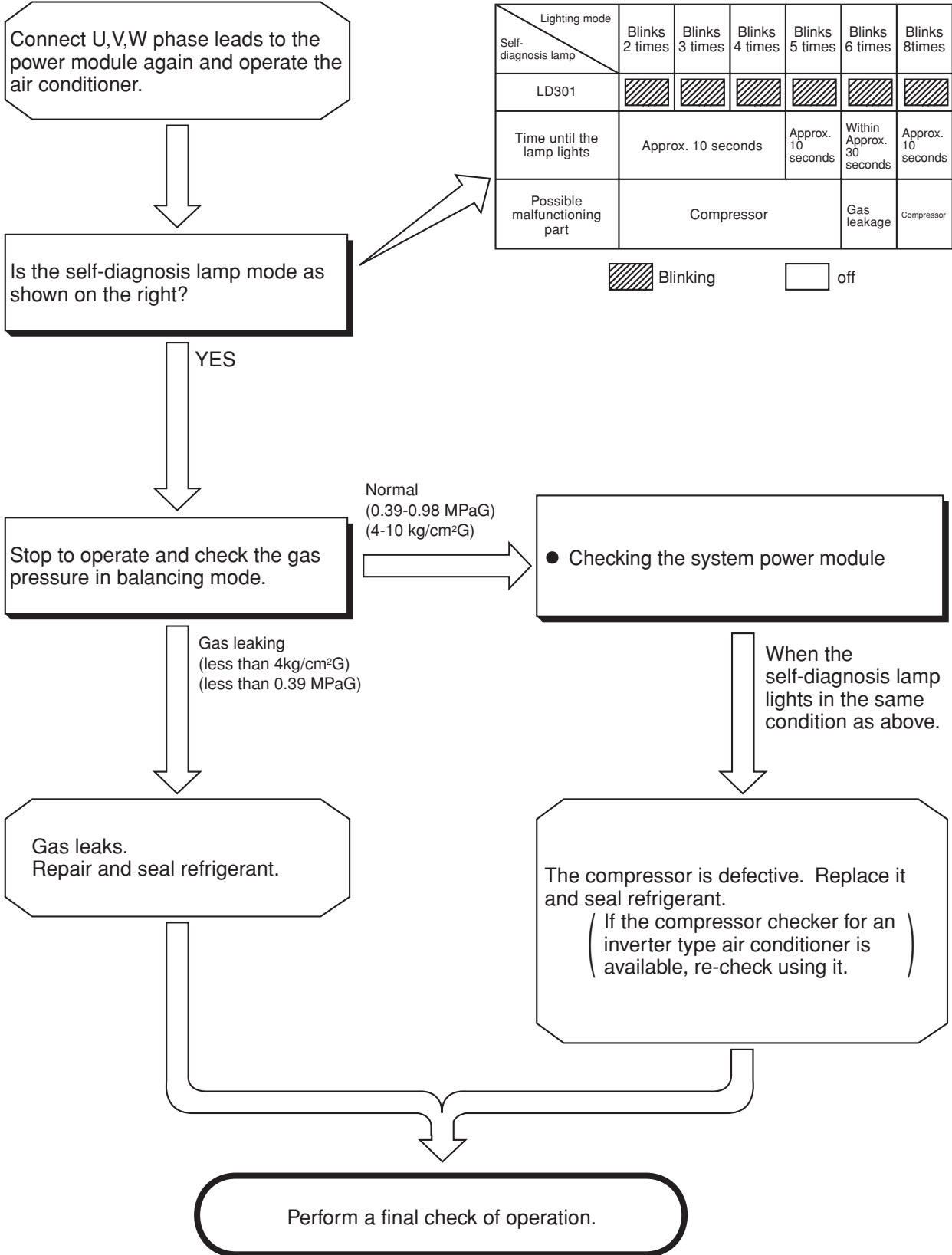

# HOW TO CHECK SYSTEM POWER MODULE

## Checking system power module using tester

Set tester to resistance range (X 100)

If indicator does not swing in the following conductivity check, the system power module is normal.

(In case of digital tester, since built-in battery is set in reverse direction, ⊕ and ⊖ terminals are reversed.)

### ⚠ CAUTION

If inner circuit of system power module is disconnected (open), the indicator of tester will not swing and this may assumed as normal. In this case, if indicator swings when ⊕ and ⊖ terminals are connected in reverse of diagram below, it is normal. Furthermore, compare how indicator swings at U, V and W phases. If indicator swings the same way at each point, it is normal.

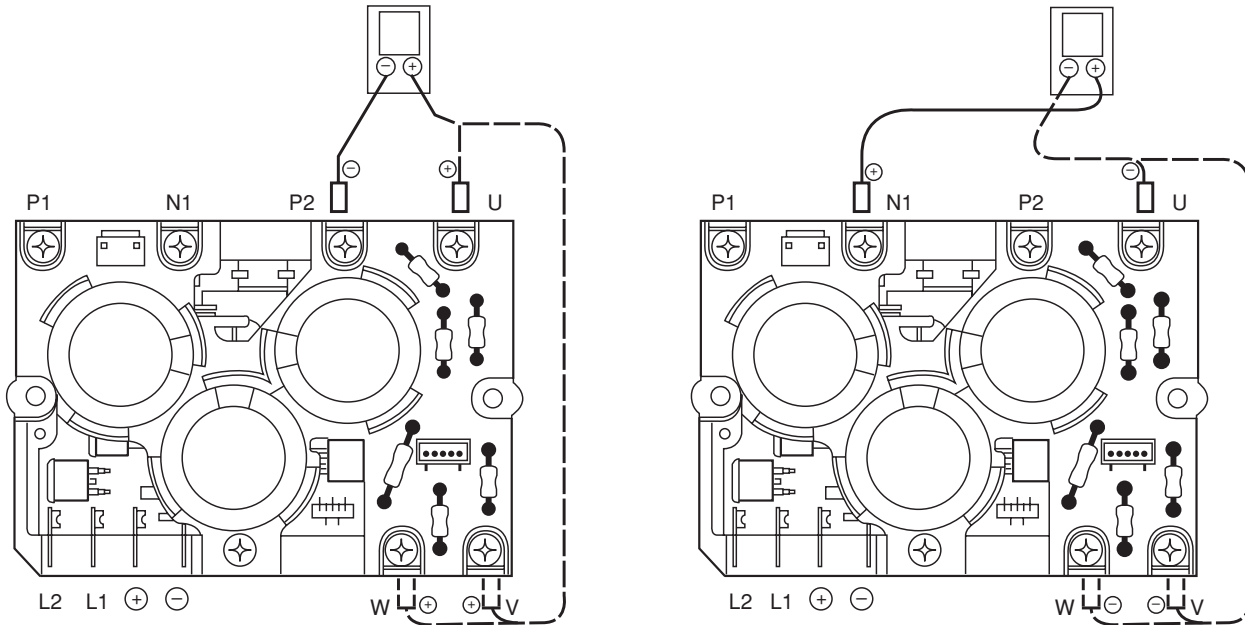

## HOW TO OPERATE USING THE SERVICE SWITCH THE OUTDOOR UNIT

1. Turn off the power supply to outdoor unit and then turn on again.
2. Remove the electrical box cover.

**LD303 (red) will light and the unit will operate in the forced cooling mode at this time.**

Never operate the unit for more than 5 minutes.

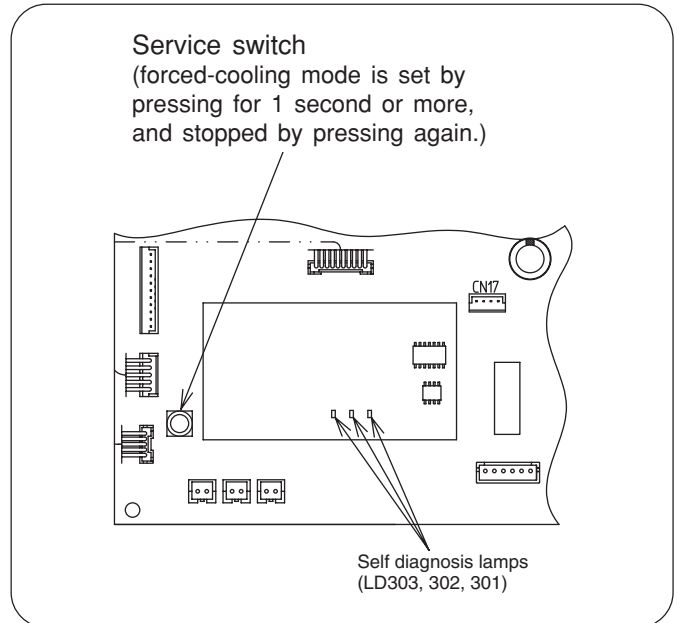
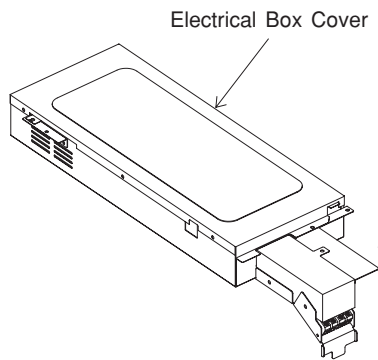

### (Cautions)

- (1) If interface signal (DC 35V) terminals C and D are not connected when the outdoor unit is in forced cool mode, the outdoor unit defect indicator (LD301) will blink 9 times during operation to indicate communication error.
- (2) If checking is done with the compressor connector disconnected, the unit will continue normal operation when the electrical parts are normal, or it will repeat operating for approx. one minute and stop due to overload power limit cut, or it will operate in the overload status.

Be sure to push the service switch again to stop the forced cool operation.

## HOW TO OPERATE THE OUTDOOR UNIT INDEPENDENTLY

1. Connect the large dia. pipe side and small dia. pipe side service valves using a pipe.

Connect the small diameter service valve and the large diameter service valve using the reducing union and copper pipe as shown on the right.

Charge refrigerant of 300g after vacuuming (※ 1)

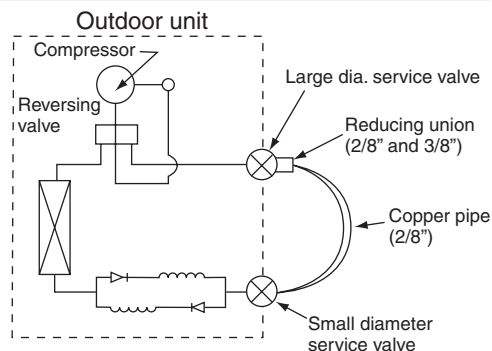

### Parts to be prepared

- (1) Reducing union  
2/8" (6.35mm)  
1/2" (12.7mm)
- (2) Copper pipe (2/8" and 1/2")

**Do not operate for more than 5 minutes**

The operation method is the same as "How to operate using the connector to servicing the outdoor unit".

※ 1 The charging amount of 300g is equivalent to the load in normal operation.

# SYSTEM POWER MODULE DIAGNOSIS

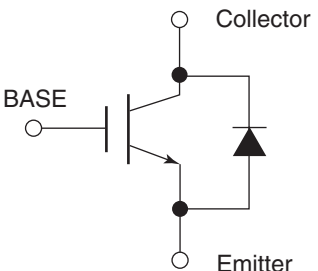
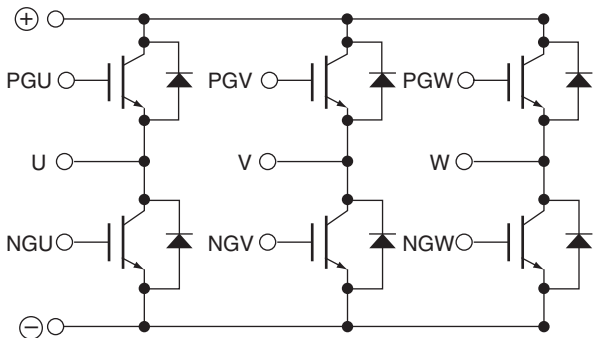
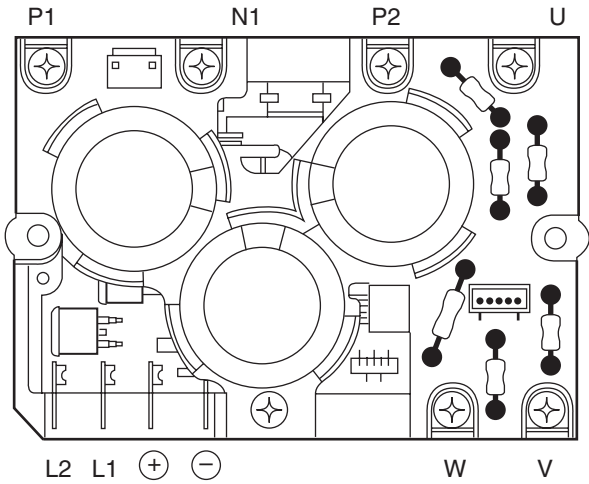
<p>Circuit diagram of the device (excepting the reflux diode)</p>	
<p>Circuit diagram of the module</p>	
<p>Terminals symbol mark of the module</p> <p>※ See next page for measuring value using tester</p>	

# PARTS LIST AND DIAGRAM

## INDOOR UNIT

MODEL : RAS-60YH5

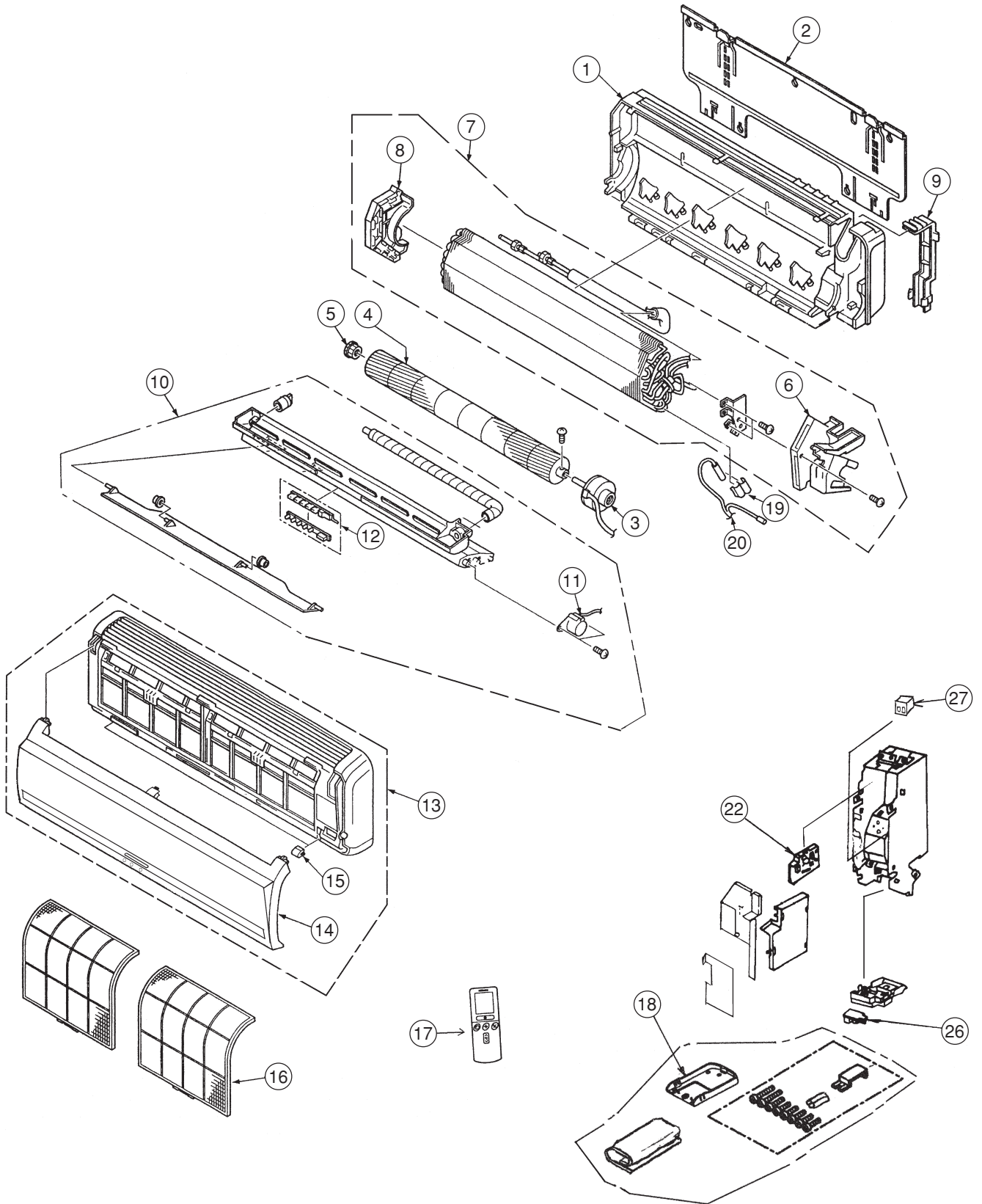





# PARTS LIST AND DIAGRAM

## OUTDOOR UNIT MODEL : RAC-60YH5

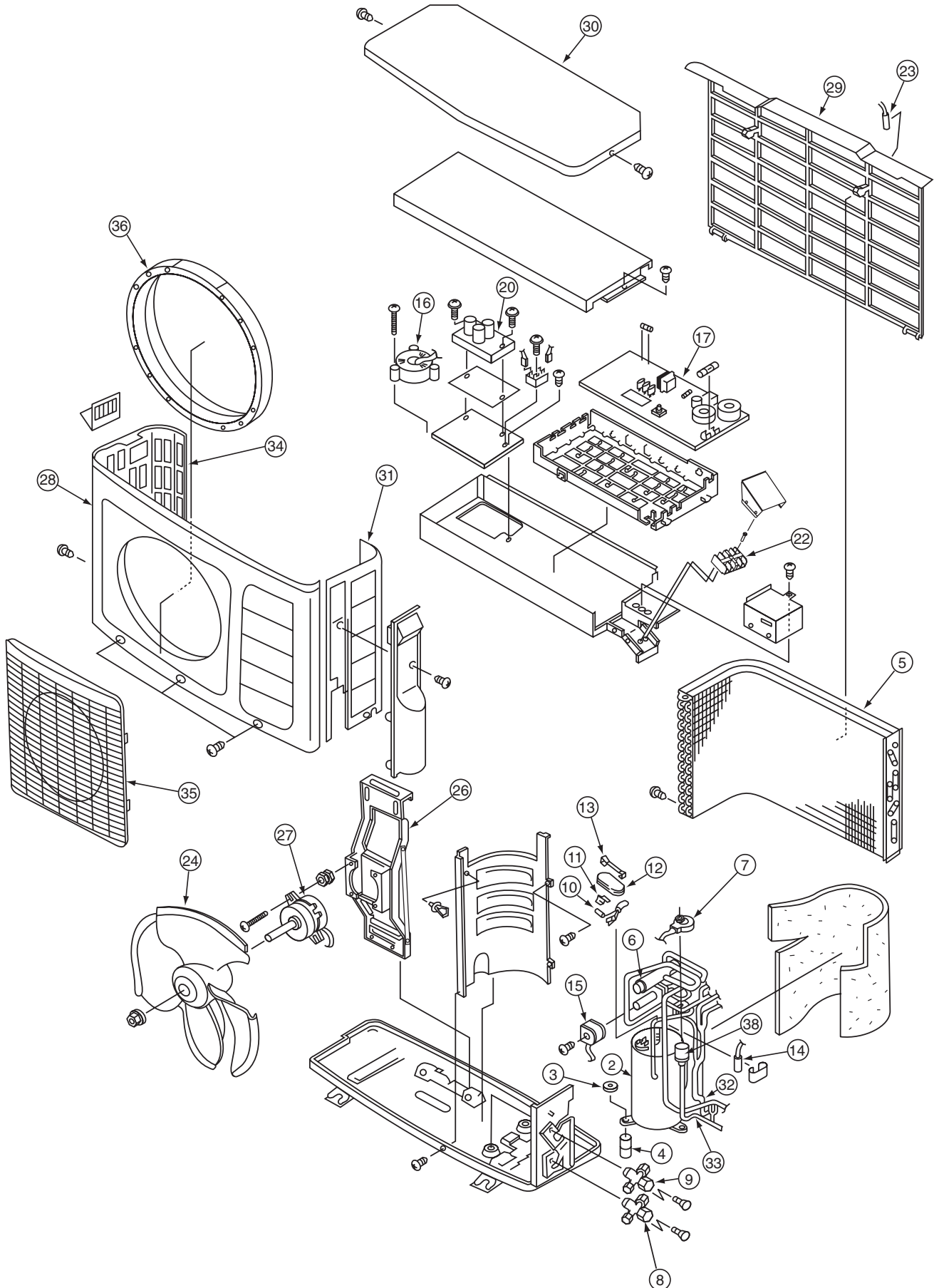

**MODEL RAC-60YH5**

<b>NO.</b>	<b>PART NO. RAC-60YH5</b>	<b>Q'TY / UNIT</b>	<b>PARTS NAME</b>
2	PMRAC-60YHA 902	1	COMPRESSOR
3	KPNT1 001	4	PUSH NUT
4	RAC-2226HV 805	3	COMPRESSOR RUBBER
5	PMRAC-50NH4 902	1	CONDENSER
6	PMRAM-22NHZ4 901	1	REVERSING VALVE
7	PMRAC-25NH4 903	1	ELECTRICAL EXPANSION COIL
8	PMRAC-50NH4 903	1	VALVE (2S)
9	PMRAC-50NH4 904	1	VALVE (4S)
10	PMRAC-40CNH2 914	1	THERMISTOR (OH)
11	PMRAC-25NH4 909	1	OVERHEAT THERMISTOR SUPPORT
12	PMRAC-25NH4 910	1	OVERLOAD RELAY COVER
14	PMRAC-40CNH2 915	1	THERMISTOR (DEFROST)
15	PMRAM-40QH5 907	1	COIL (REVERSING VALVE)
16	PMRAC-18SH4 901	1	REACTOR
17	PMRAC-S24H2 901	1	P.W.B (MAIN)
20	PMRAC-40CNH2 901	1	SYSTEM POWER MODULE
22	PMRAC-51CHA1 903	2	TERMINAL BOARD (4P)
23	PMRAC-19SH4 901	1	THERMISTOR (OUTSIDE TEMPERATURE)
24	PMRAC-40CNH2 917	1	PROPELLER FAN
26	PMRAC-40CNH2 918	1	SUPPORT (FAN MOTOR)
27	PMRAC-40CNH2 919	1	FAN MOTOR (40W)
28	PMRAC-40CNH2 904	1	CABINET
29	PMRAC-40CNH2 921	1	NET
30	PMRAC-40CNH2 922	1	TOP COVER
31	PMRAC-60YHA 901	1	SIDE PLATE-R
32	PMRAC-50NH4 906	1	STRAINER (PIPE)
33	PMRAC-50NH4 909	1	STRAINER (COND)
34	PMRAC-40CNH2 926	1	SIDE PLATE-L
35	PMRAC-40CNH2 928	1	GRILL
36	PMRAC-40CNH2 920	1	MOUTH RING
38	PMRAC-25NH4 916	1	EXPANSION VALVE

# HITACHI

**RAS-60YH5**  
**RAC-60YH5**

**PM NO. 0299E**

Printed in Malaysia