



Domestic Air conditioner

TECHNICAL DATA

ON/OFF

Wall mounted Type ARC-Series

HSU-09H03/Z1
HSU-12H03/Z1



CAUTION

1. READ THIS MANUAL CAREFULLY TO
DIAGNOSE TROUBLE CORRECTLY
BEFORE OFFERING SERVICE.
2. THIS MANUAL IS USED BY QUALIFIED
APPLIANCE TECHNICIANS ONLY.
3. HAIER DOES NOT ASSUME ANY
RESPONSIBILITY FOR PROPERTY
DAMAGE OR PERSONAL INJURY FOR
IMPROPER
SERVICE PROCEDURES DONE BY ONE
UNQUALIFIED PERSON.

Table of Contents

1. Features	2
2. Specifications	3
3. Remote controller lists	6
4. Sensors lists	6
5. Dimensional drawings	7
6. Operation range	9
7. Piping diagrams	10
8. Wiring diagrams	11
9. Capacity diagrams and curves diagrams	13
10. Sound level	17
11. Accessories	19
12. Control systems	20
13. Center of gravity	22
14. Installations	23

1 Features



Anti-mold filter: Catches most small particles and remove unpleasant odors effectively .



Child lock: Avoid the child's wrong operation on the remote controller .



Auto mode: According to the fixed temperature "26C",the unit will adjust the operation mode automatically.



Auto restart: The function permits automatic return to previous peration conditions after asudden power blackout .



Sleep mode: The setting temperature and the indoor noise can be adjusted to a more comfortable level when you set the "sleep mode"during night sleep .



24Hour timer: Use the timer function to set on,or off,or from on to off,or from off to on .



4 Fan setting: Slect the fan speed LO,MED,HI,AUTO



Easy clean design: The panel is easy to wash and the airflow vents can be detached without any special tools for quick cleaning of the inside of the air conditioner .

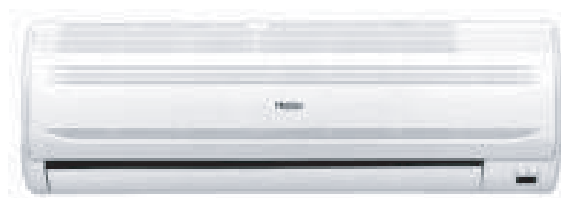

2.Specifications

This information was not available at the time of publication

NOMINAL CAPACITY and NOMINAL INPUT					
Model				HSU-09H03/Z1	HSU-12H03/Z1
NOMINAL CAPACITY(3-4)	Cooling(1)	norm.	kw	2.30	3.20
	Heating(2)	norm.	kw	2.60	3.60
NOMINAL INPUT	Cooling	norm	kw	0.83	1.18
	Heating	norm.	kw	0.78	1.18
EER	Cooling			2.77	2.80
COP	Heating			3.33	2.71
ENERGY LABEL(7-8)	Cooling			----	----
	Heating			----	----
ANNUAL ENERGY CONSUMPTION(9)	Cooling		kwh	396.5	530

TECHNICAL SPECIFICATIONS					
INDOOR UNITS				HSU-09H03/Z1	HSU-12H03/Z1
DIMENSIONS	Unit	H	mm	265	
		W	mm	795	
		D	mm	182	
WEIGHT	Unit		kg	7.2	
COLOR	Unit			white	
SOUND LEVEL	Sound pressure (cooling/heating)(5)	high	dB(A)	37	39
		medium	dB(A)	35	37
		low	dB(A)	30	30
	Sound power(cooling/heating)(6)	high	dB(A)	37	39
FAN	Air flow rate(cooling/heating)	high	m ³ /min	7.8/9.0	9.7/10.7
		low	m ³ /min	7.0/8.0	9.0/9.6
		super low	m ³ /min	6.2/7.0	8.2/8.7
	Speed(cooling/heating)	steps		5steps,silent and auto	
		high	rpm	1150	1290
		medium	rpm	1100	1150
		low	rpm	920	1000
Type	Cross flow fan				
Motor output		W	16	16	
AIR FILTER	Removable/washable/mildew proof				
REMOTE CONTROLLER	YL-M05EN				
TEMPERATURE CONTROL	Microcomputer control				
PIPING CONNECTIONS(external diameter)	liquid	mm	Φ 6.35	Φ 6.35	
	gas	mm	Φ 9.52	Φ 12.7	
	drain	mm	Φ 16	Φ 16	
INSULATION MATERIAL	Heat insulation type			both liquid and gas pipes	
HEAT EXCHANGGER	TYPE			ML fin - Φ 9.52HI - XA tube	
	Row x stage x fin pinth			mm	2 x 8 x1.4

TECHNICAL SPECIFICATIONS					
OUTDOOR UNITS			HSU-09H03/Z1	HSU-12H03/Z1	
NET DIMENSIONS (stop valve, and bottom support is not included)	Unit	H	mm	430	
		W	mm	695	
		D	mm	245	
WEIGHT	Unit		kg	31	33
COLOR	Unit	white			
SOUND LEVEL	Sound pressure(cooling/heating)(5)	high	dB(A)	48	48
	Sound power(cooling/heating)(6)	high	dB(A)	48	48
FAN	Air flow rate(cooling/heating)	high	m ³ /min	21	23
		low	m ³ /min	---	---
	Speed(cooling/heating)	high	rpm	860	1060
		low	rpm	---	---
	Type	Propeller fan			
	Motor output		W	80	80
REFRIGERANT CIRCUIT	Refrigerant type	R22			
	Refrigerant charge		kg	0.54	0.78
	Maximum allowable distance between indoor and outdoor		m	7	
	Maximum allowable level difference		m	5	
	Refrigerant control	-----			
COMPRESSOR	Type	rotary Compressor			
	Model			44R233CF-5JS	RH220VHLC
	Motor output		w	790	970
	Oil type			SUNISO 4GSI	SUNISO 4GSI
	Oil charge volume		L	0.27	0.52
PIPING CONNECTIONS	liquid		mm	Φ 6.35	
	gas		mm	Φ 9.52/ Φ12.7	
	drain		mm	Φ 18	
INSULATION MATERIAL	Heat insulation type			both liquid and gas pipes	
HEAT EXCHANGGER	TYPE				ML - Φ9.52HI - XAbube
	Row x stage x fin pinth		mm	2 x 8 x1.4	

ELECTRICAL SPECIFICATIONS					
For indoor units only:				HSU-09H03/Z1	HSU-12H03/Z1
CURRENT	Nominal running current	cooling	A	0.15	0.15
		heating	A	0.15	0.15
	Maximum running current	cooling	A	0.15	0.15
		heating	A	0.15	0.15

For combination indoor units+ outdoor units:				HSU-09H03/Z1	HSU-12H03/Z1
CURRENT	Nominal running current	cooling	A	3.9	5.6
		heating	A	3.7	5.6
	Maximum running current	cooling	A	5.0	7.3
		heating	A	5.8	7.3
	Starting current	cooling	A	32	45
		heating	A	32	45

For indoor units only:				HSU-09H03/Z1	HSU-12H03/Z1
POWER SUPPLY				VM	VM
NOMINAL DISTRIBUTION SYSTEM VOLTAGE	Phase			1PH	1PH
	Frequency	Hz		50	50
	Voltage	V		220V~	220V~

NOTES

- 1 Nominal cooling capacities are based on: indoor temperature 27°CDB/19°CWB * outdoor temperature 35°CDB * refrigerant piping length: 5m * level difference: 0m.
- 2 Nominal heating capacities are based on: indoor temperature 20°CDB * outdoor temperature 7°CDB/6°CWB * refrigerant piping length 5m (horizontal) * level difference 0m.
- 3 Capacities are net, including a deduction for cooling (an addition for heating) for indoor fan motor heat.
- 4 Units should be selected on nominal capacity. Maximum capacity is limited to peak periods.
- 5 The sound pressure level is measured via a microphone at a certain distance from the unit. For measuring conditions: please refer to item 6 of this chapter.
- 6 The sound power level is an absolute value indicating the "power" which a sound source generates.
- 7 Energy label: scale from A (most efficient) to G (less efficient).
- 8 The energy label Directive 2002/31/EC will enter into force once the relevant measurement standard will be published in the European official Standard.
- 9 Annual energy consumption: based on average use of 500 running hours per year at full load (= nominal conditions)

3 Remote controller lists

Model	HSU-09H03/Z1	HSU-12H03/Z1
YR-M05	Y	Y
YR-H10	Y	Y

4 Sensors lists

INDOOR UNIT		
type	Description	Qty
Room sensor	It's used for detecting room temperature	1
Pipe sensor	It's used for detecting temperature of evaporator	1

5 Dimensional drawings

Indoor unit

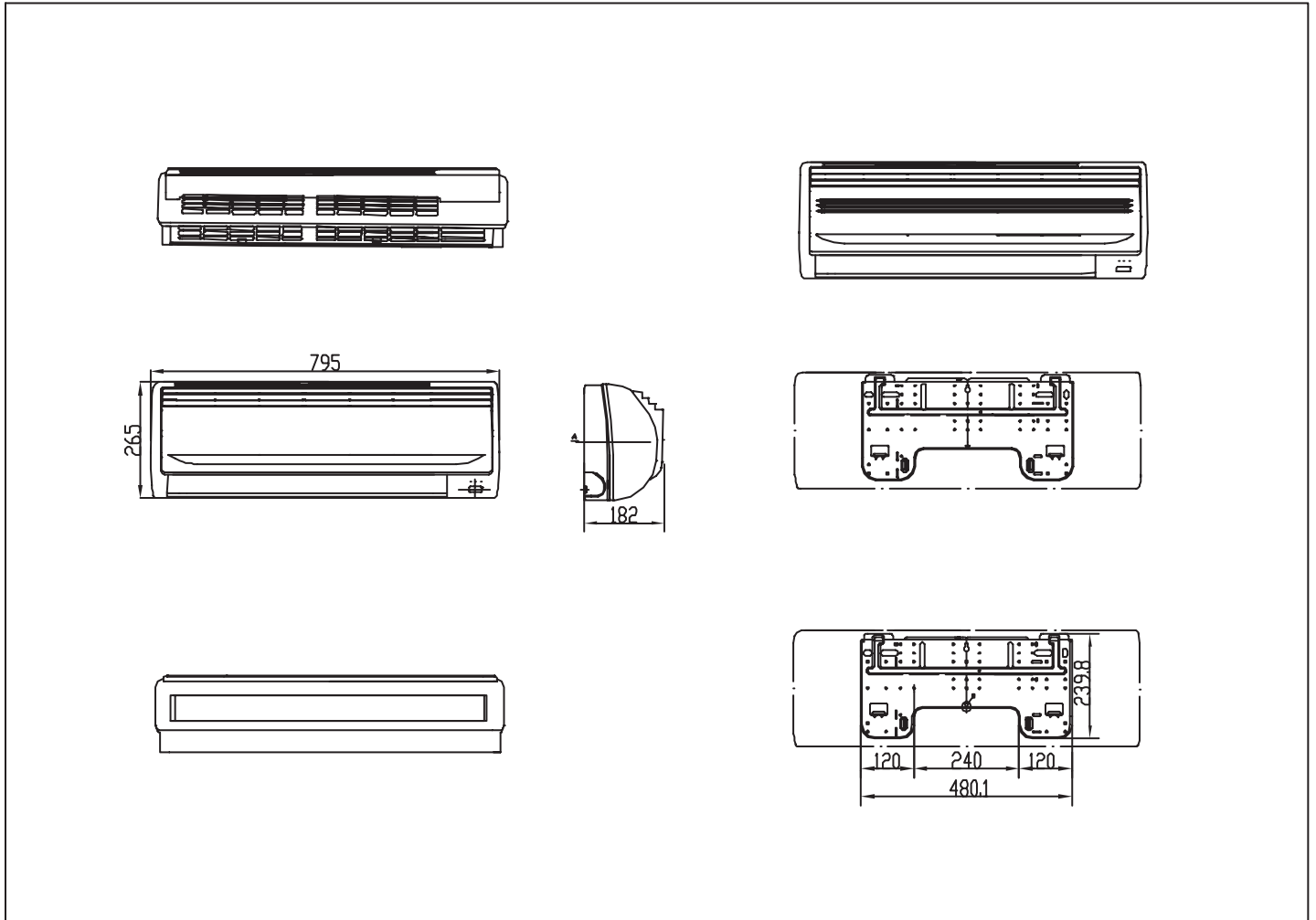

Outdoor unit

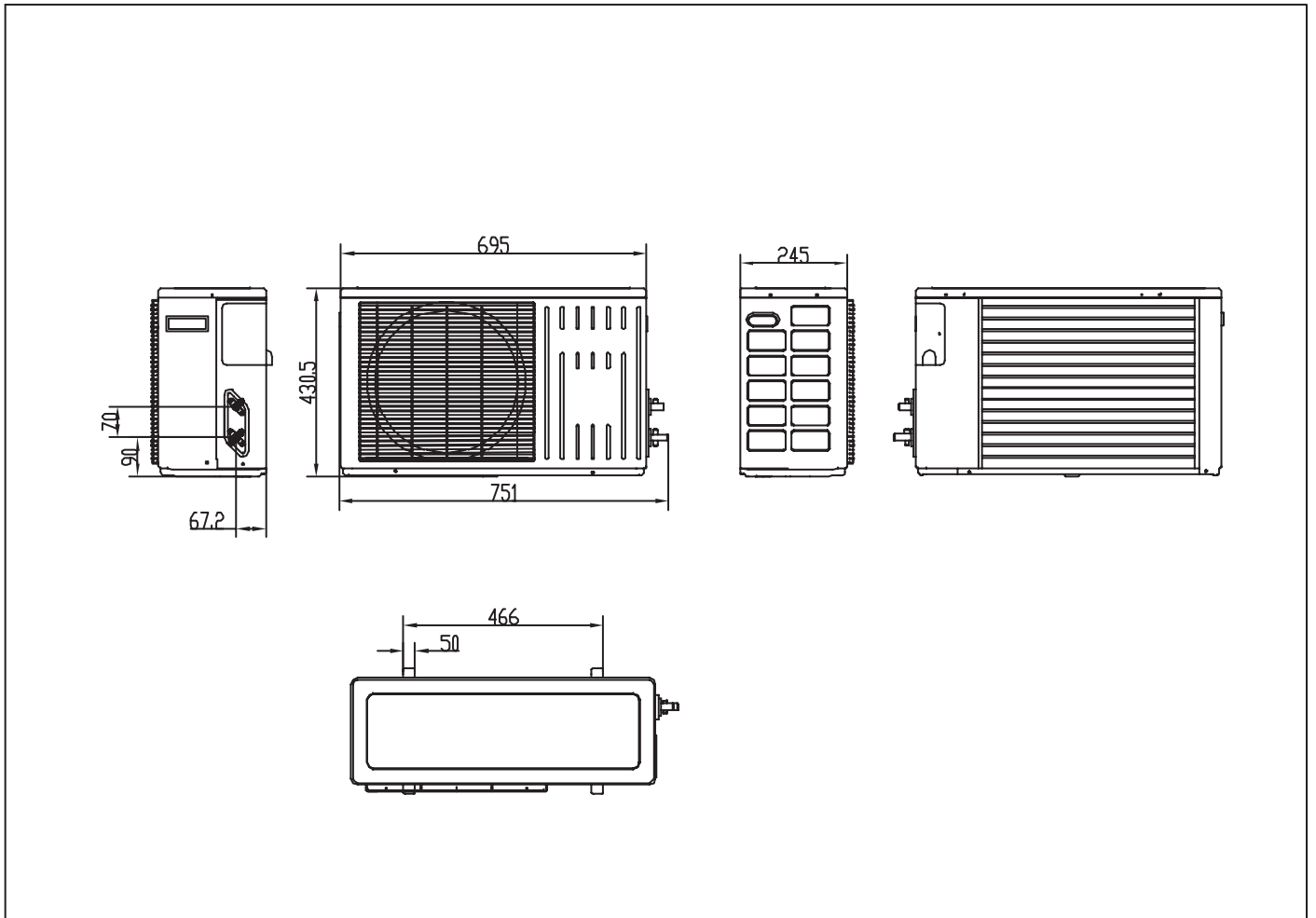

6 Operation range

The name of parts

Cooling

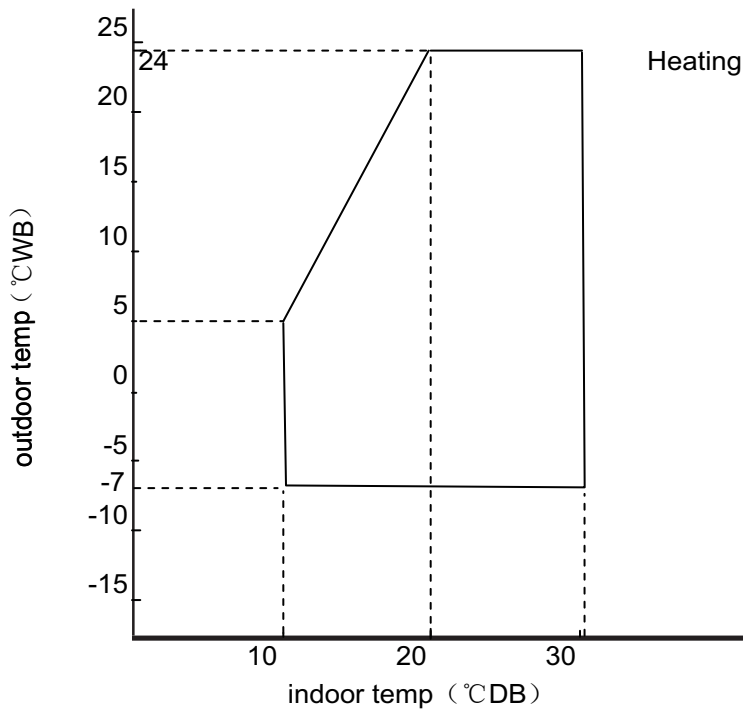
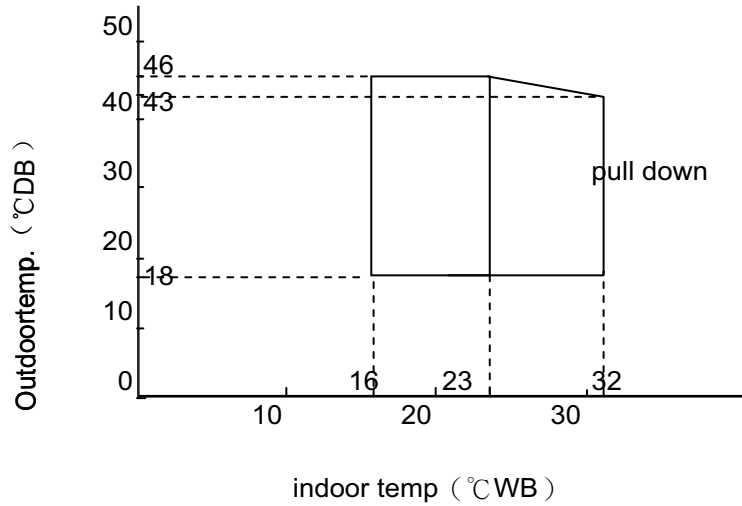

Notes:

The graphs are based on the following condition:
 Equivalent piping length 7.5m
 Level difference 0m
 Air flow rate high

7 Piping diagrams

Cooling mode

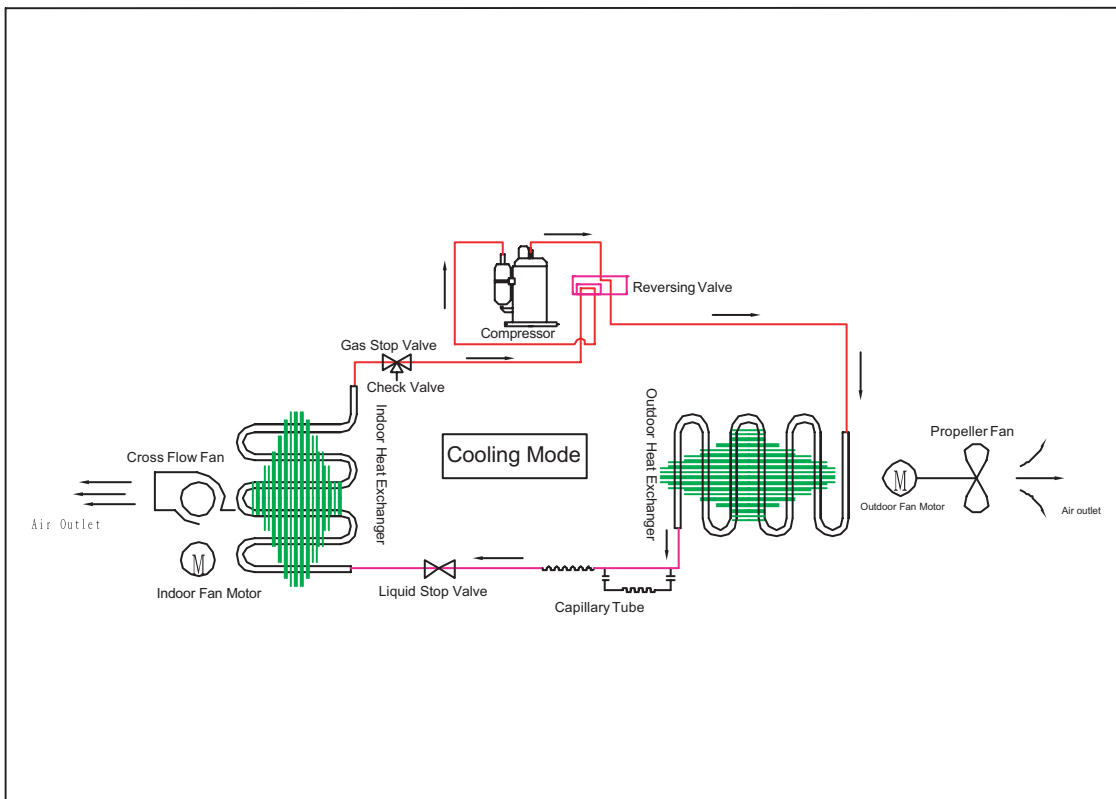

Heating mode

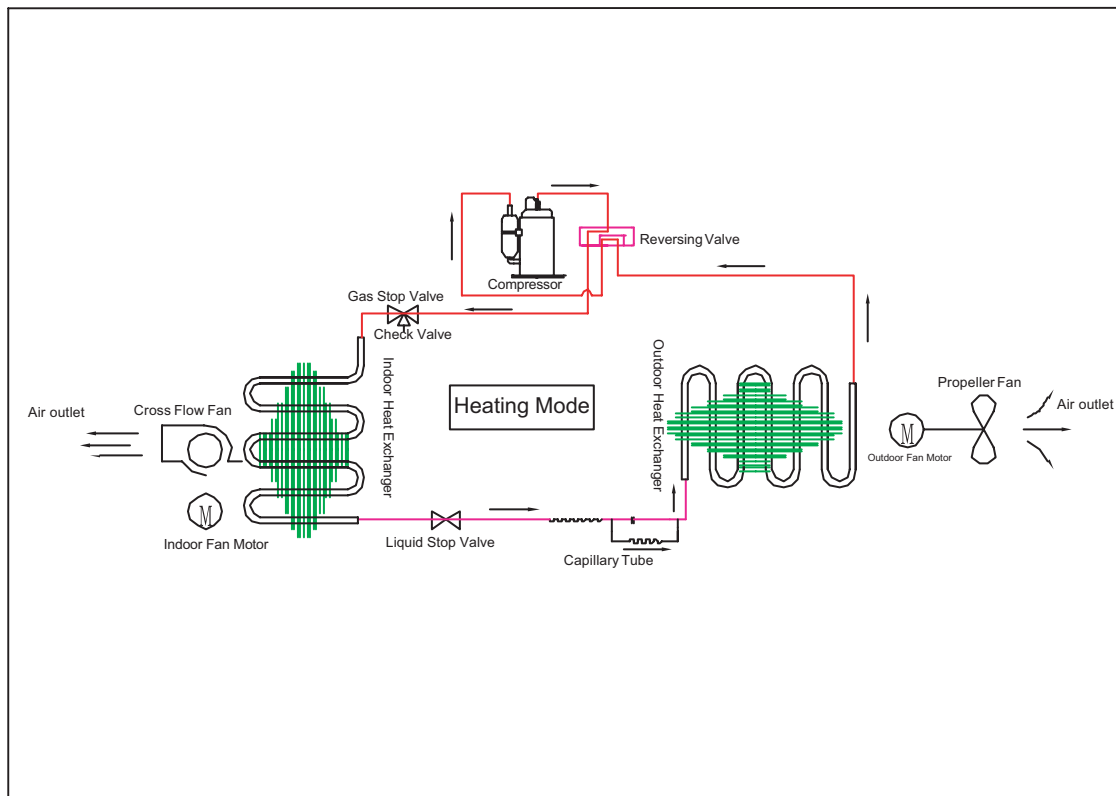

8 Wiring diagrams

Indoor unit

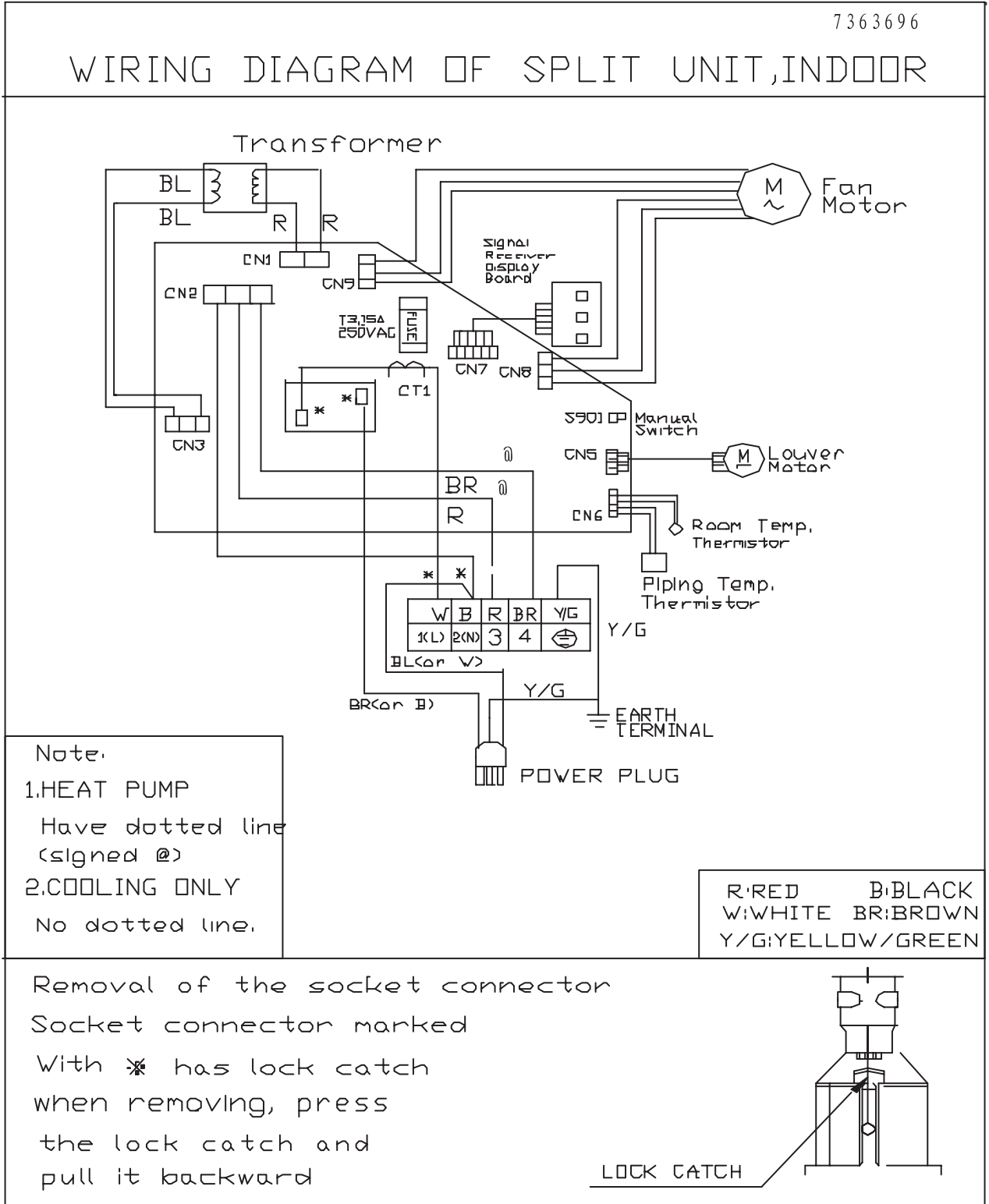

Outdoor unit

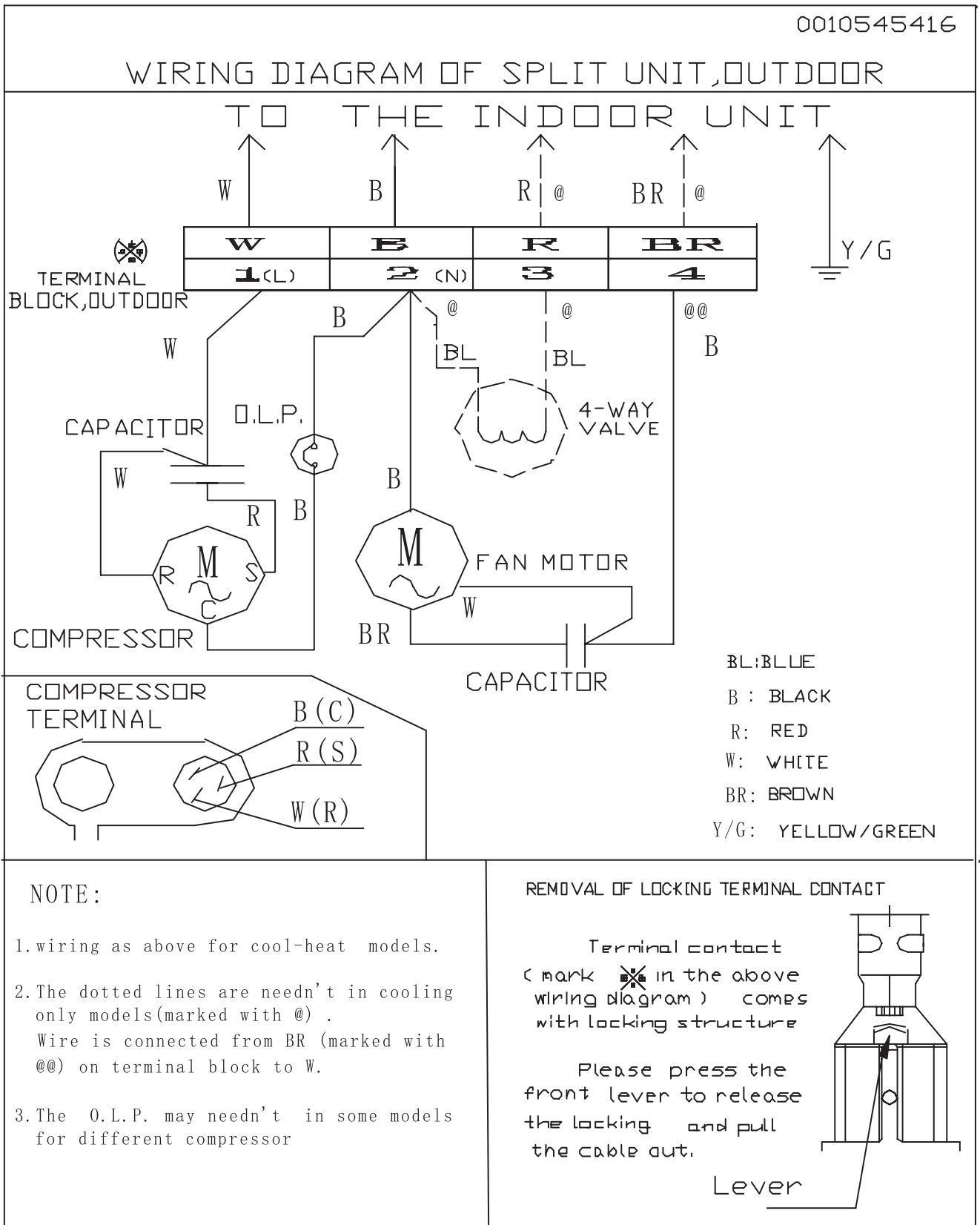

9 Capacity tables and curves diagrams

HSU-09HO3/Z1 performance curves								
cooling value-temperature talbe								
indoor temp	outdoor temp.(humidity 46%)							
DB/WB	18℃	20℃	25℃	32℃	35℃	40℃	43℃	46℃
18/12℃	1486	1497	1507	1286	1296	1339	1189	973
18/14℃	1969	1980	2047	1795	1758	1628	1516	1330
20/15℃	2451	2464	2477	2382	2220	2059	1923	1687
22/16℃	2397	2413	2430	2362	2187	1981	1842	1677
25/18℃	2344	2363	2382	2341	2154	1968	1845	1649
27/19℃	2605	2515	2565	2402	2300	2149	2026	1802
30/22℃	2882	2734	2922	2628	2498	2368	2196	2049
32/23℃	2982	2718	2928	2599	2542	2433	2305	2077
32/24℃	3061	2792	3006	2671	2613	2501	2370	2140

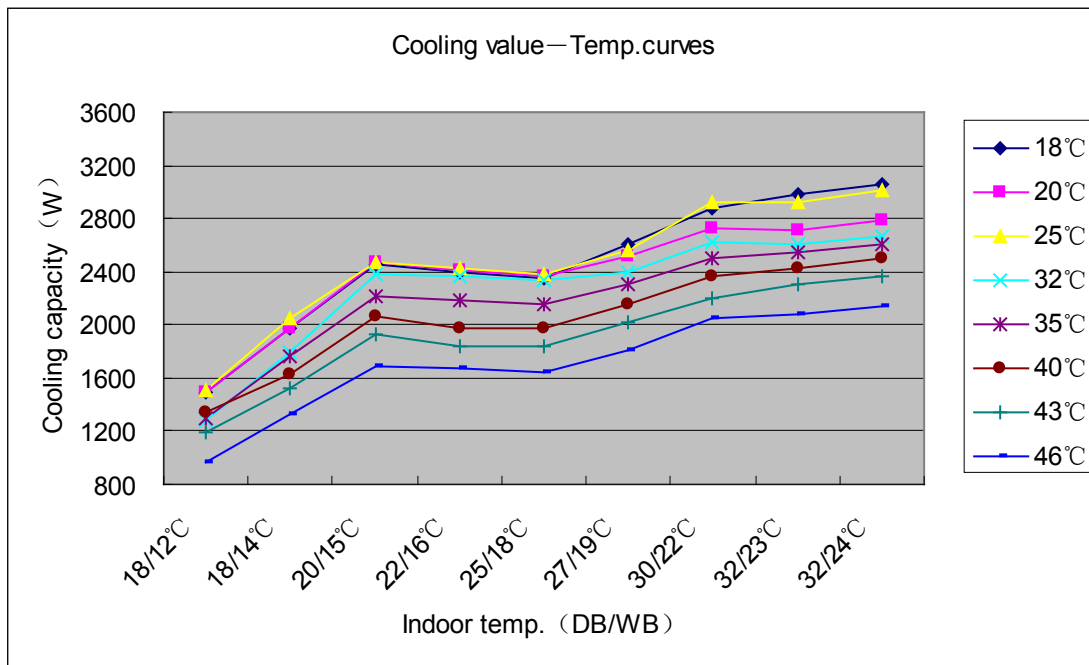

HSU-12H03/Z1 performance curves								
cooling value-temperature talbe								
indoor temp	outdoor temp.(humidity 46%)							
DB/WB	18℃	20℃	25℃	32℃	35℃	40℃	43℃	46℃
18/12℃	2386	2397	2407	2186	2196	2239	2089	1873
18/14℃	2869	2880	2947	2695	2658	2528	2416	2230
20/15℃	3351	3364	3377	3282	3120	2959	2823	2587
22/16℃	3297	3313	3330	3262	3087	2881	2742	2577
25/18℃	3244	3263	3282	3241	3054	2868	2745	2549
27/19℃	3505	3415	3465	3302	3200	3049	2926	2702
30/22℃	3782	3634	3822	3528	3398	3268	3096	2949
32/23℃	3882	3618	3828	3499	3442	3333	3205	2977
32/24℃	3961	3692	3906	3571	3513	3401	3270	3040

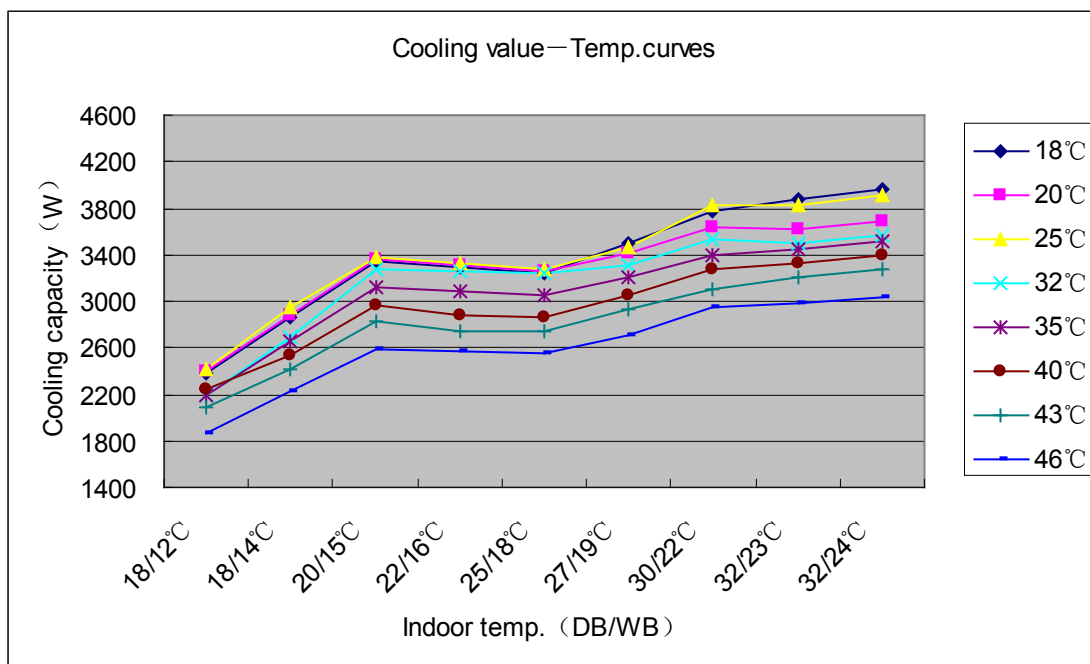

HSU-09HO3/Z1 performance curves			
heating capacity and indoor/outdoor temp.curves			
outdoor temp.	indoor temp.(humidity 46%)		
DB/WB	15°C	20°C	25°C
-15°C	445	372	275
-5°C	1284	1198	1075
5°C	1686	1594	1469
7/6°C	2199	2600	1728
15°C	2700	2750	2500
20°C	3000	2900	2800
25°C	3500	3250	3000

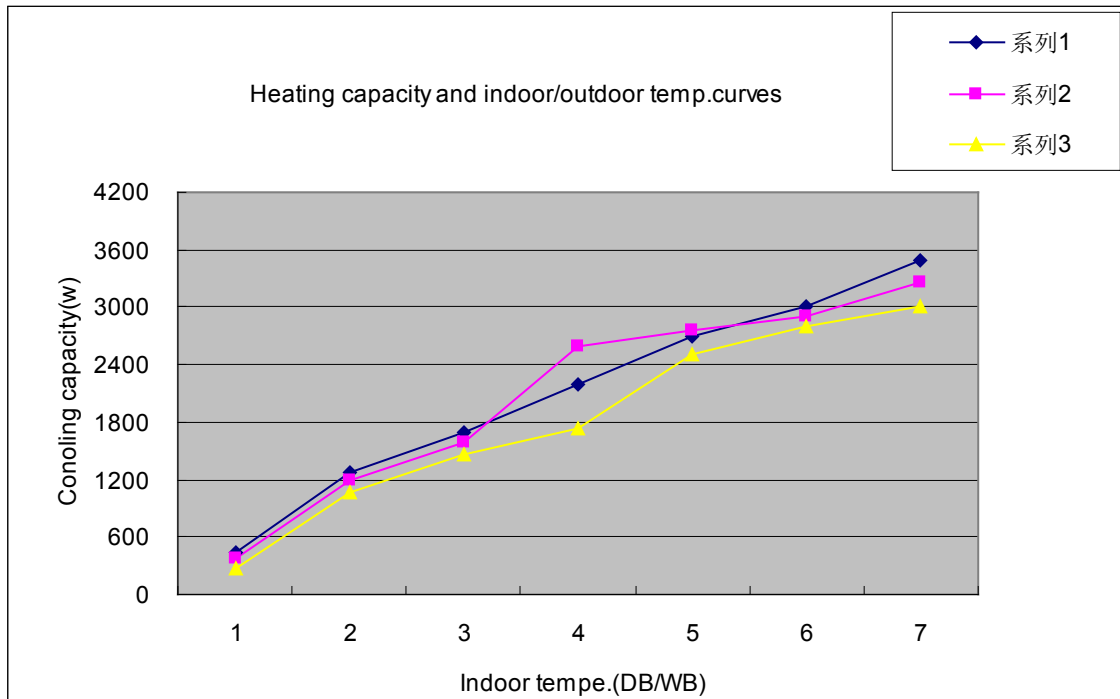

HSU-12H03/Z1 performance curves			
heating capacity and indoor/outdoor temp.curves			
outdoor temp.	indoor temp.(humidity 46%)		
DB/WB	15°C	20°C	25°C
-15°C	1445	1372	1275
-5°C	2284	2198	2075
5°C	2686	2594	2469
7/6°C	3199	3600	2728
15°C	3700	3750	3500
20°C	4000	3900	3800
25°C	4500	4250	4000

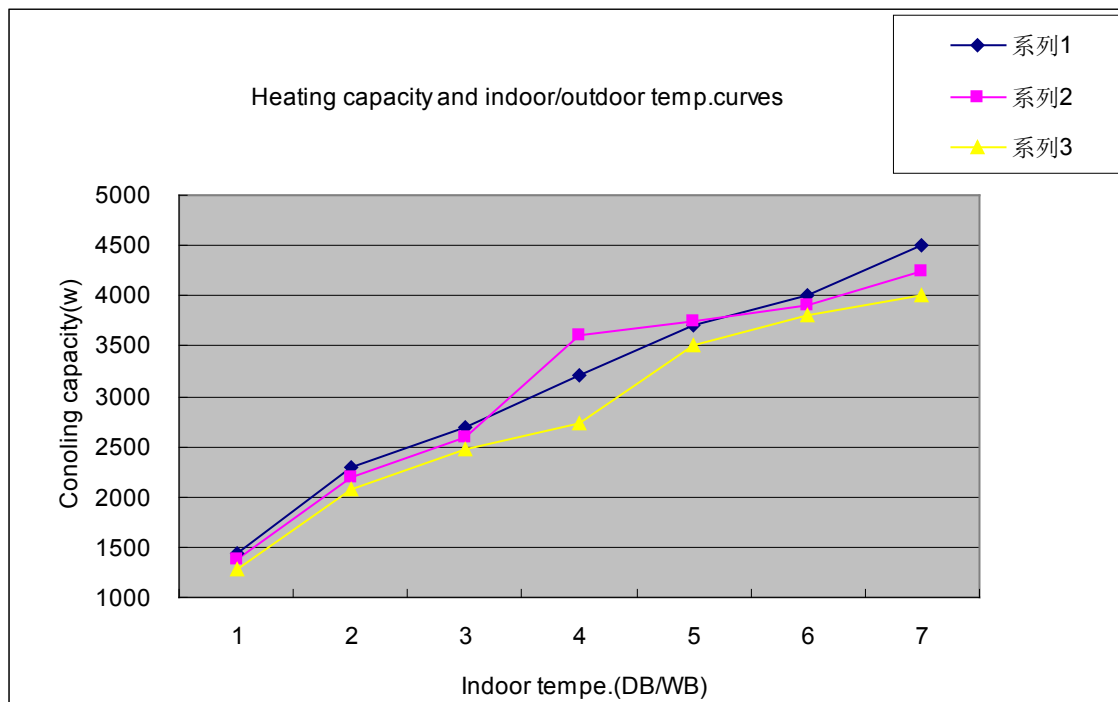

10 Sound level

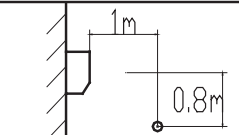
Model	Sound pressure level			Measuring location Location of microphone 	sound power level (cooling/heating)
	220 ~ V,50Hz				
	Cooling/heating				
	H	L	SL		
HSU-09H03/Z1	37	35	30		37
HSU-12H03/Z1	39	37	30		39

Sound level data(cooling)

HSU-09H03/Z1	100Hz	125Hz	250Hz	500Hz	1000Hz	2000Hz	4000Hz	6000Hz	8000Hz
INDOOR	41.7	34.7	33.6	32.6	30.5	28.2	19.7	0.0	0.0
OUTDOOR	51.7	46.5	47.2	45.6	43.9	39.7	33.0	29.9	28.9

HSU-12H03/Z1	100Hz	125Hz	250Hz	500Hz	1000Hz	2000Hz	4000Hz	6000Hz	8000Hz
INDOOR	42.4	35.2	34.6	33.6	31.4	29.1	20.1	0.0	0.0
OUTDOOR	52.7	49.7	48.2	46.3	44.2	40.1	35.0	30.2	29.9

Sound pressure spectrum(cooling)

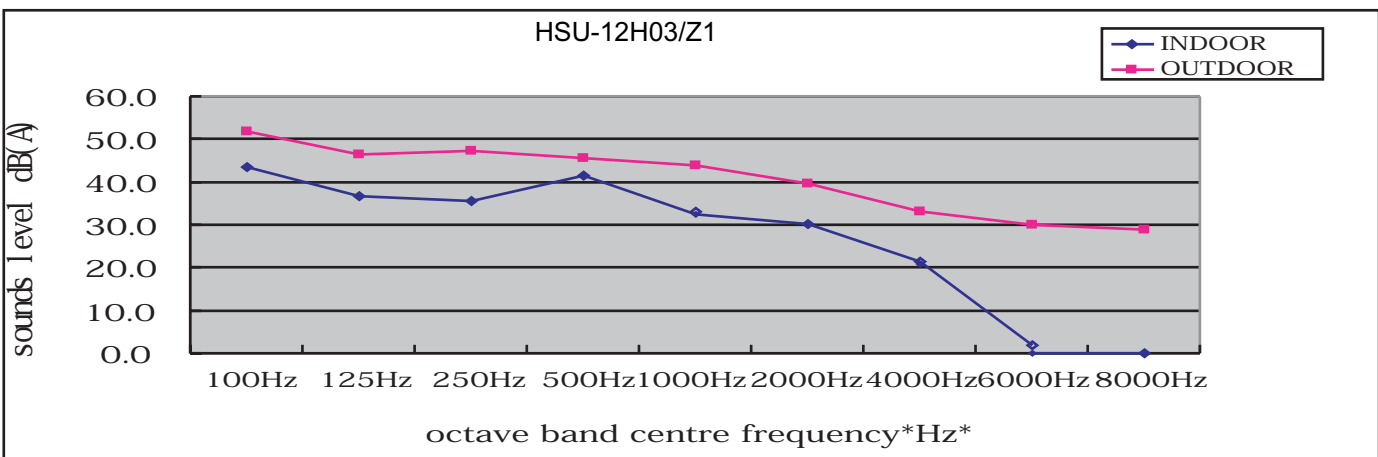
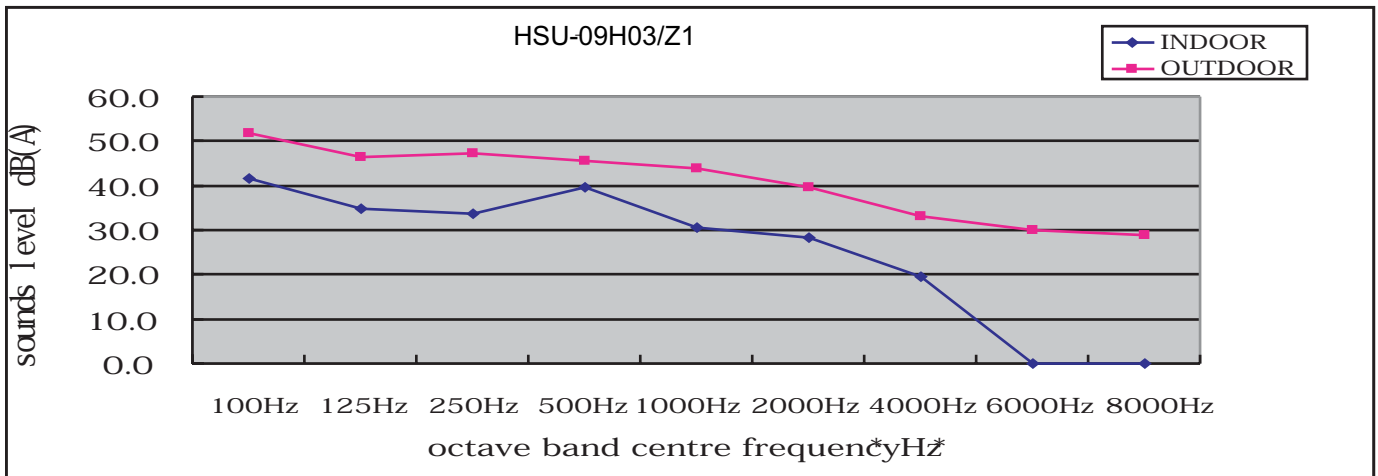

Sound level data(heating)

HSU-09H03/Z1	100Hz	125Hz	250Hz	500Hz	1000Hz	2000Hz	4000Hz	6000Hz	8000Hz
INDOOR	41.7	34.7	33.6	32.6	30.5	28.2	19.7	0.0	0.0
OUTDOOR	51.7	46.5	47.2	45.6	43.9	39.7	33.0	29.9	28.9

HSU-12H03/Z1	100Hz	125Hz	250Hz	500Hz	1000Hz	2000Hz	4000Hz	6000Hz	8000Hz
INDOOR	42.4	35.2	34.6	33.6	31.4	29.1	20.1	0.0	0.0
OUTDOOR	52.7	49.7	48.2	46.3	44.2	40.1	35.0	30.2	29.9

Sound pressure spectrum(heating)

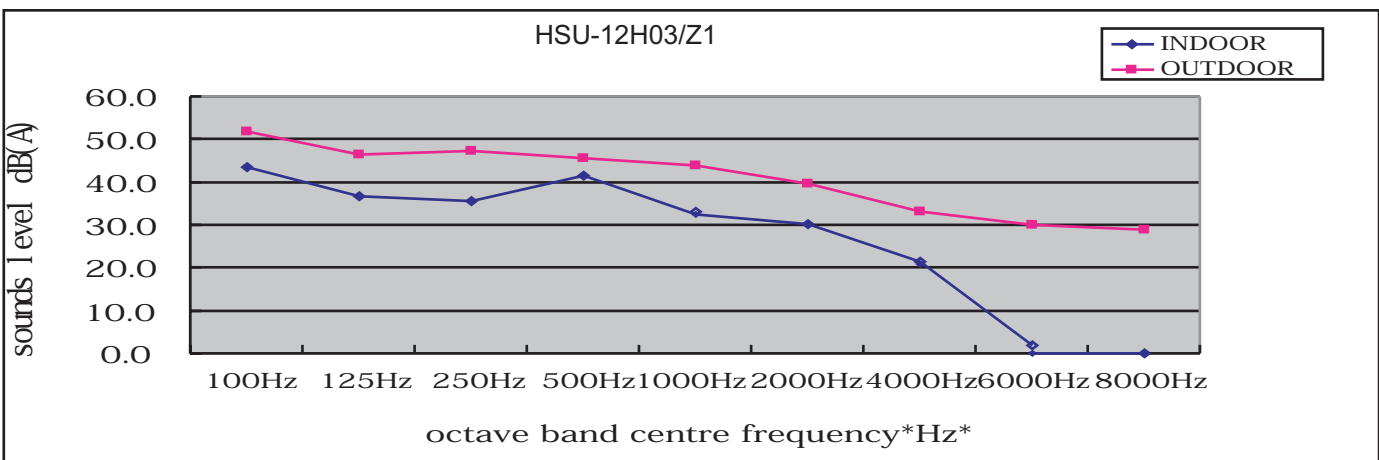
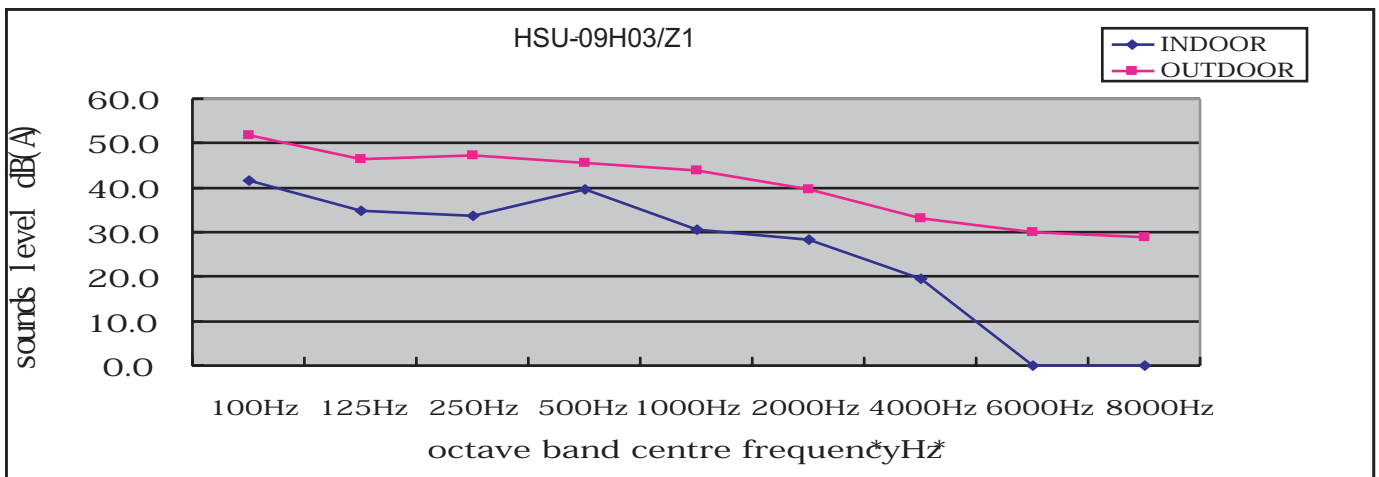

11 Accessories

Standard name	HSU-09H03/Z1	HSU-12H03/Z1
Drain hose	1	1
Plastic bag	1	1
screw assembly	1	1
Air purifier	2	2
Battery	2	2
Mounting plate	1	1
Remote controller	1	1
Installation manual	1	1
Operation manual	1	1

12 Control systems

Operation

Buttons and display of the remote controller.

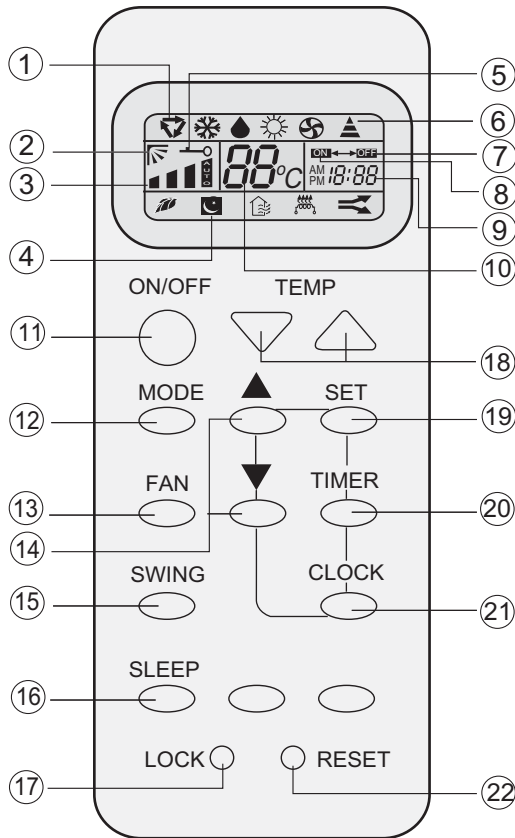

1. Mode display

AUTO

COOL

DRY

HEAT

FAN

2. SWING display



3. FAN SPEED display

4. SLEEP display

5. LOCK display

6. SIGNAL SENDING

7. TIMER OFF display

8. TIMER ON display

9. CLOCK display

10. TEMP display

11. POWER ON/OFF

Used for unit start and stop.

12. MODE

Used to select AUTO run, COOL, DRY, HEAT and FAN operation

13. FAN

Used to select fan speed LO, MED, HI, AUTO

14. HOUR

Used to set clock and timer setting.

15. SWING

Used to set auto fan direction.

16. SLEEP

Used to select sleep mode.

17. LOCK

Used to lock buttons and LCD display.

18. TEMP.

Used to select your desired temp.

19. SET

Used to confirm timer and clock settings.

20. TIMER

Used to select TIMER ON, TIMER OFF, TIMER ON-OFF

21. CLOCK

Used to set correct time

22. RESET

Used to reset the controller back to normal condition.

Clock set

When unit is started for the first time and after replacing batteries in remote controller, clock should be adjusted as follows:

Press CLOCK button, "AM" or "PM" flashes.

Press Δ or ∇ to set correct time. Each press will increase or decrease 1min. If the button is kept depressed, time will change quickly.

After time setting is confirmed, press SET, "AM" and "PM" stop flashing, while clock starts working.

NOTE: Cooling only unit do not have displays and functions related with heating

Hints









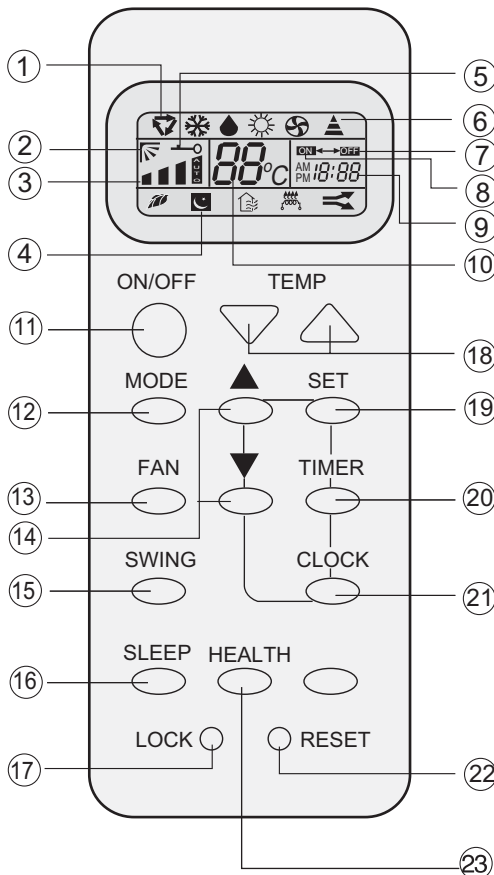





After replacing with new batteries, remote controller will conduct self-check, displaying all information on LCD. Then, it will become normal.

Operation

Buttons and display of the remote controller.

If the unit which you purchased has healthy function, Remote controller should like the following figure:



1. Mode display
 AUTO 
 COOL 
 DRY 
 HEAT 
 FAN 
2. SWING display 
3. FAN SPEED display  AUTO LO MED HI
4. SLEEP display 
5. LOCK display 
6. SIGNAL SENDING 
7. TIMER OFF display 
8. TIMER ON display 
9. CLOCK display 
10. TEMP display 
11. POWER ON/OFF
Used for unit start and stop.
12. MODE
Used to select AUTO run, COOL, DRY, HEAT and FAN operation
13. FAN
Used to select fan speed LO, MED, HI, AUTO
14. HOUR
Used to set clock and timer setting.
15. SWING
Used to set auto fan direction.
16. SLEEP
Used to select sleep mode.
17. LOCK
Used to lock buttons and LCD display.
18. TEMP.
Used to select your desired temp.
19. SET
Used to confirm timer and clock settings.
20. TIMER
Used to select TIMER ON, TIMER OFF, TIMER ON-OFF
21. CLOCK
Used to set correct time
22. RESET
Used to reset the controller back to normal condition.
23. HEALTH
Used to set healthy operation

BRIEF INTRODUCTION TO HEALTH OPERATION

The anion generator in the air conditioner can generate a lot of anion to effectively balance the quantity of position and anion in the air and also to kill bacteria and speed up the dust sediment in the room and finally clean the air in the room.

NOTE: Cooling only unit do not have displays and functions related with heating

Hints

After replacing with new batteries, remote controller will conduct self-check, displaying all information on LCD. Then, it will become normal.

13 Center of gravity

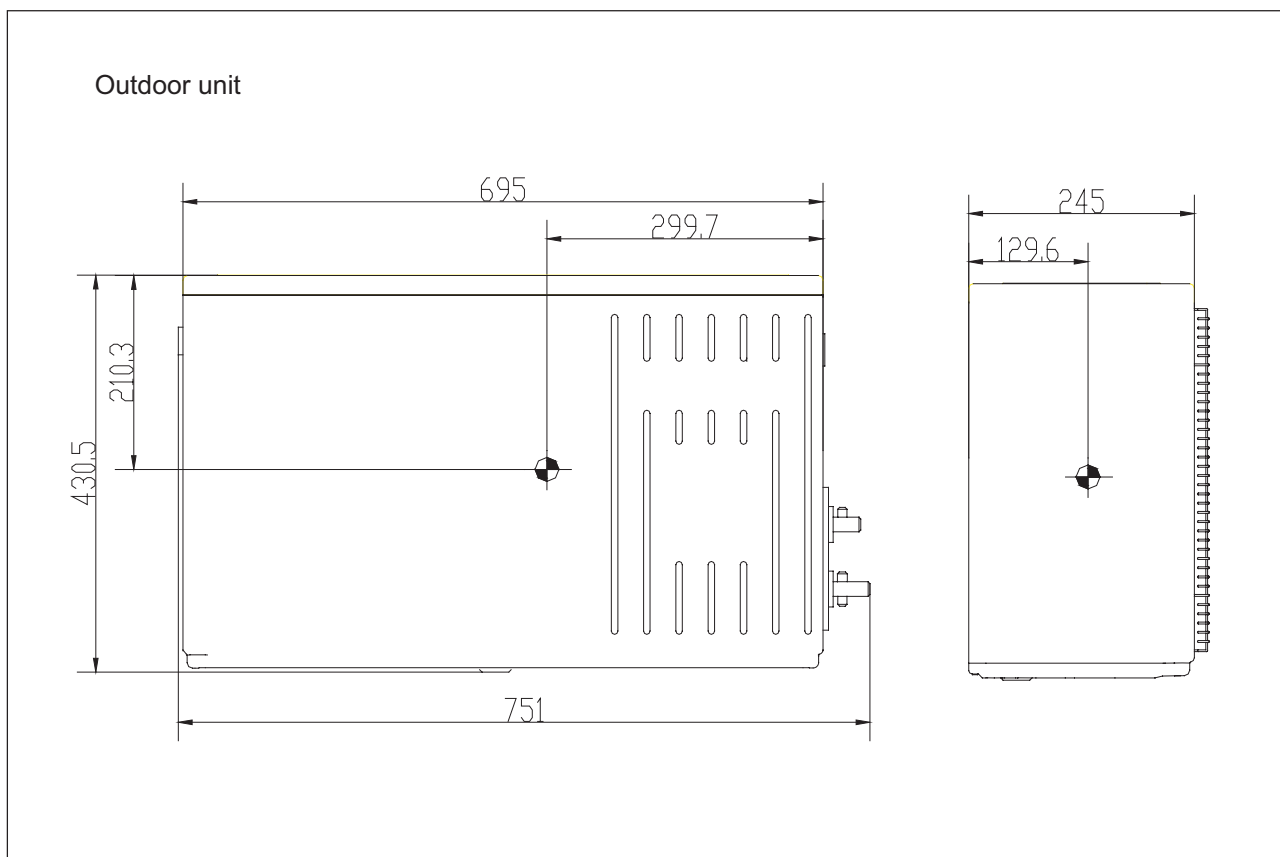
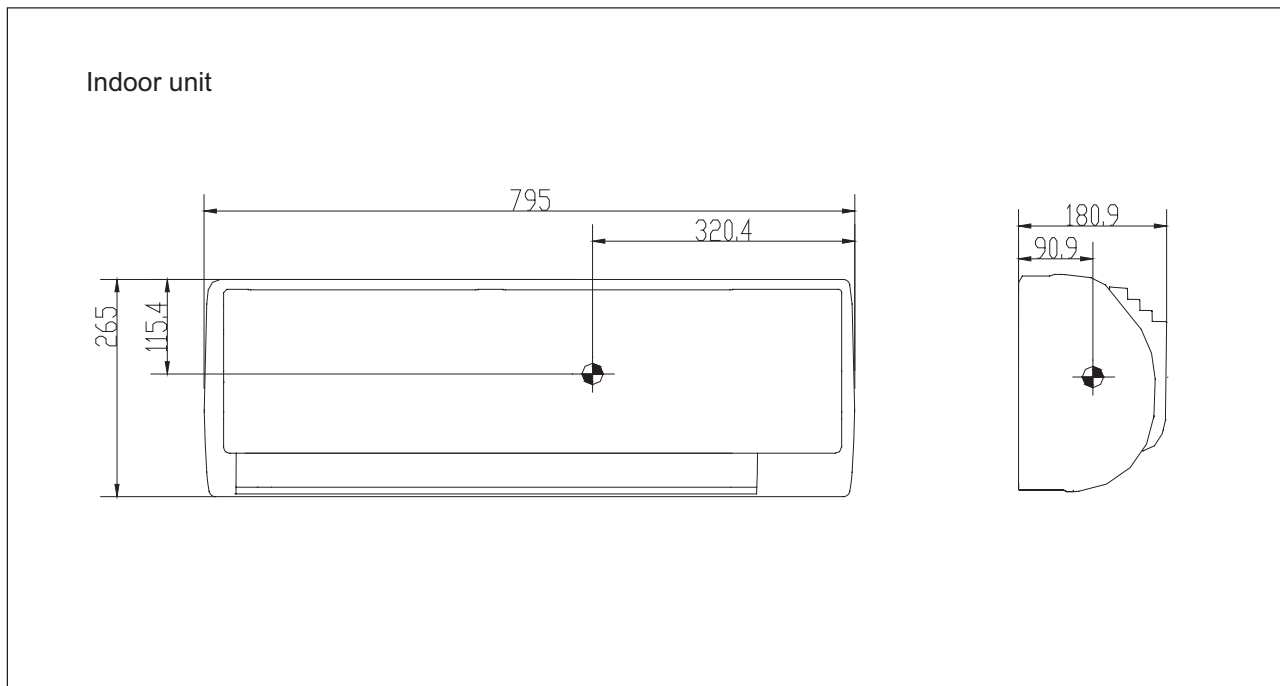

14 Installations

Indoor unit installation drawings

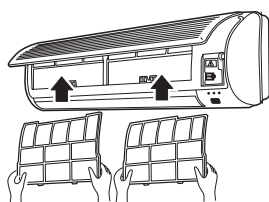
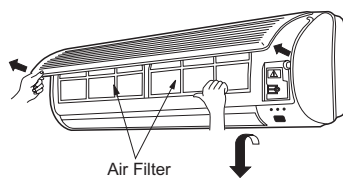
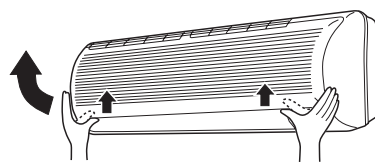
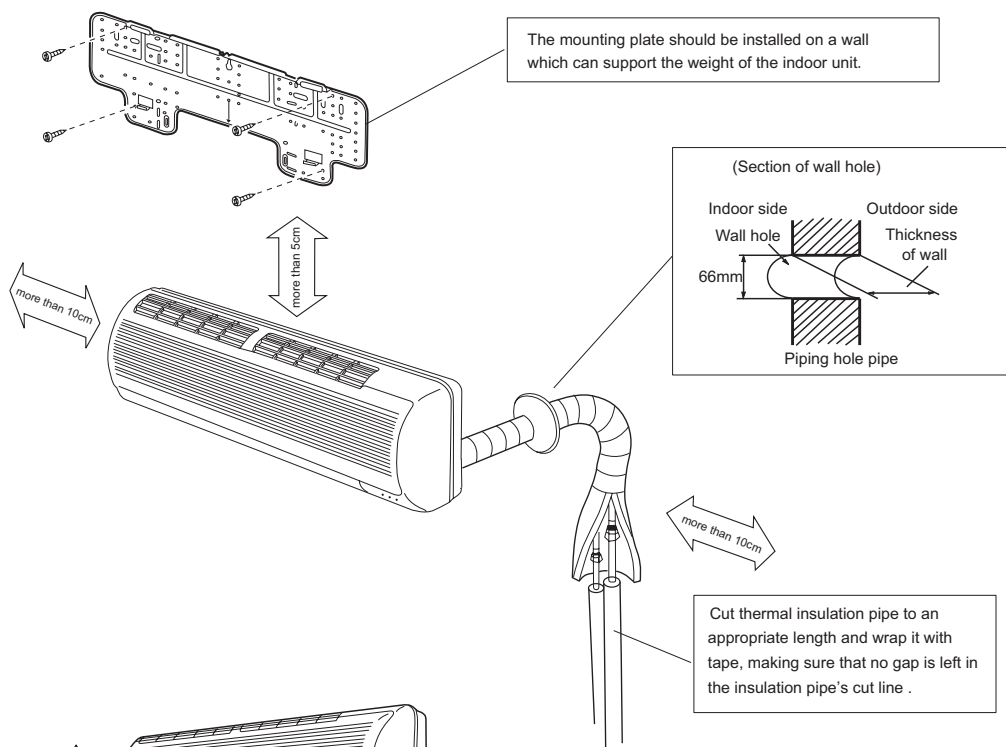
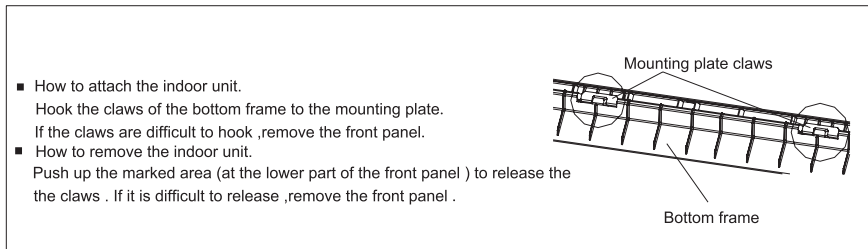

How to remove the air filter.

Open the inlet grille by pulling it upward.

Push up the filter's center tab slightly until it is released from the stopper, and remove the filter downward.

How to Attach the air filter.

Attach the filter correctly so that the "FRONT" indication is facing to the front. Make sure that the filter is completely fixed behind the stopper. If the right and left filters are not attached correctly, that may cause defects.

Close the inlet grille.

Outdoor unit installation drawings

HSU-09,12H03/Z1

Outdoor

Model	26/28 class
Max.allowable length	Cooling only: 7 m Heat pump: 7 m
Max.allowable height	5m
Additional refrigerant required for refrigerant pipe exceeding 5m in length	16g/m
Gas pipe	O.D. 9.52/12.7
Liquid pipe	O.D. 6.35/9.52

*Be sure to add the proper amount of additional refrigerant. Failure to do so may result in reduced performance.

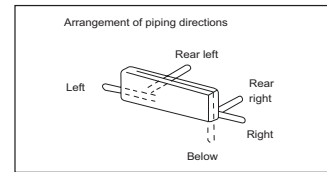

The distance between the indoor unit and the floor should be more than 2m.

Wrap the installation pipe with the finishing tape from bottom to top Model 25 / 35 class

Service lid

- How to remove the service lid. This service lid is an open/close type. Slide the lid downward to remove it.
- How to attach the service lid. Insert the upper part of the service lid into the outdoor unit to install. Tighten the screws.

Where there is a danger of the unit falling, use foot bolts, or wires.

- Fix the unit to concrete or block with bolts (Φ10mm) and nuts firmly and horizontally.
- When fitting the unit to wall surface, roof or rooftop, fix a supporter surely with nails or wires in consideration of earthquake and strong wind.
- If vibration may affect the house, fix the unit by attaching a vibration-proof mat.

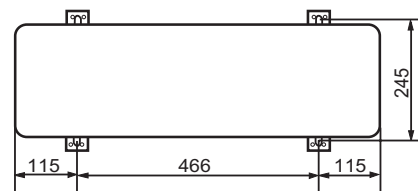

Sincere Forever



Haier Group

Haier Industrial Park, No.1, Haier Road
266101, Qingdao, China

E-mail: hractech@haier.com

Tel: +86 532 87636957

[Http://www.haier.com](http://www.haier.com)

Edited by: Zhao Jicheng

Signed by: Yang Bifei

Approved by: Zhu Zhenxue