



Domestic Air conditioner

TECHNICAL DATA

ON/OFF

Wall mounted Type V-Series

HSU-09C03/VA(ZXF)
HSU-12C03/VA(ZXF)



CAUTION

1. READ THIS MANUAL CAREFULLY TO
DIAGNOSE TROUBLE CORRECTLY
BEFORE OFFERING SERVICE.
2. THIS MANUAL IS USED BY QUALIFIED
APPLIANCE TECHNICIANS ONLY.
3. HAIER DOES NOT ASSUME ANY
RESPONSIBILITY FOR PROPERTY
DAMAGE OR PERSONAL INJURY FOR
IMPROPER
SERVICE PROCEDURES DONE BY ONE
UNQUALIFIED PERSON.

Table of Contents

1. Features	2
2. Specifications	3
3. Remote controller lists	6
4. Sensors lists	6
5. Dimensional drawings	7
6. Operation range	9
7. Piping diagrams	10
8. Wiring diagrams	11
9. Capacity diagrams and curves diagrams	13
10. Sound level	15
11. Accessories	16
12. Control systems	17
13. Center of gravity	18
14. Installations	19

1 Features



O2 fresh: It can bring the fresh air in when the machine is running in O2 fresh mode.



Healthy UV ray: UV ray generator can eliminate and prevent bacteria in air effectively



DRY function: Make dehumidifying in the room when the unit is working in the "DRY" mode .



Intelligent air:With twin-blade technology ,the airflow can be adjusted not to blow directly to human body , so preventing people from the air conditioner symptom .



Photocatalyst filter: Eliminates the air of a wide variety of odor-causing substances from cigarette smoke particles to chemical vapors



Bacteria-killing medium: 3-in-1 effect:Anti-Allergen , Anti-Bacteria



3D air flow: The 3D airflow is able to deliver the airflow horizontally and vertically



Auto mode: According to the fixed temperature "26C",the unit will adjust the operation mode automatically.



Sleep mode: The setting temperature and the indoor noise can be adjusted to a more comfortable level when you set the "sleep mode"during night sleep .



24Hour timer: Use the timer function to set on,or off,or from on to off,or from off to on .



4 Fan setting: Slect the fan speed LO,MED,HI,AUTO



Easy clean design: The panel is easy to wash and the airflow vents can be detached without any special tools for quick cleaning of the inside of the air conditioner .



Left&right flow: With specialized motor and flaps,the airflow can be adjusted



Child lock: Avoid the child's wrong operation on the remote controller .



2.Specifications

This information was not available at the time of publication

NOMINAL CAPACITY and NOMINAL INPUT					
Model			HSU-09C03/VA(ZXF)	HSU-12C03/VA(ZXF)	
NOMINAL CAPACITY(3-4)	Cooling(1)	norm.	kw	2.50	3.50
	Heating(2)	norm.	kw	-----	-----
NOMINAL INPUT	Cooling	norm	kw	0.84	1.25
	Heating	norm.	kw	-----	-----
EER	Cooling			2.98	2.80
COP	Heating			-----	-----
ENERGY LABEL(7-8)	Cooling			----	----
	Heating			----	----
ANNUAL ENERGY CONSUMPTION(9)	Cooling		kwh	396.5	530

TECHNICAL SPECIFICATIONS						
INDOOR UNITS				HSU-09C03/VA(ZXF)	HSU-12C03/VA(ZXF)	
DIMENSIONS	Unit	H	mm	265		
		W	mm	795		
		D	mm	182		
WEIGHT	Unit		kg	8.9		
COLOR	Unit				white	
SOUND LEVEL	Sound pressure (cooling/heating)(5)	high	dB(A)	38	44	
		medium	dB(A)	34	38	
		low	dB(A)	30	33	
	Sound power(cooling/heating)(6)	high	dB(A)	38	44	
FAN	Air flow rate(cooling/heating)	high	m ³ /min	7.8	8.7	
		low	m ³ /min	7.0	8.3	
		super low	m ³ /min	6.2	7.4	
	Speed(cooling/heating)	steps		5steps,silent and auto		
		high	rpm	1200	1350	
		medium	rpm	1150	1200	
		low	rpm	1050	1050	
Type	Cross flow fan					
Motor output		W	16	16		
AIR FILTER	Removable/washable/mildew proof					
REMOTE CONTROLLER	YL-H68EN					
TEMPERATURE CONTROL	Microcomputer control					
PIPING CONNECTIONS(external diameter)	liquid	mm	Φ 6.35	Φ 6.35		
	gas	mm	Φ 9.52	Φ 12.7		
	drain	mm	Φ 16	Φ 16		
INSULATION MATERIAL	Heat insulation type				both liquid and gas pipes	
HEAT EXCHANGGER	TYPE			ML fin - Φ 9.52HI - XA tube		
	Row x stage x fin pinth		mm	2 x 8 x 1.4		

TECHNICAL SPECIFICATIONS						
OUTDOOR UNITS				HSU-09C03/VA(ZXF)	HSU-12C03/VA(ZXF)	
NET DIMENSIONS (stop valve, and bottom support is not included)	Unit	H	mm	430		
		W	mm	695		
		D	mm	245		
WEIGHT	Unit		kg	27	31	
COLOR	Unit	white				
SOUND LEVEL	Sound pressure(cooling/heating)(5)	high	dB(A)	48	52	
	Sound power(cooling/heating)(6)	high	dB(A)	48	52	
FAN	Air flow rate(cooling/heating)	high	m ³ /min	22	25	
		low	m ³ /min	---	---	
	Speed(cooling/heating)	high	rpm	830	1060	
		low	rpm	---	---	
	Type	Propeller fan				
	Motor output		W	80	80	
REFRIGERANT CIRCUIT	Refrigerant type	R22				
	Refrigerant charge		kg	0.60	0.84	
	Maximum allowable distance between indoor and outdoor		m	7		
	Maximum allowable level difference		m	5		
	Refrigerant control	-----				
COMPRESSOR	Type	rotary Compressor				
	Model			2P16S225ANC	PH225X2C-8FTC	
	Motor output		w	780	1020	
	Oil type			DIAMOND MS-56	SUNISO 4GSI	
	Oil charge volume		L	0.27	0.52	
PIPING CONNECTIONS	liquid		mm	Φ 6.35		
	gas		mm	Φ 9.52/Φ 12.7		
	drain		mm	Φ 18		
INSULATION MATERIAL	Heat insulation type			both liquid and gas pipes		
HEAT EXCHANGGER	TYPE			ML - Φ 9.52HI - XAbube		
	Row x stage x fin pinth		mm	2 x 8 x 1.4		

ELECTRICAL SPECIFICATIONS						
For indoor units only:				HSU-09C03/VA(ZXF)	HSU-12C03/VA(ZXF)	
CURRENT	Nominal running current	cooling	A	0.15	0.15	
		heating	A	-----	-----	
	Maximum running current	cooling	A	0.15	0.15	
		heating	A	-----	-----	

For combination indoor units+ outdoor units:				HSU-09C03/VA(ZXF)	HSU-12C03/VA(ZXF)
CURRENT	Nominal running current	cooling	A	3.9	5.8
		heating	A	-----	-----
	Maximum running current	cooling	A	5.6	8.5
		heating	A	-----	-----
	Starting current	cooling	A	30	42
		heating	A	-----	-----

For indoor units only:				HSU-09C03/VA(ZXF)	HSU-12C03/VA(ZXF)
POWER SUPPLY				VM	VM
NOMINAL DISTRIBUTION SYSTEM VOLTAGE	Phase			1PH	1PH
	Frequency	Hz		50	50
	Voltage	V		220V~	220V~

NOTES

- 1 Nominal cooling capacities are based on: indoor temperature 27°CDB/19°CWB * outdoor temperature 35°CDB * refrigerant piping length: 5m * level difference: 0m.
- 2 Nominal heating capacities are based on: indoor temperature 20°CDB * outdoor temperature 7°CDB/6°CWB * refrigerant piping length 5m (horizontal) * level difference 0m.
- 3 Capacities are net, including a deduction for cooling (an addition for heating) for indoor fan motor heat.
- 4 Units should be selected on nominal capacity. Maximum capacity is limited to peak periods.
- 5 The sound pressure level is measured via a microphone at a certain distance from the unit. For measuring conditions: please refer to item 6 of this chapter.
- 6 The sound power level is an absolute value indicating the "power" which a sound source generates.
- 7 Energy label: scale from A (most efficient) to G (less efficient).
- 8 The energy label Directive 2002/31/EC will enter into force once the relevant measurement standard will be published in the European official Standard.
- 9 Annual energy consumption: based on average use of 500 running hours per year at full load (= nominal conditions)

3 Remote controller lists

Model	HSU-09C03/VA(ZXF)	HSU-12C03/VA(ZXF)
YL-H68	Y	Y
-----	---	---

4 Sensors lists

INDOOR UNIT		
type	Description	Qty
Room sensor	It's used for detecting room temperature	1
Pipe sensor	It's used for detecting temperature of evaporator	1

5 Dimensional drawings

Indoor unit

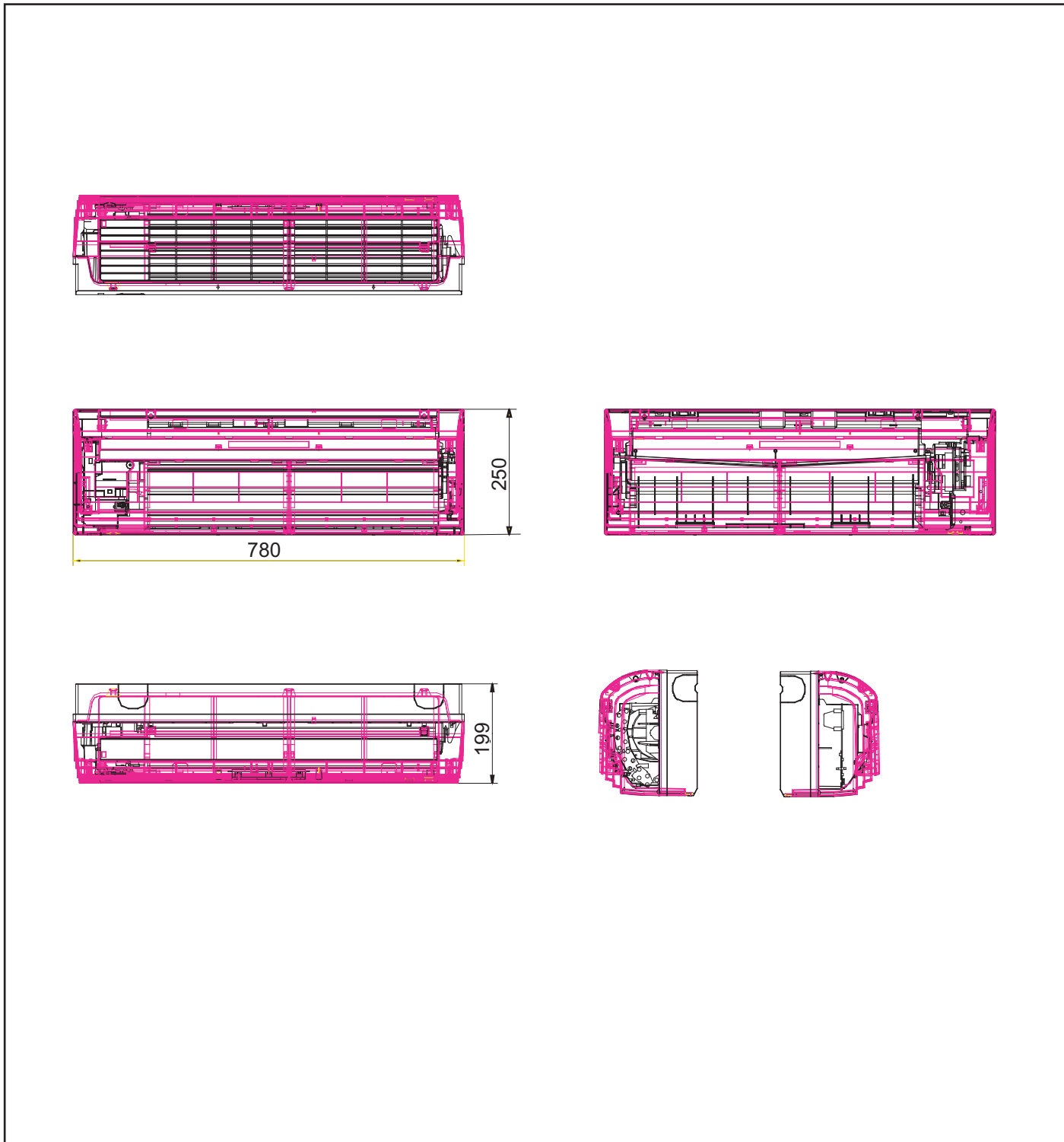

Outdoor unit

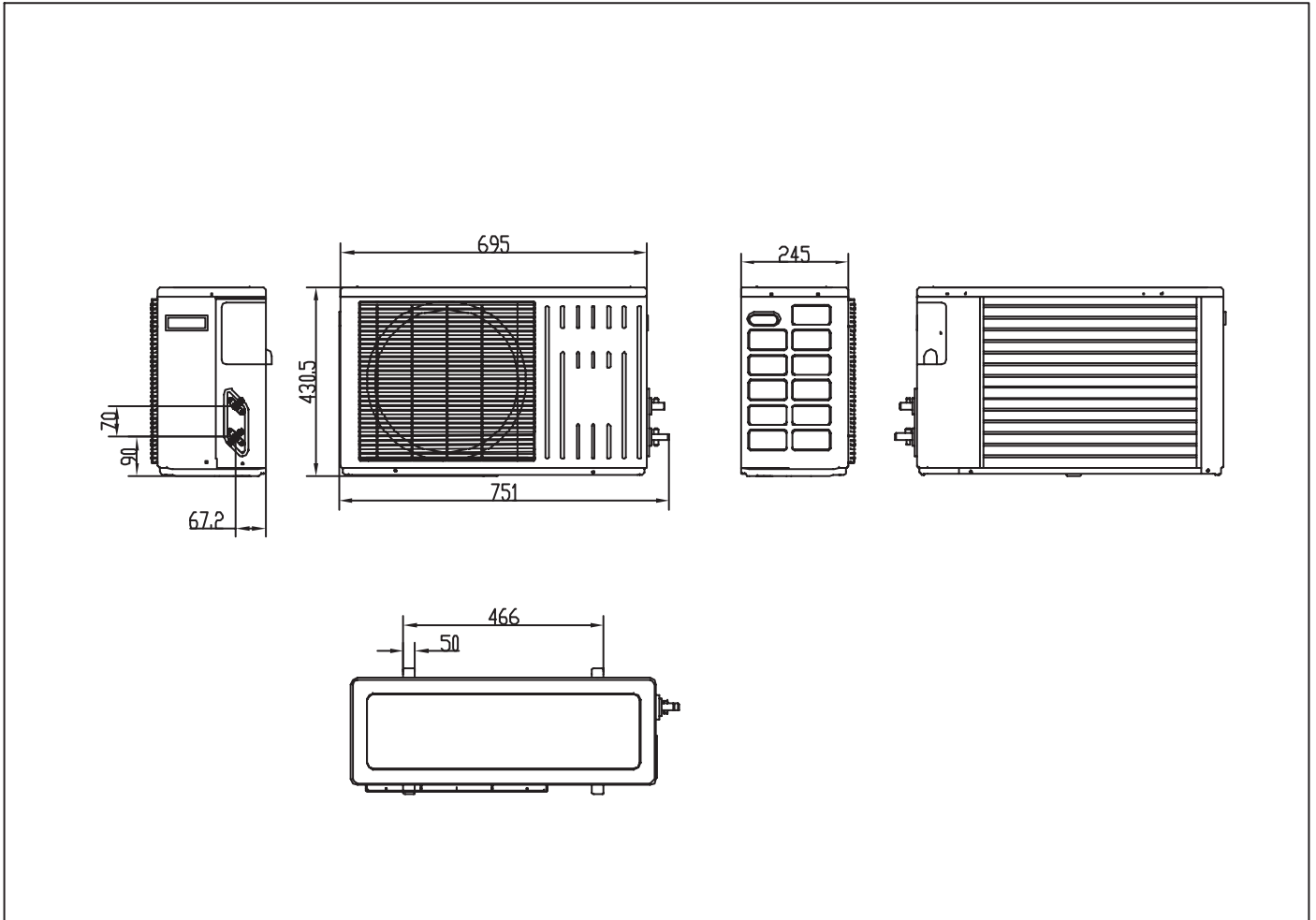

6 Operation range

The name of parts

Cooling

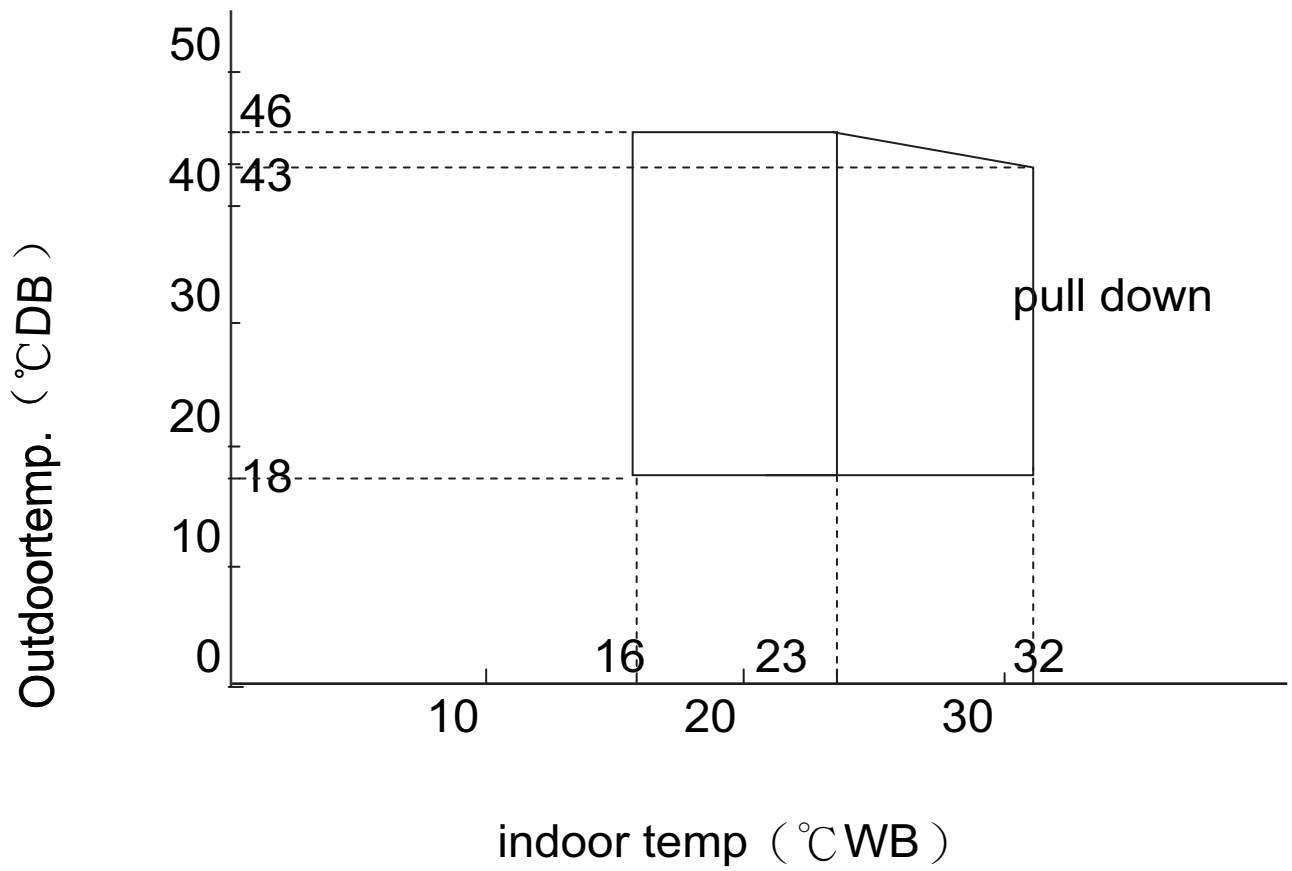

7 Piping diagrams

Cooling mode

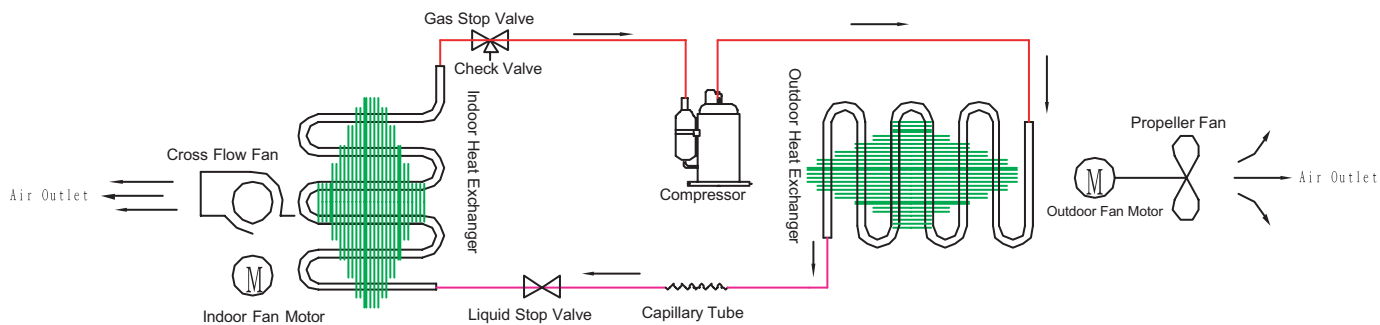

8 Wiring diagrams

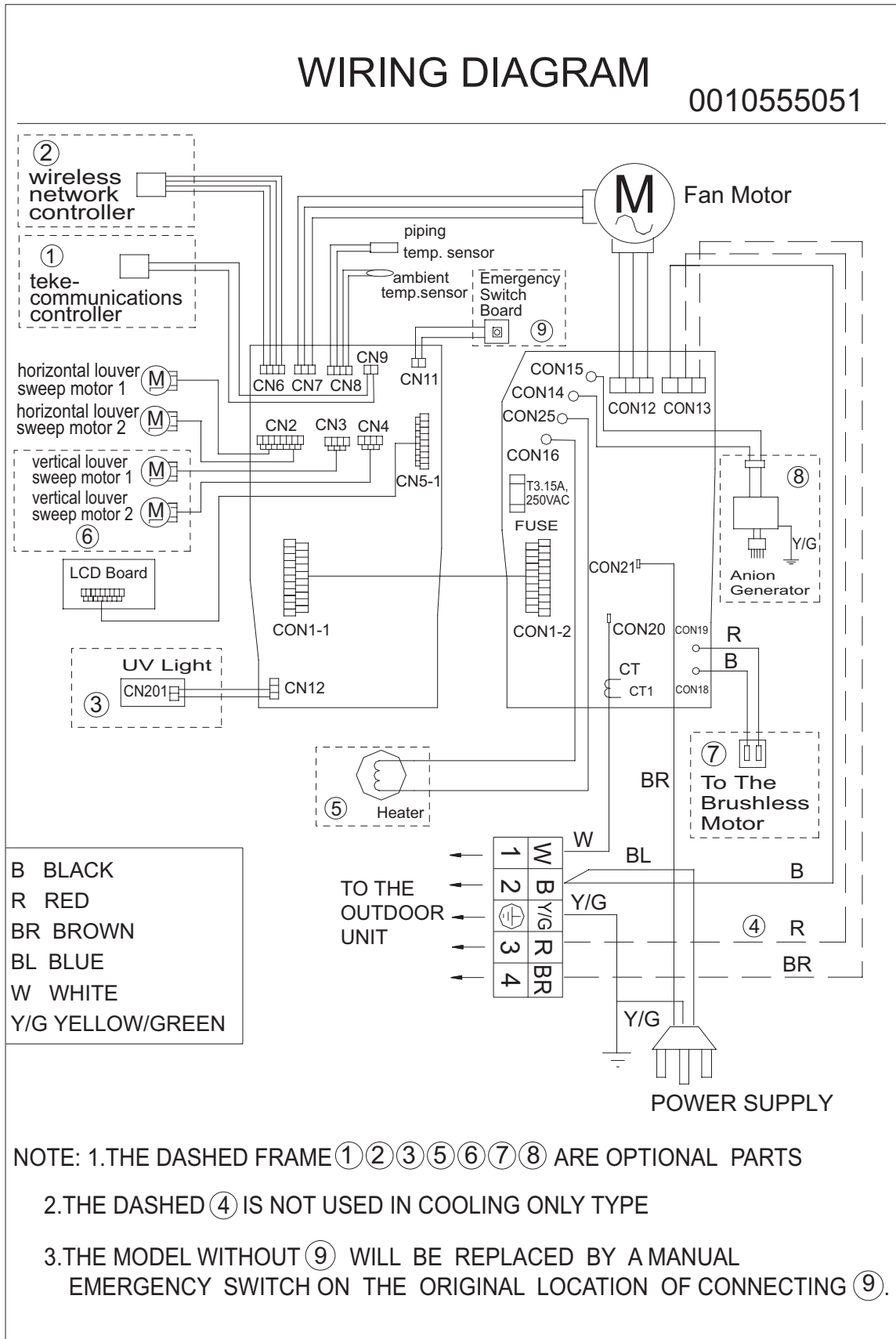

Outdoor unit

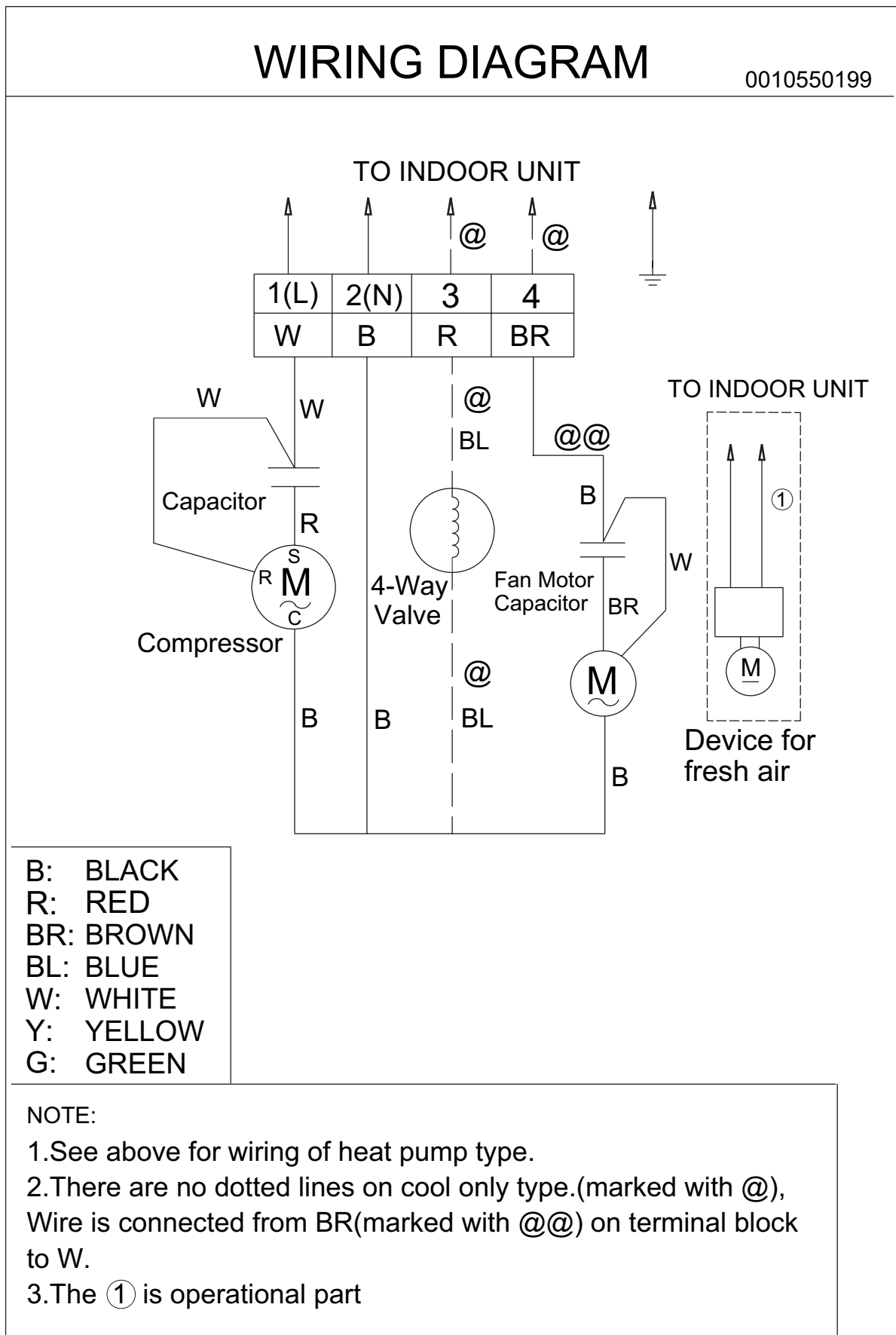

9 Capacity tables and curves diagrams

HSU-09C03/VA(ZXF) performance curves								
cooling value-temperature talbe								
indoor temp	outdoor temp.(humidity 46%)							
DB/WB	18°C	20°C	25°C	32°C	35°C	40°C	43°C	46°C
18/12°C	1686	1697	1707	1486	1496	1539	1389	1173
18/14°C	2169	2180	2247	1995	1958	1828	1716	1530
20/15°C	2651	2664	2677	2582	2420	2259	2123	1887
22/16°C	2597	2613	2630	2562	2387	2181	2042	1877
25/18°C	2544	2563	2582	2541	2354	2168	2045	1849
27/19°C	2805	2715	2765	2602	2500	2349	2226	2002
30/22°C	3082	2934	3122	2828	2698	2568	2396	2249
32/23°C	3182	2918	3128	2799	2742	2633	2505	2277
32/24°C	3261	2992	3206	2871	2813	2701	2570	2340

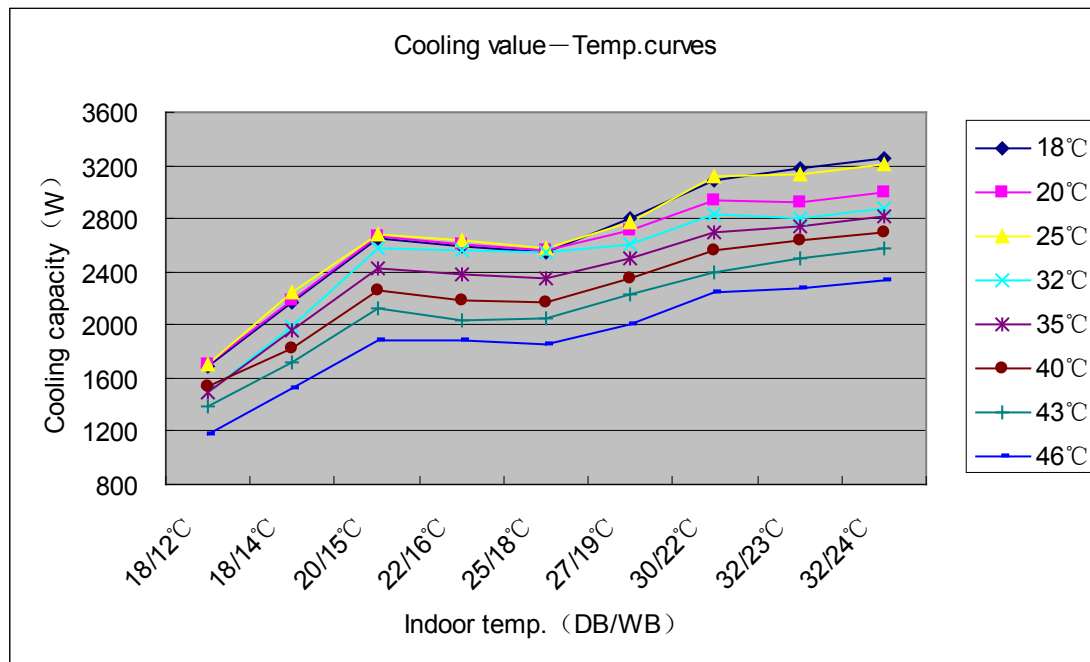

HSU-12C03/VA(ZXF) performance curves								
cooling value-temperature talbe								
indoor temp	outdoor temp.(humidity 46%)							
DB/WB	18℃	20℃	25℃	32℃	35℃	40℃	43℃	46℃
18/12℃	2686	2697	2707	2486	2496	2539	2389	2173
18/14℃	3169	3180	3247	2995	2958	2828	2716	2530
20/15℃	3651	3664	3677	3582	3420	3259	3123	2887
22/16℃	3597	3613	3630	3562	3387	3181	3042	2877
25/18℃	3544	3563	3582	3541	3354	3168	3045	2849
27/19℃	3805	3715	3765	3602	3500	3349	3226	3002
30/22℃	4082	3934	4122	3828	3698	3568	3396	3249
32/23℃	4182	3918	4128	3799	3742	3633	3505	3277
32/24℃	4261	3992	4206	3871	3813	3701	3570	3340

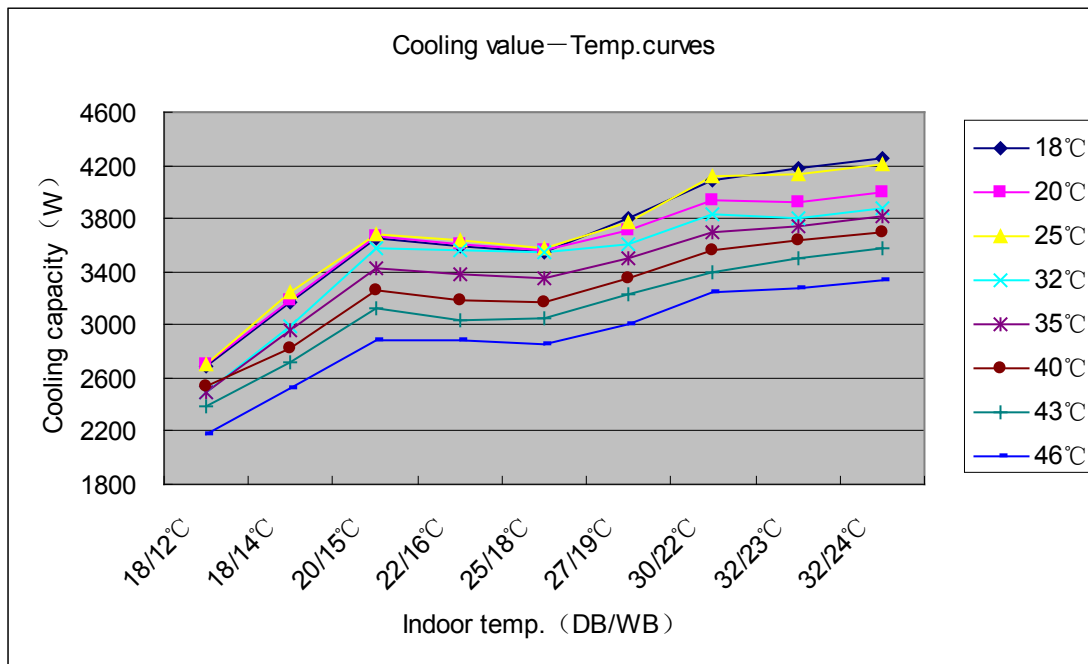

10 Sound level

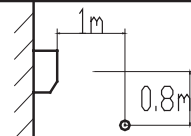
Model	Sound pressure level			Measuring location Location of microphone 	sound power level
	220 ~ V,50Hz				
	Cooling				
	H	L	SL		
HSU-09C03/VA(ZXF)	38	34	30		38
HSU-12C03/VA(ZXF)	44	38	33		44

Sound level data

HSU-09C03/VA(ZXF)	100Hz	125Hz	250Hz	500Hz	1000Hz	2000Hz	4000Hz	6000Hz	8000Hz
INDOOR	41.7	34.7	33.6	32.6	30.5	28.2	19.7	0.0	0.0
OUTDOOR	51.7	46.5	47.2	45.6	43.9	39.7	33.0	29.9	28.9

HSU-12C03/VA(ZXF)	100Hz	125Hz	250Hz	500Hz	1000Hz	2000Hz	4000Hz	6000Hz	8000Hz
INDOOR	42.4	35.2	34.6	33.6	31.4	29.1	20.1	0.0	0.0
OUTDOOR	52.7	49.7	48.2	46.3	44.2	40.1	35.0	30.2	29.9

Sound pressure spectrum

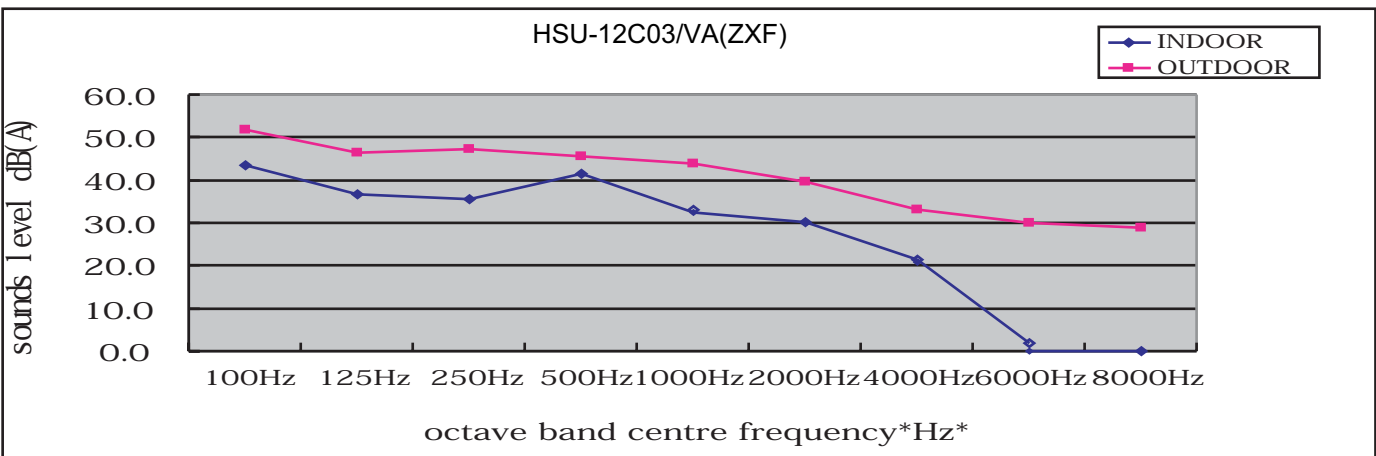
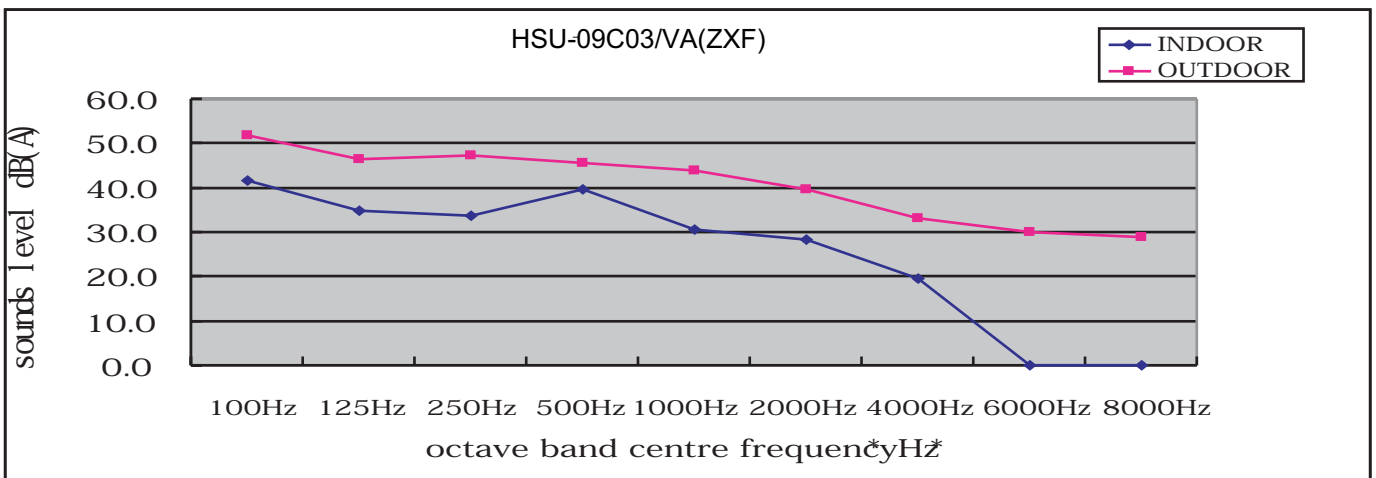

11 Accessories

Standard name	HSU-09C03/VA(ZXF)	HSU-12C03/VA(ZXF)
Drain hose	1	1
Plastic bag	1	1
screw assembly	1	1
Air purifier	2	2
Change for fresh airtube(suit)	1	1
Mounting plate	1	1
Remote controller	1	1
Installation manual	1	1
Operation manual	1	1
Change for fresh air box	1	1

12 Control systems

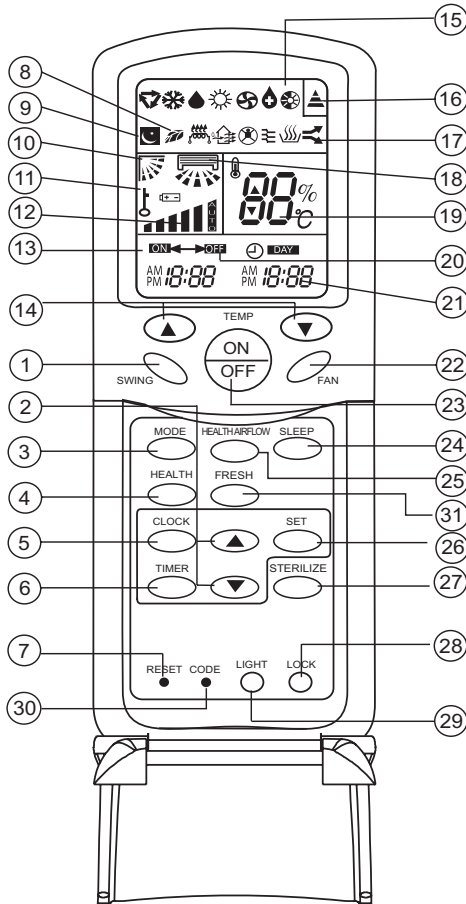

- 1. SWING button
Used to select up or down air sending direction.
- 2. HOUR button
Used to set clock and timer setting.
- 3. MODE button
Used to select operation mode. AUTO, COOL, DRY, FAN.
- 4. HEALTH button
Used to set healthy operation.
- 5. CLOCK button
Used to set correct time.
- 6. TIMER button
Used to select TIMER ON, TIMER OFF, TIMER ON-OFF.
- 7. RESET
When the remote controller appears abnormal, use a sharp pointed article to press this button to reset the remote controller normal
- 8. HEALTH display
- 9. SLEEP display
- 10. SWING UP/DOWN display

- 11. LOCK display
- 12. FAN SPEED display



- 13. TIMER ON display
- 14. TEMP button
Used to select your desired temperature.
- 15. Operation mode display

Operation mode	AUTO	COOL	DRY	FAN
Remote controller				

- 16. Signal sending display
- 17. UV light degerming function display
- 18. Left/right air flow display
- 19. TEMP display
Remote controller: to display the TEMP. setting.
- 20. TIMER OFF display
- 21. CLOCK display
- 22. FAN button
Used to select fan speed: LOW, MED, HI, AUTO
- 23. ON/OFF button
Used for unit start and stop.
- 24. SLEEP button
Used to select sleep mode.
- 25. HEALTH AIRFLOW button
Used to set the healthy airflow mode.
- 26. SET button
Used to confirm timer and clock settings.
- 27. STERILIZE button
Use to set UV light degerming function
- 28. LOCK
Used to lock buttons and LCD display. If pressed, the other buttons will be disabled and the lock condition display appears. Press it once again, lock will be canceled and lock condition display disappears.
- 29. LIGHT button
Colorful display bar of the controlling indoor machine is on and extinguished.
- 30. CODE
Used to select CODE A or B with a press, A or B will be displayed on LCD. Please select A without special explanation.
- 31. FRESH button
Used to set FRESH AIR operation.

NOTE: (1)The following functions and related displays are not available(18), (29), (30) and (31) .
(2) Cooling only unit do not have functions and displays related with heating.

13 Center of gravity

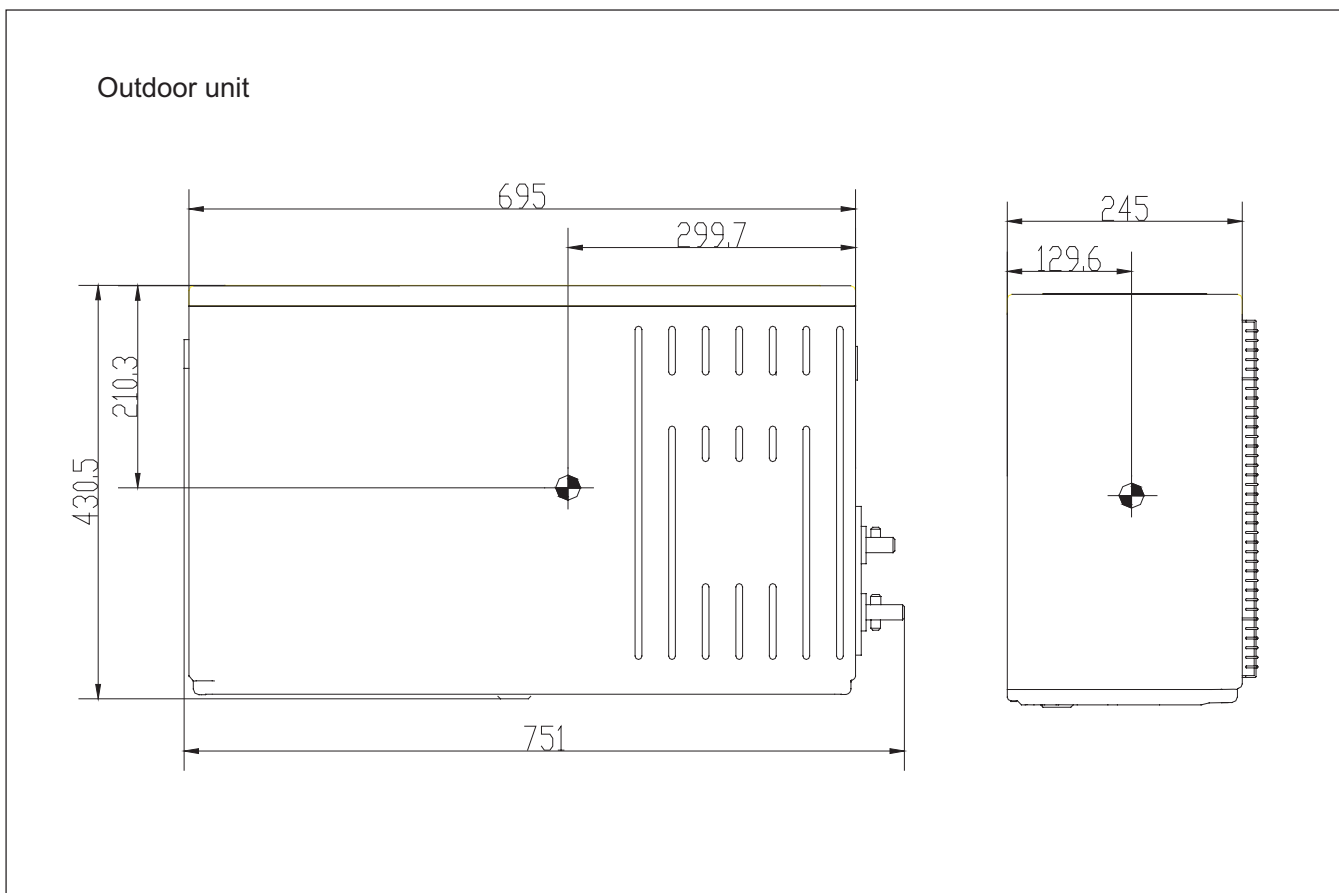
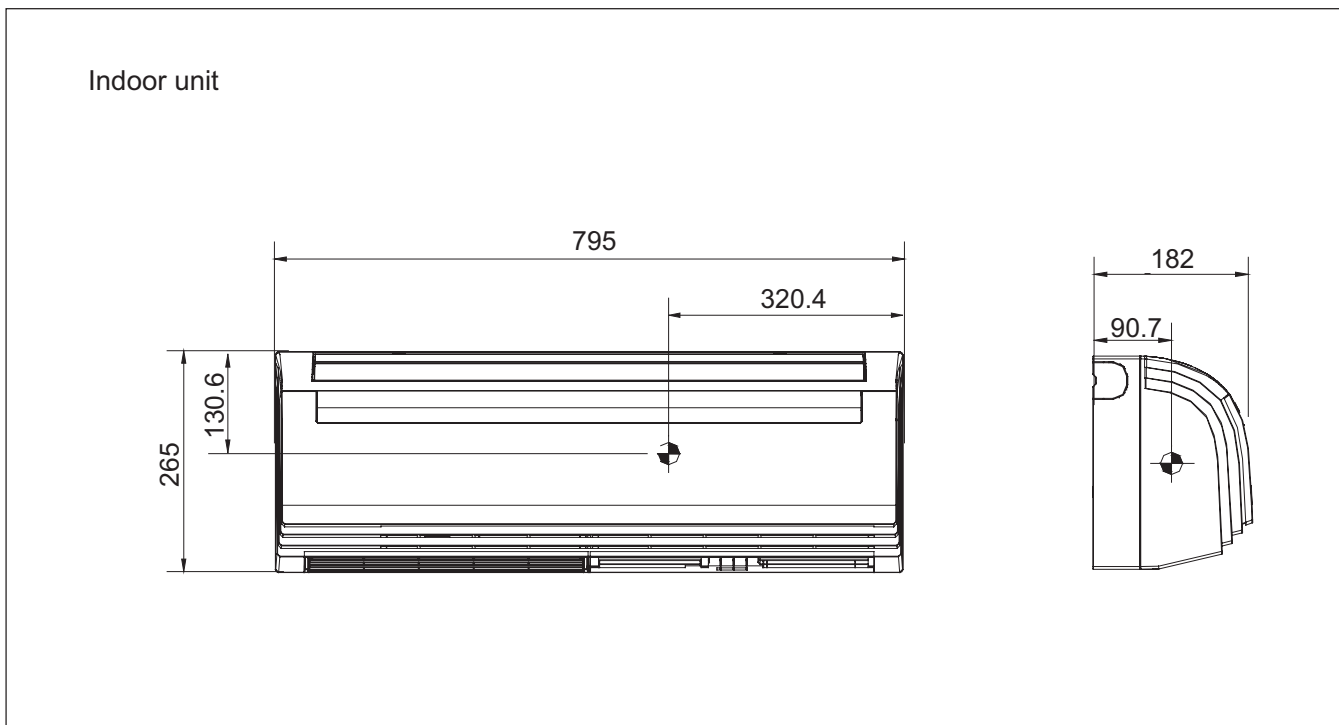

14 Installations

Indoor unit installation drawings

- How to attach the indoor unit.
Hook the claws of the bottom frame to the mounting plate.
If the claws are difficult to hook ,remove the front panel.
- How to remove the indoor unit.
Push up the marked area (at the lower part of the front panel) to release the the claws . If it is difficult to release ,remove the front panel .

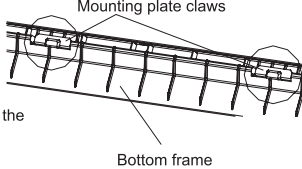

Mounting plate claws
Bottom frame

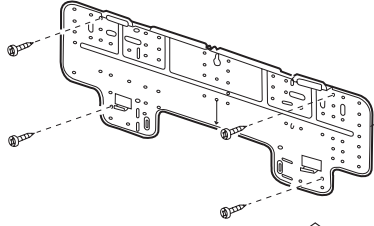

The mounting plate should be installed on a wall which can support the weight of the indoor unit.

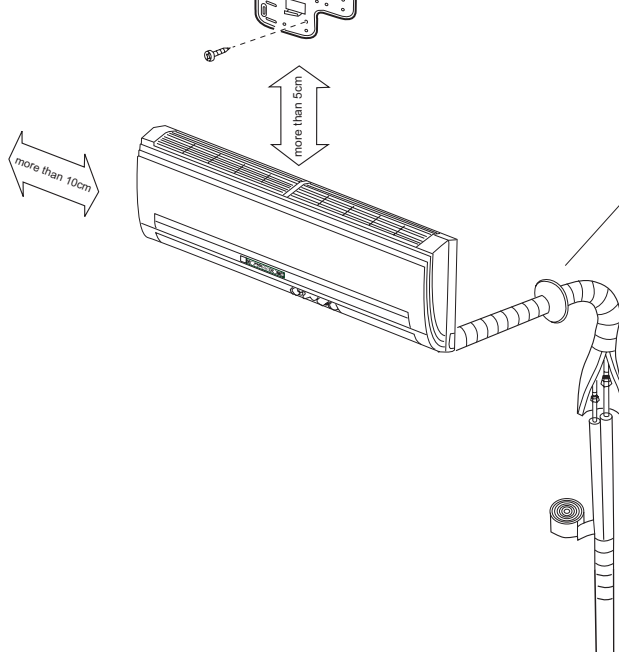

(Section of wall hole)

Indoor side Outdoor side
Wall hole Thickness of wall
66mm
Piping hole pipe

more than 5cm

more than 10cm

more than 10cm

Cut thermal insulation pipe to an appropriate length and wrap it with tape, making sure that no gap is left in the insulation pipe's cut line .

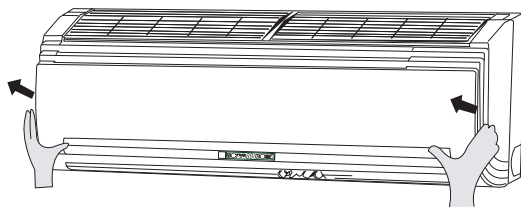

How to remove the air filter.

Open the inlet grille by pulling it upward.

Push up the filter's center tab slightly until it is released from the stopper, and remove the filter downward.

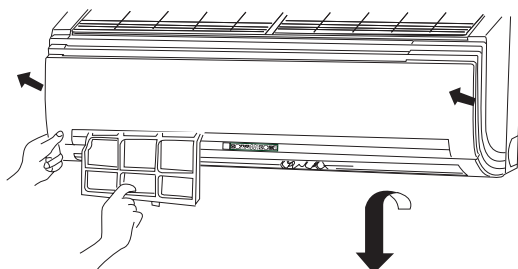

How to Attach the air filter.

Attach the filter correctly so that the "FRONT" indication is facing to the front.Make sure that the filter is completely fixed behind the stopper.If the right and left filters are not attached correctly, that may cause defects.

Close the inlet grille.

Outdoor unit installation drawings

HSU-09,12C03/VA(ZXF)

Outdoor

Model	26/28 class
Max.allowable length	Cooling only: 7 m Heat pump: 7 m
Max.allowable height	5m
Additional refrigerant required for refrigerant pipe exceeding 5m in length	16g/m
Gas pipe	O.D. 9.52/12.7
Liquid pipe	O.D. 6.35/9.52

*Be sure to add the proper amount of additional refrigerant. Failure to do so may result in reduced performance.

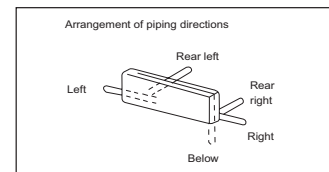

Wrap the installation pipe with the finishing tape from bottom to top Model 25 / 35 class

The distance between the indoor unit and the floor should be more than 2m.

Service lid

- How to remove the service lid. This service lid is an open/close type. Slide the lid downward to remove it.
- How to attach the service lid. Insert the upper part of the service lid into the outdoor unit to install. Tighten the screws.

Where there is a danger of the unit falling, use foot bolts, or wires.

- Fix the unit to concrete or block with bolts (Φ10mm) and nuts firmly and horizontally.
- When fitting the unit to wall surface, roof or rooftop, fix a supporter surely with nails or wires in consideration of earthquake and strong wind.
- If vibration may affect the house, fix the unit by attaching a vibration-proof mat.

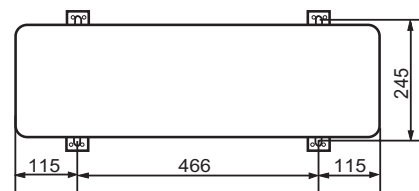

Sincere Forever



Haier Group

Haier Industrial Park, No.1, Haier Road

266101, Qingdao, China

E-mail: hractech@haier.com

Tel: +86 532 87636957

[Http://www.haier.com](http://www.haier.com)

Edited by: Zhao Jicheng

Signed by: Yang Bifei

Approved by: Zhu Zhenxue