



## Domestic Air conditioner

# ***TECHNICAL DATA***

## **ON/OFF**

### Wall mounted Type ARC-Series

HSU-07LE03  
HSU-09LE03  
HSU-12LE03



## CAUTION

1. READ THIS MANUAL CAREFULLY TO  
DIAGNOSE TROUBLE CORRECTLY  
BEFORE OFFERING SERVICE.
2. THIS MANUAL IS USED BY QUALIFIED  
APPLIANCE TECHNICIANS ONLY.
3. HAIER DOES NOT ASSUME ANY  
RESPONSIBILITY FOR PROPERTY  
DAMAGE OR PERSONAL INJURY FOR  
IMPROPER  
SERVICE PROCEDURES DONE BY ONE  
UNQUALIFIED PERSON.

# Table of Contents

<b>1. Features</b> .....	2
<b>2. Specifications</b> .....	3
<b>3. Remote controller lists</b> .....	6
<b>4. Sensors lists</b> .....	6
<b>5. Dimensional drawings</b> .....	7
<b>6. Operation range</b> .....	9
<b>7. Piping diagrams</b> .....	10
<b>8. Wiring diagrams</b> .....	11
<b>9. Capacity diagrams and curves diagrams</b> .....	13
<b>10. Sound level</b> .....	16
<b>11. Accessories</b> .....	19
<b>12. Control systems</b> .....	20
<b>13. Center of gravity</b> .....	22
<b>14. Installations</b> .....	23

# 1 Features



Auto mode: According to the fixed temperature "26°C", the unit will adjust the operation mode automatically.



Sleep mode: The setting temperature and the indoor noise can be adjusted to a more comfortable level when you set the "sleep mode" during night sleep .



Easy clean design: The panel is easy to wash and the airflow vents can be detached without any special tools for quick cleaning of the inside of the air conditioner .



24 Hour timer: Use the timer function to set on, or off, or from on to off, or from off to on .



Auto restart: The function permits automatic return to previous operation conditions after a sudden power blackout .



DRY function: Make dehumidifying in the room when the unit is working in the "DRY" mode .



Healthy negative ion: make your room full of an abundance natural negative ions.

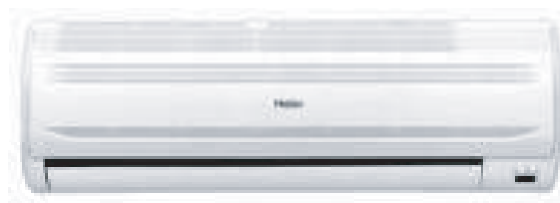

## 2. Specifications

This information was not available at the time of publication .

NOMINAL CAPACITY and NOMINAL INPUT						
Model				HSU-07LE03	HSU-09LE03	HSU-12LE03
NOMINAL CAPACITY(3-4)	Cooling(1)	norm.	kw	2.10	2.60	3.50
	Heating(2)	norm.	kw	-----	-----	-----
NOMINAL INPUT	Cooling	norm	kw	0.73	0.94	1.25
	Heating	norm.	kw	-----	-----	-----
EER	Cooling			2.88	2.77	2.80
COP	Heating			-----	-----	-----
ENERGY LABEL(7-8)	Cooling			----	----	----
	Heating			----	----	----
ANNUAL ENERGY CONSUMPTION(9)	Cooling		kwh	307.5	396.5	530

TECHNICAL SPECIFICATIONS						
INDOOR UNITS				HSU-07LE03	HSU-09LE03	HSU-12LE03
DIMENSIONS	Unit	H	mm	265		
		W	mm	795		
		D	mm	182		
WEIGHT	Unit		kg	7.2		
COLOR	Unit			white		
SOUND LEVEL	Sound pressure (cooling/heating)(5)	high	dB(A)	48	48	48
		medium	dB(A)	42	42	42
		low	dB(A)	39	39	39
	Sound power(cooling/heating)(6)	high	dB(A)	48	48	39
FAN	Air flow rate(cooling/heating)	high	m <sup>3</sup> /min	6.7	7.5	8.3
		low	m <sup>3</sup> /min	6.0	6.7	7.5
		super low	m <sup>3</sup> /min	5.2	6.0	6.9
	Speed(cooling/heating)	steps		5steps,silent and auto		
		high	rpm	1100	1150	1290
		medium	rpm	1050	1050	1150
		low	rpm	900	920	1000
Type	Cross flow fan					
Motor output		W	16	16	16	
AIR FILTER	Removable/washable/mildew proof					
REMOTE CONTROLLER	YL-M07EN					
TEMPERATURE CONTROL	Microcomputer control					
PIPING CONNECTIONS(external diameter)	liquid	mm	Φ 6.35	Φ 6.35	Φ 6.35	
	gas	mm	Φ 9.52	Φ 9.52	Φ 12.7	
	drain	mm	Φ 16	Φ 16	Φ 16	
INSULATION MATERIAL	Heat insulation type				both liquid and gas pipes	
HEAT EXCHANGGER	TYPE		ML fin - Φ 9.52HI - XA tube			
	Row x stage x fin pinth		mm	2 x 8 x 1.4		

TECHNICAL SPECIFICATIONS						
OUTDOOR UNITS				HSU-07LE03	HSU-09LE03	HSU-12LE03
NET DIMENSIONS (stop valve, and bottom support is not included)	Unit	H	mm	430		
		W	mm	695		
		D	mm	245		
WEIGHT	Unit		kg	21.5	24.2	28.8
COLOR	Unit	white				
SOUND LEVEL	Sound pressure(cooling/heating)(5)	high	dB(A)	58	58	58
	Sound power(cooling/heating)(6)	high	dB(A)	58	58	58
FAN	Air flow rate(cooling/heating)	high	m <sup>3</sup> /min	18	20	22
		low	m <sup>3</sup> /min	---	---	---
	Speed(cooling/heating)	high	rpm	830	830	1060
		low	rpm	---	---	---
	Type	Propeller fan				
	Motor output		W	60	60	60
REFRIGERANT CIRCUIT	Refrigerant type	R22				
	Refrigerant charge		kg	0.40	0.44	0.69
	Maximum allowable distance between indoor and outdoor		m	7		
	Maximum allowable level difference		m	5		
	Refrigerant control	-----				
COMPRESSOR	Type	rotary Compressor				
	Model	44R233CF-5JSC/44R233CF-5JSC 48R313NI-5ESE				
	Motor output		w	680	790	970
	Oil type	SUNISO SUNISO SUNISO				
	Oil charge volume		L	0.27	0.27	0.52
PIPING CONNECTIONS	liquid		mm	Φ 6.35		
	gas		mm	Φ 9.52/ Φ12.7		
	drain		mm	Φ 18		
INSULATION MATERIAL	Heat insulation type			both liquid and gas pipes		
HEAT EXCHANGGER	TYPE			ML - Φ9.52HI - XAbube		
	Row x stage x fin pinth		mm	2 x 8 x1.4		

ELECTRICAL SPECIFICATIONS						
For indoor units only:				HSU-07LE03	HSU-09LE03	HSU-12LE03
CURRENT	Nominal running current	cooling	A	0.15	0.15	0.15
		heating	A	-----	-----	-----
	Maximum running current	cooling	A	0.15	0.15	0.15
		heating	A	-----	-----	-----

For combination indoor units+ outdoor units:				HSU-07LE03	HSU-09LE03	HSU-12LE03
CURRENT	Nominal running current	cooling	A	3.5	4.5	5.9
		heating	A	-----	-----	-----
	Maximum running current	cooling	A	4.6	6.2	7.5
		heating	A	-----	-----	-----
	Starting current	cooling	A	18	22	32
		heating	A	-----	-----	-----

For indoor units only:				HSU-07LE03	HSU-09LE03	HSU-12LE03
POWER SUPPLY				VM	VM	VM
NOMINAL DISTRIBUTION SYSTEM VOLTAGE	Phase			1PH	1PH	1PH
	Frequency	Hz		50	50	50
	Voltage	V		220V~	220V~	220V~

## NOTES

- 1 Nominal cooling capacities are based on: indoor temperature 27°CDB/19°CWB \* outdoor temperature 35°CDB \* refrigerant piping length: 5m \* level difference: 0m.
- 2 Nominal heating capacities are based on: indoor temperature 20°CDB \* outdoor temperature 7°CDB/6°CWB \* refrigerant piping length 5m (horizontal) \* level difference 0m.
- 3 Capacities are net, including a deduction for cooling (an addition for heating) for indoor fan motor heat.
- 4 Units should be selected on nominal capacity. Maximum capacity is limited to peak periods.
- 5 The sound pressure level is measured via a microphone at a certain distance from the unit. For measuring conditions: please refer to item 6 of this chapter.
- 6 The sound power level is an absolute value indicating the "power" which a sound source generates.
- 7 Energy label: scale from A (most efficient) to G (less efficient).
- 8 The energy label Directive 2002/31/EC will enter into force once the relevant measurement standard will be published in the European official Standard.
- 9 Annual energy consumption: based on average use of 500 running hours per year at full load (= nominal conditions)

### 3 Remote controller lists

Model	HSU-07LE03	HSU-09LE03	HSU-12LE03
YL-M07	Y	Y	Y
YL-H10	Y	Y	Y

### 4 Sensors lists

INDOOR UNIT		
type	Description	Qty
Room sensor	It's used for detecting room temperature	1
Pipe sensor	It's used for detecting temperature of evaporator	1

# 5 Dimensional drawings

Indoor unit

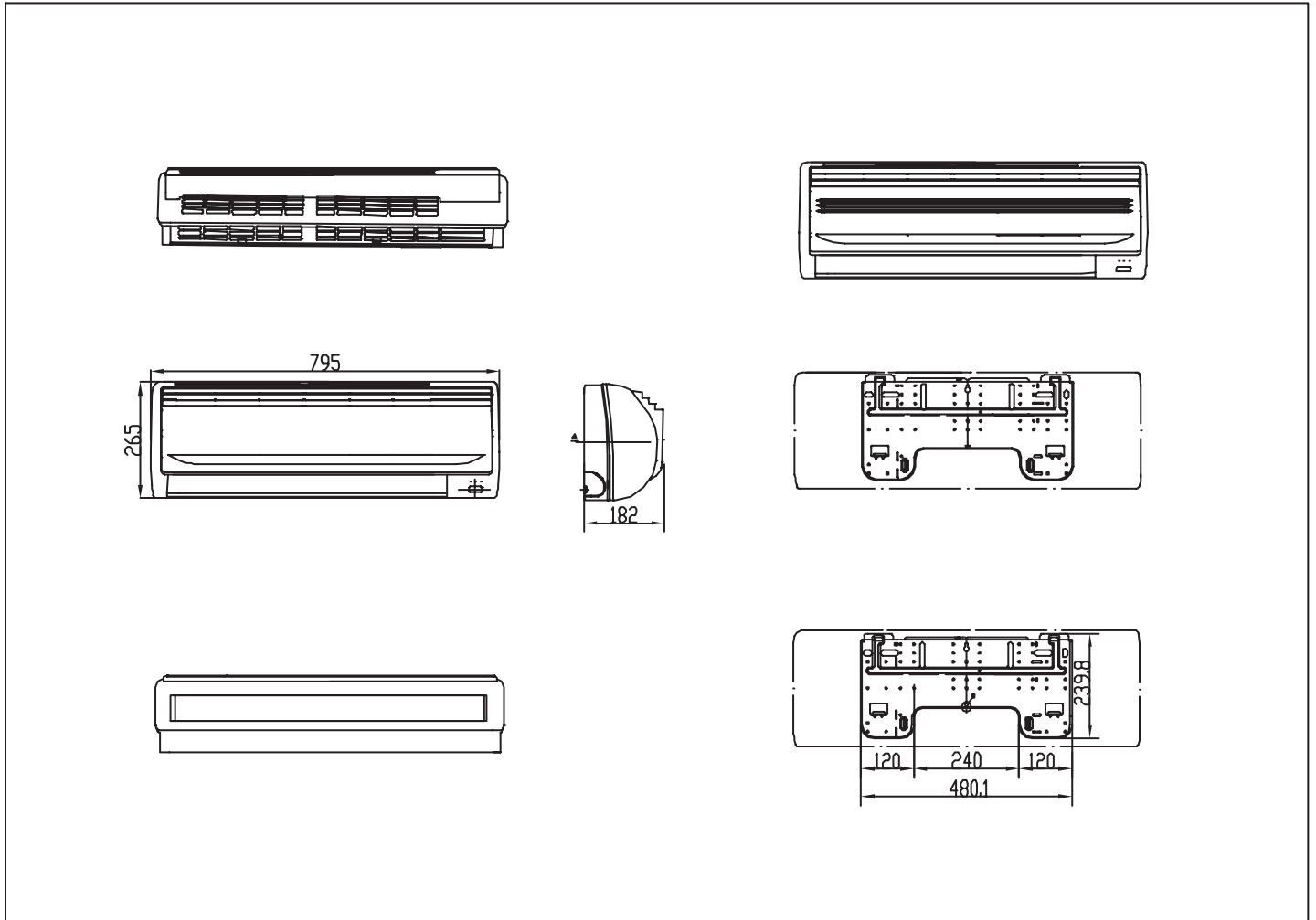



# Outdoor unit

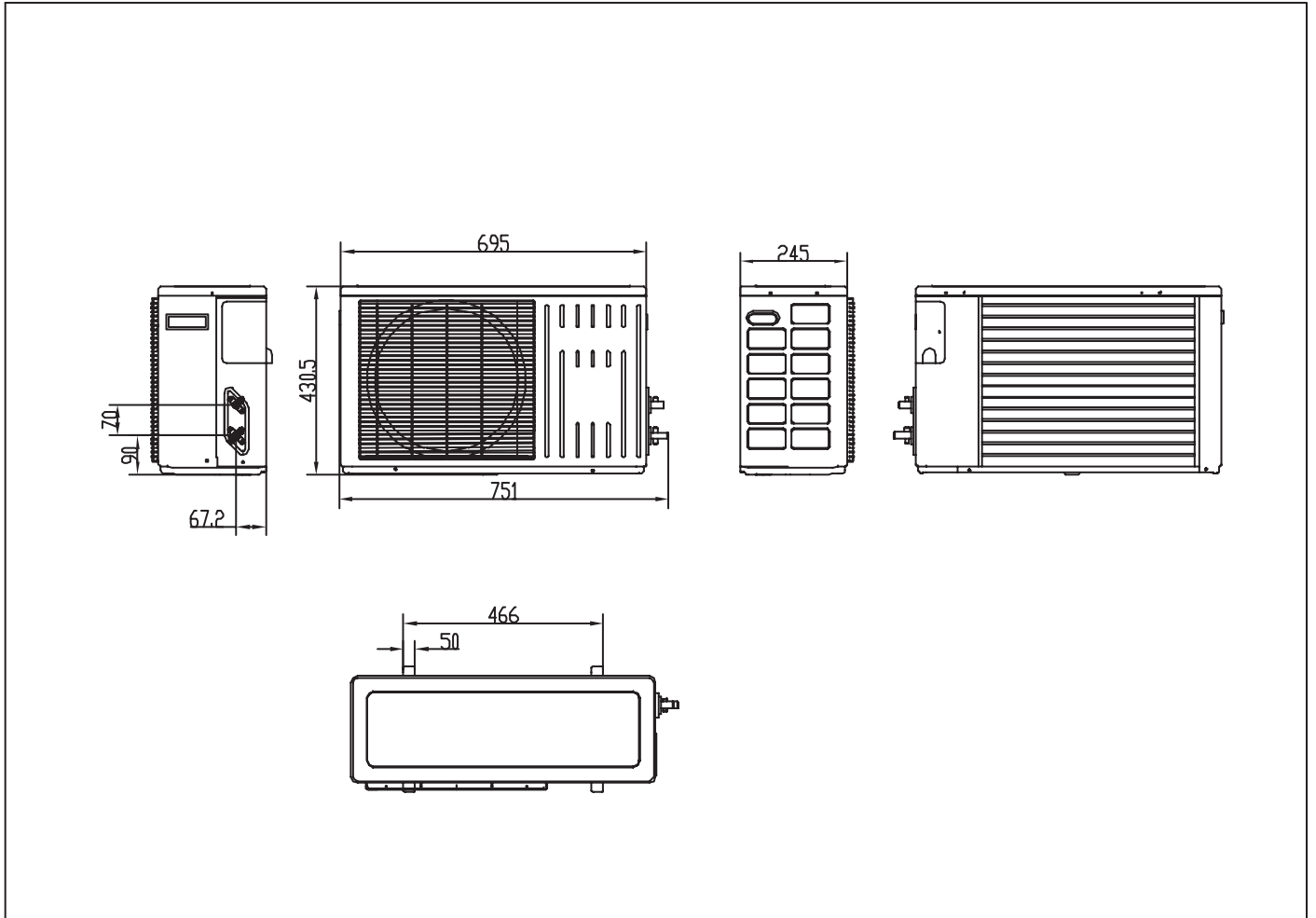

# 6 Operation range

The name of parts

Cooling

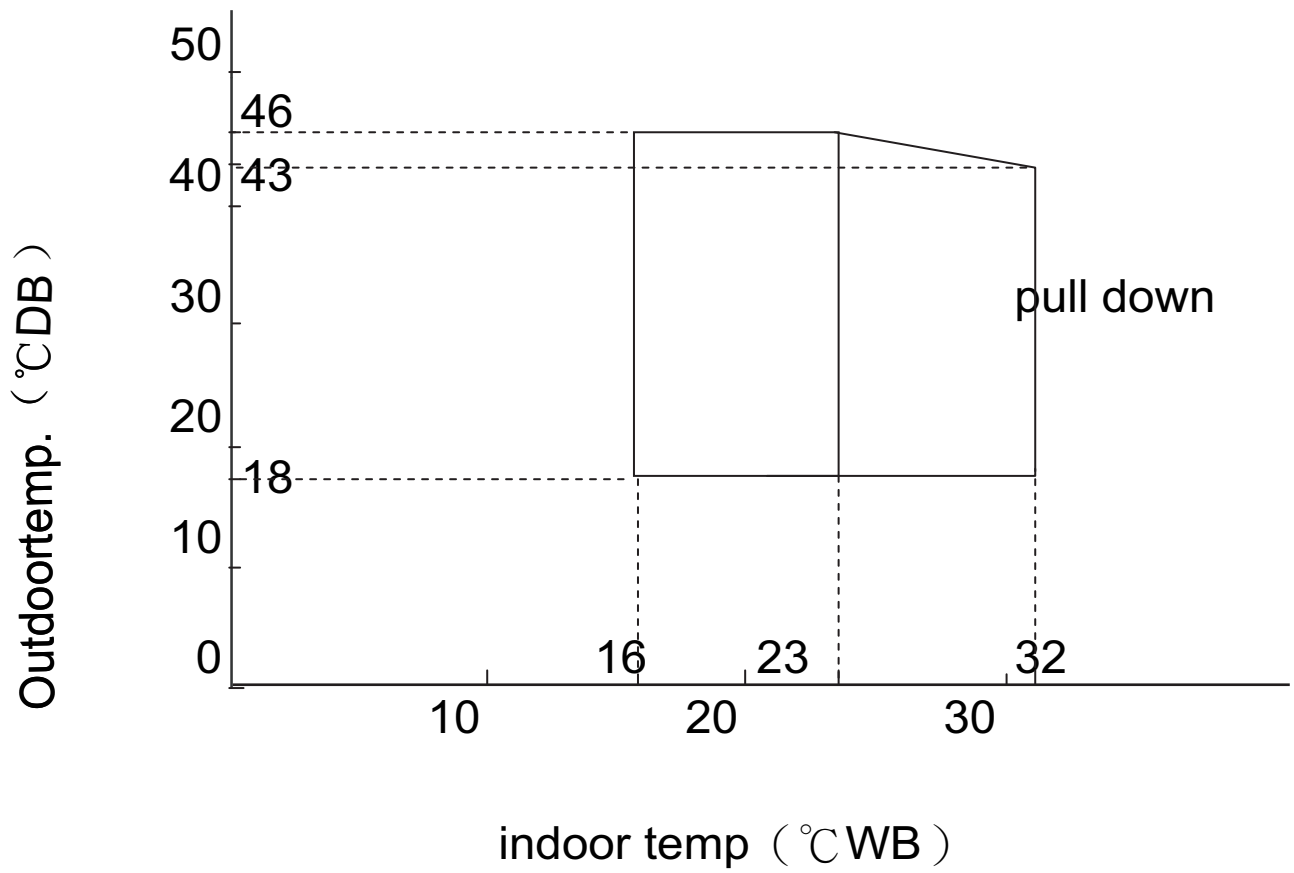

# 7 Piping diagrams

## Cooling mode

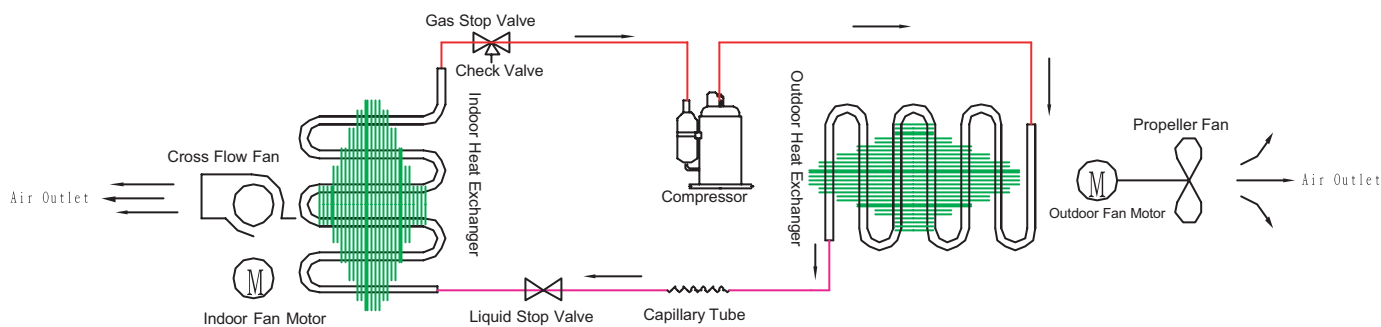

# 8 Wiring diagrams

## Indoor unit

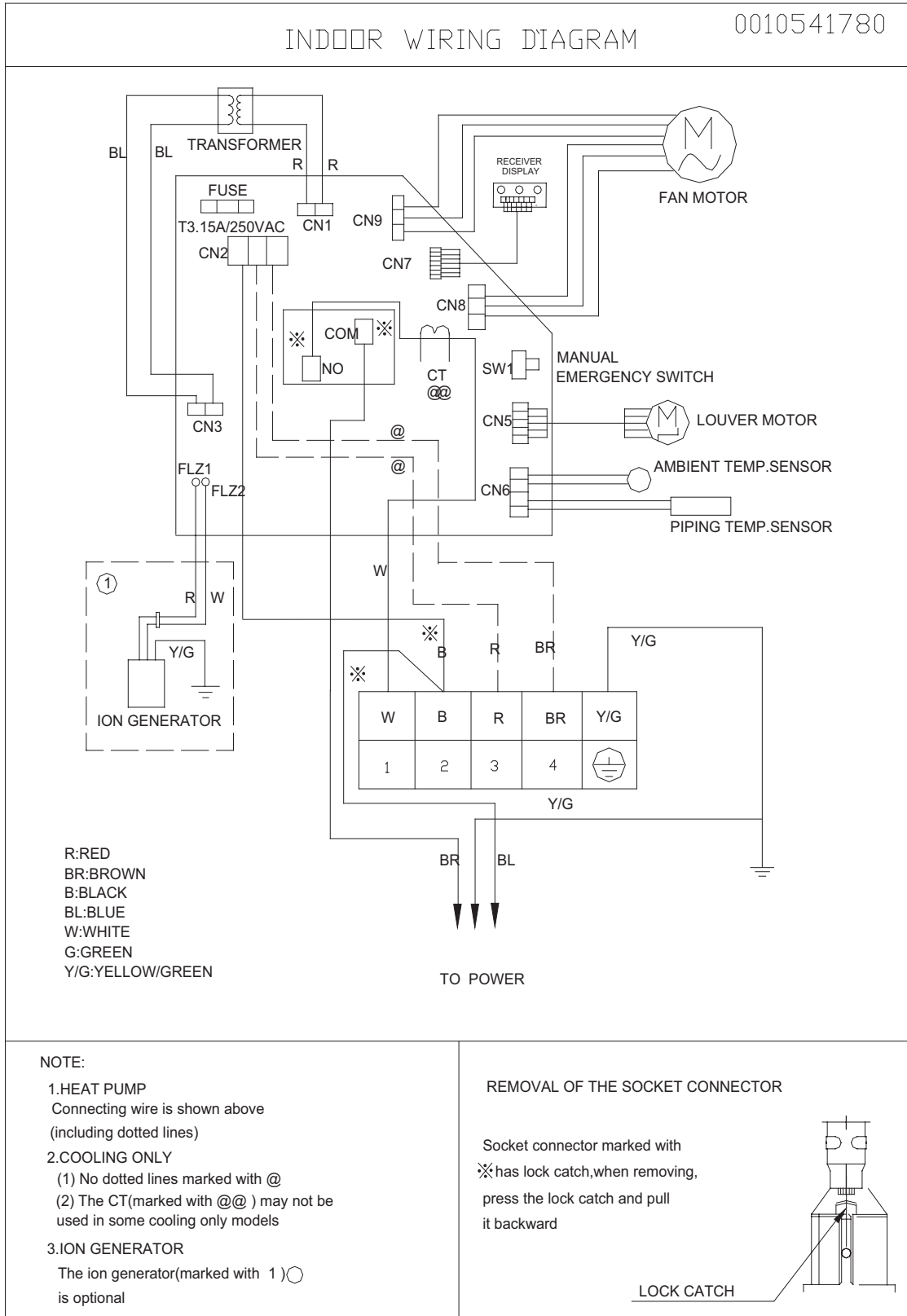

# Outdoor unit

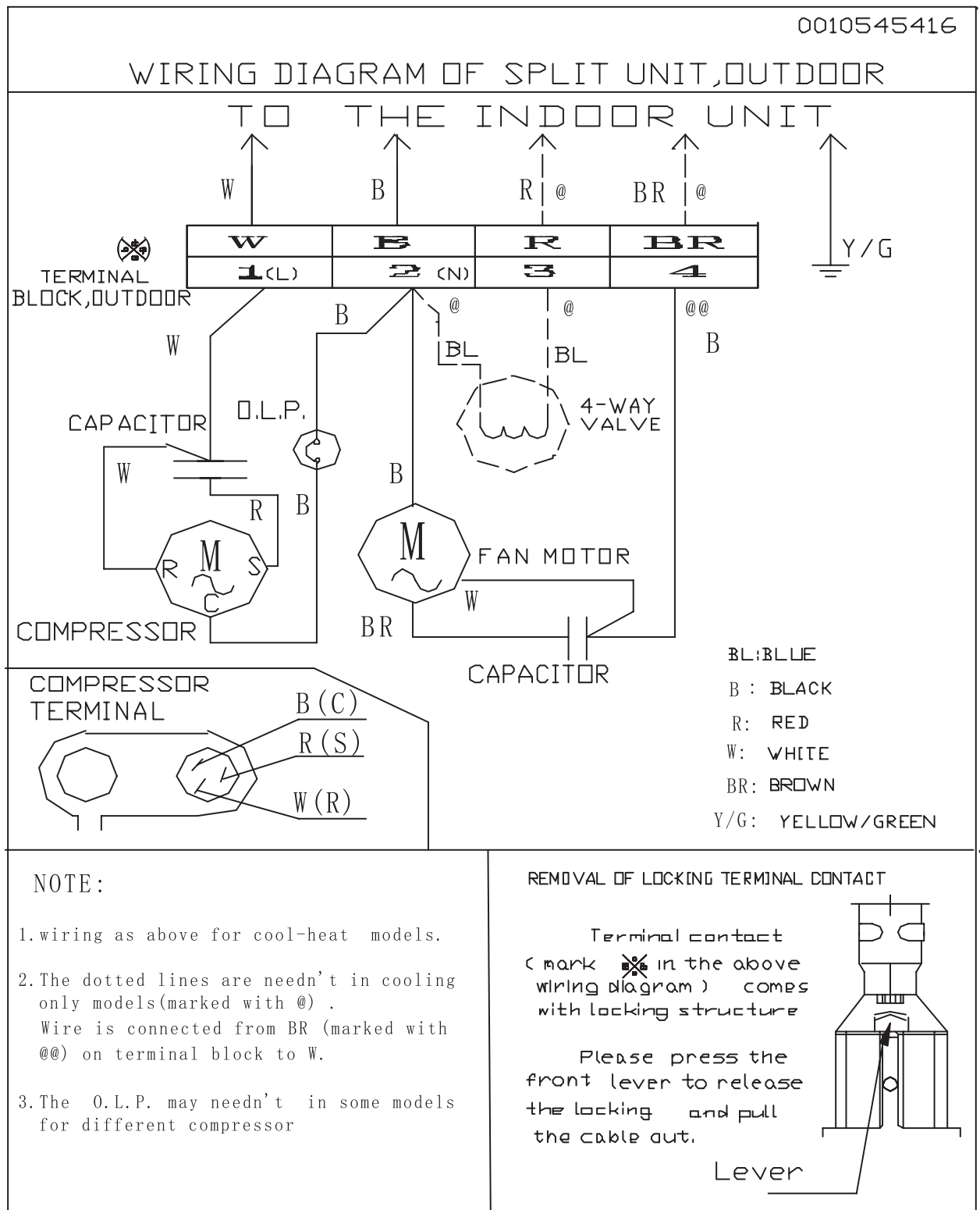

## 9 Capacity tables and curves diagrams

HSU-07LE03 performance curves								
cooling value-temperature talbe								
indoor temp	outdoor temp.(humidity 46%)							
DB/WB	18℃	20℃	25℃	32℃	35℃	40℃	43℃	46℃
18/12℃	1286	1297	1307	1086	1096	1139	989	773
18/14℃	1769	1780	1847	1595	1558	1428	1316	1130
20/15℃	2251	2264	2277	2182	2020	1859	1723	1487
22/16℃	2197	2213	2230	2162	1987	1781	1642	1477
25/18℃	2144	2163	2182	2141	1954	1768	1645	1449
27/19℃	2405	2315	2365	2202	2100	1949	1826	1602
30/22℃	2682	2534	2722	2428	2298	2168	1996	1849
32/23℃	2782	2518	2728	2399	2342	2233	2105	1877
32/24℃	2861	2592	2806	2471	2413	2301	2170	1940

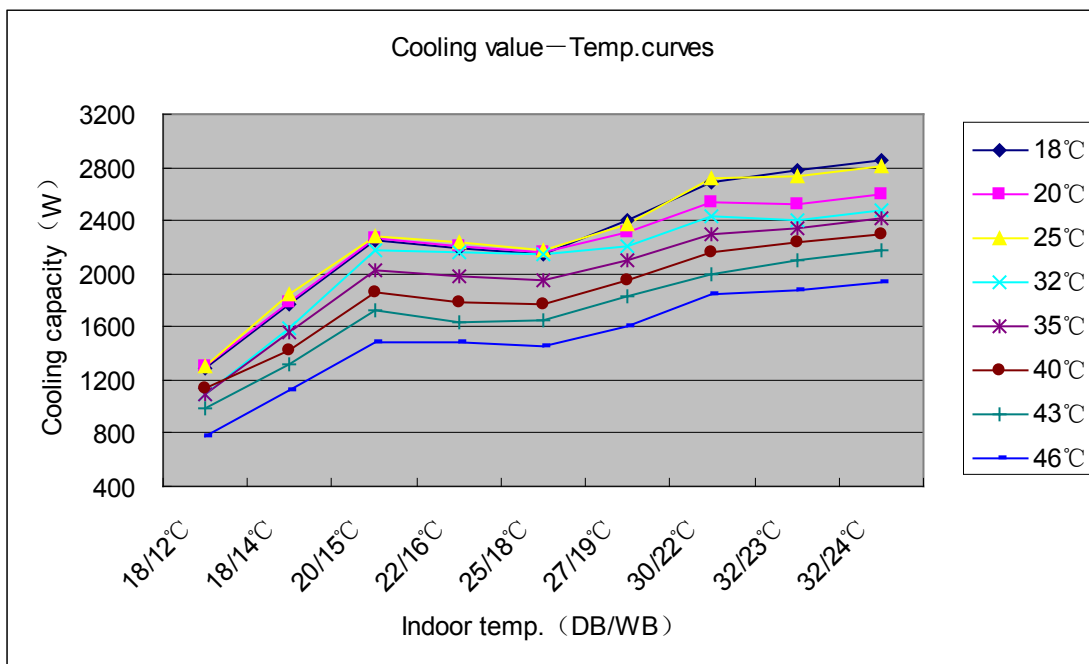

HSU-09LE03 performance curves								
cooling value-temperature talbe								
indoor temp	outdoor temp.(humidity 46%)							
DB/WB	18℃	20℃	25℃	32℃	35℃	40℃	43℃	46℃
18/12℃	1786	1797	1807	1586	1596	1639	1489	1273
18/14℃	2269	2280	2347	2095	2058	1928	1816	1630
20/15℃	2751	2764	2777	2682	2520	2359	2223	1987
22/16℃	2697	2713	2730	2662	2487	2281	2142	1977
25/18℃	2644	2663	2682	2641	2454	2268	2145	1949
27/19℃	2905	2815	2865	2702	2600	2449	2326	2102
30/22℃	3182	3034	3222	2928	2798	2668	2496	2349
32/23℃	3282	3018	3228	2899	2842	2733	2605	2377
32/24℃	3361	3092	3306	2971	2913	2801	2670	2440

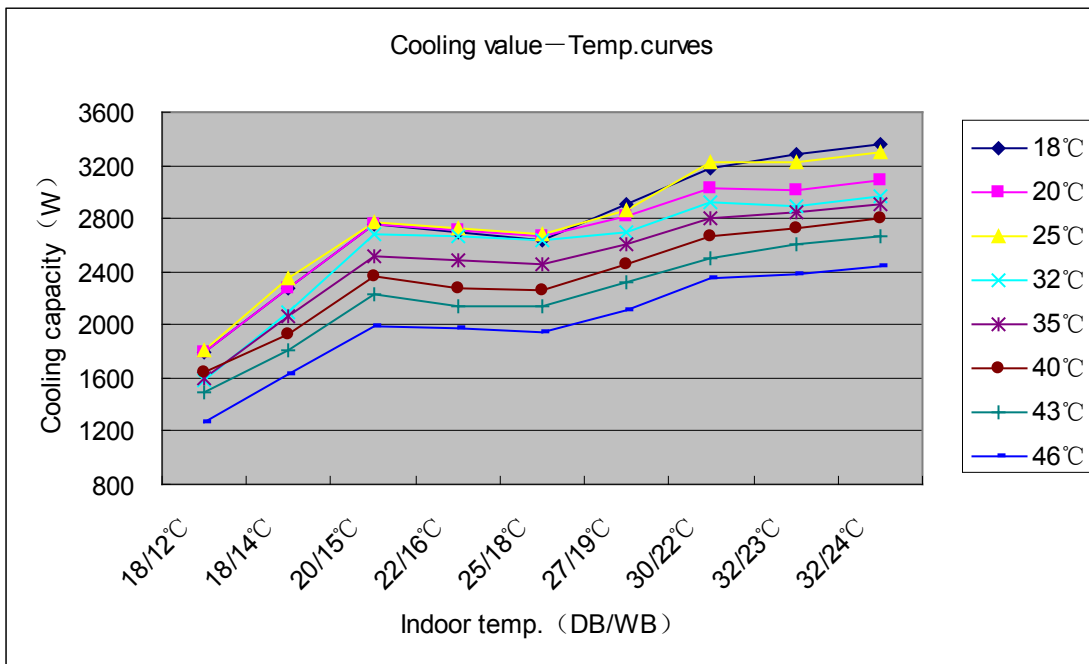

HSU-12LE03 performance curves								
cooling value-temperature talbe								
indoor temp	outdoor temp.(humidity 46%)							
DB/WB	18°C	20°C	25°C	32°C	35°C	40°C	43°C	46°C
18/12°C	2686	2697	2707	2486	2496	2539	2389	2173
18/14°C	3169	3180	3247	2995	2958	2828	2716	2530
20/15°C	3651	3664	3677	3582	3420	3259	3123	2887
22/16°C	3597	3613	3630	3562	3387	3181	3042	2877
25/18°C	3544	3563	3582	3541	3354	3168	3045	2849
27/19°C	3805	3715	3765	3602	3500	3349	3226	3002
30/22°C	4082	3934	4122	3828	3698	3568	3396	3249
32/23°C	4182	3918	4128	3799	3742	3633	3505	3277
32/24°C	4261	3992	4206	3871	3813	3701	3570	3340

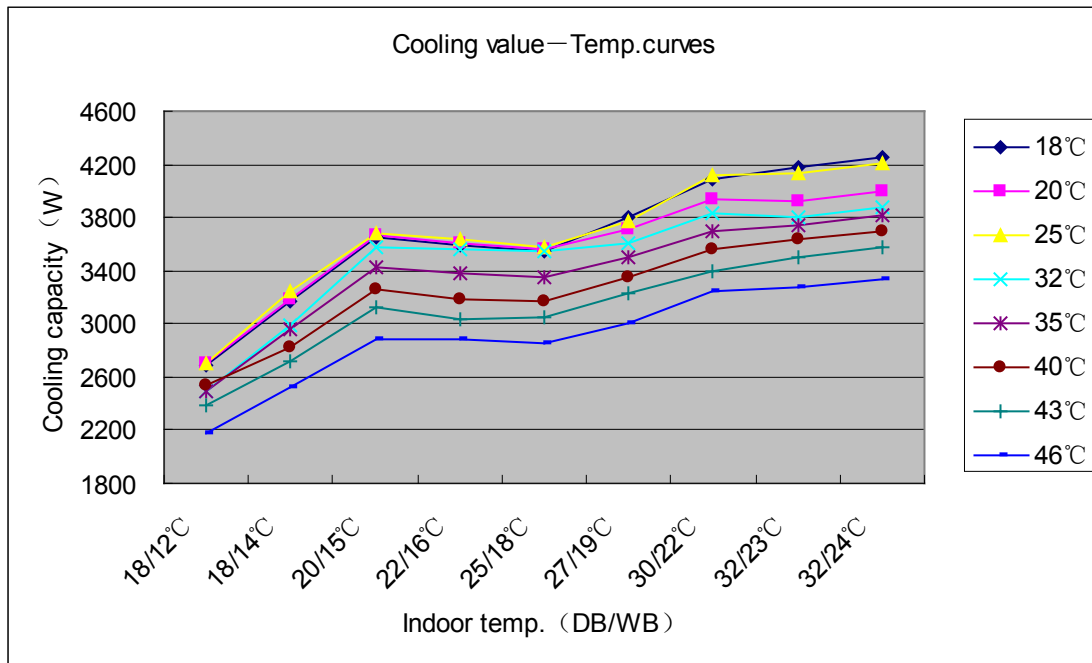

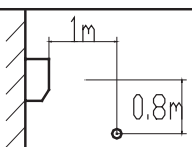

# 10 Sound level

Model	Sound pressure level			Measuring location Location of microphone 	sound power level
	220 ~ V,50Hz				
	Cooling				
	H	L	SL		
HSU-07LE03	48	42	39		48
HSU-09LE03	48	42	39		48
HSU-12LE03	48	42	39		48

## Sound level data

HSU-07LE03	100Hz	125Hz	250Hz	500Hz	1000Hz	2000Hz	4000Hz	6000Hz	8000Hz
INDOOR	41.7	34.7	33.6	32.6	30.5	28.2	19.7	0.0	0.0
OUTDOOR	51.7	46.5	47.2	45.6	43.9	39.7	33.0	29.9	28.9

## Sound pressure spectrum

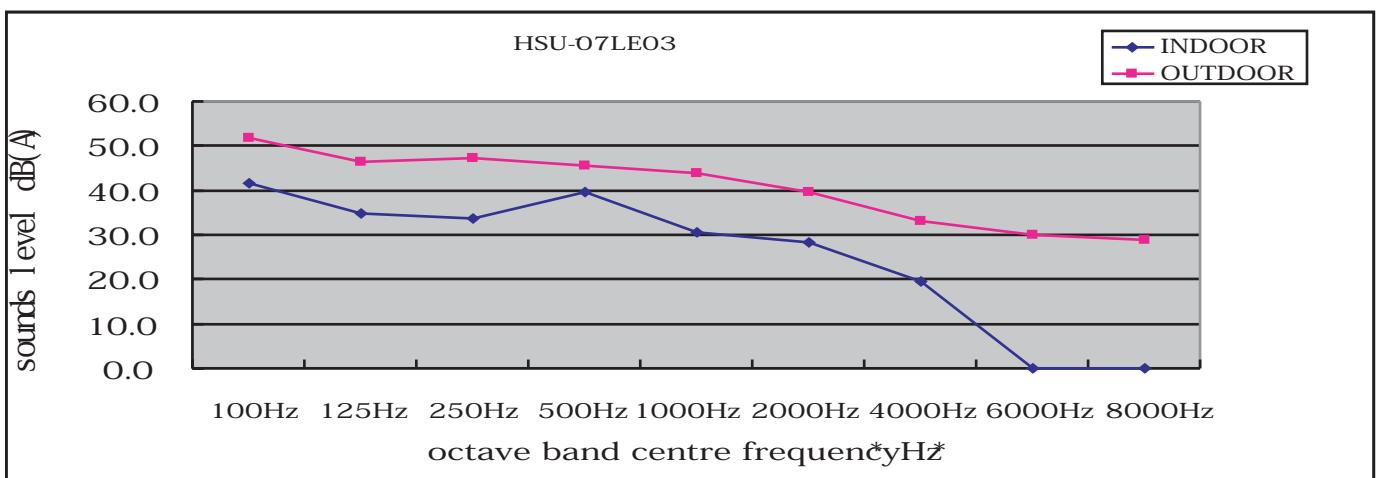

### Sound level data

HSU-09LE03	100Hz	125Hz	250Hz	500Hz	1000Hz	2000Hz	4000Hz	6000Hz	8000Hz
INDOOR	41.7	34.7	33.6	32.6	30.5	28.2	19.7	0.0	0.0
OUTDOOR	51.7	46.5	47.2	45.6	43.9	39.7	33.0	29.9	28.9

### Sound pressure spectrum

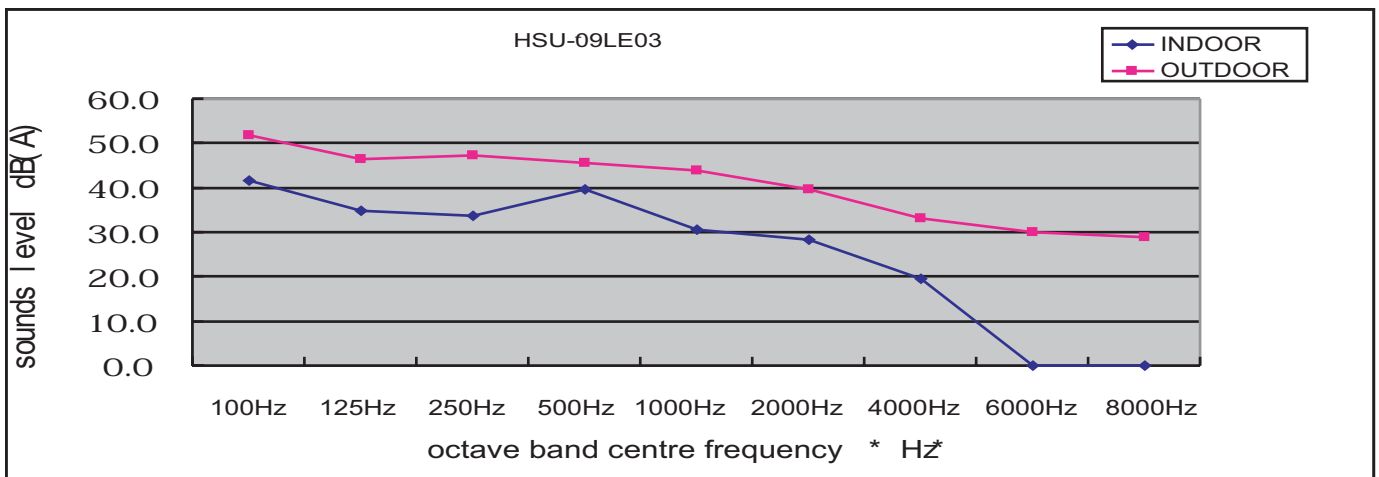

### Sound level data

HSU-12LE03	100Hz	125Hz	250Hz	500Hz	1000Hz	2000Hz	4000Hz	6000Hz	8000Hz
INDOOR	42.4	35.2	34.6	33.6	31.4	29.1	20.1	0.0	0.0
OUTDOOR	52.7	49.7	48.2	46.3	44.2	40.1	35.0	30.2	29.9

### Sound pressure spectrum

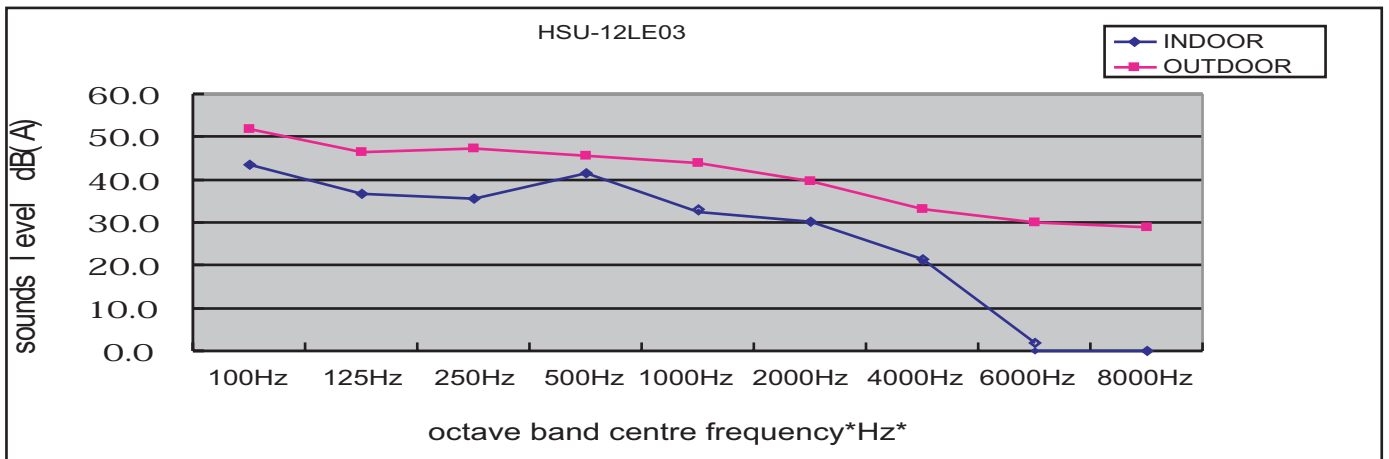

# 11 Accessories

## Standard accessories

Standard name	HSU-07LE03	HSU-09LE03	HSU-12LE03
Drain hose	1	1	1
Plastic bag	1	1	1
screw assembly	1	1	1
Air purifier	2	2	2
Battery	2	2	2
Mounting plate	1	1	1
Remote controller	1	1	1
Installation manual	1	1	1
Operation manual	1	1	1

## 12 Control systems

### Operation

Buttons and display of the remote controller.

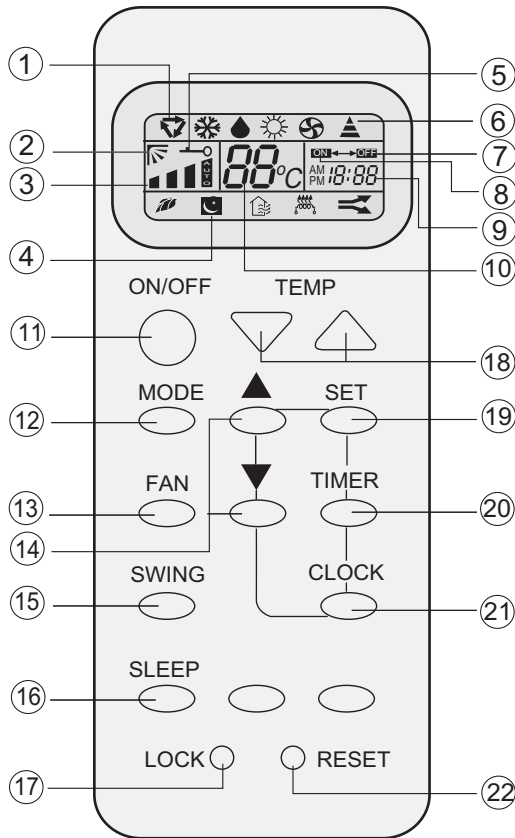

#### 1. Mode display

AUTO

COOL

DRY

HEAT

FAN

#### 2. SWING display

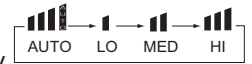

#### 3. FAN SPEED display

#### 4. SLEEP display

#### 5. LOCK display

#### 6. SIGNAL SENDING

#### 7. TIMER OFF display

#### 8. TIMER ON display

#### 9. CLOCK display

#### 10. TEMP display

#### 11. POWER ON/OFF

Used for unit start and stop.

#### 12. MODE

Used to select AUTO run, COOL, DRY, HEAT and FAN operation

#### 13. FAN

Used to select fan speed LO, MED, HI, AUTO

#### 14. HOUR

Used to set clock and timer setting.

#### 15. SWING

Used to set auto fan direction.

#### 16. SLEEP

Used to select sleep mode.

#### 17. LOCK

Used to lock buttons and LCD display.

#### 18. TEMP.

Used to select your desired temp.

#### 19. SET

Used to confirm timer and clock settings.

#### 20. TIMER

Used to select TIMER ON, TIMER OFF, TIMER ON-OFF

#### 21. CLOCK

Used to set correct time

#### 22. RESET

Used to reset the controller back to normal condition.

### Clock set

When unit is started for the first time and after replacing batteries in remote controller, clock should be adjusted as follows:

Press CLOCK button, "AM" or "PM" flashes.

Press  $\Delta$  or  $\nabla$  to set correct time. Each press will increase or decrease 1min. If the button is kept depressed, time will change quickly.

After time setting is confirmed, press SET, "AM" and "PM" stop flashing, while clock starts working.

NOTE: Cooling only unit do not have displays and functions related with heating

### Hints





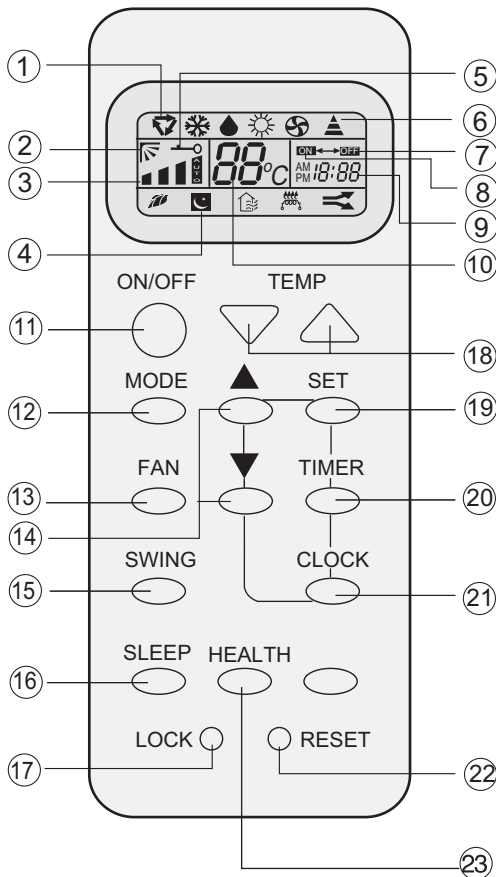

After replacing with new batteries, remote controller will conduct self-check, displaying all information on LCD. Then, it will become normal.

## Operation

### Buttons and display of the remote controller.

If the unit which you purchased has healthy function, Remote controller should like the following figure:



1. Mode display  
 AUTO   
 COOL   
 DRY   
 HEAT   
 FAN 
2. SWING display 
3. FAN SPEED display 
4. SLEEP display
5. LOCK display
6. SIGNAL SENDING
7. TIMER OFF display
8. TIMER ON display
9. CLOCK display
10. TEMP display
11. POWER ON/OFF  
Used for unit start and stop.
12. MODE  
Used to select AUTO run, COOL, DRY, HEAT and FAN operation
13. FAN  
Used to select fan speed LO, MED, HI, AUTO
14. HOUR  
Used to set clock and timer setting.
15. SWING  
Used to set auto fan direction.
16. SLEEP  
Used to select sleep mode.
17. LOCK  
Used to lock buttons and LCD display.
18. TEMP.  
Used to select your desired temp.
19. SET  
Used to confirm timer and clock settings.
20. TIMER  
Used to select TIMER ON, TIMER OFF, TIMER ON-OFF
21. CLOCK  
Used to set correct time
22. RESET  
Used to reset the controller back to normal condition.
23. HEALTH  
Used to set healthy operation

#### BRIEF INTRODUCTION TO HEALTH OPERATION

The anion generator in the air conditioner can generate a lot of anion to effectively balance the quantity of position and anion in the air and also to kill bacteria and speed up the dust sediment in the room and finally clean the air in the room.

NOTE: Cooling only unit do not have displays and functions related with heating

#### Hints

After replacing with new batteries, remote controller will conduct self-check, displaying all information on LCD. Then, it will become normal.

### 13 Center of gravity

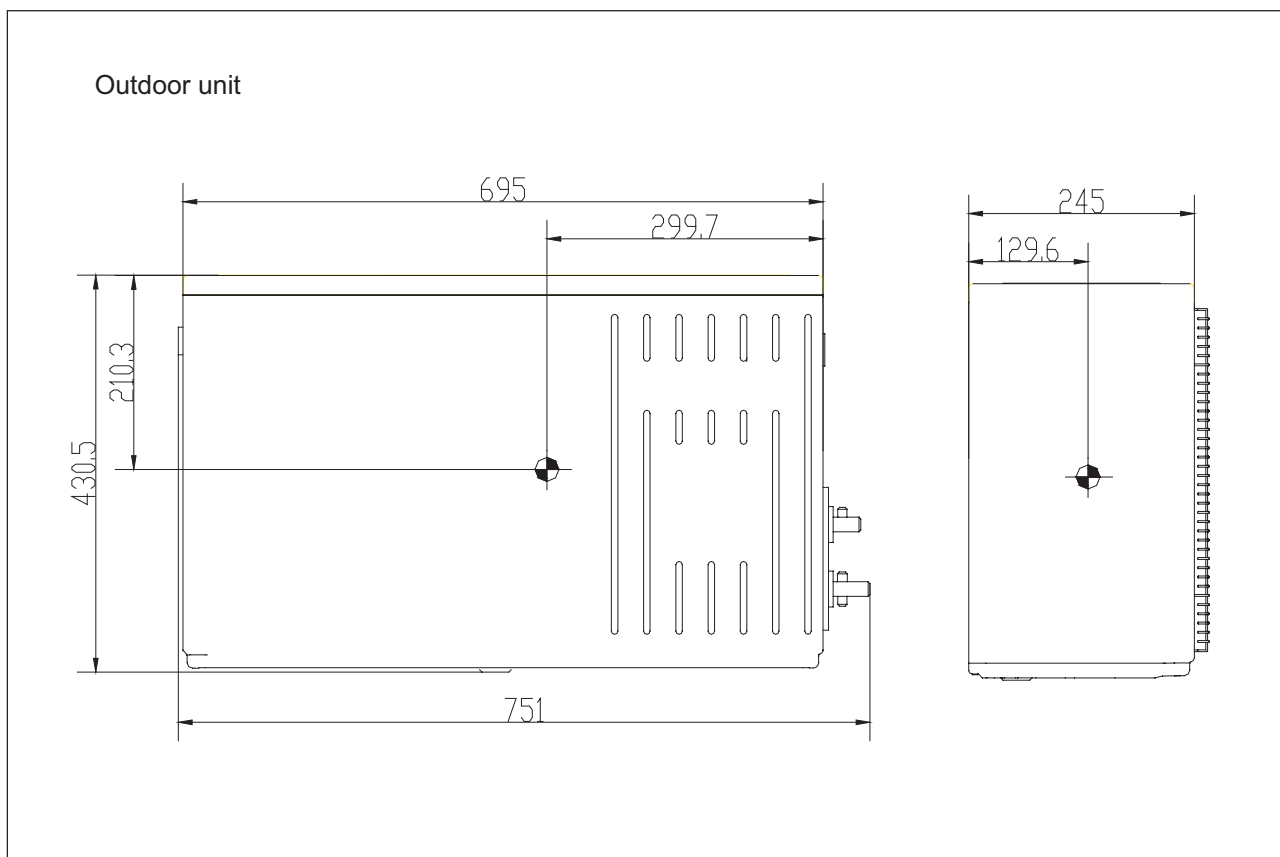
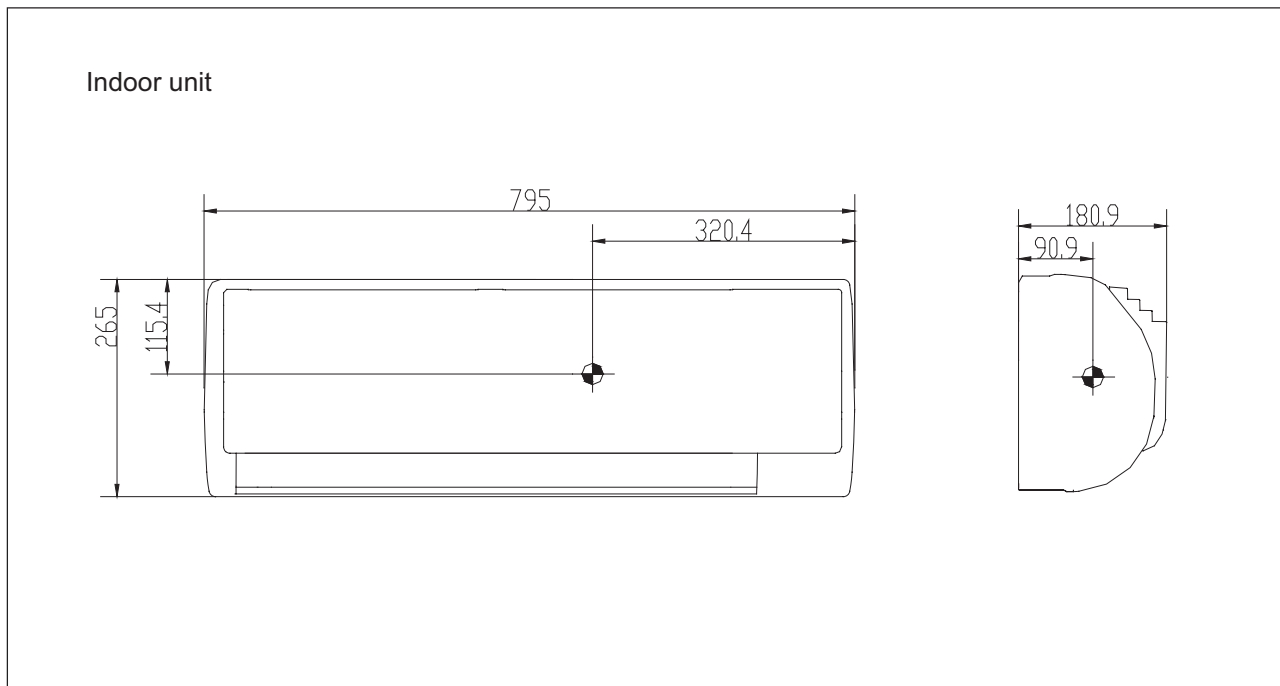

# 14 Installations

## Indoor unit installation drawings

- How to attach the indoor unit.  
Hook the claws of the bottom frame to the mounting plate.  
If the claws are difficult to hook ,remove the front panel.
- How to remove the indoor unit.  
Push up the marked area (at the lower part of the front panel ) to release the the claws . If it is difficult to release ,remove the front panel .

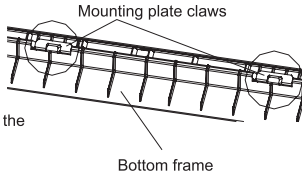

Mounting plate claws  
Bottom frame

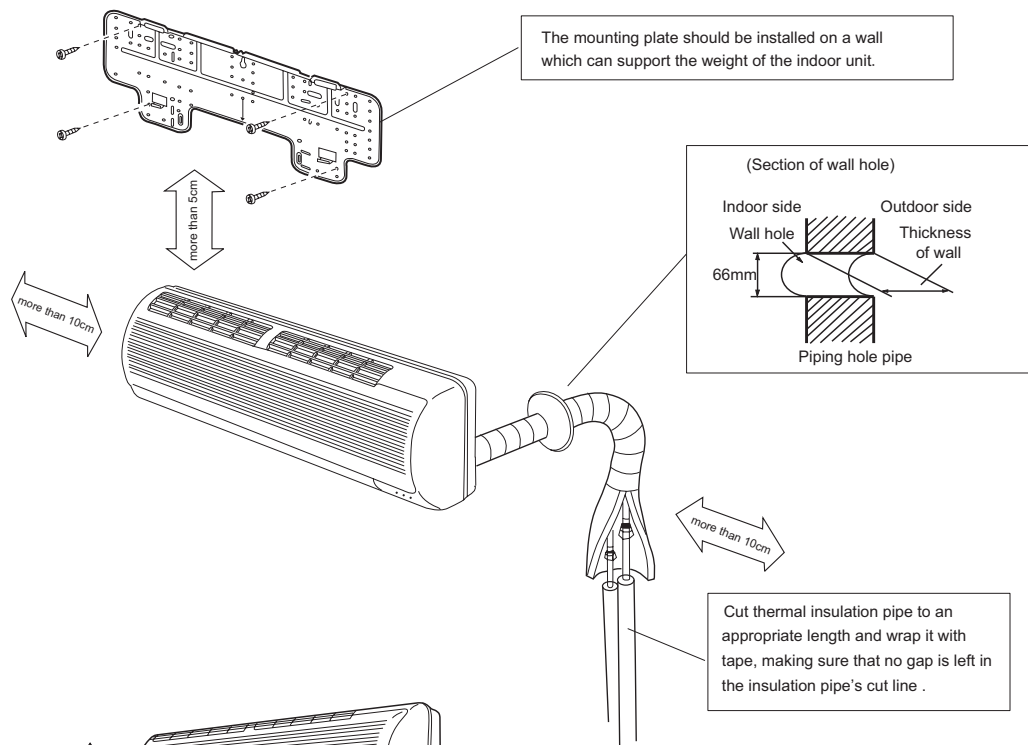

The mounting plate should be installed on a wall which can support the weight of the indoor unit.

(Section of wall hole)

Indoor side      Outdoor side  
Wall hole      Thickness of wall  
66mm  
Piping hole pipe

more than 5cm

more than 10cm

more than 10cm

Cut thermal insulation pipe to an appropriate length and wrap it with tape, making sure that no gap is left in the insulation pipe's cut line .

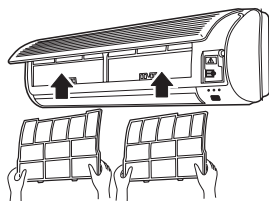
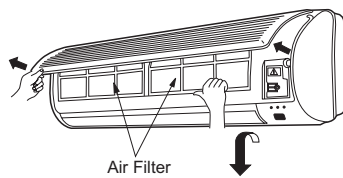
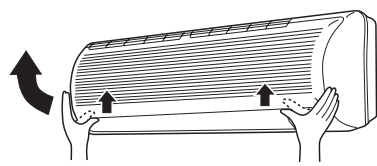

### How to remove the air filter.

Open the inlet grille by pulling it upward.

Push up the filter's center tab slightly until it is released from the stopper, and remove the filter downward.

### How to Attach the air filter.

Attach the filter correctly so that the "FRONT" indication is facing to the front. Make sure that the filter is completely fixed behind the stopper. If the right and left filters are not attached correctly, that may cause defects.

Close the inlet grille.



# Outdoor unit installation drawings

## HSU-07,09,12LE03

### Outdoor

Model	26/28 class
Max.allowable length	Cooling only: 7 m Heat pump: 7 m
Max.allowable height	5m
Additional refrigerant required for refrigerant pipe exceeding 5m in length	16g/m
Gas pipe	O.D. 9.52/12.7
Liquid pipe	O.D. 6.35/9.52

\*Be sure to add the proper amount of additional refrigerant. Failure to do so may result in reduced performance.

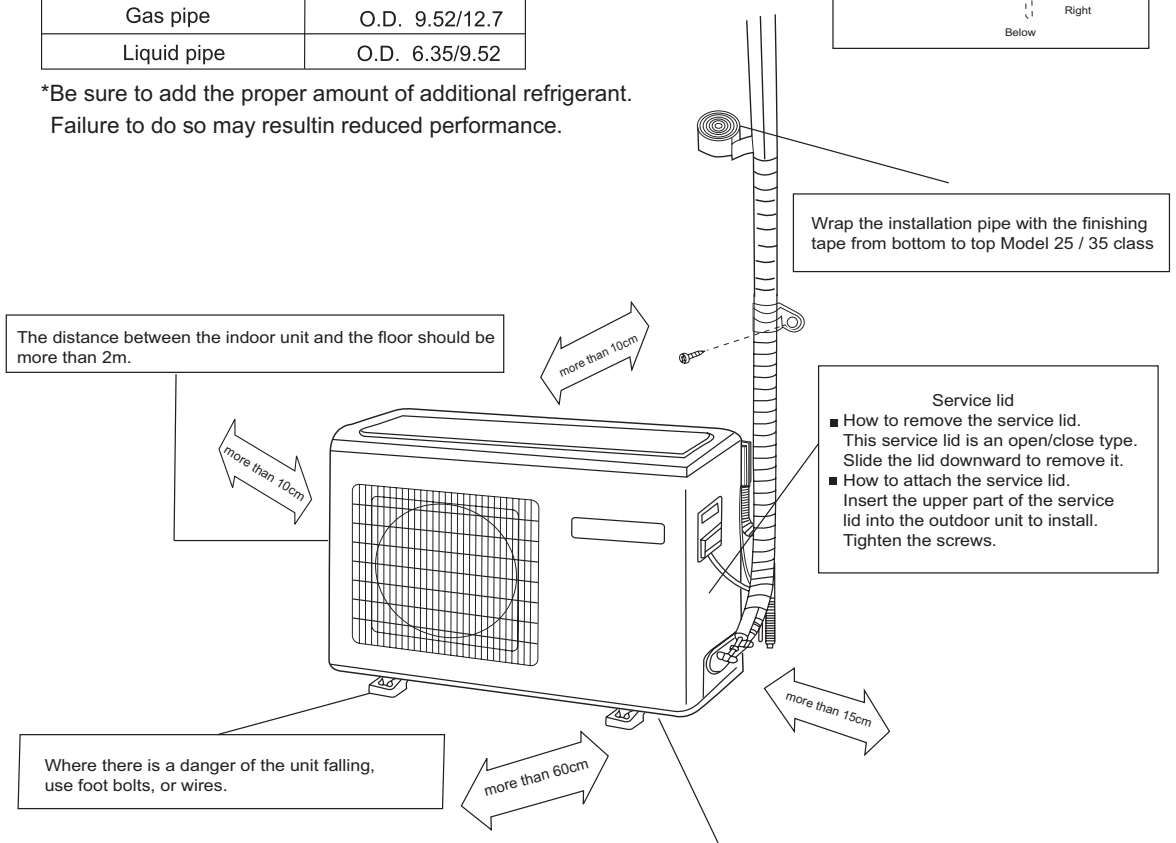
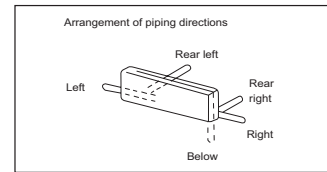

- Fix the unit to concrete or block with bolts (φ10mm) and nuts firmly and horizontally.
- When fitting the unit to wall surface, roof or rooftop, fix a supporter surely with nails or wires in consideration of earthquake and strong wind.
- If vibration may affect the house, fix the unit by attaching a vibration-proof mat.

115 466 115 245

# Sincere Forever



Haier Group

---

Haier Industrial Park, No.1, Haier Road  
266101, Qingdao, China  
E-mail: hractech@haier.com  
Tel: +86 532 87636957  
[Http://www.haier.com](http://www.haier.com)

Edited by: Zhao Jicheng

Signed by: Yang Bifei

Approved by: Zhu Zhenxue