

Haier

TECENICAL DATA

Order No.AC1001T005V0

Wall mounted Type

ON/OFF EK-Series

Model No. HSU-18HEK03



WARNING

This service information is designed for experienced repair technicians only and is not designed for use by the general public. It does not contain warnings or cautions to advise non-technical individuals of potential dangers in attempting to service a product. Products powered by electricity should be serviced or repaired only by experienced professional technicians. Any attempt to service or repair the product or products dealt with in this service information by anyone else could result in serious injury or death

©2010(Qingdao Haier Air Conditioner General corp.,Ltd)
All right reserved .Unauthorized copying and distribution is a violation of law

Haier Group

Table of Contents

1.Features	1
2. Specifications	2
3.Remote controller lists	3
4.Sensors lists	4
5.Dimensional drawings and center of gravity	5
6.Operation range	7
7.Piping diagrams	8
8.Wiring diagrams	9
9. Capacity diagrams and curves diagrams	11
10.Sound level	21
11. Accesories	22
12.Control systems	23
13.Installations	24

1 Features



ESF filter : Trap harmful dust and remove unpleasant odors effectively



4 Fan setting: Slect the fan speed LO,MED,HI,AUTO



Anti-mold filter: Catches most small particles and remove unpleasant odors effectively



Sleep mode: The setting temprature and the indoor noise can be adjusted to a more comfortable level when you set the "sleep mode"during night sleep



24 Hour timer: Use the timer function to set on,or off,or from on to off,or from off to on



Auto restart: The function permits automatic return to previous peration conditions



Easy clean design: The panel is easy to wash and the airflow vents can be detached without any special tools for quick cleaning of the inside of the air conditioner



Auto mode According to the fixed temperature "26°C " ,the unit will adjust the operation mode automatically.

2. Specifications

Model			HSU-18HEK03	
			Cooling	
Capacity Rated	kW		4.8	5.2
	Btu/h		16380	17750
	kcal/h		4128	4472
POWER SUPPLY			VM	
NOMINAL DISTRIBUTION SYSTEM VOLTAGE	Phase		1PH	
	Frequency	HZ	60	
	Voltage		V	
Moisture Removal			L/h	2.0
Running Current (Rated)			A	8.7
Power Consumption Rated			W	1900
COP Rated			W/W	2.53
Piping Connections (external diameter)	Liquid	mm	φ 6.35	
	Gas	mm	φ 12.7	
	Drain	mm	φ 16.0	
Heat Insulation			Both Liquid and Gas Pipes	
Max. Piping Length			m	20
Max. Level Difference			m	10
Chargeless			m	5
Amount of Additional Charge of Refrigerant			g/m	20
Indoor Unit				
Front Panel Color			White	
Air Flow Rate	m ³ /min(cfm)	H	12.5(441.3)	
		M	11.6(408.6)	
		L	10.6(375.9)	
Fan	Type		Cross Flow Fan	
	Motor Output	W	26	
	Speed	Steps	3 Steps,Auto	
Air Direction Control			Right, Left, Horizontal, Downward	
Air Filter			Removable / Washable / Mildew Proof	
Run current (rated)			A	0.14
Power consumption			W	31
Temperature Control			Microcomputer Control	
Dimensions (H×W×D)			mm	938*187*265
Packaged Dimensions (H×W×D)			mm	1016*304*360
Weight			kg	10.5
Gross Weight			kg	12.5
Operation Sound	H/M/L		dB(A)	42/39/37
Sound Power	H(cooling/heating)		dB(A)	52

Outdoor Unit			
Casing Color		Ivory white	
Compressor	Type		Hermetic motor compressor
	Model		Rechi 48R473NU+81SH
	Motor Output	W	1900
	Oil Type		SUNISO 4GSD
	Oil Charge	L	0.51
Refrigerant	Model		R22
	Charge	kg	1.54
Air Flow Rate (H/L)	m ³ /min		32.7
	cfm		1153
Fan	Type		Axial fan
	Motor Output	W	30
Runing current (rated)		A	8.5
Power Consumption (rated)		W	1869
Dimensions (H×W×D) (stop valve, and bottom support is not included)		mm	783*255*543
Packaged Dimensions (H×W×D)		mm	930*340*614
Weight		kg	36.5
Gross Weight		kg	40.5
OperationSound	H	dBA	52
Sound Power	H(cooling/heating)	dBA	52

Note: The data are based on the conditions shown in the table below.

Cooling	Heating	Piping Length
Indoor:27°CDB/19°CWB Outdoor: 35°CDB/24°CWB	Indoor: 20°CDB Outdoor:7°CDB/6°CWB	5m

Conversion Formulae
kcal/h=kW×860
Btu/h=kW×3413
cfm=m ³ /min×35.3

3.Remote controller lists

Model	HSU-18HEK03
YR-W04	Y

4.Sensors lists

INDOOR UNIT		
type	Description	Qty
Room sensor	It's used for detecting room temperature	1
Pipe sensor	It's used for detecting temperature of evaporator	1

5. Dimensional drawings and center of gravity

Indoor unit

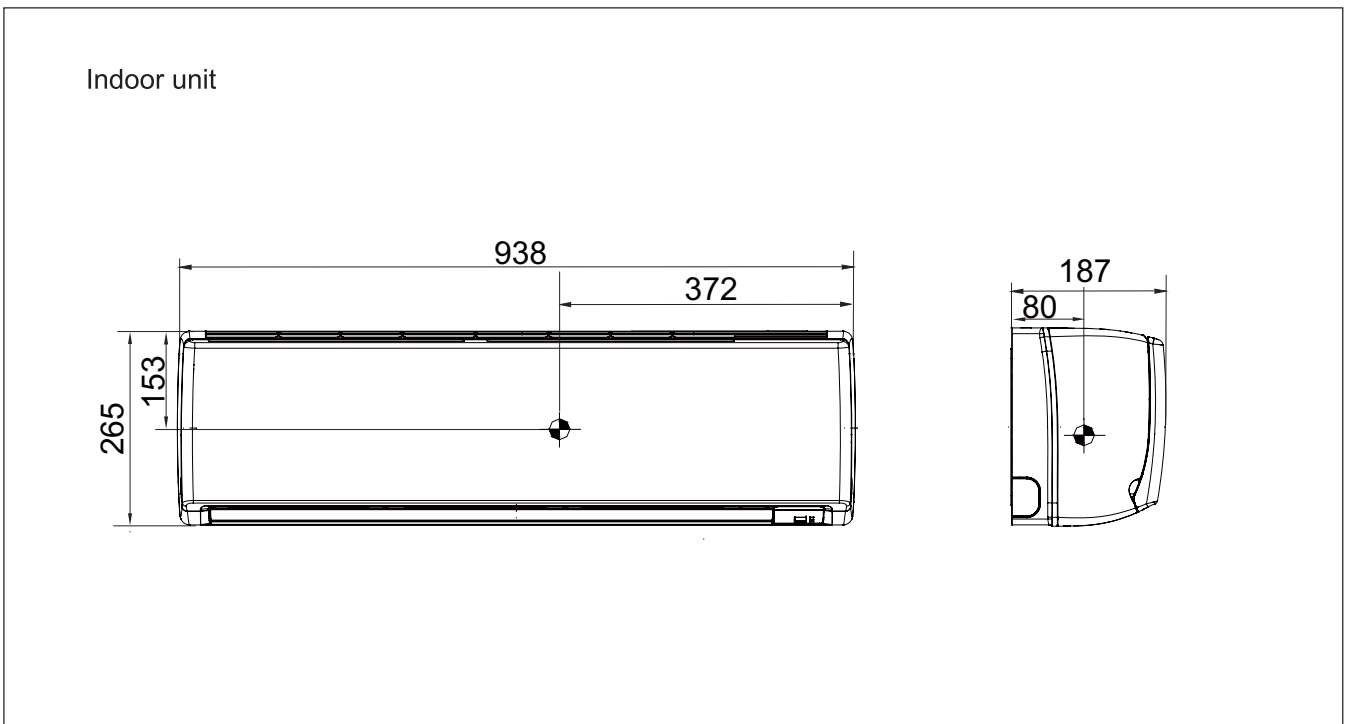

Outdoor unit

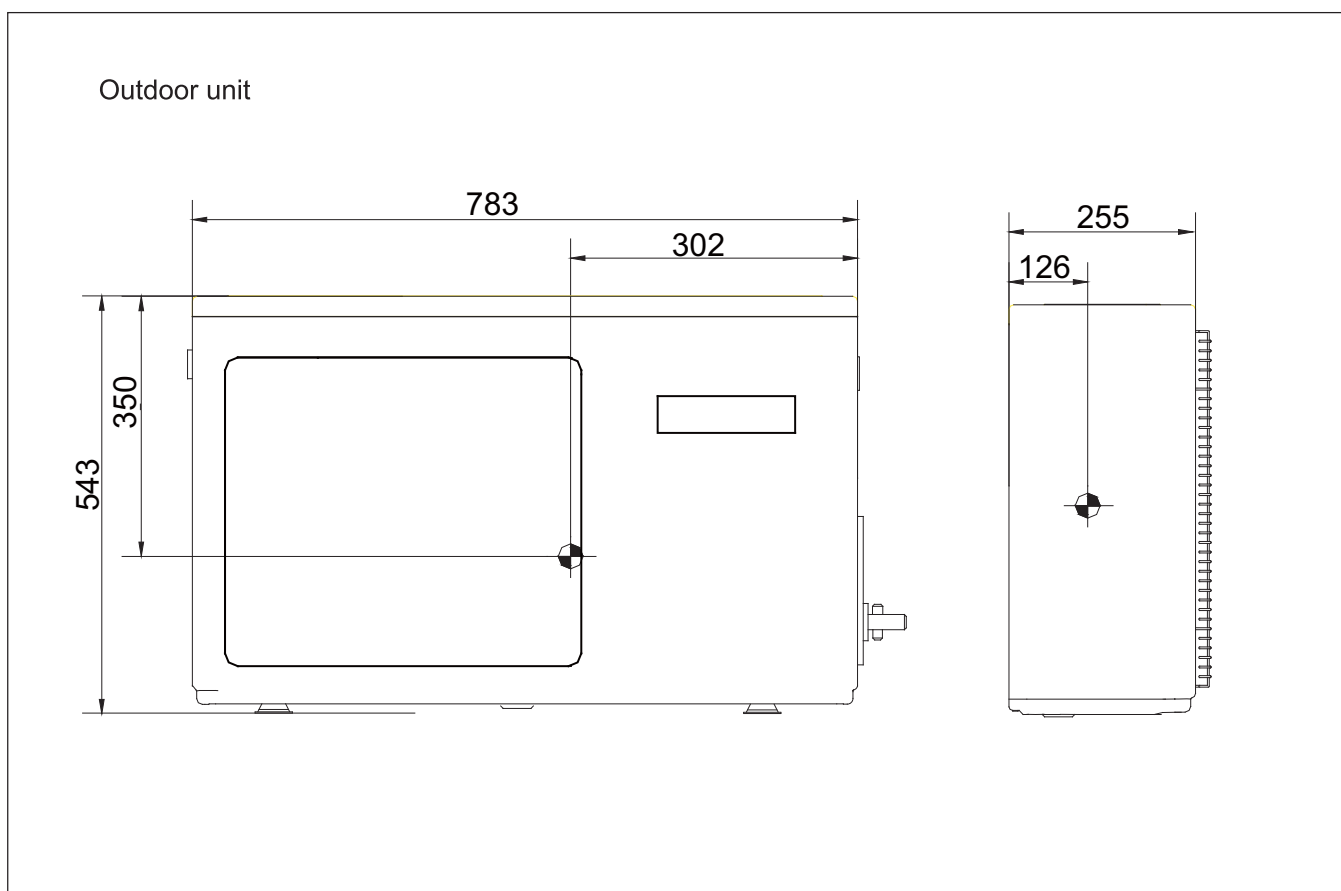

6. Operation range

The name of parts

Cooling

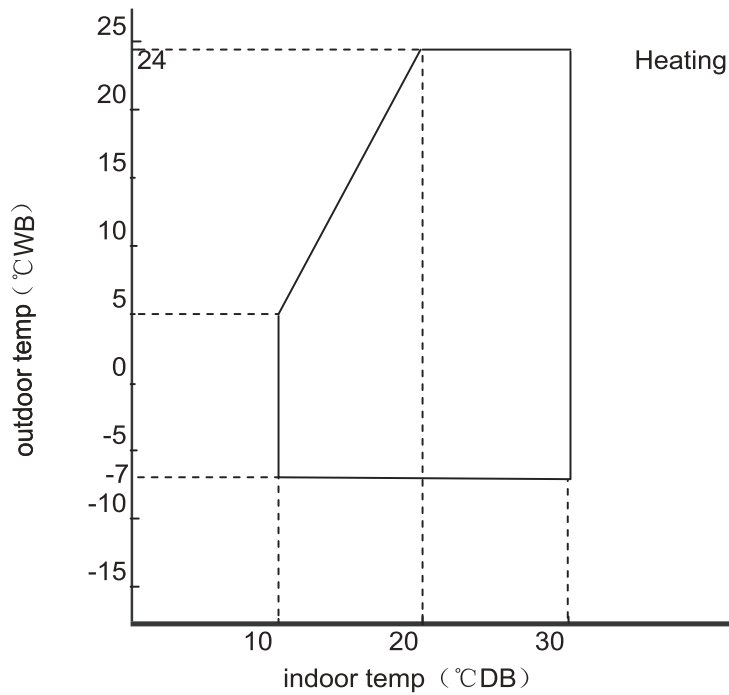
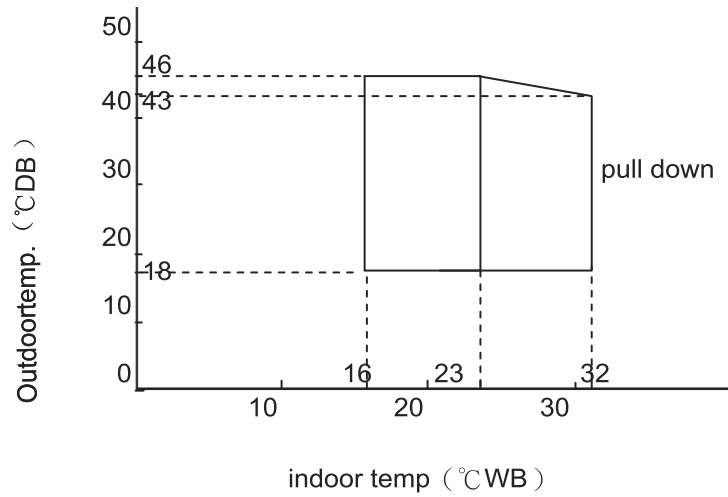

Notes:

The graphs are based on the following condition:

Equivalent piping length	7.5m
Level difference	0m
Air flow rate	high

7.Piping Diagrams

Cooling mode

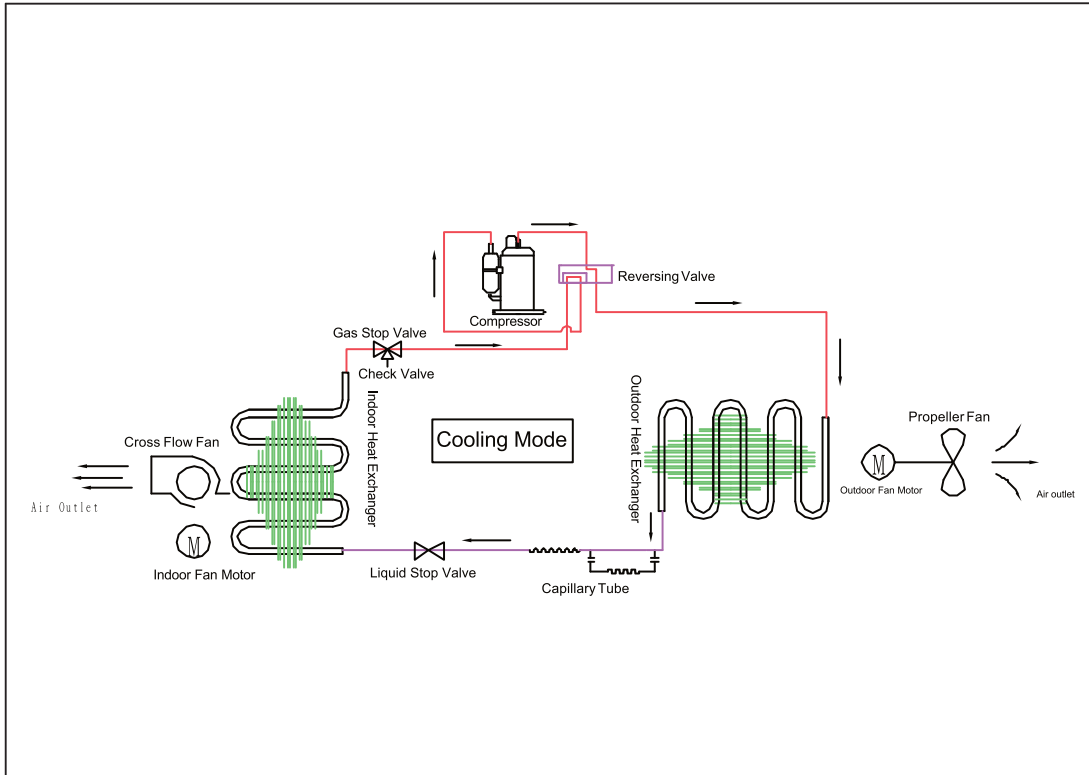

Heating mode

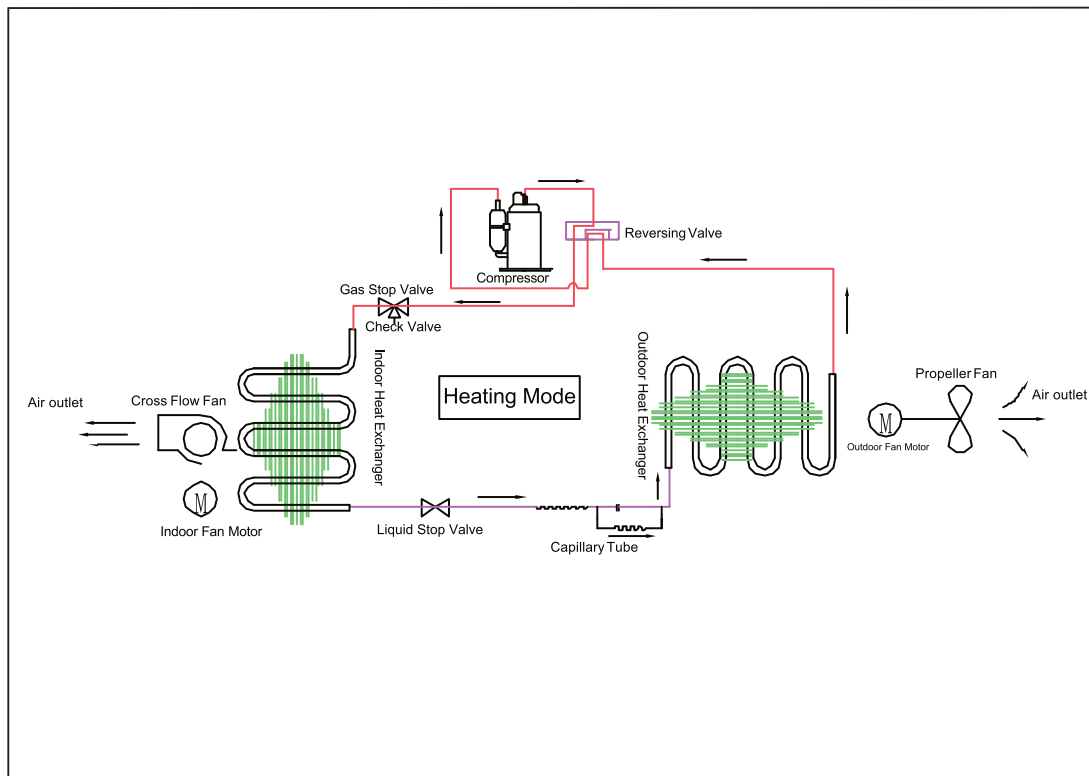

8.Wiring diagrams

Indoor

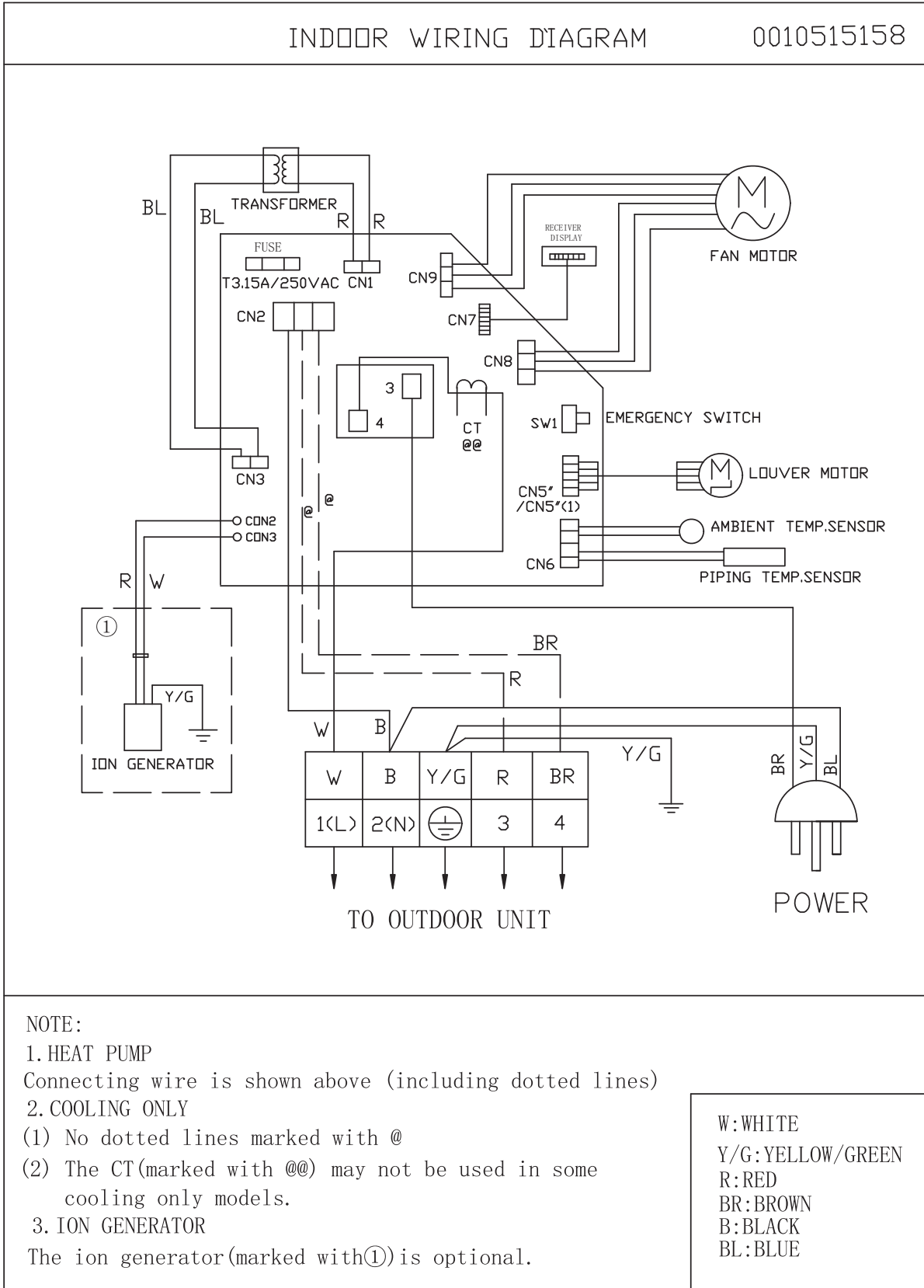

Outdoor

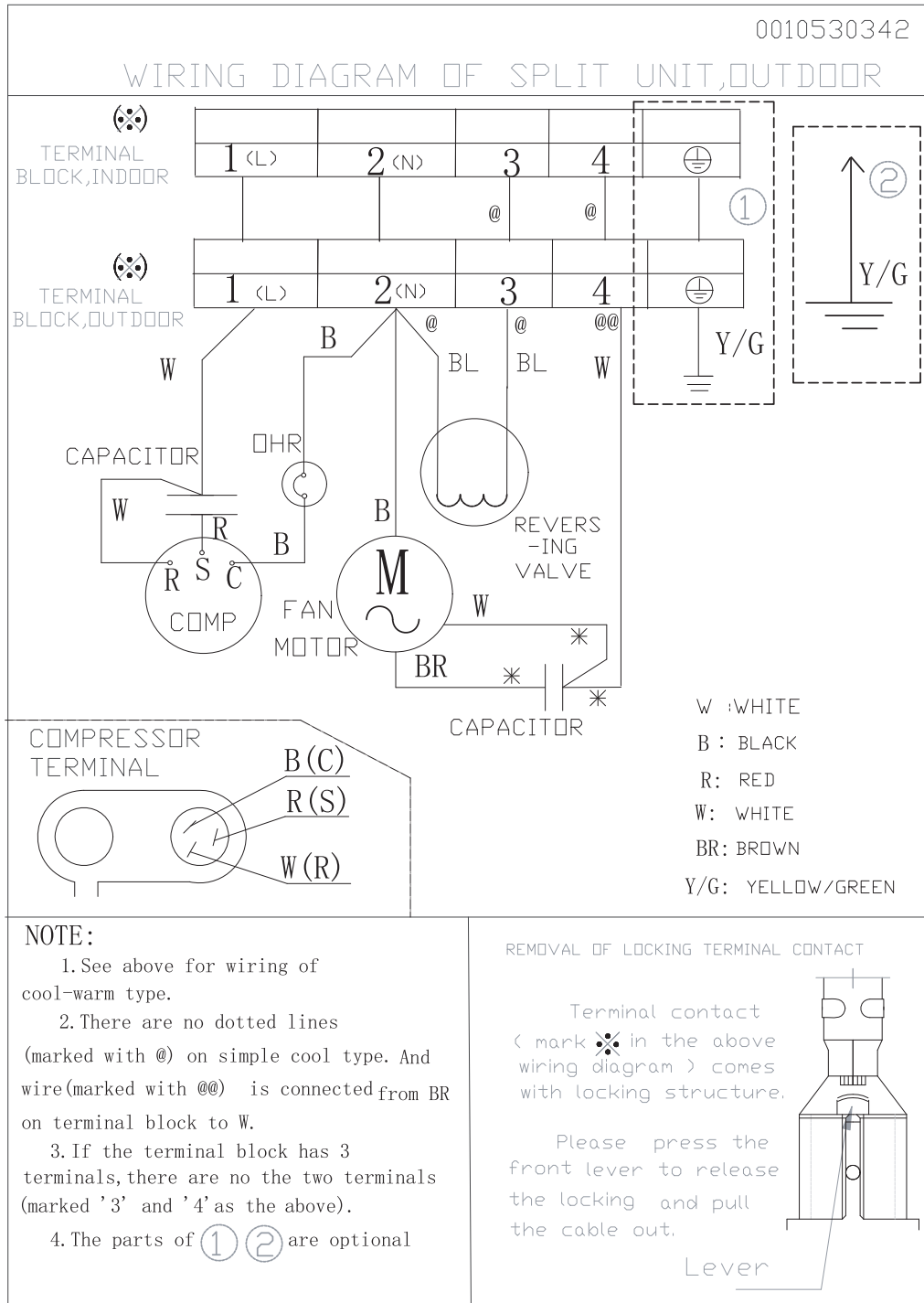

9. Capacity diagrams and curves diagrams

9.1 Cooling Capacity-temperature Curves

HSU-18HEK03 performance curves								
cooling capacity and indoor/outdoor temp.curves								
indoor temp.	outdoor temp.(humidity 46%)							
DB/WB	18°C	20°C	25°C	32°C	35°C	40°C	43°C	46°C
18/12°C	4593	4398	4354	4293	4298	4319	4045	3952
18/14°C	4833	4640	4623	4548	4529	4464	4208	3998
20/15°C	5075	4882	4839	4841	4760	4679	4411	4015
22/16°C	5049	4857	4815	4831	4745	4641	4371	4050
25/18°C	5022	4831	4791	4821	4727	4634	4372	4110
27/19°C	5152	4907	4882	4851	4800	4725	4463	4280
30/22°C	5291	5076	5061	4964	4899	4834	4540	4310
32/23°C	5345	5098	5064	4950	4921	4867	4602	4355
32/24°C	5381	5160	5103	4985	4956	4901	4635	4440

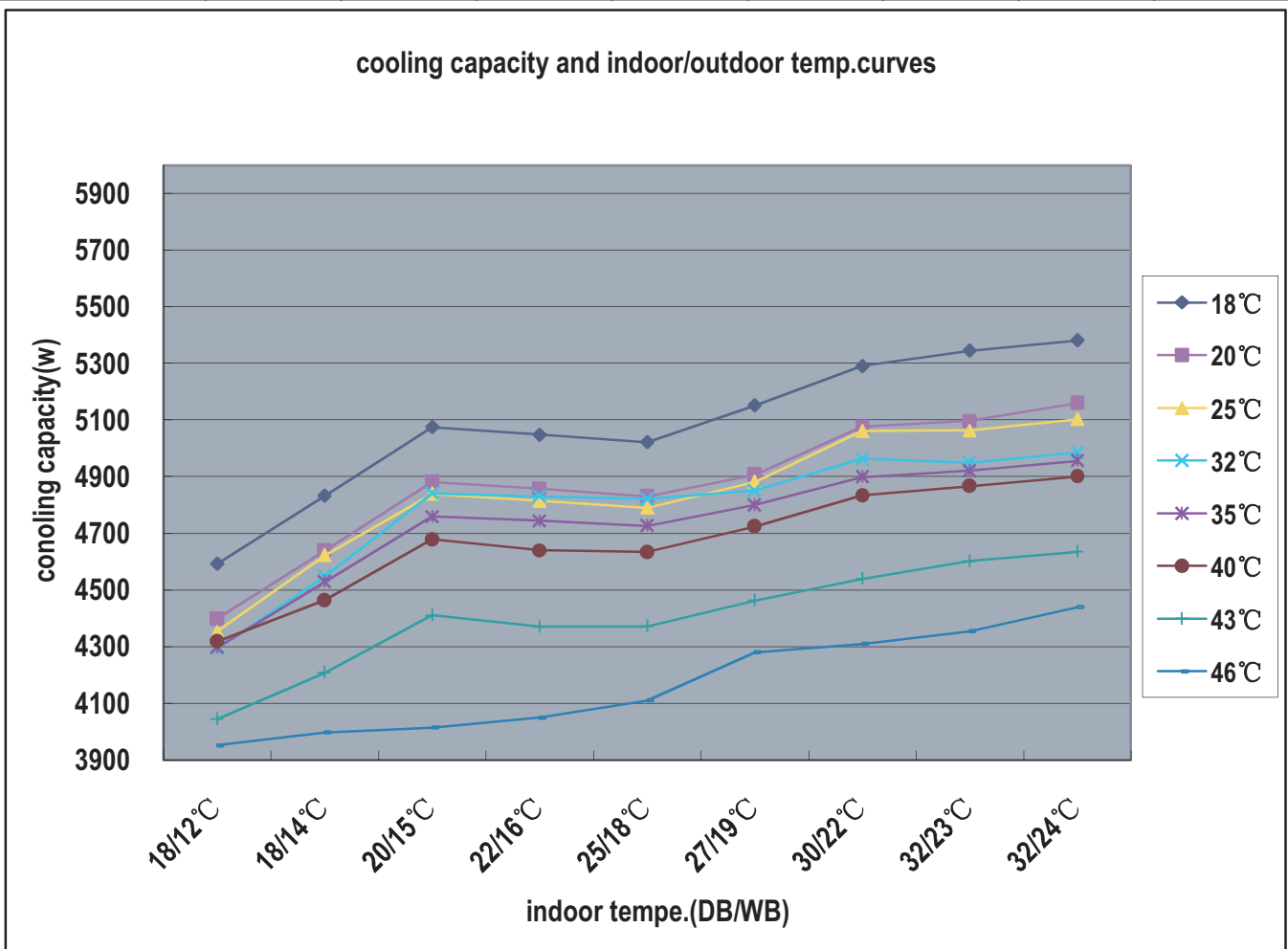

9.2 Heating Capacity-temperature Curves

HSU-18HEK03 performance curves			
heating capacity and indoor/outdoor temp.talbe			
outdoor temp.	indoor temp.(humidity 46%)		
DB/WB	15°C	20°C	25°C
-10°C	3045	2972	2875
-5°C	3884	3798	3675
5°C	4284	4196	4069
7/6°C	4799	5200	4328
15°C	5300	5350	5100
20°C	5600	5500	5400
25°C	6100	5850	5600

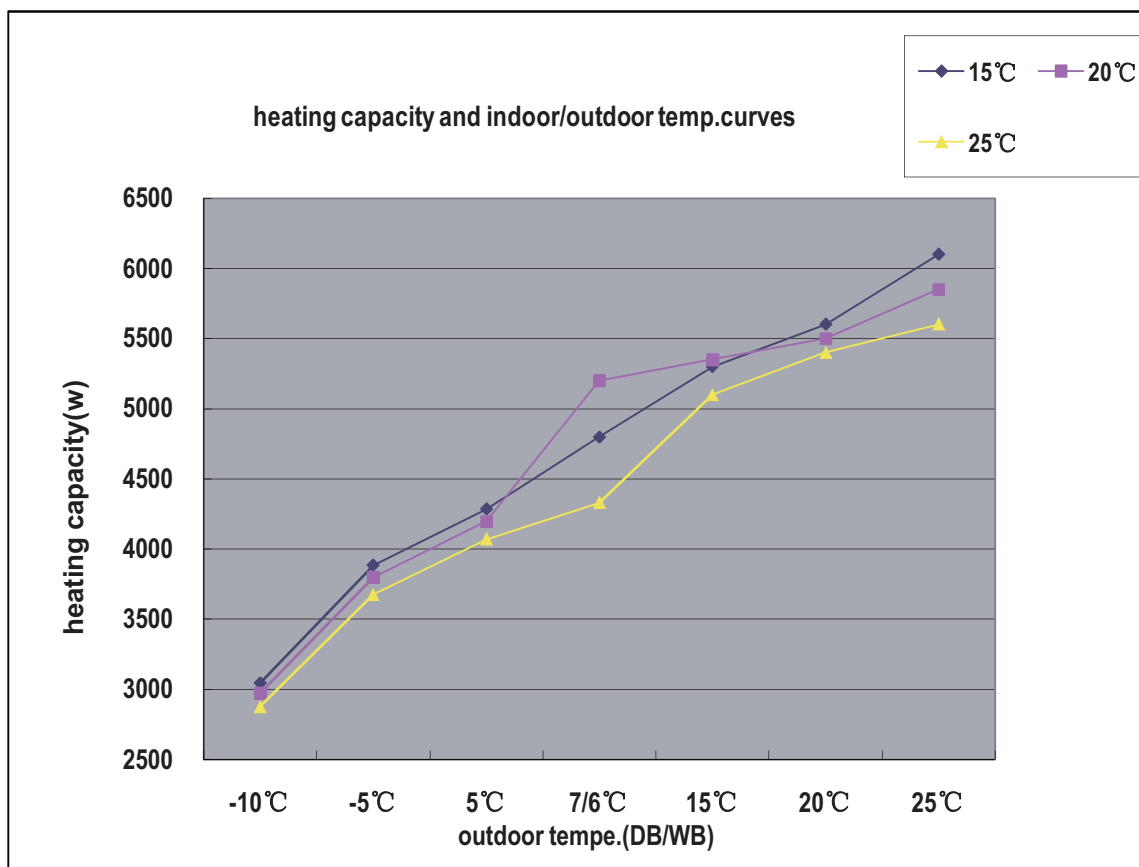

9.3 Sensible cooling value-temperature curves

HSU-18HEK03 performance curves								
sensible cooling value-temperature talbe								
indoor temp.	outdoor temp.(humidity 46%)							
DB/WB	18°C	20°C	25°C	32°C	35°C	40°C	43°C	46°C
18/12°C	1857	1783	1720	1647	1489	1400	1315	1236
18/14°C	1936	1866	1789	1752	1545	1489	1360	1273
20/15°C	1982	1920	1845	1807	1634	1536	1408	1315
22/16°C	2061	1969	1935	1870	1691	1562	1445	1347
25/18°C	2137	2066	2003	1961	1774	1667	1491	1400
27/19°C	2205	2132	2063	2020	1819	1713	1570	1459
30/22°C	2284	2261	2192	2147	1941	1769	1630	1523
32/23°C	2430	2380	2260	2181	2043	1834	1699	1562
32/24°C	2454	2404	2320	2265	2131	1920	1723	1629

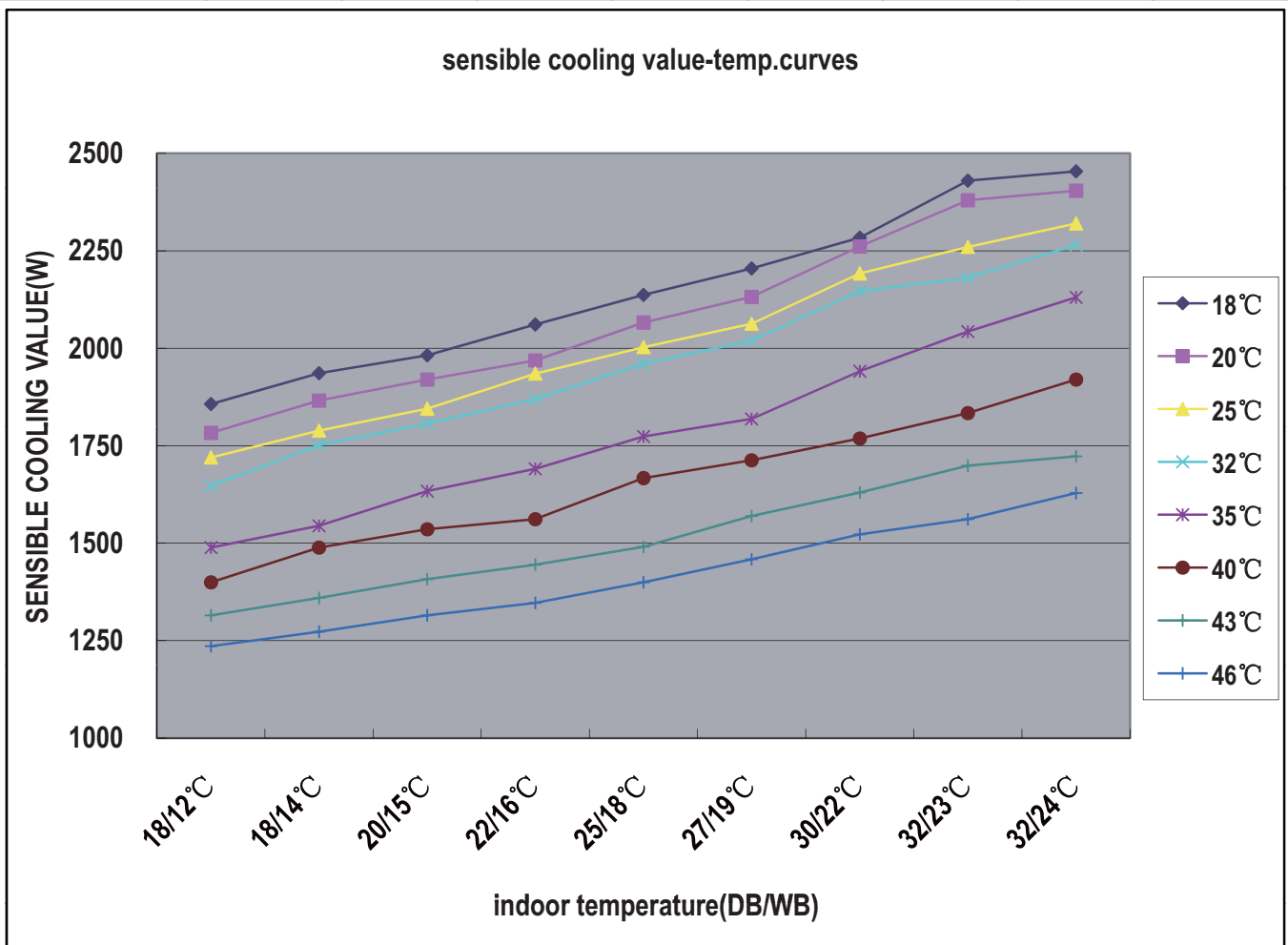

9.4 Cooling Power Consumption Value-temperature Curves

HSU-18HEK03 performance curves								
power consumption value-teme.talbe								
indoor temp.	outdoor temp.(humidity 46%)							
DB/WB	18°C	20°C	25°C	32°C	35°C	40°C	43°C	46°C
18/12°C	1428	1487	1565	1720	1792	2087	2185	2104
18/14°C	1433	1492	1571	1726	1798	2096	2195	2114
20/15°C	1456	1517	1597	1755	1828	2130	2231	2148
22/16°C	1476	1538	1619	1779	1853	2154	2254	2171
25/18°C	1496	1559	1641	1803	1878	2180	2282	2196
27/19°C	1514	1577	1660	1824	1900	2205	2307	2222
30/22°C	1542	1606	1690	1858	1935	2234	2334	2248
32/23°C	1566	1631	1717	1886	1965	2291	2400	2311
32/24°C	1571	1648	1730	1904	1985	2305	2412	2323

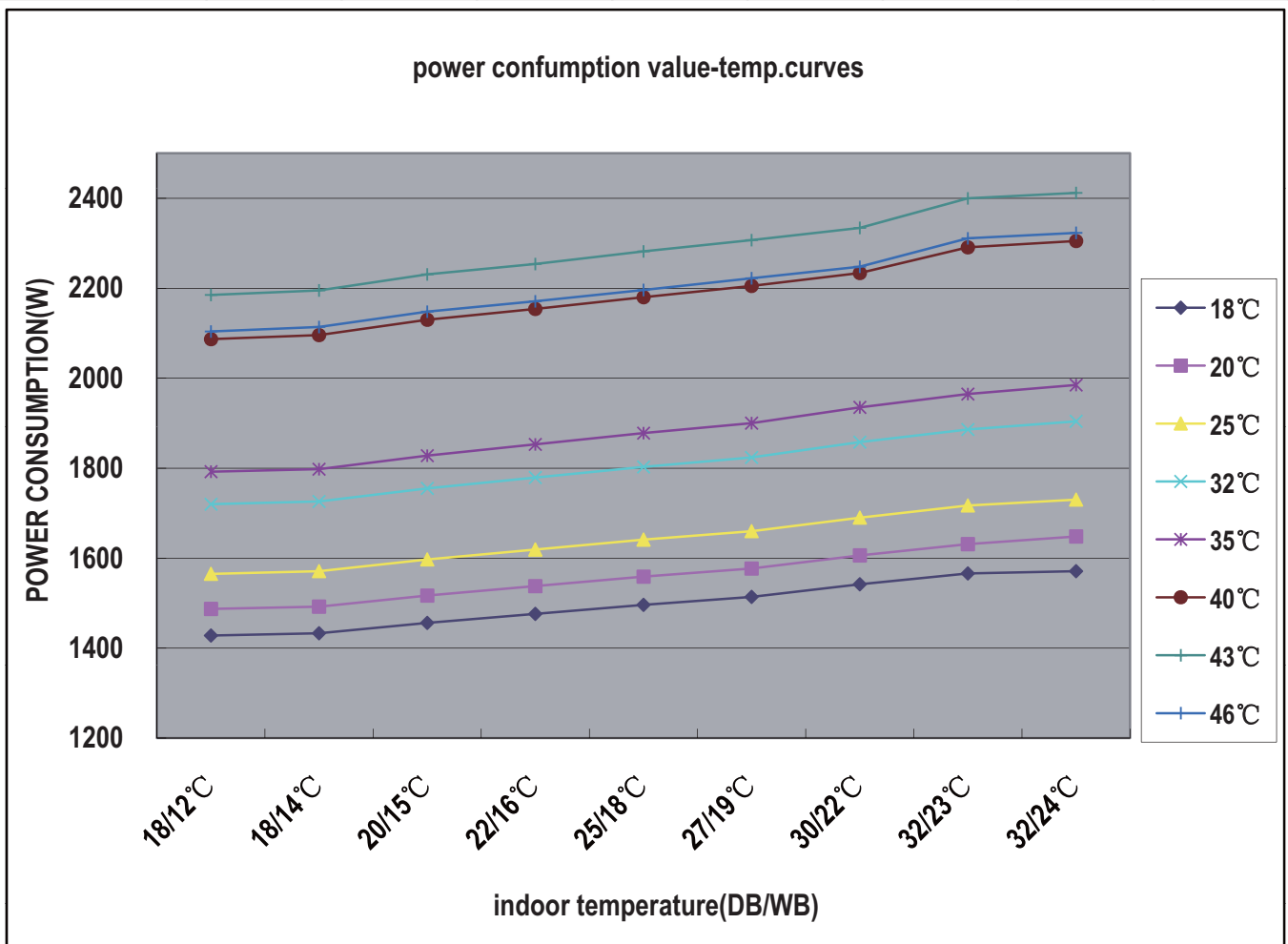

9.5 Heating Power Consumption Value-temperature Curves

HSU-18HEK03 performance curves			
power consumption value-teme.talbe			
DB/WB	15℃	20℃	25℃
-10℃	1342	1380	1423
-5℃	1411	1450	1580
5℃	1430	1520	1600
7/6℃	1620	1650	1720
15℃	1520	1550	1600
20℃	1280	1320	1540
25℃	1250	1280	1430

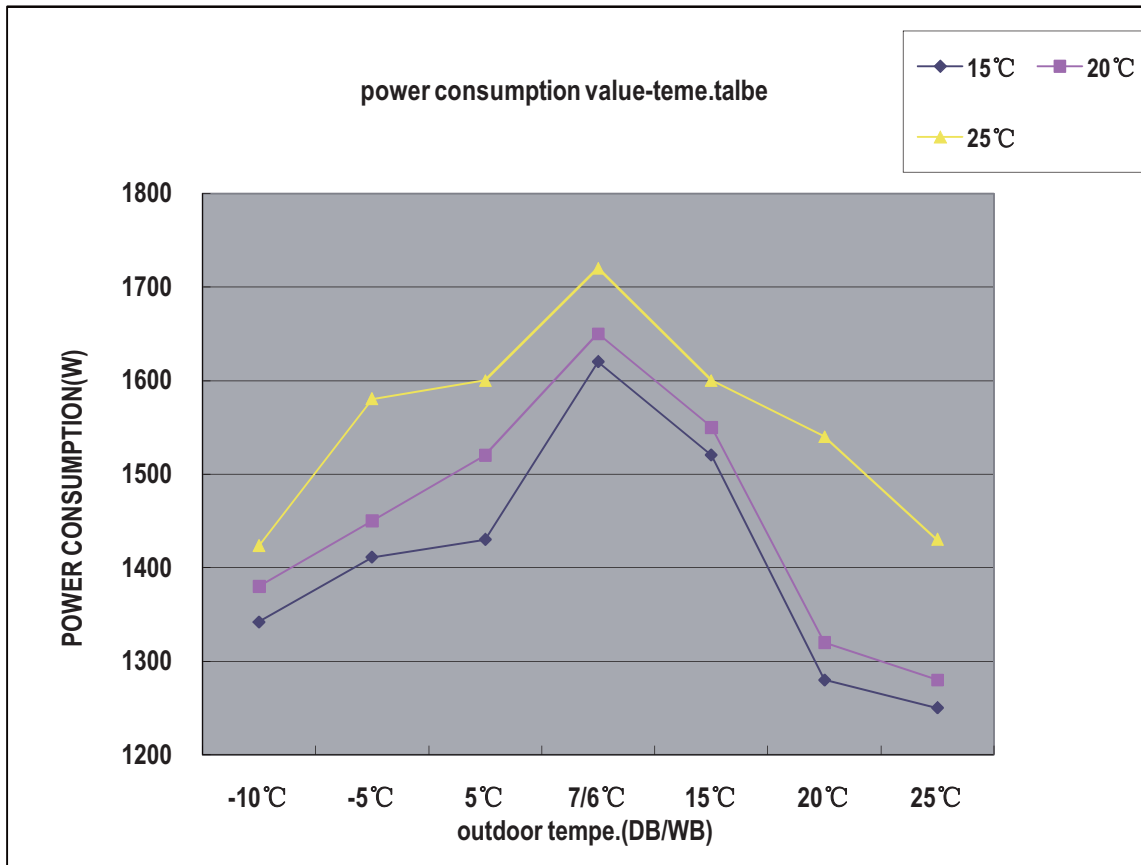

9.6 Air outlet Value-temperature Curves

HSU-18HEK03 performance curves								
air outlet temp.-ambient teme.talbe								
indoor temp.	outdoor temp.(humidity 46%)							
DB/WB	18°C	20°C	25°C	32°C	35°C	40°C	43°C	46°C
18/12°C	7.07	7.27	7.57	8.07	8.87	9.37	9.67	9.87
18/14°C	7.71	7.91	8.21	8.71	9.51	10.01	10.31	10.51
20/15°C	8.87	9.07	9.37	9.87	10.67	11.17	11.47	11.67
22/16°C	9.80	10.00	10.30	10.80	11.60	12.10	12.40	12.60
25/18°C	10.51	10.71	11.01	11.51	12.31	12.81	13.11	13.31
27/19°C	11.19	11.39	11.69	12.19	12.99	13.49	13.79	13.99
30/22°C	11.65	11.85	12.15	12.65	13.45	13.95	14.25	14.45
32/23°C	11.79	11.99	12.29	12.79	13.59	14.09	14.39	14.59
32/24°C	11.84	12.04	12.34	12.84	13.64	14.14	14.44	14.64

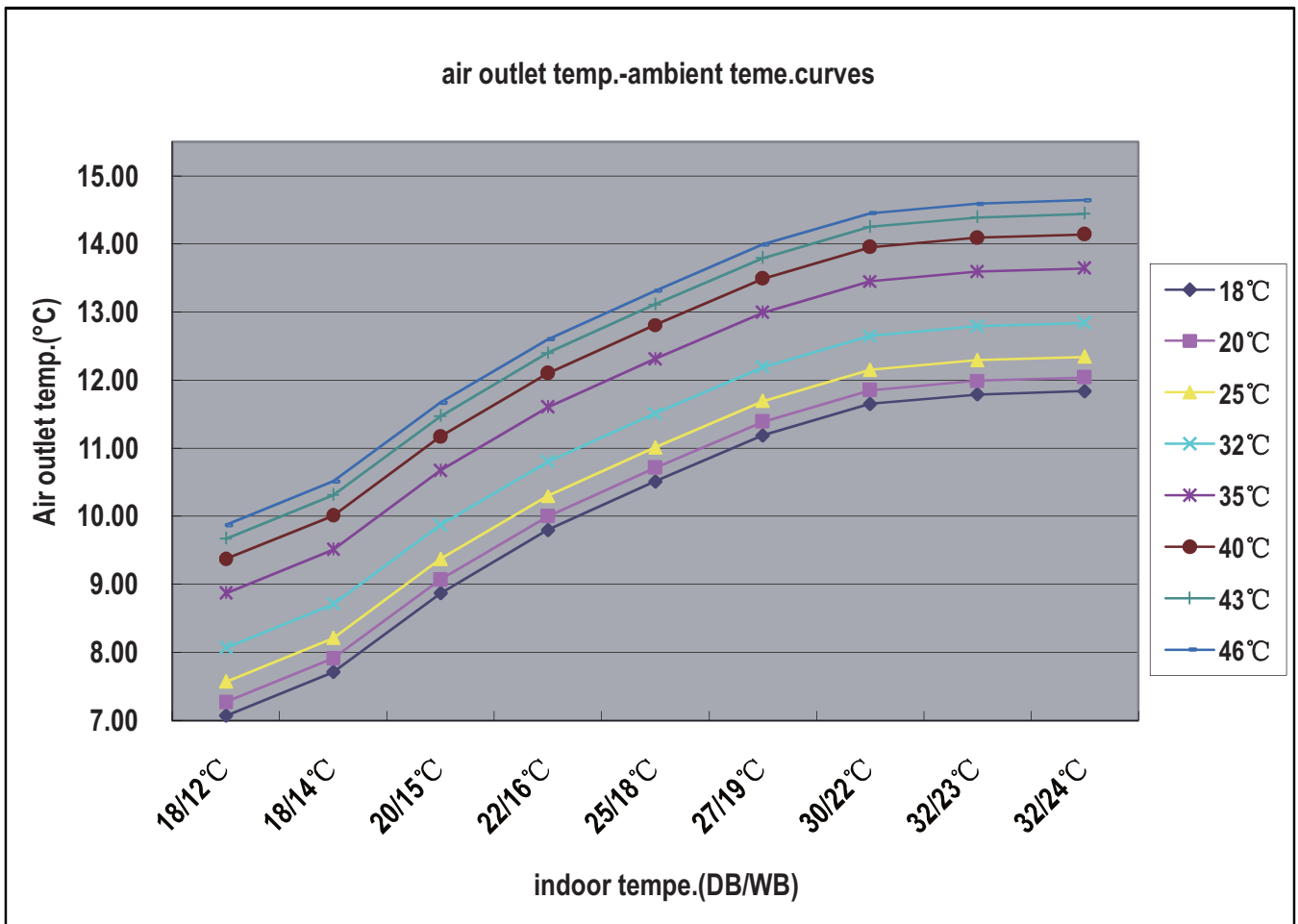

9.7 Cooling Discharge Pressure Curves

HSU-18HEK03 performance curves			
COOLING DISCHARGE PRESSURE.talbe			
outdoor temp. (humidity 46%)	indoor temp.		
DB/WB	16℃	19℃	22℃
15℃	2240	2360	2540
25℃	2530	2640	2720
30℃	2864	2990	3190
35℃	3180	3290	3480
40℃	3310	3490	3620
45℃	3400	3573	3680

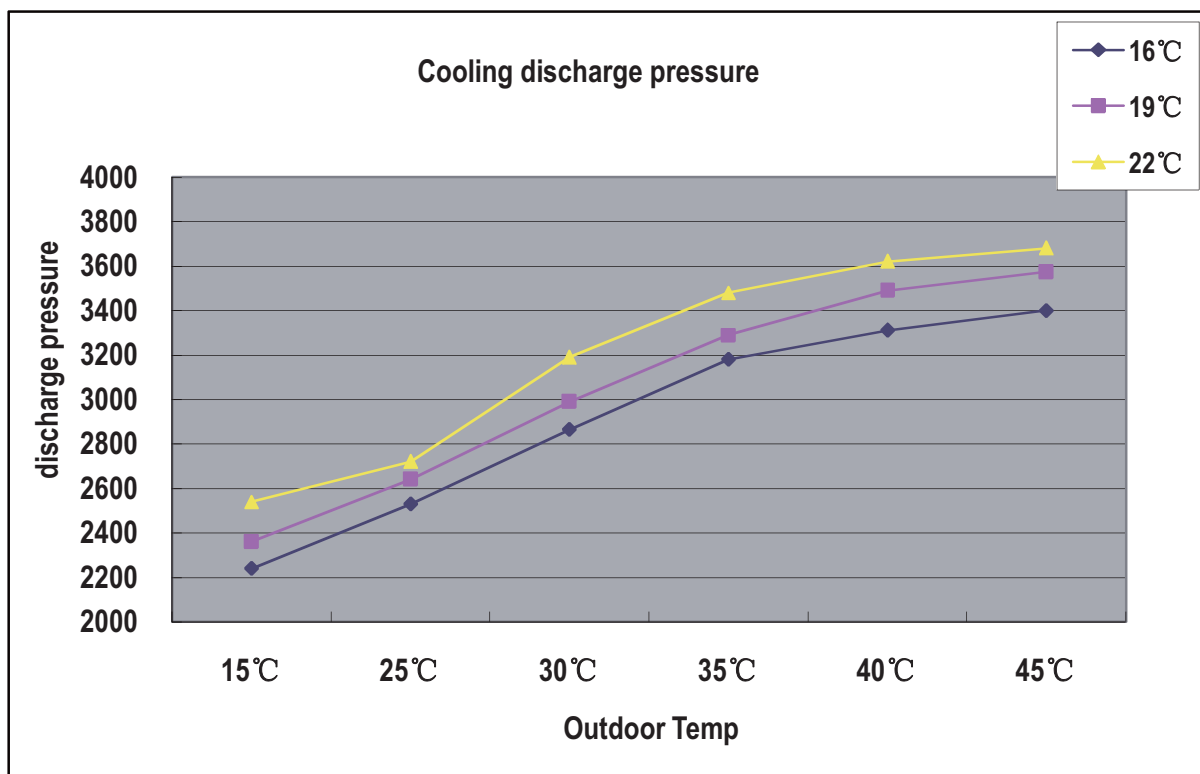

9.8 Heating Discharge Pressure Curves

HSU-18HEK03 performance curves			
HEATING DISCHARGE PRESSURE.talbe			
outdoor temp. (humidity 46%)	indoor temp.		
DB/WB	15℃	20℃	25℃
-15℃	2003	2171	2336
-10℃	2069	2260	2482
-5℃	2324	2440	2649
0℃	2290	2460	2661
5℃	2499	2630	2755
10℃	2819	2962	3267
15℃	3316	3499	3567
20℃	2957	3330	3500

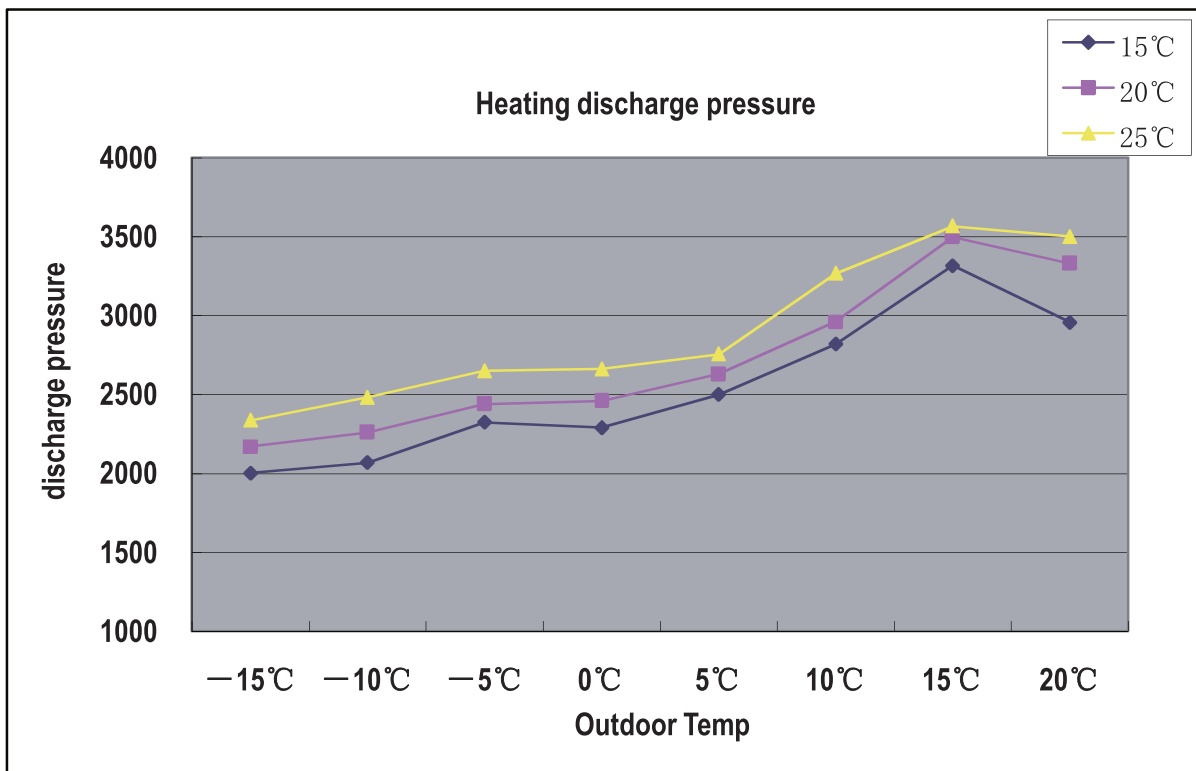

9.9 Cooling Suction Pressure Curves

HSU-18HEK03 performance curves			
COOLING SUCTION PRESSURE.talbe			
outdoor temp. (humidity 46%)	indoor temp.		
DB/WB	16℃	19℃	22℃
15℃	646	734	746
25℃	675	754	758
30℃	678	759	757
35℃	688	762	778
40℃	726	804	820
45℃	754	836	851

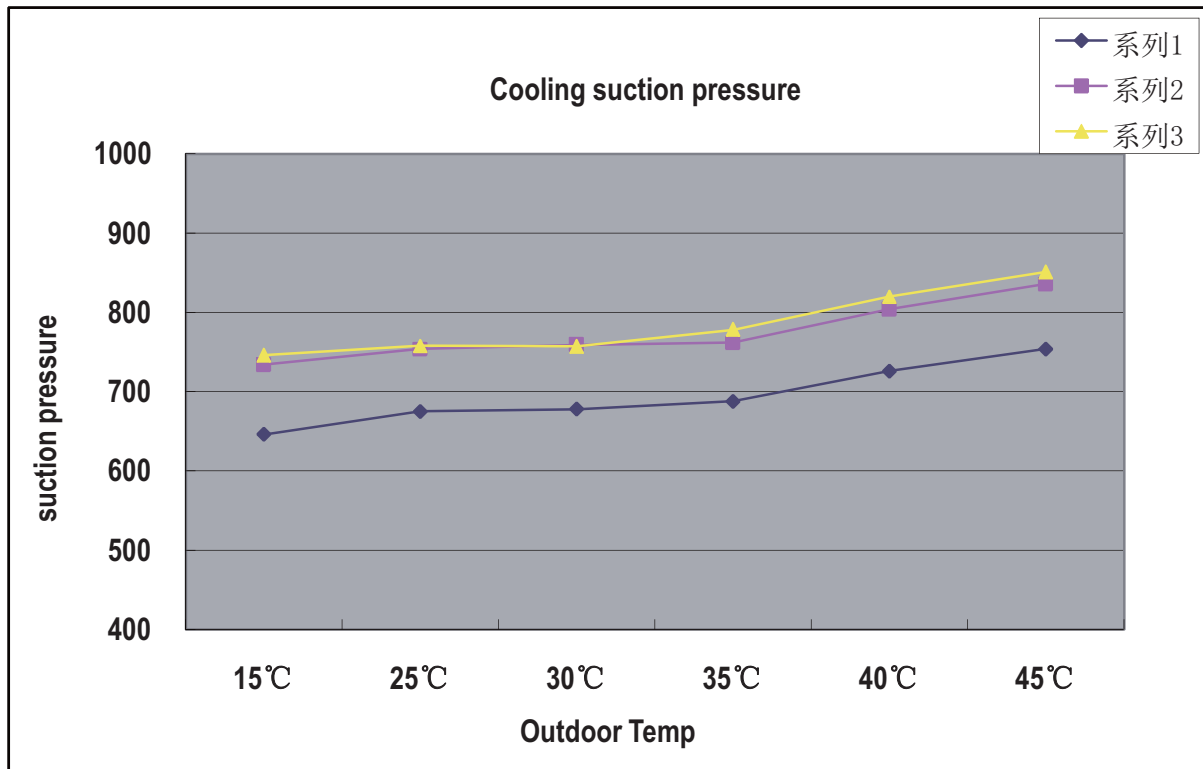

9.10 Accessories

Standard name	HSU-18HEK03
Drain hose	1
Plastic bag	1
screw assembly	1
Air purifier	2
Change for fresh airtube(suit)	0
Mounting plate	1
Remote controller	1
Installation manual	1
Operation manual	1
R-03 dry battery	2
Steel nail	6
Plastic cap	4
Cover	1
Cushion	4
Pipe supporting plate	1
Drain elbow	1

10.Sound level

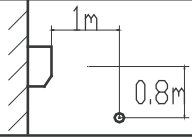
Model	Sound pressure level			Measuring location Location of microphone 	sound power level (cooling/heating)
	C:220-240V~ H:220-230V~,50Hz				
	Cooling/heating				
	H	M	L		
HSU-18HEK03(cooling)	42	39	37		52
HSU-18HEK03(heating)	42	39	37		52

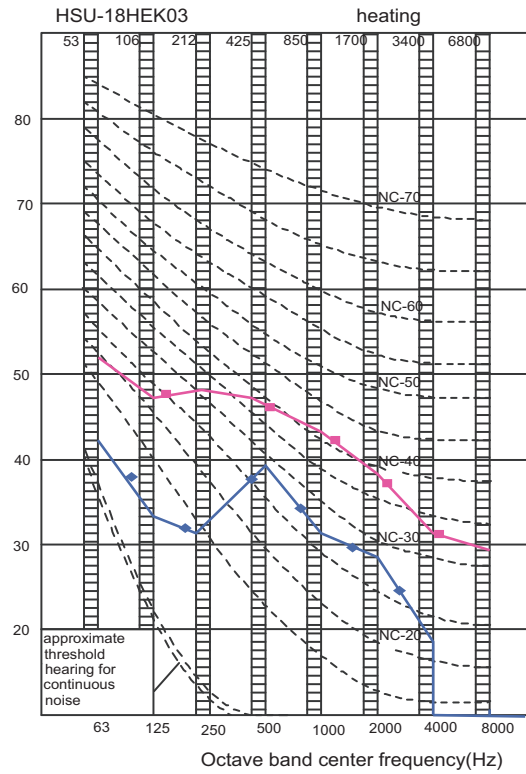
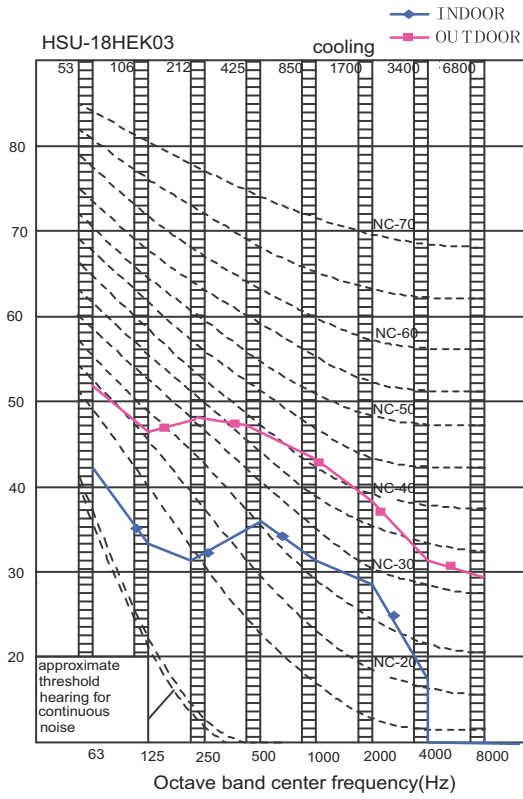

11. Accessories

Standard name	HSU-18HEK03
Drain hose	1
Plastic bag	1
screw assembly	1
Air purifier	2
Change for fresh airtube(suit)	0
Mounting plate	1
Remote controller	1
Installation manual	1
Operation manual	1
R-03 dry battery	2
Steel nail	6
Plastic cap	4
Cover	1
Cushion	4
Pipe supporting plate	1
Drain elbow	1

12. Control systems

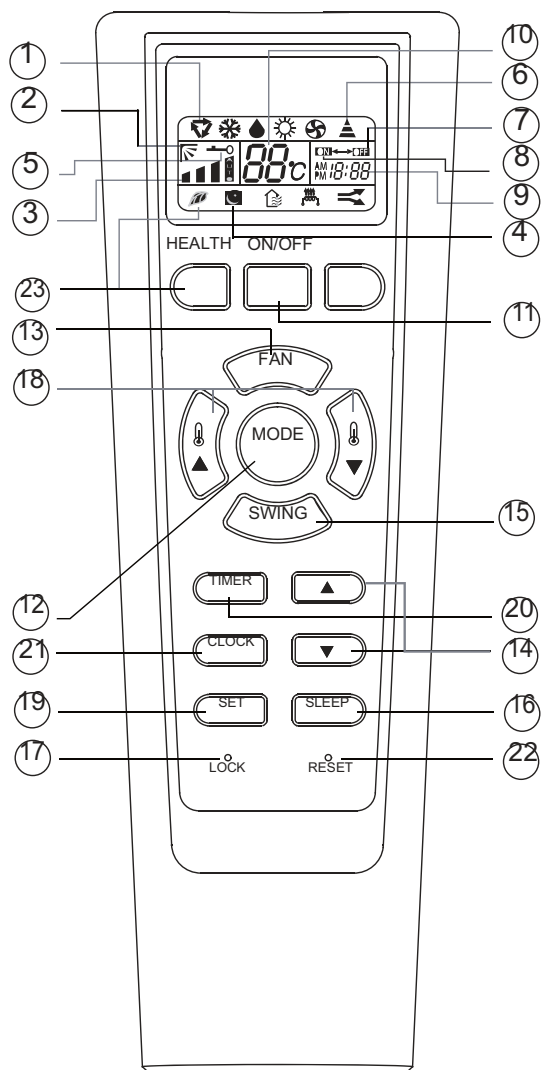

6. SIGNAL SENDING
7. TIMER OFF display
8. TIMER ON display
9. CLOCK display
10. TEMP display
11. POWER ON/OFF
Used for unit start and stop.
12. MODE
Used to select AUTO run, COOL, DRY, HEAT and FAN operation.
13. FAN
Used to select fan speed LO, MED, HI, AUTO
14. HOUR
Used to set clock and timer setting.
15. SWING
Used to set auto fan direction.
16. SLEEP
Used to select sleep mode.
17. LOCK
Used to lock buttons and LCD display.
18. TEMP.SETTING
Used to select your desired temp.
19. SET / LIGHT
Used to confirm timer and clock settings.
20. TIMER
Used to select TIMER ON, TIMER OFF, TIMER ON-OFF
21. CLOCK Used to set correct time
22. RESET
Used to reset the controller back to normal condition.
23. HEALTH
Used to operate the healthy function and LCD display.(This function is unacailable on some models.)

1. Mode display

AUTO	
COOL	
DRY	
HEAT	
FAN	

2. SWING display

3. FAN SPEED display

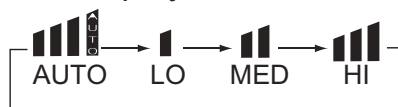

4. SLEEP display

5. LOCK display











NOTE:

Cooling only unit do not have displays and functions related with heating
If the unit which you purchased has healthy function, follow it. If not, please ignore.

13. Installations

Drawing for the installation of indoor and outdoor units

Accessory parts

No.	Accessory parts	Number of articles
①	Remote controller	1
②	 R-03 dry battery	2
③	 Mounting plate	1
④	 Drain hose	1
⑤	 $\phi 4 \times 50$ Steel nail, cement	6
⑥	 $\phi 4 \times 25$ Screw  Plastic cap	4
⑦	 Drain-elbow	1
⑧	 Cover	1
⑨	 Cushion	4
⑩	 Pipe supporting plate	1
⑪	 Connecting cable	1

Optional parts for piping

Mark	Parts name
(A)	Non-adhesive tape
(B)	Adhesive tape
(C)	Saddle(L.S) with screws
(D)	Connecting electric cable for indoor and outdoor
(E)	Drain hose
(F)	Heating insulating material
(G)	Piping hole cover

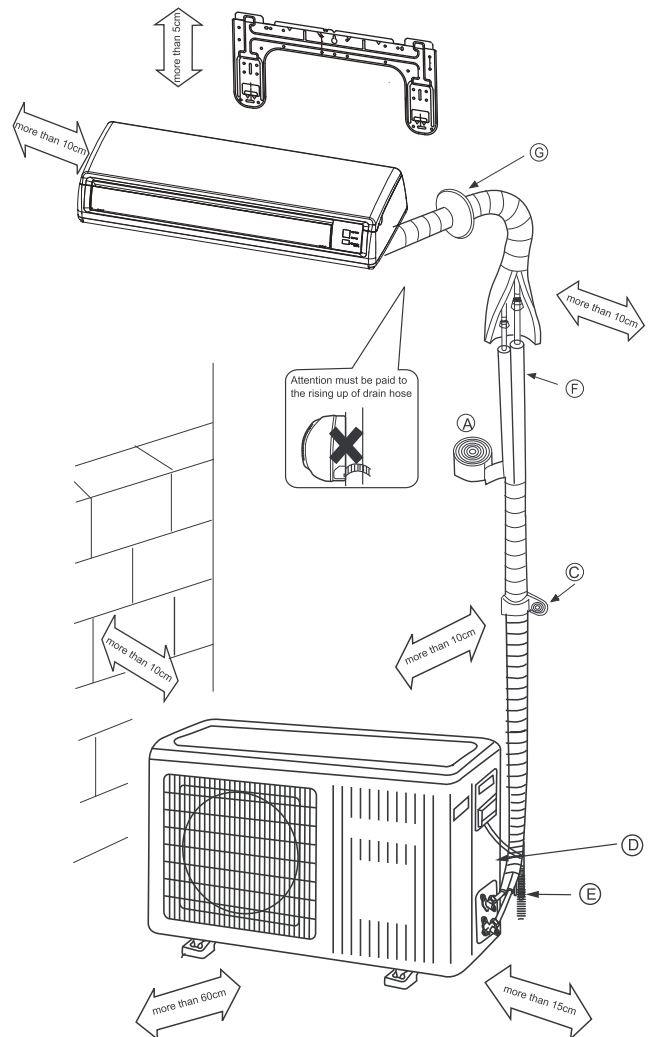
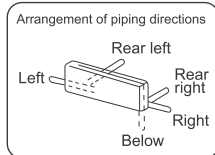

Note: Cooling only units don't have Drain-elbow

※ The marks from (A) to (G) in the figure are the parts numbers.

※ The distance between the indoor unit and the floor should be more than 2m.

Sincere Forever

Haier Group

Haier Industrial Park, No.1, Haier Road
266101, Qingdao, China_

E-mail: hractech@haier.com

Tel: +86 532 87636960

[Http://www.haier.com](http://www.haier.com)

Edited by : Liu Tao
Zhang Jing

Signed by : Yang Bifei

Approved by: Wu Hongjin