

# Service Manual

## Inverter Pair Wall Mounted Type G-Series



[Applied Models]

- Inverter Pair: Heat Pump

# Service Manual

## Inverter Pair Wall Mounted Type G-Series



[Applied Models]

- Inverter Pair: Heat Pump

# Inverter Pair Wall Mounted Type G-Series

## ●Heat Pump

### Indoor Units

FTXL20G2V1B

FTXL25G2V1B

FTXL35G2V1B

### Outdoor Units

RXL20G2V1B

RXL25G2V1B

RXL35G2V1B

RXL20G2V1B9

1. Introduction .....	vii
1.1 Safety Cautions .....	vii
1.2 Used Icons .....	xi
<b>Part 1 List of Functions .....</b>	<b>1</b>
1. Functions.....	2
<b>Part 2 Specifications .....</b>	<b>3</b>
1. Specifications .....	4
<b>Part 3 Printed Circuit Board Connector Wiring Diagram .....</b>	<b>7</b>
1. Printed Circuit Board Connector Wiring Diagram.....	8
1.1 Indoor Unit.....	8
1.2 Outdoor Unit.....	11
<b>Part 4 Function and Control.....</b>	<b>19</b>
1. Main Functions .....	20
1.1 Frequency Principle.....	20
1.2 Airflow Direction Control.....	22
1.3 Fan Speed Control for Indoor Units.....	23
1.4 Program Dry Operation .....	24
1.5 Automatic Operation.....	25
1.6 Thermostat Control.....	26
1.7 NIGHT SET Mode .....	27
1.8 ECONO Operation .....	28
1.9 2-Area INTELLIGENT EYE Operation .....	29
1.10 Inverter POWERFUL Operation .....	31
1.11 Other Functions.....	32
2. Function of Thermistor .....	33
3. Control Specification .....	34
3.1 Mode Hierarchy .....	34
3.2 Frequency Control.....	35
3.3 Controls at Mode Changing / Start-up.....	37
3.4 Discharge Pipe Temperature Control.....	39
3.5 Input Current Control.....	40
3.6 Freeze-up Protection Control .....	41
3.7 Heating Peak-cut Control .....	41
3.8 Outdoor Fan Control.....	42
3.9 Liquid Compression Protection Function.....	42
3.10 Defrost Control .....	43
3.11 Electronic Expansion Valve Control .....	44
3.12 Malfunctions .....	47
3.13 Forced Operation Mode .....	48
3.14 Standby Electricity Saving.....	48
<b>Part 5 Operation Manual .....</b>	<b>49</b>
1. System Configuration.....	50
2. Operation Manual.....	51

2.1	Auto Dry Cool Heat Fan Operation .....	52
2.2	Adjusting the Airflow Direction.....	54
2.3	COMFORT AIRFLOW and INTELLIGENT EYE Operation.....	56
2.4	POWERFUL Operation .....	59
2.5	OUTDOOR UNIT QUIET Operation.....	60
2.6	ECONO Operation .....	61
2.7	TIMER Operation .....	62
2.8	WEEKLY TIMER Operation .....	64

## **Part 6 Service Diagnosis..... 69**

1.	Caution for Diagnosis.....	70
1.1	Troubleshooting with LED .....	70
2.	Problem Symptoms and Measures .....	71
3.	Service Check Function .....	72
3.1	ARC452 Series.....	72
4.	Troubleshooting .....	75
4.1	Error Codes and Description .....	75
4.2	Indoor Unit PCB Abnormality .....	76
4.3	Freeze-up Protection Control or Heating Peak-cut Control.....	77
4.4	Fan Motor (DC Motor) or Related Abnormality.....	79
4.5	Thermistor or Related Abnormality (Indoor Unit).....	81
4.6	Signal Transmission Error (between Indoor Unit and Outdoor Unit).....	82
4.7	Unspecified Voltage (between Indoor Unit and Outdoor Unit) .....	83
4.8	Outdoor Unit PCB Abnormality.....	84
4.9	OL Activation (Compressor Overload) .....	86
4.10	Compressor Lock .....	87
4.11	DC Fan Lock .....	88
4.12	Input Overcurrent Detection .....	89
4.13	Four Way Valve Abnormality.....	90
4.14	Discharge Pipe Temperature Control.....	92
4.15	High Pressure Control in Cooling .....	94
4.16	Compressor System Sensor Abnormality .....	96
4.17	Position Sensor Abnormality .....	98
4.18	DC Voltage / Current Sensor Abnormality (20/25 Class) .....	101
4.19	CT or Related Abnormality (35 Class).....	102
4.20	Thermistor or Related Abnormality (Outdoor Unit).....	104
4.21	Electrical Box Temperature Rise.....	106
4.22	Radiation Fin Temperature Rise .....	108
4.23	Output Overcurrent Detection .....	110
4.24	Refrigerant Shortage .....	112
4.25	Low-voltage Detection or Over-voltage Detection.....	115
4.26	Signal Transmission Error on Outdoor Unit PCB (35 Class Only).....	117
5.	Check .....	118
5.1	How to Check.....	118

## **Part 7 Removal Procedure..... 126**

1.	Indoor Unit.....	128
1.1	Removal of Air Filter.....	128
1.2	Removal of Front Panel.....	130

1.3	Removal of Front Grille .....	132
1.4	Removal of Horizontal Blades / Vertical Blades .....	135
1.5	Removal of Electrical Box .....	138
1.6	Removal of PCB.....	141
1.7	Removal of Indoor Heat Exchanger .....	146
1.8	Removal of Swing Motors .....	149
1.9	Removal of Fan Motor.....	153
2.	Outdoor Unit - RXL20G2V1B .....	156
2.1	Removal of Outer Panels / Fan Motor.....	156
2.2	Removal of Electrical Box .....	164
2.3	Removal of Drain Pan Heater .....	168
2.4	Removal of Thermistors .....	170
2.5	Removal of PCB.....	172
2.6	Removal of Reactor / Partition Plate .....	175
2.7	Removal of Sound Blanket.....	177
2.8	Removal of Four Way Valve.....	178
2.9	Removal of Compressor.....	181
3.	Outdoor Unit - RXL20G2V1B9 .....	183
3.1	Removal of Outer Panels / Fan Motor.....	183
3.2	Removal of Electrical Box .....	192
3.3	Removal of Drain Pan Heater .....	195
3.4	Removal of PCB.....	197
3.5	Removal of Reactor / Partition Plate .....	205
3.6	Removal of Sound Blanket.....	207
3.7	Removal of Four Way Valve.....	209
3.8	Removal of Compressor.....	212
4.	Outdoor Unit - RXL25G2V1B .....	214
4.1	Removal of Outer Panels .....	214
4.2	Removal of Electrical Box .....	216
4.3	Removal of PCB.....	221
4.4	Removal of Drain Pan Heater .....	226
4.5	Removal of Sound Blanket.....	228
4.6	Removal of Outdoor Fan / Fan Motor.....	230
4.7	Removal of Thermistors .....	233
4.8	Removal of Four Way Valve / Electronic Expansion Valve .....	234
4.9	Removal of Compressor.....	237
5.	Outdoor Unit - RXL35G2V1B .....	240
5.1	Removal of Outer Panels .....	240
5.2	Removal of Outdoor Fan / Fan Motor.....	244
5.3	Removal of Electrical Box .....	248
5.4	Removal of PCB.....	254
5.5	Removal of Drain Pan Heater .....	257
5.6	Removal of Sound Blanket / Thermistors.....	259
5.7	Removal of Four Way Valve.....	261
5.8	Removal of Electronic Expansion Valve.....	262
5.9	Removal of Compressor.....	263

## **Part 8 Trial Operation and Field Settings..... 266**

1.	Trial Operation .....	267
2.	Field Settings .....	268
2.1	When 2 Units are Installed in 1 Room.....	268

- 2.2 Standby Electricity Saving .....269
- 2.3 Jumper and Switch Settings .....270
- 3. Application of Silicon Grease to a Power Transistor and a Diode Bridge .271

**Part 9 Appendix.....272**

- 1. Piping Diagrams .....273
  - 1.1 Indoor Unit.....273
  - 1.2 Outdoor Unit.....274
- 2. Wiring Diagrams.....276
  - 2.1 Indoor Unit.....276
  - 2.2 Outdoor Unit.....276















# 1. Introduction



## 1.1 Safety Cautions









### Cautions and Warnings

- Be sure to read the following safety cautions before conducting repair work.
- The caution items are classified into “ **Warning**” and “ **Caution**”. The “ **Warning**” items are especially important since they can lead to death or serious injury if they are not followed closely. The “ **Caution**” items can also lead to serious accidents under some conditions if they are not followed. Therefore, be sure to observe all the safety caution items described below.
- About the pictograms
  - △ This symbol indicates the item for which caution must be exercised.  
The pictogram shows the item to which attention must be paid.
  - This symbol indicates the prohibited action.  
The prohibited item or action is shown in the illustration or near the symbol.
  - This symbol indicates the action that must be taken, or the instruction.  
The instruction is shown in the illustration or near the symbol.
- After the repair work is complete, be sure to conduct a test operation to ensure that the equipment operates normally, and explain the cautions for operating the product to the customer.











### 1.1.1 Cautions Regarding Safety of Workers





 <b>Warning</b>	
Be sure to disconnect the power cable plug from the plug socket before disassembling the equipment for repair. Working on the equipment that is connected to the power supply may cause an electrical shock. If it is necessary to supply power to the equipment to conduct the repair or inspecting the circuits, do not touch any electrically charged sections of the equipment.	
If the refrigerant gas is discharged during the repair work, do not touch the discharged refrigerant gas. The refrigerant gas may cause frostbite.	
When disconnecting the suction or discharge pipe of the compressor at the welded section, evacuate the refrigerant gas completely at a well-ventilated place first. If there is a gas remaining inside the compressor, the refrigerant gas or refrigerating machine oil discharges when the pipe is disconnected, and it may cause injury.	
If the refrigerant gas leaks during the repair work, ventilate the area. The refrigerant gas may generate toxic gases when it contacts flames.	
The step-up capacitor supplies high-voltage electricity to the electrical components of the outdoor unit. Be sure to discharge the capacitor completely before conducting repair work. A charged capacitor may cause an electrical shock.	
Do not start or stop the air conditioner operation by plugging or unplugging the power cable plug. Plugging or unplugging the power cable plug to operate the equipment may cause an electrical shock or fire.	







 <b>Warning</b>	
Be sure to wear a safety helmet, gloves, and a safety belt when working at a high place (more than 2 m). Insufficient safety measures may cause a fall accident.	
In case of R-410A refrigerant models, be sure to use pipes, flare nuts and tools for the exclusive use of the R-410A refrigerant. The use of materials for R-22 refrigerant models may cause a serious accident such as a damage of refrigerant cycle as well as an equipment failure.	





 <b>Caution</b>	
Do not repair the electrical components with wet hands. Working on the equipment with wet hands may cause an electrical shock.	
Do not clean the air conditioner by splashing water. Washing the unit with water may cause an electrical shock.	
Be sure to provide the grounding when repairing the equipment in a humid or wet place, to avoid electrical shocks.	
Be sure to turn off the power switch and unplug the power cable when cleaning the equipment. The internal fan rotates at a high speed, and cause injury.	
Be sure to conduct repair work with appropriate tools. The use of inappropriate tools may cause injury.	
Be sure to check that the refrigerating cycle section has cooled down enough before conducting repair work. Working on the unit when the refrigerating cycle section is hot may cause burns.	
Use the welder in a well-ventilated place. Using the welder in an enclosed room may cause oxygen deficiency.	

## 1.1.2 Cautions Regarding Safety of Users

 <b>Warning</b>	
<p>Be sure to use parts listed in the service parts list of the applicable model and appropriate tools to conduct repair work. Never attempt to modify the equipment. The use of inappropriate parts or tools may cause an electrical shock, excessive heat generation or fire.</p>	
<p>If the power cable and lead wires have scratches or deteriorated, be sure to replace them. Damaged cable and wires may cause an electrical shock, excessive heat generation or fire.</p>	
<p>Do not use a joined power cable or extension cable, or share the same power outlet with other electrical appliances, since it may cause an electrical shock, excessive heat generation or fire.</p>	
<p>Be sure to use an exclusive power circuit for the equipment, and follow the local technical standards related to the electrical equipment, the internal wiring regulations, and the instruction manual for installation when conducting electrical work. Insufficient power circuit capacity and improper electrical work may cause an electrical shock or fire.</p>	
<p>Be sure to use the specified cable for wiring between the indoor and outdoor units. Make the connections securely and route the cable properly so that there is no force pulling the cable at the connection terminals. Improper connections may cause excessive heat generation or fire.</p>	
<p>When wiring between the indoor and outdoor units, make sure that the terminal cover does not lift off or dismount because of the cable. If the cover is not mounted properly, the terminal connection section may cause an electrical shock, excessive heat generation or fire.</p>	
<p>Do not damage or modify the power cable. Damaged or modified power cable may cause an electrical shock or fire. Placing heavy items on the power cable, and heating or pulling the power cable may damage the cable.</p>	
<p>Do not mix air or gas other than the specified refrigerant (R-410A / R-22) in the refrigerant system. If air enters the refrigerating system, an excessively high pressure results, causing equipment damage and injury.</p>	
<p>If the refrigerant gas leaks, be sure to locate the leaking point and repair it before charging the refrigerant. After charging refrigerant, make sure that there is no refrigerant leak. If the leaking point cannot be located and the repair work must be stopped, be sure to perform pump-down and close the service valve, to prevent the refrigerant gas from leaking into the room. The refrigerant gas itself is harmless, but it may generate toxic gases when it contacts flames, such as fan and other heaters, stoves and ranges.</p>	
<p>When relocating the equipment, make sure that the new installation site has sufficient strength to withstand the weight of the equipment. If the installation site does not have sufficient strength and if the installation work is not conducted securely, the equipment may fall and cause injury.</p>	





 <b>Warning</b>	
Check to make sure that the power cable plug is not dirty or loose, then insert the plug into a power outlet securely. If the plug has dust or loose connection, it may cause an electrical shock or fire.	
Be sure to install the product correctly by using the provided standard installation frame. Incorrect use of the installation frame and improper installation may cause the equipment to fall, resulting in injury.	For unitary type only 
Be sure to install the product securely in the installation frame mounted on the window frame. If the unit is not securely mounted, it may fall and cause injury.	For unitary type only 
When replacing the coin battery in the remote control, be sure to disposed of the old battery to prevent children from swallowing it. If a child swallows the coin battery, see a doctor immediately.	

 <b>Caution</b>	
Installation of a leakage breaker is necessary in some cases depending on the conditions of the installation site, to prevent electrical shocks.	
Do not install the equipment in a place where there is a possibility of combustible gas leaks. If the combustible gas leaks and remains around the unit, it may cause a fire.	
Check to see if the parts and wires are mounted and connected properly, and if the connections at the soldered or crimped terminals are secure. Improper installation and connections may cause excessive heat generation, fire or an electrical shock.	
If the installation platform or frame has corroded, replace it. Corroded installation platform or frame may cause the unit to fall, resulting in injury.	
Check the grounding, and repair it if the equipment is not properly grounded. Improper grounding may cause an electrical shock.	

 <b>Caution</b>	
Be sure to measure the insulation resistance after the repair, and make sure that the resistance is 1 MΩ or higher. Faulty insulation may cause an electrical shock.	
Be sure to check the drainage of the indoor unit after the repair. Faulty drainage may cause the water to enter the room and wet the furniture and floor.	
Do not tilt the unit when removing it. The water inside the unit may spill and wet the furniture and floor.	
Be sure to install the packing and seal on the installation frame properly. If the packing and seal are not installed properly, water may enter the room and wet the furniture and floor.	For unitary type only  

## 1.2 Used Icons

Icons are used to attract the attention of the reader to specific information. The meaning of each icon is described in the table below:

Icon	Type of Information	Description
 Note:	Note	A “note” provides information that is not indispensable, but may nevertheless be valuable to the reader, such as tips and tricks.
 Caution	Caution	A “caution” is used when there is danger that the reader, through incorrect manipulation, may damage equipment, lose data, get an unexpected result or has to restart (part of) a procedure.
 Warning	Warning	A “warning” is used when there is danger of personal injury.
	Reference	A “reference” guides the reader to other places in this binder or in this manual, where he/she will find additional information on a specific topic.



# Part 1

# List of Functions

1. Functions.....2

# 1. Functions

Category	Functions	FTXL20/25G2V1B RXL20/25G2V1B RXL20G2V1B9	FTXL35G2V1B RXL35G2V1B	Category	Functions	FTXL20/25G2V1B RXL20/25G2V1B RXL20G2V1B9	FTXL35G2V1B RXL35G2V1B
Basic Function	Inverter (with Inverter Power Control)	○	○	Health & Clean	Air-Purifying Filter	—	—
	Operation Limit for Cooling (°CDB)	-10 ~46	-10 ~46		Photocatalytic Deodorizing Filter	—	—
	Operation Limit for Heating (°CWB)	-20 ~20	-20 ~20		Air-Purifying Filter with Photocatalytic Deodorizing Function	—	—
	PAM Control	○	○		Titanium Apatite Photocatalytic Air-Purifying Filter	○	○
	Standby Electricity Saving	○	—		Air Filter (Prefilter)	○	○
Compressor	Oval Scroll Compressor	—	—	Wipe-Clean Flat Panel	○	○	
	Swing Compressor	○	○	Washable Grille	—	—	
	Rotary Compressor	—	—	MOLD PROOF Operation	—	—	
	Reluctance DC Motor	○	○	Good-Sleep Cooling Operation	—	—	
Comfortable Airflow	Power-Airflow Flap	—	—	Timer	WEEKLY TIMER Operation	○	○
	Power-Airflow Dual Flaps	○	○		24-Hour ON/OFF TIMER	○	○
	Power-Airflow Diffuser	—	—		NIGHT SET Mode	○	○
	Wide-Angle Louvers	○	○	Worry Free "Reliability & Durability"	Auto-Restart (after Power Failure)	○	○
	Vertical Auto-Swing (Up and Down)	○	○		Self-Diagnosis (Digital, LED) Display	○	○
	Horizontal Auto-Swing (Right and Left)	○	○		Wiring Error Check	—	—
	3-D Airflow	○	○		Anti-Corrosion Treatment of Outdoor Heat Exchanger	○	○
	COMFORT AIRFLOW Operation	○	○		Drain Pan Heater	○	○
Comfort Control	Auto Fan Speed	○	○	Flexibility	Multi-Split / Split Type Compatible Indoor Unit	—	—
	Indoor Unit Quiet Operation	○	○		Flexible Voltage Correspondence	—	—
	NIGHT QUIET Mode (Automatic)	—	—		High Ceiling Application	—	—
	OUTDOOR UNIT QUIET Operation (Manual)	○	○		Chargeless	10 m	10 m
	2-Area INTELLIGENT EYE Operation	○	○		Either Side Drain (Right or Left)	○	○
	INTELLIGENT EYE Operation	—	—		Power Selection	—	—
	Quick Warming Function (Preheating Operation)	○	○		Remote Control	5-Rooms Centralized Controller (Option)	○
	Hot-Start Function	○	○	Remote Control Adapter (Normal Open Pulse Contact) (Option)		○	○
Operation	Automatic Defrosting	○	○	Remote Control Adapter Adapter (Normal Open Contact) (Option)	○	○	
	Automatic Operation	○	○	DIII-NET Compatible (Adapter) (Option)	○	○	
	Program Dry Operation	○	○	Wireless	○	○	
Lifestyle Convenience	Fan Only	○	○	Wired (Option)	○	○	
	New POWERFUL Operation (Non-Inverter)	—	—				
	Inverter POWERFUL Operation	○	○				
	Priority-Room Setting	—	—				
	COOL / HEAT Mode Lock	—	—				
	HOME LEAVE Operation	—	—				
	ECONO Operation	○	○				
	Indoor Unit ON/OFF Button	○	○				
Signal Receiving Sign	○	○					
Temperature Display	—	—					

**Note:** ○ : Holding Functions  
 — : No Functions



# Part 2 Specifications

1. Specifications .....4

# 1. Specifications

50 Hz, 220 - 230 - 240V

Models	Indoor Units		FTXL20G2V1B		FTXL20G2V1B	
	Outdoor Units		RXL20G2V1B		RXL20G2V1B9	
			Cooling	Heating	Cooling	Heating
Capacity Rated (Min. ~ Max.)	kW		2.0 (1.4 ~ 4.0)	2.7 (1.4 ~ 5.2)	2.0 (1.4 ~ 4.0)	2.7 (1.4 ~ 5.2)
	Btu/h		6,800 (4,800 ~ 13,600)	9,200 (4,800 ~ 17,700)	6,800 (4,800 ~ 13,600)	9,200 (4,800 ~ 17,700)
	kcal/h		1,720 (1,200 ~ 3,440)	2,320 (1,200 ~ 4,470)	1,720 (1,200 ~ 3,440)	2,320 (1,200 ~ 4,470)
Moisture Removal	L/h		0.9	—	0.9	—
Running Current (Rated)	A		2.5 - 2.4 - 2.3	3.1 - 3.0 - 2.9	2.5 - 2.4 - 2.3	3.1 - 3.0 - 2.9
Power Consumption Rated (Min. ~ Max.)	W		450 (350 ~ 1,190)	590 (340 ~ 1,460)	450 (350 ~ 1,190)	590 (340 ~ 1,460)
Power Factor	%		81.8 - 81.5 - 81.5	86.5 - 85.5 - 84.8	81.8 - 81.5 - 81.5	86.5 - 85.5 - 84.8
COP (Rated)	W/W		4.44 (4.00 ~ 3.36)	4.58 (4.12 ~ 3.56)	4.44 (4.00 ~ 3.36)	4.58 (4.12 ~ 3.56)
Piping Connections	Liquid	mm	φ 6.4		φ 6.4	
	Gas	mm	φ 9.5		φ 9.5	
	Drain	mm	φ 18.0		φ 18.0	
Heat Insulation			Both Liquid and Gas Pipes		Both Liquid and Gas Pipes	
Max. Interunit Piping Length	m		20		20	
Max. Interunit Height Difference	m		15		15	
Chargeless	m		10		10	
Amount of Additional Charge of Refrigerant	g/m		20		20	
<b>Indoor Units</b>		<b>FTXL20G2V1B</b>		<b>FTXL20G2V1B</b>		
Front Panel Color		White		White		
Airflow Rate	m <sup>3</sup> /min (cfm)	H	10.4 (367)	10.6 (374)	10.4 (367)	10.6 (374)
		M	7.7 (270)	8.5 (302)	7.7 (270)	8.5 (302)
		L	4.8 (170)	6.4 (226)	4.8 (170)	6.4 (226)
		SL	3.5 (125)	5.4 (191)	3.5 (125)	5.4 (191)
Fan	Type	Cross Flow Fan		Cross Flow Fan		
	Motor Output	W	23		23	
	Speed	Steps	5 Steps, Quiet, Auto		5 Steps, Quiet, Auto	
Air Direction Control			Right, Left, Horizontal, Downward		Right, Left, Horizontal, Downward	
Air Filter			Removable / Washable / Mildew Proof		Removable / Washable / Mildew Proof	
Running Current (Rated)	A		0.12 - 0.12 - 0.11	0.13 - 0.13 - 0.12	0.12 - 0.12 - 0.11	0.13 - 0.13 - 0.12
Power Consumption (Rated)	W		26 - 26 - 26	28 - 28 - 28	26 - 26 - 26	28 - 28 - 28
Power Factor	%		98.5 - 94.2 - 98.5	97.9 - 93.6 - 97.2	98.5 - 94.2 - 98.5	97.9 - 93.6 - 97.2
Temperature Control			Microcomputer Control		Microcomputer Control	
Dimensions (H × W × D)	mm		295 × 800 × 215		295 × 800 × 215	
Packaged Dimensions (H × W × D)	mm		274 × 870 × 366		274 × 870 × 366	
Weight	kg		10		10	
Gross Weight	kg		14		14	
Operation Sound	H / M / L / SL	dBA	42 / 34 / 26 / 23	42 / 36 / 29 / 26	42 / 34 / 26 / 23	42 / 36 / 29 / 26
Sound Power		dBA	58	58	58	58
<b>Outdoor Units</b>		<b>RXL20G2V1B</b>		<b>RXL20G2V1B9</b>		
Casing Color		Ivory White		Ivory White		
Compressor	Type	Hermetically Sealed Swing Type		Hermetically Sealed Swing Type		
	Model	1YC23AFXD		1YC23AEXD		
	Motor Output	W	600		600	
Refrigerant Oil	Type	FVC50K		FVC50K		
	Charge	L	0.375		0.375	
Refrigerant	Type	R-410A		R-410A		
	Charge	kg	1.2		1.2	
Airflow Rate	m <sup>3</sup> /min (cfm)	H	36.0 (1,272)	30.2 (1,066)	36.0 (1,272)	30.6 (1,080)
		SL	31.4 (1,109)	22.6 (798)	32.7 (1,153)	28.5 (1,005)
Fan	Type	Propeller		Propeller		
	Motor Output	W	50		23	
Running Current (Rated)	A		2.38 - 2.28 - 2.19	2.97 - 2.87 - 2.78	2.38 - 2.28 - 2.19	2.97 - 2.87 - 2.78
Power Consumption (Rated)	W		424 - 424 - 424	562 - 562 - 562	424 - 424 - 424	562 - 562 - 562
Power Factor	%		81.0 - 80.9 - 80.7	86.0 - 85.1 - 84.2	81.0 - 80.9 - 80.7	86.0 - 85.1 - 84.2
Starting Current	A		4.8		4.8	
Dimensions (H × W × D)	mm		550 × 765 × 285		550 × 765 × 285	
Packaged Dimensions (H × W × D)	mm		612 × 906 × 364		612 × 906 × 364	
Weight	kg		34		34	
Gross Weight	kg		40		38	
Operation Sound	H / SL	dBA	48 / 44	48 / 45	48 / 44	48 / 45
Sound Power	H	dBA	63	63	63	63
Drawing No.			3D062678		3D066479	

**Note:** ■ The data are based on the conditions shown in the table below.

Cooling	Heating	Piping Length
Indoor ; 27°CDB / 19°CWB Outdoor ; 35°CDB / 24°CWB	Indoor ; 20°CDB Outdoor ; 7°CDB / 6°CWB	5 m

Conversion Formulae
kcal/h = kW × 860 Btu/h = kW × 3412 cfm = m <sup>3</sup> /min × 35.3

50 Hz, 220 - 230 - 240V

Models	Indoor Units		FTXL25G2V1B		FTXL35G2V1B	
	Outdoor Units		RXL25G2V1B		RXL35G2V1B	
			Cooling	Heating	Cooling	Heating
Capacity Rated (Min. ~ Max.)	kW		2.5 (1.7 ~ 5.0)	3.4 (1.7 ~ 6.0)	3.5 (1.7 ~ 5.3)	4.0 (1.7 ~ 6.6)
	Btu/h		8,500 (5,800 ~ 17,100)	11,600 (5,800 ~ 20,500)	11,900 (5,800 ~ 18,100)	13,600 (5,800 ~ 22,500)
	kcal/h		2,150 (1,460 ~ 4,300)	2,920 (1,460 ~ 5,160)	3,010 (1,460 ~ 4,560)	3,440 (1,460 ~ 5,680)
Moisture Removal	L/h		1.2	—	1.9	—
Running Current (Rated)	A		3.1 - 3.0 - 2.9	4.3 - 4.1 - 3.9	4.1 - 3.9 - 3.7	4.3 - 4.1 - 3.9
Power Consumption Rated (Min. ~ Max.)	W		550 (440 ~ 2,230)	770 (400 ~ 1,980)	870 (440 ~ 1,810)	920 (400 ~ 2,010)
Power Factor	%		80.6 - 79.7 - 79.0	81.3 - 81.7 - 82.3	96.4 - 96.9 - 97.9	97.2 - 97.5 - 98.2
COP (Rated)	W/W		4.55 (3.86 ~ 2.24)	4.42 (4.25 ~ 3.03)	4.02 (3.86 ~ 2.93)	4.35 (4.25 ~ 3.30)
Piping Connections	Liquid	mm	φ 6.4		φ 6.4	
	Gas	mm	φ 9.5		φ 12.7	
	Drain	mm	φ 18.0		φ 18.0	
Heat Insulation			Both Liquid and Gas Pipes		Both Liquid and Gas Pipes	
Max. Interunit Piping Length	m		20		20	
Max. Interunit Height Difference	m		15		15	
Chargeless	m		10		10	
Amount of Additional Charge of Refrigerant	g/m		20		20	
<b>Indoor Units</b>			<b>FTXL25G2V1B</b>		<b>FTXL35G2V1B</b>	
Front Panel Color			White		White	
Airflow Rate	m <sup>3</sup> /min (cfm)	H	9.1 (321)	11.2 (395)	10.2 (360)	11.0 (388)
		M	7.7 (273)	9.4 (333)	8.6 (305)	9.3 (330)
		L	6.3 (221)	7.7 (271)	7.0 (246)	7.6 (267)
		SL	5.4 (190)	6.8 (240)	6.0 (212)	6.7 (236)
Fan	Type		Cross Flow Fan		Cross Flow Fan	
	Motor Output	W	23		23	
	Speed	Steps	5 Steps, Quiet, Auto		5 Steps, Quiet, Auto	
Air Direction Control			Right, Left, Horizontal, Downward		Right, Left, Horizontal, Downward	
Air Filter			Removable / Washable / Mildew Proof		Removable / Washable / Mildew Proof	
Running Current (Rated)	A		0.11 - 0.11 - 0.10	0.14 - 0.14 - 0.13	0.12 - 0.12 - 0.11	0.15 - 0.14 - 0.14
Power Consumption (Rated)	W		24 - 24 - 24	30 - 30 - 30	26 - 26 - 26	32 - 32 - 32
Power Factor	%		99.2 - 94.9 - 100.0	97.4 - 93.2 - 96.2	98.5 - 94.2 - 98.5	97.0 - 99.4 - 95.2
Temperature Control			Microcomputer Control		Microcomputer Control	
Dimensions (H × W × D)	mm		295 × 800 × 215		295 × 800 × 215	
Packaged Dimensions (H × W × D)	mm		274 × 870 × 366		274 × 870 × 366	
Weight	kg		10		10	
Gross Weight	kg		14		14	
Operation Sound	H / M / L / SL	dBA	42 / 38 / 33 / 30	42 / 38 / 33 / 30	43 / 39 / 34 / 31	44 / 39 / 34 / 31
Sound Power		dBA	58	58	59	60
<b>Outdoor Units</b>			<b>RXL25G2V1B</b>		<b>RXL35G2V1B</b>	
Casing Color			Ivory White		Ivory White	
Compressor	Type		Hermetically Sealed Swing Type		Hermetically Sealed Swing Type	
	Model		2YC36BXD		2YC36BXD	
	Motor Output	W	1,100		1,100	
Refrigerant Oil	Type		FVC50K		FVC50K	
	Charge	L	0.65		0.65	
Refrigerant	Type		R-410A		R-410A	
	Charge	kg	1.3		1.7	
Airflow Rate	m <sup>3</sup> /min (cfm)	H	37.3 (1,317)	31.3 (1,107)	50.9 (1,797)	45.0 (1,589)
		SL	30.6 (1,079)	27.2 (959)	48.9 (1,727)	43.1 (1,522)
Fan	Type		Propeller		Propeller	
	Motor Output	W	50		53	
Running Current (Rated)	A		2.99 - 2.89 - 2.80	4.16 - 3.96 - 3.77	3.98 - 3.78 - 3.59	4.15 - 3.96 - 3.76
Power Consumption (Rated)	W		526 - 526 - 526	740 - 740 - 740	844 - 844 - 844	888 - 888 - 888
Power Factor	%		80.0 - 79.1 - 78.3	80.9 - 81.2 - 81.8	96.4 - 97.1 - 98.0	97.3 - 97.5 - 98.4
Starting Current	A		7.4		7.3	
Dimensions (H × W × D)	mm		550 × 765 × 285		735 × 825 × 300	
Packaged Dimensions (H × W × D)	mm		612 × 906 × 364		797 × 960 × 390	
Weight	kg		39		48	
Gross Weight	kg		45		53	
Operation Sound	H / SL	dBA	48 / 44	48 / 45	48 / 44	48 / 45
Sound Power	H	dBA	63	63	62	62
Drawing No.			3D062679		3D062680	

**Note:** ■ The data are based on the conditions shown in the table below.

Cooling	Heating	Piping Length
Indoor ; 27°CDB / 19°CWB	Indoor ; 20°CDB	5 m
Outdoor ; 35°CDB / 24°CWB	Outdoor ; 7°CDB / 6°CWB	

Conversion Formulae
kcal/h = kW × 860
Btu/h = kW × 3412
cfm = m <sup>3</sup> /min × 35.3



# Part 3

# Printed Circuit Board

# Connector Wiring Diagram

1. Printed Circuit Board Connector Wiring Diagram.....	8
1.1 Indoor Unit.....	8
1.2 Outdoor Unit.....	11

# 1. Printed Circuit Board Connector Wiring Diagram

## 1.1 Indoor Unit

### Connectors and Other Parts

#### PCB (1): Control PCB

- |                      |                                                                                   |
|----------------------|-----------------------------------------------------------------------------------|
| 1) S1                | Connector for DC fan motor                                                        |
| 2) S21               | Connector for centralized control (HA)                                            |
| 3) S25               | Connector for INTELLIGENT EYE sensor PCB                                          |
| 4) S32               | Connector for indoor heat exchanger thermistor                                    |
| 5) S41               | Connector for swing motors                                                        |
| 6) S46               | Connector for display PCB                                                         |
| 7) S47               | Connector for signal receiver PCB                                                 |
| 8) H1, H2, H3,<br>FG | Connector for terminal board                                                      |
| 9) JA                | Address setting jumper<br>* Refer to page 268 for detail.                         |
| JB                   | Fan speed setting when compressor stops for thermostat OFF                        |
| JC                   | Power failure recovery function (auto-restart)<br>* Refer to page 270 for detail. |
| 10) LED A            | LED for service monitor (green)                                                   |
| 11) FU1 (F1U)        | Fuse (3.15 A, 250 V)                                                              |
| 12) V1               | Varistor                                                                          |

#### PCB (2): Signal Receiver PCB

- |        |                           |
|--------|---------------------------|
| 1) S48 | Connector for control PCB |
|--------|---------------------------|

#### PCB (3): Display PCB

- |               |                                  |
|---------------|----------------------------------|
| 1) S49        | Connector for control PCB        |
| 2) SW1 (S1W)  | Forced operation ON / OFF button |
| 3) LED1 (H1P) | LED for operation (green)        |
| 4) LED2 (H2P) | LED for timer (yellow)           |
| 5) LED3 (H3P) | LED for INTELLIGENT EYE (green)  |
| 6) RTH1 (R1T) | Room temperature thermistor      |

#### PCB (4): INTELLIGENT EYE Sensor PCB

- |        |                           |
|--------|---------------------------|
| 1) S26 | Connector for control PCB |
|--------|---------------------------|

PCB Detail

PCB (1): Control PCB

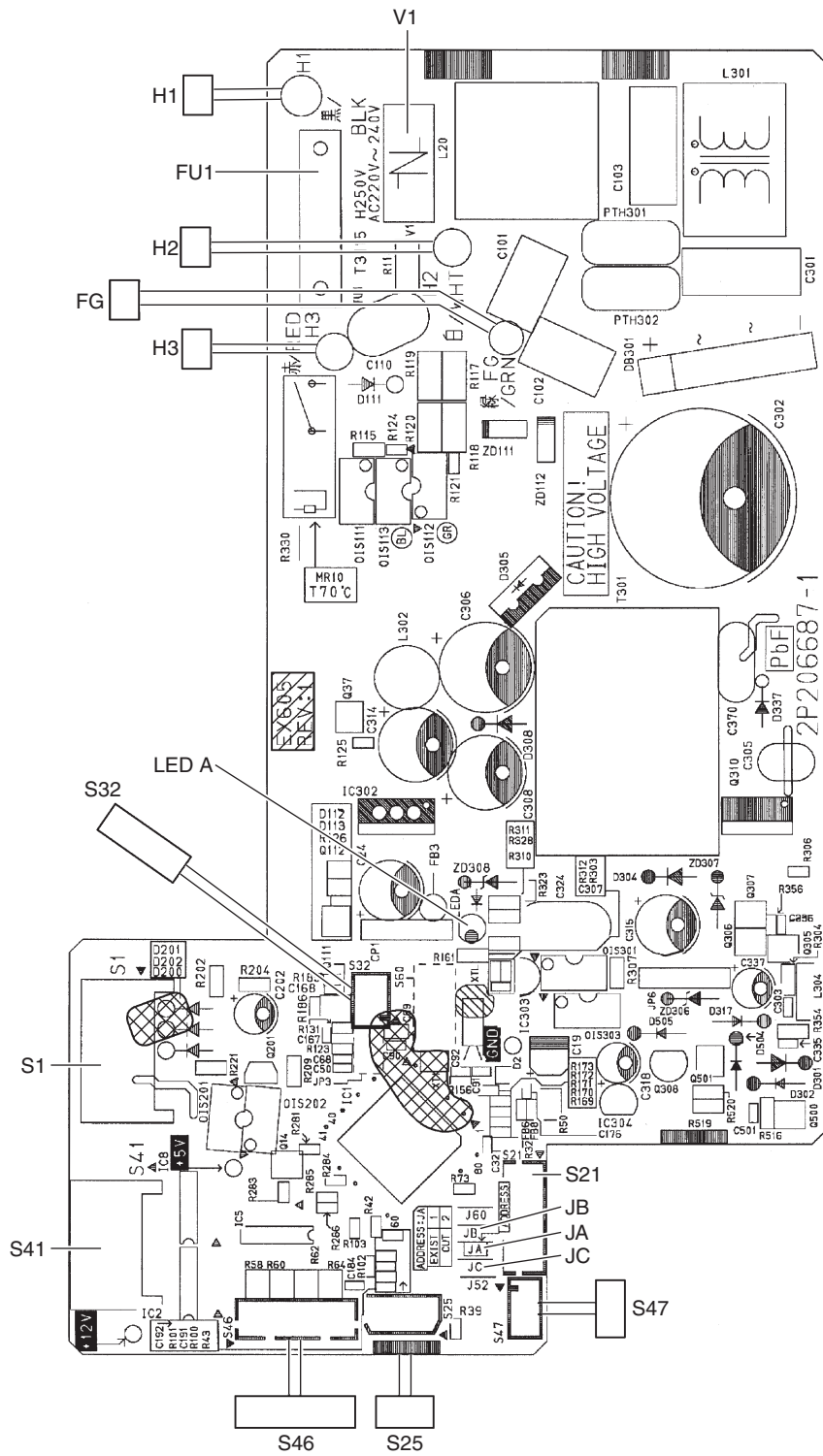

2P206687-1

**PCB (2): Signal Receiver PCB**

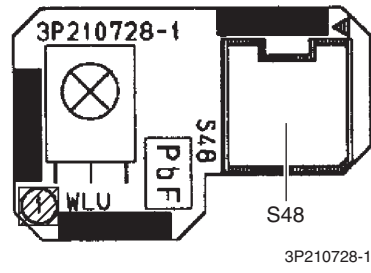

**PCB (3): Display PCB**

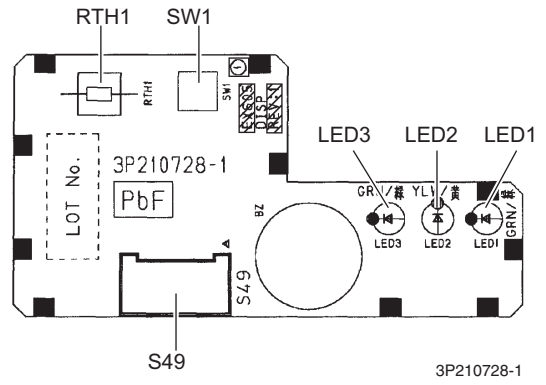

**PCB (4): INTELLIGENT EYE Sensor PCB**

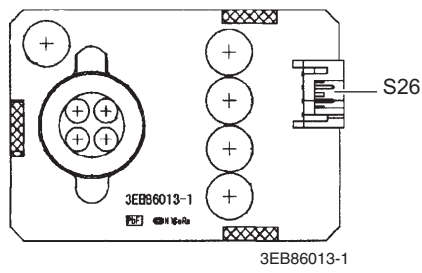



## 1.2 Outdoor Unit

### 1.2.1 RXL20G2V1B

#### Connectors and Other Parts

#### PCB (1): Filter PCB

- |                |                                      |
|----------------|--------------------------------------|
| 1) S11         | Connector for main PCB               |
| 2) HL1, HN1, S | Connector for terminal board         |
| 3) E1          | Terminal for earth                   |
| 4) E2          | Connector for terminal board (earth) |
| 5) HL2, HN2    | Connector for main PCB               |
| 6) HR1         | Connector for reactor                |
| 7) FU3         | Fuse (20 A, 250 V)                   |
| 8) V2, V3      | Varistor                             |

#### PCB (2): Main PCB

- |              |                                                                                            |
|--------------|--------------------------------------------------------------------------------------------|
| 1) S10       | Connector for filter PCB                                                                   |
| 2) S20       | Connector for electronic expansion valve coil                                              |
| 3) S30       | Connector for compressor                                                                   |
| 4) S40       | Connector for overload protector                                                           |
| 5) S50       | Connector for magnetic relay                                                               |
| 6) S70       | Connector for fan motor                                                                    |
| 7) S80       | Connector for four way valve coil                                                          |
| 8) S90       | Connector for thermistors<br>(outdoor temperature, outdoor heat exchanger, discharge pipe) |
| 9) HL3, HN3  | Connector for filter PCB                                                                   |
| 10) HR2      | Connector for reactor                                                                      |
| 11) FU1, FU2 | Fuse (3.15 A, 250 V)                                                                       |
| 12) LED A    | LED for service monitor (green)                                                            |
| 13) V1       | Varistor                                                                                   |
| 14) J5       | Jumper for improvement of defrost performance<br>* Refer to page 270 for detail.           |

PCB Detail

PCB (1): Filter PCB

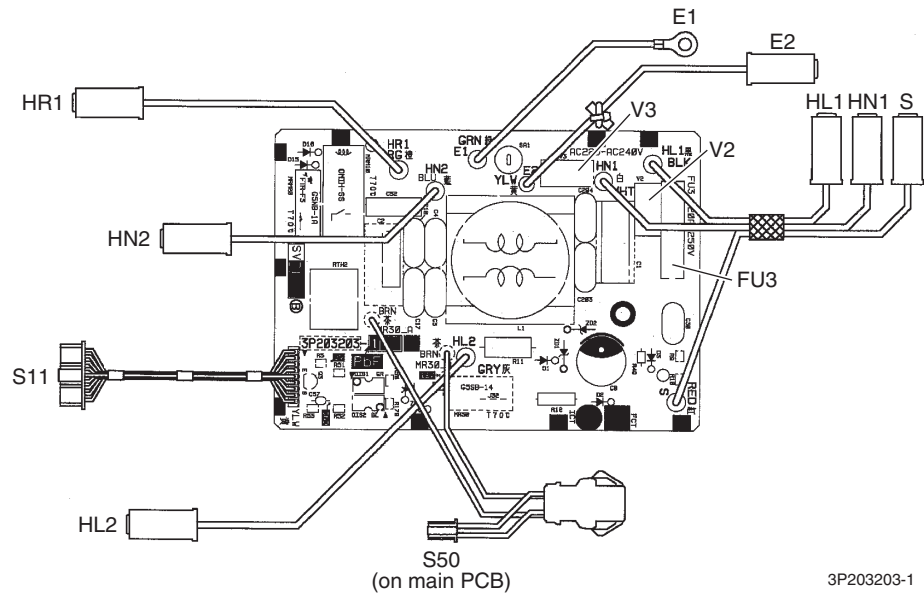

PCB (2): Main PCB

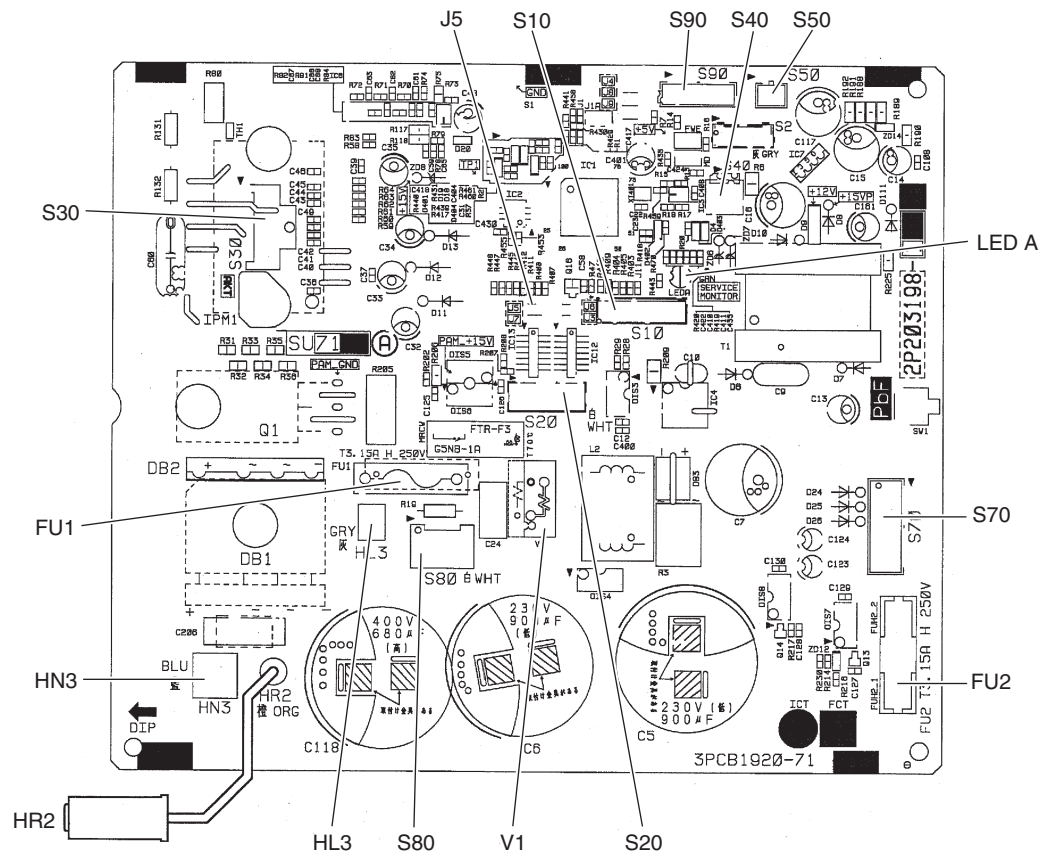

2P203198-1

## 1.2.2 RXL20G2V1B9

### Connectors and Other Parts

#### PCB (1): Filter PCB

- |                |                              |
|----------------|------------------------------|
| 1) S11         | Connector for main PCB       |
| 2) AC1, AC2, S | Connector for terminal board |
| 3) E1, E2      | Terminal for earth           |
| 4) HL2, HN2    | Connector for main PCB       |
| 5) HR1         | Connector for reactor        |
| 6) FU1         | Fuse (3.15 A, 250 V)         |
| 7) FU3         | Fuse (20 A, 250 V)           |
| 8) V2, V3      | Varistor                     |

#### PCB (2): Main PCB

- |             |                                                                                            |
|-------------|--------------------------------------------------------------------------------------------|
| 1) S10      | Connector for filter PCB                                                                   |
| 2) S20      | Connector for electronic expansion valve coil                                              |
| 3) S40      | Connector for overload protector                                                           |
| 4) S50      | Connector for magnetic relay                                                               |
| 5) S70      | Connector for fan motor                                                                    |
| 6) S80      | Connector for four way valve coil                                                          |
| 7) S90      | Connector for thermistors<br>(outdoor temperature, outdoor heat exchanger, discharge pipe) |
| 8) S100     | Connector for forced operation button PCB                                                  |
| 9) HL3, HN3 | Connector for filter PCB                                                                   |
| 10) HR2     | Connector for reactor                                                                      |
| 11) U, V, W | Connector for compressor                                                                   |
| 12) FU2     | Fuse (3.15 A, 250 V)                                                                       |
| 13) LED A   | LED for service monitor (green)                                                            |
| 14) V1      | Varistor                                                                                   |
| 15) J5      | Jumper for improvement of defrost performance<br>* Refer to page 270 for detail.           |

#### PCB (3): Forced Operation Button PCB

- |         |                                |
|---------|--------------------------------|
| 1) S110 | Connector for main PCB         |
| 2) SW1  | Forced operation ON/OFF button |

PCB Detail

PCB (1): Filter PCB

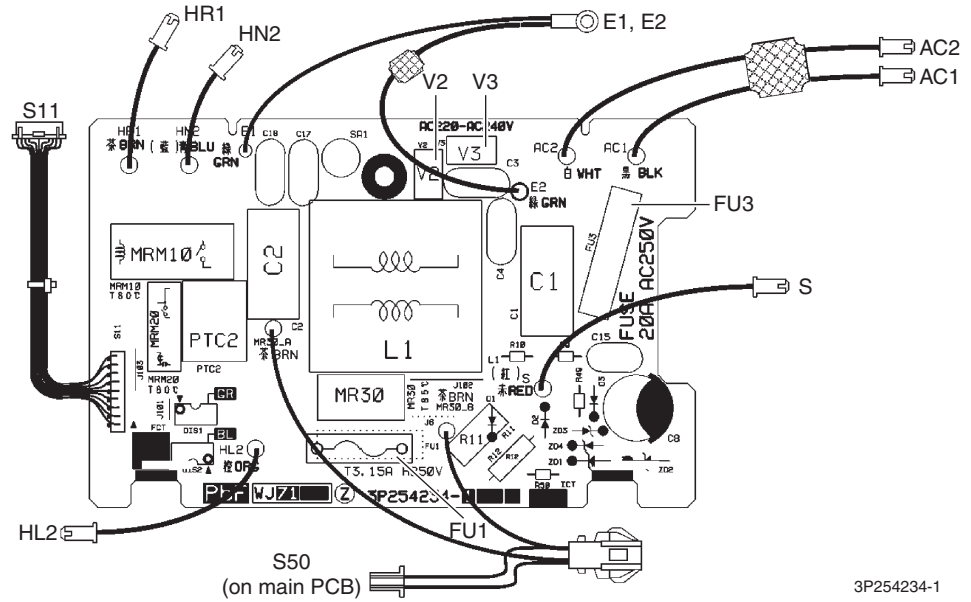

PCB (2): Main PCB

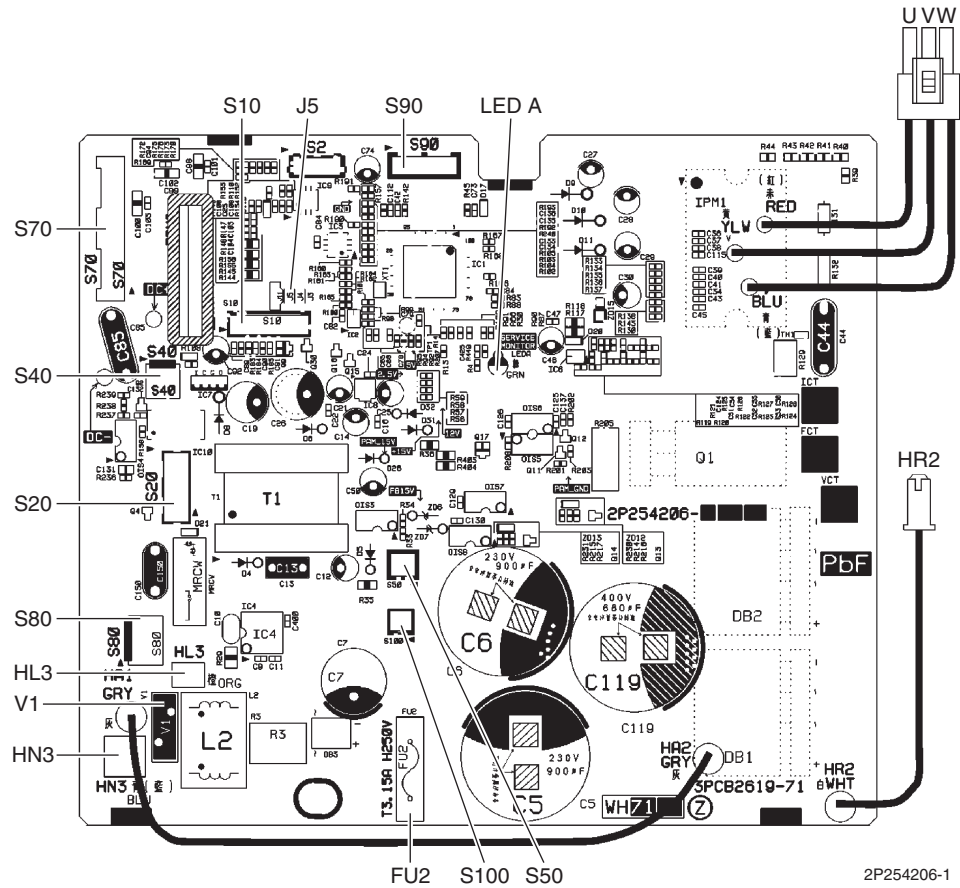

PCB (3): Forced Operation Button PCB

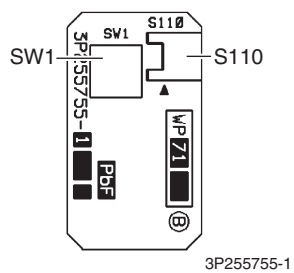

### 1.2.3 RXL25G2V1B

#### Connectors and Other Parts

#### PCB (1): Control PCB

1) S20	Connector for electronic expansion valve coil
2) S40	Connector for overload protector
3) S70	Connector for fan motor
4) S80	Connector for four way valve coil
5) S90	Connector for thermistors (outdoor temperature, outdoor heat exchanger, discharge pipe)
6) U, V, W	Connector for compressor
7) HL1, HN1, S	Connector for terminal board
8) E (E2)	Connector for earth
9) HR1, HR2	Connector for reactor
10) LED A	LED for service monitor (green)
11) FU1, FU2	Fuse (3.15 A, 250 V)
12) FU3	Fuse (30 A, 250 V)
13) J5	Jumper for improvement of defrost performance * Refer to page 270 for detail.
14) V1, V3, V4	Varistor

PCB Detail

PCB (1): Control PCB

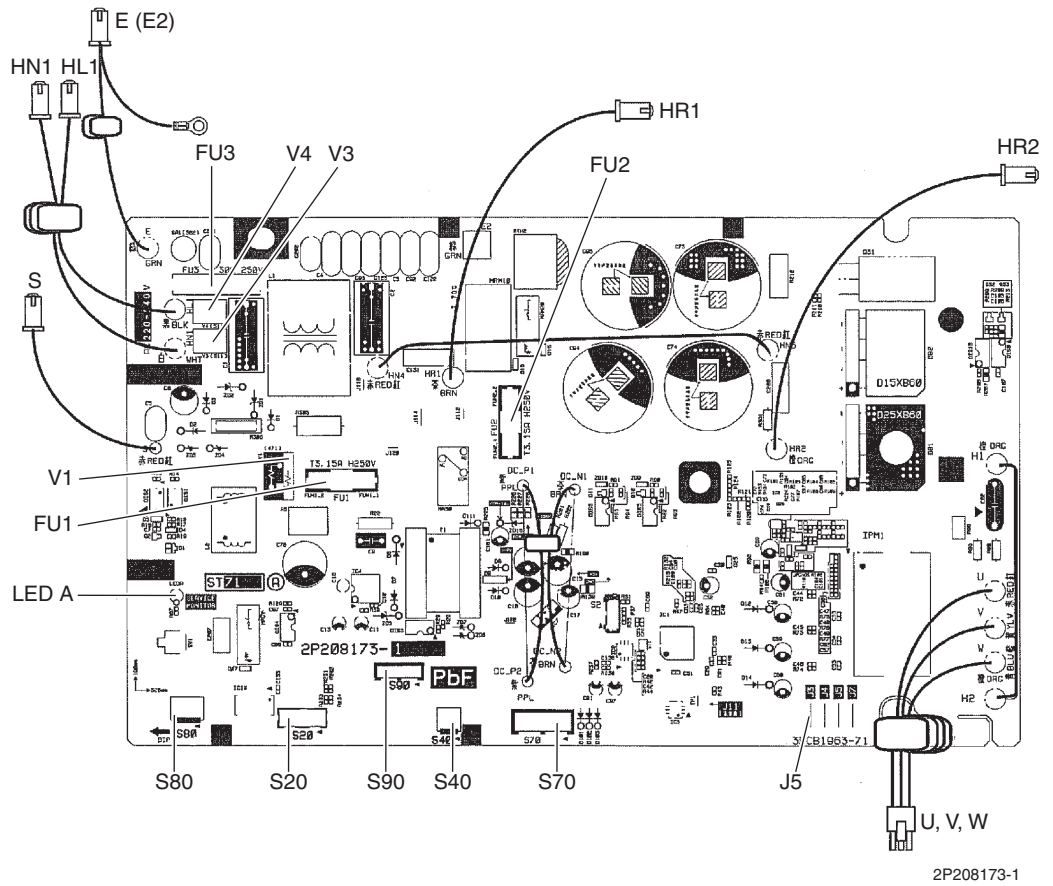

## 1.2.4 RXL35G2V1B

### Connectors and Other Parts

#### PCB (1): Main PCB

1) S10	Connector for terminal board (indoor-outdoor transmission)
2) S20	Connector for electronic expansion valve coil
3) S40	Connector for overload protector
4) S51, S101	Connector for service monitor PCB
5) S70	Connector for fan motor
6) S80	Connector for four way valve coil
7) S90	Connector for thermistors (outdoor temperature, outdoor heat exchanger, discharge pipe)
8) AC1, AC2	Connector for terminal board (power supply)
9) E1, E2	Connector for earth
10) HR1, HR2	Connector for reactor
11) U, V, W	Connector for compressor
12) FU1	Fuse (30 A, 250 V)
13) FU2, FU3	Fuse (3.15 A, 250 V)
14) V2, V3, V5 V6, V11	Varistor

#### PCB (2): Service Monitor PCB

1) S52, S102	Connector for main PCB
2) LED A	LED for service monitor (green)
3) SW1	Forced operation ON/OFF switch
4) SW4-C	Switch for improvement of defrost performance * Refer to page 270 for detail.

PCB Detail

PCB (1): Main PCB

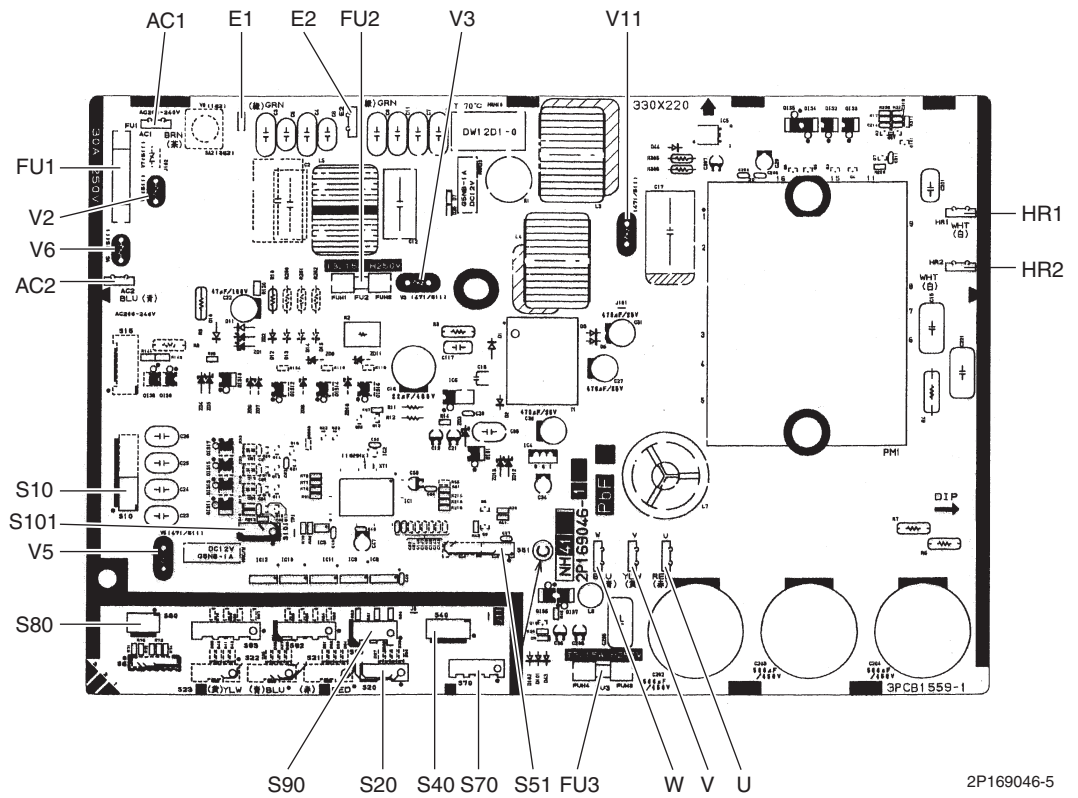

PCB (2): Service Monitor PCB

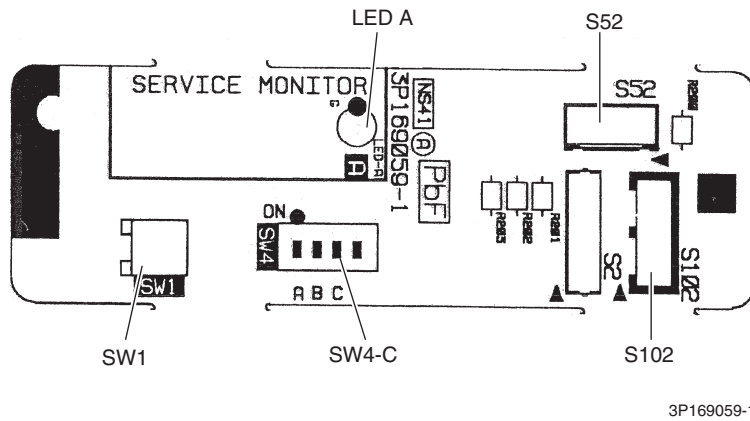



# Part 4

## Function and Control

1. Main Functions .....	20
1.1 Frequency Principle.....	20
1.2 Airflow Direction Control.....	22
1.3 Fan Speed Control for Indoor Units.....	23
1.4 Program Dry Operation .....	24
1.5 Automatic Operation.....	25
1.6 Thermostat Control.....	26
1.7 NIGHT SET Mode .....	27
1.8 ECONO Operation .....	28
1.9 2-Area INTELLIGENT EYE Operation .....	29
1.10 Inverter POWERFUL Operation .....	31
1.11 Other Functions.....	32
2. Function of Thermistor .....	33
3. Control Specification .....	34
3.1 Mode Hierarchy .....	34
3.2 Frequency Control.....	35
3.3 Controls at Mode Changing / Start-up.....	37
3.4 Discharge Pipe Temperature Control.....	39
3.5 Input Current Control.....	40
3.6 Freeze-up Protection Control .....	41
3.7 Heating Peak-cut Control .....	41
3.8 Outdoor Fan Control.....	42
3.9 Liquid Compression Protection Function.....	42
3.10 Defrost Control .....	43
3.11 Electronic Expansion Valve Control .....	44
3.12 Malfunctions .....	47
3.13 Forced Operation Mode .....	48
3.14 Standby Electricity Saving.....	48

# 1. Main Functions



**Note:** The definitions of temperatures are classified as following.

- ◆ Room temperature: temperature of the lower part of the room
- ◆ Set temperature: temperature set by remote control
- ◆ Room thermistor temperature: temperature detected by room temperature thermistor
- ◆ Target temperature: temperature determined by microcomputer

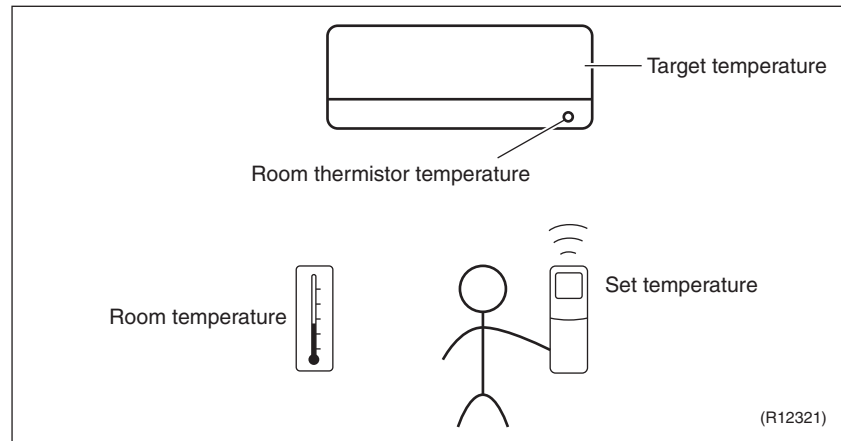

## 1.1 Frequency Principle

### Main Control Parameters

The compressor is frequency-controlled during normal operation. The target frequency is set by the following 2 parameters coming from the operating indoor unit:

- The load condition of the operating indoor unit
- The difference between the room thermistor temperature and the target temperature

### Additional Control Parameters

The target frequency is adapted by additional parameters in the following cases:

- Frequency restrictions
- Initial settings
- Forced cooling operation

### Inverter Principle

To regulate the capacity, a frequency control is needed. The inverter makes it possible to vary the rotation speed of the compressor. The following table explains the conversion principle:

Phase	Description
1	The supplied AC power source is converted into the DC power source for the present.
2	The DC power source is reconverted into the three phase AC power source with variable frequency. <ul style="list-style-type: none"> <li>■ When the frequency increases, the rotation speed of the compressor increases resulting in an increased refrigerant circulation. This leads to a higher amount of the heat exchange per unit.</li> <li>■ When the frequency decreases, the rotation speed of the compressor decreases resulting in a decreased refrigerant circulation. This leads to a lower amount of the heat exchange per unit.</li> </ul>

## Drawing of Inverter

The following drawing shows a schematic view of the inverter principle:

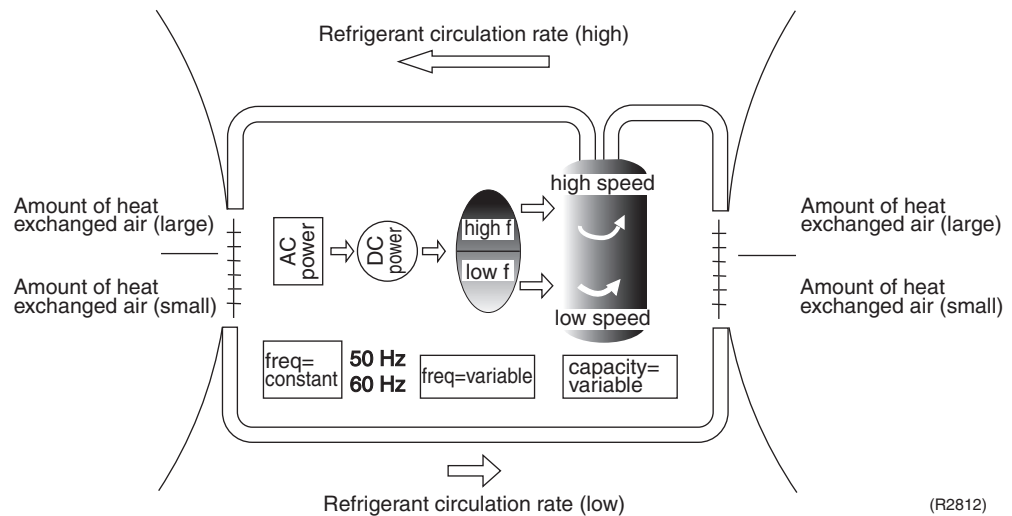

## Inverter Features

The inverter provides the following features:

- The regulating capacity can be changed according to the changes in the outdoor temperature and cooling / heating load.
- Quick heating and quick cooling  
The compressor rotational speed is increased when starting the heating (or cooling). This enables to reach the set temperature quickly.
- Even during extreme cold weather, the high capacity is achieved. It is maintained even when the outdoor temperature is 2°C.
- Comfortable air conditioning  
A fine adjustment is integrated to keep the room temperature constant.
- Energy saving heating and cooling  
Once the set temperature is reached, the energy saving operation enables to maintain the room temperature at low power.

## Frequency Limits

The following functions regulate the minimum and maximum frequency:

Frequency	Functions
Low	<ul style="list-style-type: none"> <li>■ Four way valve operation compensation. Refer to page 38.</li> </ul>
High	<ul style="list-style-type: none"> <li>■ Compressor protection function. Refer to page 38.</li> <li>■ Discharge pipe temperature control. Refer to page 39.</li> <li>■ Input current control. Refer to page 40.</li> <li>■ Freeze-up protection control. Refer to page 41.</li> <li>■ Heating peak-cut control. Refer to page 41.</li> <li>■ Defrost control. Refer to page 43.</li> </ul>

## Forced Cooling Operation

Refer to "Forced operation mode" on page 48 for detail.

# 1.2 Airflow Direction Control

## Power-Airflow Dual Flaps

The large flaps send a large volume of air downwards to the floor and provide an optimum control in cooling, dry, and heating mode.

### Cooling / Dry Mode

During cooling or dry mode, the flap retracts into the indoor unit. Then, cool air can be blown far and pervaded all over the room.

### Heating Mode

During heating mode, the large flap directs airflow downwards to spread the warm air to the entire room.

## Wide-Angle Louvers

The louvers, made of elastic synthetic resin, provide a wide range of airflow that guarantees a comfortable air distribution.

## Auto-Swing

The following table explains the auto swing process for cooling, dry, heating, and fan :

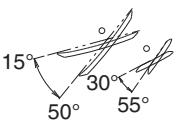
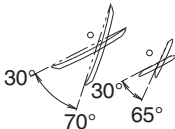
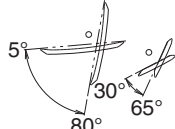
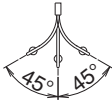
Vertical Swing (up and down)			Horizontal Swing (right and left)
Cooling / Dry	Heating	Fan	
 <p>(R12182)</p>	 <p>(R11402)</p>	 <p>(R11403)</p>	 <p>(R11404)</p>

## 3-D Airflow

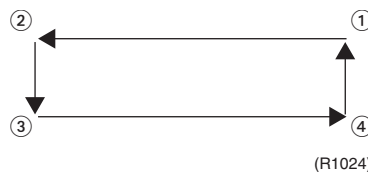

Alternative repetition of vertical and horizontal swing motions enables uniform air-conditioning of the entire room. This function is effective for starting the air conditioner.

When the horizontal swing and vertical swing are both set to auto mode, the airflow becomes 3-D airflow and the horizontal swing and vertical swing motions are alternated. The order of swing motion is such that it turns counterclockwise, starting from the right upper point as viewed from the front side of the indoor unit.



## COMFORT AIRFLOW Operation

The vertical swing flap is controlled not to blow the air directly on the person in the room.

Cooling	Heating
 <p>(R11665)</p>	 <p>(R12181)</p>

## 1.3 Fan Speed Control for Indoor Units

### Outline

Phase control and fan speed control contains 9 steps: LLL, LL, SL, L, ML, M, MH, H, and HH. The airflow rate can be automatically controlled depending on the difference between the room thermistor temperature and the target temperature. This is done through phase control and Hall IC control.



For more information about Hall IC, refer to the troubleshooting for fan motor on page 79.

### Automatic Fan Speed Control

In automatic fan speed operation, the step "SL" is not available.

Step	Cooling	Heating
LLL	 (R6833)	
LL		
L		
ML		
M		
MH		
H		
HH (POWERFUL)		

↔ = The airflow rate is automatically controlled within this range when the FAN setting button is set to automatic.

#### <Cooling>

The following drawing explains the principle of fan speed control for cooling.

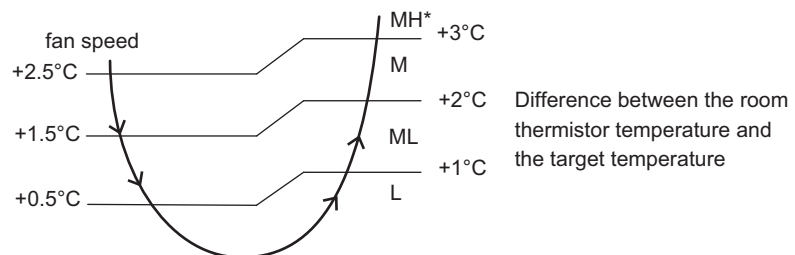

(R12317)

\*In automatic fan speed operation, upper limit is at M tap in 30 minutes from the operation start.

#### <Heating>

On heating mode, the fan speed is regulated according to the indoor heat exchanger temperature and the difference between the room thermistor temperature and the target temperature.



#### Note:

1. During POWERFUL operation, fan rotates at H tap + 50 rpm.
2. Fan stops during defrost operation.
3. In time of thermostat OFF, the fan rotates at the following speed.  
Cooling: The fan keeps rotating at the set tap.  
Heating: The fan stops.

### COMFORT AIRFLOW Operation

- The fan speed is controlled automatically within the following steps.  
Cooling: L tap – MH tap (same as AUTOMATIC)  
Heating: ML tap – Equivalent to ML tap – MH tap
- The latest command has the priority between POWERFUL and COMFORT AIRFLOW.

## 1.4 Program Dry Operation

### Outline

Program dry operation removes humidity while preventing the room temperature from lowering. Since the microcomputer controls both the temperature and airflow rate, the temperature adjustment and fan adjustment buttons are inoperable in this mode.

### Detail

The microcomputer automatically sets the temperature and airflow rate. The difference between the room thermistor temperature at start-up and the target temperature is divided into two zones. Then, the unit operates in the dry mode with an appropriate capacity for each zone to maintain the temperature and humidity at a comfortable level.

Room thermistor temperature at start-up	Target temperature X	Thermostat OFF point Y	Thermostat ON point Z
24°C or more	Room thermistor temperature at start-up	X - 2.5°C	X - 0.5°C or Y + 0.5°C (zone B) continues for 10 min.
23.5°C ∴ 18°C		X - 2.0°C	X - 0.5°C or Y + 0.5°C (zone B) continues for 10 min.
17.5°C ∴	18°C	X - 2.0°C	X - 0.5°C = 17.5°C or Y + 0.5°C (zone B) continues for 10 min.

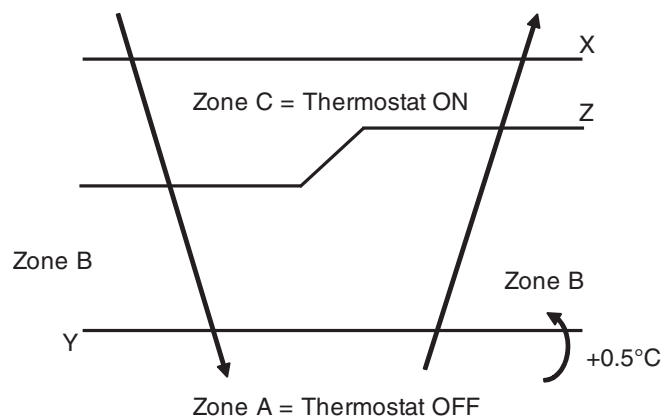

(R11581)

## 1.5 Automatic Operation

### Outline

#### Automatic Cooling / Heating Function

When the AUTO mode is selected with the remote control, the microcomputer automatically determines the operation mode as cooling or heating according to the room temperature and the set temperature at start-up, and automatically operates in that mode.

The unit automatically switches the operation mode to maintain the room temperature at the set temperature.

### Detail

Ts: set temperature (set by remote control)

Tt: target temperature (determined by microcomputer)

Tr: room thermistor temperature (detected by room temperature thermistor)

C: correction value

- The set temperature (Ts) determines the target temperature (Tt).  
(Ts = 18 ~ 30°C).
- The target temperature (Tt) is calculated as;  
 $Tt = Ts + C$   
where C is the correction value.  
C = 0°C
- Thermostat ON/OFF point and mode switching point are as follows.  
Tr means the room thermistor temperature.
  - Heating → Cooling switching point:  
 $Tr \geq Tt + 2.5^\circ\text{C}$
  - Cooling → Heating switching point:  
 $Tr < Tt - 2.5^\circ\text{C}$
  - Thermostat ON/OFF point is the same as the ON/OFF point of cooling or heating operation.
- During initial operation
  - $Tr \geq Ts$ : Cooling operation
  - $Tr < Ts$ : Heating operation

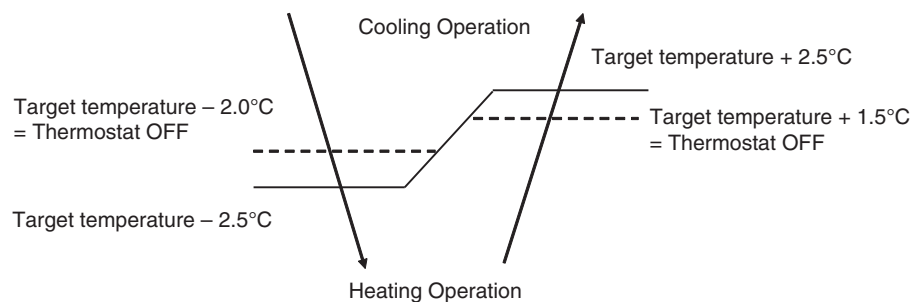

(R11893)

Ex: When the target temperature is 25°C

Cooling → 23°C: Thermostat OFF → 22°C: Switch to heating

Heating → 26.5°C: Thermostat OFF → 27.5°C: Switch to cooling

## 1.6 Thermostat Control

Thermostat control is based on the difference between the room thermistor temperature and the target temperature.

### Thermostat OFF Condition

- ◆ The temperature difference is in the zone A.

### Thermostat ON Condition

- ◆ The temperature difference returns to the zone C after being in the zone A.
- ◆ The system resumes from defrost control in any zones except A.
- ◆ The operation turns on in any zones except A.
- ◆ The monitoring time has passed while the temperature difference is in the zone B.  
(Cooling / Dry : 10 minutes, Heating : 10 seconds)

### Cooling / Dry

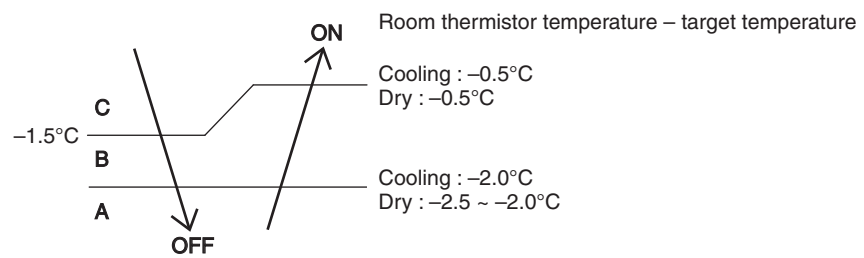

### Heating

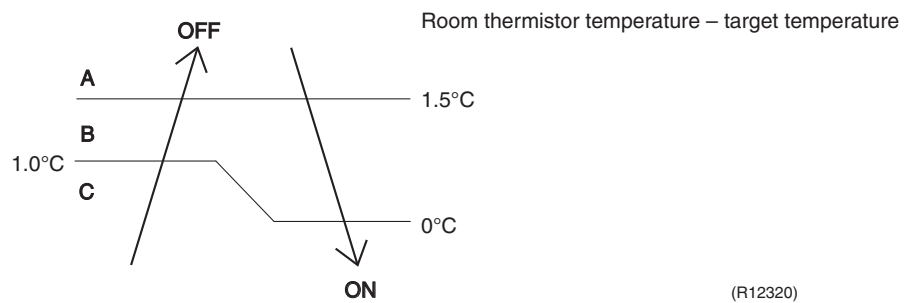



## 1.7 NIGHT SET Mode

### Outline

When the OFF timer is set, the NIGHT SET Mode is automatically activated. The NIGHT SET Mode keeps the airflow rate setting.

### Detail

The NIGHT SET Mode continues operation at the target temperature for the first one hour, then automatically raises the target temperature slightly in the case of cooling, or lowers it slightly in the case of heating. This prevents excessive cooling in summer and excessive heating in winter to ensure comfortable sleeping conditions, and also conserves electricity.

#### Cooling

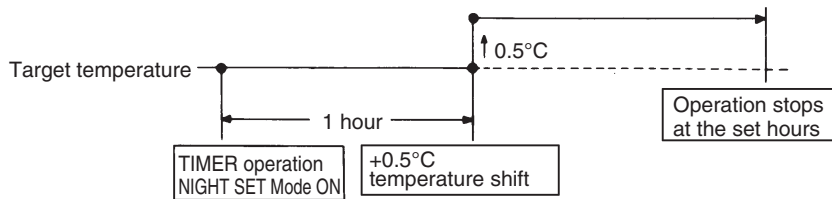

(R10870)

#### Heating

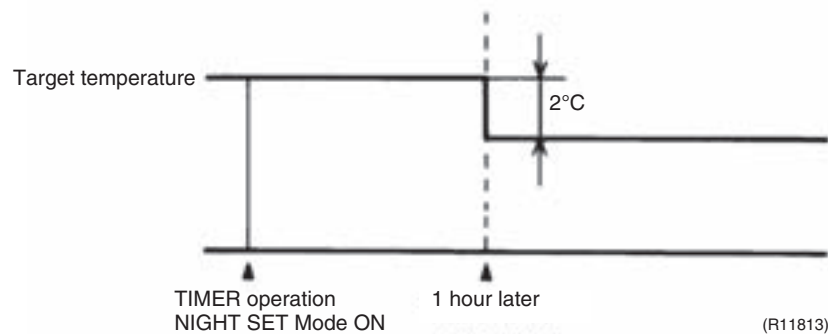

(R11813)

## 1.8 ECONO Operation

### Outline

The "ECONO operation" reduces the maximum operating current and the power consumption. This operation is particularly convenient for energy-saving-oriented users. It is also a major bonus for those whose breaker capacities do not allow the use of multiple electrical devices and air conditioners.

It is easily activated from the infrared remote control by pushing the ECONO button.

- When this function is activated, the maximum capacity also decreases.
- The remote control can send the ECONO command when the unit is in COOL, HEAT, DRY, or AUTO operation. This function can only be set when the unit is running. Pressing the ON/OFF button on the remote control cancels the function.
- This function and POWERFUL operation cannot be used at the same time. The latest command has the priority.

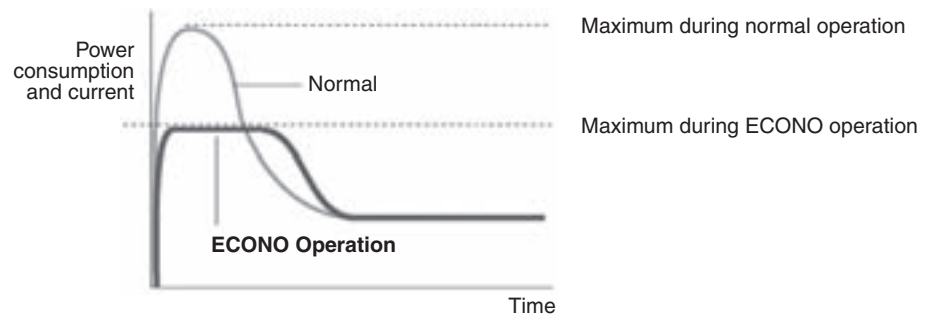

(R9288)

### Detail

- When the ECONO command is valid, the input current has upper limit. (Refer to "Input current control" on page 40.)

## 1.9 2-Area INTELLIGENT EYE Operation

### Outline

The following functions can be performed by a motion sensor (INTELLIGENT EYE).

1. Reduction of the capacity when there is nobody in the room in order to save electricity (energy saving operation)
2. Dividing the room into plural areas and detecting existence of humans in each area.  
Moving the airflow direction to the area with no human automatically to avoid direct airflow on humans.

### Detail

#### 1. Detection method of INTELLIGENT EYE

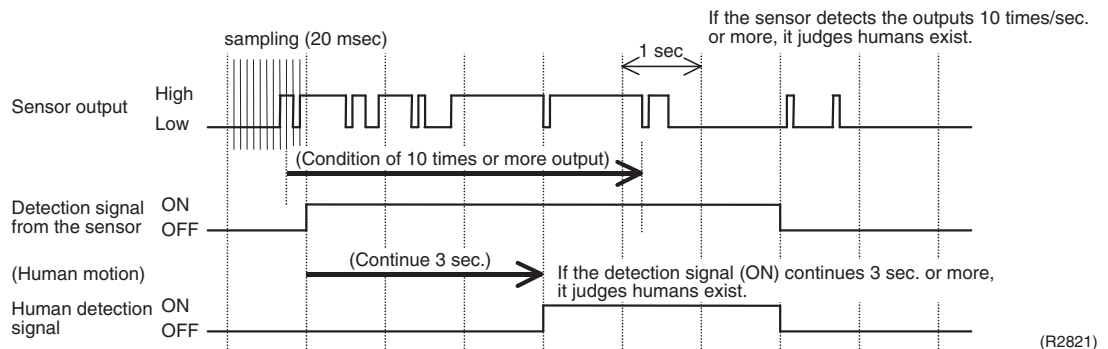

- This sensor detects human motion by receiving infrared rays and displays the pulse wave output.
- The microcomputer in the indoor unit carries out a sampling every 20 msec. and if it detects 10 cycles of the wave in one second in total (corresponding to  $20 \text{ msec.} \times 10 = 200 \text{ msec.}$ ), and when the ON signal continues 3 sec., it judges human is in the room as the motion signal is ON
- 2-area INTELLIGENT EYE sensor is divided into 2 areas and detects humans in each area.
- Image of 2-area INTELLIGENT EYE

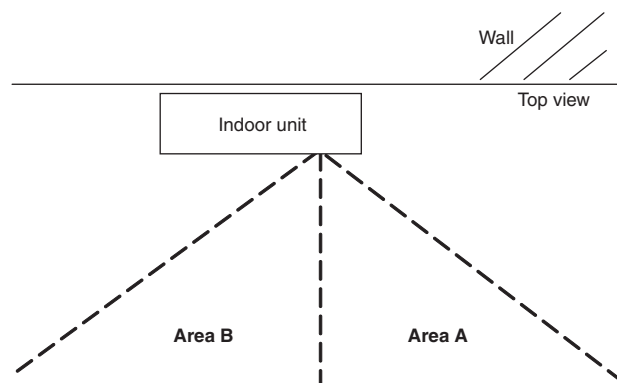

· A microcomputer judges human existence by the sensor signal from each area A and B.

(R12276)

## 2. Motions (for example: in cooling)

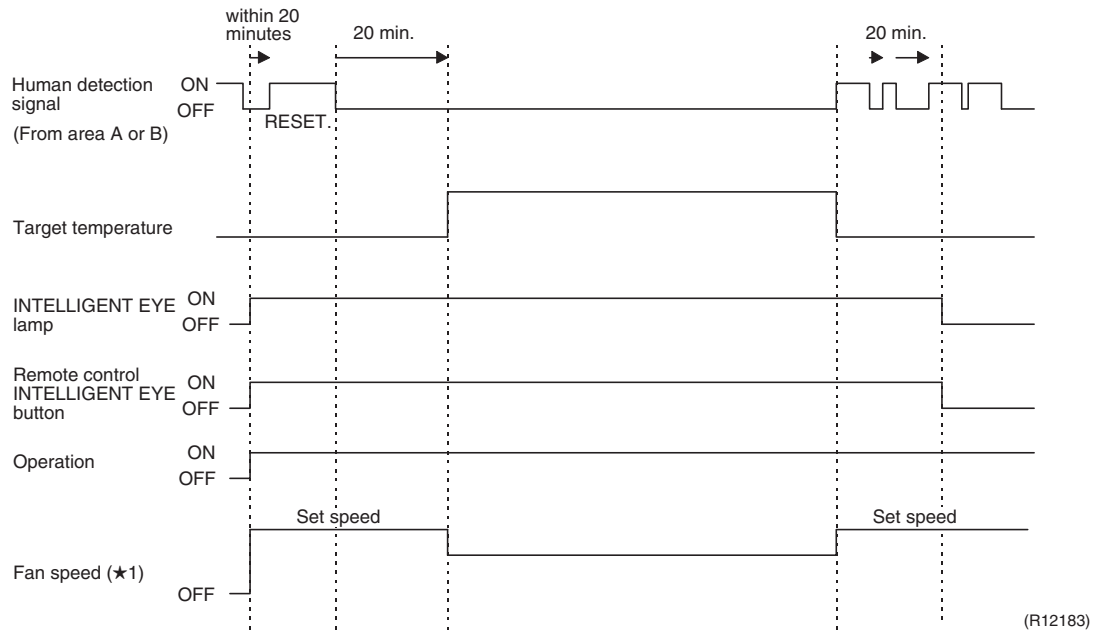

- When the microcomputer does not have a signal from the sensor in 20 minutes, it judges that nobody is in the room and operates the unit in temperature shifted from the target temperature. (Cooling / Dry : 2°C higher, Heating : 2°C lower, Auto : according to the operation mode at that time.)

★1 In case of FAN mode, the fan speed reduces by 60 rpm.

## 3. Airflow direction in 2-area INTELLIGENT EYE operation

- Detection method: The opposite area of detected area is set as the target direction.

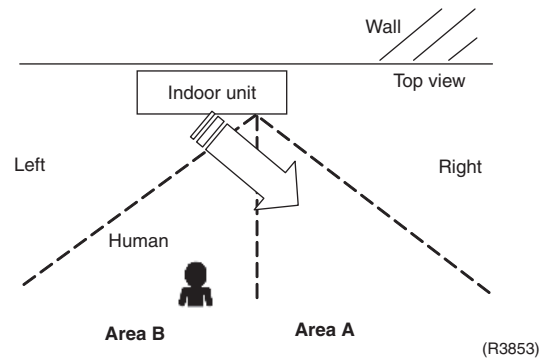

1. Detection signal ON in both area A and B: Shift the airflow direction to area B (left side)
2. Detection signal ON in area A: Shift the airflow direction to area B (left side)
3. Detection signal ON in area B: Shift the airflow direction to area A (right side)
4. Detection signal OFF in both area A and B: No change

\* When the detection signal is OFF for 20 minutes in both area A and B, the unit starts energy saving operation.

## Others

- For dry operation, you cannot set the temperature with remote control, but internally the target temperature is shifted by 2°C.

## 1.10 Inverter POWERFUL Operation

### Outline

In order to exploit the cooling and heating capacity to full extent, operate the air conditioner by increasing the indoor fan rotating speed and the compressor frequency.

### Detail

When POWERFUL button is pressed, the fan speed and target temperature are converted to the following states for 20 minutes.

Operation mode	Fan speed	Target temperature
COOL	H tap + 50 rpm	18°C
DRY	Dry rotating speed + 50 rpm	Lowered by 2.5°C
HEAT	H tap + 50 rpm	31°C
FAN	H tap + 50 rpm	—
AUTO	Same as cooling / heating in POWERFUL operation	The target temperature is kept unchanged.

Ex.) : POWERFUL operation in cooling mode.

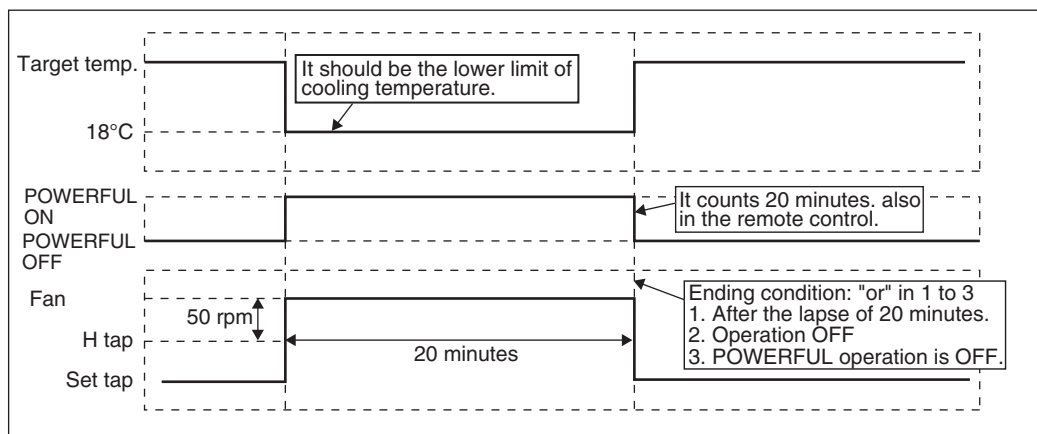

(R7096)

## 1.11 Other Functions

### 1.11.1 Hot-Start Function

In order to prevent the cold air blast that normally comes when heating operation is started, the temperature of the indoor heat exchanger is detected, and either the airflow is stopped or is made very weak thereby carrying out comfortable heating of the room.

\*The cold air blast is also prevented using a similar control when the defrosting operation is started or when the thermostat is turned ON.

### 1.11.2 Signal Receiving Sign

When the indoor unit receives a signal from the remote control, the unit emits a signal receiving sound.

### 1.11.3 Indoor Unit ON/OFF Button

An ON/OFF button is provided on the display of the unit.

- Press this button once to start operation. Press once again to stop it.
- This button is useful when the remote control is missing or the battery has run out.
- The operation mode refers to the following table.

Mode	Temperature setting	Airflow rate
AUTO	25°C	Automatic

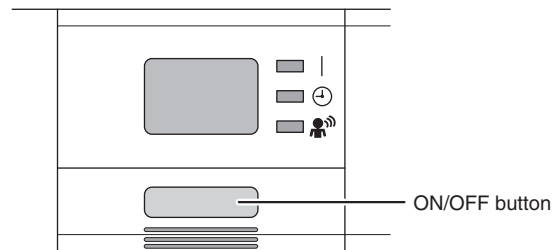

(R8302)

#### <Forced operation mode>

Forced operation mode can be started by pressing the ON/OFF button for 5 to 9 seconds while the unit is not operating.

Refer to "Forced operation mode" on page 48 for detail.



**Note:** When the ON/OFF button is pressed for 10 seconds or more, the forced operation is stopped.

### 1.11.4 Titanium Apatite Photocatalytic Air-Purifying Filter

This filter combines the Air-Purifying Filter and Titanium Apatite Photocatalytic Deodorizing Filter as a single highly effective filter. The filter traps microscopic particles, decompose odors and even deactivates bacteria and viruses. It lasts for 3 years without replacement if washed about once every 6 months.

### 1.11.5 Auto-restart Function

Even if a power failure (including one for just a moment) occurs during the operation, the operation restarts automatically when the power is restored in the same condition as before the power failure.



**Note:** It takes 3 minutes to restart the operation because the 3-minute standby function is activated.

### 1.11.6 WEEKLY TIMER Operation

Up to 4 timer settings can be saved for each day of the week (up to 28 settings in total). Those 3 items of "ON/OFF", "temperature" and "time" can be set.



Refer to "WEEKLY TIMER Operation" on page 63 for detail.

## 2. Function of Thermistor

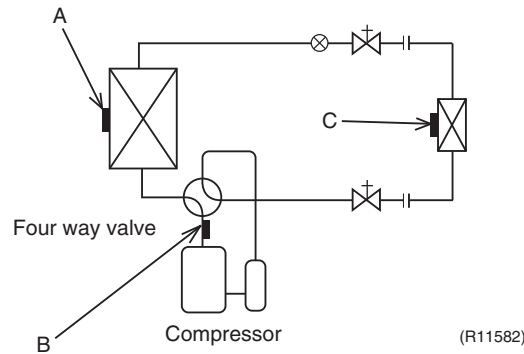

### A Outdoor Heat Exchanger Thermistor

1. The outdoor heat exchanger thermistor is used for controlling target discharge pipe temperature. The system sets the target discharge pipe temperature according to the outdoor and indoor heat exchanger temperature, and controls the electronic expansion valve opening so that the target discharge pipe temperature can be obtained.
2. In cooling operation, the outdoor heat exchanger thermistor is used for detecting disconnection of the discharge pipe thermistor. When the discharge pipe temperature becomes lower than the outdoor heat exchanger temperature, the discharge pipe thermistor is judged as disconnected.
3. In cooling operation, the outdoor heat exchanger thermistor is used for high pressure protection.

### B Discharge Pipe Thermistor

1. The discharge pipe thermistor is used for controlling discharge pipe temperature. If the discharge pipe temperature (used in place of the inner temperature of the compressor) rises abnormally, the operating frequency becomes lower or the operation halts.
2. The discharge pipe thermistor is used for detecting disconnection of the discharge pipe thermistor.

### C Indoor Heat Exchanger Thermistor

1. The indoor heat exchanger thermistor is used for controlling target discharge pipe temperature. The system sets the target discharge pipe temperature according to the outdoor and indoor heat exchanger temperature, and controls the electronic expansion valve opening so that the target discharge pipe temperature can be obtained.
2. In cooling operation, the indoor heat exchanger thermistor is used for freeze-up protection control. If the indoor heat exchanger temperature drops abnormally, the operating frequency becomes lower or the operation halts.
3. In heating operation, the indoor heat exchanger thermistor is used for detecting disconnection of the discharge pipe thermistor. When the discharge pipe temperature becomes lower than the indoor heat exchanger temperature, the discharge pipe thermistor is judged as disconnected.

## 3. Control Specification

### 3.1 Mode Hierarchy

#### Outline

There are two modes; the one is the normal operation mode and the other is the forced operation mode for installation and providing service.

#### Detail

There are following modes; stop, cooling (includes drying), heating (include defrosting)

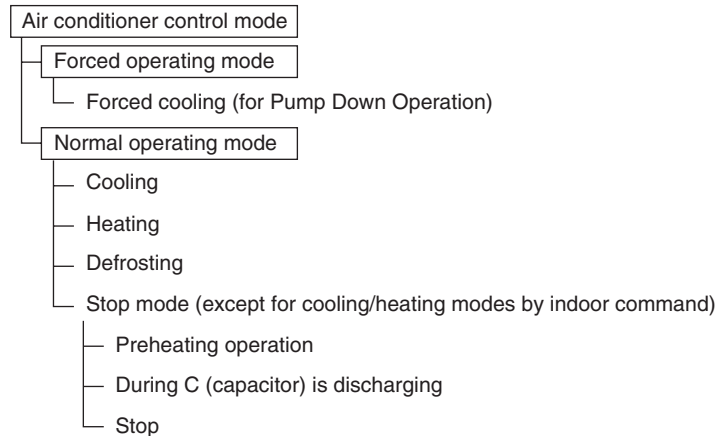

(R2829)



**Note:** Unless specified otherwise, an indoor dry operation command is regarded as cooling operation.



## 3.2 Frequency Control

### Outline

Frequency is determined according to the difference between the room thermistor temperature and the target temperature.

The function is explained as follows.

1. How to determine frequency
2. Frequency command from the indoor unit (Difference between the room thermistor temperature and the target temperature)
3. Frequency initial setting
4. PI control

When the shift of the frequency is less than zero ( $\Delta F < 0$ ) by PI control, the target frequency is used as the command frequency.

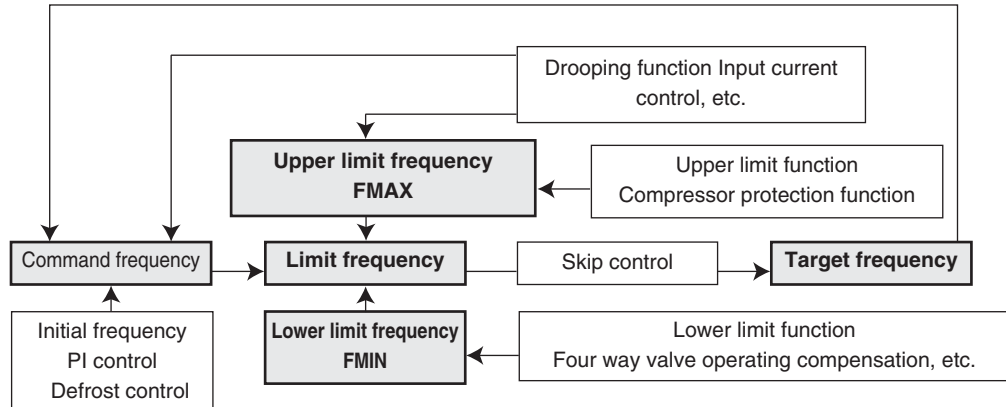

(R2831)

### Detail

#### How to Determine Frequency

The compressor's frequency is determined by taking the following steps.

##### 1. Determine command frequency

- ◆ Command frequency is determined in the following order of priority.
  1. Limiting defrost control time
  2. Forced cooling
  3. Indoor frequency command

##### 2. Determine upper limit frequency

- ◆ The minimum value is set as an upper limit frequency among the frequency upper limits of the following functions:  
Compressor protection, input current, discharge pipe temperature, heating peak-cut, freeze-up protection, defrost.

##### 3. Determine lower limit frequency

- ◆ The maximum value is set as a lower limit frequency among the frequency lower limits of the following functions:  
Four way valve operation compensation, draft prevention, pressure difference upkeep.

##### 4. Determine prohibited frequency

- ◆ There is a certain prohibited frequency such as a power supply frequency.

**Indoor Frequency Command ( $\Delta D$  signal)**

The difference between the room thermistor temperature and the target temperature is taken as the " $\Delta D$  signal" and is used for frequency command.

Temperature difference	$\Delta D$ signal	Temperature difference	$\Delta D$ signal	Temperature difference	$\Delta D$ signal	Temperature difference	$\Delta D$ signal
-2.0	*Th OFF	0	4	2.0	8	4.0	C
-1.5	1	0.5	5	2.5	9	4.5	D
-1.0	2	1.0	6	3.0	A	5.0	E
-0.5	3	1.5	7	3.5	B	5.5	F

\*Th OFF = Thermostat OFF

**Frequency Initial Setting****<Outline>**

When starting the compressor, the frequency is initialized according to the  $\Delta D$  value and the Q value of the indoor unit.

Q value: Indoor unit output determined from indoor unit volume, airflow rate and other factors.

**PI Control (Determine Frequency Up / Down by  $\Delta D$  Signal)****1. P control**

The  $\Delta D$  value is calculated in each sampling time (15 ~ 20 seconds), and the frequency is adjusted according to its difference from the frequency previously calculated.

**2. I control**

If the operating frequency does not change for more than a certain fixed time, the frequency is adjusted according to the  $\Delta D$  value.

When the  $\Delta D$  value is small, the frequency is lowered.

When the  $\Delta D$  value is large, the frequency is increased.

**3. Frequency management when other controls are functioning**

- ◆ When frequency is drooping;  
Frequency management is carried out only when the frequency droops.
- ◆ For limiting lower limit  
Frequency management is carried out only when the frequency rises.

**4. Upper and lower limit of frequency by PI control**

The frequency upper and lower limits are set according to the command on indoor unit.

When the indoor or outdoor unit quiet operation command comes from the indoor unit, the upper limit frequency is lowered than the usual setting.

## 3.3 Controls at Mode Changing / Start-up

### 3.3.1 Preheating Operation

#### Outline

The inverter operation in open phase starts with the conditions of the preheating command from the indoor unit, the outdoor temperature, and the discharge pipe temperature.

#### Detail

##### ■ RXL20/25G2V1B

##### ON Condition

- ◆ When the discharge pipe temperature is below 10°C, the inverter operation in open phase starts.

##### OFF Condition

- ◆ When the discharge pipe temperature is higher than 12°C, the inverter operation in open phase stops.

##### ■ RXL20G2V1B9

Outdoor temperature  $\geq 7^{\circ}\text{C}$  → Control A

Outdoor temperature  $< 7^{\circ}\text{C}$  → Control B

##### Control A

- ◆ ON condition  
Discharge pipe temperature  $< 10^{\circ}\text{C}$
- ◆ OFF condition  
Discharge pipe temperature  $> 12^{\circ}\text{C}$   
Radiation fin temperature  $\geq 90^{\circ}\text{C}$

##### Control B

- ◆ ON condition  
Discharge pipe temperature  $< 20^{\circ}\text{C}$
- ◆ OFF condition  
Discharge pipe temperature  $> 22^{\circ}\text{C}$   
Radiation fin temperature  $\geq 90^{\circ}\text{C}$

##### ■ RXL35G2V1B

Outdoor temperature  $\geq 10^{\circ}\text{C}$  → Control A

Outdoor temperature  $< 10^{\circ}\text{C}$  → Control B

##### Control A

- ◆ ON condition  
Discharge pipe temperature  $< 6^{\circ}\text{C}$
- ◆ OFF condition  
Discharge pipe temperature  $> 8^{\circ}\text{C}$   
Radiation fin temperature  $\geq 90^{\circ}\text{C}$

##### Control B

- ◆ ON condition  
Discharge pipe temperature  $< 10.5^{\circ}\text{C}$
- ◆ OFF condition  
Discharge pipe temperature  $> 12^{\circ}\text{C}$   
Radiation fin temperature  $\geq 90^{\circ}\text{C}$

### 3.3.2 Four Way Valve Switching

#### Outline

In heating operation, current is conducted, and in cooling and defrosting, current is not conducted. In order to eliminate the switching sound when the heating is stopped, as the four way valve coil switches from ON to OFF, the OFF delay switch of the four way valve is carried out after the operation stopped.

#### Detail

##### OFF delay switch of four way valve:

The four way valve coil is energized for 150 ~ 160 seconds after the operation is stopped.

### 3.3.3 Four Way Valve Operation Compensation

#### Outline

At the beginning of the operation as the four way valve is switched, the differential pressure to activate the four way valve is acquired by having output frequency which is more than a certain fixed frequency, for a certain fixed time.

#### Detail

##### Starting Conditions

1. When starting compressor for heating.
  2. When the operation mode changes to cooling from heating.
  3. When starting compressor for defrosting or resetting.
  4. When starting compressor for the first time after the reset with the power is ON.
  5. When starting compressor for heating next to the suspension of defrosting.
  6. When starting compressor next to the fault of switching over cooling / heating.
- Set the lower limit frequency  $\Delta$  Hz for  $\text{B}$  seconds with any conditions 1 through 6 above.

	20 class		25 class		35 class	
	Cooling	Heating	Cooling	Heating	Cooling	Heating
$\Delta$ (Hz)	68	66	48	54	48	48
$\text{B}$ (seconds)	45		60		70	

### 3.3.4 3-minute Standby

Turning on the compressor is prohibited for 3 minutes after turning it off.  
(Except when defrosting.)

### 3.3.5 Compressor Protection Function

When turning the compressor from OFF to ON, the upper limit of frequency is set as follows.  
(The function is not activated when defrosting.)

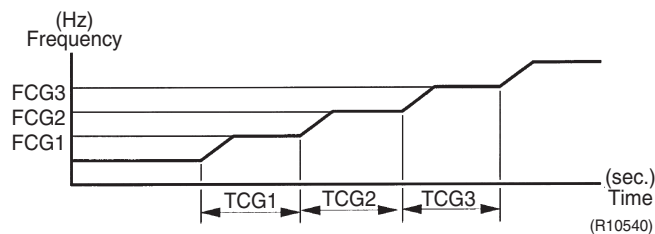

	20 class	25 class	35 class	Unit
FCG 1	48	55	55	Hz
FCG 2	64	70	70	
FCG 3	88	85	85	
TCG 1	240	150	120	seconds
TCG 2	360	180	200	
TCG 3	180	300	470	

## 3.4 Discharge Pipe Temperature Control

### Outline

The discharge pipe temperature is used as the internal temperature of the compressor. If the discharge pipe temperature rises above a certain level, the upper limit of frequency is set to keep this temperature from going up further.

### Detail

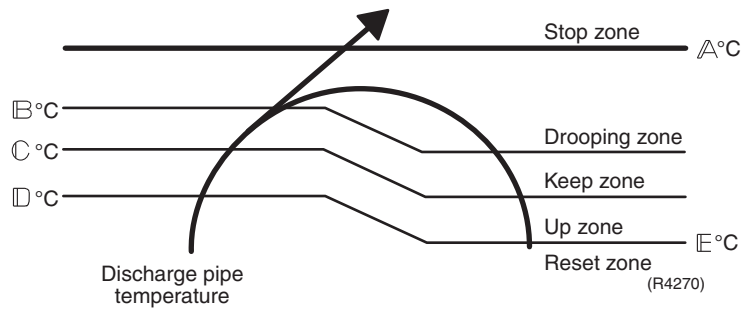

Zone	Control
Stop zone	When the temperature reaches the stop zone, the compressor stops.
Drooping zone	The timer starts, and the frequency is drooping.
Keep zone	The upper limit of frequency is kept.
Up zone	The upper limit of frequency is increased.
Reset zone	The upper limit of frequency is canceled.

	20 class	25 class	35 class
A (°C)	110	110	110
B (°C)	105	103	103
C (°C)	101	102	101.5
D (°C)	99	100	100
E (°C)	97	95	95

## 3.5 Input Current Control

### Outline

The microcomputer calculates the input current during the compressor is running, and sets the frequency upper limit from the input current.

In case of heat pump model, this control which is the upper limit control of the frequency takes priority to the lower limit of control of four way valve operation compensation.

### Detail

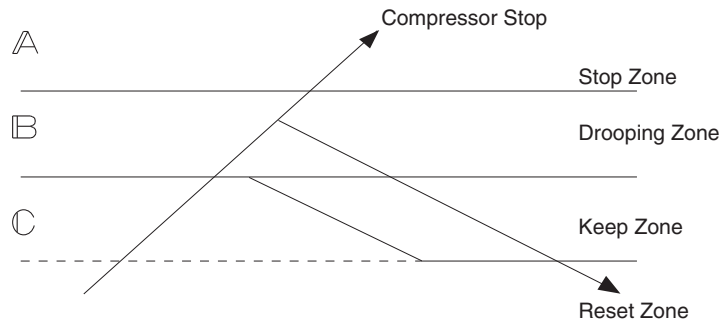

(R4304)

#### Frequency control in each zone

##### Stop zone

- After 2.5 seconds in this zone, the compressor is stopped.

##### Drooping zone

- The upper limit of the compressor frequency is defined as operation frequency – 2 Hz.
- After this, the output frequency is pulled down by 2 Hz every second until it reaches the keep zone.

##### Keep zone

- The present maximum frequency goes on.

##### Reset zone

- Limit of the frequency is canceled.

#### ■ RXL20-35G2V1B

		20 class		25 class		35 class	
		Cooling	Heating	Cooling	Heating	Cooling	Heating
A (A)		9.25		14.25		20.0	
B (A)	Normal mode	7.25	8.25	10.0	10.5	10.0	15.0
	ECONO mode	3.25		4.5		7.0	10.5
C (A)	Normal mode	6.5	7.5	9.0	9.5	9.0	14.0
	ECONO mode	2.5		3.5		6.0	9.5

#### ■ RXL20G2V1B9

		Cooling	Heating
A (A)		9.25	
B (A)	Normal mode	8.25	
	ECONO mode	3.25	
C (A)	Normal mode	7.5	
	ECONO mode	2.5	

#### Limitation of current drooping and stop value according to the outdoor temperature

- The current droops when outdoor temperature becomes higher than a certain level (depending on the model).

## 3.6 Freeze-up Protection Control

### Outline

During cooling operation, the signal sent from the indoor unit controls the operating frequency limitation and prevents freezing of the indoor heat exchanger. (The signal from the indoor unit is divided into zones.)

### Detail

The operating frequency limitation is judged with the indoor heat exchanger temperature.

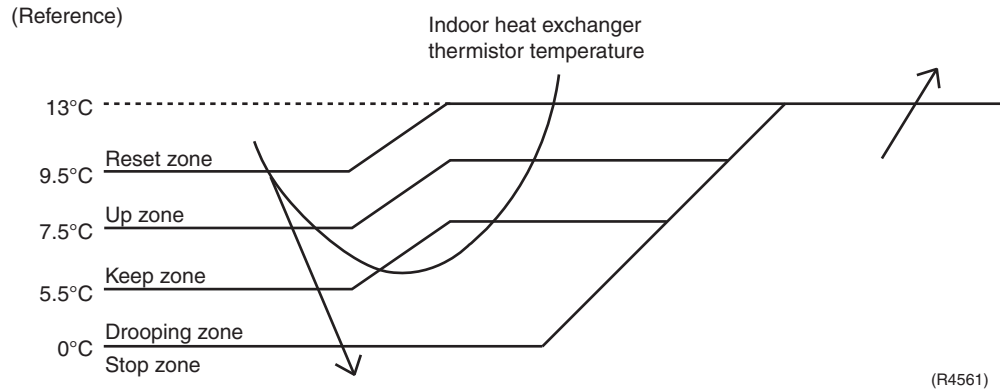

## 3.7 Heating Peak-cut Control

### Outline

During heating operation, the indoor heat exchanger temperature determines the frequency upper limit to prevent abnormal high pressure.

### Detail

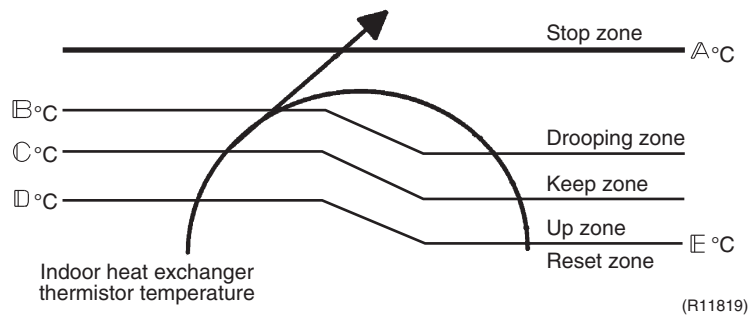

Zone	Control
Stop zone	When the temperature reaches the stop zone, the compressor stops.
Drooping zone	The timer starts, and the frequency is drooping.
Keep zone	The upper limit of frequency is kept.
Up zone	The upper limit of frequency is increased.
Reset zone	The upper limit of frequency is canceled.

	20 class	25 class	35 class
A (°C)	65	65	65
B (°C)	56	55	56
C (°C)	53	54	55
D (°C)	51	52	53
E (°C)	46	50	51

## 3.8 Outdoor Fan Control

### 1. Fan OFF delay when stopped

The outdoor fan is turned OFF 60 seconds after the compressor stops.

### 2. Fan ON control to cool down the electrical box

The outdoor fan is turned ON when the electrical box temperature is high while the compressor is OFF.

### 3. Fan OFF control while defrosting

The outdoor fan is turned OFF while defrosting.

### 4. Fan ON/OFF control when operation starts / stops

The outdoor fan is turned ON when the operation starts. The outdoor fan is turned OFF when the operation stops.

### 5. Fan control while forced operation

The outdoor fan is controlled as well as normal operation while the forced operation.

### 6. Fan speed control while indoor / outdoor quiet operation

The rotation speed of the outdoor fan is reduced by the command of the indoor/outdoor quiet operation.

### 7. Fan control for POWERFUL operation

The rotation speed of the outdoor fan is increased while the POWERFUL operation.

### 8. Fan speed control for pressure difference upkeep

The rotation speed of the outdoor fan is controlled for keeping the pressure difference while cooling with low outdoor temperature.

- ◆ When the pressure difference is small, the rotation speed of the outdoor fan is reduced.
- ◆ When the pressure difference is large, the rotation speed of the outdoor fan is increased.

## 3.9 Liquid Compression Protection Function

### Outline

In order to obtain the dependability of the compressor, the compressor is stopped according to the outdoor temperature and temperature of the outdoor heat exchanger.

### Detail

- Operation stops depending on the outdoor temperature

Compressor turns off under the conditions that the system is in cooling operation and outdoor temperature is below  $-12^{\circ}\text{C}$ .



## 3.10 Defrost Control

### Outline

Defrosting is carried out by the cooling cycle (reverse cycle). The defrosting time or outdoor heat exchanger temperature must be more than a certain value to finish.

### Detail

#### Conditions for Starting Defrost

- The starting conditions is determined with the outdoor temperature and the outdoor heat exchanger temperature.
- The system is in heating operation.
- The compressor operates for 6 minutes.
- More than  $\Delta$  minutes of accumulated time pass since the start of the operation, or ending the previous defrosting.

#### Conditions for Canceling Defrost

The judgment is made with outdoor heat exchanger temperature. ( $4^{\circ}\text{C} \sim 18^{\circ}\text{C}$ )

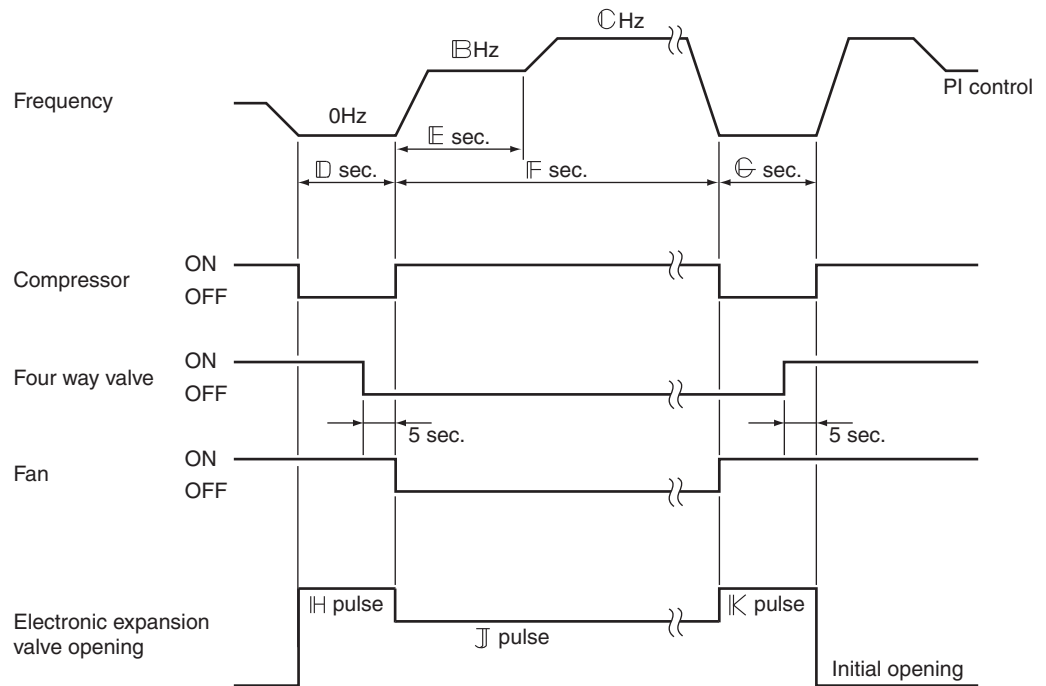

(R12211)

	20 class	25 class	35 class
$\Delta$ (minutes)	28	30	44
B (Hz)	76	48	55
C (Hz)	86	70	90
D (seconds)	50	60	60
E (seconds)	60	120	120
F (seconds)	600	650	460
G (seconds)	60	30	30
IH (pulse)	450	450	450
J (pulse)	350	350	450
IK (pulse)	450	450	450

### 3.11 Electronic Expansion Valve Control

**Outline**

The following items are included in the electronic expansion valve control.

**Electronic expansion valve is fully closed**

1. Electronic expansion valve is fully closed when turning on the power.
2. Pressure equalizing control

**Open Control**

1. Electronic expansion valve control when starting operation
2. Electronic expansion valve control when frequency changed
3. Electronic expansion valve control for defrosting
4. Electronic expansion valve control when the discharge pipe temperature is abnormally high
5. Electronic expansion valve control when the discharge pipe thermistor is disconnected

**Feedback Control**

1. Discharge pipe temperature control

**Detail**

The followings are the examples of control which function in each mode by the electronic expansion valve control.

Operation pattern		Control when frequency changed	Control for abnormally high discharge pipe temperature
When power is turned ON	Fully closed when power is turned ON	X	X
↓			
Cooling operation	Open control when starting	X	○
↓			
(Control of target discharge pipe temperature)	(Control of target discharge pipe temperature)	○	○
↓			
Stop	Pressure equalizing control	X	X
↓			
Heating operation	Open control when starting	X	○
↓			
(Control of target discharge pipe temperature)	(Control of target discharge pipe temperature)	○	○
↓			
Stop	Pressure equalizing control	X	X
↓			
Heating operation	Open control when starting	X	X
↓			
Continue	Continue	X	○
↓			
Control of discharge pipe thermistor disconnection		X	X
↓			
Stop	Pressure equalizing control	X	X

(R2833)

### 3.11.1 Fully Closing with Power ON

The electronic expansion valve is initialized when turning on the power. The opening position is set and the pressure equalization is developed.

### 3.11.2 Pressure Equalization Control

When the compressor is stopped, the pressure equalization control is activated. The electronic expansion valve opens, and develops the pressure equalization.

### 3.11.3 Opening Limit

#### Outline

A maximum and minimum opening of the electronic expansion valve are limited.

#### Detail

	20 class	25 class	35 class
Maximum opening (pulse)	480	450	480
Minimum opening (pulse)	52	60	54

The electronic expansion valve is fully closed when cooling operation stops, and is opened at fixed degree during defrosting.

### 3.11.4 Starting Operation Control

The electronic expansion valve opening is controlled when the operation starts, and prevents the superheating or liquid compression.

### 3.11.5 High Discharge Pipe Temperature

When the compressor is operating, if the discharge pipe temperature exceeds a certain value, the electronic expansion valve opens and the refrigerant runs to the low pressure side. This procedure lowers the discharge pipe temperature.

### 3.11.6 Disconnection of the Discharge Pipe Thermistor

#### Outline

The disconnection of the discharge pipe thermistor is detected by comparing the discharge pipe temperature with the condensation temperature. If the discharge pipe thermistor is disconnected, the electronic expansion valve opens according to the outdoor temperature and the operation frequency, and operates for a specified time, and then stops.

After 3 minutes of waiting, the operation restarts and checks if the discharge pipe thermistor is disconnected. If the discharge pipe thermistor is disconnected, the system stops after operating for a specified time.

If the disconnection is detected 4 ~ 5 times (depending on the model) in succession, then the system is shut down. When the compressor runs for 60 minutes without any error, the error counter is reset.

**Detail**

When the starting control (cooling :  $\Delta$  seconds, heating :  $\text{B}$  seconds) finishes, the detection timer for disconnection of the discharge pipe thermistor (  $\text{C}$  seconds) starts. When the timer is over, the following adjustment is made.

## 1. When the operation mode is cooling

When the following condition is fulfilled, the discharge pipe thermistor disconnection is ascertained.

Discharge pipe temperature + 6°C < outdoor heat exchanger temperature

## 2. When the operation mode is heating

When the following condition is fulfilled, the discharge pipe thermistor disconnection is ascertained.

Discharge pipe temperature + 6°C < indoor heat exchanger temperature

	20 class	25 class	35 class
$\Delta$ (seconds)	10	10	10
$\text{B}$ (seconds)	120	30	30
$\text{C}$ (seconds)	810	630	630

**Adjustment when the thermistor is disconnected**

When the disconnection is ascertained, the compressor continues operation for 9 minutes and then stops.

When the compressor stops repeatedly, the system is shut down.

**3.11.7 Control when frequency is changed**

When the target discharge pipe temperature control is active, if the target frequency is changed for a specified value in a certain time period, the target discharge pipe temperature control is canceled and the target opening of the electronic expansion valve is changed according to the shift.

**3.11.8 Target Discharge Pipe Temperature Control**

The target discharge pipe temperature is obtained from the indoor and outdoor heat exchanger temperature, and the electronic expansion valve opening is adjusted so that the actual discharge pipe temperature becomes close to the target discharge pipe temperature. (Indirect SH (superheating) control using the discharge pipe temperature)

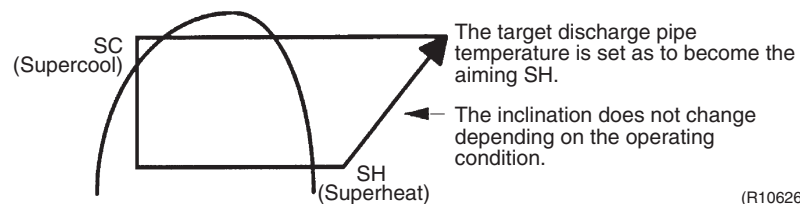

The electronic expansion valve opening and the target discharge pipe temperature are adjusted every 20 seconds. The target discharge pipe temperature is controlled by indoor heat exchanger temperature and outdoor heat exchanger temperature. The opening degree of the electronic expansion valve is controlled by followings.

- ◆ Target discharge pipe temperature
- ◆ Actual discharge pipe temperature
- ◆ Previous discharge pipe temperature

## 3.12 Malfunctions

### 3.12.1 Sensor Malfunction Detection

Sensor malfunction may occur in the thermistor.

#### Relating to Thermistor Malfunction

1. Outdoor heat exchanger thermistor
2. Discharge pipe thermistor
3. Radiation fin thermistor
4. Outdoor temperature thermistor

### 3.12.2 Detection of Overcurrent and Overload

#### Outline

An excessive output current is detected and, the OL temperature is observed to protect the compressor.

#### Detail

- If the OL (compressor head) temperature exceeds 120 ~ 130°C (depending on the model), the system shuts down the compressor.
- If the inverter current exceeds 9.25 ~ 20 A (depending on the model), the system shuts down the compressor.

### 3.12.3 Refrigerant Shortage Control

#### Outline

##### I Detecting by power consumption

If the power consumption is below the specified value and the frequency is higher than the specified frequency, it is regarded as refrigerant shortage.

The power consumption is small comparing with that in the normal operation when refrigerant is insufficient, and refrigerant shortage is detected by checking a power consumption.

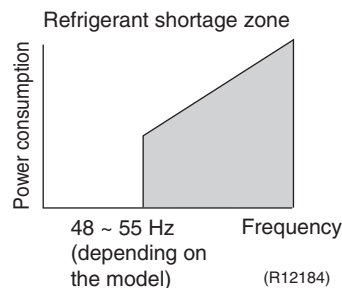

##### II Detecting by discharge pipe temperature

If the discharge pipe temperature is higher than the target discharge pipe temperature, and the electronic expansion valve is fully open for more than the specified time, it is regarded as refrigerant shortage.

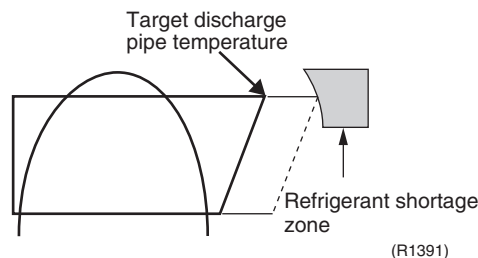

##### III Detecting by the difference of temperature

If the difference between suction and discharge temperature is smaller than the specified value, it is regarded as refrigerant shortage.



Refer to "Refrigerant shortage" on page 112 for detail.

## 3.13 Forced Operation Mode

**Outline** Forced operation mode includes only forced cooling.

### Detail

Item	Forced Cooling
Conditions	1) The outdoor unit is not abnormal and not in the 3-minute standby mode.
	2) The outdoor unit is not operating.
	The forced operation is allowed when the above both conditions are met.
Start	1) Press the forced operation ON/OFF button (SW1) on the indoor unit for 5 seconds.
	2) Press the forced operation ON/OFF button (SW1) on the outdoor unit.
Command frequency	RXL20G2V1B: 68 Hz RXL20G2V1B9: 58 Hz RXL25G2V1B: 47 Hz RXL35G2V1B: 66 Hz
End	1) The operation ends automatically after 15 minutes.
	2) Press the forced operation ON/OFF button (SW1) on the indoor unit again.
	3) Press the ON/OFF button on the remote control.
	4) Press the forced operation ON/OFF button (SW1) on the outdoor unit.
Others	The protection functions are prior to all others in the forced operation.

## 3.14 Standby Electricity Saving

### 20/25 Class Only

This function turns power supply OFF to the outdoor unit and sets the indoor unit into energy-saving mode, thus reducing the power consumption of the air conditioner.

**For 20 class models, field setting is required for turning ON the function.**



Refer to "Standby Electricity Saving" on page 269 for detail.

# Part 5

# Operation Manual

1. System Configuration.....	50
2. Operation Manual.....	51
2.1 Auto Dry Cool Heat Fan Operation .....	52
2.2 Adjusting the Airflow Direction.....	54
2.3 COMFORT AIRFLOW and INTELLIGENT EYE Operation.....	56
2.4 POWERFUL Operation .....	59
2.5 OUTDOOR UNIT QUIET Operation.....	60
2.6 ECONO Operation .....	61
2.7 TIMER Operation .....	62
2.8 WEEKLY TIMER Operation .....	64

# 1. System Configuration

After the installation and test operation of the room air conditioner have been completed, it should be operated and handled as described below. Every user would like to know the correct method of operation of the room air conditioner, to check if it is capable of cooling (or heating) well, and to know a clever method of using it.

In order to meet this expectation of the users, giving sufficient explanations taking enough time can be said to reduce about 80% of the requests for servicing. However good the installation work is and however good the functions are, the customer may blame either the room air conditioner or its installation work because of improper handling. The installation work and handing over of the unit can only be considered to have been completed when its handling has been explained to the user without using technical terms but giving full knowledge of the equipment.



## 2. Operation Manual

### 2.1 Remote Control

#### ■ Remote Control

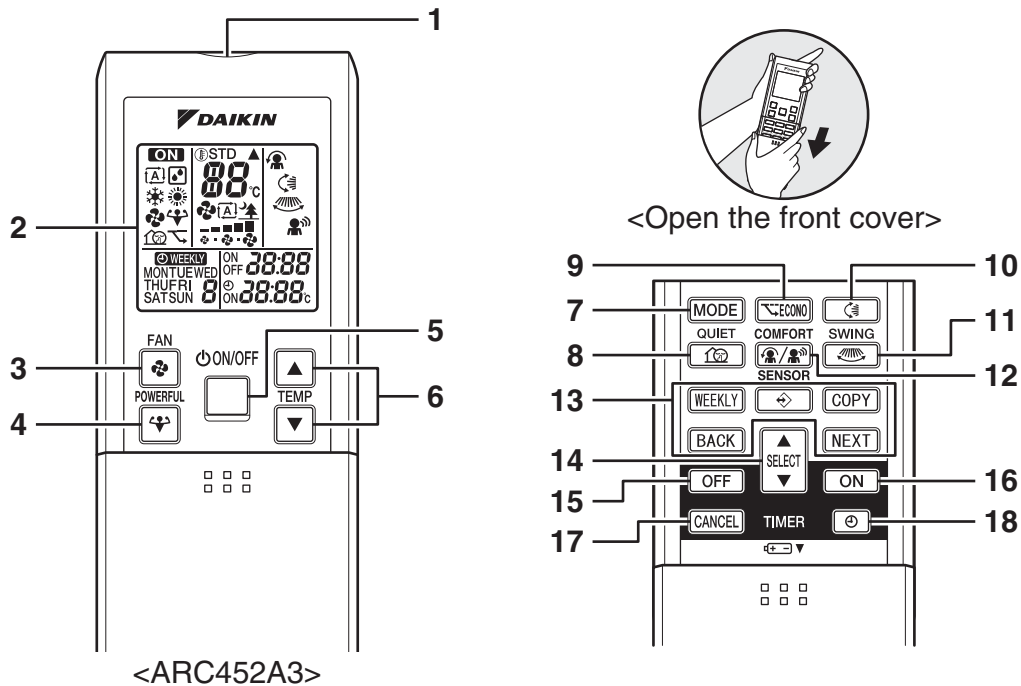

#### 1. Signal transmitter:

- It sends signals to the indoor unit.

#### 2. Display:

- It displays the current settings.  
(In this illustration, each section is shown with all its displays ON for the purpose of explanation.)

#### 3. FAN setting button:

- It selects the airflow rate setting.

#### 4. POWERFUL button:

- POWERFUL operation

#### 5. ON/OFF button:

- Press this button once to start operation.  
Press once again to stop it.

#### 6. TEMPERATURE adjustment buttons:

- It changes the temperature setting.

#### 7. MODE selector button

- It selects the operation mode.  
(AUTO/DRY/COOL/HEAT/FAN)

#### 8. QUIET button:

- OUTDOOR UNIT QUIET operation

#### 9. ECONO button:

- ECONO operation

#### 10. SWING button:

- Horizontal blades (flaps)

#### 11. SWING button:

- Louvers (vertical blades)

#### 12. COMFORT/SENSOR button:

- COMFORT AIRFLOW and INTELLIGENT EYE operation

#### 13. WEEKLY/PROGRAM/COPY/BACK/NEXT button:

- WEEKLY TIMER operation

#### 14. SELECT button:

- It changes the ON/OFF TIMER and WEEKLY TIMER settings.

#### 15. OFF TIMER button

#### 16. ON TIMER button

#### 17. TIMER CANCEL button:

- It cancels the timer setting.  
• It cannot be used for the WEEKLY TIMER operation

#### 18. CLOCK button

## 2.2 Auto Dry Cool Heat Fan Operation

The air conditioner operates with the operation mode of your choice. From the next time on, the air conditioner will operate with the same operation mode.

### ■ To start operation

1. Press “MODE selector button” and select a operation mode.
  - Each pressing of the button advances the mode setting in sequence.

- : AUTO
- : DRY
- : COOL
- : HEAT
- : FAN



2. Press “ON/OFF button”.
  - “ON” is displayed on the LCD.
  - The OPERATION lamp lights up.

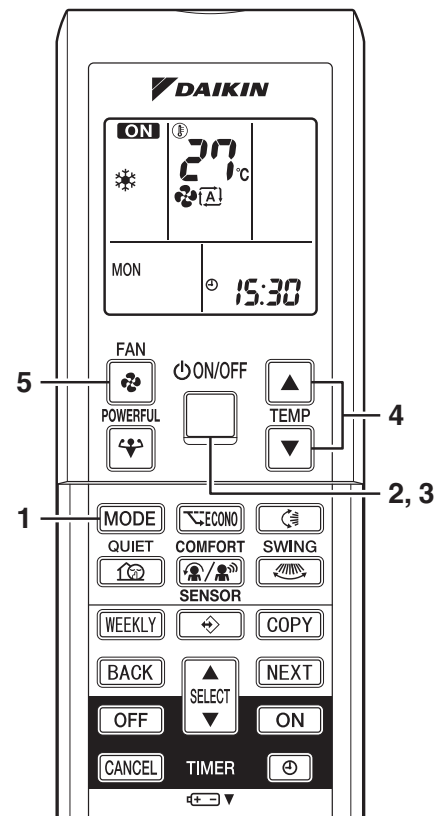
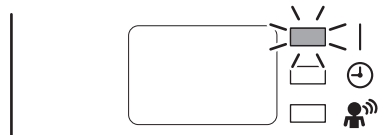

### ■ To stop operation

3. Press “ON/OFF button” again.
  - “ON” disappears from the LCD.
4. Then OPERATION lamp goes off.





### ■ To change the temperature setting

5. Press “TEMPERATURE adjustment button”.

DRY or FAN mode The temperature setting is not variable.	AUTO or COOL or HEAT mode Press “▲” to raise the temperature and press “▼” to lower the temperature. Set to the temperature you like 
-------------------------------------------------------------	------------------------------------------------------------------------------------------------------------------------------------------------

## ■ To change the airflow rate setting

### 6. Press “FAN setting button”.

DRY mode	AUTO or COOL or HEAT or FAN mode
The airflow rate setting is not variable.	Five levels of airflow rate setting from “  ” to “  ” plus “  ” “  ” are available. 

- Indoor unit quiet operation

When the air flow is set to “”, the noise from the indoor unit will become quieter. Use this when making the noise quieter.

## NOTE

### ■ Note on HEAT operation

- Since this air conditioner heats the room by taking heat from outdoor air to indoors, the heating capacity becomes smaller in lower outdoor temperatures. If the heating effect is insufficient, it is recommended to use another heating appliance in combination with the air conditioner.
- The heat pump system heats the room by circulating hot air around all parts of the room. After the start of HEAT operation, it takes some time before the room gets warmer.
- In heating operation, frost may occur on the outdoor unit and lower the heating capacity. In that case, the system switches into defrosting operation to take away the frost.
- During defrosting operation, hot air does not flow out of indoor unit.
- A pinging sound may be heard during defrosting operation, which, however does not mean that the air conditioner has failures.

### ■ Note on COOL operation

- This air conditioner cools the room by blowing the hot air in the room outside, so if the outside temperature is high, the performance of the air conditioner drops.

### ■ Note on DRY operation

- The computer chip works to rid the room of humidity while maintaining the temperature as much as possible. It automatically controls temperature and airflow rate, so manual adjustment of these functions is unavailable.

### ■ Note on AUTO operation

- In AUTO operation, the system selects a temperature setting and an appropriate operation mode (COOL or HEAT) based on the room temperature at the start of the operation.
- The system automatically reselects setting at a regular interval to bring the room temperature to user-setting level.
- If you do not like AUTO operation, manually change the set temperature..

### ■ Note on FAN operation

- This mode is valid for fan only.





### ■ Note on airflow rate setting

- At smaller airflow rates, the cooling (heating) effect is also smaller.





## 2.3 Adjusting the Airflow Direction

You can adjust the airflow direction to increase your comfort.

### ■ To adjust the horizontal blades (flaps)



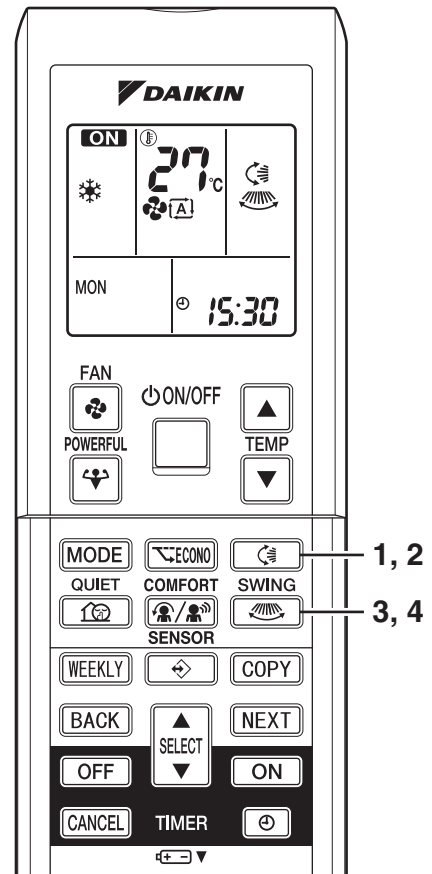

1. Press “SWING button ”.
  - “” is displayed on the LCD and the flaps will begin to swing.
2. When the flaps have reached the desired position, press “SWING button ” once more.
  - The flaps will stop moving.
  - “” disappears from the LCD

### ■ To adjust the vertical blades (louvers)

3. Press “SWING button ”.
  - “” is displayed on the LCD.
4. When the louvers have reached the desired position, press the “SWING button ” once more.
  - The louvers will stop moving.
  - “” disappears from the LCD.



## ■ To start 3-D Airflow

3. Press the “SWING button ” and the “SWING button ”:  
the “” and “” display will light up and the flap and louvers will move in turn.

## ■ To cancel 3-D Airflow

4. Press either the “SWING button ” or the “SWING button ”.

## ■ COMFORT AIRFLOW operation

- Check COMFORT AIRFLOW operation in the section of COMFORT AIRFLOW Operation and “INTELLIGENT EYE Operation”

## Notes on flaps and louvers angles

- When “SWING button” is selected, the flaps swinging range depends on the operation mode. (See the figure.)

### Three-Dimensional (3-D) Airflow

- Using three-dimensional airflow circulates cold air, which tends to be collected at the bottom of the room, and hot air, which tends to collect near the ceiling, throughout the room, preventing areas of cold and hot developing.

### ■ ATTENTION

- Always use a remote control to adjust the angles of the flaps and louvers. If you attempt to move it forcibly with hand when it is swinging, the mechanism may be broken.
- Always use a remote control to adjust the louvers angles. Inside the air outlet, a fan is rotating at a high speed.

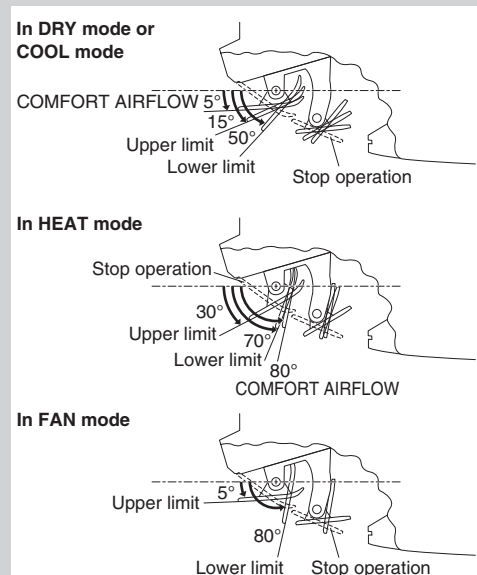

## 2.4 COMFORT AIRFLOW and INTELLIGENT EYE Operation

The INTELLIGENT EYE incorporates infrared sensors to detect the presence of people in the conditioned room.

When these sensors detect people, the louvers will adjust the airflow direction to an area where people are not present. When there are no people in the sensing areas, the air conditioner will go into energy-saving mode.

### ■ To start operation

1. Press “COMFORT/SENSOR button” and select an operation mode.
  - Choose the desired operation mode out of the following sequence.
  - Each time the “COMFORT/SENSOR button” is pressed a different setting option is displayed on the LCD.



### ■ To cancel operation

2. Press “COMFORT/SENSOR button”.
  - Press the button to select “Blank”.

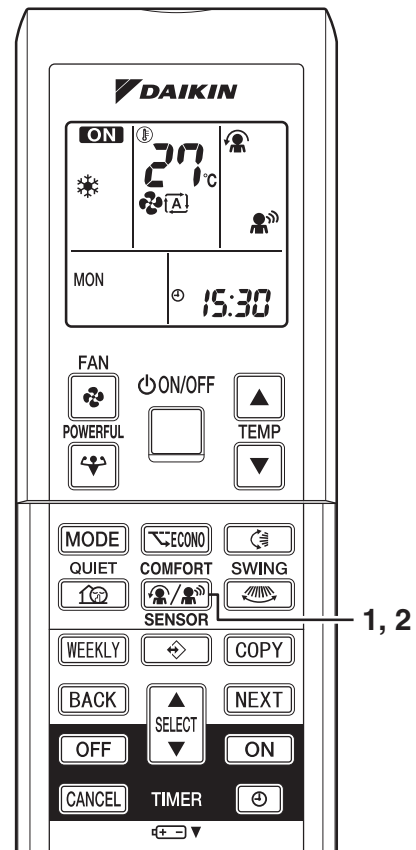

Display	Operation mode	Explanation
	COMFORT AIRFLOW	The flaps will adjust the airflow direction upward while cooling, and adjust the airflow direction downward while heating.
	INTELLIGENT EYE	The sensors will detect the movement of people in the sensing areas and the louvers will adjust the airflow direction to an area where people are not present. When there are no people in the sensing areas, the air conditioner will go into energy-saving mode.
	COMFORT AIRFLOW and INTELLIGENT EYE	The air conditioner will be in COMFORT AIRFLOW operation combined with INTELLIGENT EYE operation.
Blank	No function	—

## Notes on “COMFORT AIRFLOW Operation”

### ■ Note on the angles of the flaps

- The flap position will change, preventing air from blowing directly on the occupants of the room.
- POWERFUL operation and COMFORT AIRFLOW operation cannot be used at the same time.
- The volume of air will be set to AUTO. If the upward and downward airflow direction is selected, the COMFORT AIRFLOW function will be canceled.
- Priority is given to the function of whichever button is pressed last.
- The COMFORT AIRFLOW function makes the following airflow direction adjustments.  
The flaps will move upward while cooling so that the airflow will be directed upward.  
The flaps will move downward while heating so that the airflow will be directed downward.

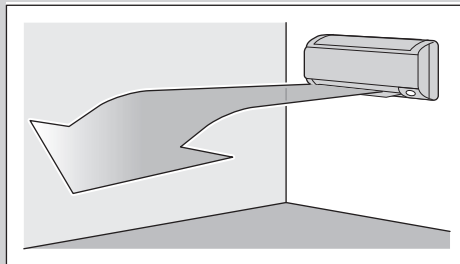

Cooling operation

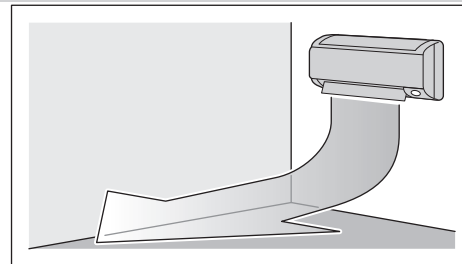

Heating operation

## Notes on “INTELLIGENT EYE Operation”

- The INTELLIGENT EYE sensor according to the following situations.

Vertical angle 90°  
(Side View)

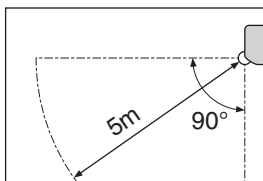

Horizontal angle 110°  
(Top View)

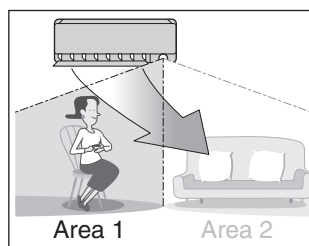
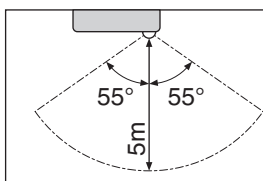

A person is detected in  
area 1.

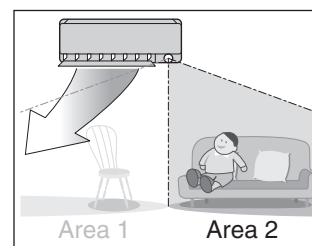

A person is detected in  
area 2.

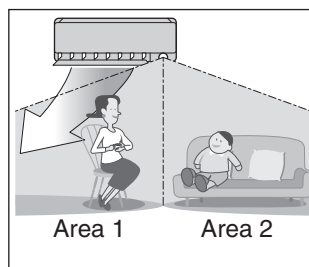

People are detected in  
both areas.

(Use the INTELLIGENT EYE  
Operation in combination with the  
COMFORT AIRFLOW Operation.)

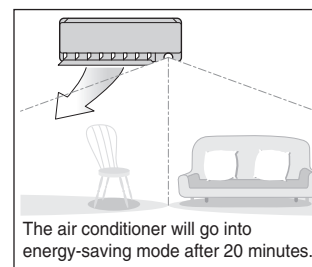

The air conditioner will go into  
energy-saving mode after 20 minutes.

No people are detected in  
the areas.

\* The wind direction may differ from the  
illustrated direction depending on the actions  
and movements of the people in the areas.

## Notes on “INTELLIGENT EYE Operation”

- While the air conditioner is in INTELLIGENT EYE operation, the louvers will adjust the airflow direction if there are people in the sensing areas of the INTELLIGENT EYE so that the leftward or rightward airflow will not be directed to the people. If no people are detected in either area 1 or 2 in 20 minutes, the air conditioner will go into energy-saving mode with the set temperature shifted by 2°C. The air conditioner may go into energy-saving operation even if there are people in the areas. This may occur depending on the clothes the people are wearing if there are no movements of the people in the areas.
- The airflow direction from the louvers will be leftward if there are people in both areas 1 and 2 or if there is a person right in front of the sensors because the sensors on the both sides will detect the person.
- Due to the position of the sensor, people might be exposed to the airflow of the indoor unit if they are close to the front side of the indoor unit.  
If there are people close to the front side of the indoor unit or in both areas, it is recommended to use the COMFORT AIRFLOW and INTELLIGENT EYE functions simultaneously. When both of them are in use, the air conditioner will not direct the airflow towards the people.
- Sensor may not detect moving objects further than 5m away. (Check the application range)
- Sensor detection sensitivity changes according to indoor unit location, the speed of passersby, temperature range, etc.
- The sensor also mistakenly detects pets, sunlight, fluttering curtains and light reflected off of mirrors as passersby.
- NIGHT SET MODE will not go on during use of INTELLIGENT EYE operation.

## “INTELLIGENT EYE” is useful for Energy Saving

### ■ Energy saving operation

- Change the temperature -2°C in heating / +2°C in cooling / +2°C in dry mode from set temperature.
- Decrease the airflow rate slightly in FAN mode only. If no presence detected in the room during 20 minutes.

### ■ To combine “COMFORT AIRFLOW Operation” and “INTELLIGENT EYE Operation”

- The air conditioner can go into operation with the COMFORT AIRFLOW and INTELLIGENT EYE functions combined. The flaps adjust the airflow direction upward (while in cooling operation) and downward (while in heating operation), during which the sensors of the INTELLIGENT EYE are working to detect the movement of people. When the sensors detect people, the louvers will direct the airflow in such way that it will not be blown directly on them. If there are no people, the air conditioner will go into energy-saving operation after 20 minutes.



### CAUTION

- Do not place large objects near the sensor. Also keep heating units or humidifiers outside the sensor's detection area. This sensor can detect undesirable objects.
- Do not hit or violently push the INTELLIGENT EYE sensor. This can lead to damage and malfunction.



## 2.5 POWERFUL Operation

POWERFUL operation quickly maximizes the cooling (heating) effect in any operation mode.

You can get the maximum capacity.

### ■ To start POWERFUL operation

1. Press “POWERFUL button”.
  - POWERFUL operation ends in 20minutes. Then the system automatically operates again with the previous settings which were used before POWERFUL operation.
  - “” is displayed on the LCD.
  - When using POWERFUL operation, there are some functions which are not available.

### ■ To cancel POWERFUL operation

2. Press “POWERFUL button” again.
  - “” disappears from the LCD.

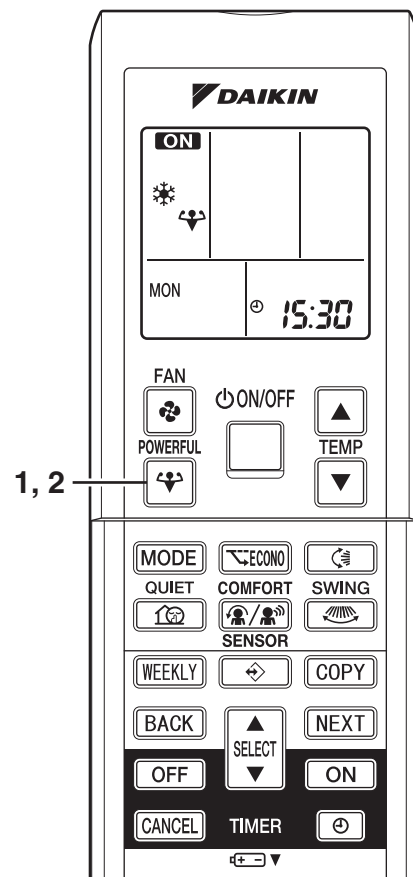

## NOTE

### ■ Notes on COMFORT AIRFLOW operation

- POWERFUL Operation cannot be used together with ECONO, QUIET, or COMFORT Operation. Priority is given to the function of whichever button is pressed last.
- POWERFUL Operation can only be set when the unit is running. Pressing the operation stop button causes the settings to be canceled, and the “” disappears from the LCD.
- POWERFUL operation will not increase the capacity of the air conditioner if the air conditioner is already in operation with its maximum capacity demonstrated.
- **In COOL and HEAT mode**  
To maximize the cooling (heating) effect, the capacity of outdoor unit must be increased and the airflow rate be fixed to the maximum setting.  
The temperature and airflow settings are not variable.
- **In DRY mode**  
The temperature setting is lowered by 2.5°C and the airflow rate is slightly increased.
- **In FAN mode**  
The airflow rate is fixed to the maximum setting.

## 2.6 OUTDOOR UNIT QUIET Operation

OUTDOOR UNIT QUIET operation lowers the noise level of the outdoor unit by changing the frequency and fan speed on the outdoor unit.

This function is convenient during night.

### ■ To start OUTDOOR UNIT QUIET operation

1. Press "QUIET button".
  - "🔇" is displayed on the LCD.

### ■ To cancel OUTDOOR UNIT QUIET operation

2. Press "QUIET button" again.
  - "🔇" disappears from the LCD.

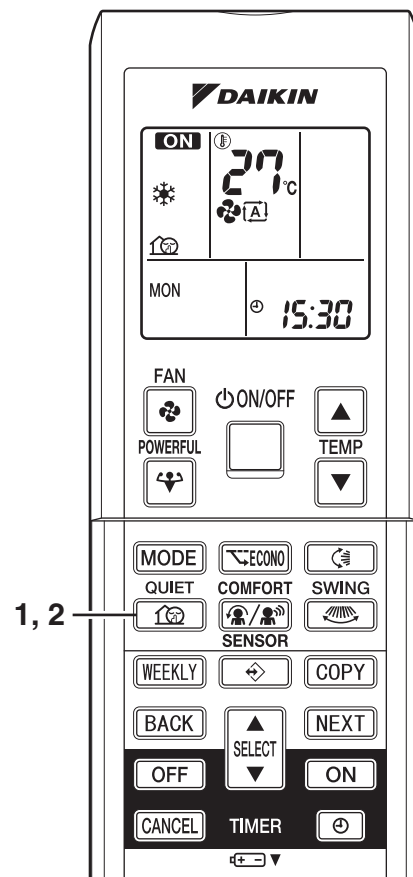

## NOTE

### ■ Notes on COMFORT AIRFLOW operation

- This function is available in COOL, HEAT, and AUTO modes. (This is not available in FAN and DRY mode.)
- POWERFUL operation and OUTDOOR UNIT QUIET operation cannot be used at the same time. Priority is given to the function of whichever button is pressed last.
- OUTDOOR UNIT QUIET operation will drop neither the frequency nor fan speed if the frequency and fan speed have been already dropped low enough.

## 2.7 ECONO Operation

ECONO operation is a function which enables efficient operation by limiting the maximum power consumption value.

This function is useful for cases in which attention should be paid to ensure a circuit breaker will not trip when the product runs alongside other appliances.

### ■ To start ECONO operation

1. Press “ECONO button”.
  - “” is displayed on the LCD.

### ■ To cancel ECONO operation

2. Press “ECONO button” again.
  - “” disappears from the LCD.

Running current and power consumption

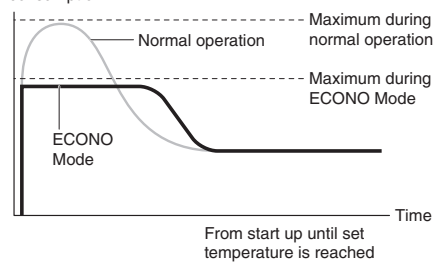

- This diagram is a representation for illustrative purposes only.
- \* The maximum running current and power consumption of the air conditioner in ECONO mode vary with the connecting outdoor unit.

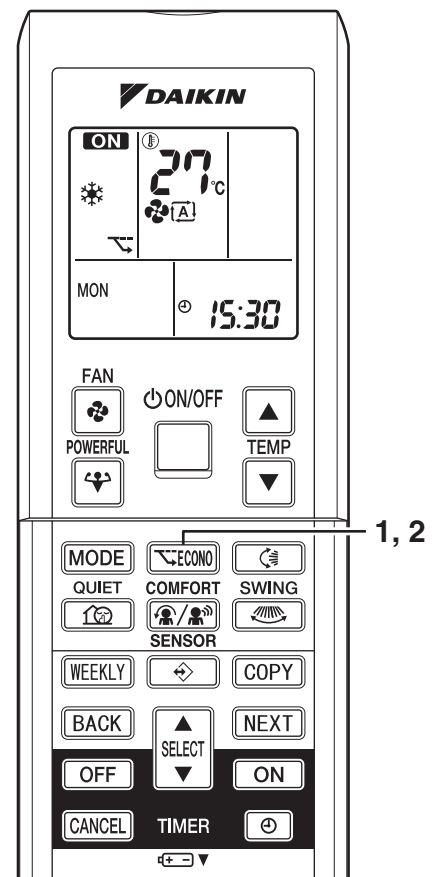

## NOTE

### ■ Notes on ECONO operation

- ECONO Operation can only be set when the unit is running. Pressing the OFF button causes the setting to be canceled, and the “” disappears from the LCD.
- ECONO operation is a function which enables efficient operation by limiting the power consumption of the outdoor unit (operating frequency).
- ECONO operation functions in AUTO, COOL, DRY and HEAT modes.
- POWERFUL and ECONO operation cannot be used at the same time. Priority is given to the function of whichever button is pressed last.
- Power consumption may not drop even if ECONO operation is used if the level of power consumption is already low.

## 2.8 TIMER Operation

Timer functions are useful for automatically switching the air conditioner on or off at night or in the morning. You can also use OFF TIMER and ON TIMER in combination.

### ■ To use OFF TIMER operation

- Check that the clock is correct.  
If not, set the clock to the present time.
1. Press “OFF TIMER button”.
    - “0:00” is displayed on the LCD.
    - “ OFF ” blinks.
  2. Press “SELECT button” until the time setting reaches the point you like.
    - Every pressing of either button increases or decreases the time setting by 10 minutes.  
Holding down either button changes the setting rapidly.
  3. Press “OFF TIMER button” again.
    - The TIMER lamp lights up..



### ■ To cancel the OFF TIMER operation

4. Press “CANCEL button”.
  - The TIMER lamp goes off

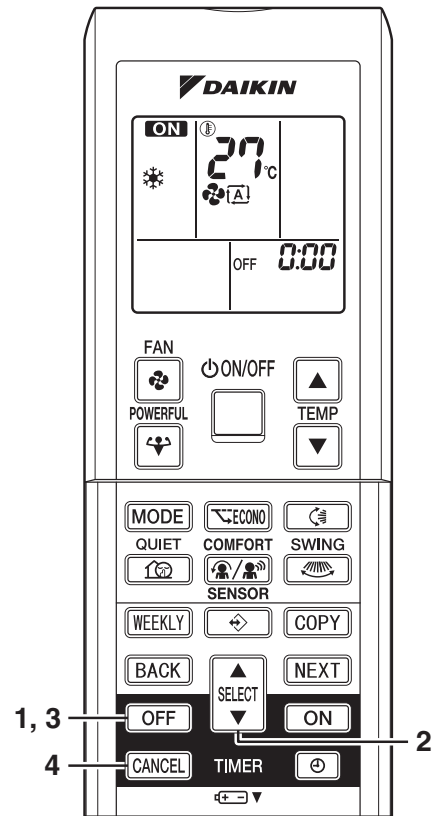

## NOTE

- When TIMER is set, the present time is not displayed.
- Once you set ON, OFF TIMER, the time setting is kept in the memory. (The memory is canceled when remote control batteries are replaced.)
- When operating the unit via the ON/OFF Timer, the actual length of operation may vary from the time entered by the user. (Maximum approx. 10 minutes)

### ■ NIGHT SET mode

When the OFF TIMER is set, the air conditioner automatically adjusts the temperature setting (0.5°C up in COOL, 2.0°C down in HEAT) to prevent excessive cooling (heating) for your pleasant sleep.

## ■ To use ON TIMER operation

- Check that the clock is correct.  
If not, set the clock to the present time.
1. Press “ON TIMER button”.
    - “6:00” is displayed on the LCD.
    - “ON” blinks.
  2. Press “SELECT button” until the time setting reaches the point you like.
    - Every pressing of either button increases or decreases the time setting by 10 minutes.  
Holding down either button changes the setting rapidly.
  3. Press “ON TIMER button” again.
    - The TIMER lamp lights up.

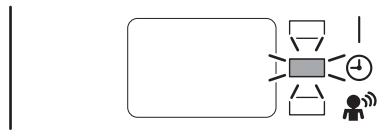

## ■ To cancel the ON TIMER operation

4. Press “CANCEL button”.
  - The TIMER lamp goes off.

## ■ To combine ON TIMER and OFF TIMER

- A sample setting for combining the two timers is shown below.

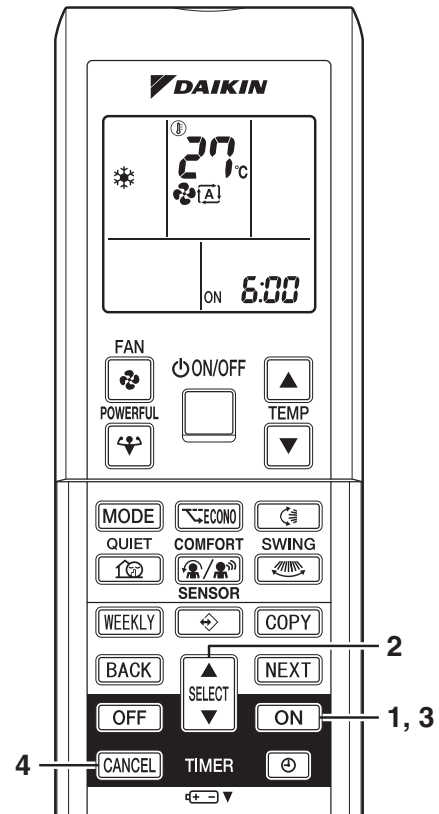
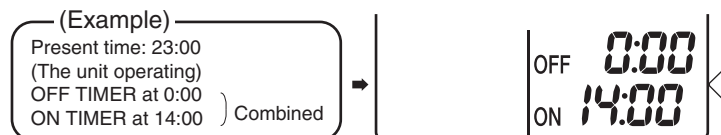

## ATTENTION

- In the following cases, set the timer again.
  - After a breaker has turned OFF.
  - After a power failure.
  - After replacing batteries in the remote control.

## 2.9 WEEKLY TIMER Operation

Up to 4 timer settings can be saved for each day of the week. It is convenient if the WEEKLY TIMER is set according to the family's life style.

### ■ Using in these cases of WEEKLY TIMER

An example of WEEKLY TIMER settings is shown below.

**Example:** The same timer settings are made for the week from Monday through Friday while different timer settings are made for the weekend.

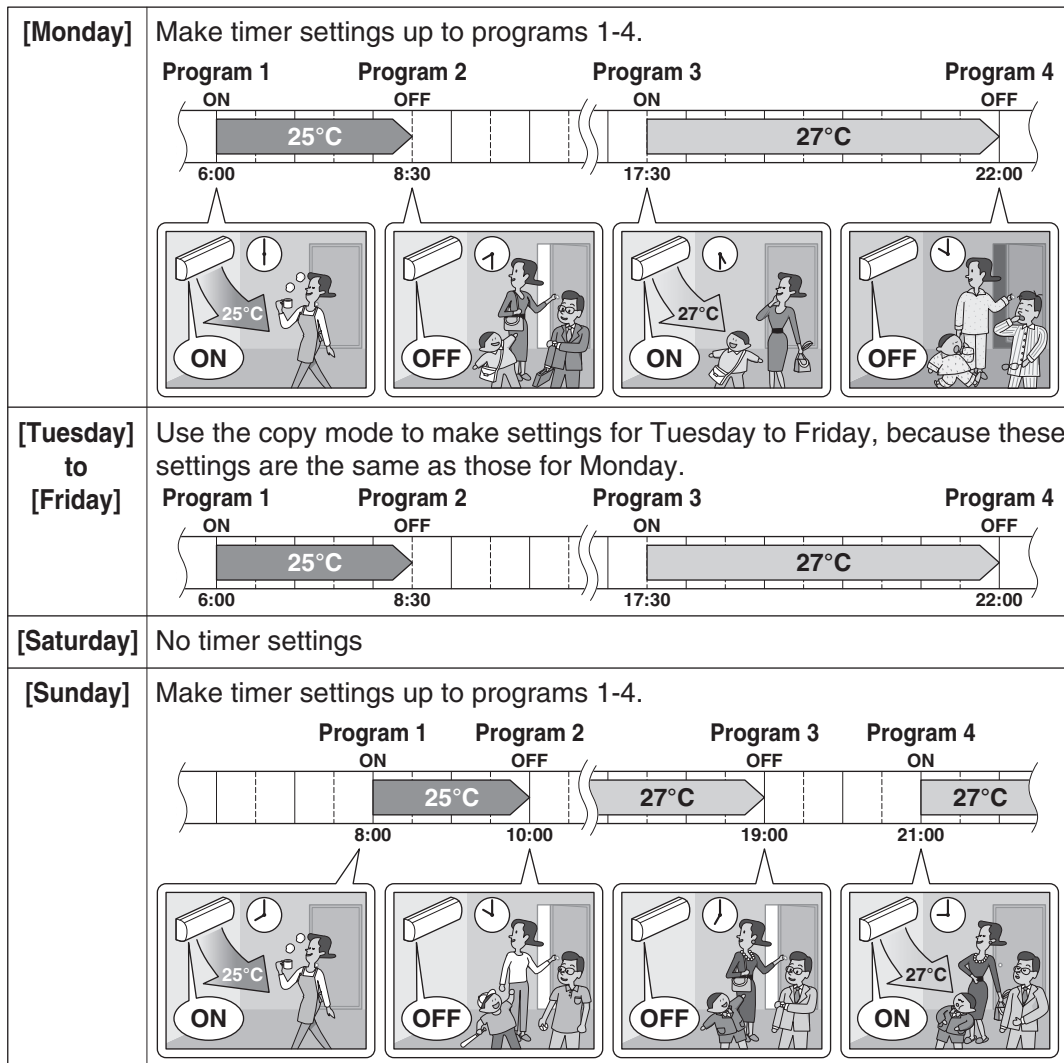

- Up to 4 reservations per day and 28 reservations per week can be set in the WEEKLY TIMER. The effective use of the copy mode ensures ease of making reservations.
- The use of ON-ON-ON-ON settings, for example, makes it possible to schedule operating mode and set temperature changes. Furthermore, by using OFF-OFF-OFF-OFF settings, only the turn-OFF time of each day can be set. This will turn OFF the air conditioner automatically if the user forgets to turn it OFF.

## ■ To use WEEKLY TIMER operation

### Setting mode

- Make sure the day of the week and time are set. If not, set the day of the week and time.

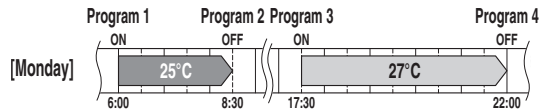

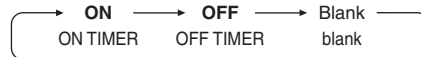

- Press “” button”.
  - The day of the week and the reservation number of the current day will be displayed.
  - 1 to 4 settings can be made per day.
- Press the “SELECT button” to select the desired day of the week and reservation number.
  - Pressing the “SELECT button” changes the reservation number and the day of the week.
- Press “NEXT button”.
  - The day of the week and reservation number will be set.
  - “ WEEKLY” and “ON” blink.
- Press “SELECT button” to select the desired mode.
  - Pressing the “SELECT button” changes “ON” or “OFF” setting in sequence.

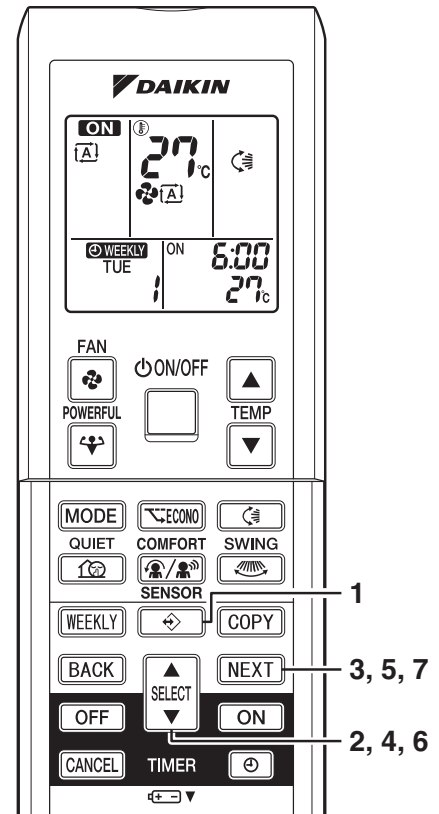
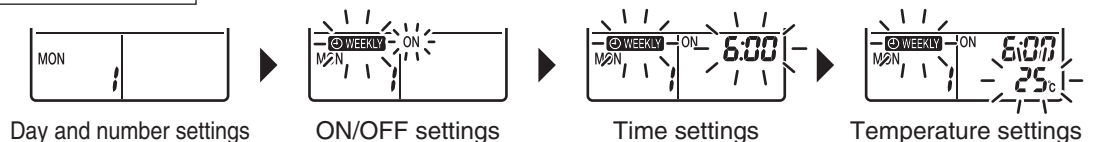

- In case the reservation has already been set, selecting “blank” deletes the reservation.
  - Go to STEP 9 if “blank” is selected.
- Press “NEXT button”.
    - The ON/OFF TIMER mode will be set.
    - “ WEEKLY” and the time blink.
  - Press “SELECT button” to select the desired time.
    - The time can be set between 0:00 and 23:50 in 10 minute intervals.
    - To return to the ON/OFF TIMER mode setting, press “BACK button”.
    - Go to STEP 9 when setting the OFF TIMER.
  - Press “NEXT button”.
    - The time will be set.
    - “ WEEKLY” and the temperature blink.

### Setting Displays



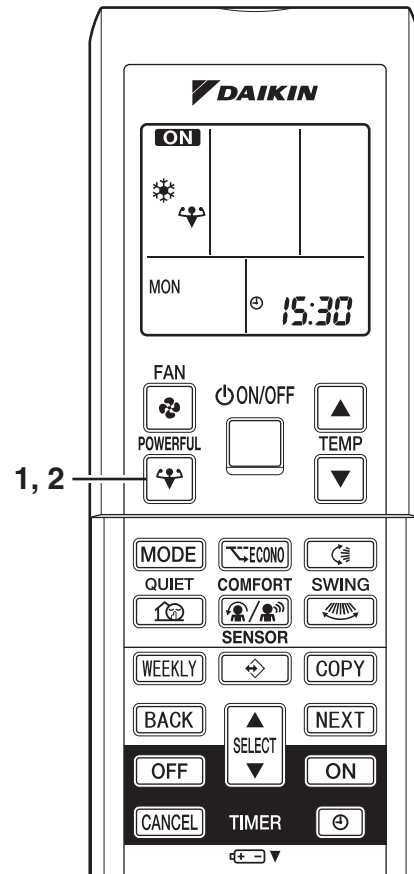

8. Press “SELECT button” to select the desired temperature.
  - The temperature can be set between 10°C and 32°C.  
Cooling: The unit operates at 18°C even if it is set at 10 to 17°C.  
Heating: The unit operates at 30°C even if it is set at 31 to 32°C.
  - To return to the time setting, press “BACK button”.
  - The set temperature is only displayed when the mode setting is on.
9. Press “NEXT button”.
  - The temperature will be set and go to the next reservation setting.
  - To continue further settings, repeat the procedure from STEP 4.
10. Press “ button” to complete the setting.
  - Be sure to direct the remote control toward the indoor unit and check for a receiving tone and flashing the operation lamp.
  - “ WEEKLY” is displayed on the LCD and WEEKLY TIMER operation is activated.
  - The TIMER lamp lights up.
  - A reservation made once can be easily copied and the same settings used for another day of the week.  
Refer to Copy mode.



## NOTE

### ■ Notes on WEEKLY TIMER operation

- Do not forget to set the clock on the remote control first.
- The day of the week, ON/OFF TIMER mode, time and set temperature (only for ON TIMER mode) can be set with WEEKLY TIMER. Other settings for ON TIMER are based on the settings just before the operation.
- Both WEEKLY TIMER and ON/OFF TIMER operation cannot be used at the same time. The ON/OFF TIMER operation has priority if it is set while WEEKLY TIMER is still active. The WEEKLY TIMER will go into standby state, and “ WEEKLY” will disappear from the LCD.  
When ON/OFF TIMER is up, the WEEKLY TIMER will automatically become active.
- Only the time and set temperature set with the weekly timer are sent with the “ button”. Set the weekly timer only after setting the operation mode, the fan strength, and the fan direction ahead of time.
- Shutting the breaker off, power failure, and other similar events will render operation of the indoor unit’s internal clock inaccurate. Reset the clock.
- The “BACK button” can be used only for the time and temperature settings. It cannot be used to go back to the reservation number.



## Copy mode

- A reservation made once can be copied another day of the week. The whole reservation of the selected day of the week will be copied.

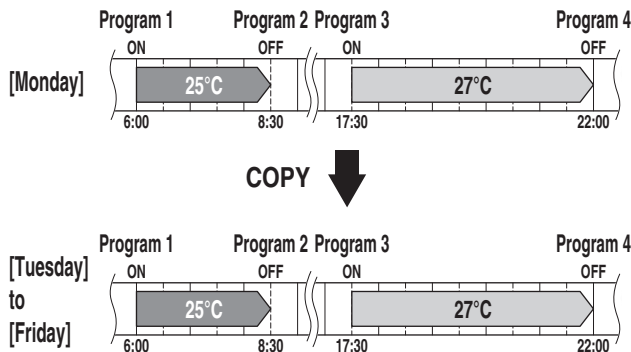

- Press “” button”.
- Press “SELECT button” to confirm the day of the week to be copied.
- Press “COPY button” to activate copy mode.
  - The whole reservation of the selected day of the week will be copied.
- Press “SELECT button” to select the destination day of the week.

1, 2

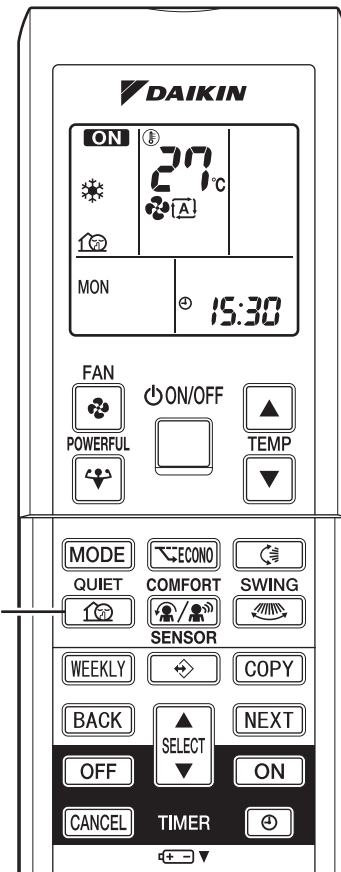

- Press “COPY button”.
  - The reservation will be copied to the selected day of the week. The whole reservation of the selected day of the week will be copied.
  - To continue copying the settings to other days of the week, repeat STEP 4 and STEP 5.
- Press “” button” to complete the setting.
  - “ WEEKLY” is displayed on the LCD and WEEKLY TIMER operation is activated.

### Setting Displays

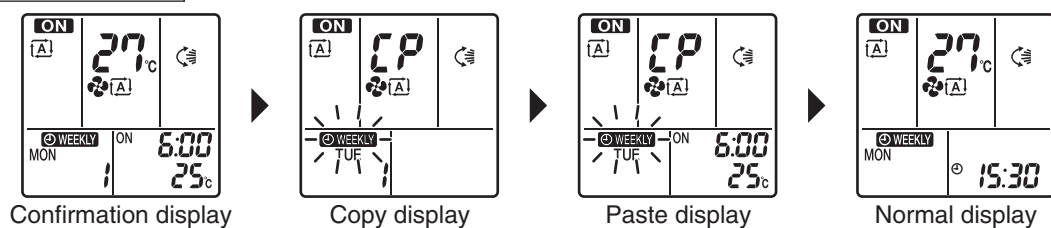



## NOTE

### ■ COPY MODE

- The entire reservation of the source day of the week is copied in the copy mode. In the case of making a reservation change for any day of the week individually after copying the content of weekly reservations, press “ button” and change the settings in the steps of Setting mode.

### ■ Confirming a reservation

- The reservation can be confirmed.
- Press “ button”.
    - The day of the week and the reservation number of the current day will be displayed.
  - Press “SELECT button” to select the day of the week and the reservation number to be confirmed.
    - Pressing the “SELECT button” displays the reservation details.
    - To change the confirmed reserved settings, select the reservation number and press “NEXT button”. The mode is switched to setting mode. Go to Setting mode STEP 4.
  - Press “ button” to exit confirming mode.
    - “ WEEKLY” is displayed on the LCD and WEEKLY TIMER operation is activated.
    - The TIMER lamp lights up.

#### Setting Displays





Normal display

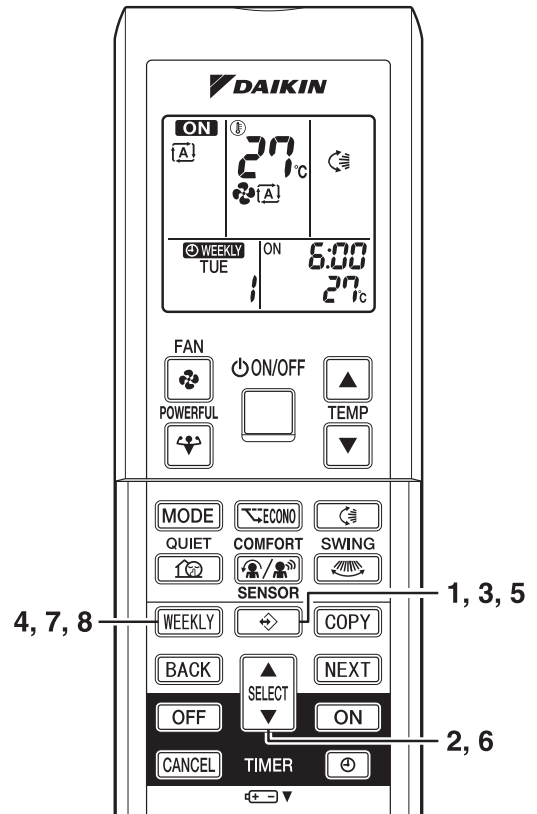

Confirmation display



## ■ To deactivate WEEKLY TIMER operation

4. Press “WEEKLY button” while “ WEEKLY ” is displayed on the LCD.
  - The “ WEEKLY ” will disappear from the LCD.
  - The TIMER lamp goes off.
  - To reactivate the WEEKLY TIMER operation, press the “WEEKLY button” again.
  - If a reservation deactivated with “WEEKLY button” is activated once again, the last reservation mode will be used.

## ■ To delete reservations

### The individual reservation

- Refer to Setting mode.  
When selecting desired mode at STEP 4 in setting mode, select “blank”. The reservation will be deleted.

### The reservations for each day of the week

- This function can be used for deleting reservations for each day of the week.

5. Press “ button”.
6. Select the day of the week to be canceled with the “SELECT button”.
7. Hold the “WEEKLY button” for 5 seconds.
  - The selected reservation will be canceled.

### All reservations

8. Hold “WEEKLY button” for 5 seconds.
  - Be sure to direct the remote control toward the main unit and check for a receiving tone.
  - This operation is not effective while WEEKLY TIMER is being set.
  - All reservations will be deleted.

# Part 6

## Service Diagnosis

1. Caution for Diagnosis.....	70
1.1 Troubleshooting with LED .....	70
2. Problem Symptoms and Measures .....	71
3. Service Check Function .....	72
3.1 ARC452 Series.....	72
4. Troubleshooting .....	75
4.1 Error Codes and Description .....	75
4.2 Indoor Unit PCB Abnormality .....	76
4.3 Freeze-up Protection Control or Heating Peak-cut Control.....	77
4.4 Fan Motor (DC Motor) or Related Abnormality.....	79
4.5 Thermistor or Related Abnormality (Indoor Unit).....	81
4.6 Signal Transmission Error (between Indoor Unit and Outdoor Unit).....	82
4.7 Unspecified Voltage (between Indoor Unit and Outdoor Unit) .....	83
4.8 Outdoor Unit PCB Abnormality.....	84
4.9 OL Activation (Compressor Overload) .....	86
4.10 Compressor Lock .....	87
4.11 DC Fan Lock .....	88
4.12 Input Overcurrent Detection .....	89
4.13 Four Way Valve Abnormality.....	90
4.14 Discharge Pipe Temperature Control.....	92
4.15 High Pressure Control in Cooling .....	94
4.16 Compressor System Sensor Abnormality .....	96
4.17 Position Sensor Abnormality .....	98
4.18 DC Voltage / Current Sensor Abnormality (20/25 Class) .....	101
4.19 CT or Related Abnormality (35 Class).....	102
4.20 Thermistor or Related Abnormality (Outdoor Unit).....	104
4.21 Electrical Box Temperature Rise.....	106
4.22 Radiation Fin Temperature Rise .....	108
4.23 Output Overcurrent Detection .....	110
4.24 Refrigerant Shortage .....	112
4.25 Low-voltage Detection or Over-voltage Detection.....	115
4.26 Signal Transmission Error on Outdoor Unit PCB (35 Class Only).....	117
5. Check .....	118
5.1 How to Check.....	118

# 1. Caution for Diagnosis

## 1.1 Troubleshooting with LED

### Indoor Unit

The operation lamp blinks when any of the following errors is detected.

1. When a protection device of the indoor or outdoor unit is activated, or when the thermistor malfunctions.
  2. When a signal transmission error occurs between the indoor and outdoor units.
- In either case, conduct the diagnostic procedure described in the following pages.

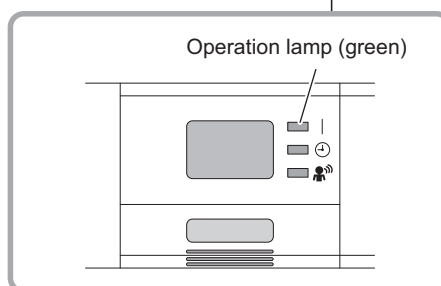
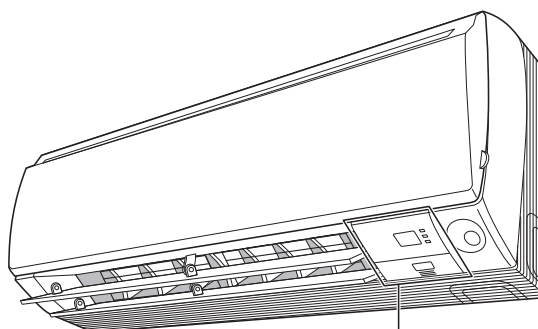

(R12187)

### Outdoor Unit

The outdoor unit has one green LED (LED A) on the PCB. When the LED A blinks, the microcomputer works in order.

## 2. Problem Symptoms and Measures

Symptom	Check Item	Details of Measure	Reference Page
The units does not operate.	Check the power supply.	Check to make sure that the rated voltage is supplied.	—
	Check the type of the indoor units.	Check to make sure that the indoor unit type is compatible with the outdoor unit.	—
	Check the outdoor temperature.	Heating operation cannot be used when the outdoor temperature is 20°C or higher, and cooling operation cannot be used when the outdoor temperature is below -10°C.	—
	Diagnose with remote control indication.	—	75
	Check the remote control addresses.	Check to make sure that address settings for the remote control and indoor unit are correct.	—
Operation sometimes stops.	Check the power supply.	A power failure of 2 to 10 cycles stops air conditioner operation. (Operation lamp OFF)	—
	Check the outdoor temperature.	Heating operation cannot be used when the outdoor temperature is 20°C or higher, and cooling operation cannot be used when the outdoor temperature is below -10°C.	—
	Diagnose with remote control indication.	—	75
The unit operates but does not cool, or does not heat.	Check for wiring and piping errors in the connection between the indoor and outdoor units.	Conduct the wiring/piping error check described on the product diagnosis label.	—
	Check for thermistor detection errors.	Check to make sure that the thermistor is mounted securely.	—
	Check for faulty operation of the electronic expansion valve.	Set the units to cooling operation, and check the temperature of the liquid pipe to see if the electronic expansion valve works.	—
	Diagnose with remote control indication.	—	75
	Diagnose by service port pressure and operating current.	Check for refrigerant shortage.	112
Large operating noise and vibrations	Check the output voltage of the power module.	—	123
	Check the power module.	—	—
	Check the installation condition.	Check to make sure that the required spaces for installation (specified in the installation manual, etc.) are provided.	—

### 3. Service Check Function

#### 3.1 ARC452 Series

- Check Method 1**
1. When the timer cancel button is held down for 5 seconds, “00” indication appears on the temperature display section.

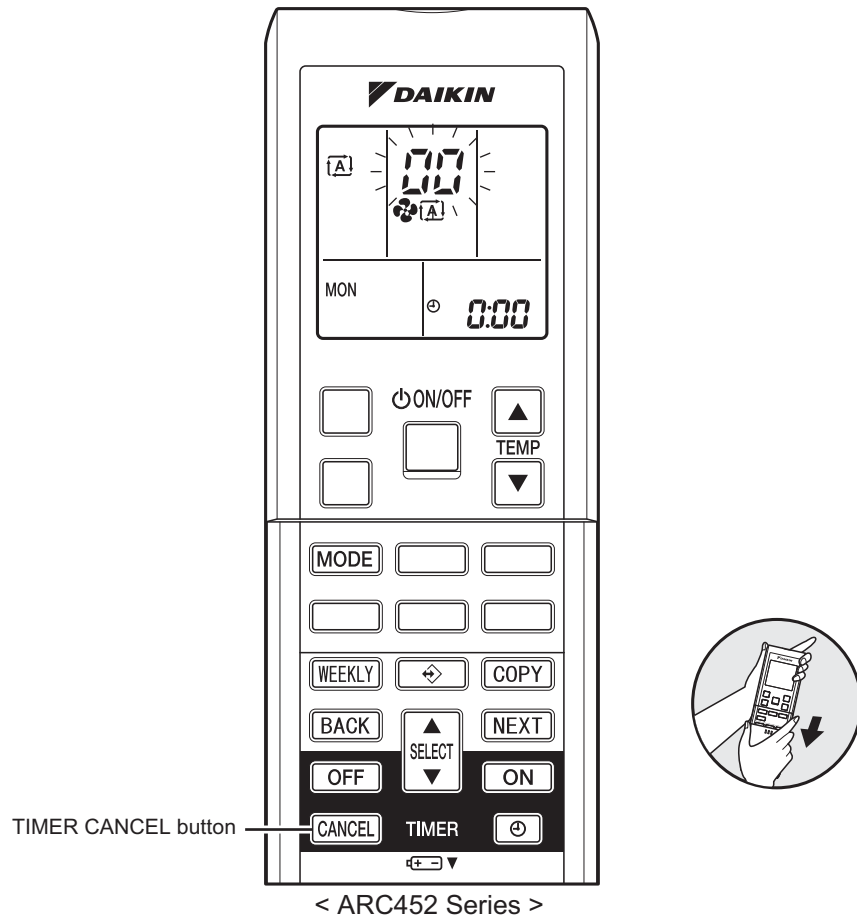

(R12205)

2. Press the timer cancel button repeatedly until a long beep sounds.
  - The code indication changes in the sequence shown below.

No.	Code	No.	Code	No.	Code
1	00	13	C7	25	UR
2	U4	14	R3	26	UH
3	L5	15	H8	27	P4
4	E6	16	H9	28	L3
5	H6	17	C9	29	L4
6	HD	18	C4	30	H7
7	R6	19	C5	31	U2
8	E7	20	J3	32	ER
9	U0	21	J6	33	RH
10	F3	22	E5	34	FR
11	R5	23	R1		
12	F6	24	E1		

- i Note:**
1. A short beep “pi” and two consecutive beeps “pi pi” indicate non-corresponding codes.
  2. To return to the normal mode, hold the timer cancel button down for 5 seconds. When the remote control is left untouched for 60 seconds, it also returns to the normal mode.

## Check Method 2

1. Press the 3 buttons (TEMP▲, TEMP▼, MODE) at the same time.

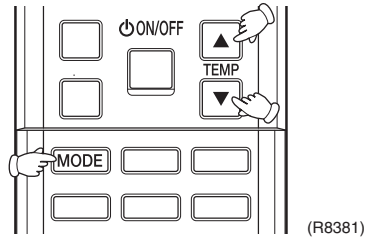

The figure of the ten's place blinks.

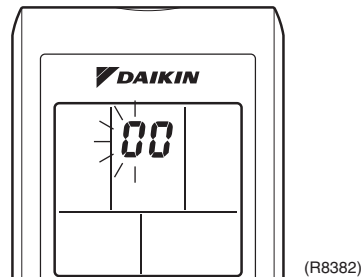

2. Press the TEMP▲ or ▼ button and change the figure until you hear the sound of "beep" or "pi pi".

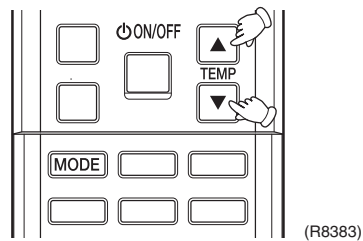

3. Diagnose by the sound.
  - ★"pi" : The figure of the ten's place does not accord with the error code.
  - ★"pi pi" : The figure of the ten's place accords with the error code but the one's not.
  - ★"beep" : The both figures of the ten's and one's place accord with the error code.
 (→ See 7.)

4. Press the MODE button.

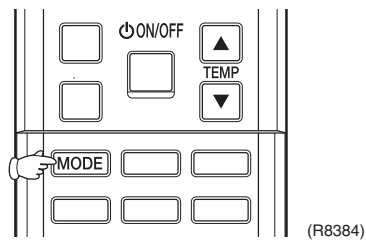

The figure of the one's place blinks.

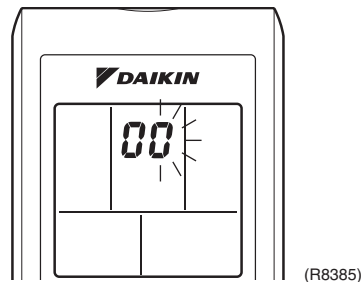



5. Press the TEMP▲ or ▼ button and change the figure until you hear the sound of “beep”.

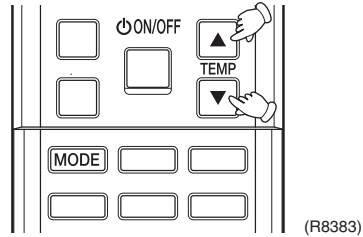

6. Diagnose by the sound.
- ★“pi” : The figure of the ten’s place does not accord with the error code.
  - ★“pi pi” : The figure of the ten’s place accords with the error code but the one’s not.
  - ★“beep” : The both figures of the ten’s and one’s place accord with the error code.
7. Determine the error code.  
The figures indicated when you hear the “beep” sound are error code.  
(Error codes and description → Refer to page 75.)
8. Press the MODE button to exit from the diagnosis mode.

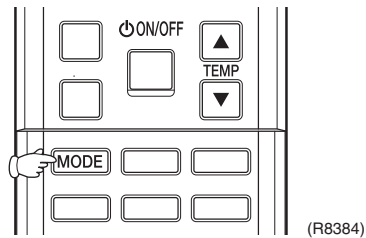

The display “?” means the trial operation mode.  
(Refer to page 267 for trial operation.)

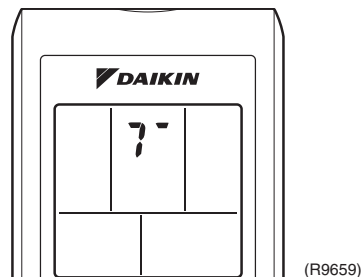

9. Press the ON/OFF button twice to return to the normal mode.

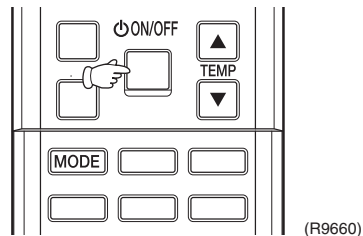

**Note:** When the remote control is left untouched for 60 seconds, it returns to the normal mode.

## 4. Troubleshooting

### 4.1 Error Codes and Description

	Error Codes	Description	Reference Page
System	<i>00</i>	Normal	—
	<i>U0</i> ★	Refrigerant shortage	112
	<i>U2</i>	Low-voltage detection or over-voltage detection	115
	<i>U4</i>	Signal transmission error (between indoor unit and outdoor unit)	82
	<i>UR</i>	Unspecified voltage (between indoor unit and outdoor unit)	83
Indoor Unit	<i>R1</i>	Indoor unit PCB abnormality	76
	<i>R5</i>	Freeze-up protection control or heating peak-cut control	77
	<i>R6</i>	Fan motor (DC motor) or related abnormality	79
	<i>C4</i>	Indoor heat exchanger thermistor or related abnormality	81
	<i>C9</i>	Room temperature thermistor or related abnormality	81
Outdoor Unit	<i>E1</i>	Outdoor unit PCB abnormality	84
	<i>E5</i> ★	OL activation (compressor overload)	86
	<i>E6</i> ★	Compressor lock	87
	<i>E7</i>	DC fan lock	88
	<i>E8</i>	Input overcurrent detection	89
	<i>ER</i>	Four way valve abnormality	90
	<i>F3</i>	Discharge pipe temperature control	92
	<i>F6</i>	High pressure control in cooling	94
	<i>H0</i>	Compressor system sensor abnormality	96
	<i>H6</i>	Position sensor abnormality	98
	<i>H8</i>	DC voltage / current sensor abnormality (20/25 class)	101
		CT or related abnormality (35 class)	102
	<i>H9</i>	Outdoor temperature thermistor or related abnormality	104
	<i>J3</i>	Discharge pipe thermistor or related abnormality	104
	<i>J6</i>	Outdoor heat exchanger thermistor or related abnormality	104
	<i>L3</i>	Electrical box temperature rise	106
	<i>L4</i>	Radiation fin temperature rise	108
	<i>L5</i>	Output overcurrent detection	110
	<i>P4</i>	Radiation fin thermistor or related abnormality	104
	<i>U7</i>	Signal transmission error on outdoor unit PCB (35 class only)	117

★: Displayed only when system-down occurs.

## 4.2 Indoor Unit PCB Abnormality

Remote Control Display *A1*

**Method of Malfunction Detection** Evaluation of zero-cross detection of power supply by the indoor unit PCB.

**Malfunction Decision Conditions** There is no zero-cross detection in approximately 10 seconds.

- Supposed Causes**
- Wrong models interconnected
  - Defective indoor unit PCB
  - Disconnection of connector

### Troubleshooting

 **Caution** Be sure to turn off the power switch before connecting or disconnecting connectors, or parts may be damaged.

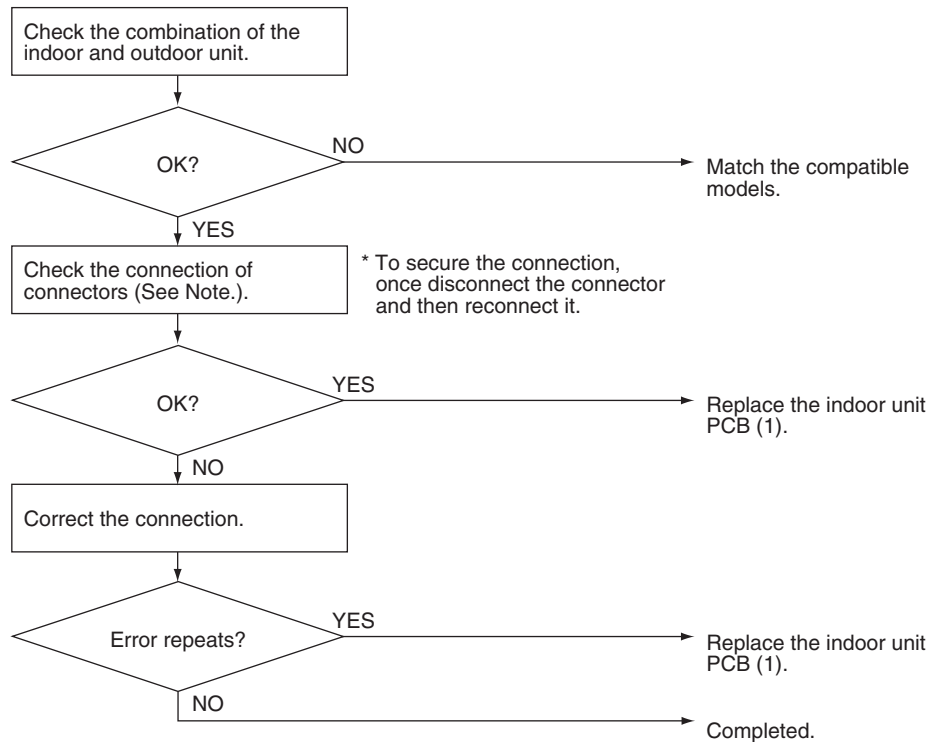

(R11704)

 **Note:** Check the following connector.

Model Type	Connector
Wall Mounted Type	Terminal board ~ Control PCB

## 4.3 Freeze-up Protection Control or Heating Peak-cut Control

Remote Control *RS*  
Display

### Method of Malfunction Detection

- Freeze-up protection control  
During cooling operation, the freeze-up protection control (operation halt) is activated according to the temperature detected by the indoor heat exchanger thermistor.
- Heating peak-cut control  
During heating operation, the temperature detected by the indoor heat exchanger thermistor is used for the heating peak-cut control (operation halt, outdoor fan stop, etc.)

### Malfunction Decision Conditions

- Freeze-up protection control  
During cooling operation, the indoor heat exchanger temperature is below 0°C.
- Heating peak-cut control  
During heating operation, the indoor heat exchanger temperature is above 65°C

### Supposed Causes

- Short-circuited air
- Clogged air filter of the indoor unit
- Dust accumulation on the indoor heat exchanger
- Defective indoor heat exchanger thermistor
- Defective indoor unit PCB

Troubleshooting



**Check No.06**  
Refer to P.120



**Caution** Be sure to turn off the power switch before connecting or disconnecting connectors, or parts may be damaged.

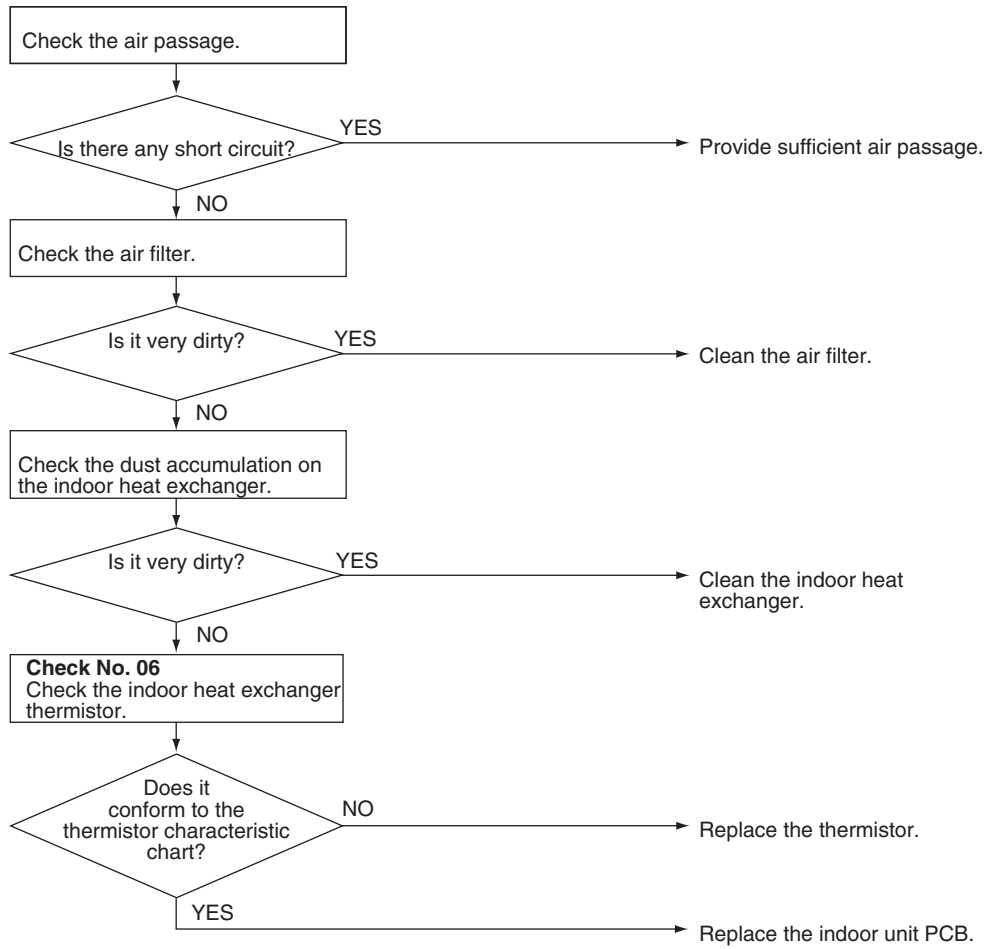

(R7131)

## 4.4 Fan Motor (DC Motor) or Related Abnormality

---

Remote Control  
Display

*AB*

---

Method of  
Malfunction  
Detection

The rotation speed detected by the Hall IC during fan motor operation is used to determine abnormal fan motor operation.

---

Malfunction  
Decision  
Conditions

The detected rotation speed does not reach the demanded rotation speed of the target tap, and is less than 50% of the maximum fan motor rotation speed.

---

Supposed  
Causes

- Layer short inside the fan motor winding
- Breaking of wire inside the fan motor
- Breaking of the fan motor lead wires
- Defective capacitor of the fan motor
- Defective indoor unit PCB

Troubleshooting



**Check No.01**  
Refer to P.118



**Caution**

Be sure to turn off the power switch before connecting or disconnecting connectors, or parts may be damaged.

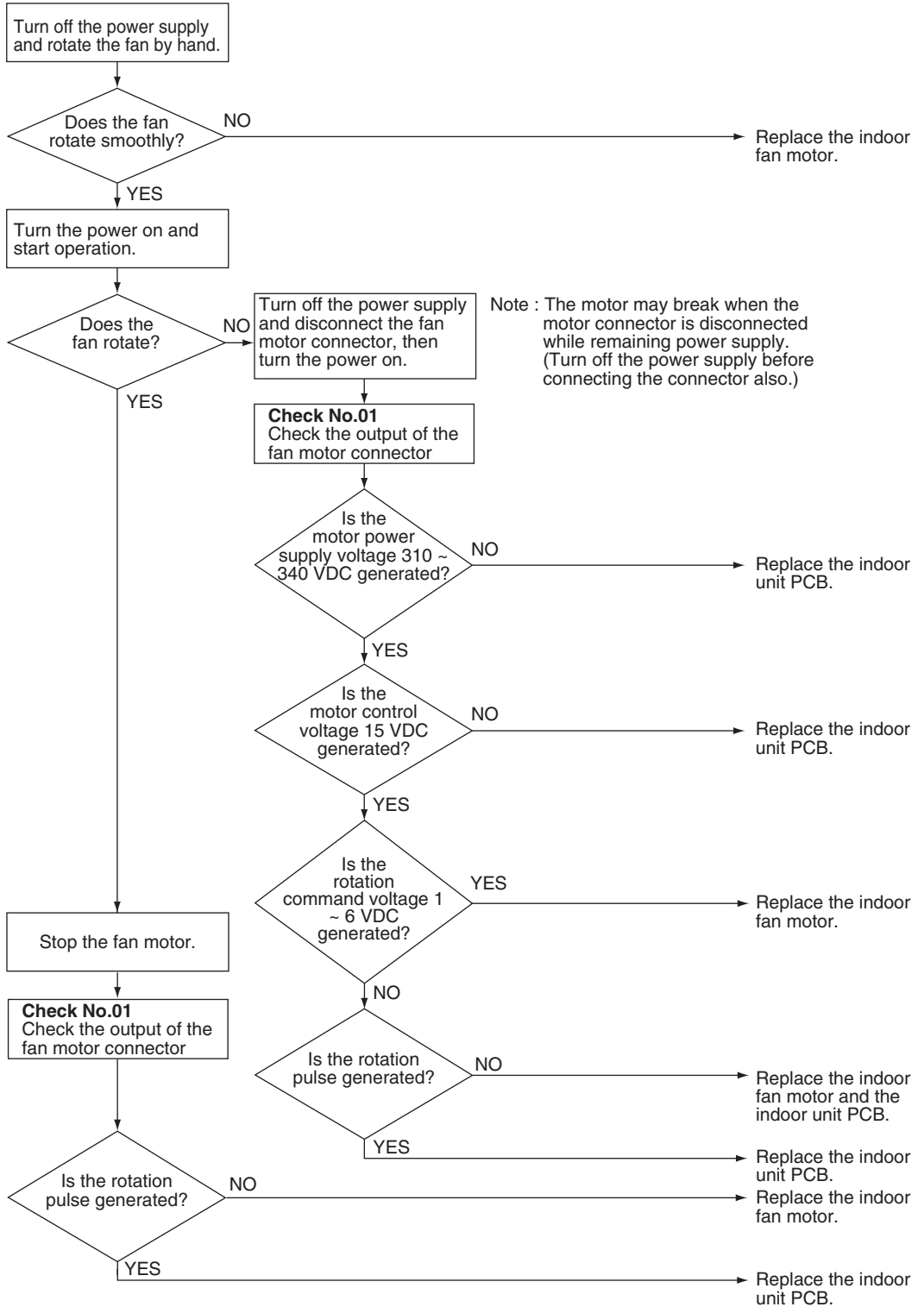

(R12033)

## 4.5 Thermistor or Related Abnormality (Indoor Unit)

Remote Control Display  $\mathcal{L}4, \mathcal{L}9$

### Method of Malfunction Detection

The temperatures detected by the thermistors determine thermistor errors.

### Malfunction Decision Conditions

The thermistor input is more than 4.96 V or less than 0.04 V during compressor operation.

### Supposed Causes

- Disconnection of connector
- Defective thermistor
- Defective indoor unit PCB

### Troubleshooting



Check No.06  
Refer to P.120



#### Caution

Be sure to turn off the power switch before connecting or disconnecting connectors, or parts may be damaged.

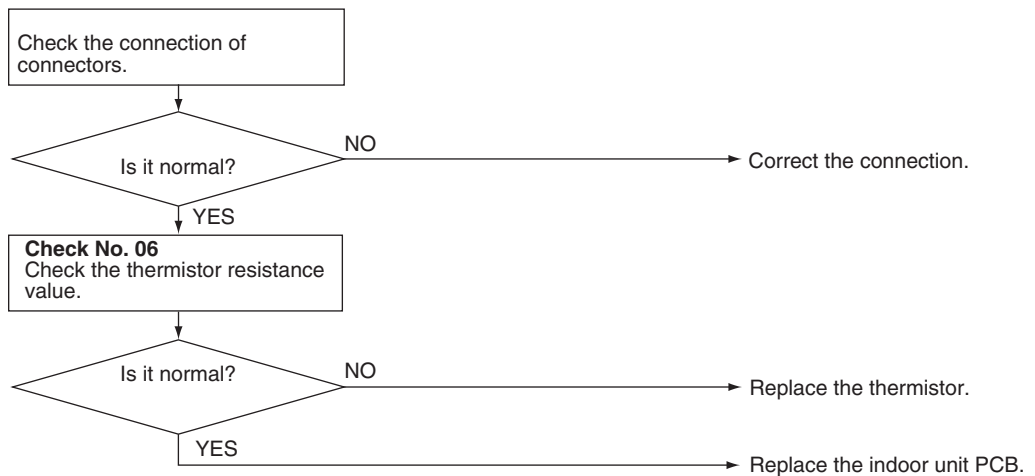

(R7134)

$\mathcal{L}4$  : Indoor heat exchanger thermistor

$\mathcal{L}9$  : Room temperature thermistor



## 4.6 Signal Transmission Error (between Indoor Unit and Outdoor Unit)

Remote Control Display

U4

Method of Malfunction Detection

The data received from the outdoor unit in indoor unit-outdoor unit signal transmission is checked whether it is normal.

Malfunction Decision Conditions

The data sent from the outdoor unit cannot be received normally, or the content of the data is abnormal.

Supposed Causes

- Wiring error
- Breaking of the connection wires between the indoor and outdoor units (wire No. 3)
- Defective outdoor unit PCB
- Defective indoor unit PCB
- Disturbed power supply waveform

### Troubleshooting



Check No.10  
Refer to P.122



**Caution**

Be sure to turn off the power switch before connecting or disconnecting connectors, or parts may be damaged.

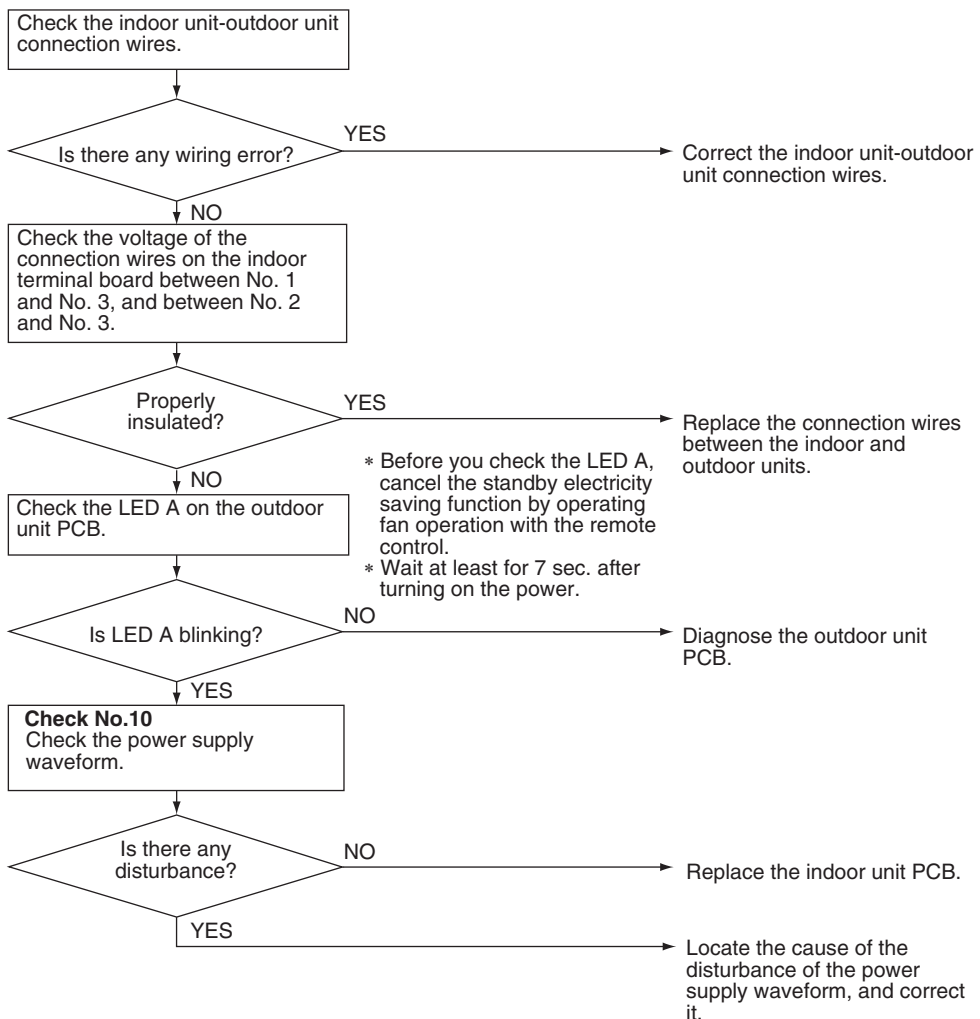

(R12160)

## 4.7 Unspecified Voltage (between Indoor Unit and Outdoor Unit)

Remote Control Display

*UR*

Method of Malfunction Detection

The supply power is detected for its requirements (different from pair type and multi type) by the indoor / outdoor transmission signal.

Malfunction Decision Conditions

The pair type and multi type are interconnected.

Supposed Causes

- Wrong models interconnected
- Wrong wiring of connecting wires
- Wrong indoor unit PCB or outdoor unit PCB mounted
- Defective indoor unit PCB
- Defective outdoor unit PCB

### Troubleshooting

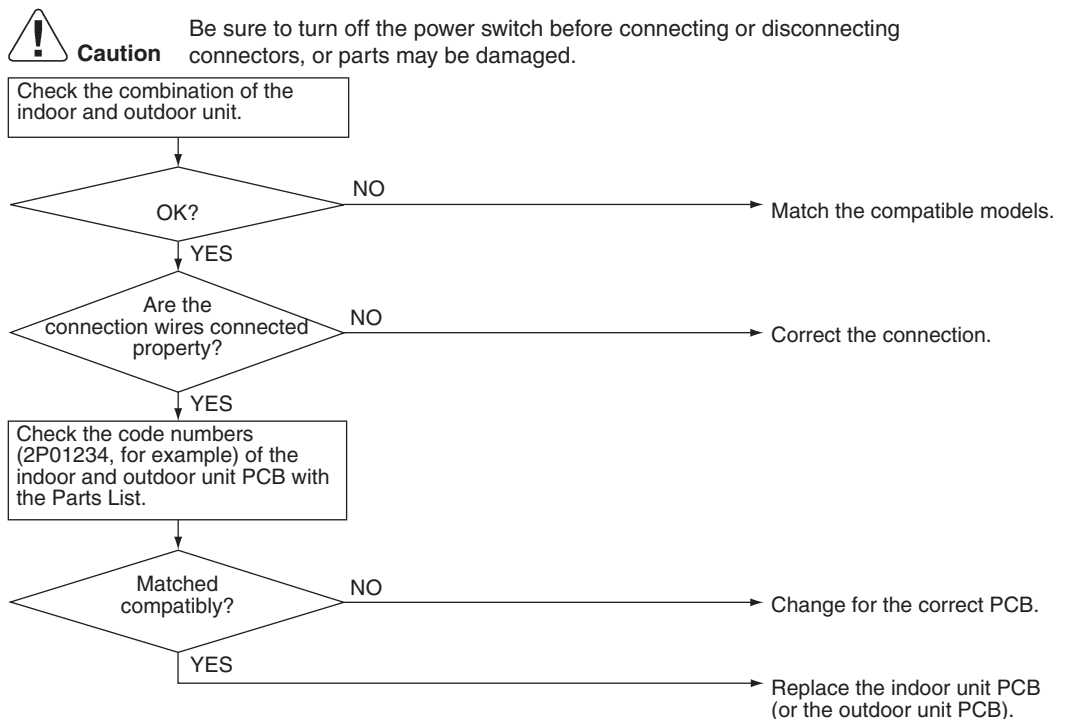

(R11707)

## 4.8 Outdoor Unit PCB Abnormality

Remote Control Display

E1

Method of Malfunction Detection

- The system follows the microprocessor program as specified.
- The system checks to see if the zero-cross signal comes in properly.

Malfunction Decision Conditions

- The microprocessor program runs out of control.
- The zero-cross signal is not detected.

Supposed Causes

- Defective outdoor unit PCB
- Broken harness between PCBs
- Noise
- Momentary fall of voltage
- Momentary power failure, etc.

Troubleshooting

20/35 class

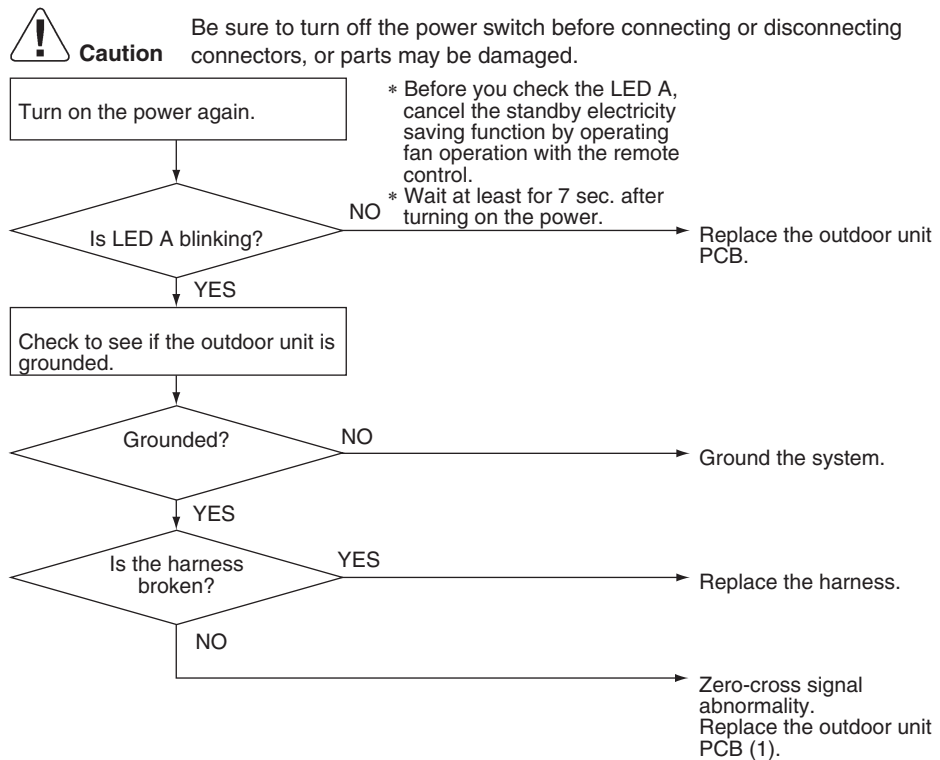

(R12161)

Troubleshooting 25 class

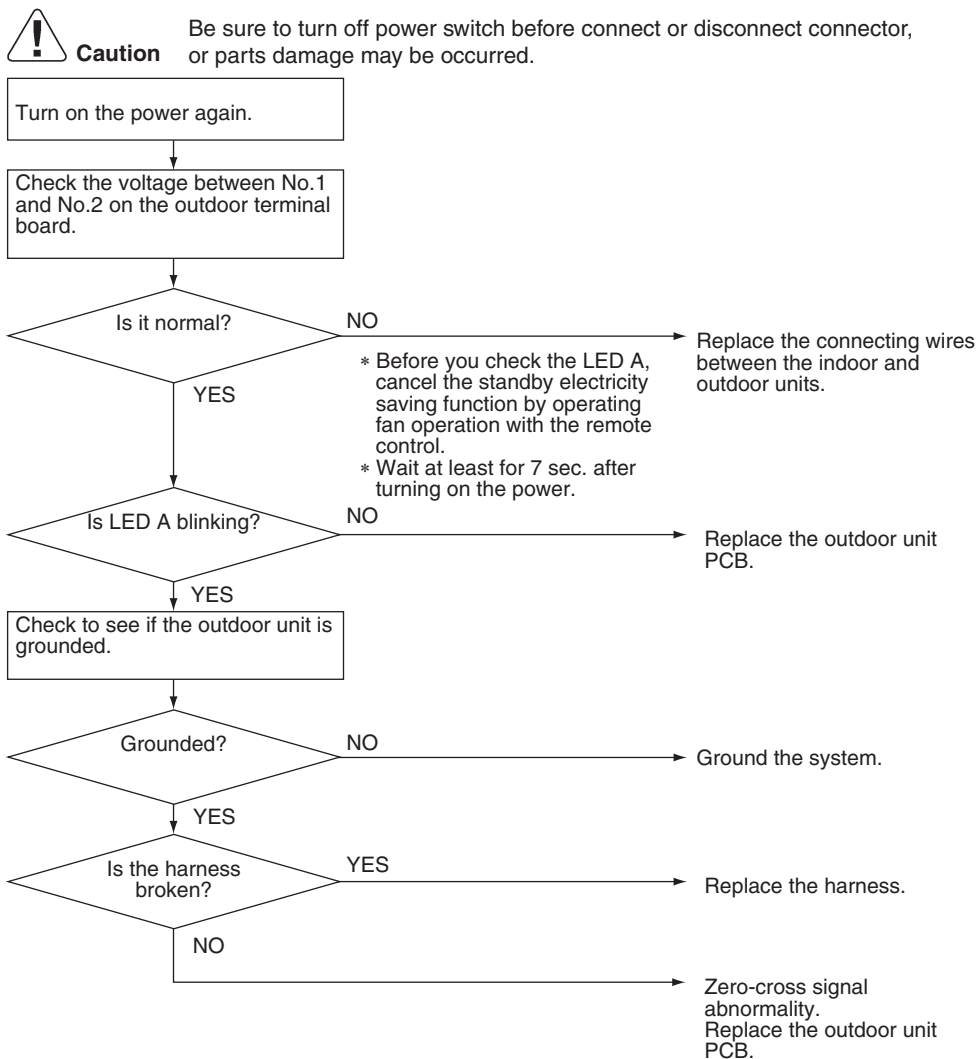

(R12188)

## 4.9 OL Activation (Compressor Overload)





Remote Control Display **E5**

Method of Malfunction Detection  
A compressor overload is detected through compressor OL.

Malfunction Decision Conditions  
 ■ If the error repeats twice, the system is shut down.  
 ■ Reset condition: Continuous run for about 60 minutes without any other error  
 \* The operating temperature condition is not specified.

Supposed Causes  
 ■ Defective discharge pipe thermistor  
 ■ Defective electronic expansion valve or coil  
 ■ Defective four way valve or coil  
 ■ Defective outdoor unit PCB  
 ■ Refrigerant shortage  
 ■ Water mixed in refrigerant  
 ■ Defective stop valve

### Troubleshooting

-  **Check No.04**  
Refer to P.118
-  **Check No.05**  
Refer to P.119
-  **Check No.06**  
Refer to P.120
-  **Check No.11**  
Refer to P.122

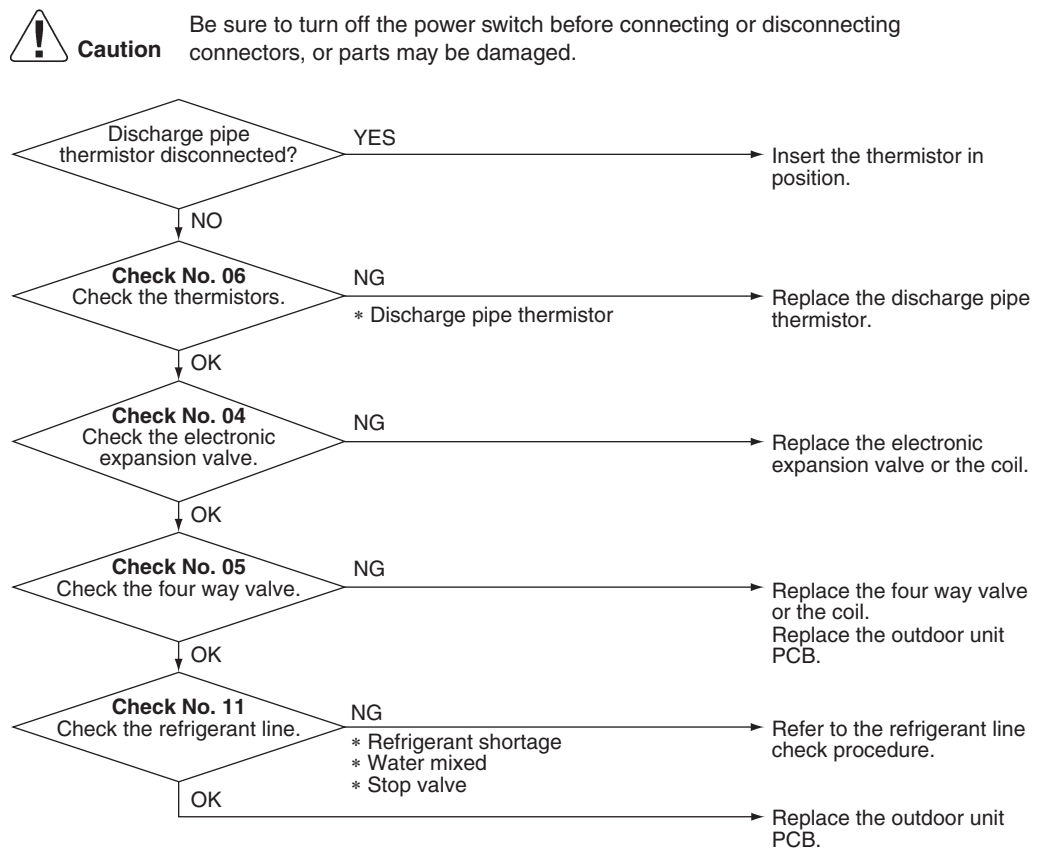

## 4.10 Compressor Lock

Remote Control  
Display

**EE**

Method of  
Malfunction  
Detection

A compressor lock is detected by checking the compressor running condition through the position detection circuit.

Malfunction  
Decision  
Conditions

### 20/25 class

- Operation stops due to overcurrent.
- If the error repeats 16 times, the system is shut down.
- Reset condition: Continuous run for about 11 minutes without any other error

### 35 class

- A compressor lock is detected by the current waveform generated when applying high-frequency voltage to the motor.
- If the error repeats 16 times, the system is shut down
- Reset condition: Continuous run for about 5 minutes without any other error

Supposed  
Causes

- Compressor locked
- Compressor harness disconnected

Troubleshooting



### Caution

Be sure to turn off the power switch before connecting or disconnecting connectors, or parts may be damaged.

(Precaution before turning on the power again)

Make sure the power has been off for at least 30 seconds.

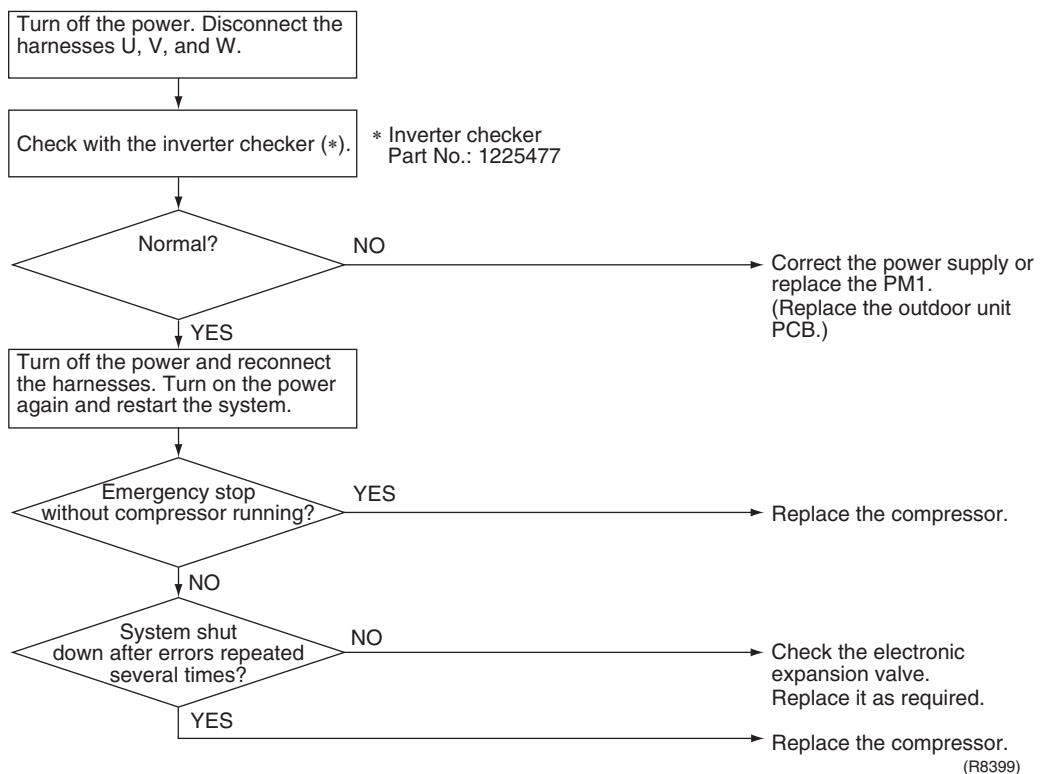

# 4.11 DC Fan Lock

Remote Control Display **E7**

**Method of Malfunction Detection** An error is determined with the high-voltage fan motor rotation speed detected by the Hall IC.

- Malfunction Decision Conditions**
- The fan does not start in 15 ~ 60 seconds (depending on the model) even when the fan motor is running.
  - If the error repeats 16 times, the system is shut down.
  - Reset condition: Continuous run for about 11 minutes (35 class: 5 minutes) without any other error

- Supposed Causes**
- Disconnection of the fan motor
  - Foreign matters stuck in the fan
  - Defective fan motor
  - Defective outdoor unit PCB

**Troubleshooting**

  
**Check No.15**  
 Refer to P.124

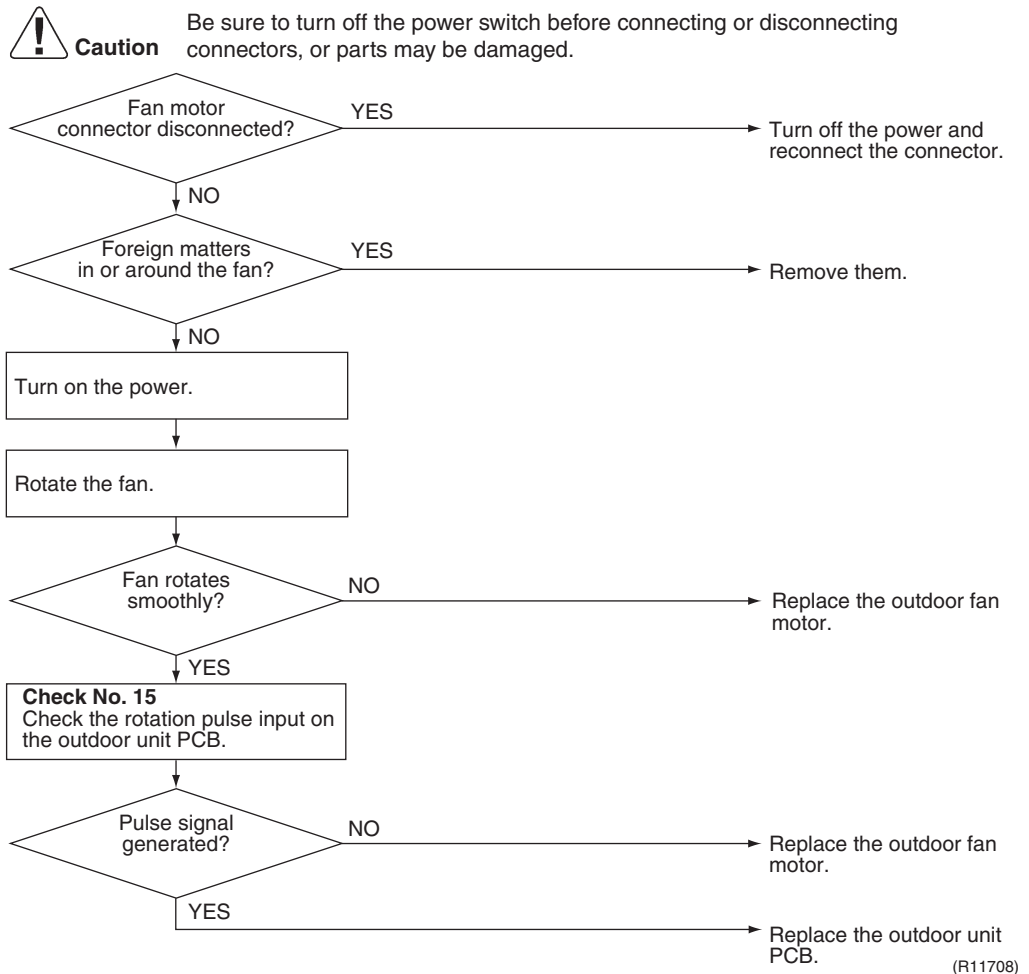

## 4.12 Input Overcurrent Detection

Remote Control  
Display

EE

Method of  
Malfunction  
Detection

An input overcurrent is detected by checking the input current value with the compressor running.

Malfunction  
Decision  
Conditions

- The following current with the compressor running continues for 2.5 seconds.  
Cooling / Heating: Above 9.25 ~ 20 A (Refer to "Input current control" on page 40 for detail.)

Supposed  
Causes

- Defective compressor
- Defective power module
- Defective outdoor unit PCB
- Short circuit

### Troubleshooting



**Check No.07**  
Refer to P.121



**Check No.08**  
Refer to P.121



#### Caution

Be sure to turn off the power switch before connecting or disconnecting connectors, or parts may be damaged.

\* An input overcurrent may result from wrong internal wiring. If the wires have been disconnected and reconnected for part replacement, for example, and the system is interrupted by an input overcurrent, take the following procedure.

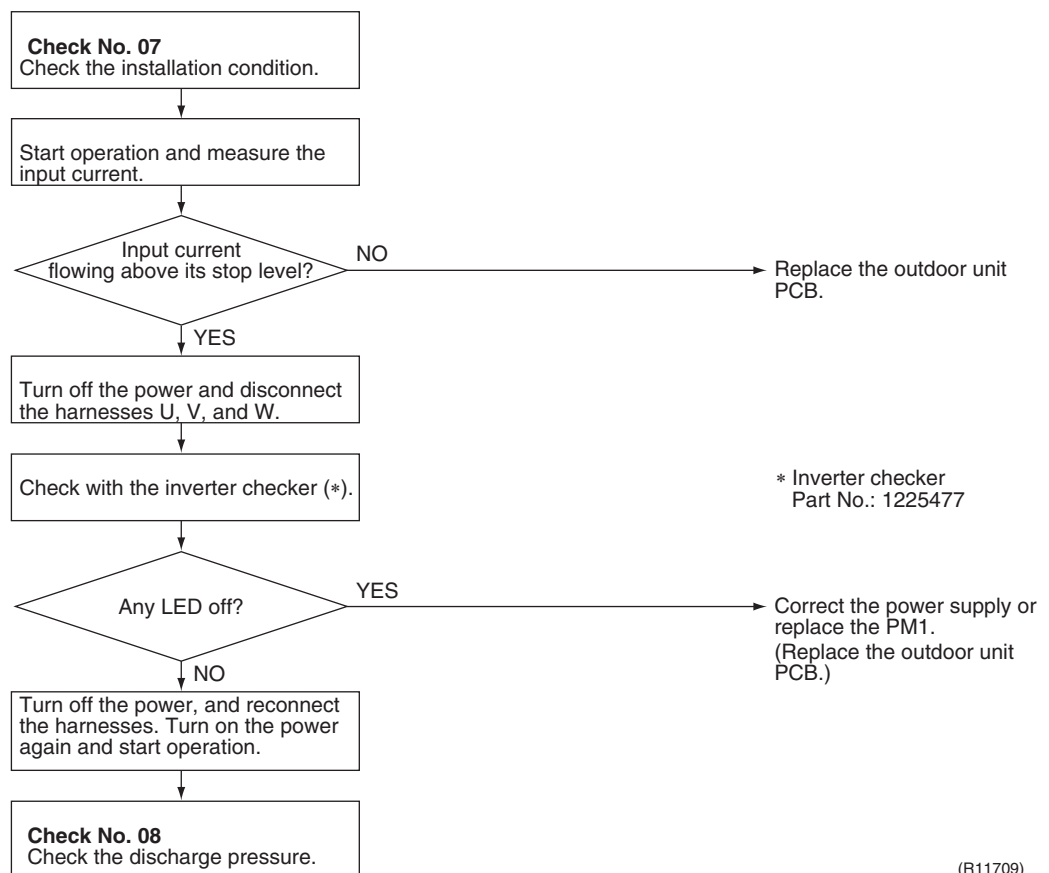



## 4.13 Four Way Valve Abnormality

Remote Control  
Display

*EA*

Method of  
Malfunction  
Detection

The room temperature thermistor, the indoor heat exchanger thermistor, the outdoor temperature thermistor, and the outdoor heat exchanger thermistor are checked if they function within their normal ranges in each operation mode.

Malfunction  
Decision  
Conditions

A following condition continues over 1 ~ 10 minutes (depending on the model) after operating for 5 ~ 10 minutes (depending on the model).

- Cooling / Dry  
(room thermistor temp. – indoor heat exchanger temp.) < –5°C
- Heating  
(indoor heat exchanger temp. – room thermistor temp.) < –5°C
- If the error repeats, the system is shut down.
- Reset condition: Continuous run for about 60 minutes without any other error

Supposed  
Causes

- Disconnection of four way valve coil
- Defective four way valve, coil, or harness
- Defective outdoor unit PCB
- Defective thermistor
- Refrigerant shortage
- Water mixed in refrigerant
- Defective stop valve

## Troubleshooting



**Check No.05**  
Refer to P.119



**Check No.06**  
Refer to P.120



**Check No.11**  
Refer to P.122

**Caution**

Be sure to turn off the power switch before connecting or disconnecting connectors, or parts may be damaged.

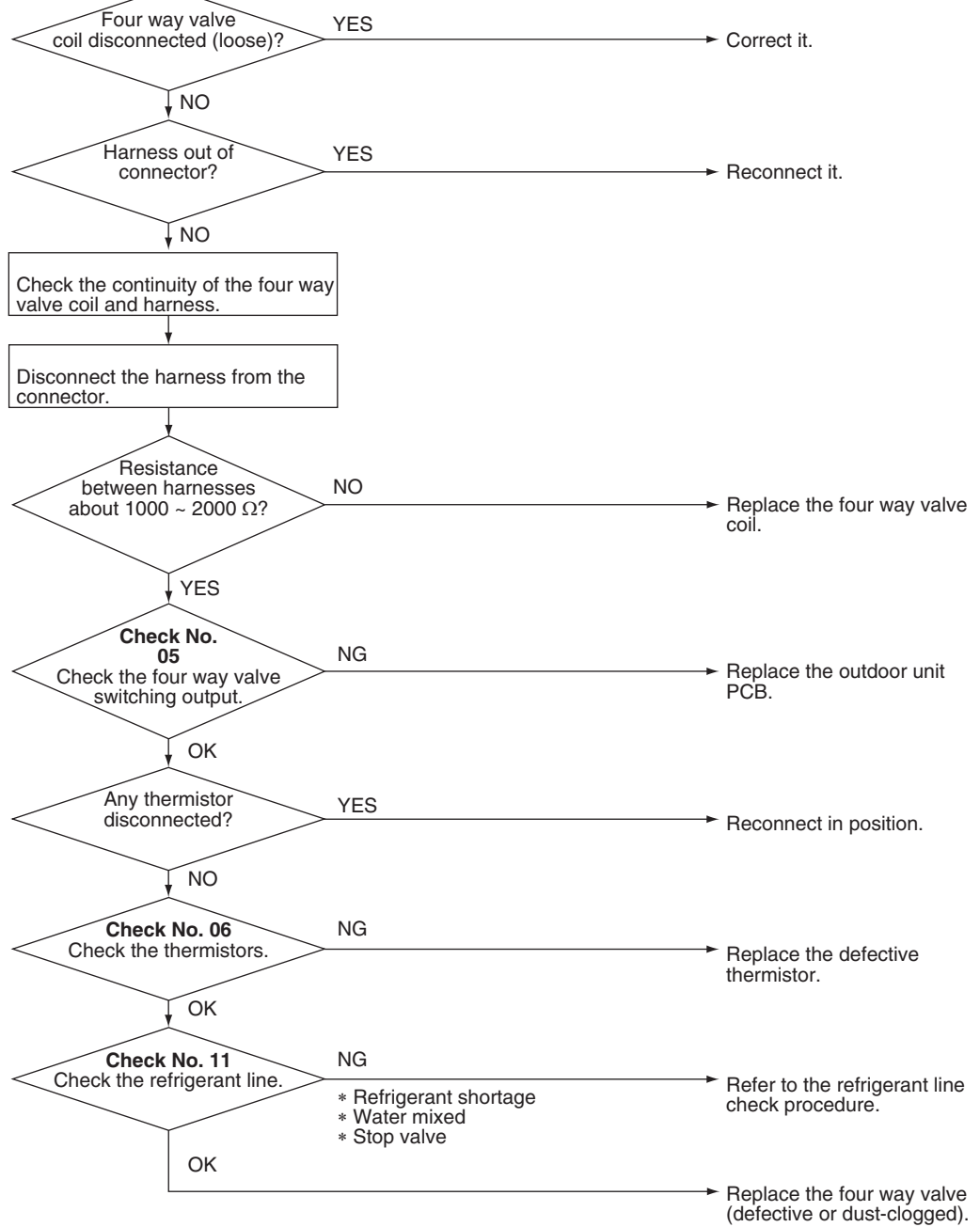

(R11710)

## 4.14 Discharge Pipe Temperature Control

Remote Control Display

**F3**

Method of Malfunction Detection

An error is determined with the temperature detected by the discharge pipe thermistor.

Malfunction Decision Conditions

- If the temperature detected by the discharge pipe thermistor rises above  $A$  °C, the compressor stops.
- The error is cleared when the discharge pipe temperature has dropped below  $B$  °C.

**<20 class>**

Stop temperatures	A (°C)	B (°C)
(1) above 45 Hz (rising), above 40 Hz (dropping)	110	97
(2) 30 ~ 45 Hz (rising), 25 ~ 40 Hz (dropping)	105	92
(3) below 30 Hz (rising), below 25 Hz (dropping)	99	86

**<25 class>**

Stop temperatures	A (°C)	B (°C)
(1) above 30Hz (rising), above 25Hz (dropping)	110	95
(2) below 30Hz (rising), below 25Hz (dropping)	108	93

**<35 class>**

A (°C)	B (°C)
110	95

- If the error repeats, the system is shut down.
- Reset condition: Continuous run for about 60 minutes without any other error

Supposed Causes

- Defective discharge pipe thermistor  
(Defective outdoor heat exchanger thermistor or outdoor temperature thermistor)
- Defective electronic expansion valve or coil
- Refrigerant shortage
- Defective four way valve
- Water mixed in refrigerant
- Defective stop valve
- Defective outdoor unit PCB

Troubleshooting



Check No.04  
Refer to P.118



Check No.06  
Refer to P.120



Check No.11  
Refer to P.122



**Caution** Be sure to turn off the power switch before connecting or disconnecting connectors, or parts may be damaged.

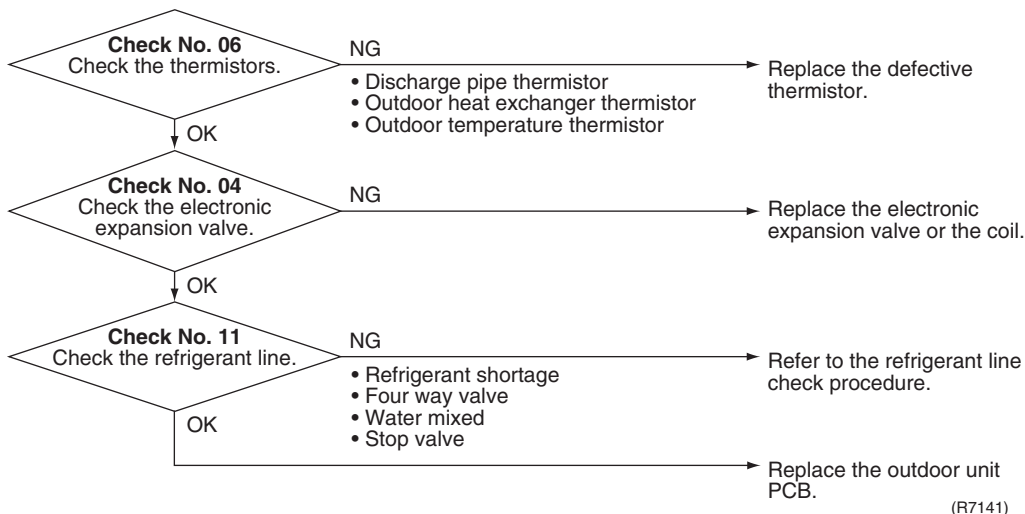

(R7141)

## 4.15 High Pressure Control in Cooling

Remote Control Display

*F6*

Method of Malfunction Detection

High-pressure control (operation halt, frequency drop, etc.) is activated in cooling operation if the temperature sensed by the outdoor heat exchanger thermistor exceeds the limit.

Malfunction Decision Conditions

- The temperature sensed by the outdoor heat exchanger thermistor rises above  $\text{A}^{\circ}\text{C}$ .
- The error is cleared when the temperature drops below  $\text{B}^{\circ}\text{C}$ .

	$\text{A}^{\circ}\text{C}$	$\text{B}^{\circ}\text{C}$
RXL20G2V1B	65	54
RXL20G2V1B9	65	52
RXL25G2V1B	65	53
RXL35G2V1B	65	51

Supposed Causes

- The installation space is not large enough.
- Dirty outdoor heat exchanger
- Defective outdoor fan motor
- Defective stop valve
- Defective electronic expansion valve or coil
- Defective outdoor heat exchanger thermistor
- Defective outdoor unit PCB

Troubleshooting

  
**Check No.04**  
 Refer to P.118

  
**Check No.06**  
 Refer to P.120

  
**Check No.07**  
 Refer to P.121

  
**Check No.08**  
 Refer to P.121

  
**Check No.09**  
 Refer to P.122

 **Caution** Be sure to turn off the power switch before connecting or disconnecting connectors, or parts may be damaged.

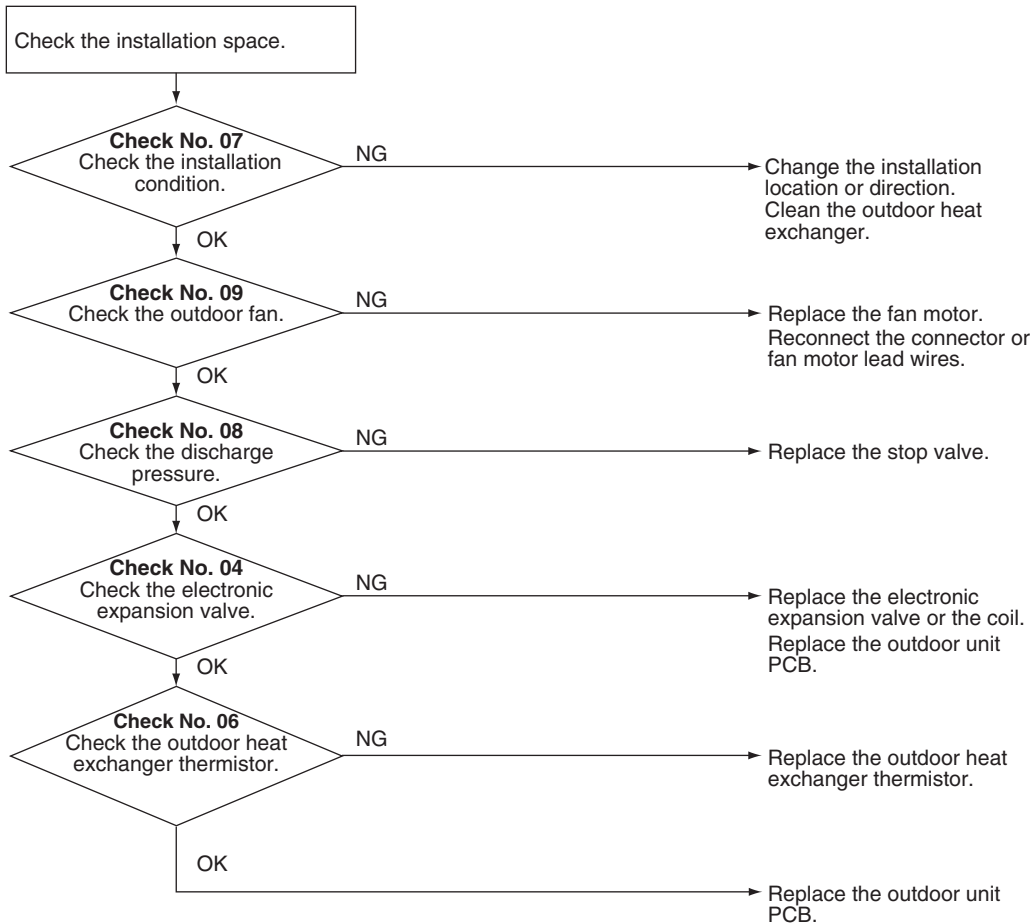

(R11897)

## 4.16 Compressor System Sensor Abnormality

### 4.16.1 20/25 Class

<b>Remote Control Display</b>	<i>HO</i>
<b>Method of Malfunction Detection</b>	<ul style="list-style-type: none"> <li>■ The system checks the DC current before the compressor starts.</li> </ul>
<b>Malfunction Decision Conditions</b>	<ul style="list-style-type: none"> <li>■ The DC current before compressor start-up is out of the range 0.5 ~ 4.5 V (sensor output converted to voltage value)</li> <li>■ The DC voltage before compressor start-up is below 50 V.</li> </ul>
<b>Supposed Causes</b>	<ul style="list-style-type: none"> <li>■ Broken or disconnection of harness</li> <li>■ Defective outdoor unit PCB</li> </ul>

#### Troubleshooting

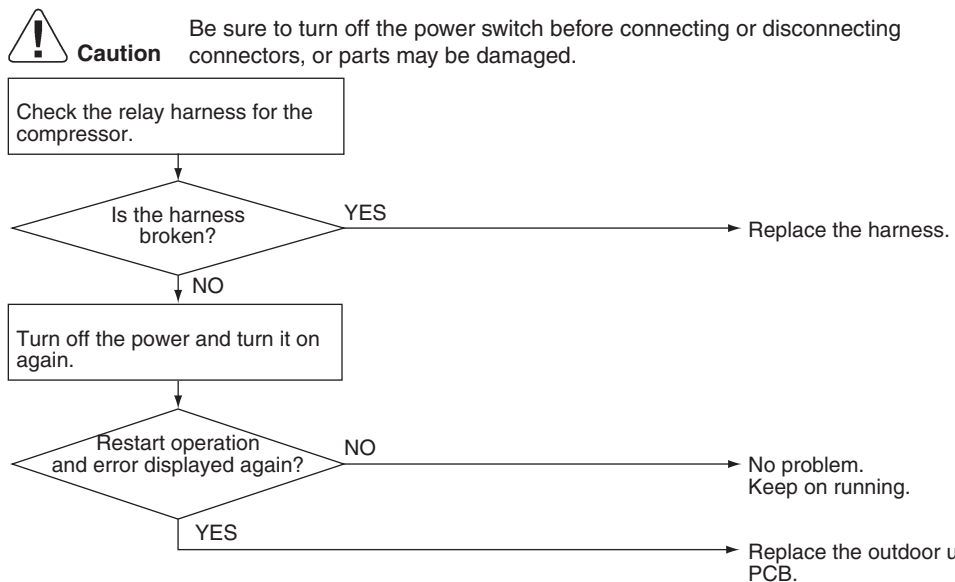

(R11712)

## 4.16.2 35 Class

Remote Control  
Display

*HO*

Method of  
Malfunction  
Detection

- The system checks the supply voltage and the DC voltage before the compressor starts.
- The system checks the compressor current right after the compressor starts.

Malfunction  
Decision  
Conditions

- The supply voltage and the DC voltage is obviously low or high.
- The compressor current does not run when the compressor starts.

Supposed  
Causes

- Disconnection of reactor
- Disconnection of compressor harness
- Defective outdoor unit PCB
- Defective compressor

### Troubleshooting

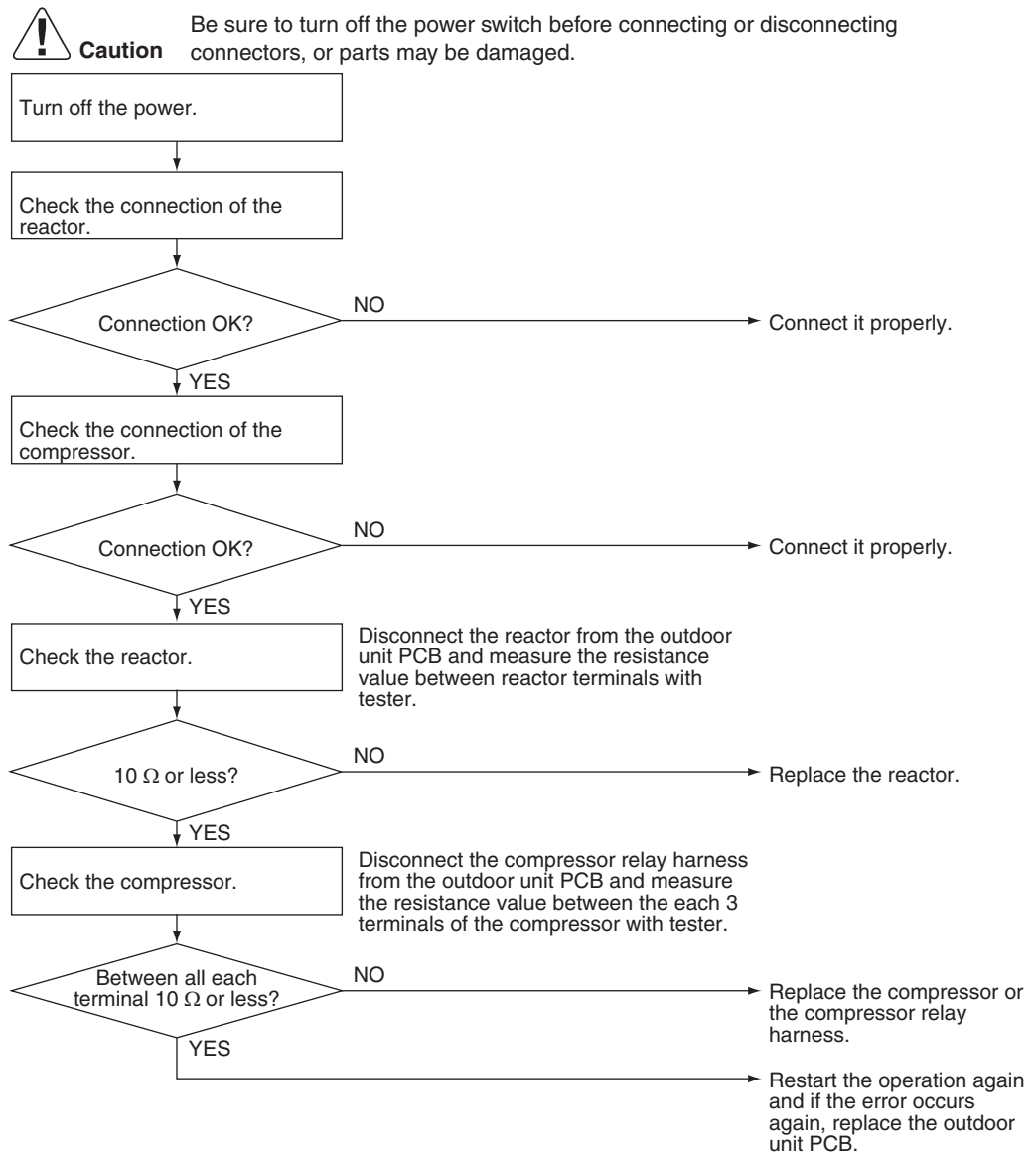

(R7174)



## 4.17 Position Sensor Abnormality

---

Remote Control  
Display

*H6*

---

Method of  
Malfunction  
Detection

A compressor start-up failure is detected by checking the compressor running condition through the position detection circuit.

---

Malfunction  
Decision  
Conditions

- If the error repeats, the system is shut down.
  - Reset condition: Continuous run for about 11 minutes (35 class: 5 minutes) without any other error
- 

Supposed  
Causes

- Disconnection of the compressor relay cable
- Defective compressor
- Defective outdoor unit PCB
- Start-up failure caused by the closed stop valve
- Input voltage is out of specification

## Troubleshooting

20/25 class



Check No.29  
Refer to P.125

**Caution**

Be sure to turn off the power switch before connecting or disconnecting connectors, or parts may be damaged.

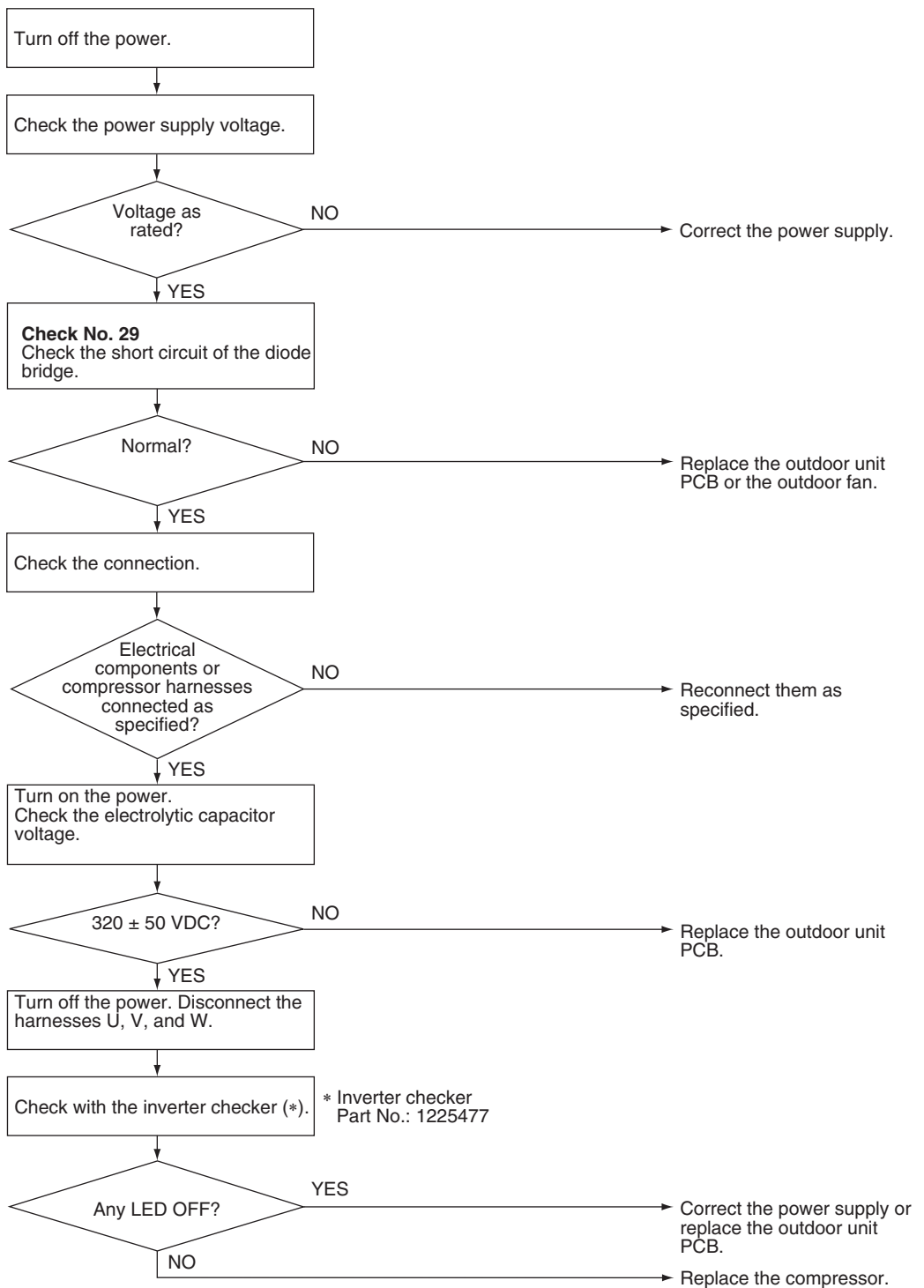

(R11380)

Troubleshooting 35 class

 **Caution** Be sure to turn off the power switch before connecting or disconnecting connectors, or parts may be damaged.

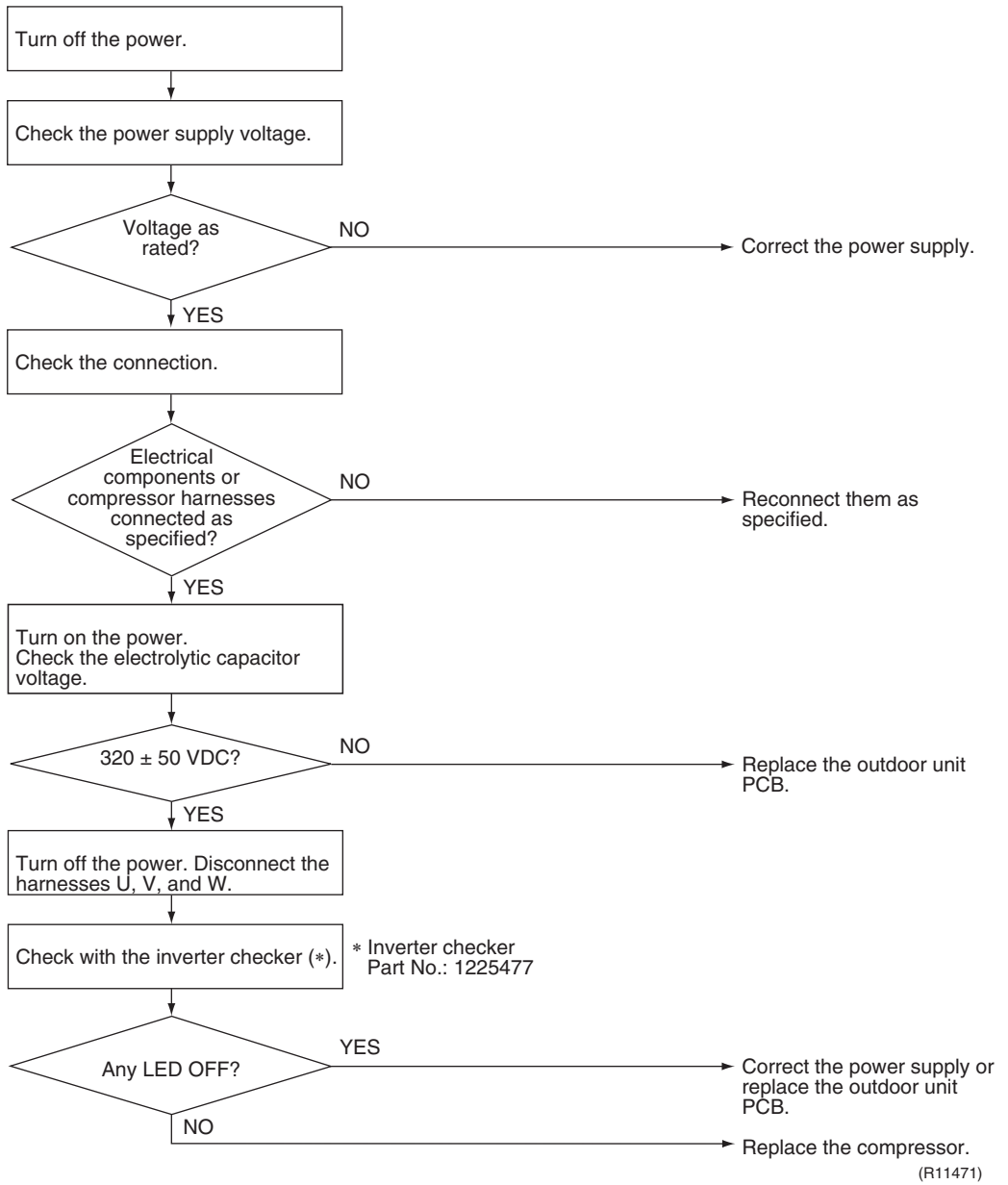

## 4.18 DC Voltage / Current Sensor Abnormality (20/25 Class)

Remote Control  
Display

*H8*

Method of  
Malfunction  
Detection

DC voltage or DC current sensor abnormality is identified based on the compressor running frequency and the input current.

Malfunction  
Decision  
Conditions

- The compressor running frequency is above 52 Hz.
- If the error repeats 4 times, the system is shut down.
- Reset condition: Continuous run for about 60 minutes without any other error

Supposed  
Causes

- Defective outdoor unit PCB

Troubleshooting



**Caution**

Be sure to turn off the power switch before connecting or disconnecting connectors, or parts may be damaged.

**Replace the outdoor unit PCB.**

## 4.19 CT or Related Abnormality (35 Class)

---

**Remote Control  
Display**

*H8*

---

**Method of  
Malfunction  
Detection**

A CT or related error is detected by checking the compressor running frequency and CT-detected input current.

---

**Malfunction  
Decision  
Conditions**

- The compressor running frequency is more than 55 Hz, and the CT input current is below 0.5 A.
  - If the error repeats 4 times, the system is shut down.
  - Reset condition: Continuous run for about 60 minutes without any other error
- 

**Supposed  
Causes**

- Defective power module
- Breakage of wiring or disconnection
- Defective reactor
- Defective outdoor unit PCB

Troubleshooting



**Check No.12**  
Refer to P.123



**Caution** Be sure to turn off the power switch before connecting or disconnecting connectors, or parts may be damaged.

Turn off the power and turn it on again.

Start operation.

\* Running current as shown at right with relay cable 1 or 2?

YES → Replace the outdoor unit PCB.

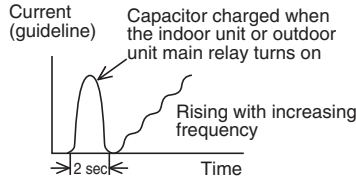

**Check No. 12**  
Check the capacitor voltage.

320 ± 50 VDC?

YES → Turn off the power. Disconnect the harnesses U, V, and W.

Measure the rectifier input voltage.

Check with the inverter checker (\*).

\* Inverter checker  
Part No.: 1225477

Any LED OFF?

YES → Correct the power supply or replace the PM1. (Replace the outdoor unit PCB.)

Turn off the power and reconnect the harnesses. Then turn on the power again and restart operation.

Compressor running?

YES → Replace the outdoor unit PCB.

NO → Replace the compressor.

Voltage within the allowable range (Supply voltage ± 15%)?

YES → Replace the outdoor unit PCB.

NO → Check the supply voltage.

(R11134)

## 4.20 Thermistor or Related Abnormality (Outdoor Unit)

Remote Control Display

*H9, J3, J6, P4*

Method of Malfunction Detection

This fault is identified based on the thermistor input voltage to the microcomputer.  
A thermistor fault is identified based on the temperature sensed by each thermistor.

Malfunction Decision Conditions

- The thermistor input voltage is above 4.96 V (25 class: 4.98 V) or below 0.04 V (25 class: 0.02 V) with the power on.
- *J3* error is judged if the discharge pipe temperature is lower than the heat exchanger temperature.

Supposed Causes

- Disconnection of the connector for the thermistor
- Defective thermistor
- Defective heat exchanger thermistor in the case of *J3* error (outdoor heat exchanger thermistor in cooling operation, or indoor heat exchanger thermistor in heating operation)
- Defective outdoor unit PCB
- Defective indoor unit PCB

Troubleshooting

In case of "*P4*"



**Caution**

Be sure to turn off the power switch before connecting or disconnecting connectors, or parts may be damaged.

**Replace the outdoor unit PCB.**

*P4* : Radiation fin thermistor

## Troubleshooting



Check No.06  
Refer to P.120

In case of "H9" "J3" "J5"

**Caution**

Be sure to turn off the power switch before connecting or disconnecting connectors, or parts may be damaged.

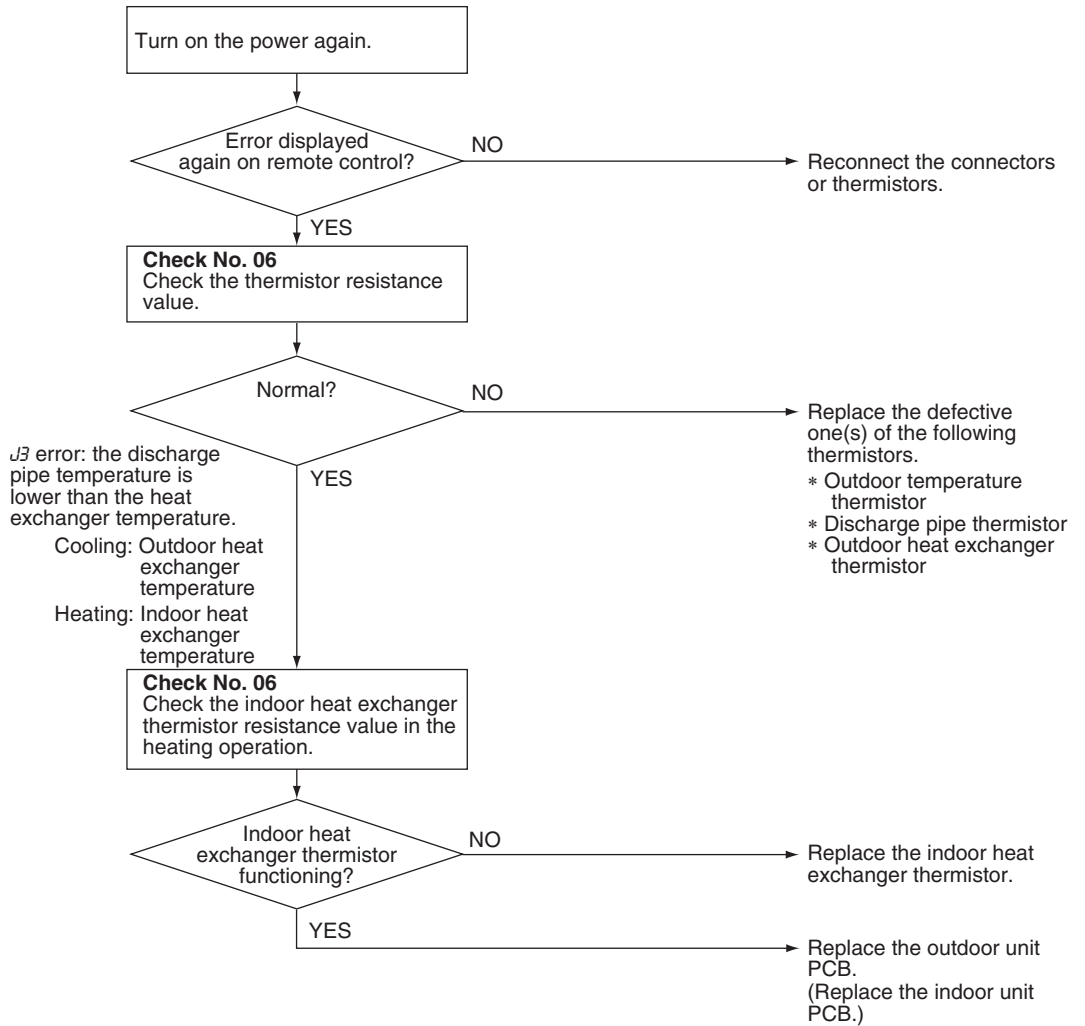

(R11905)

H9 : Outdoor temperature thermistor

J3 : Discharge pipe thermistor

J5 : Outdoor heat exchanger thermistor



## 4.21 Electrical Box Temperature Rise

Remote Control Display

**L3**

Method of Malfunction Detection

An electrical box temperature rise is detected by checking the radiation fin thermistor with the compressor off.

Malfunction Decision Conditions

- With the compressor off, the radiation fin temperature is above  $A^{\circ}\text{C}$ .
- The error is cleared when the radiation fin temperature drops below  $B^{\circ}\text{C}$ .
- To cool the electrical components, the outdoor fan starts when the radiation fin temperature rises above  $C^{\circ}\text{C}$  and stops when it drops below  $B^{\circ}\text{C}$ .

	A (°C)	B (°C)	C (°C)
RXL20G2V1B	80	70	80
RXL20G2V1B9	98	75	83
RXL25G2V1B	80	70	75
RXL35G2V1B	95	80	85

Supposed Causes

- Defective outdoor fan motor
- Short circuit
- Defective radiation fin thermistor
- Disconnection of connector
- Defective outdoor unit PCB

Troubleshooting



**Check No.07**  
Refer to P.121



**Check No.09**  
Refer to P.122



**Caution**

Be sure to turn off the power switch before connecting or disconnecting connectors, or parts may be damaged.

Turn off the power and turn it on again.

**WARNING**

To cool the electrical components, the outdoor fan starts when the radiation fin temperature rises above C°C and stops when it drops below B°C.

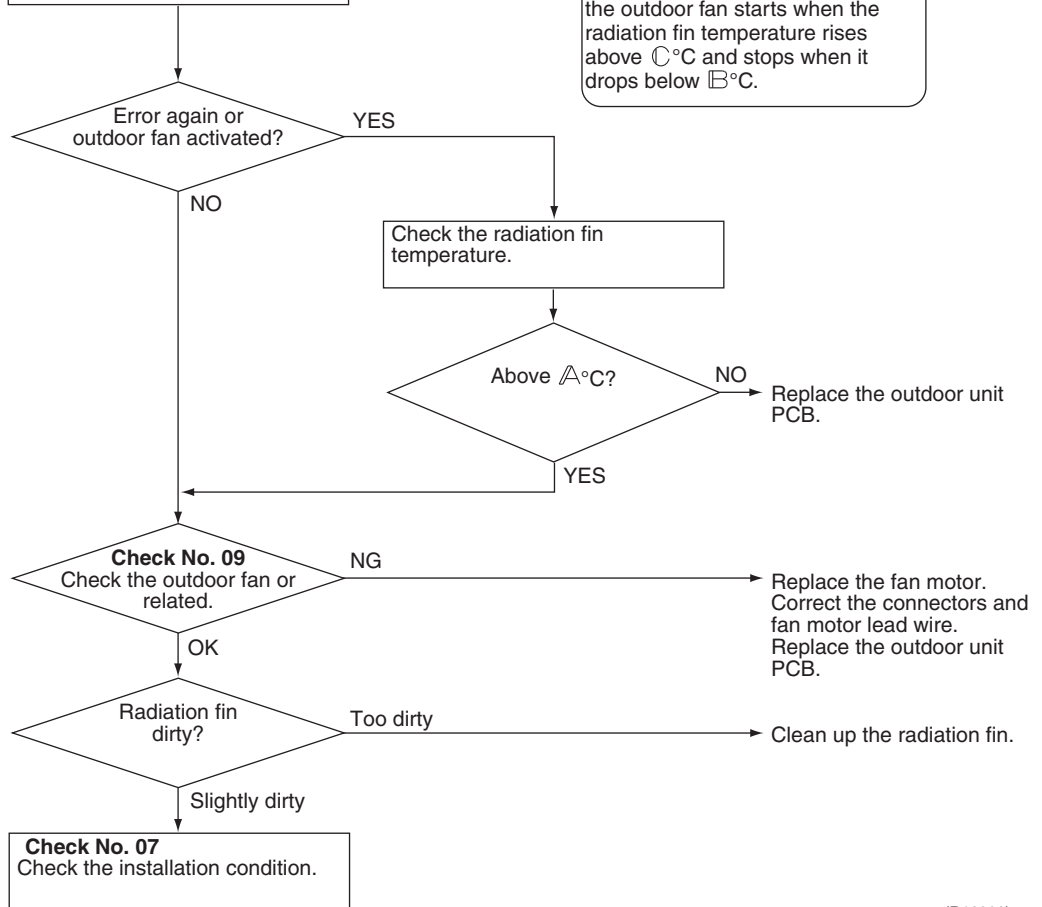

(R12000)

	A (°C)	B (°C)	C (°C)
RXL20G2V1B	80	70	80
RXL20G2V1B9	98	75	83
RXL25G2V1B	80	70	75
RXL35G2V1B	95	80	85

## 4.22 Radiation Fin Temperature Rise

Remote Control Display **L4**

**Method of Malfunction Detection** A radiation fin temperature rise is detected by checking the radiation fin thermistor with the compressor on.

- Malfunction Decision Conditions**
- If the radiation fin temperature with the compressor on is above  $A$  °C.
  - The error is cleared when the radiation fin temperature drops below  $B$  °C.
  - If the error repeats, the system is shut down.
  - Reset condition: Continuous run for about 60 minutes without any other error

	$A$ (°C)	$B$ (°C)
RXL20G2V1B	90	85
RXL20G2V1B9	98	78
RXL25G2V1B	92.5	85
RXL35G2V1B	105	99

- Supposed Causes**
- Defective outdoor fan motor
  - Short circuit
  - Defective radiation fin thermistor
  - Disconnection of connector
  - Defective outdoor unit PCB
  - Silicon grease is not applied properly on the radiation fin after replacing the outdoor unit PCB.

Troubleshooting



**Check No.07**  
Refer to P.121



**Check No.09**  
Refer to P.122



**Caution** Be sure to turn off the power switch before connecting or disconnecting connectors, or parts may be damaged.

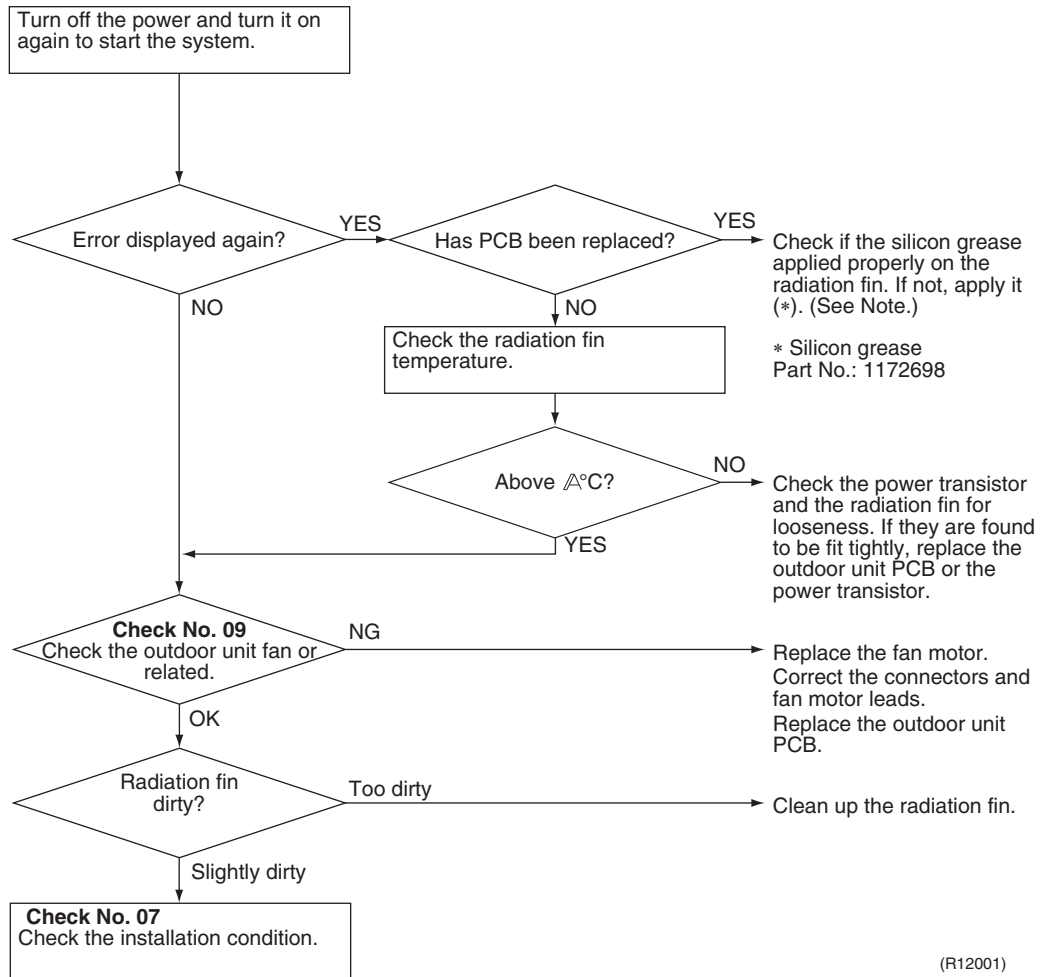

(R12001)

	Δ (°C)
RXL20G2V1B	90
RXL20G2V1B9	98
RXL25G2V1B	92.5
RXL35G2V1B	105



**Note:** Refer to “Application of silicon grease to a power transistor and a diode bridge” on page 271 for detail.

## 4.23 Output Overcurrent Detection

---

**Remote Control Display** *L5*

---

**Method of Malfunction Detection** An output overcurrent is detected by checking the current that flows in the inverter DC section.

---

**Malfunction Decision Conditions**

- A position signal error occurs while the compressor is running.
- A speed error occurs while the compressor is running.
- An output overcurrent signal is fed from the output overcurrent detection circuit to the microcomputer.
- If the error repeats, the system is shut down.
- Reset condition: Continuous run for about 11 minutes (35 class: 5 minutes) without any other error

---

**Supposed Causes**

- Poor installation condition
- Closed stop valve
- Defective power module
- Wrong internal wiring
- Abnormal supply voltage
- Defective outdoor unit PCB
- Defective compressor

Troubleshooting



**Check No.07**  
Refer to P.121



**Check No.08**  
Refer to P.121



**Check No.13**  
Refer to P.123



**Caution** Be sure to turn off the power switch before connecting or disconnecting connectors, or parts may be damaged.

\* An output overcurrent signal may result from wrong internal wiring. If the wires have been disconnected and reconnected and the system is interrupted by an output overcurrent, take the following procedure.

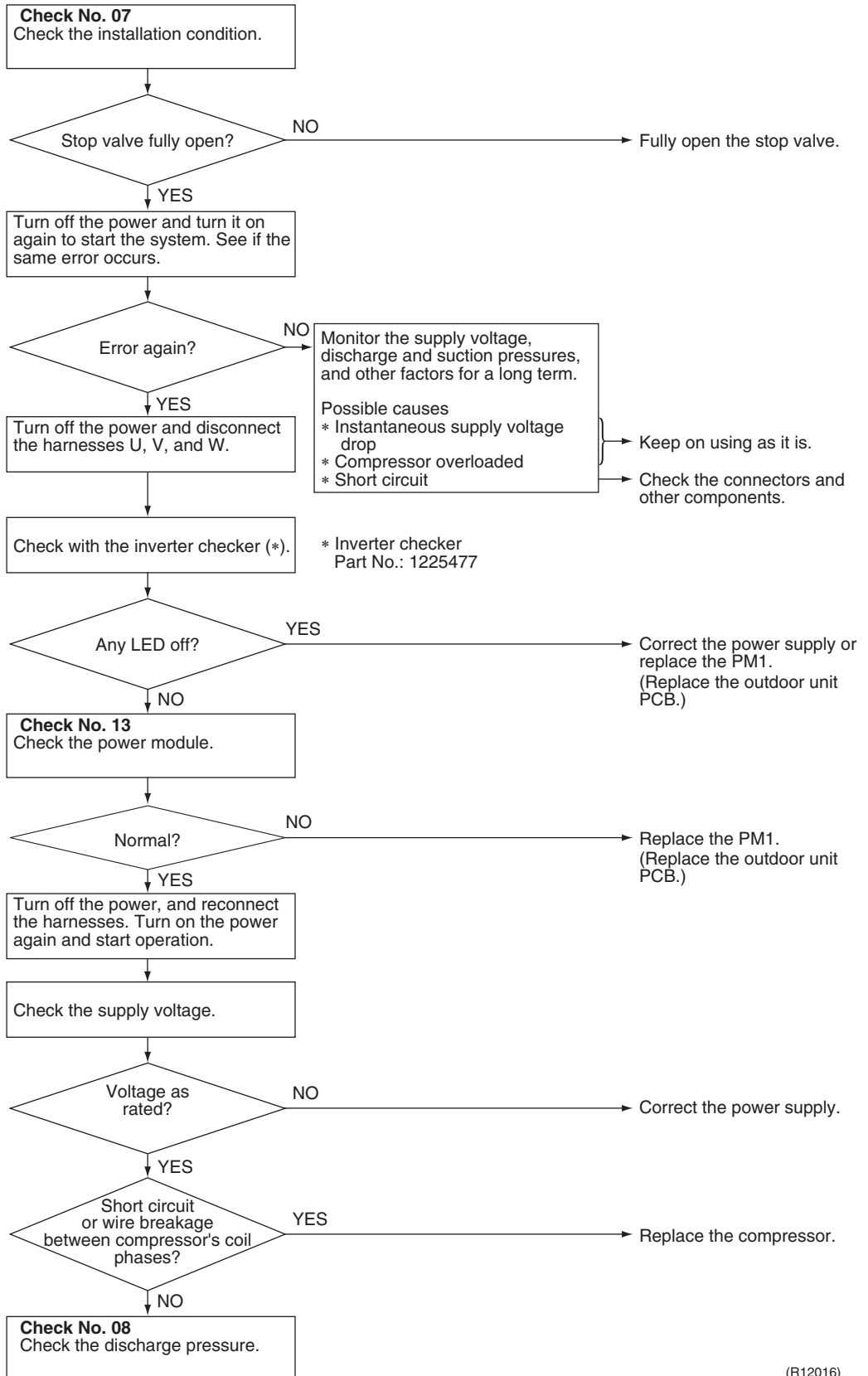

(R12016)

## 4.24 Refrigerant Shortage

Remote Control Display **U0**

Method of Malfunction Detection

**Refrigerant shortage detection I:**

Refrigerant shortage is detected by checking the input current value and the compressor running frequency. If the refrigerant is short, the input current is smaller than the normal value.

**Refrigerant shortage detection II:**

Refrigerant shortage is detected by checking the discharge pipe temperature and the opening of the electronic expansion valve. If the refrigerant is short, the discharge pipe temperature tends to rise.

**Refrigerant shortage detection III:**

Refrigerant shortage is detected by checking the difference between suction and discharge temperature.

Malfunction Decision Conditions

**Refrigerant shortage detection I:**

The following conditions continue for 7 minutes.

**<20/25 class>**

- ◆ Input current × input voltage ≤ A × output frequency + B
- ◆ Output frequency > C

	A (-)	B (W)	C (Hz)
20 class	640/256	0	55
25 class	3446/256	-346	48

**<35 class>**

- ◆ Input current ≤ D × output frequency + E
- ◆ Output frequency > F

	D (-)	E (A)	F (Hz)
35 class	18/1000	0.7	55

**Refrigerant shortage detection II :**

The following conditions continue for 80 seconds.

- ◆ Opening of the electronic expansion valve ≥ G
- ◆ Discharge pipe temperature > H × target discharge pipe temperature + J

	G (pulse)	H (-)	J (°C)
20 class	480	128/128	30
25 class	450	128/128	40
35 class	480	128/128	cooling: 20, heating: 45

**Refrigerant shortage detection III : (20 class only)**

When the difference of the temperature is smaller than  $\text{K} \text{ } ^\circ\text{C}$ , it is regarded as refrigerant shortage.

		K (°C)
Cooling	room thermistor temperature – indoor heat exchanger temperature	4.0
	outdoor heat exchanger temperature – outdoor temperature	4.0
Heating	indoor heat exchanger temperature – room thermistor temperature	3.0
	outdoor temperature – outdoor heat exchanger temperature	3.0

- If the error repeats 4 times, the system is shut down.
- Reset condition: Continuous run for about 60 minutes without any other error

---

**Supposed Causes**

- Disconnection of the discharge pipe thermistor, indoor or outdoor heat exchanger thermistor, room or outdoor temperature thermistor
- Closed stop valve
- Refrigerant shortage (refrigerant leakage)
- Poor compression performance of compressor
- Defective electronic expansion valve



Troubleshooting



Check No.04  
Refer to P.118



Check No.06  
Refer to P.120



**Caution**

Be sure to turn off the power switch before connecting or disconnecting connectors, or parts may be damaged.

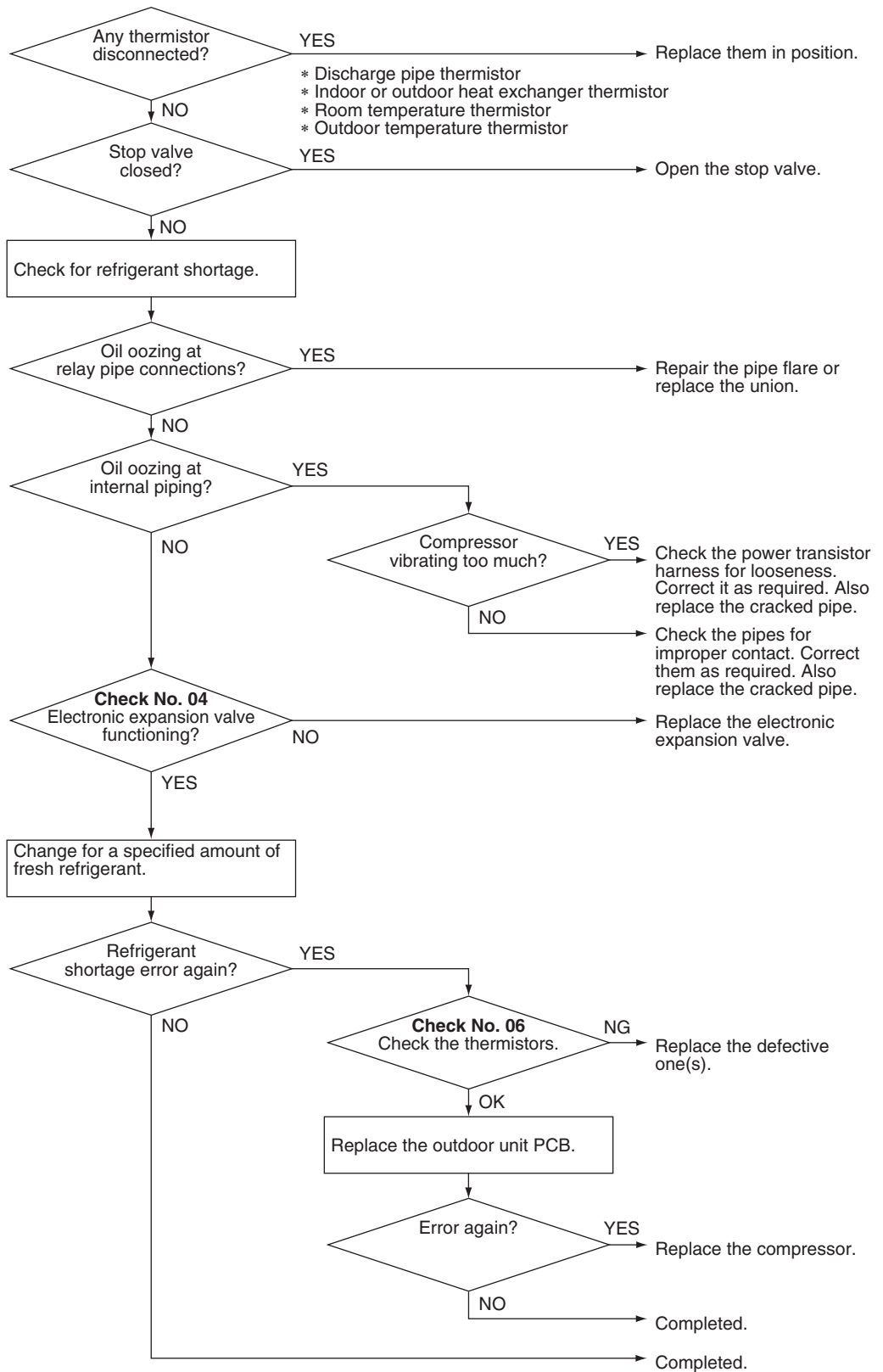

(R12015)

## 4.25 Low-voltage Detection or Over-voltage Detection

Remote Control  
Display

*U2*

Method of  
Malfunction  
Detection

**Low-voltage detection:**

An abnormal voltage drop is detected by the DC voltage detection circuit.

**Over-voltage detection:**

An abnormal voltage rise is detected by the over-voltage detection circuit.

Malfunction  
Decision  
Conditions

**Low-voltage detection:**

- The voltage detected by the DC voltage detection circuit is below 150 ~ 180 V (depending on the model).

**Over-voltage detection:**

- An over-voltage signal is fed from the over-voltage detection circuit to the microcomputer. (The voltage is over 400 V.)
- If the error repeats, the system is shut down.
- Reset condition: Continuous run for about 11 minutes (35 class: 5 minutes) without any other error

Supposed  
Causes

- Supply voltage is not as specified.
- Defective DC voltage detection circuit
- Defective over-voltage detection circuit
- Defective PAM control part
- Layer short inside the fan motor winding

Troubleshooting

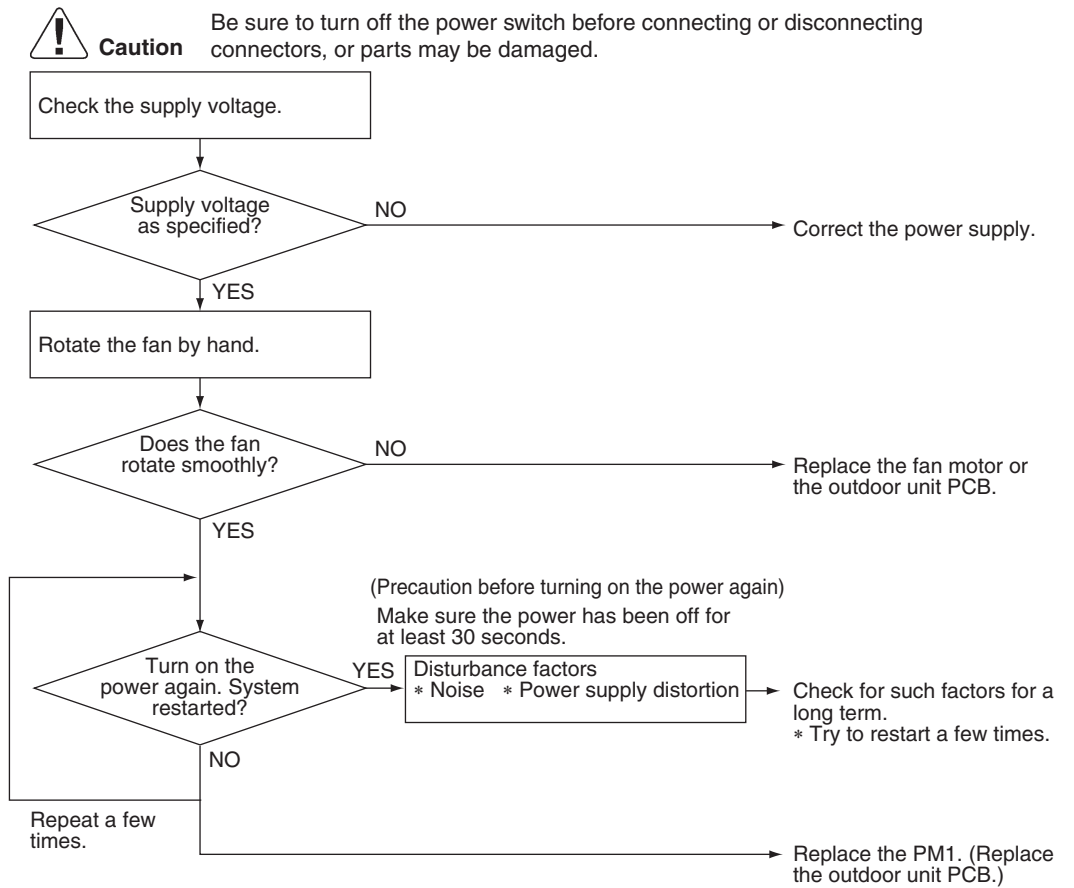

(R8402)

## 4.26 Signal Transmission Error on Outdoor Unit PCB (35 Class Only)

Remote Control  
Display

U7

Method of  
Malfunction  
Detection

Communication error between microcomputer mounted on the main microcomputer and PM1.

Malfunction  
Decision  
Conditions

- The abnormality is determined when the data sent from the PM1 can not be received for 9 seconds.
- The error counter is reset when the data from the PM1 can be successfully received.

Supposed  
Causes

- Defective outdoor unit PCB

Troubleshooting



**Caution**

Be sure to turn off the power switch before connecting or disconnecting connectors, or parts may be damaged.

Turn off the power and turn it on again.

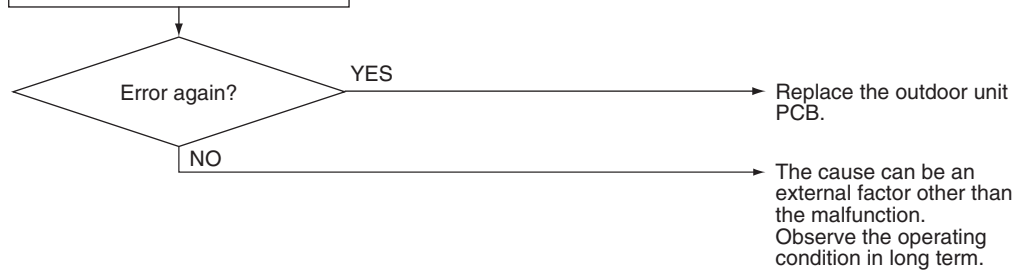

(R7185)

## 5. Check

### 5.1 How to Check

#### 5.1.1 Fan Motor Connector Output Check

##### Check No.01

1. Check the connection of connector.
2. Check the motor power supply voltage output (pins 4 - 7).
3. Check the motor control voltage (pins 4 - 3).
4. Check the rotation command voltage (pins 4 - 2).
5. Check the rotation pulse (pins 4 - 1).

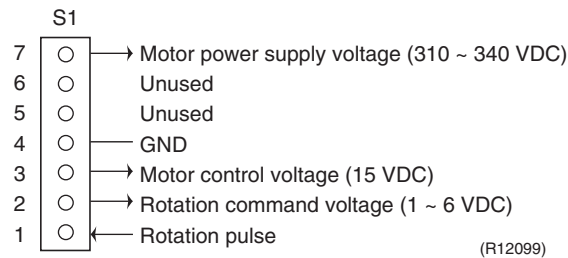

#### 5.1.2 Electronic Expansion Valve Check

##### Check No.04

Conduct the followings to check the electronic expansion valve (EV).

1. Check to see if the EV connector is correctly connected to the PCB.
2. Turn the power off and on again, and check to see if the EV generate latching sound.
3. If the EV does not generate latching sound in the above step 2, disconnect the connector and check the continuity using a tester.
4. Check the continuity between the pins 1 - 6 and 3 - 6, and between the pins 2 - 5 and 4 - 5. If there is no continuity between the pins, the EV coil is faulty.

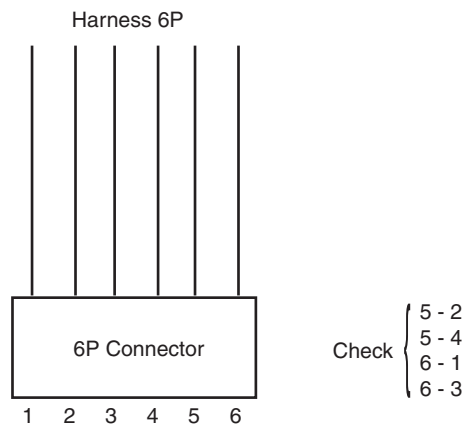

5. If the continuity is confirmed in the above step 3, the outdoor unit PCB is faulty.



**Note:** Please note that the latching sound varies depending on the valve type.

### 5.1.3 Four Way Valve Performance Check

#### Check No.05

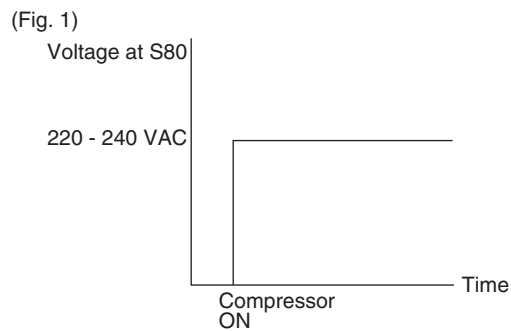
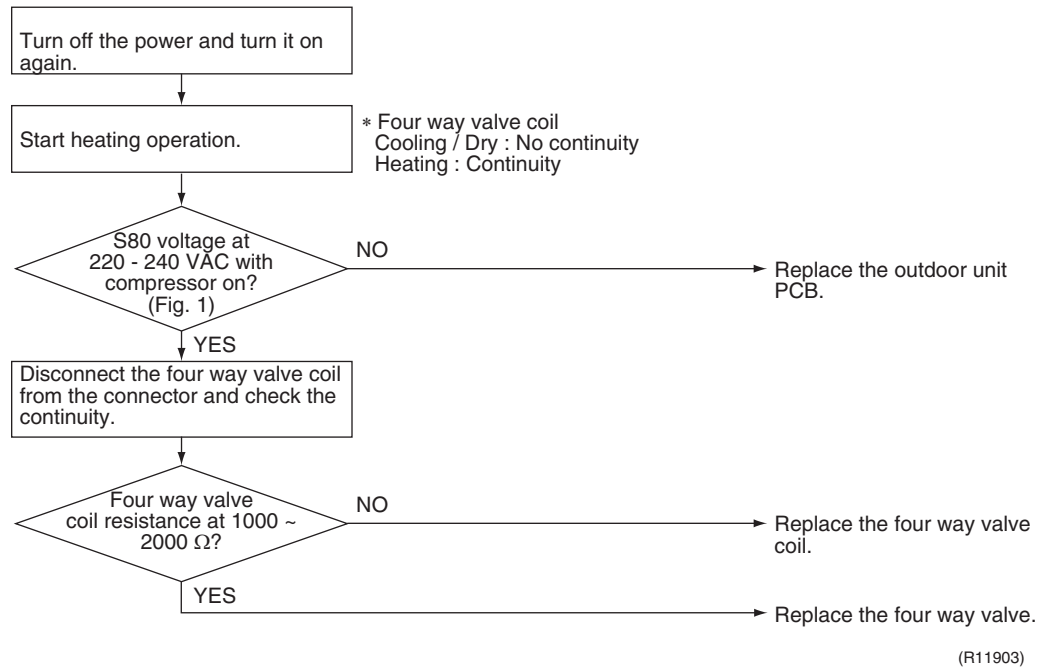

## 5.1.4 Thermistor Resistance Check

### Check No.06

Disconnect the connectors of the thermistors from the PCB, and measure the resistance of each thermistor using tester.

The relationship between normal temperature and resistance is shown in the table and the graph below.

Temperature (°C)	Thermistor R25°C = 20 kΩ, B = 3950
-20	211.0 (kΩ)
-15	150.0
-10	116.5
-5	88.0
0	67.2
5	51.9
10	40.0
15	31.8
20	25.0
25	20.0
30	16.0
35	13.0
40	10.6
45	8.7
50	7.2

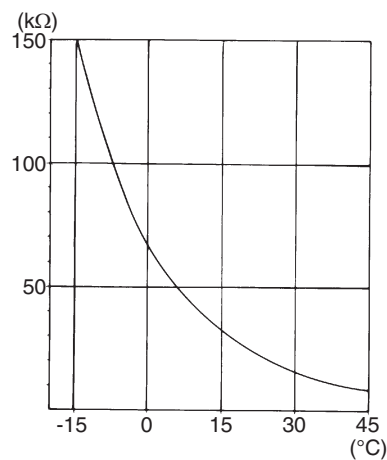

(R11905)

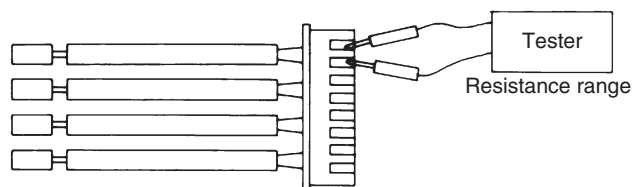

(R11906)

- For the models in which the thermistor is directly mounted on the PCB, disconnect the connector for the PCB and measure.

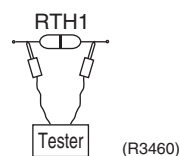

(R3460)

## 5.1.5 Installation Condition Check

### Check No.07

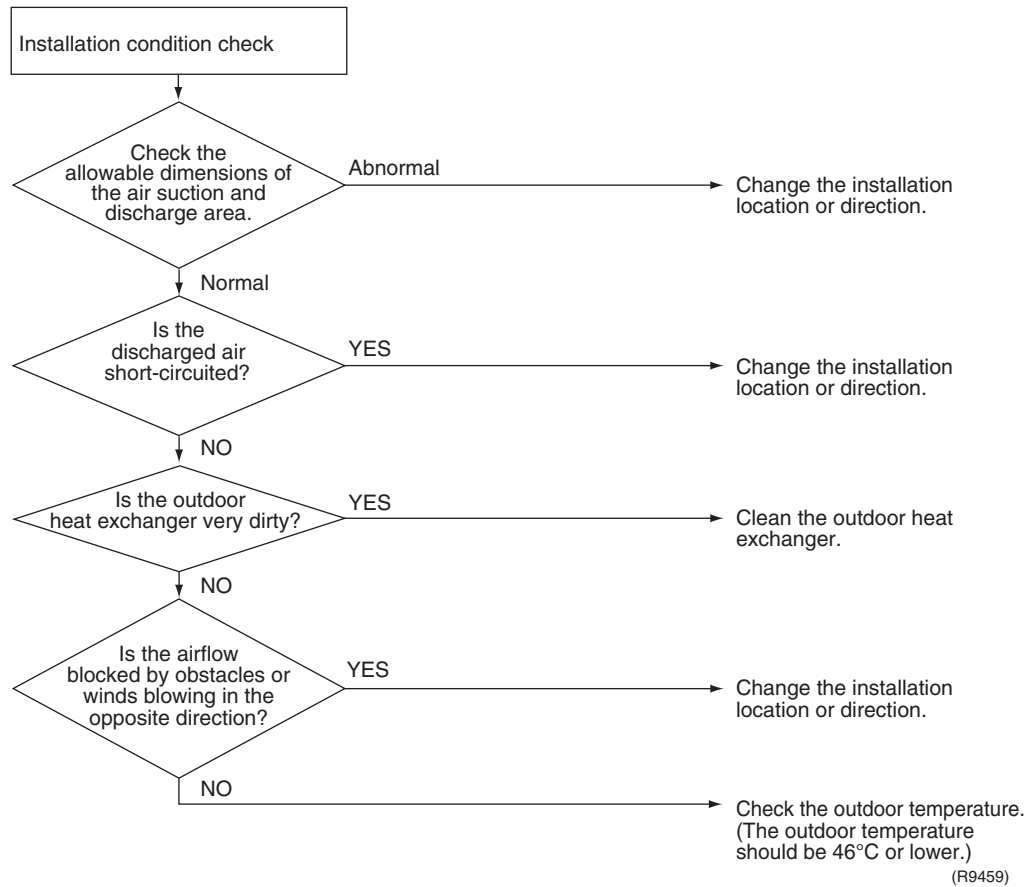

## 5.1.6 Discharge Pressure Check

### Check No.08

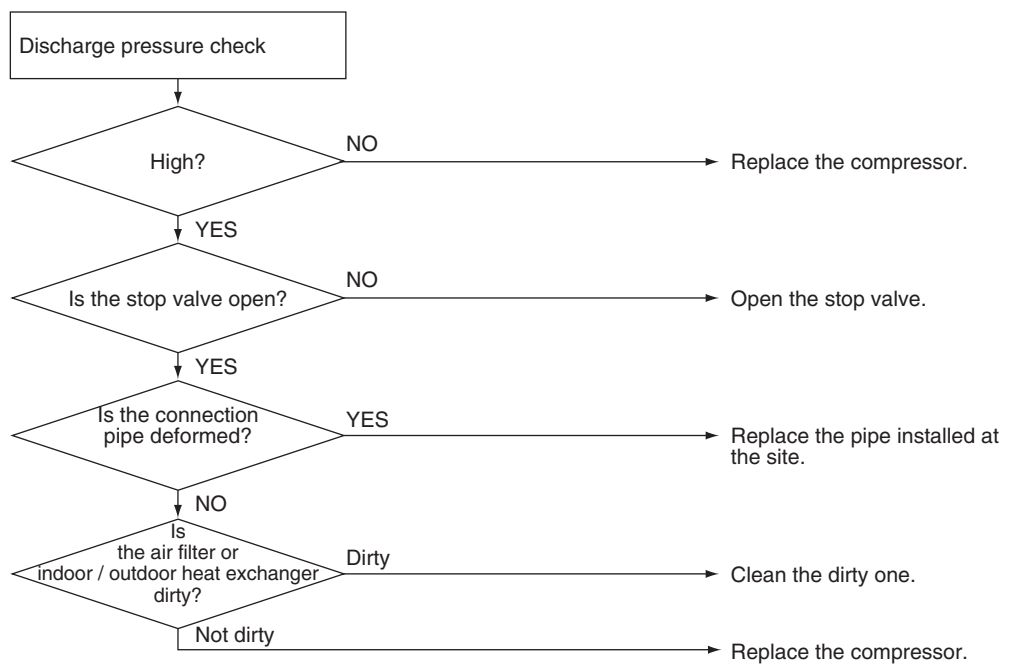



### 5.1.7 Outdoor Fan System Check

Check No.09

DC motor

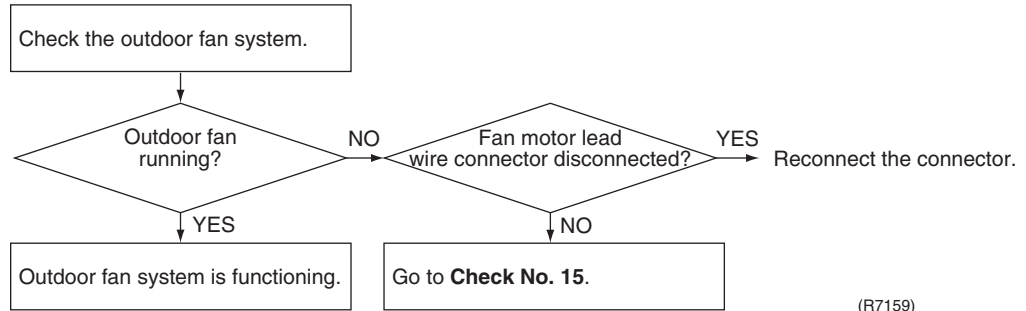

(R7159)

### 5.1.8 Power Supply Waveforms Check

Check No.10

Measure the power supply waveform between No. 1 and No. 2 on the terminal board, and check the waveform disturbance.

- Check to see if the power supply waveform is a sine wave. (Fig.1)
- Check to see if there is waveform disturbance near the zero cross. (sections circled in Fig.2)

Fig.1

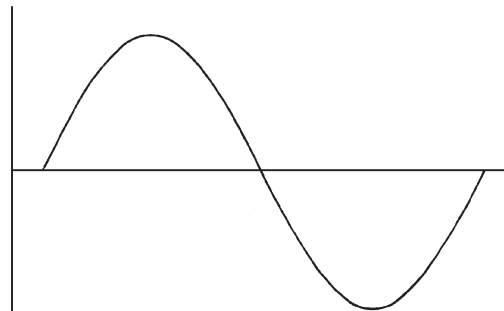

(R1736)

Fig.2

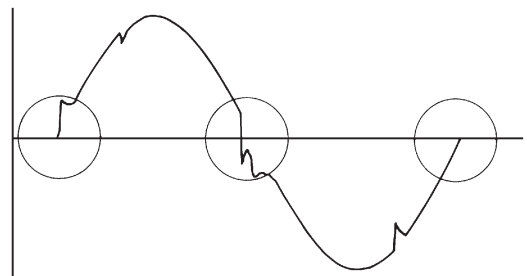

(R1444)

### 5.1.9 Inverter Units Refrigerant System Check

Check No.11

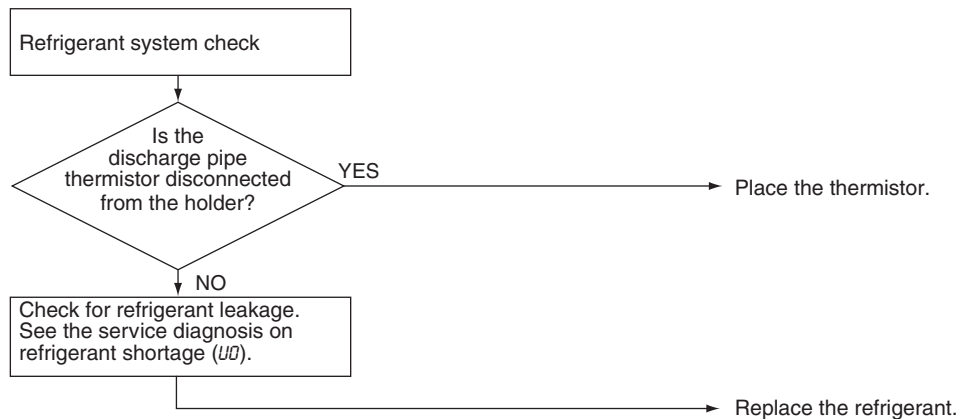

(R8259)

## 5.1.10 Capacitor Voltage Check

### Check No.12

Before this check, be sure to check the main circuit for short circuit.  
With the circuit breaker still on, measure the voltage according to the drawing of the model in question. Be careful never to touch any live parts.

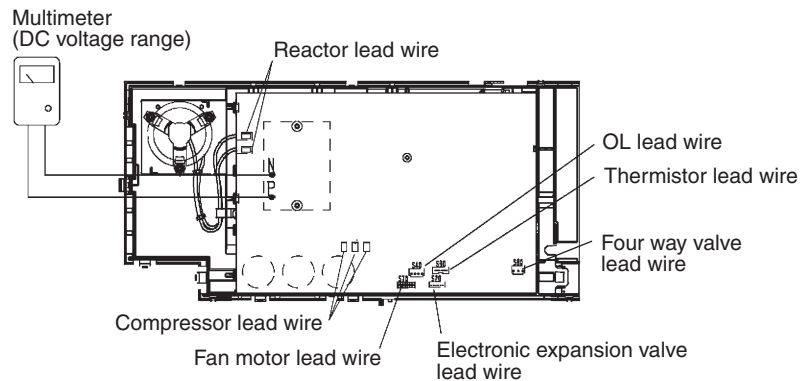

(R5222)

## 5.1.11 Power Module Check

### Check No.13



**Note:** Check to make sure that the voltage between (+) and (-) of the diode bridge (DB1) is approx. 0 V before checking.

- Disconnect the compressor harness connector from the outdoor unit PCB. To disengage the connector, press the protrusion on the connector.
- Follow the procedure below to measure resistance between the terminals of the DB1 and the terminals of the compressor with a multi-tester. Evaluate the measurement results for a judgment.

Negative (-) terminal of tester (positive terminal (+) for digital tester)	DB1 (+)	UVW	DB1 (-)	UVW
Positive (+) terminal of tester (negative terminal (-) for digital tester)	UVW	DB1 (+)	UVW	DB1 (-)
Resistance in OK	several k $\Omega$ ~ several M $\Omega$			
Resistance in NG	0 $\Omega$ or $\infty$			

## 5.1.12 Rotation Pulse Check on the Outdoor Unit PCB

### Check No.15

#### RXL20-35G2V1B

Make sure that the voltage of  $320 \pm 30$  V is applied.

1. Set operation off and power off. Disconnect the connector S70.
2. Check that the voltage between the pins 4 - 7 is 320 VDC.
3. Check that the control voltage between the pins 3 - 4 is 15 VDC.
4. Check that the rotation command voltage between the pins 2 - 4 is 0 ~ 15 VDC.
5. Keep operation off and power off. Connect the connector S70.
6. Check whether 2 pulses (0 ~ 15 VDC) are output at the pins 1 - 4 when the fan motor is rotated 1 turn by hand.

When the fuse is melted, check the outdoor fan motor for proper function.

If NG in step 2 → Defective PCB → Replace the outdoor unit PCB.

If NG in step 4 → Defective Hall IC → Replace the outdoor fan motor.

If OK in both steps 2 and 4 → Replace the outdoor unit PCB.

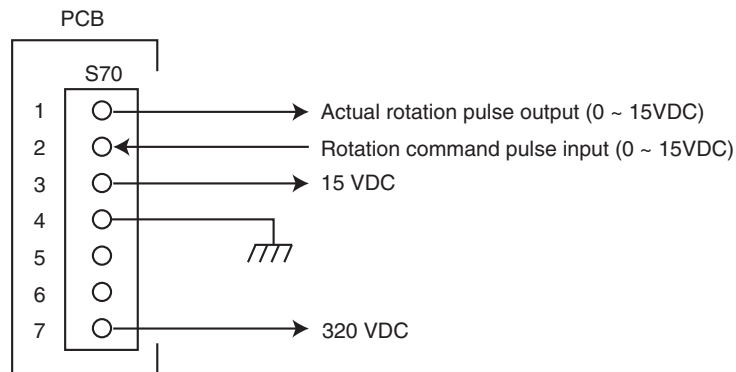

(R10811)

#### RXL20G2V1B9

1. Check that the voltage between the pins 10 - 11 is 15 VDC.
2. Check if the Hall IC generates the rotation pulse (0 ~ 15 VDC) 4 times between the pins 10 - 12, 10 - 13, when the fan motor is manually rotated once.

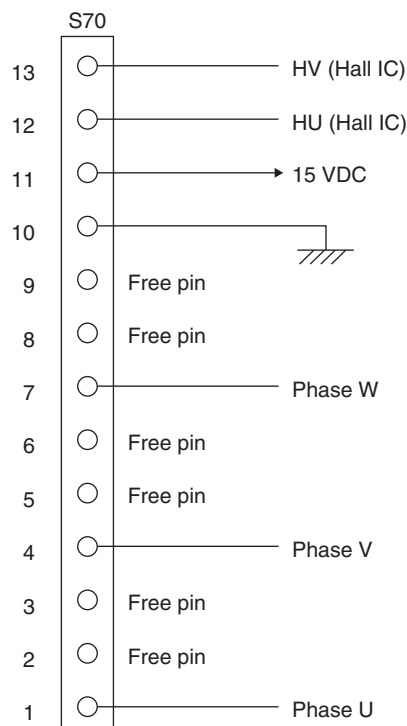

(R11907)

### 5.1.13 Main Circuit Short Check

Check No.29



**Note:** Check to make sure that the voltage between (+) and (-) of the diode bridge (DB1) is approx. 0 V before checking.

- Measure the resistance between the pins of the DB1 as below.
- If the resistance is  $\infty$  or less than 1 k $\Omega$ , short circuit occurs on the main circuit.

(-) terminal of the tester (in case of digital, (+) terminal)	~ (2, 3)	+ (4)	~ (2, 3)	-(1)
(+) terminal of the tester (in case of digital, (-) terminal)	+ (4)	~ (2, 3)	-(1)	~ (2, 3)
Resistance in OK	several k $\Omega$ ~ several M $\Omega$	$\infty$	$\infty$	several k $\Omega$ ~ several M $\Omega$
Resistance in NG	0 $\Omega$ or $\infty$	0	0	0 $\Omega$ or $\infty$

20 class

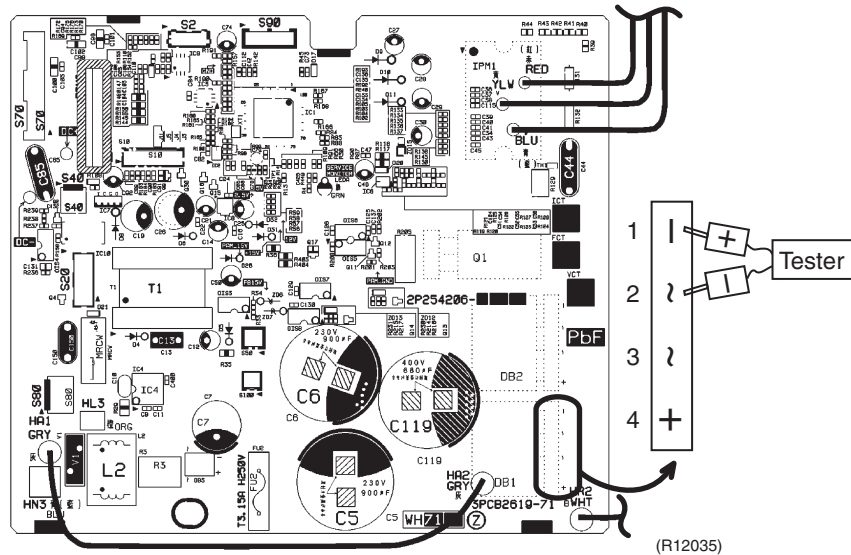

25 class

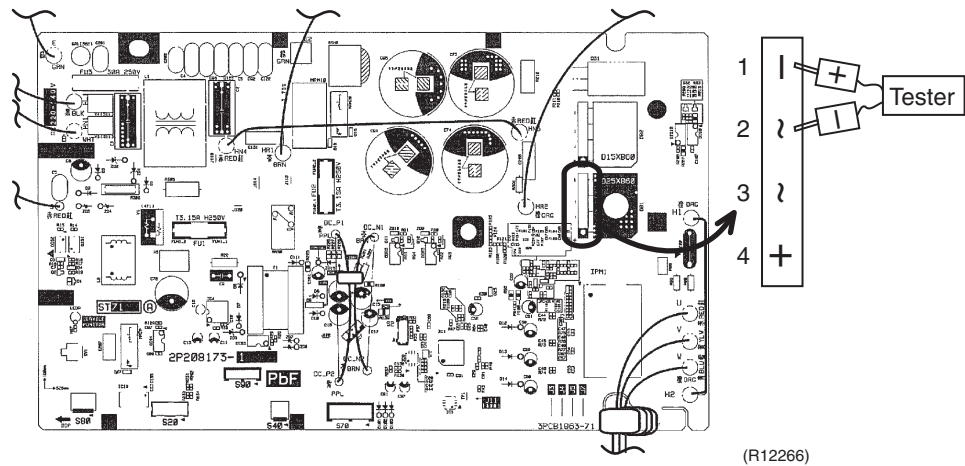

# Part 7

## Removal Procedure

1. Indoor Unit.....	128
1.1 Removal of Air Filter.....	128
1.2 Removal of Front Panel.....	130
1.3 Removal of Front Grille.....	132
1.4 Removal of Horizontal Blades / Vertical Blades.....	135
1.5 Removal of Electrical Box.....	138
1.6 Removal of PCB.....	141
1.7 Removal of Indoor Heat Exchanger.....	146
1.8 Removal of Swing Motors.....	149
1.9 Removal of Fan Motor.....	153
2. Outdoor Unit - RXL20G2V1B.....	156
2.1 Removal of Outer Panels / Fan Motor.....	156
2.2 Removal of Electrical Box.....	164
2.3 Removal of Drain Pan Heater.....	168
2.4 Removal of Thermistors.....	170
2.5 Removal of PCB.....	172
2.6 Removal of Reactor / Partition Plate.....	175
2.7 Removal of Sound Blanket.....	177
2.8 Removal of Four Way Valve.....	178
2.9 Removal of Compressor.....	181
3. Outdoor Unit - RXL20G2V1B9.....	183
3.1 Removal of Outer Panels / Fan Motor.....	183
3.2 Removal of Electrical Box.....	192
3.3 Removal of Drain Pan Heater.....	195
3.4 Removal of PCB.....	197
3.5 Removal of Reactor / Partition Plate.....	205
3.6 Removal of Sound Blanket.....	207
3.7 Removal of Four Way Valve.....	209
3.8 Removal of Compressor.....	212
4. Outdoor Unit - RXL25G2V1B.....	214
4.1 Removal of Outer Panels.....	214
4.2 Removal of Electrical Box.....	216
4.3 Removal of PCB.....	221
4.4 Removal of Drain Pan Heater.....	226
4.5 Removal of Sound Blanket.....	228
4.6 Removal of Outdoor Fan / Fan Motor.....	230
4.7 Removal of Thermistors.....	233
4.8 Removal of Four Way Valve / Electronic Expansion Valve.....	234
4.9 Removal of Compressor.....	237
5. Outdoor Unit - RXL35G2V1B.....	240
5.1 Removal of Outer Panels.....	240
5.2 Removal of Outdoor Fan / Fan Motor.....	244
5.3 Removal of Electrical Box.....	248
5.4 Removal of PCB.....	254
5.5 Removal of Drain Pan Heater.....	257

5.6	Removal of Sound Blanket / Thermistors.....	259
5.7	Removal of Four Way Valve.....	261
5.8	Removal of Electronic Expansion Valve.....	262
5.9	Removal of Compressor.....	263

# 1. Indoor Unit

## 1.1 Removal of Air Filter

**Procedure**



**Warning** Be sure to wait 10 minutes or more after turning off all power supplies before disassembling work.

Step	Procedure	Points
1. Appearance features	<p>(R7900)</p> <p>(R7901)</p>	<p><b>Warning</b>  <b>Dangerous: High voltage</b>                      A high voltage is applied to all the electric circuits of this product including thermistors.</p> <ul style="list-style-type: none"> <li>■ When the signal receiver catches a signal from the remote control, the receiving tone sounds and the operation lamp blinks immediately to confirm the signal reception.</li> <li>■ When the ON/OFF button is kept pressed for 5 seconds, the forced cooling operation is performed for about 15 minutes.</li> </ul>
2. Remove the air filter.	<ol style="list-style-type: none"> <li>1 Hold the both sides of the front panel, and open the panel to the position where it stops.</li> <li>2 Slightly push up the center knob of the air filter and release the hooks.</li> <li>3 Pull out the air filter downward and remove it.</li> </ol> <p>(R7902)</p> <p>(R7903)</p>	<ul style="list-style-type: none"> <li>■ The air filter is not marked for difference between the right and left sides.</li> <li>■ The air filter can be set easily by inserting it along the guides.</li> <li>■ Insert the air filter with the "FRONT"-mark faced up.</li> <li>■ Be sure to insert the hooks (at 2 lower positions) when mounting the air filter.</li> </ul>

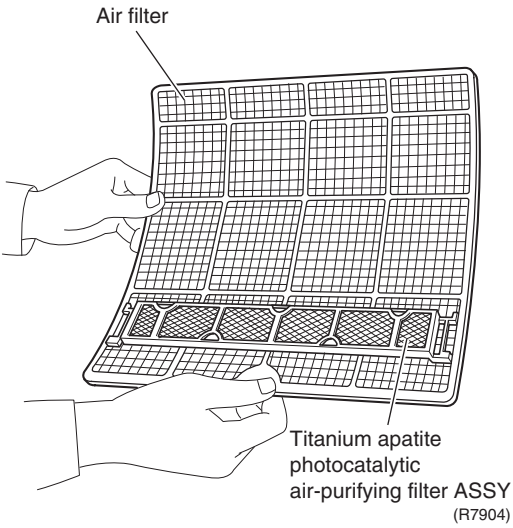
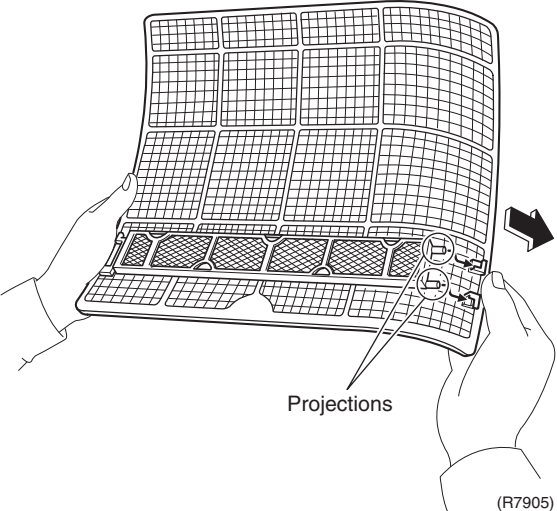
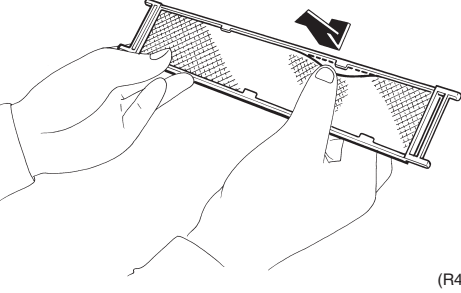
Step	Procedure	Points
3. Remove the Titanium apatite photocatalytic air-purifying filter.		
1	<p>The Titanium apatite photocatalytic air-purifying filter ASSY is attached to the back of the air filter.</p> 	<ul style="list-style-type: none"> <li>■ The Titanium apatite photocatalytic air-purifying filter is not marked for difference between the right and left sides.</li> </ul>
2	<p>Remove the Titanium apatite photocatalytic air-purifying filter ASSY by bending the air filter and unfastening the projections from the air filter frame.</p> 	
3	<p>Remove the Titanium apatite photocatalytic air-purifying filter from its frame (at 5 positions) by bending it.</p> 	



# 1.2 Removal of Front Panel

**Procedure**



**Warning** Be sure to wait 10 minutes or more after turning off all power supplies before disassembling work.

Step	Procedure	Points
1	Hold the both sides of the front panel, and open the panel over the position where it stops.	<p style="text-align: center;">Front panel</p> <p style="text-align: right;">(R7906)</p>
2	Slide the left rotary shaft to the right and release it.	<p style="text-align: center;">Rotary shaft</p> <p style="text-align: right;">(R7907)</p>
3	Slide the right rotary shaft to the left and release it.	<p style="text-align: center;">Rotary shaft</p> <p style="text-align: right;">(R7909)</p>
4	Remove the front panel.	<p style="text-align: right;">(R7910)</p>

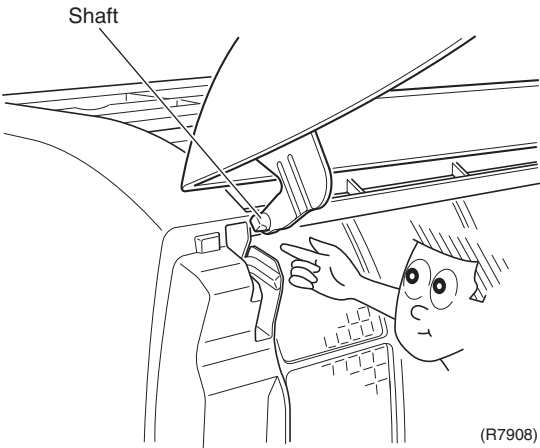
Step	Procedure	Points
5	<p>When mounting the front panel, make sure that the shaft is fitted in the guide before closing the panel.</p>	 <p><b>Caution on Mounting</b></p> <ul style="list-style-type: none"><li>■ When mounting the front panel, fit the right and left rotary shafts one by one into the grooves and fully push them in position.</li></ul>

# 1.3 Removal of Front Grille

**Procedure**

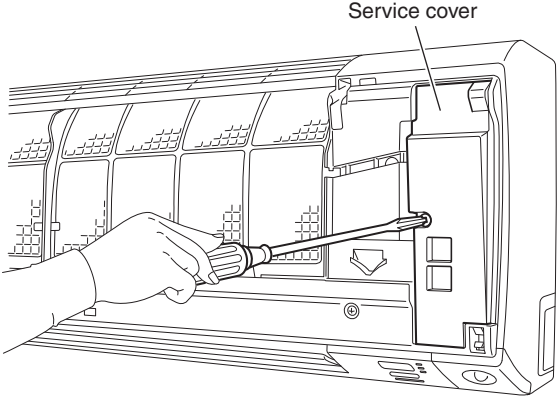
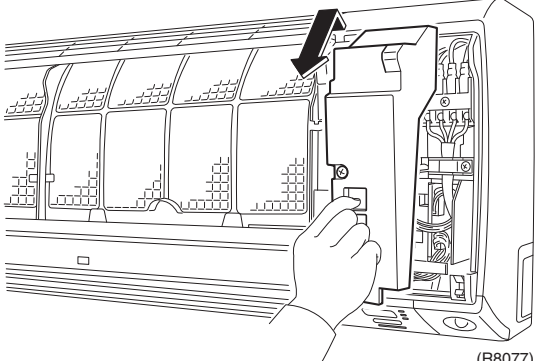
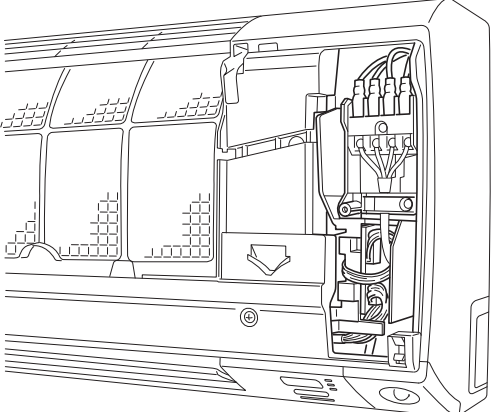

**Warning** Be sure to wait 10 minutes or more after turning off all power supplies before disassembling work.

Step	Procedure	Points
1. Remove the service cover.		
1	<p>Remove the screw of the service cover.</p>  <p style="text-align: right;">(R7911)</p>	<p><b>Preparation</b></p> <ul style="list-style-type: none"> <li>Remove the front panel according to the "Removal of Front Panel".</li> </ul>
2	<p>Pull out the service cover diagonally down in the direction of the arrow.</p>  <p style="text-align: right;">(R8077)</p>	
3	<p>The figure shows the appearance of the inside.</p>  <p style="text-align: right;">(R7913)</p>	

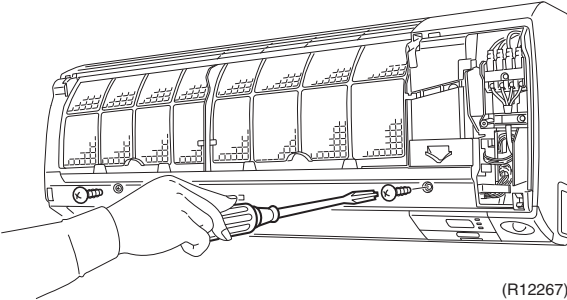
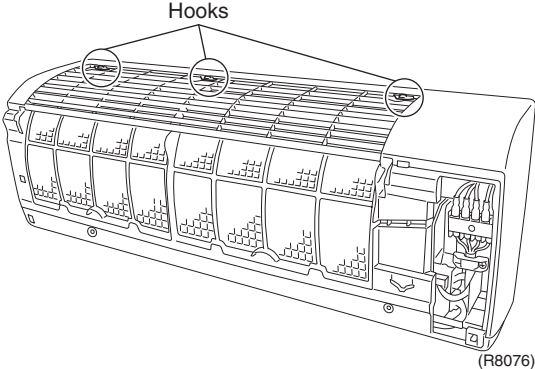
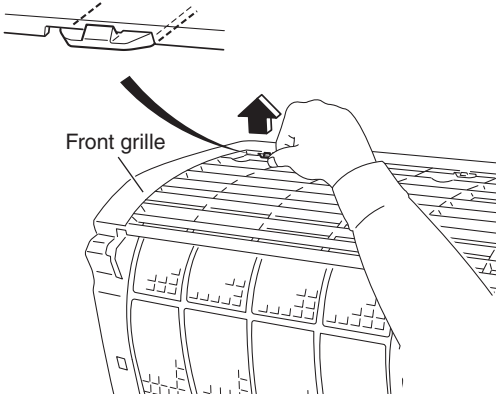
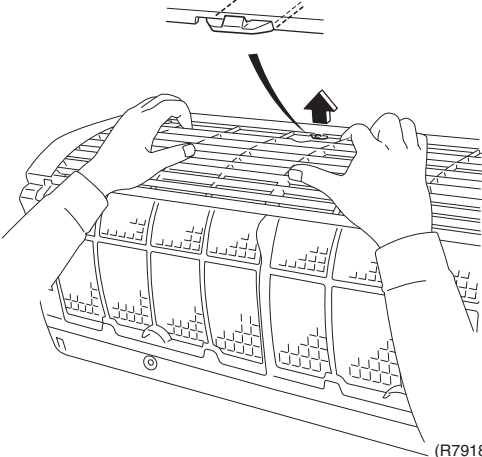
Step	Procedure	Points
2. Remove the front grille.		
1	<p>Remove the 2 screws. (one each at the right and left)</p>  <p>(R12267)</p>	
2	<p>The front grille has 3 hooks at the top.</p>  <p>(R8076)</p>	
3	<p>Unfasten the left hook.</p>  <p>(R7917)</p>	
4	<p>Unfasten the center hook.</p>  <p>(R7918)</p>	

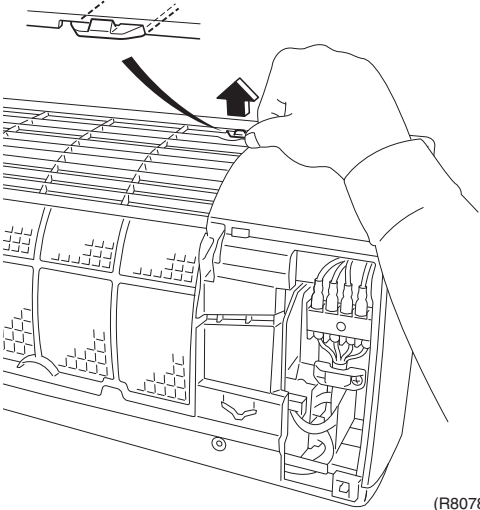
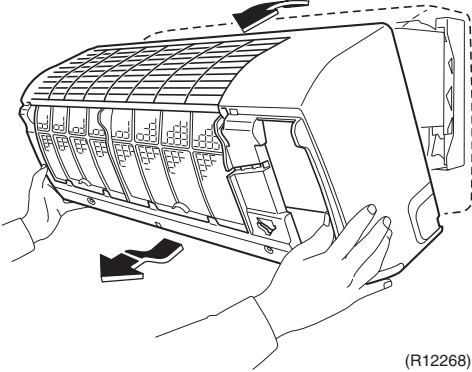
Step	Procedure	Points
5	<p>Unfasten the right hook.</p>  <p>(R8078)</p>	
6	<p>Pull the upper part of the front grille out and lift the lower part up, and then remove the front grille.</p>  <p>(R12268)</p>	<p><b>Caution on Mounting</b></p> <ul style="list-style-type: none"> <li>■ When mounting the front grille, make sure that the 3 hooks are fastened as they were.</li> </ul>

## 1.4 Removal of Horizontal Blades / Vertical Blades

### Procedure

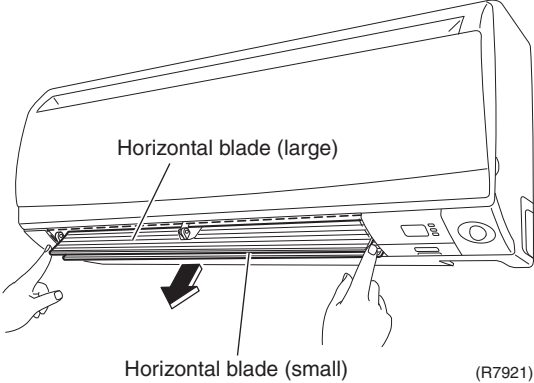
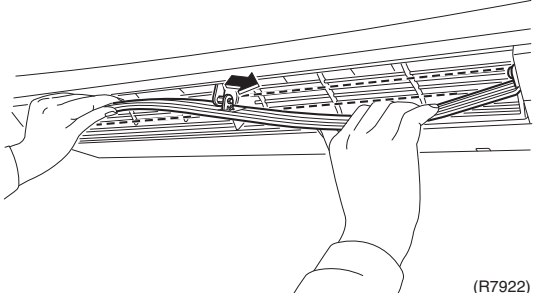
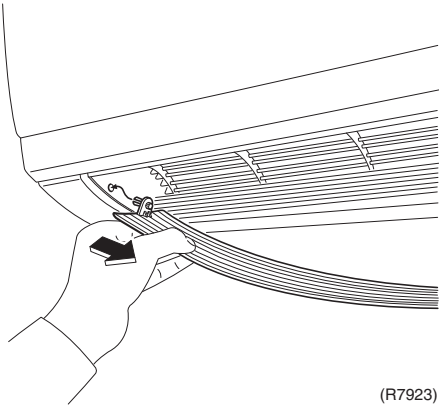
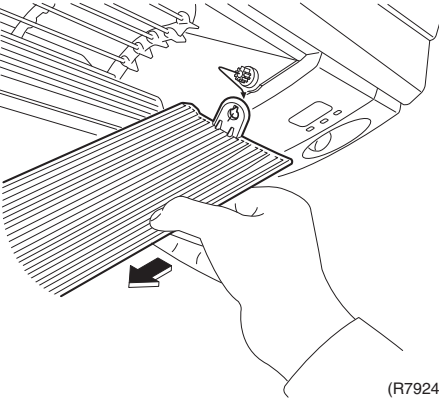

**Warning** Be sure to wait 10 minutes or more after turning off all power supplies before disassembling work.

Step	Procedure	Points	
1. Remove the horizontal blade (large).			
1	Open the horizontal blade (large).	<p><b>Caution on Mounting</b></p> <ul style="list-style-type: none"> <li>■ Mount the large horizontal blade to the upper side and the small horizontal blade to the lower side. Do not put them in the wrong place.</li> </ul>	
2	Unfasten the center shaft while bending the horizontal blade (large) slightly.		
3	Unfasten the left shaft.		
4	Unfasten the key alignment shaft at the right side.		
4		<p><b>Caution on Mounting</b></p> <ul style="list-style-type: none"> <li>■ There is a key alignment at the right shaft. When mounting, insert the right shaft first while turning.</li> <li>■ After inserting the right shaft, mount the horizontal blade first to the center shaft and then to the left shaft.</li> </ul>	
4			

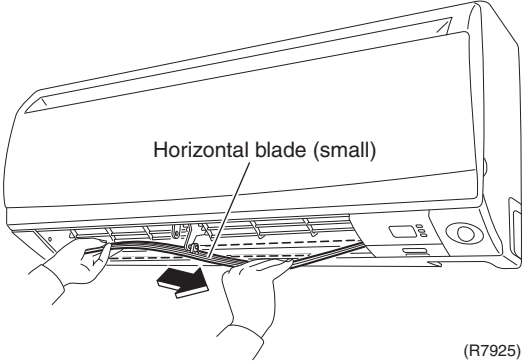
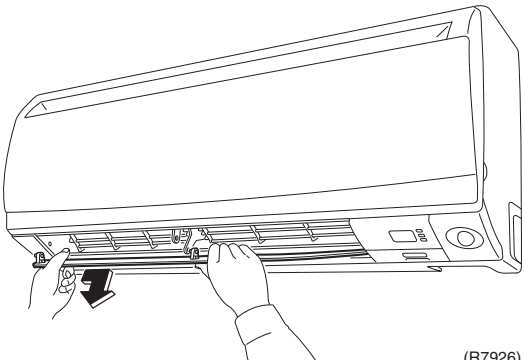
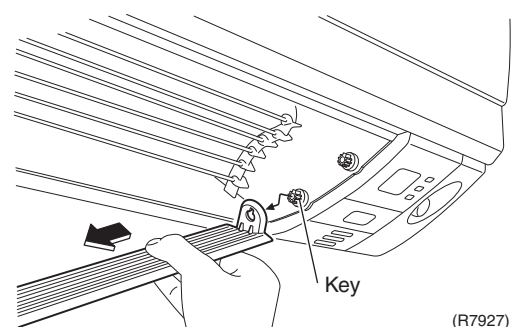
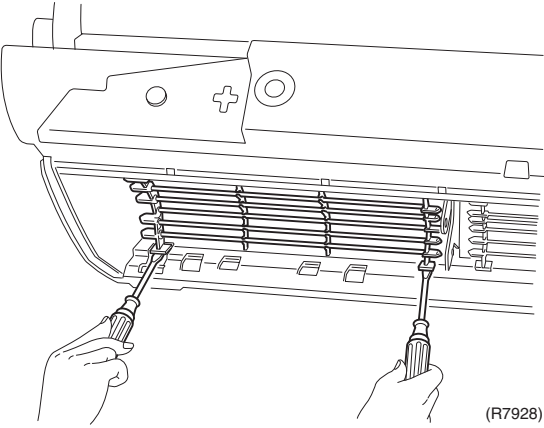
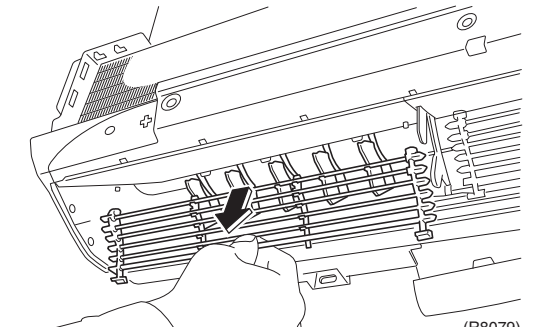
Step	Procedure	Points
<p>2. Remove the horizontal blade (small).</p> <p>1 Unfasten the center shaft while bending the horizontal blade (small) slightly.</p> <p>2 Unfasten the left shaft.</p> <p>3 Unfasten the key alignment shaft at the right side.</p>	 <p>Horizontal blade (small)</p> <p>(R7925)</p>  <p>(R7926)</p>  <p>Key</p> <p>(R7927)</p>	
<p>3. Remove the fan guard.</p> <p>1 Unfasten the hooks at the lower part of the fan guard with a flat screwdriver.</p> <p>2 Remove the fan guard.</p>	 <p>(R7928)</p>  <p>(R8079)</p>	

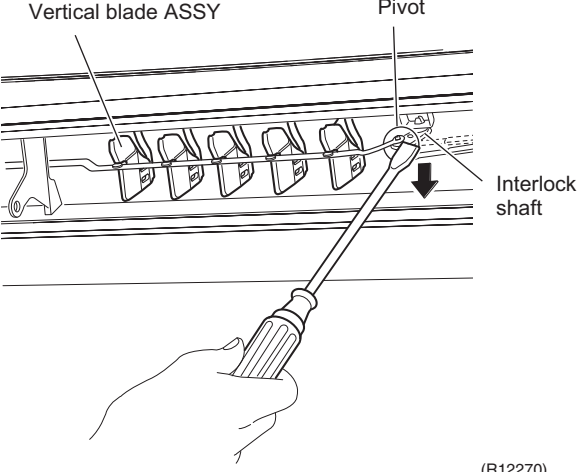
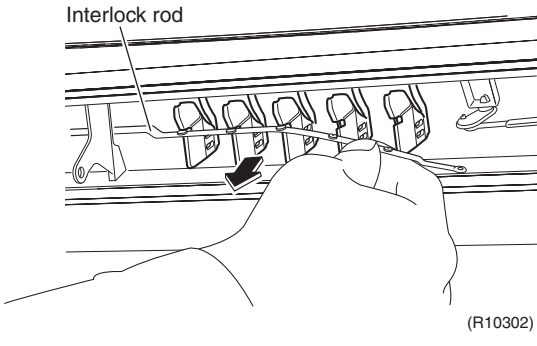
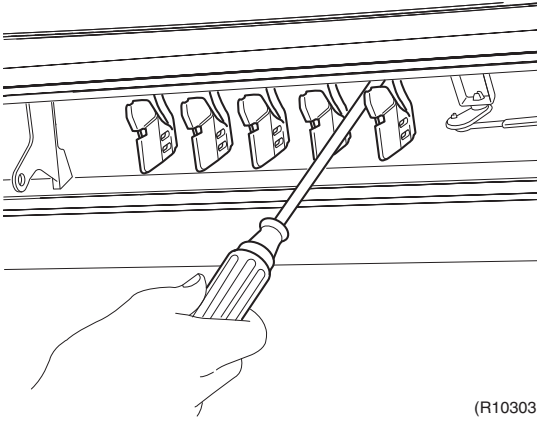
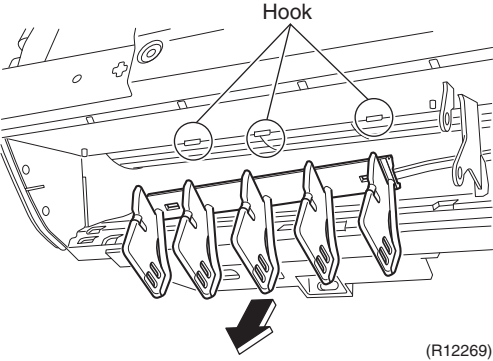
Step	Procedure	Points
4. Remove the vertical blade ASSY.		
1	<p>Detach the pivot from the interlock shaft for vertical blades with a flat screwdriver.</p> 	
2	<p>Remove the interlock rod.</p> 	
3	<p>Unfasten the hooks at the upper 3 positions by pressing them with a flat screwdriver.</p> 	
4	<p>Remove the vertical blade ASSY.</p> 	<ul style="list-style-type: none"> <li>■ A vertical blade ASSY has 5 fins. It is impossible to replace only one fin.</li> <li>■ The vertical blade ASSY is not marked for difference between right and left.</li> </ul>



# 1.5 Removal of Electrical Box

**Procedure**



**Warning** Be sure to wait 10 minutes or more after turning off all power supplies before disassembling work.

Step	Procedure	Procedure	Points
1	The figure shows the connections of wire harnesses.	<p style="text-align: right;">(R7931)</p>	<p><b>Preparation</b></p> <ul style="list-style-type: none"> <li>Remove the front grille according to the "Removal of Front Grille".</li> </ul>
2	Remove the screw of the wire fixture.	<p style="text-align: right;">(R7932)</p>	
3	Remove the screws on the terminal board to disconnect the connecting wires.	<p style="text-align: right;">(R7933)</p>	
4	Disconnect the connector for fan motor [S1].	<p style="text-align: center;">[S1]</p> <p style="text-align: right;">(R7934)</p>	

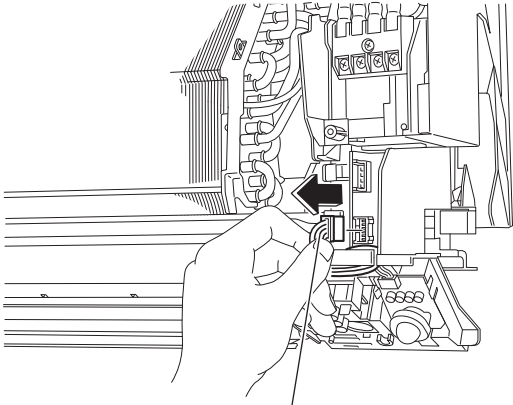
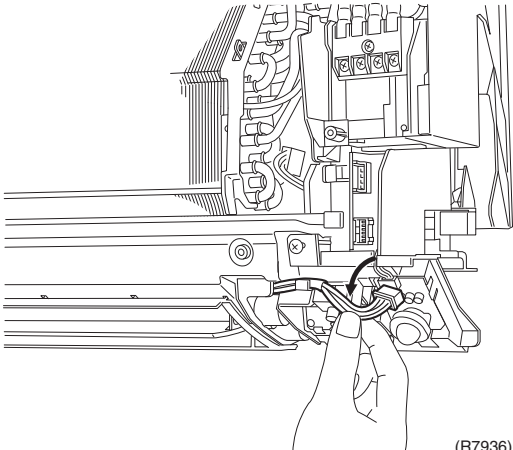
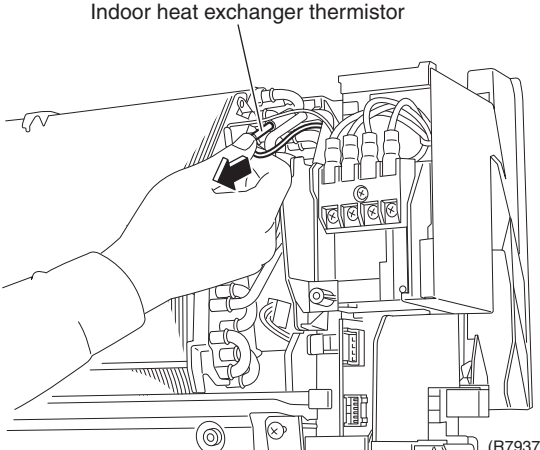
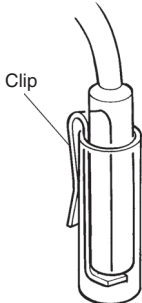
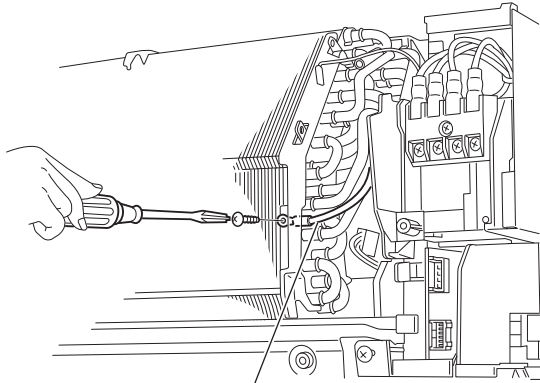
Step	Procedure	Points
5	Disconnect the connector for swing motors [S41].  <p style="text-align: center;">[S41] (R7935)</p>	
6	Release the harness for swing motors from the hook.  <p style="text-align: right;">(R7936)</p>	
7	Pull out the indoor heat exchanger thermistor.  <p style="text-align: center;">Indoor heat exchanger thermistor</p> <p style="text-align: right;">(R7937)</p>	<p>■ Be careful not to lose the clip of the thermistor.</p>  <p style="text-align: right;">(R11268)</p>
8	Remove the screw and detach the earth wire.  <p style="text-align: center;">Earth wire (R7938)</p>	

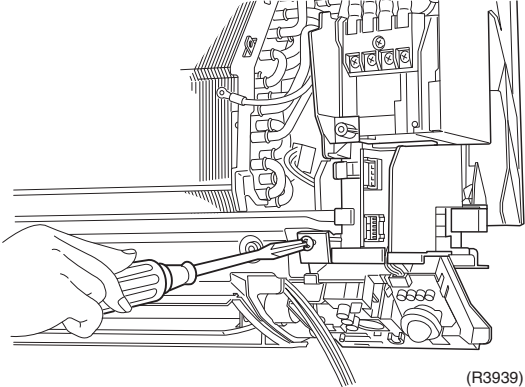
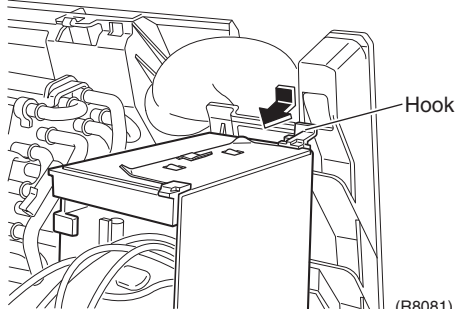
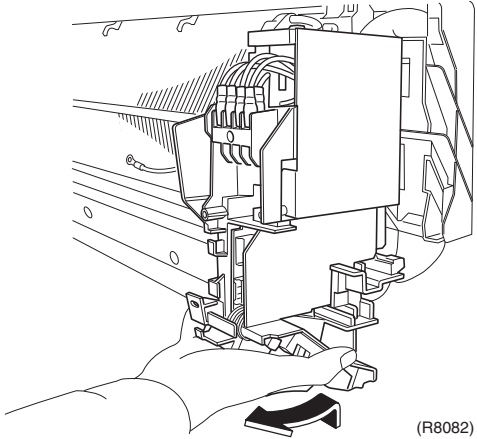
Step	Procedure	Points
9	<p>Remove the screw of the electrical box.</p>  <p>(R3939)</p>	
10	<p>Unfasten the hook at the upper far side by pressing it from above and pulling the electrical box toward yourself.</p>  <p>(R8081)</p>	
11	<p>Lift up the electrical box and pull it out.</p>  <p>(R8082)</p>	<ul style="list-style-type: none"> <li>There is a hook also at the lower part of the back. When mounting the electrical box, make sure that it is securely fastened.</li> </ul>

## 1.6 Removal of PCB

### Procedure

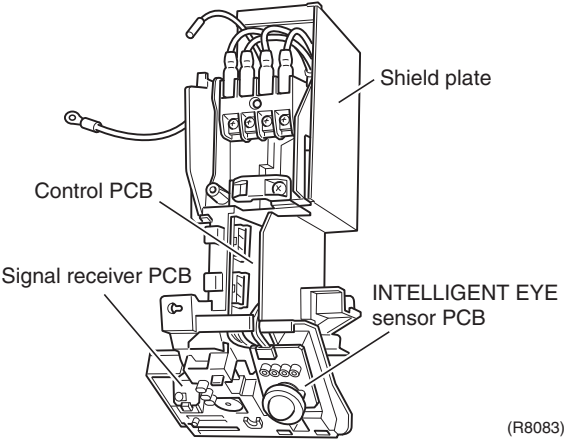
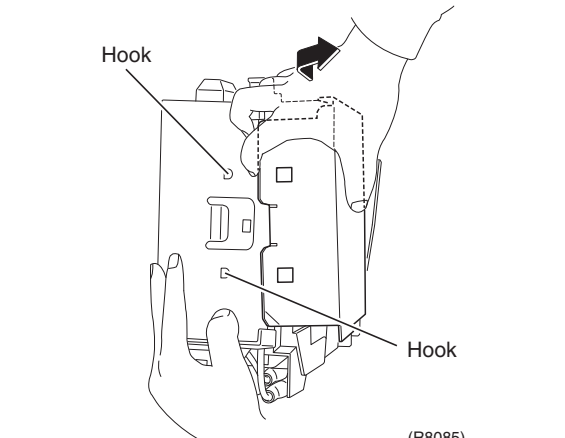
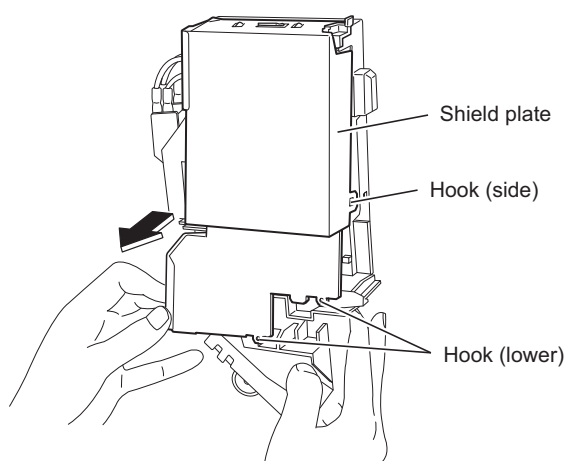
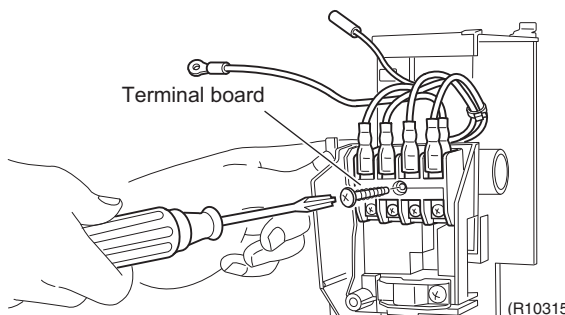

**Warning** Be sure to wait 10 minutes or more after turning off all power supplies before disassembling work.

Step	Procedure	Points
<p>1. Remove the shield plate.</p> <p>1 The figure shows the appearance of the electrical box.</p> <p>2 Unfasten the hooks at the upper 2 positions of the shield plate.</p> <p>3 Unfasten the hook at the side of the shield plate.</p> <p>4 Lift up the shield plate to unfasten the lower hooks and remove it.</p>	 <p>(R8083)</p>  <p>(R8085)</p>  <p>(R10619)</p>	<p><b>Preparation</b></p> <ul style="list-style-type: none"> <li>Remove the electrical box according to the "Removal of Electrical Box".</li> </ul>
<p>2. Remove the terminal board.</p> <p>1 Remove the screw to remove the terminal board.</p>	 <p>(R10315)</p>	

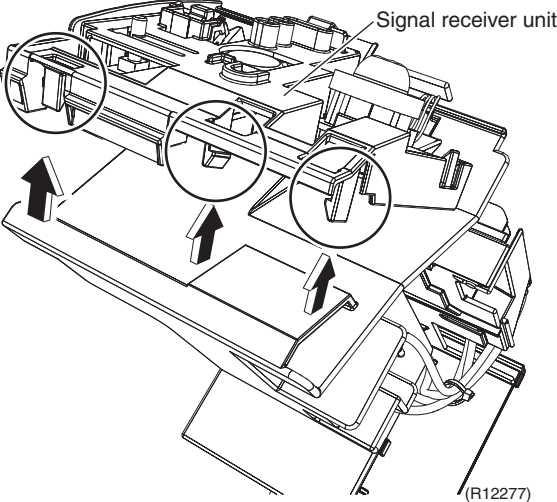
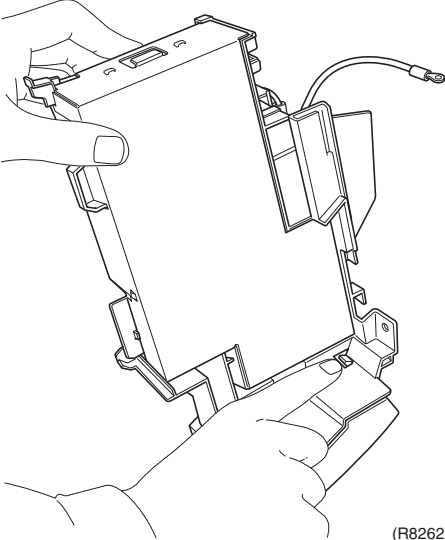
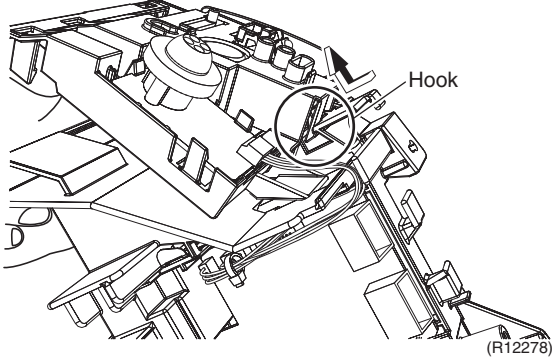
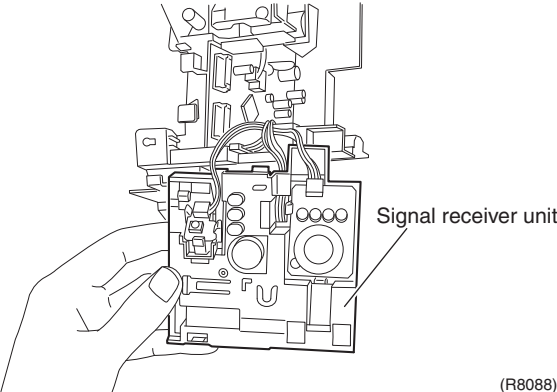
Step	Procedure	Points
3. Remove the signal receiver unit.		
1	Unfasten the 3 hooks.	
	 <p>(R12277)</p>	
2	Unfasten the hook on the opposite side, and lift up the signal receiver unit.	
	 <p>(R8262)</p>	
	 <p>(R12278)</p>	
3	Remove the signal receiver unit.	
	 <p>(R8088)</p>	

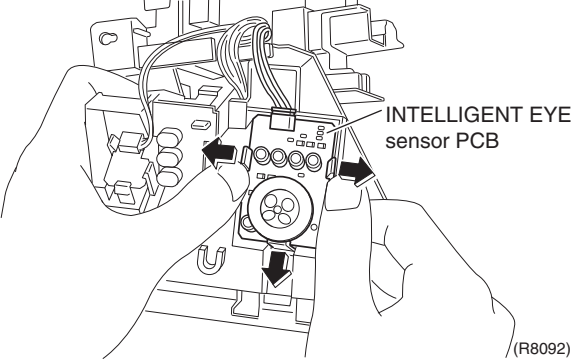
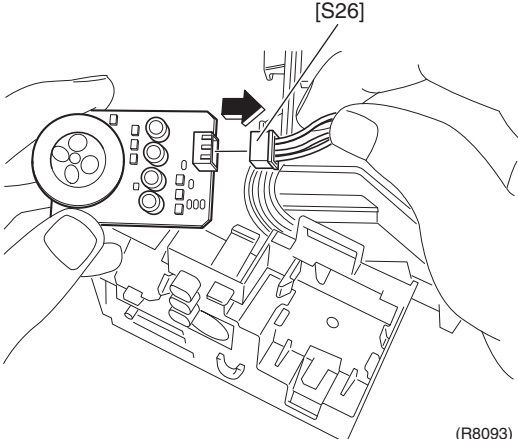
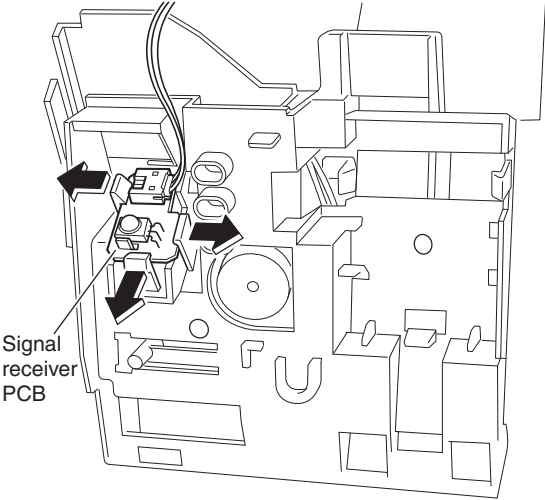
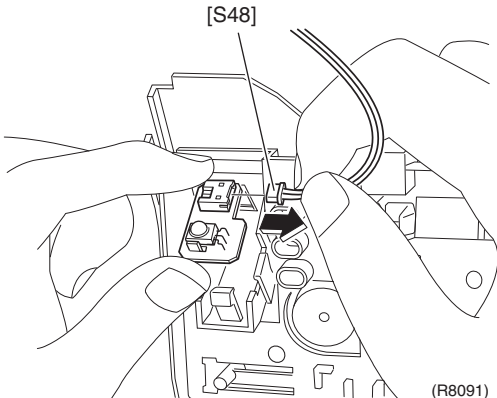
Step	Procedure	Points
<p>4. Remove the INTELLIGENT EYE sensor PCB.</p>	<p>1 Unfasten the 3 hooks and remove the INTELLIGENT EYE sensor PCB.</p>  <p>(R8092)</p> <p>2 Disconnect the connector [S26] from the INTELLIGENT EYE sensor PCB.</p>  <p>(R8093)</p>	
<p>5. Remove the signal receiver PCB.</p>	<p>1 Unfasten the 3 hooks and remove the signal receiver PCB.</p>  <p>(R8090)</p> <p>2 Disconnect the connector [S48] from the signal receiver PCB.</p>  <p>(R8091)</p>	

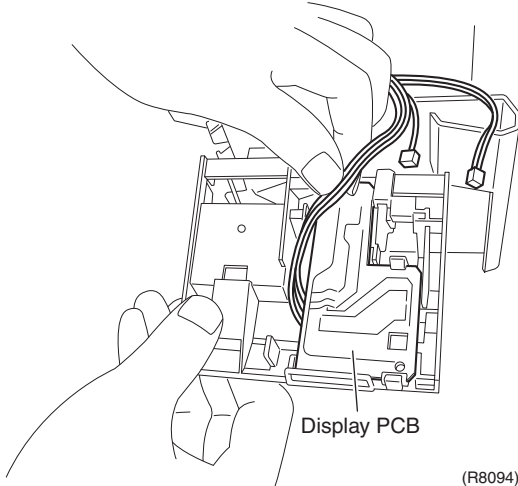
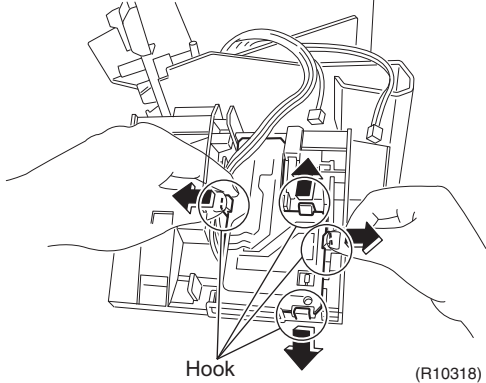
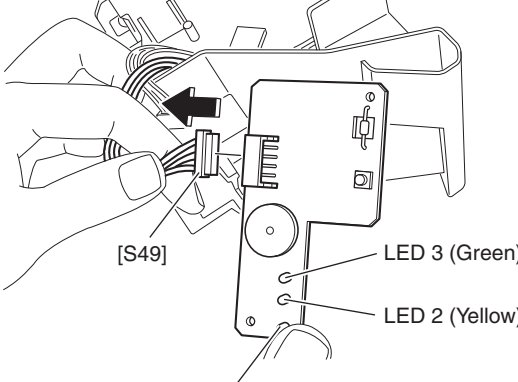
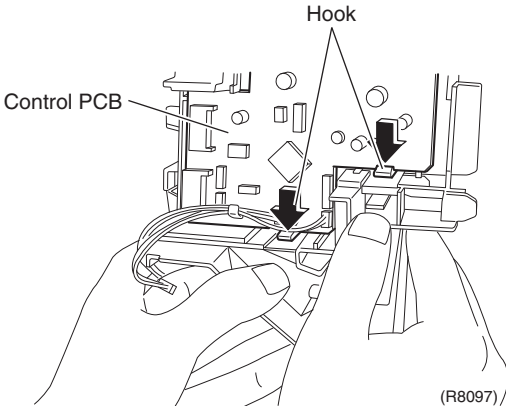
Step	Procedure	Points
<p>6. Remove the display PCB.</p> <p>1 The figure shows the connection of wire harness for the display PCB.</p> <p>2 Unfasten the 4 hooks and remove the display PCB.</p> <p>3 Disconnect the connector [S49] from the display PCB.</p>	 <p>(R8094)</p>  <p>(R10318)</p>  <p>(R8096)</p>	<ul style="list-style-type: none"> <li>■ The display PCB is positioned on the rear side of the signal receiver unit.</li> </ul>
<p>7. Remove the control PCB.</p> <p>1 Unfasten the lower 2 hooks of the control PCB.</p>	 <p>(R8097)</p>	

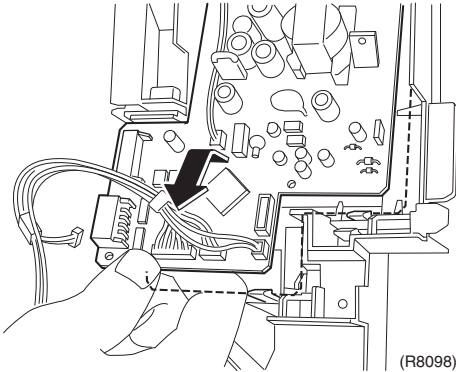
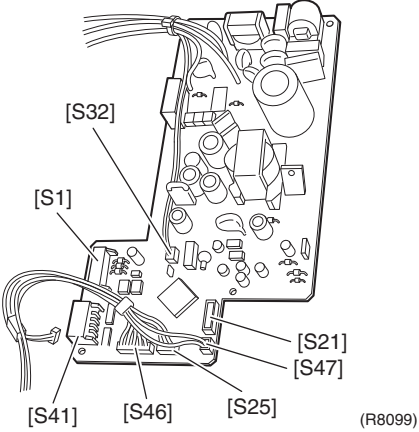
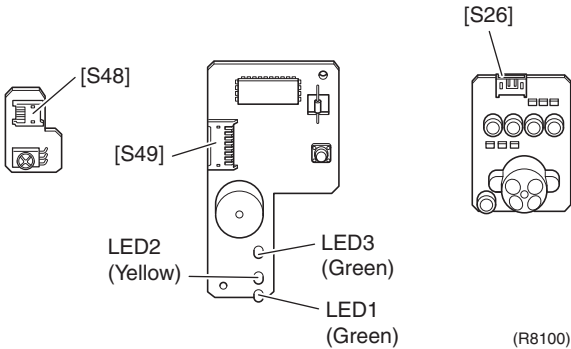
Step	Procedure	Points
<p>2</p> <p>Lift up the bottom of the control PCB and pull it out.</p>	 <p>(R8098)</p>	<ul style="list-style-type: none"> <li>When mounting the control PCB, make sure that it is fixed by upper 2 hooks.</li> </ul>
<p>3</p> <p>The figures show the names of the PCB component parts.</p>	 <p>(R8099)</p>  <p>(R8100)</p>	<ul style="list-style-type: none"> <li>[S1]: DC fan motor</li> <li>[S21]: HA connector</li> <li>[S25]: INTELLIGENT EYE sensor PCB</li> <li>[S26]: control PCB</li> <li>[S32]: indoor heat exchanger thermistor</li> <li>[S41]: swing motors</li> <li>[S46]: display PCB</li> <li>[S47]: signal receiver PCB</li> <li>[S48] [S49]: control PCB</li> </ul> <ul style="list-style-type: none"> <li>Refer to page 9, 10 for detail.</li> </ul>



# 1.7 Removal of Indoor Heat Exchanger

**Procedure**



**Warning**

Be sure to turn off all power supplies at least 10 min. before disassembling work.

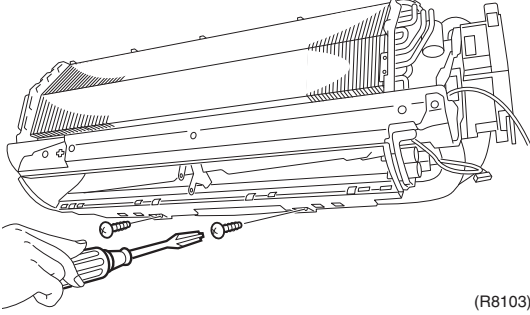
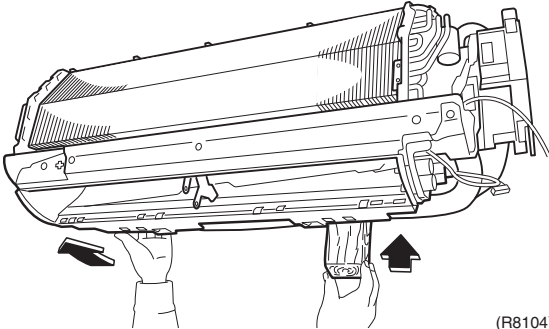
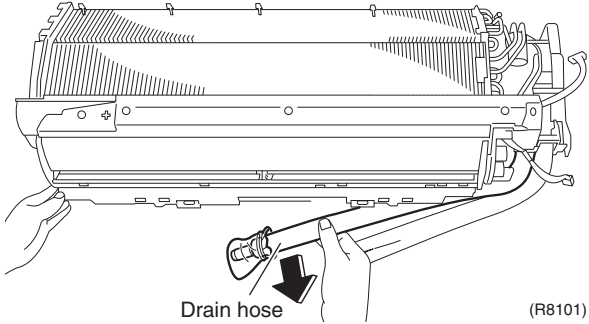
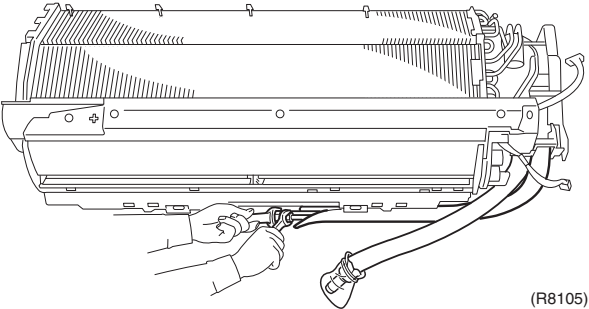
Step	Procedure	Points
1. Disconnect the refrigerant piping.		
1	<p>Remove the screws which fix the indoor heat exchanger to the installation plate.</p>  <p>(R8103)</p>	
2	<p>Lift the indoor unit with a wooden base.</p>  <p>(R8104)</p>	<p><b>Caution</b></p> <p>In pump-down work, be sure to stop the compressor before disconnecting the refrigerant pipe. If the refrigerant pipe is disconnected with the compressor operating and the stop valve open, air may be sucked in to generate an over-pressure in refrigeration cycle, thus resulting in pipe rupture or accidental injury.</p> <ul style="list-style-type: none"> <li>■ Place a plastic sheet under the drain pan to prevent from wetting the floor with remaining drain.</li> <li>■ If the drain hose is embedded in the wall, disconnect the drain hose beforehand.</li> </ul>
3	<p>Lift up the indoor unit slightly and pull out the drain hose. (The illustration is for the case of left piping.)</p>  <p>Drain hose (R8101)</p>	
4	<p>Disconnect the piping connection with 2 wrenches.</p>  <p>(R8105)</p> <p><b>Caution</b></p> <p>From the viewpoint of global environment protection, be sure to use a vacuum pump for air purging.</p>	<ul style="list-style-type: none"> <li>■ Carry out the removal works with 2 wrenches.</li> <li>■ When the pipings are disconnected, protect the both openings of pipe side and unit side from entering of moisture.</li> </ul>

Step	Procedure	Points
2.	Remove the indoor heat exchanger.	<b>Preparation</b> ■ Remove the indoor unit from the installation plate.
1	Unfasten the hook of the piping fixture at the back of the indoor unit and pull out the pipe.	
2	Widen the auxiliary pipe by about 10-20 degrees.	 <b>Caution</b> When dismantling or mounting the indoor heat exchanger, be sure to wear gloves or wrap it with cloth before proceeding. (You may be injured by the fins.)
3	Remove the 2 screws on the left side.	
4	Unfasten the lower hook on the right side with a flat screwdriver.	

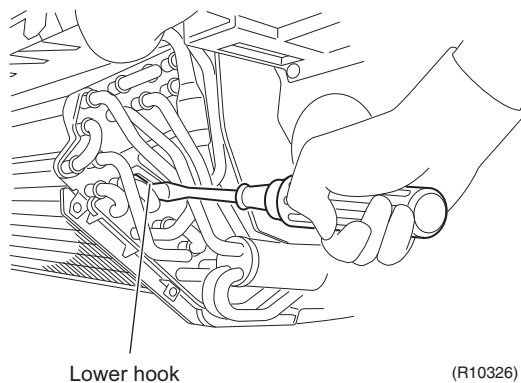
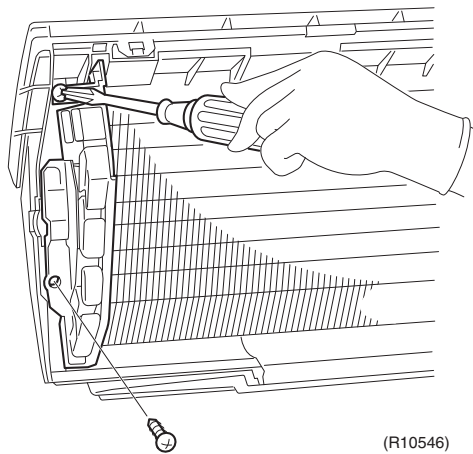
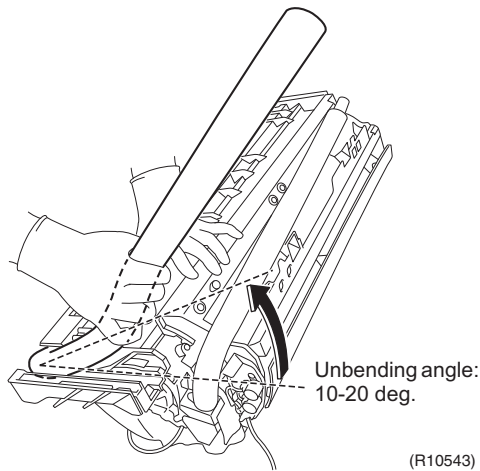
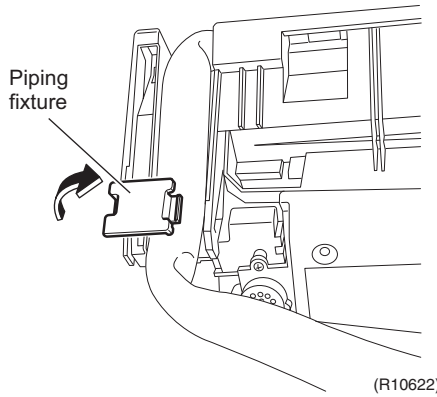

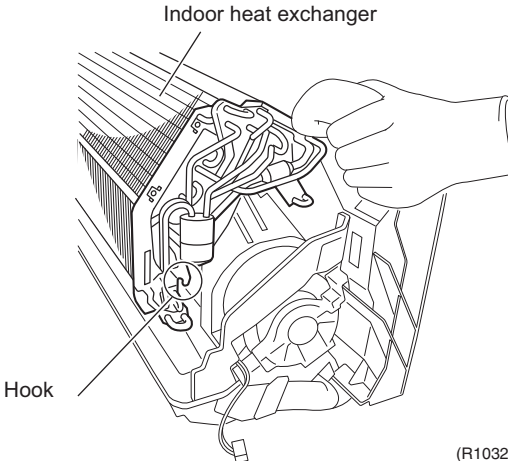
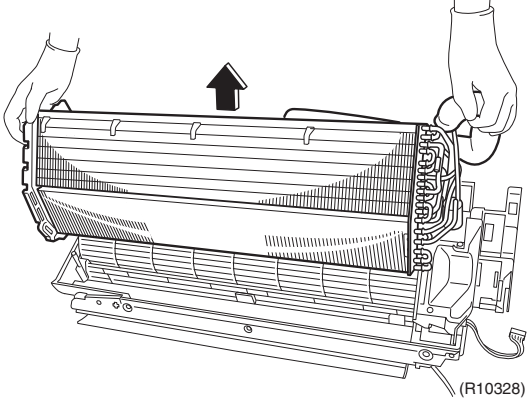
Step	Procedure	Points
5	<p>After unfastening the lower hooks, lift up the indoor heat exchanger by its right side.</p> 	<ul style="list-style-type: none"> <li>When mounting the indoor heat exchanger, make sure that the hook (right) is fastened.</li> </ul>
6	<p>Remove the indoor heat exchanger.</p> 	

## 1.8 Removal of Swing Motors

### Procedure



### Warning

Be sure to turn off all power supplies at least 10 minutes before disassembling work.

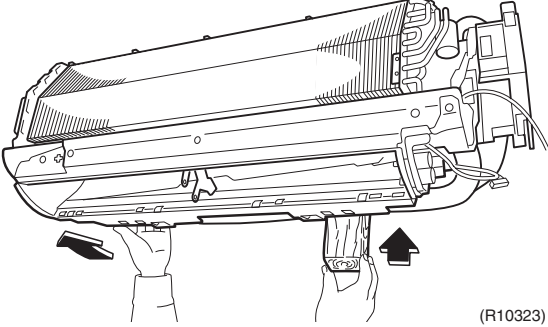
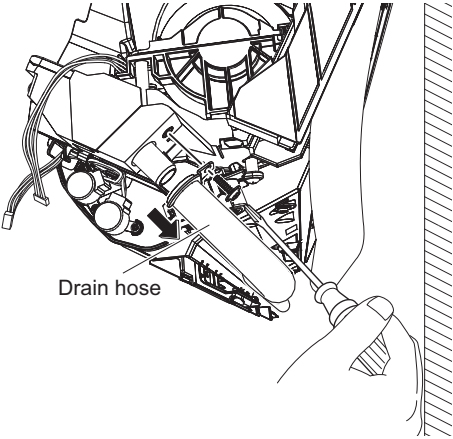
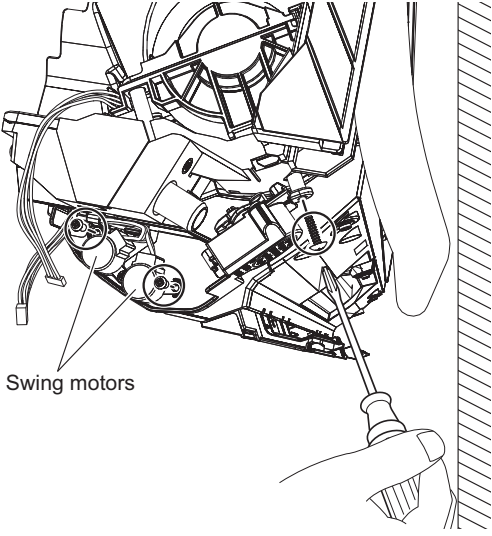
Step	Procedure	Points
1.	Remove the swing motor for vertical blade.	
1	Lift the indoor unit with a wooden base.	 <p>(R10323)</p>
2	Remove the screw behind the drain hose, and disconnect the drain hose.	 <p>Drain hose</p> <p>(R10329)</p>
3	Remove the screw at the rear, and remove the screws on the right and the left side of the swing motors.	 <p>Swing motors</p> <p>(R10330)</p>

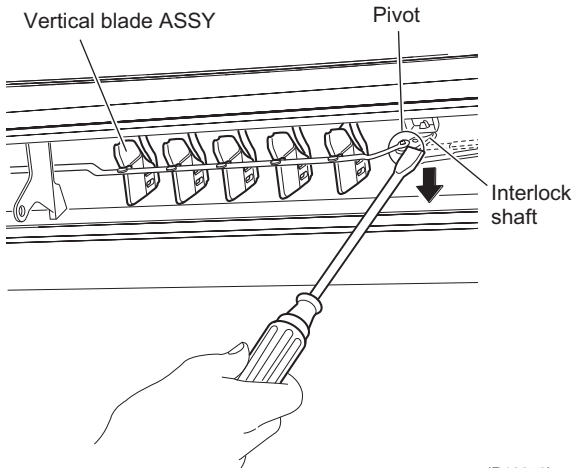
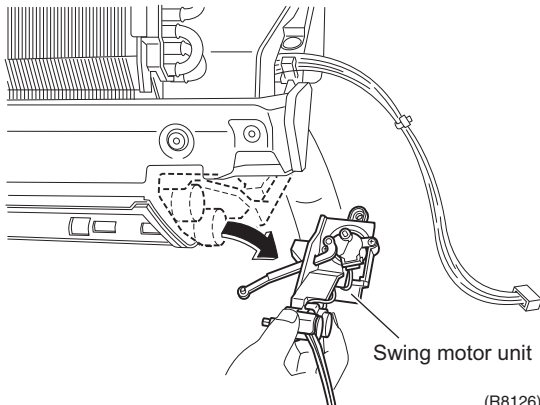
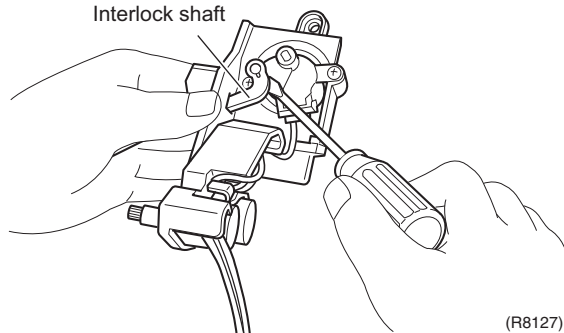
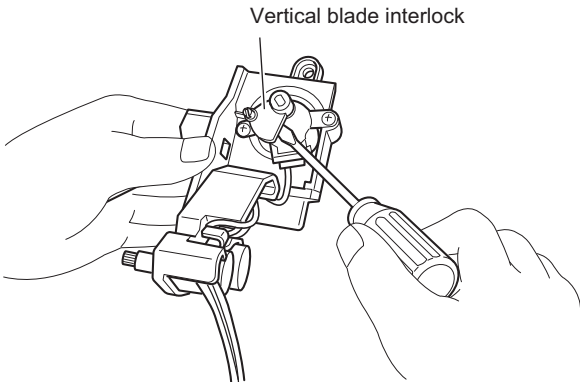
Step	Procedure	Points
4	<p>Detach the pivot from the interlock shaft for vertical blades with a flat screwdriver.</p> 	
5	<p>Remove the swing motor unit.</p> 	
6	<p>Detach the interlock shaft from the swing motor with a flat screwdriver.</p> 	
7	<p>Remove the vertical blade interlock with a flat screwdriver.</p> 	

Step	Procedure	Points
8	Remove the 2 screws.	
9	Remove the swing motor for vertical blade.	
10	Disconnect the connector.	<p>■ Connector : green</p>

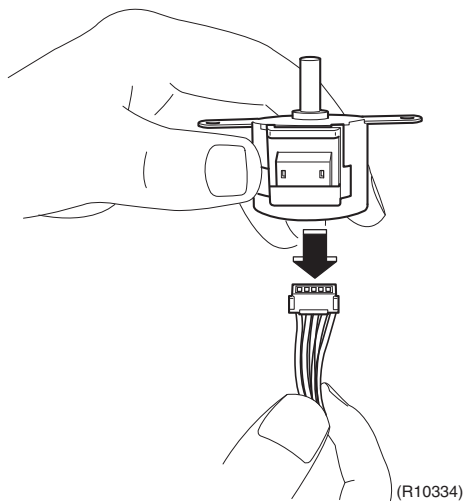
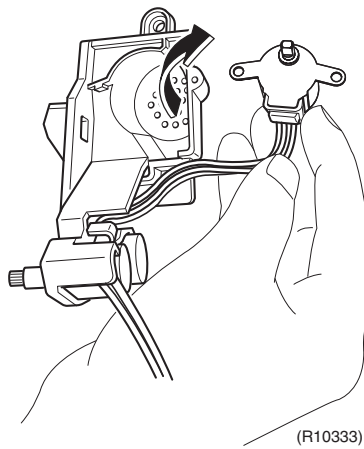
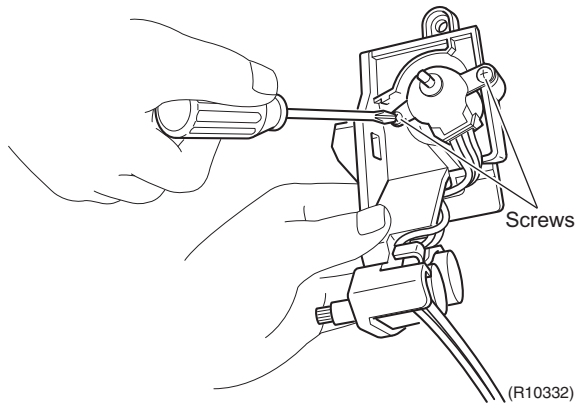

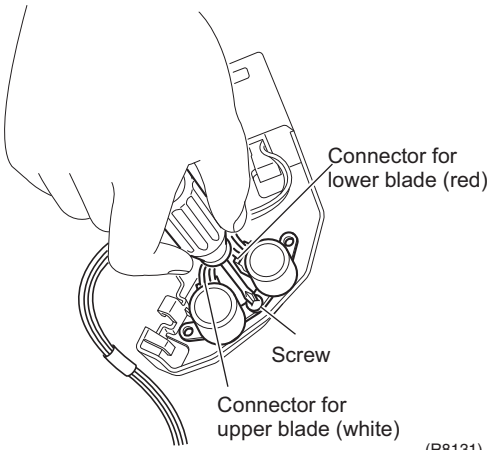
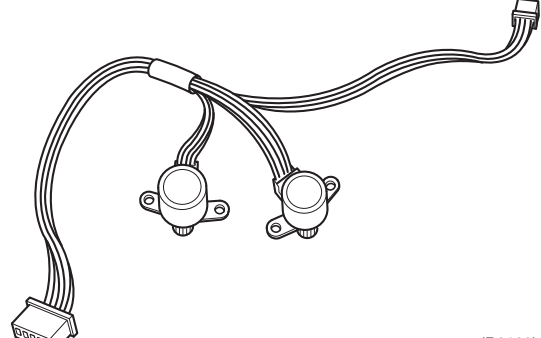
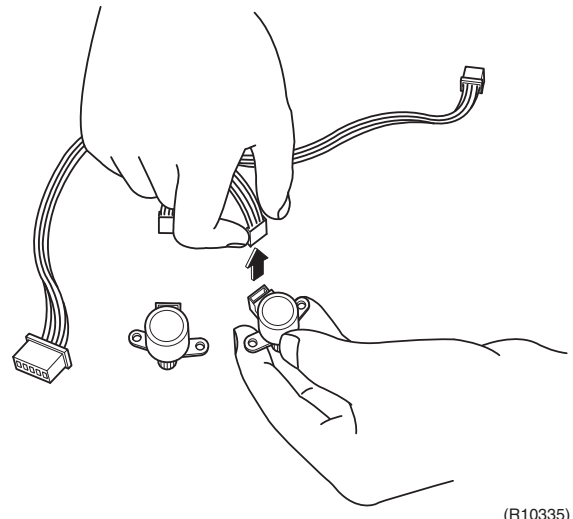
Step	Procedure	Points
2.	Remove the swing motor for horizontal blade.	
1	<p>Remove the screw and remove the swing motors for horizontal blades.</p>  <p>(R8131)</p>  <p>(R8132)</p>	<p><b>Caution</b></p> <p>When reassembling, do not confuse the installing order of the 2 motors and the colors of the connectors. If you set the connectors or motors opposite, the horizontal blades do not move smoothly or the noise may be heard.</p> <p>(1) Set the motor for the upper blade first. (connector: white)</p> <p>(2) Then, set the motor for the lower blade. (connector: red)</p> <p>(3) Fix the both motors with a screw.</p>
2	<p>Disconnect the harnesses from the motors.</p>  <p>(R10335)</p>	

## 1.9 Removal of Fan Motor

### Procedure



### Warning

Be sure to turn off all power supplies at least 10 min. before disassembling work.

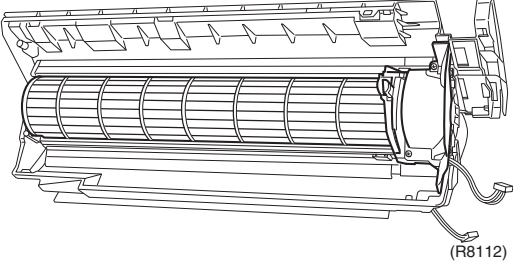
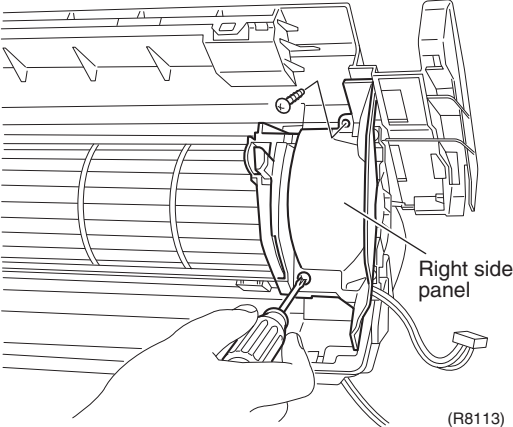
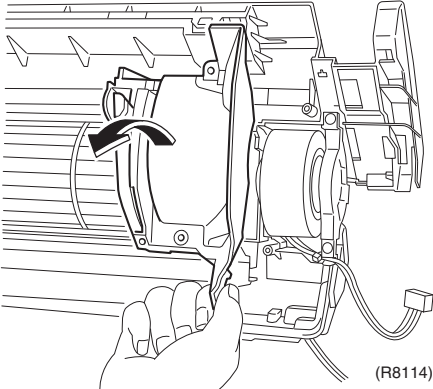
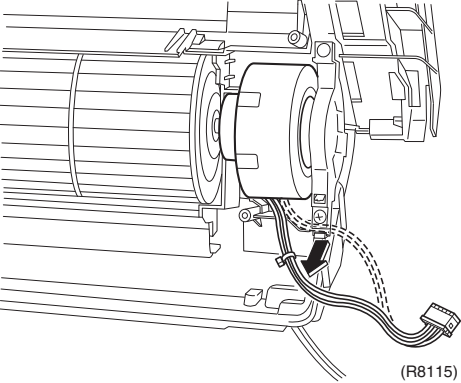
Step	Procedure	Points
1. Remove the right side panel.	 <p>(R8112)</p>  <p>Right side panel (R8113)</p>  <p>(R8114)</p>	<p><b>Preparation</b></p> <ul style="list-style-type: none"> <li>Remove the indoor heat exchanger according to the "Removal of Indoor Heat Exchanger".</li> </ul>
2. Release the fan motor wire harness from the hook.	 <p>(R8115)</p>	

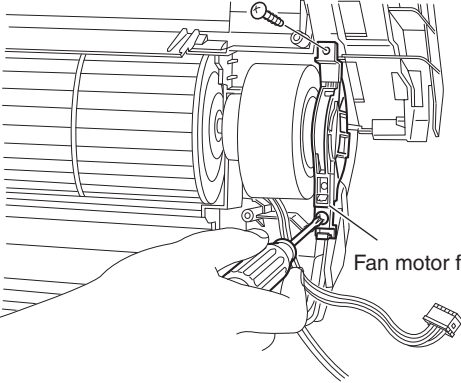
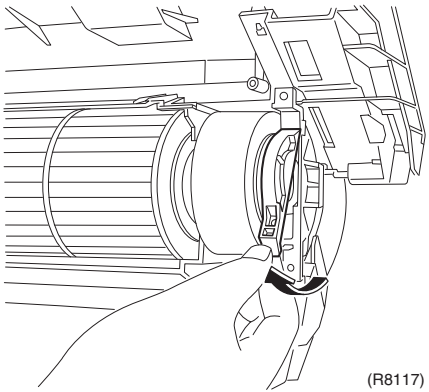
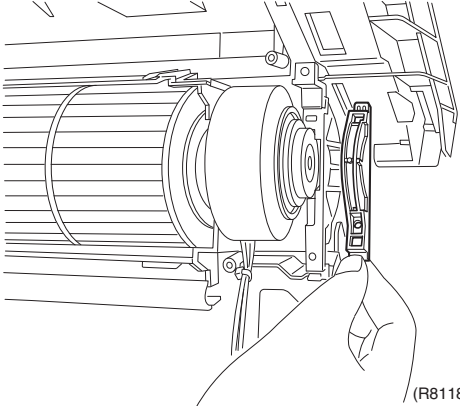
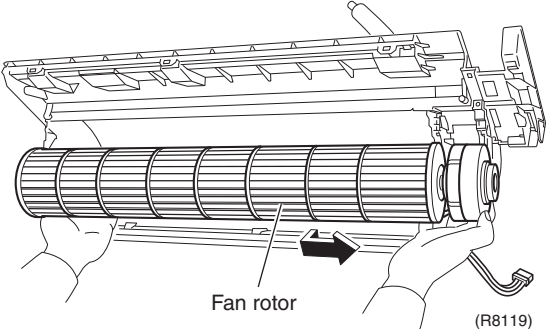

Step	Procedure	Points
<p>3 Remove the 2 screws of the fan motor fixing plate.</p>	 <p>Fan motor fixing plate</p> <p>(R8116)</p>	
<p>4 Unfasten the hook of the fan motor fixing plate and remove the plate.</p>	 <p>(R8117)</p>  <p>(R8118)</p>	
<p>2. Remove the fan rotor.</p>		
<p>1 Dislocate the fan rotor by sliding it to the right.</p>	 <p>Fan rotor</p> <p>(R8119)</p>	

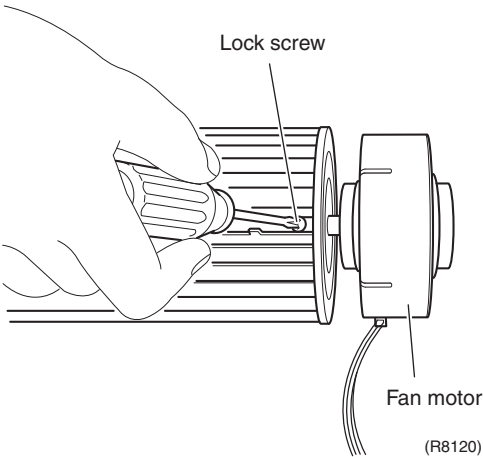
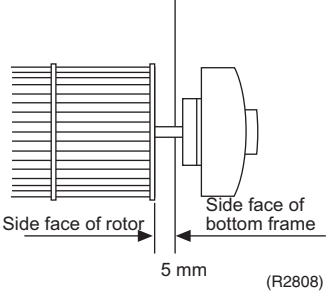
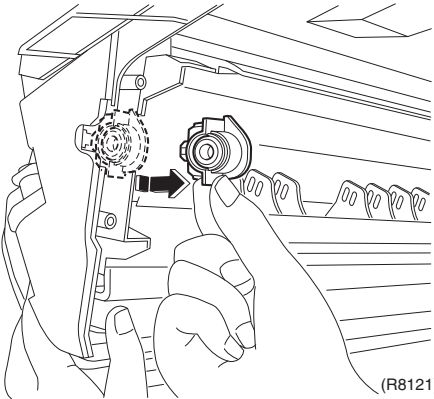
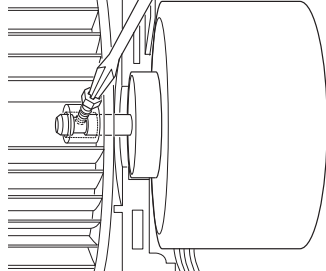
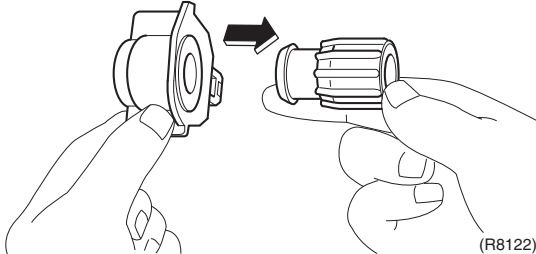
Step	Procedure	Points
2	<p>Loosen the lock screw and remove the fan rotor.</p>  <p style="text-align: right;">(R8120)</p>	<ul style="list-style-type: none"> <li>■ When reassembling the fan rotor, provide as much as 5 mm of play between the side face of the rotor and the bottom frame.</li> </ul>  <p style="text-align: right;">(R2808)</p>
3	<p>Press the bearing ASSY from outside.</p>  <p style="text-align: right;">(R8121)</p>	 <p style="text-align: right;">(R9582)</p> <ol style="list-style-type: none"> <li>(1) Insert the fan motor with approx. 5 mm left.</li> <li>(2) Tighten the screw until it stops. Then turn the screw in one scroll.</li> <li>(3) Move the fan rotor and confirm the fan motor and the fan rotor are installed appropriately.</li> <li>(4) Tighten the screw completely if appropriate.</li> <li>(5) If not appropriate, go back to (1).</li> </ol>
4	<p>Remove the bearing.</p>  <p style="text-align: right;">(R8122)</p>	

## 2. Outdoor Unit - RXL20G2V1B

### 2.1 Removal of Outer Panels / Fan Motor

**Procedure**



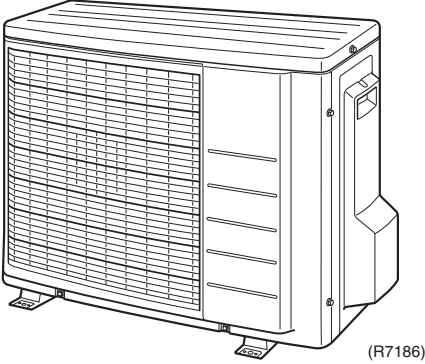
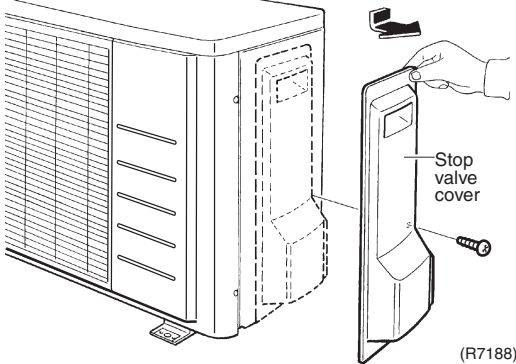

**Warning** Be sure to wait for 10 minutes or more after turning off all power supplies before disassembling work.

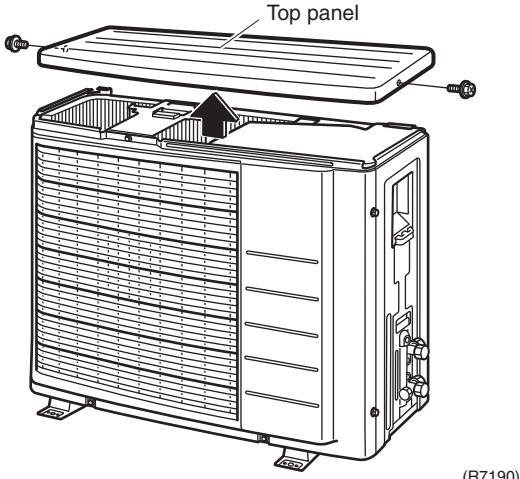
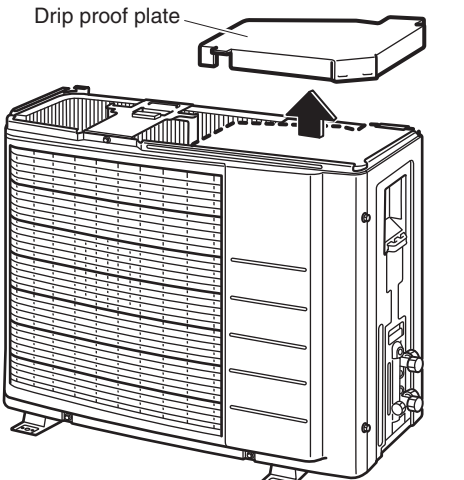
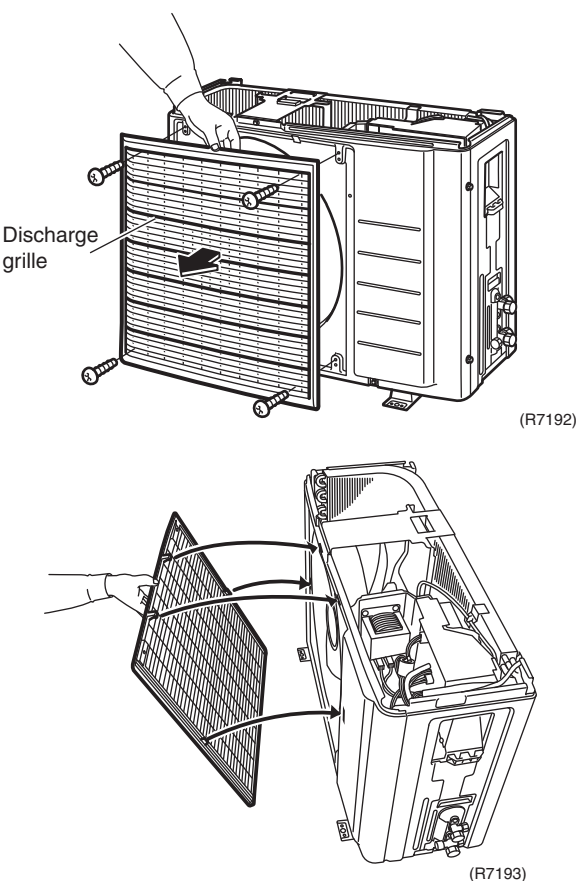
Step	Procedure	Points
1. Appearance features	 <p>(R7186)</p>	<ul style="list-style-type: none"> <li>■ Take care not to cut your finger by the fins of the outdoor heat exchanger.</li> </ul>
2. Remove the panels.	<p>1 Remove the screw of the stop valve cover. Pull down the stop valve cover and remove it.</p>  <p>(R7188)</p>	<ul style="list-style-type: none"> <li>■ The stop valve cover is united with the shield plate.</li> <li>■ When reassembling, make sure to fit the 5 hooks.</li> </ul>

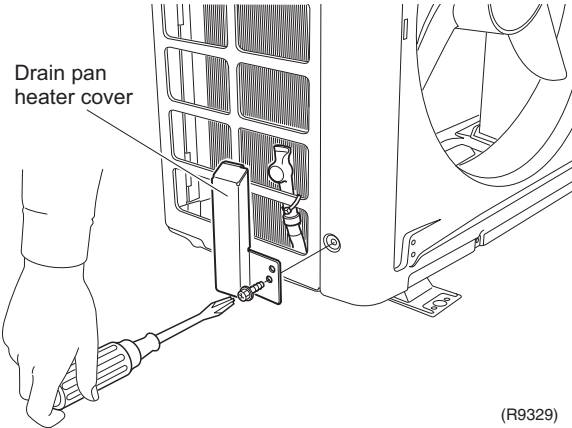
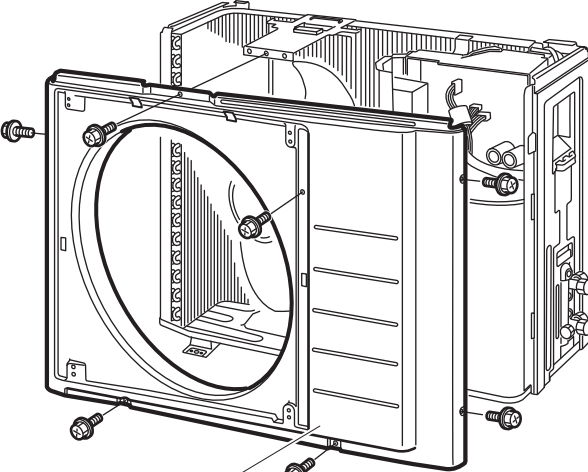
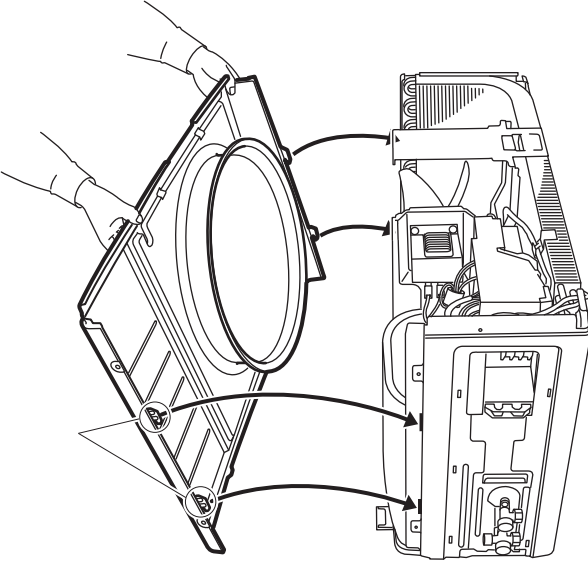
Step	Procedure	Procedure	Points
2	Remove the 2 screws and lift the top panel.	 <p>Top panel</p> <p>(R7190)</p>	
3	Remove the drip proof plate.	 <p>Drip proof plate</p> <p>(R7191)</p>	
4	Remove the 4 screws and remove the discharge grille.	 <p>Discharge grille</p> <p>(R7192)</p> <p>(R7193)</p>	<p>■ The discharge grille has 4 hooks.</p>

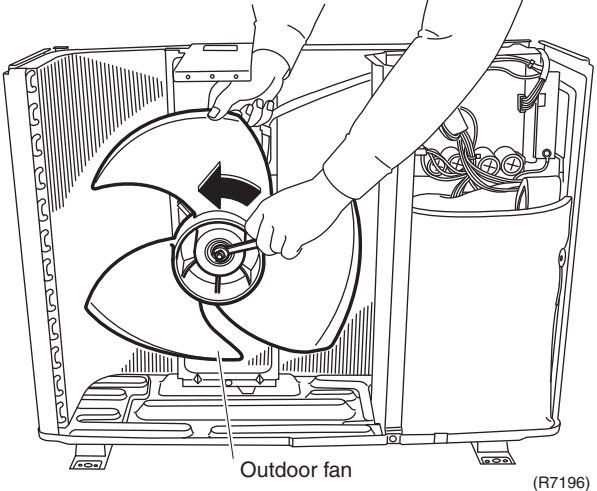
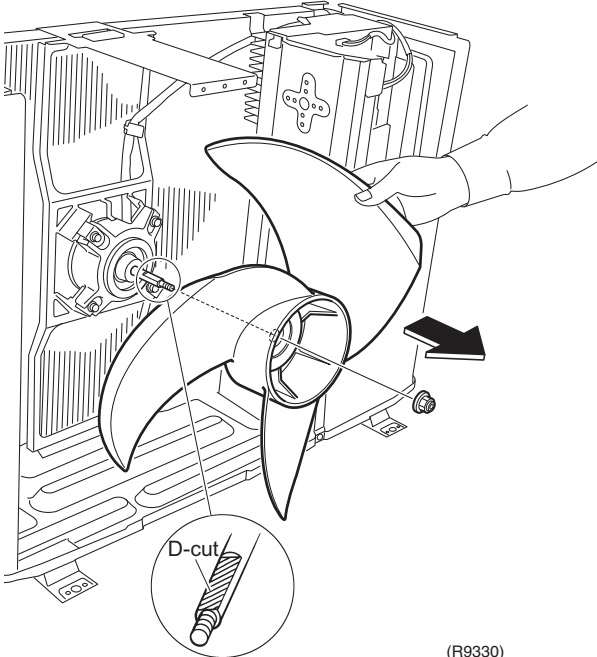
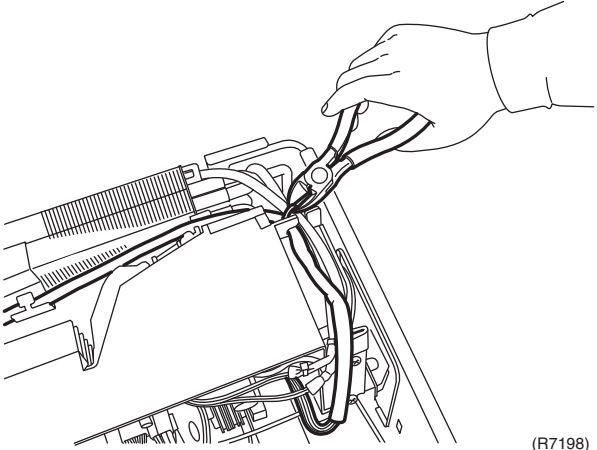
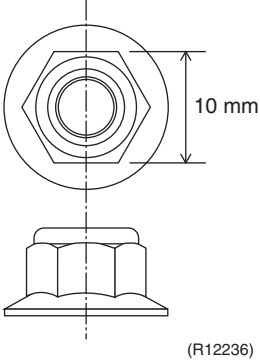
Step	Procedure	Points
5	<p>Remove the screw and remove the drain pan heater cover.</p>  <p>(R9329)</p>	
6	<p>Remove the 7 screws of the front panel.</p>  <p>(R12304)</p>	
7	<p>Unfasten the hooks. Pull and remove the front panel.</p>  <p>(R7195)</p>	<p>■ The front panel has 4 hooks.</p>

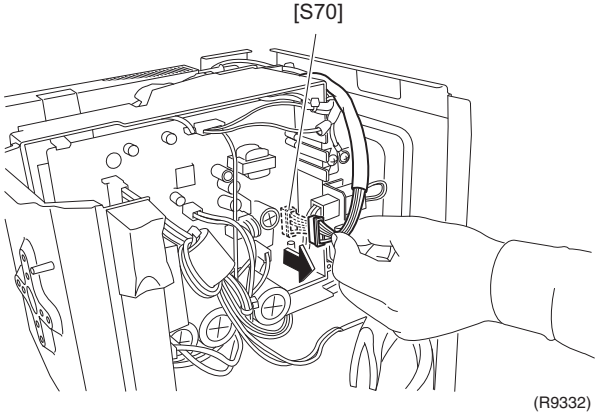
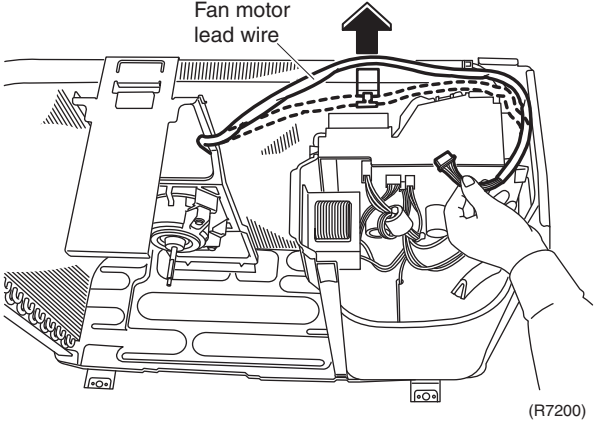
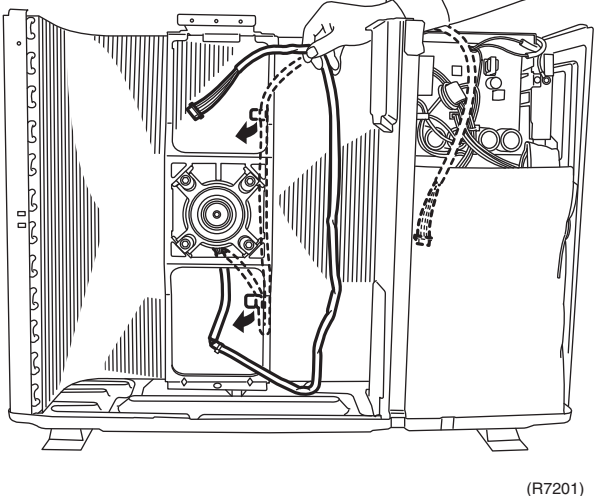
Step	Procedure	Points
3. Remove the fan motor.	<p data-bbox="151 248 464 344">1 Remove the washer-fitted nut of the outdoor fan.</p>  <p data-bbox="151 730 464 790">2 Remove the outdoor fan.</p>  <p data-bbox="151 1424 464 1453">3 Cut the clamp.</p> 	<ul style="list-style-type: none"> <li>■ The screw has reverse winding.</li> <li>■ Nut size: M6</li> </ul>  <p data-bbox="1331 669 1401 689">(R12236)</p> <ul style="list-style-type: none"> <li>■ When reassembling, align ▼ mark of the outdoor fan with D-cut section of the motor shaft.</li> </ul>

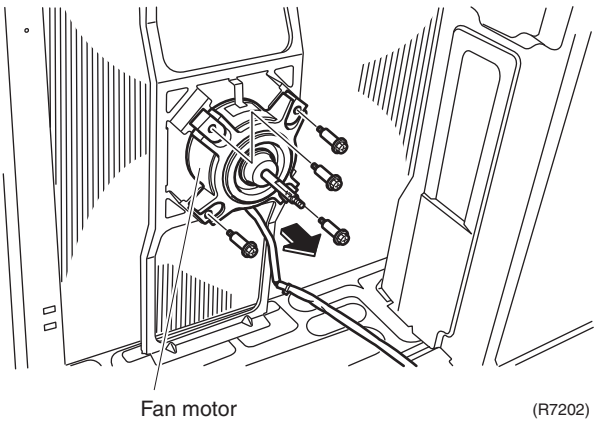
Step	Procedure	Points
4	<p>Disconnect the connector for the fan motor [S70].</p>  <p>(R9332)</p>	
5	<p>Release the fan motor lead wire from the hook.</p>  <p>(R7200)</p>	
6	<p>Open the hooks and release the fan motor lead wire.</p>  <p>(R7201)</p>	<ul style="list-style-type: none"> <li>When reassembling, put the fan motor lead wire through the back of the fan motor (so as not to be entangled with the outdoor fan).</li> </ul>  <p>Lead wire      Outdoor fan (R3249)</p>
7	<p>Remove the 4 screws and remove the fan motor.</p>  <p>Fan motor (R7202)</p>	<ul style="list-style-type: none"> <li>Be sure to remove the lower screws first. If the upper screws are removed first, the fan motor, the center of gravity of which is toward the front, may tilt down or fall, getting you injured.</li> </ul>

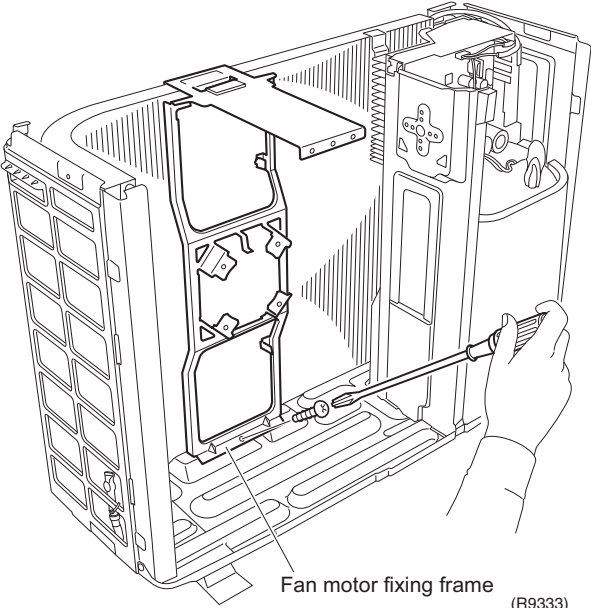
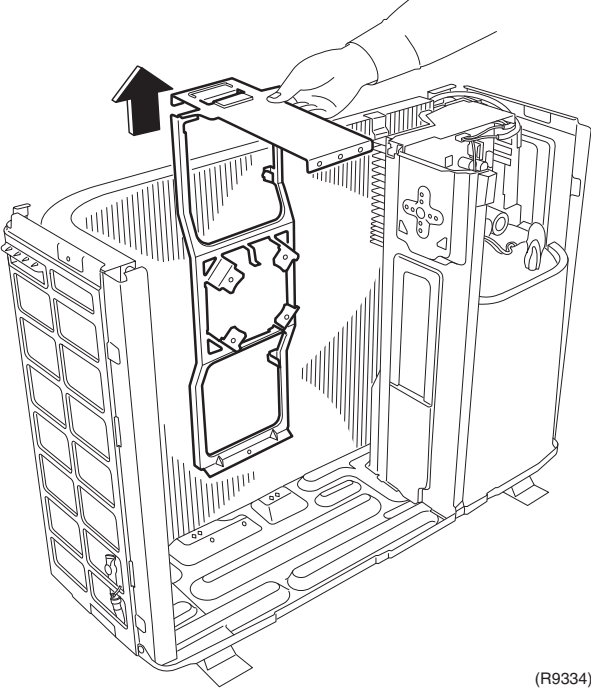
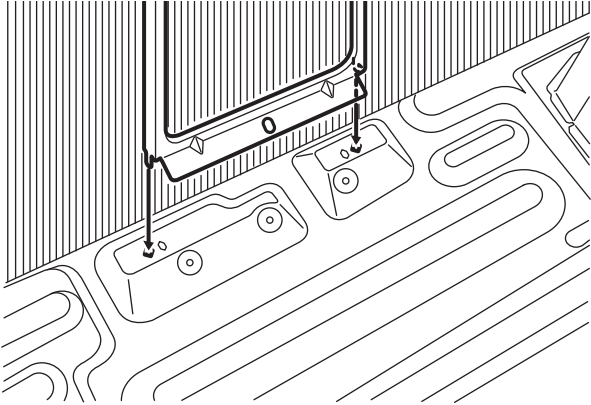
Step	Procedure	Points
8	<p data-bbox="199 219 459 309">Remove the screw and remove the fan motor fixing frame.</p>  <p data-bbox="762 808 1054 853">Fan motor fixing frame (R9333)</p>  <p data-bbox="1018 1554 1078 1576">(R9334)</p>  <p data-bbox="1018 2033 1078 2056">(R7206)</p>	<ul style="list-style-type: none"> <li data-bbox="1093 1576 1445 1666">■ When reassembling, fit the lower hooks into the bottom frame.</li> </ul>

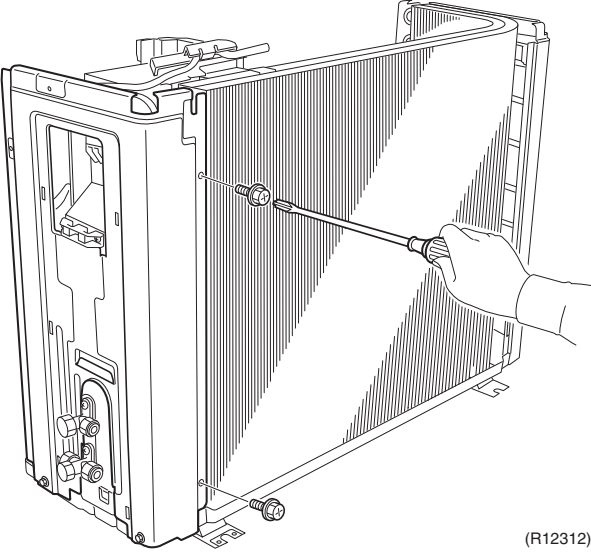
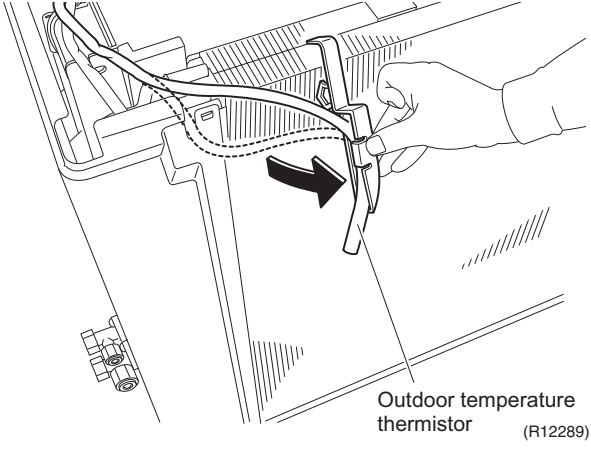
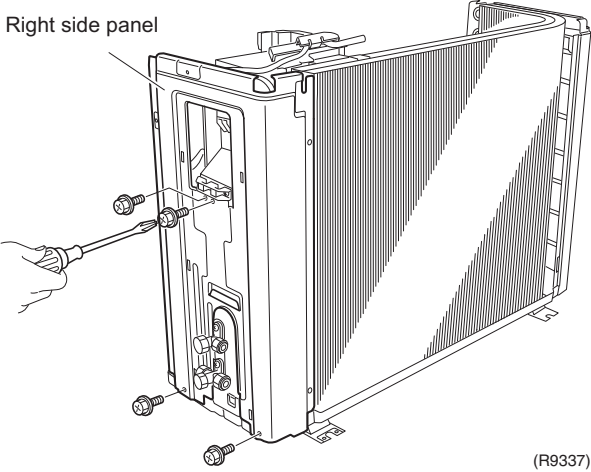

Step	Procedure	Points
4. Remove the right side panel.		
1 Remove the 2 screws on the rear side.	 <p>(R12312)</p>	
2 Release the outdoor temperature thermistor.	 <p>Outdoor temperature thermistor (R12289)</p>	
3 Remove the 4 screws on the right side panel.	 <p>Right side panel</p> <p>(R9337)</p>	

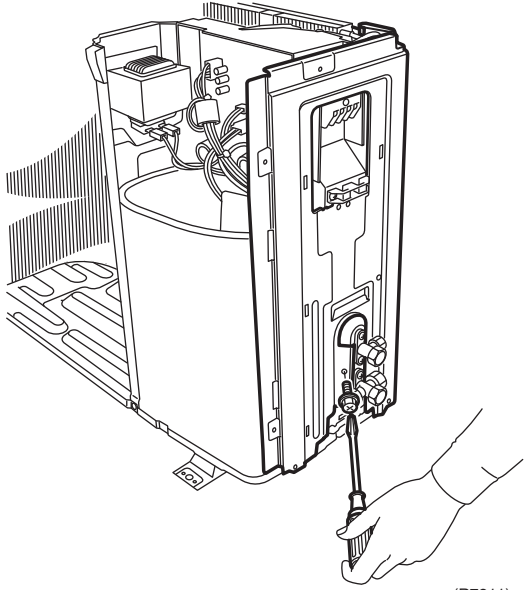
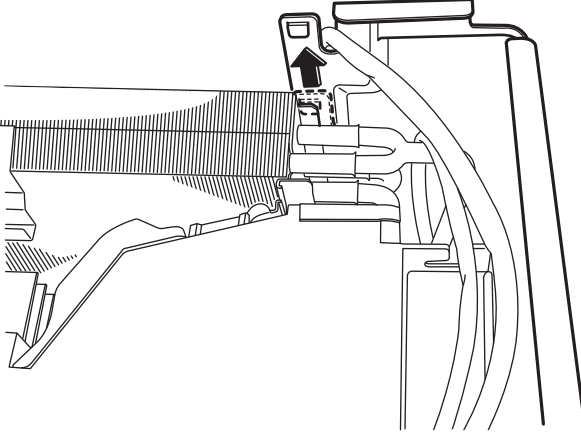
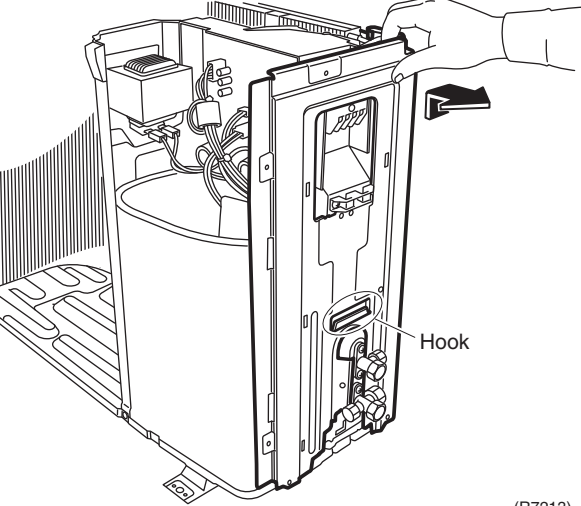
Step	Procedure	Points
4	<p>Remove the screw near the stop valves.</p>  <p>(R7211)</p>	
5	<p>Unfasten the hook on the rear side.</p>  <p>(R7212)</p>	<ul style="list-style-type: none"> <li>■ When reassembling, make sure to fit the hook.</li> </ul>
6	<p>Lift up the right side panel and remove it.</p>  <p>Hook</p> <p>(R7213)</p>	<ul style="list-style-type: none"> <li>■ When reassembling, make sure to fit the hook.</li> </ul>

## 2.2 Removal of Electrical Box

**Procedure**

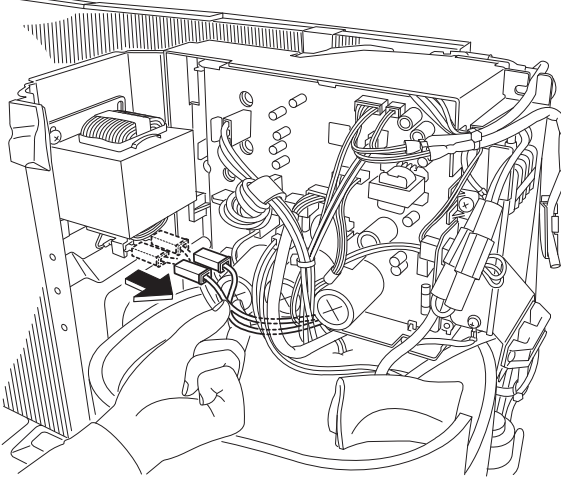
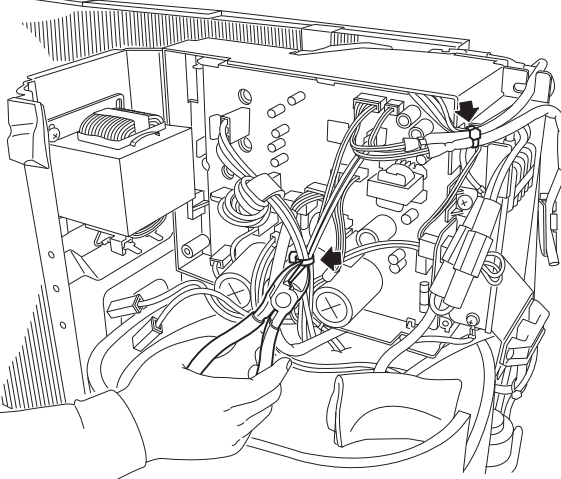
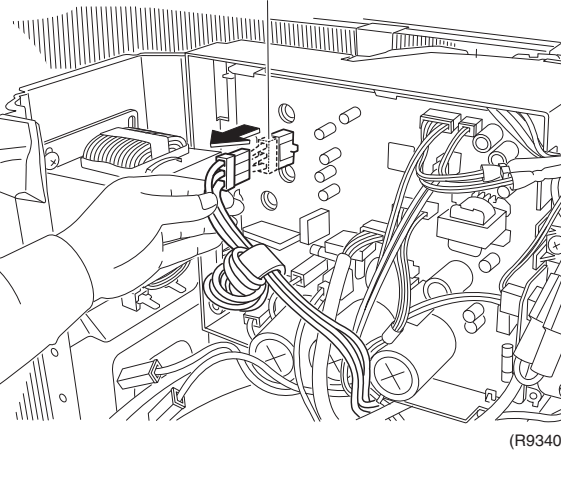

**Warning** Be sure to wait for 10 minutes or more after turning off all power supplies before disassembling work.

Step	Procedure	Procedure	Points
1	Disconnect the 2 connectors for the reactor.	 <p style="text-align: right;">(R9338)</p>	<p><b>Preparation</b></p> <ul style="list-style-type: none"> <li>Remove the panels and disconnect the connector for the fan motor according to the "Removal of Outer Panels / Fan Motor".</li> </ul>
2	Cut the clamps at 2 locations.	 <p style="text-align: right;">(R9339)</p>	
3	Disconnect the connector for the compressor [S30].	 <p style="text-align: right;">(R9340)</p>	<ul style="list-style-type: none"> <li>When reassembling, coil the excessive lead wire and hang the loop on the hook.</li> </ul>

Step	Procedure	Points
4	Disconnect the connectors for the magnetic relay [S50] and for the thermistors [S90].	(R9341)
5	Disconnect the connectors for the filter PCB [S10] and for the overload protector [S40].	(R9342)
6	Disconnect the connectors for the electronic expansion valve coil [S20] and for the four way valve coil [S80].	(R9343)

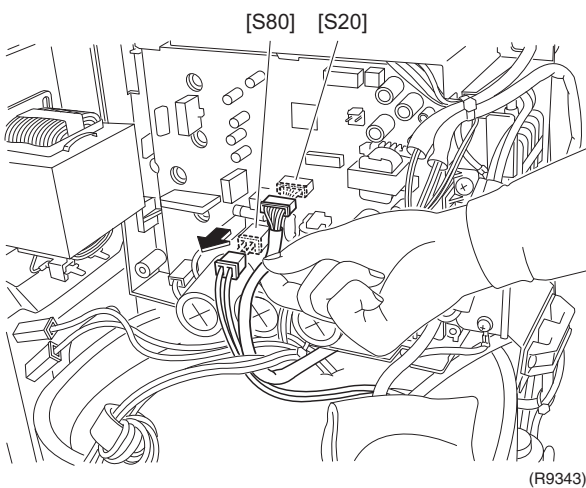
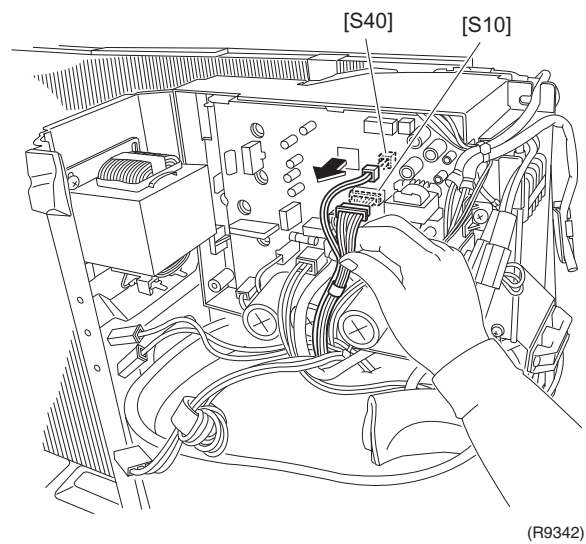
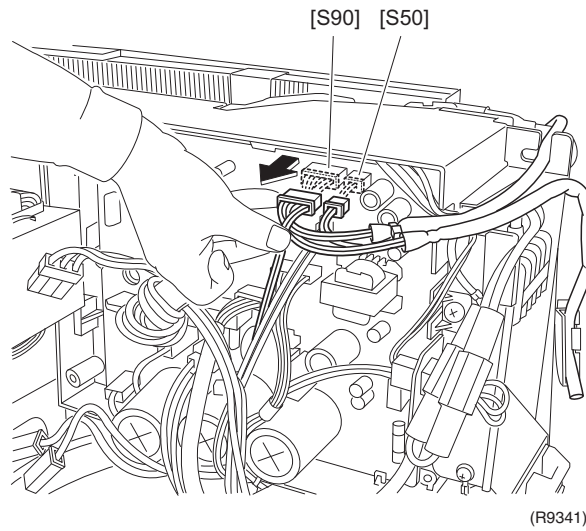

Step	Procedure	Points
7	Disconnect the connectors for the filter PCB [HL3] [HN3].	
8	Remove the wire harness for standby electricity saving.	
9	Cut the clamps at 2 locations.	
10	Disconnect the connectors for the drain pan heater with a flat screwdriver.	

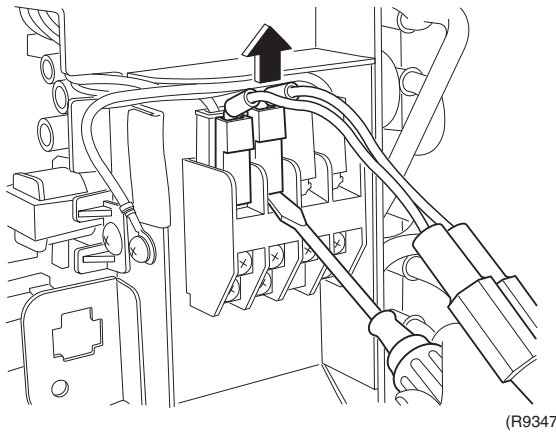
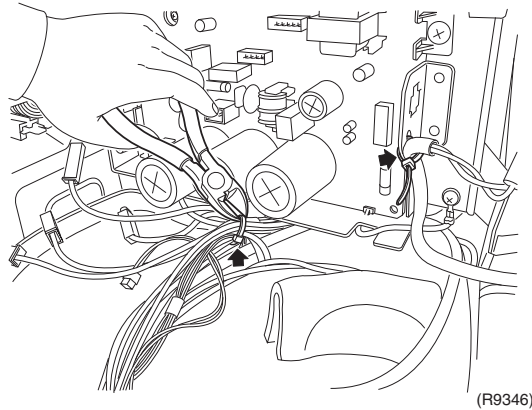
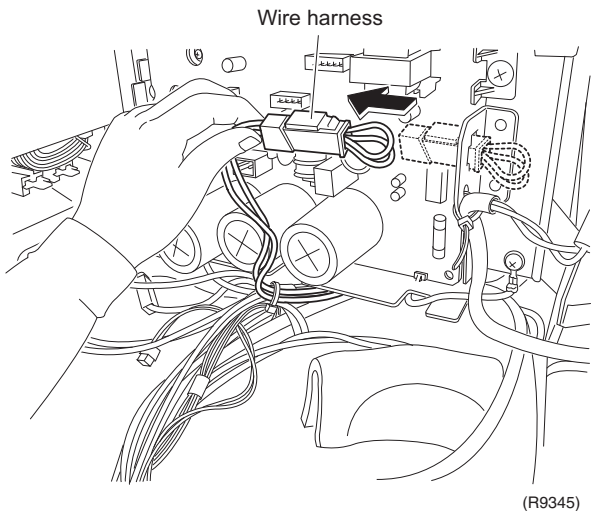
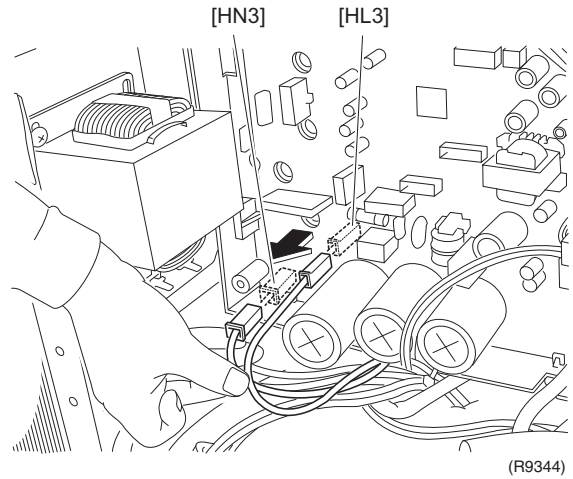

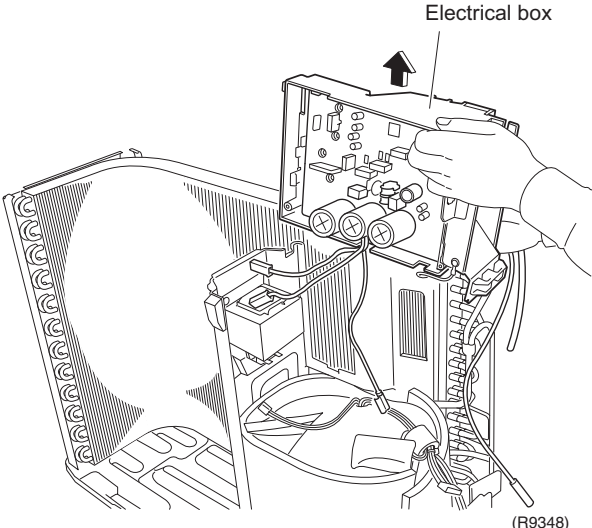
Step	Procedure	Points
11	<p data-bbox="199 219 422 280">Lift and remove the electrical box.</p>  <p data-bbox="997 734 1053 757">(R9348)</p>	

## 2.3 Removal of Drain Pan Heater

**Procedure**

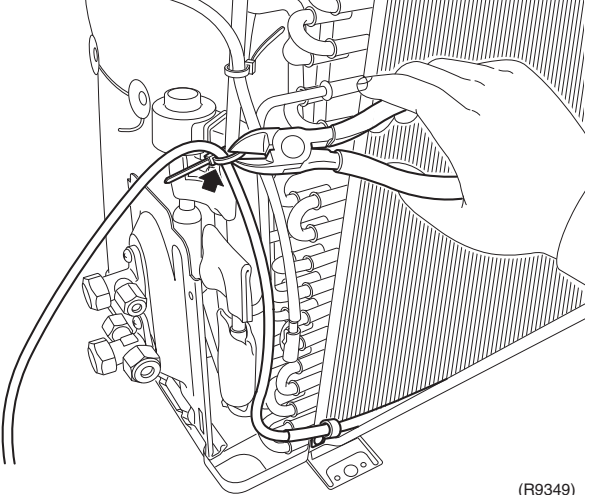
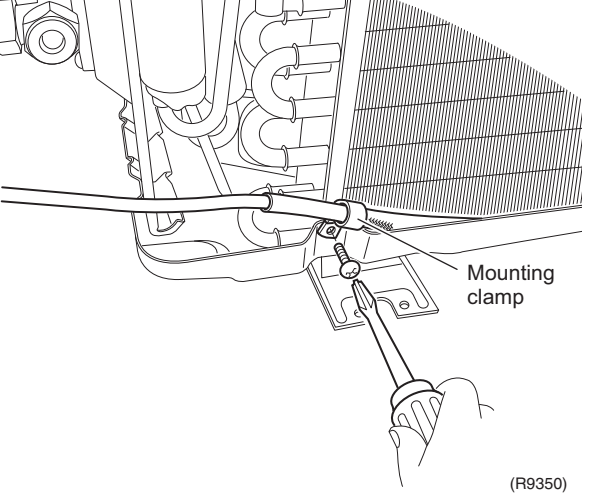
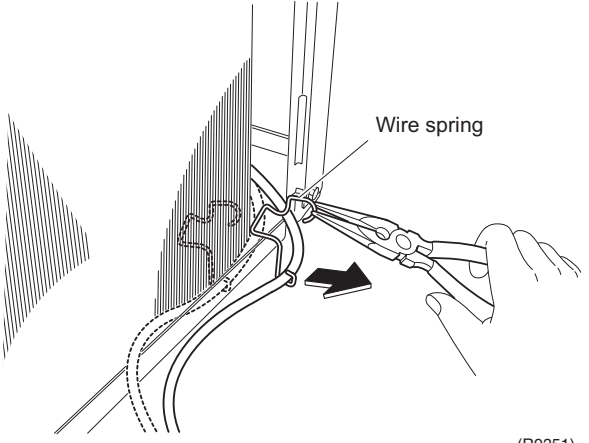
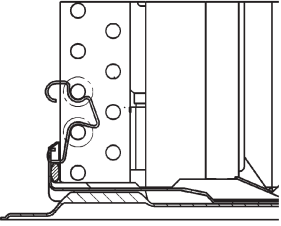

**Warning** Be sure to wait 10 minutes or more after turning off all power supplies before disassembling work.

Step	Procedure	Points
1. Remove the drain pan heater.		
1	Cut the clamp.	
	 <p style="text-align: right;">(R9349)</p>	
2	Remove the screw of the mounting clamp.	
3	<p>Release the drain pan heater ASSY from the ditch between the bottom frame and the outdoor heat exchanger ASSY. Remove the wire spring with long nose pliers.</p>  <p style="text-align: right;">(R9350)</p>  <p style="text-align: right;">(R9351)</p>	<ul style="list-style-type: none"> <li>■ Take care not to cut your finger by the fins of the outdoor heat exchanger.</li> <li>■ When reassembling, hang the wire spring to the hair pin cooling tube.</li> </ul>  <p style="text-align: right;">(R9748)</p>

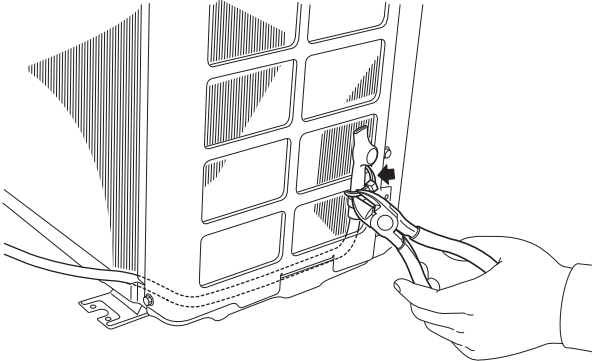
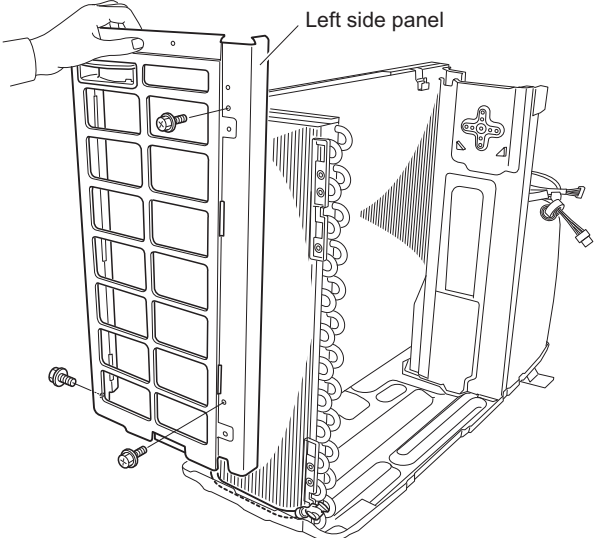
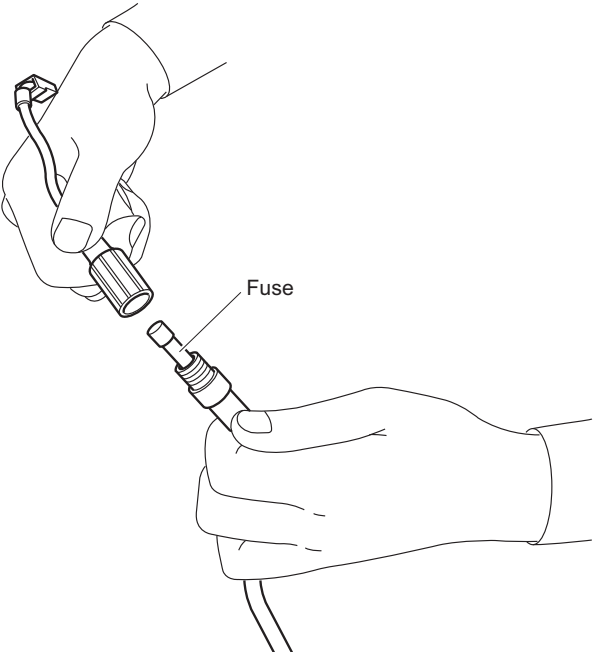
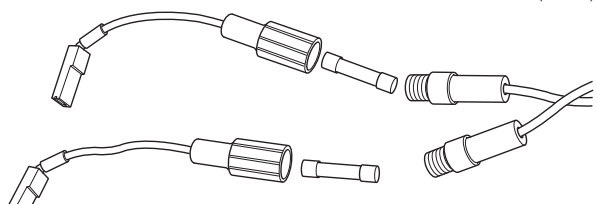
Step	Procedure	Points
4	<p data-bbox="193 215 470 248">Cut the clamp.</p>  <p data-bbox="1018 591 1082 607">(R9352)</p>	
5	<p data-bbox="193 613 470 714">Remove the 3 screws and remove the left side panel.</p>  <p data-bbox="978 1173 1082 1189">(R12307)</p>	
6	<p data-bbox="193 1189 470 1263">The fuses are inside the drain pan heater.</p>  <p data-bbox="1018 1863 1082 1879">(R9354)</p>  <p data-bbox="1002 2087 1082 2103">(R9355)</p>	



## 2.4 Removal of Thermistors

**Procedure**

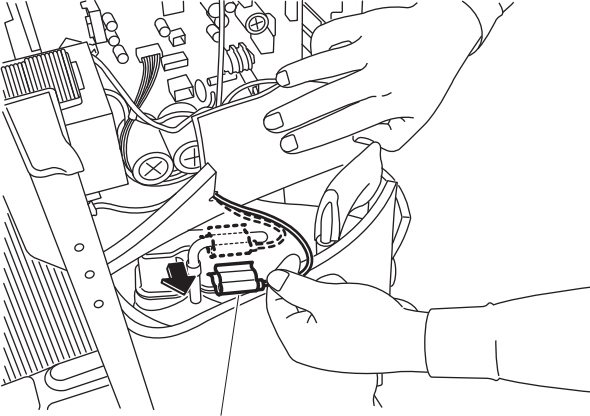
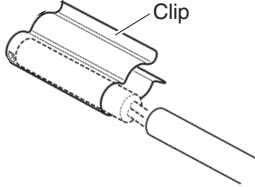
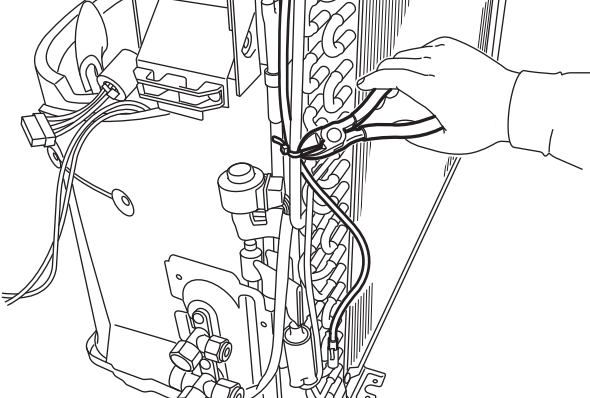
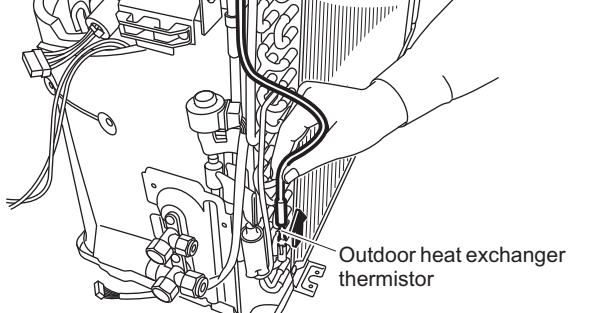
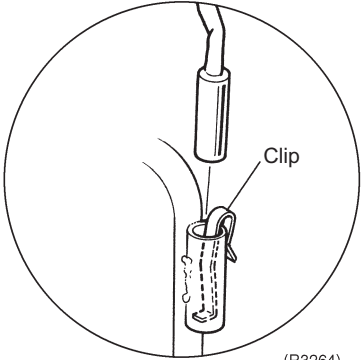

**Warning** Be sure to wait 10 minutes or more after turning off all power supplies before disassembling work.

Step	Procedure	Procedure	Points
1	Release the discharge pipe thermistor.	 <p style="text-align: center;">Discharge pipe thermistor (R0267)</p>	<p>■ Be careful not to lose the clip for the thermistor.</p>  <p style="text-align: right;">(R12279)</p>
2	Cut the clamp.	 <p style="text-align: right;">(R7221)</p>	
3	Pull out the outdoor heat exchanger thermistor.	 <p style="text-align: center;">Outdoor heat exchanger thermistor (R7222)</p>	<p>■ Be careful not to lose the clip for the thermistor.</p>  <p style="text-align: right;">(R3264)</p>

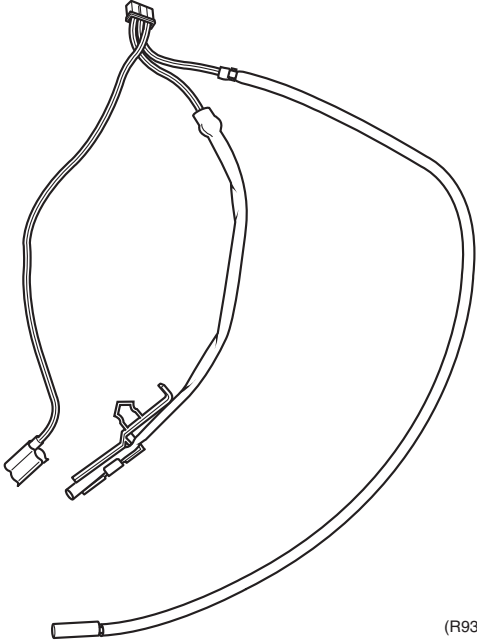
Step		Procedure	Points
4	Feature of the thermistors	 <p>(R9356)</p>	

## 2.5 Removal of PCB

**Procedure**

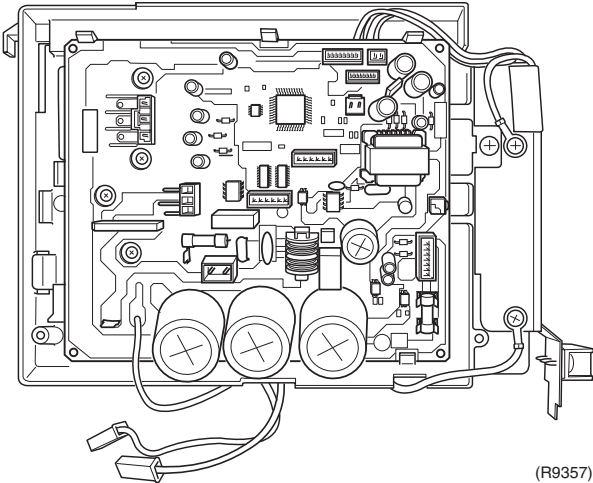
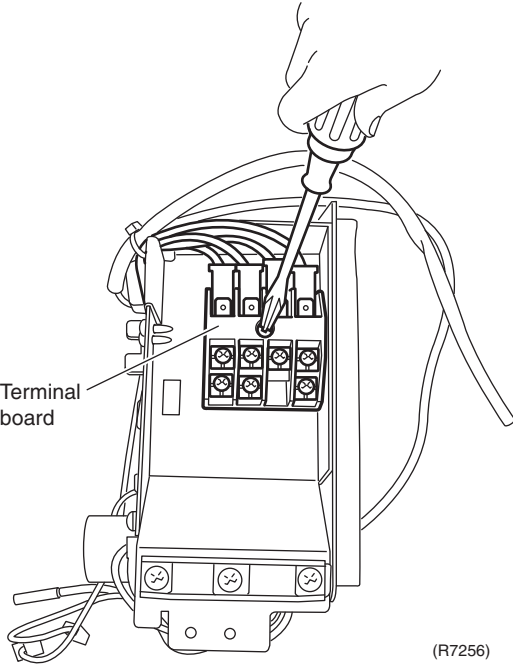
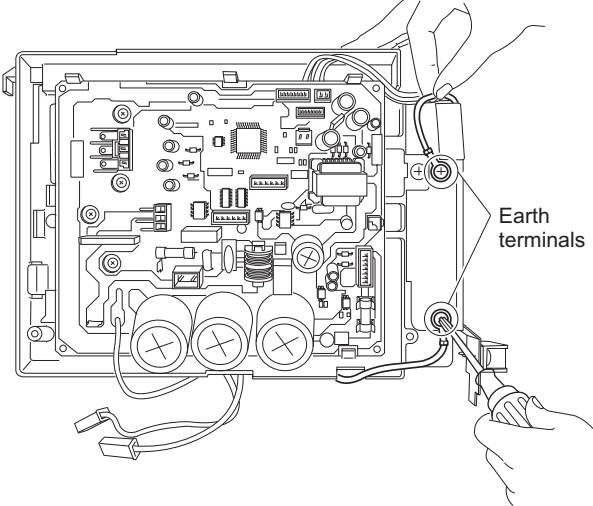

**Warning** Be sure to wait 10 minutes or more after turning off all power supplies before disassembling work.

Step	Procedure	Points
<p>1. Remove the main PCB.</p> <p>1 Feature of the main PCB</p> <p>2 Remove the screw on the terminal board.</p> <p>3 Release the 2 earth terminals.</p>	 <p>(R9357)</p>  <p>Terminal board</p> <p>(R7256)</p>  <p>Earth terminals</p> <p>(R9358)</p>	<ul style="list-style-type: none"> <li>■ You can remove the main PCB when you disconnect the lead wires on the terminal board without removing the electrical box.</li> </ul>

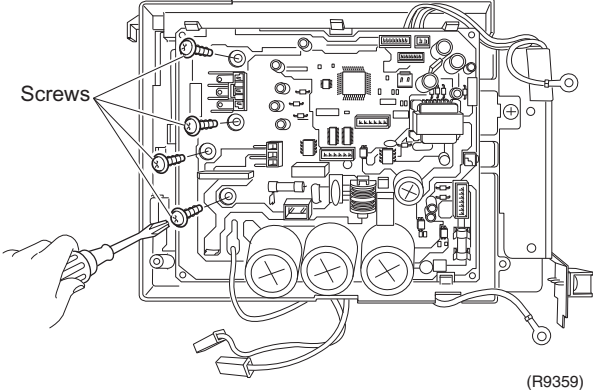
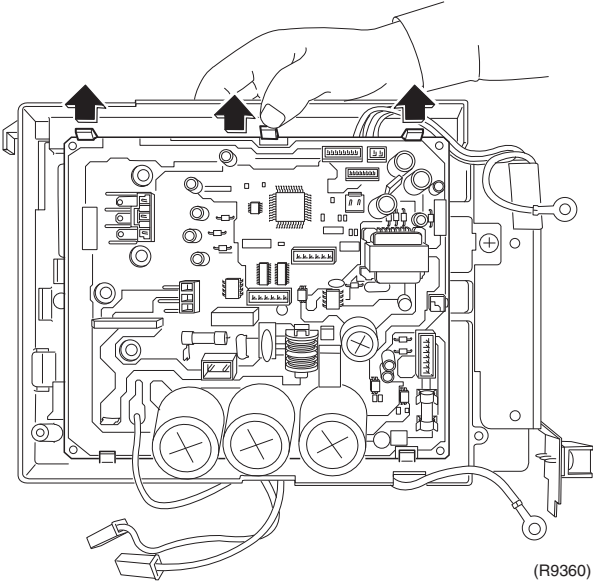
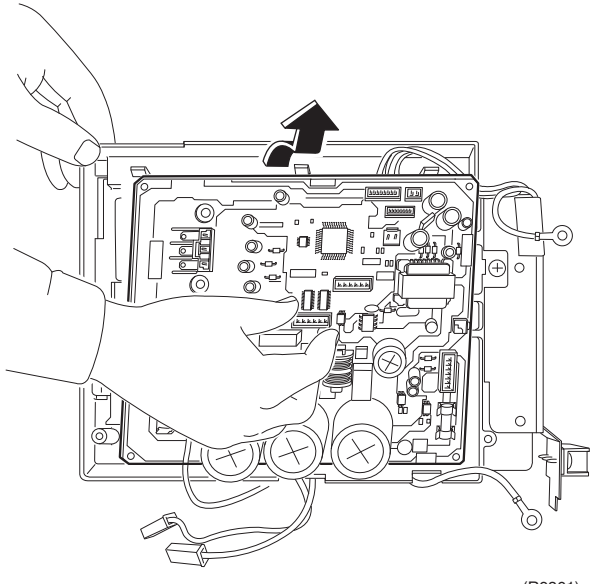
Step	Procedure	Points
4	Remove the 4 screws.	
	 <p>(R9359)</p>	
5	Unfasten the 3 hooks on the upper side.	
	 <p>(R9360)</p>	
6	Lift and pull out the main PCB.	
	 <p>(R9361)</p>	

Step	Procedure	Points
7	<p data-bbox="199 219 422 275">Feature of the main PCB</p> <p data-bbox="518 772 853 801">[HN3] [HL3] [S80] [S20]</p> <p data-bbox="1029 510 1077 539">[S70]</p> <p data-bbox="989 801 1061 831">(R12189)</p>	<p data-bbox="1093 219 1436 248">■ Refer to page 12 for detail.</p> <p data-bbox="1093 280 1412 309">[S10] [HL3] [HN3]: filter PCB</p> <p data-bbox="1093 318 1396 374">[S20]: electronic expansion valve coil</p> <p data-bbox="1093 383 1300 412">[S30]: compressor</p> <p data-bbox="1093 421 1372 450">[S40]: overload protector</p> <p data-bbox="1093 459 1332 488">[S50]: magnetic relay</p> <p data-bbox="1093 497 1268 526">[S70]: fan motor</p> <p data-bbox="1093 535 1372 564">[S80]: four way valve coil</p> <p data-bbox="1093 573 1292 602">[S90]: thermistors</p>

## 2.6 Removal of Reactor / Partition Plate

### Procedure

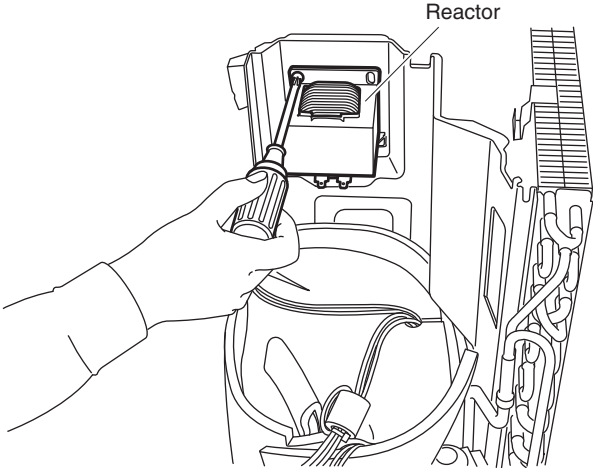
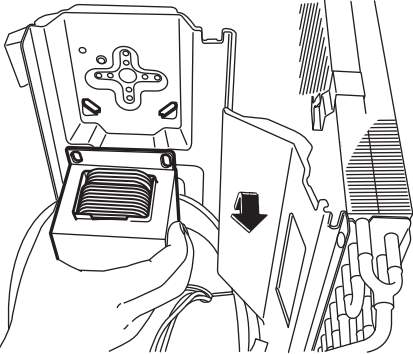
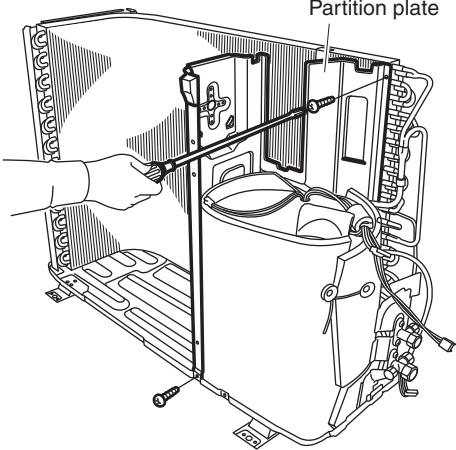

**Warning** Be sure to wait 10 minutes or more after turning off all power supplies before disassembling work.

Step	Procedure	Points
1. Remove the reactor. 1 Remove the screw and remove the reactor.	 <p>(R7224)</p>  <p>(R7225)</p>	<b>Preparation</b> <ul style="list-style-type: none"> <li>■ Remove the outer panels according to the "Removal of Outer Panels / Fan Motor".</li> <li>■ Remove the electrical box according to the "Removal of Electrical Box".</li> </ul>
2. Remove the partition plate. 1 Remove the 2 screws.	 <p>(R7226)</p>	

Step	Procedure	Points
2	<p>The partition plate has a hook on the lower side. Lift and pull the partition plate to remove.</p>	<ul style="list-style-type: none"> <li>■ When reassembling, fit the lower hook into the bottom frame.</li> </ul>

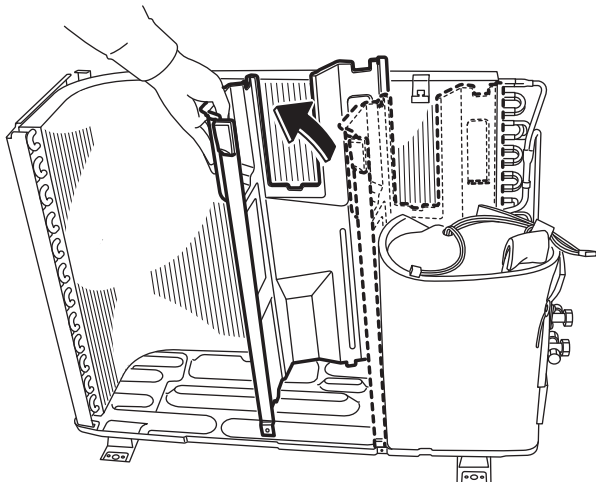

(R7227)

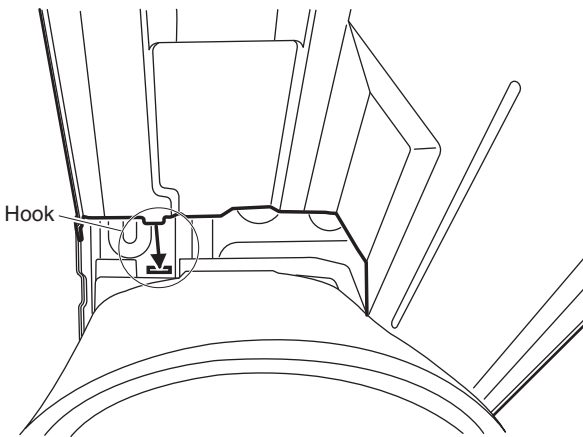

(R7228)

## 2.7 Removal of Sound Blanket

### Procedure

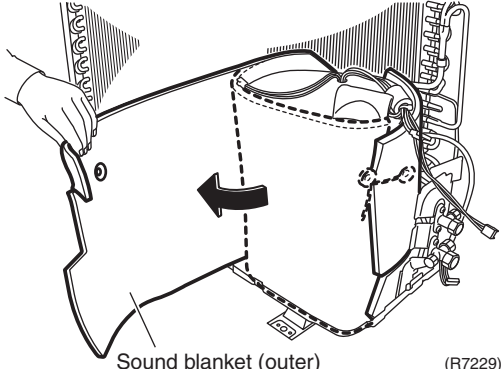
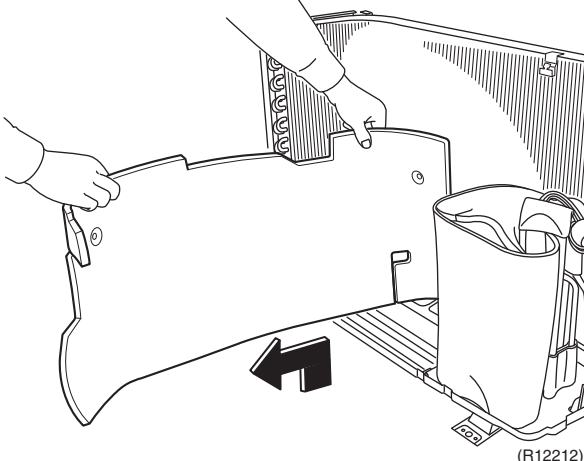
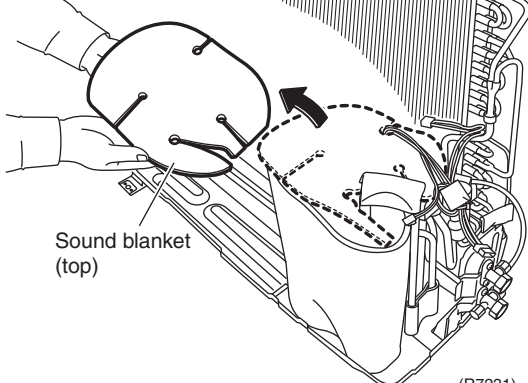
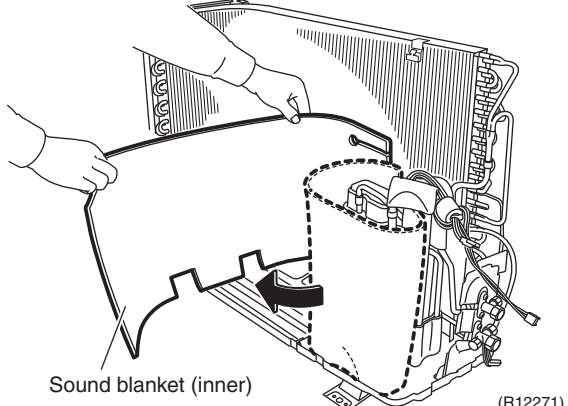

**Warning** Be sure to wait for 10 minutes or more after turning off all power supplies before disassembling work.

Step	Procedure	Procedure	Points
1	Untie the string and open the sound blanket (outer).		<p><b>Preparation</b></p> <ul style="list-style-type: none"> <li>■ Remove the outer panels according to the "Removal of Outer Panels / Fan Motor".</li> <li>■ Remove the electrical box according to the "Removal of Electrical Box".</li> </ul>
2	Lift and remove the sound blanket (outer).		<ul style="list-style-type: none"> <li>■ Since the piping ports are torn easily, remove the sound blanket carefully.</li> </ul>
3	Remove the sound blanket (top).		
4	Pull the sound blanket (inner) out.		



## 2.8 Removal of Four Way Valve

**Procedure**

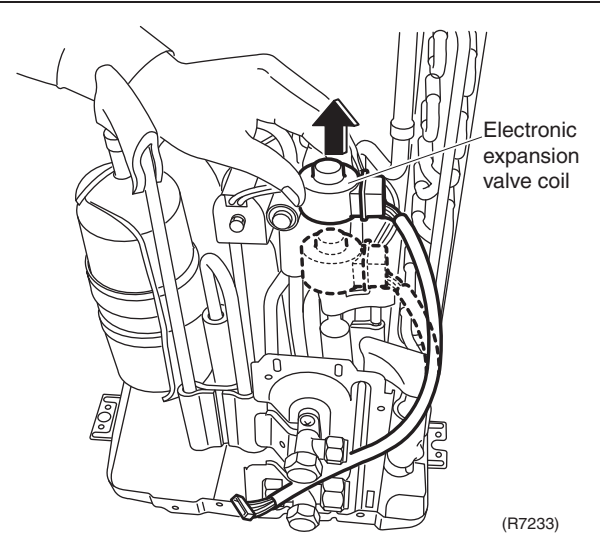
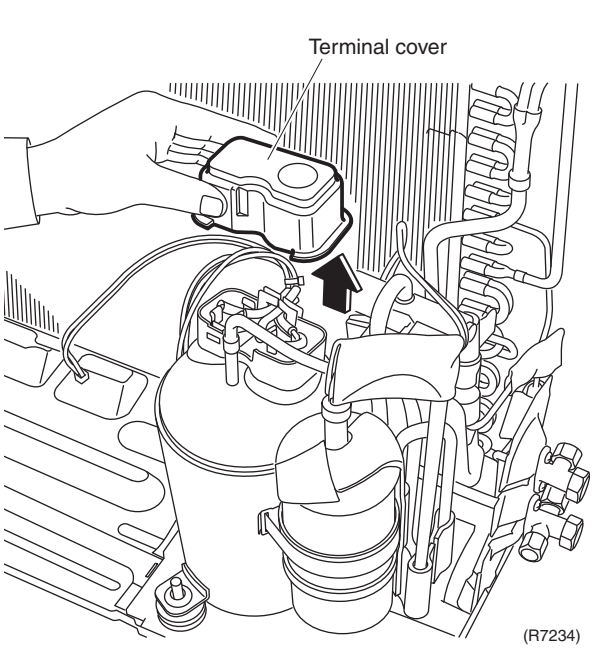
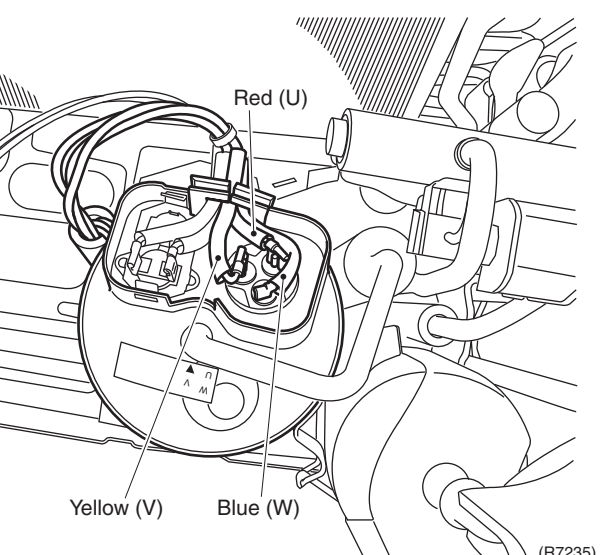

**Warning** Be sure to wait for 10 minutes or more after turning off all power supplies before disassembling work.

Step	Procedure	Procedure	Points
1	Pull out the electronic expansion valve coil.	 <p style="text-align: right;">Electronic expansion valve coil</p> <p style="text-align: right;">(R7233)</p>	
2	Remove the terminal cover.	 <p style="text-align: center;">Terminal cover</p> <p style="text-align: right;">(R7234)</p>	
3	Disconnect the lead wires of the compressor.	 <p style="text-align: center;">Red (U)</p> <p style="text-align: left;">Yellow (V)</p> <p style="text-align: center;">Blue (W)</p> <p style="text-align: right;">(R7235)</p>	

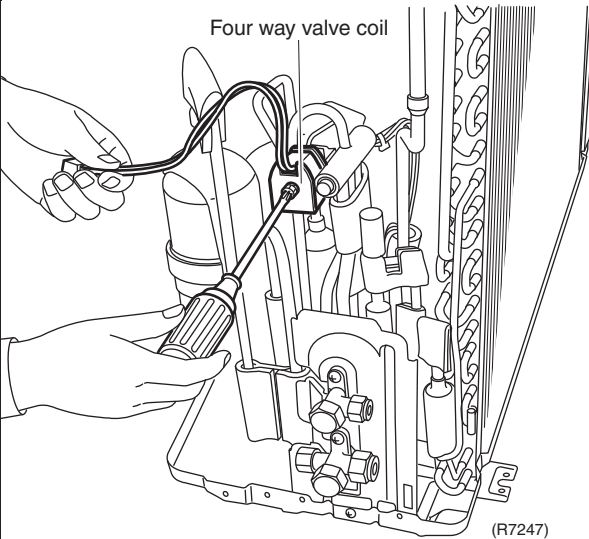
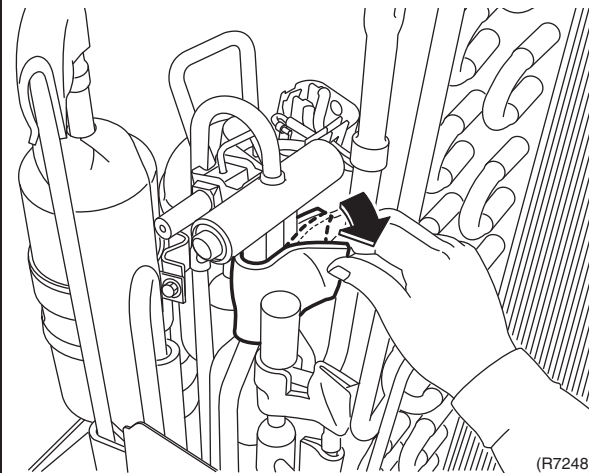
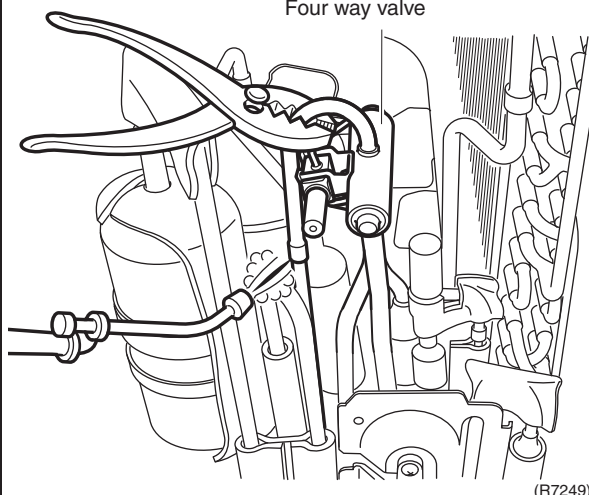
Step	Procedure	Points
4	<p>Remove the screw and remove the four way valve coil.</p>  <p style="text-align: right;">(R7247)</p>	<p><b>Warning</b> Be careful not to get yourself burnt with the pipes and other parts that are heated by the gas brazing machine.</p> <p><b>Warning</b> If the refrigerant gas leaks during work, ventilate the room. (If the refrigerant gas is exposed to flames, toxic gas may be generated.)</p> <p><b>Caution</b> From the viewpoint of global environment protection, do not discharge the refrigerant gas in the atmosphere. Make sure to collect all the refrigerant gas.</p>
5	<p>Remove the sheets of putty.</p>  <p style="text-align: right;">(R7248)</p>	<p><b>Cautions for restoration</b></p> <ol style="list-style-type: none"> <li>1. Restore the piping by non-oxidation brazing.</li> <li>2. It is required to prevent the carbonization of the oil inside the four way valve and the deterioration of the gaskets affected by heat. (Keep below 120°C.) For the sake of this, wrap the four way valve with wet cloth and provide water so that the cloth does not dry.</li> </ol>
6	<p>Heat up the brazed part and withdraw the piping with pliers.</p>  <p style="text-align: right;">(R7249)</p>	<p><b>In case of difficulty with gas brazing machine</b></p> <ol style="list-style-type: none"> <li>1. Disconnect the brazed part where is easy to disconnect and restore.</li> <li>2. Cut pipes on the main unit with a tube cutter in order to make it easy to disconnect.</li> </ol>

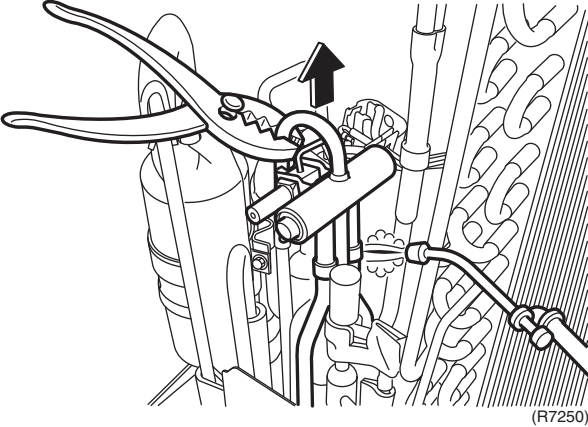





Step	Procedure	Points
		<p><b>Note:</b></p> <ul style="list-style-type: none"> <li>■ Do not use a metal saw for cutting pipes by all means because the sawdust comes into the circuit.</li> <li>■ When withdrawing the pipes, be careful not to pinch them firmly with pliers. The pipes may get deformed.</li> <li>■ Provide a protective sheet or a steel plate so that the brazing flame cannot influence peripheries.</li> </ul>

## 2.9 Removal of Compressor

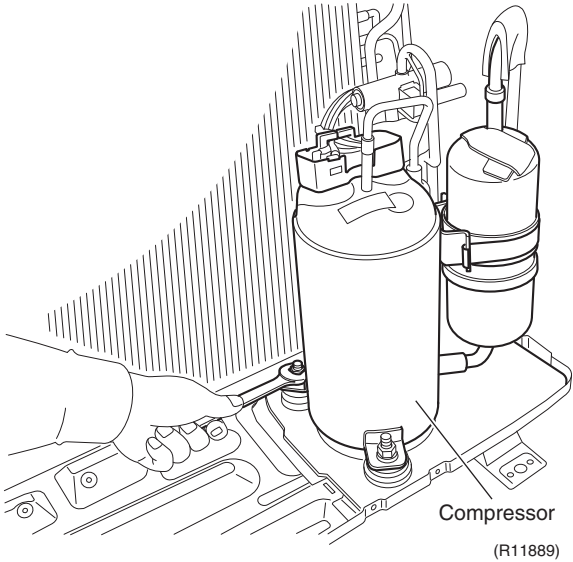
### Procedure

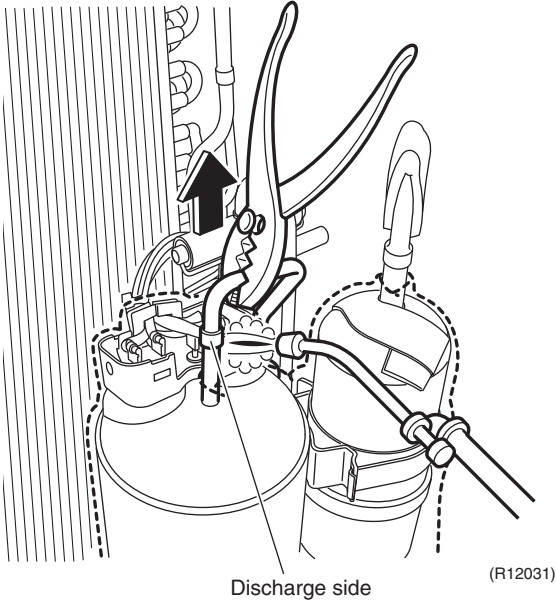

**Warning** Be sure to wait for 10 minutes or more after turning off all power supplies before disassembling work.

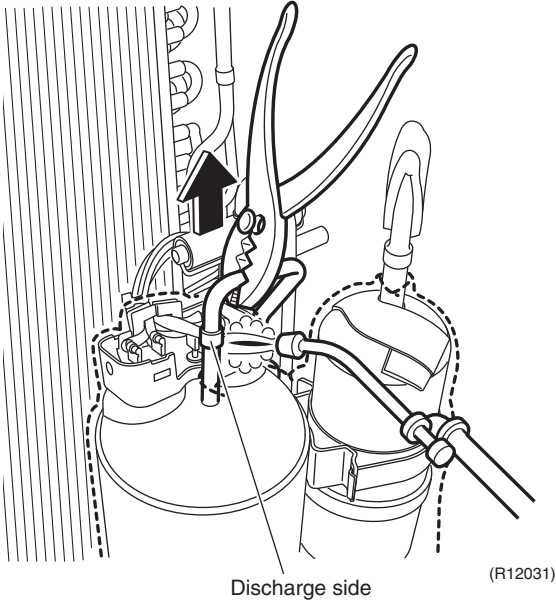
Step	Procedure	Points
1	Remove the 2 nuts of the compressor. 	<p> <b>Warning</b> Be careful not to get yourself burnt with the pipes and other parts that are heated by the gas brazing machine.</p> <p> <b>Warning</b> If the refrigerant gas leaks during work, ventilate the room. (If the refrigerant gas is exposed to flames, toxic gas may be generated.)</p> <p> <b>Warning</b> Since it may happen that the refrigerant oil in the compressor catches fire, prepare wet cloth so as to extinguish fire immediately.</p>
<ul style="list-style-type: none"> <li>■ Before working, make sure that the refrigerant is empty in the circuit.</li> <li>■ Be sure to apply nitrogen replacement when heating up the brazed part.</li> </ul>		<p> <b>Caution</b> From the viewpoint of global environment protection, do not discharge the refrigerant gas in the atmosphere. Make sure to collect all the refrigerant gas.</p>
2	Heat up the brazed part of the discharge side and disconnect. 	<p><b>Cautions for restoration</b></p> <ol style="list-style-type: none"> <li>1. Restore the piping by non-oxidation brazing.</li> <li>2. It is required to prevent the carbonization of the oil inside the four way valve and the deterioration of the gaskets affected by heat. (Keep below 120°C.) For the sake of this, wrap the four way valve with wet cloth and provide water so that the cloth does not dry.</li> </ol> <p><b>In case of difficulty with gas brazing machine</b></p> <ol style="list-style-type: none"> <li>1. Disconnect the brazed part where is easy to disconnect and restore.</li> <li>2. Cut pipes on the main unit with a tube cutter in order to make it easy to disconnect.</li> </ol>

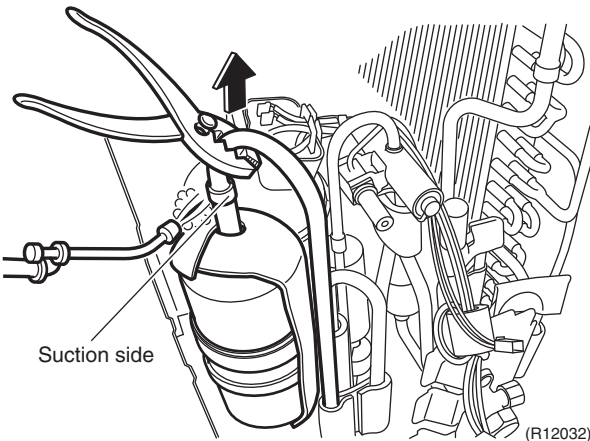
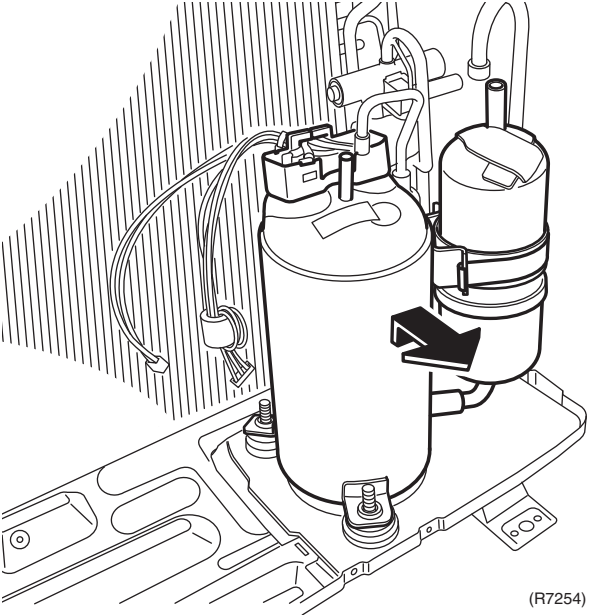
Step	Procedure	Points
3	<p>Heat up the brazed part of the suction side and disconnect.</p>  <p style="text-align: right;">(R12032)</p>	<p><b>Note:</b></p> <ul style="list-style-type: none"> <li>■ Do not use a metal saw for cutting pipes by all means because the sawdust comes into the circuit.</li> <li>■ When withdrawing the pipes, be careful not to pinch them firmly with pliers. The pipes may get deformed.</li> <li>■ Provide a protective sheet or a steel plate so that the brazing flame cannot influence peripheries.</li> </ul>
4	<p>Lift the compressor up and remove it.</p>  <p style="text-align: right;">(R7254)</p>	<ul style="list-style-type: none"> <li>■ Be careful so as not to burn the compressor terminals, the name plate, the heat exchanger fin.</li> </ul>

## 3. Outdoor Unit - RXL20G2V1B9

### 3.1 Removal of Outer Panels / Fan Motor

#### Procedure



**Warning** Be sure to wait 10 minutes or more after turning off all power supplies before disassembling work.

Step	Procedure	Points
1. Appearance features	<p>(R7186)</p> <p>(R12288)</p>	<ul style="list-style-type: none"> <li>■ Take care not to cut your finger by the fins of the outdoor heat exchanger.</li> </ul>
2. Remove the panels.	<p>1 Remove the screw of the stop valve cover. Pull down the stop valve cover and remove it.</p> <p>Stop valve cover</p> <p>(R7188)</p> <p>Shield plate</p> <p>Hooks</p> <p>(R7189)</p>	<ul style="list-style-type: none"> <li>■ The stop valve cover is united with the shield plate.</li> <li>■ When reassembling, make sure to fit the 5 hooks.</li> </ul>

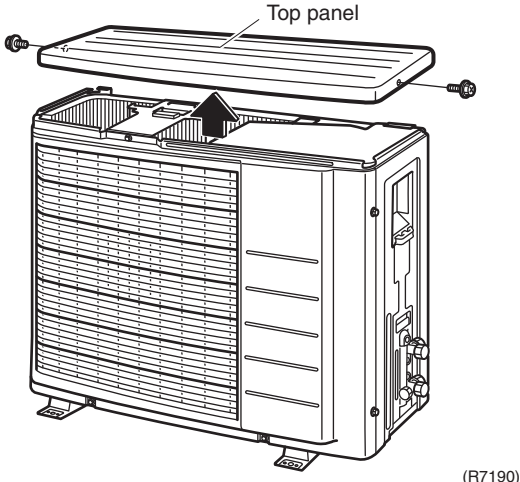
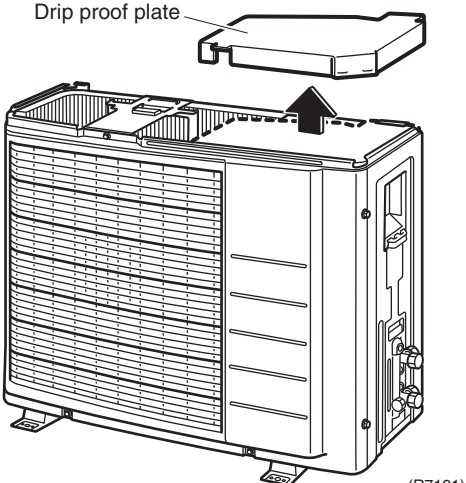
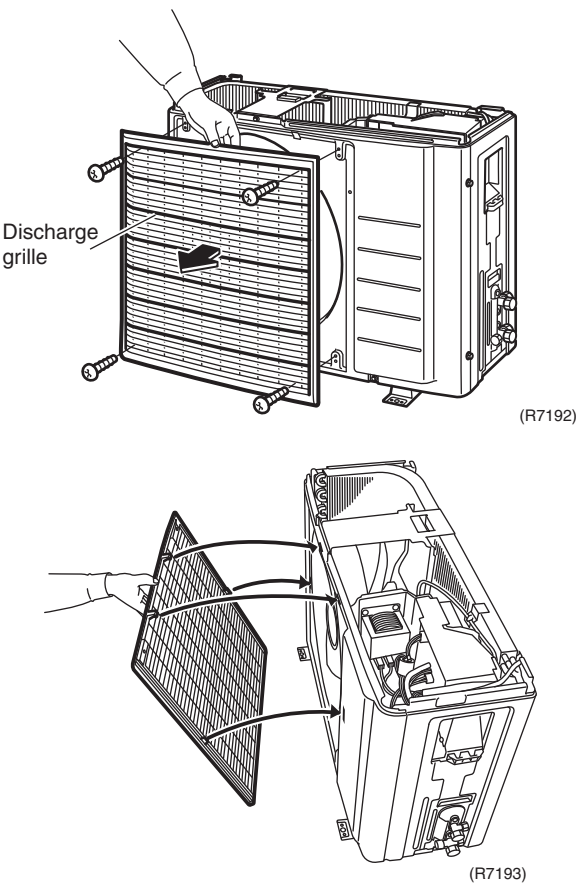
Step		Procedure	Points
2	Remove the 2 screws and lift the top panel.	 <p>Top panel</p> <p>(R7190)</p>	
3	Remove the drip proof plate.	 <p>Drip proof plate</p> <p>(R7191)</p>	
4	Remove the 4 screws and remove the discharge grille.	 <p>Discharge grille</p> <p>(R7192)</p> <p>(R7193)</p>	<p>■ The discharge grille has 4 hooks.</p>

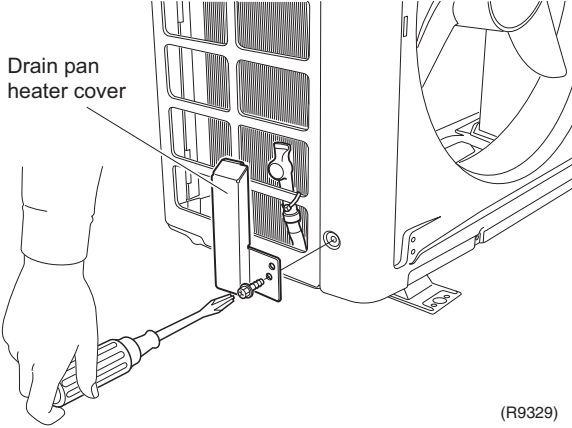
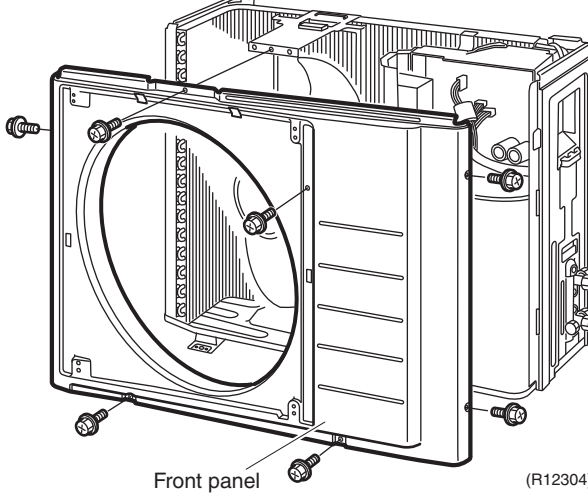
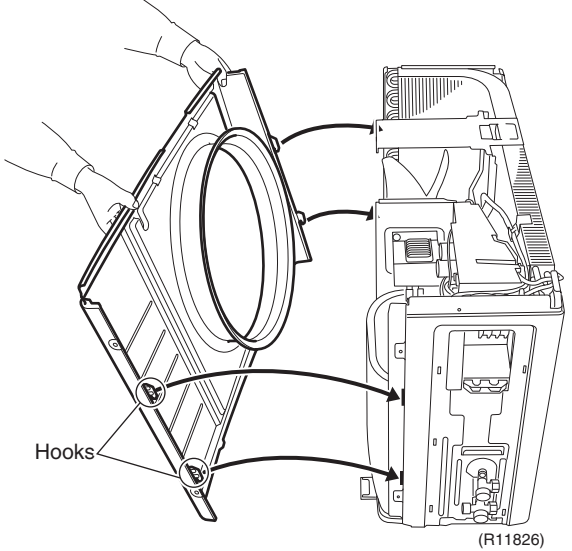
Step	Procedure	Points
5	Remove the screw and remove the drain pan heater cover.	
	 <p>Drain pan heater cover</p> <p>(R9329)</p>	
6	Remove the 7 screws of the front panel.	
	 <p>Front panel</p> <p>(R12304)</p>	
7	Unfasten the hooks. Pull and remove the front panel.	
	 <p>Hooks</p> <p>(R11826)</p>	<p>■ The front panel has 4 hooks.</p>

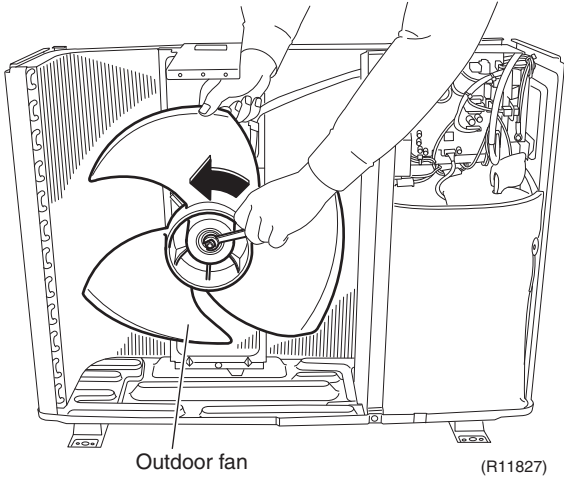
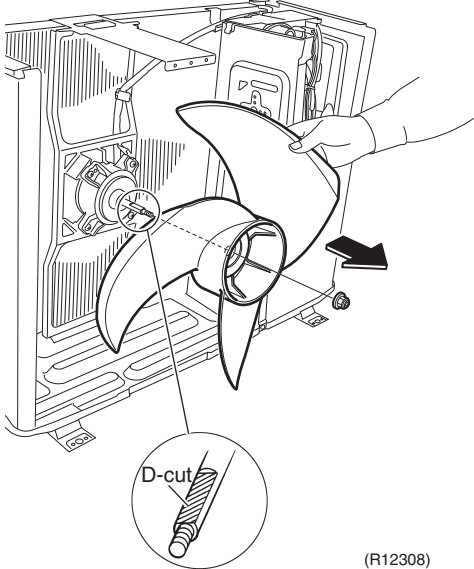
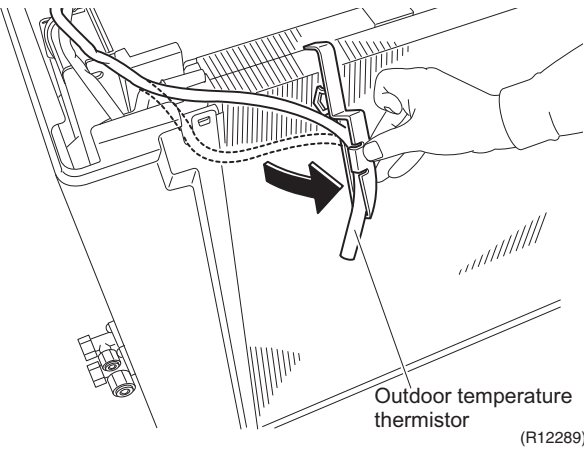
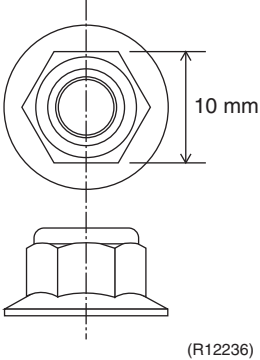

Step	Procedure	Points
<p>3. Remove the fan motor.</p>	<p>1 Remove the washer-fitted nut of the outdoor fan.</p>  <p>Outdoor fan (R11827)</p> <p>2 Remove the outdoor fan.</p>  <p>D-cut (R12308)</p> <p>3 Release the outdoor temperature thermistor.</p>  <p>Outdoor temperature thermistor (R12289)</p>	<p>■ The screw has reverse winding.</p> <p>■ Nut size: M6</p>  <p>10 mm (R12236)</p> <p>■ When reassembling, align ▼ mark of the outdoor fan with D-cut section of the motor shaft.</p>

Step	Procedure	Points
4	Cut the clamp.	
5	Disconnect the connector for the fan motor [S70].	
6	Release the fan motor lead wire from the hook.	

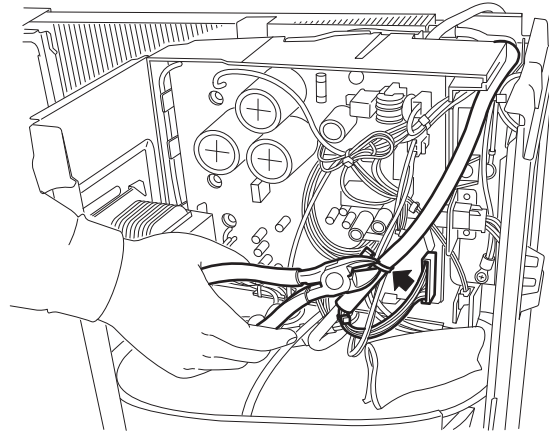

(R11830)

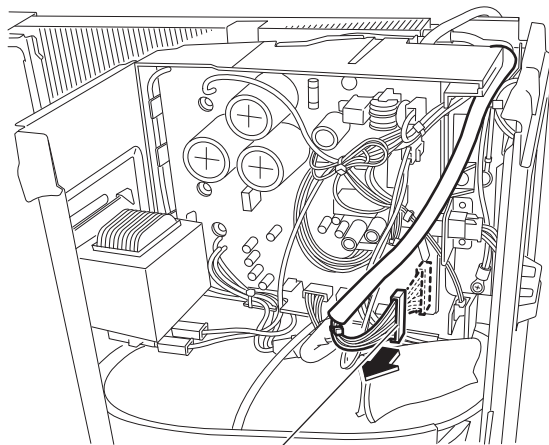

[S70]

(R11831)

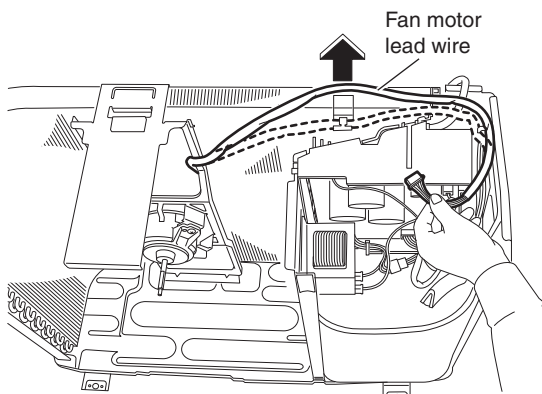

(R11832)

Step	Procedure	Points
7	Remove the screw and remove the fan motor fixing frame.	<ul style="list-style-type: none"> <li>■ When reassembling, fit the lower hooks into the bottom frame.</li> </ul>

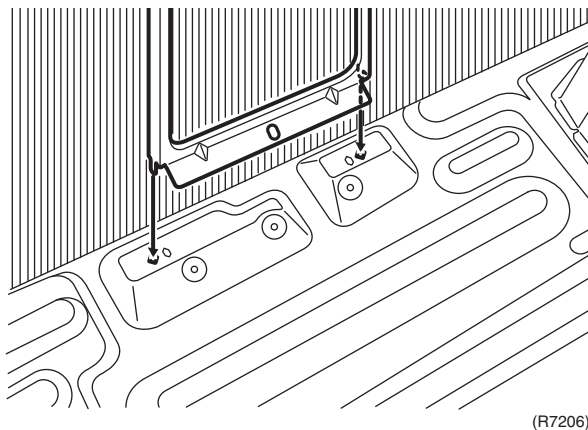
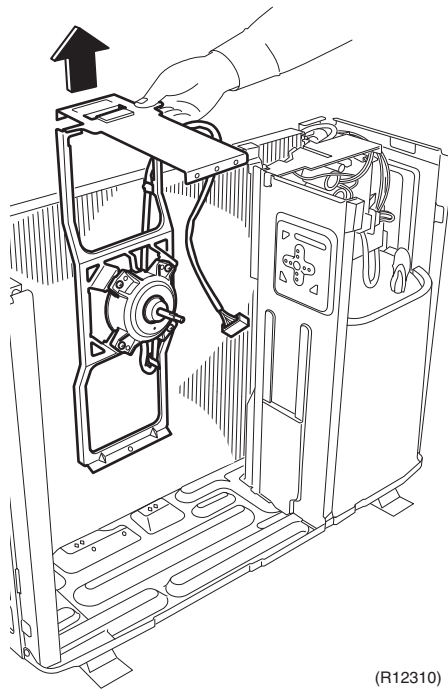
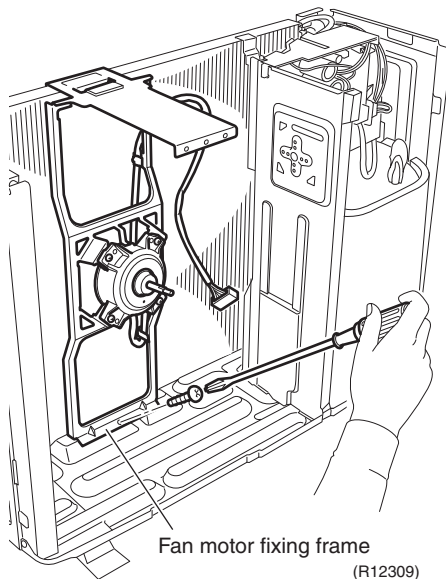

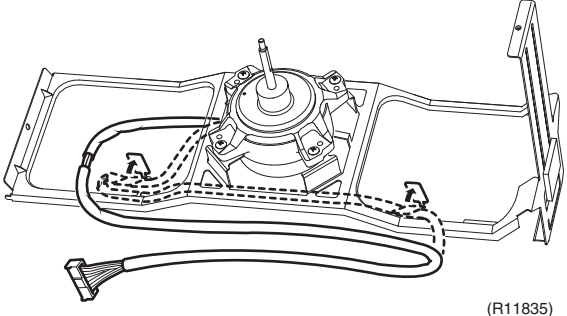
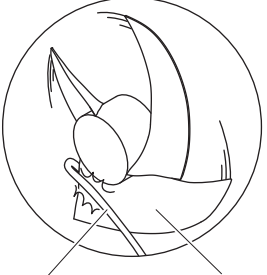
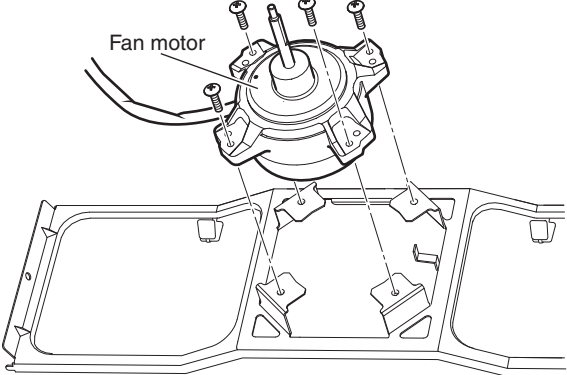
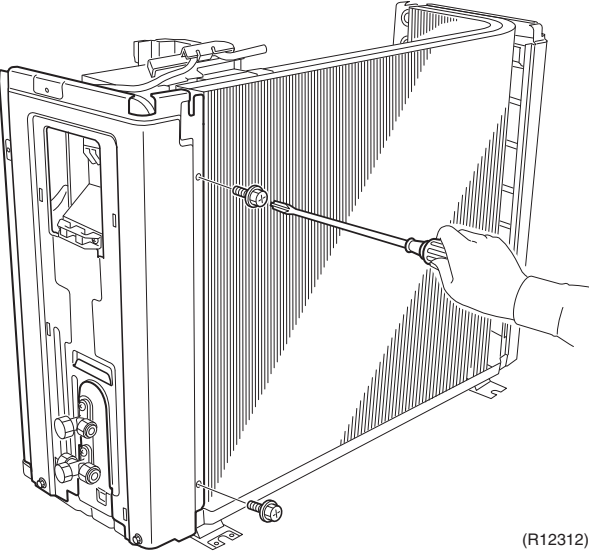
Step	Procedure	Procedure	Points
8	Open the hooks and release the fan motor lead wire.	 <p>(R11835)</p>	<p>■ When reassembling, put the fan motor lead wire through the back of the fan motor (so as not to be entangled with the outdoor fan).</p>  <p>Lead wire      Outdoor fan (R3249)</p>
9	Remove the 4 screws and remove the fan motor.	 <p>Fan motor</p> <p>(R12311)</p>	
4.	Remove the right side panel.	 <p>(R12312)</p>	
1	Remove the 2 screws on the rear side.		

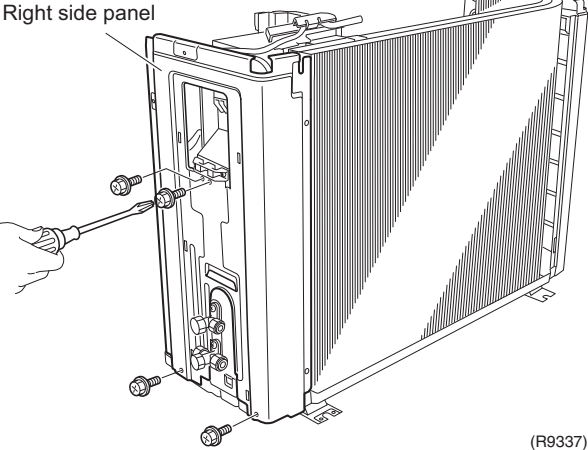
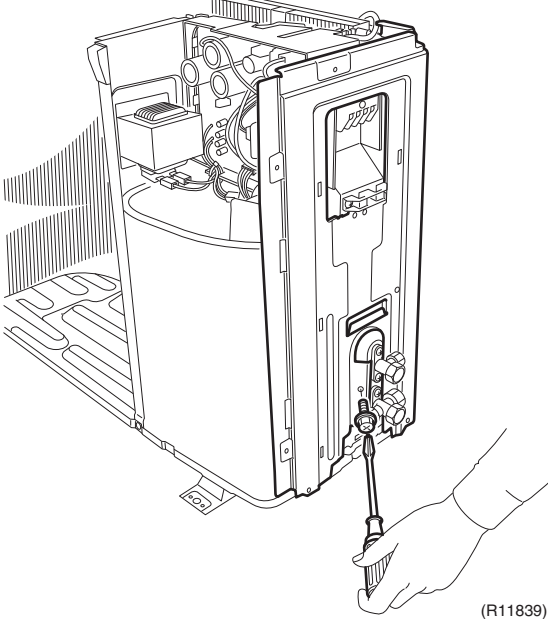
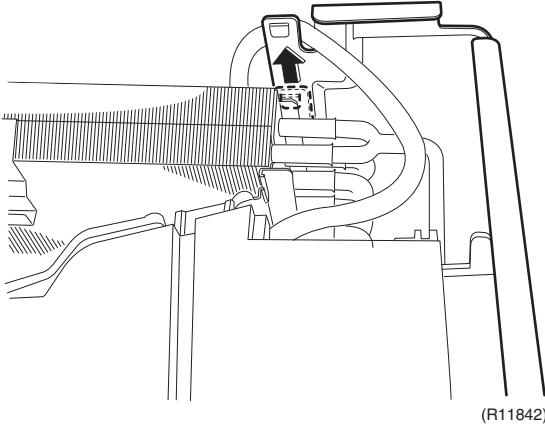
Step	Procedure	Points
2	Remove the 4 screws on the right side panel.	
	 <p>Right side panel</p> <p>(R9337)</p>	
3	Remove the screw near the stop valves.	
	 <p>(R11839)</p>	
4	Unfasten the hook on the rear side.	
	 <p>(R11842)</p>	<p>■ When reassembling, make sure to fit the hook.</p>

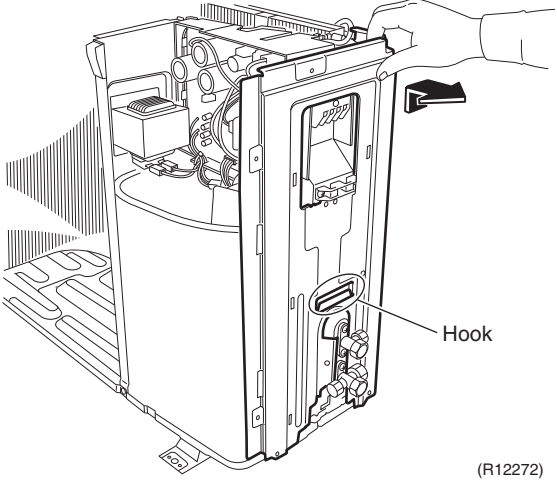
Step	Procedure	Points
5	<p data-bbox="199 217 432 277">Lift up the right side panel and remove it.</p>  <p data-bbox="986 689 1054 712">(R12272)</p>	<ul data-bbox="1093 217 1437 277" style="list-style-type: none"><li>■ When reassembling, make sure to fit the hook.</li></ul>

## 3.2 Removal of Electrical Box

**Procedure**



**Warning** Be sure to wait 10 minutes or more after turning off all power supplies before disassembling work.

Step	Procedure	Points
1	Disconnect the connector for the overload protector [S40].	<p><b>Preparation</b></p> <ul style="list-style-type: none"> <li>Remove the panels and disconnect the connector for the fan motor according to the "Removal of Outer Panels / Fan Motor".</li> </ul>
2	Disconnect the connector for the four way valve coil [S80].	
3	Disconnect the 2 connectors for the reactor.	

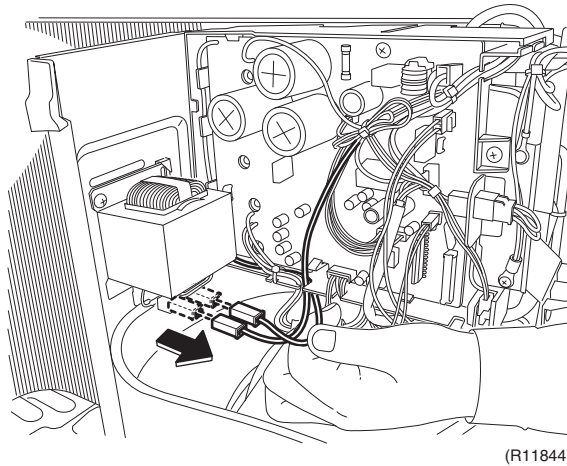
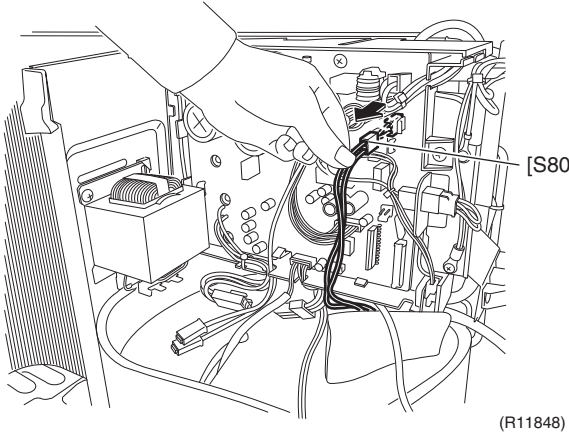
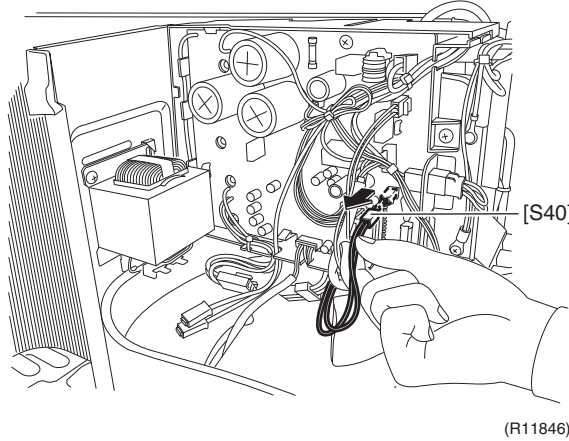

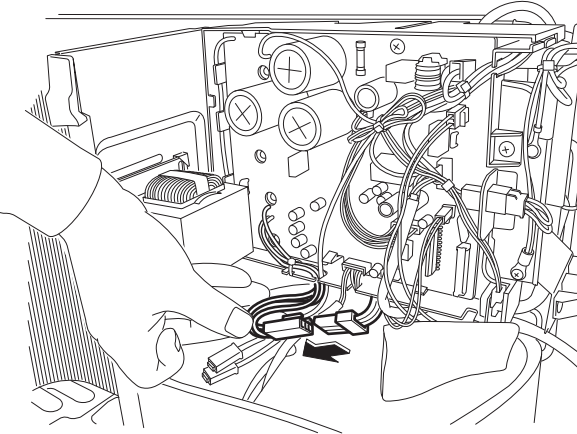
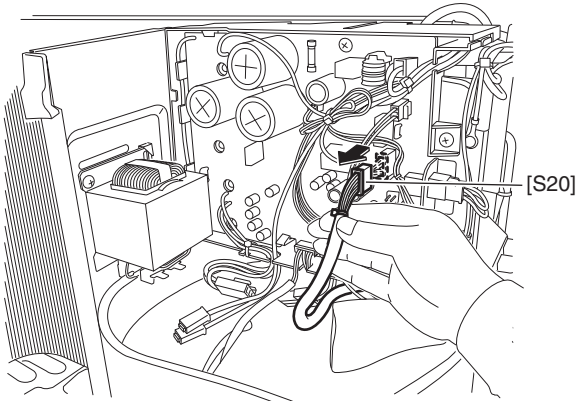
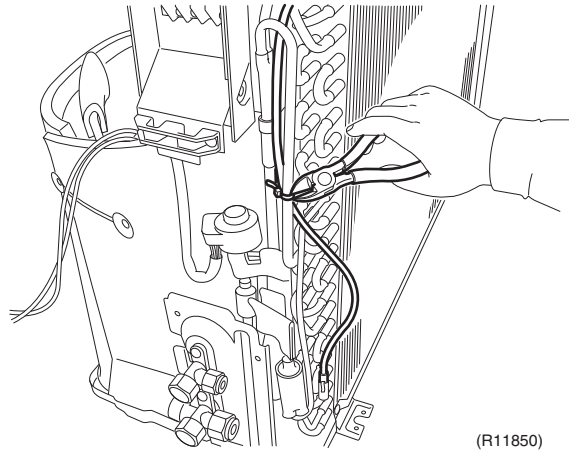
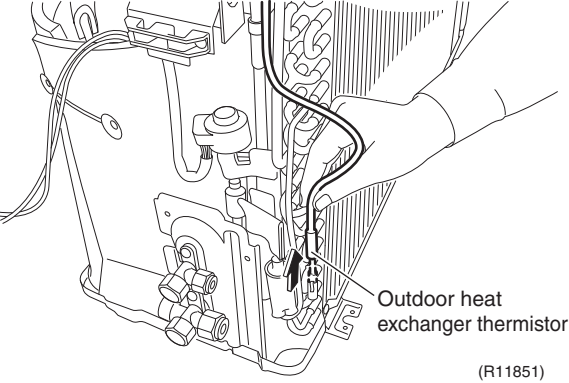
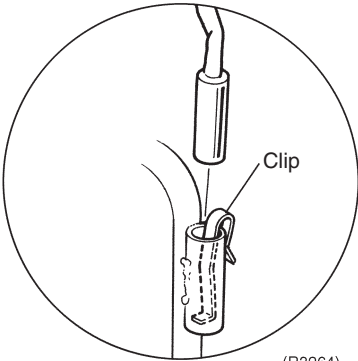
Step	Procedure	Points
4	<p>Disconnect the relay connector for the compressor.</p>  <p>(R11845)</p>	
5	<p>Disconnect the connector for the electronic expansion valve coil [S20].</p>  <p>(R11847)</p>	
6	<p>Cut the clamp.</p>  <p>(R11850)</p>	
7	<p>Pull out the outdoor heat exchanger thermistor.</p>  <p>(R11851)</p>	<p>■ Be careful not to lose the clip for the thermistor.</p>  <p>(R3264)</p>

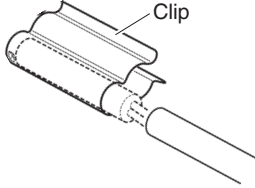
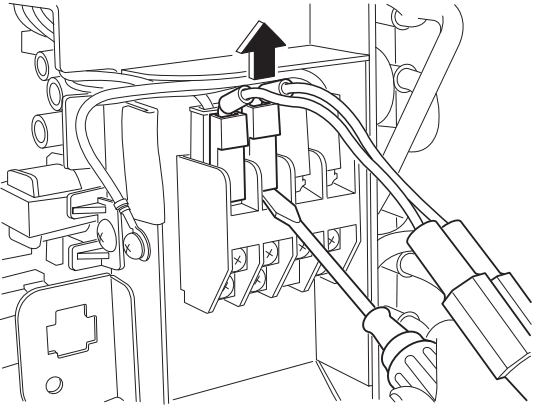
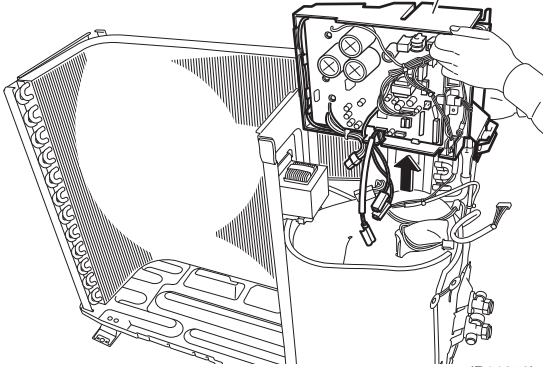

Step	Procedure	Points
8	Release the discharge pipe thermistor.	<p>■ Be careful not to lose the clip for the thermistor.</p>  <p>Clip</p> <p>(R12279)</p>
9	Disconnect the connectors for the drain pan heater with a flat screwdriver.	 <p>(R9347)</p>
10	Lift and remove the electrical box.	 <p>Electrical Box</p> <p>(R11852)</p>

### 3.3 Removal of Drain Pan Heater

**Procedure**

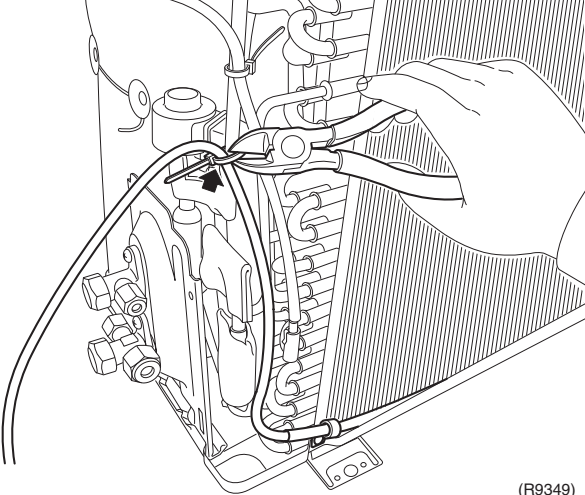
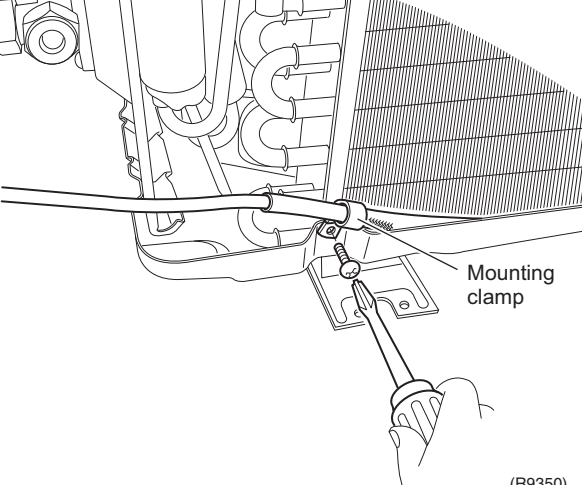
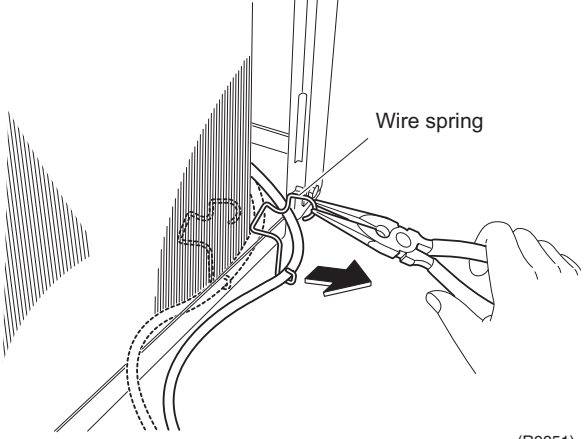
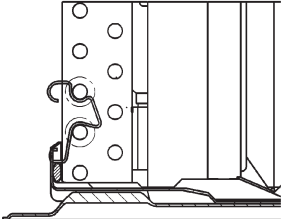

**Warning** Be sure to wait 10 minutes or more after turning off all power supplies before disassembling work.

Step	Procedure	Points
1. Remove the drain pan heater.		
1 Cut the clamp.	 <p>(R9349)</p>	
2 Remove the screw of the mounting clamp.	 <p>Mounting clamp</p> <p>(R9350)</p>	
3 Release the drain pan heater ASSY from the ditch between the bottom frame and the outdoor heat exchanger ASSY. Remove the wire spring with long nose pliers.	 <p>Wire spring</p> <p>(R9351)</p>	<ul style="list-style-type: none"> <li>■ Take care not to cut your finger by the fins of the outdoor heat exchanger.</li> <li>■ When reassembling, hang the wire spring to the hair pin cooling tube.</li> </ul>  <p>(R9748)</p>

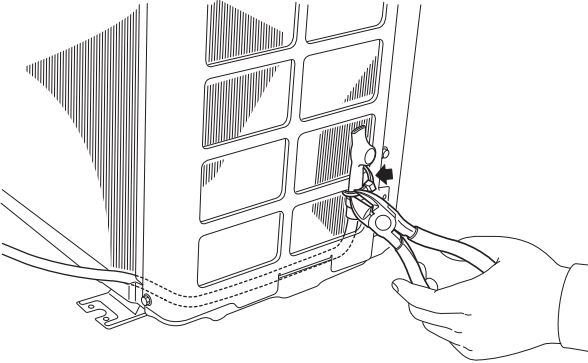
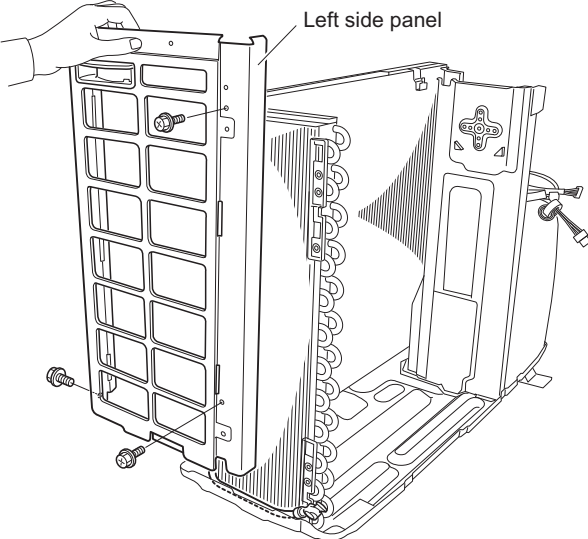
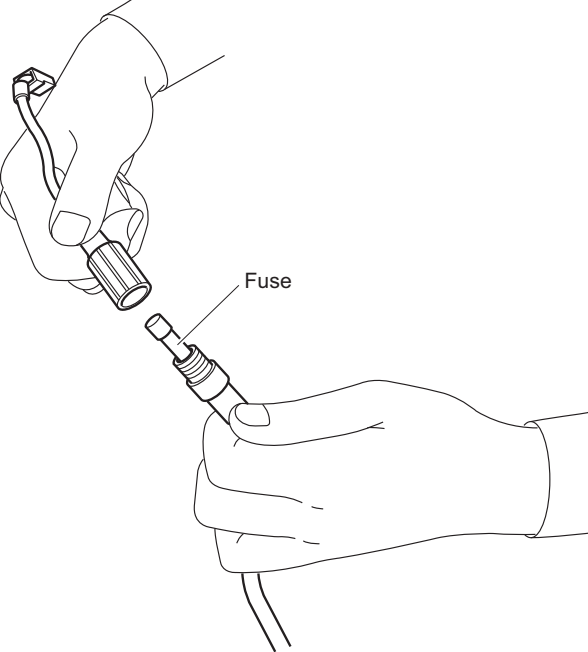
Step	Procedure	Points
4	<p>Cut the clamp.</p>  <p>(R9352)</p>	
5	<p>Remove the 3 screws and remove the left side panel.</p>  <p>Left side panel</p> <p>(R12307)</p>	
6	<p>The fuses are inside the drain pan heater.</p>  <p>Fuse</p> <p>(R9354)</p>	

## 3.4 Removal of PCB

### Procedure

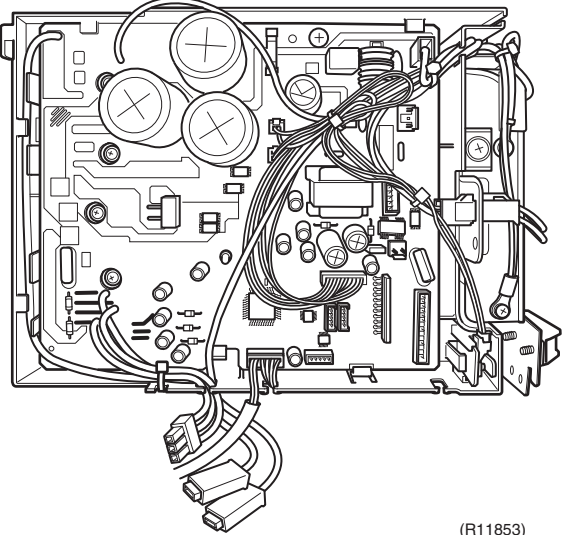
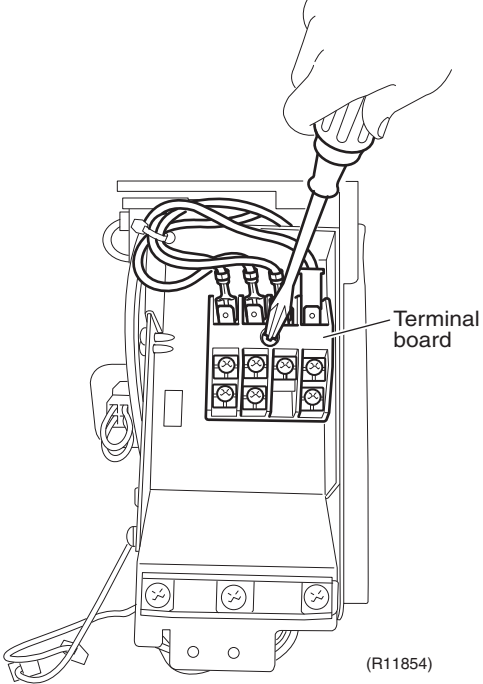
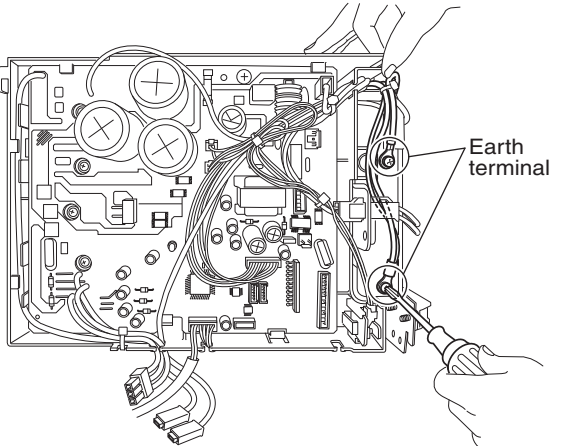

**Warning** Be sure to wait 10 minutes or more after turning off all power supplies before disassembling work.

Step	Procedure	Points
<p>1. Remove the main PCB.</p> <p>1 Feature of the main PCB</p> <p>2 Remove the screw on the terminal board.</p> <p>3 Release the 2 earth terminals.</p>	 <p>(R11853)</p>  <p>Terminal board</p> <p>(R11854)</p>  <p>Earth terminal</p> <p>(R11855)</p>	<ul style="list-style-type: none"> <li>■ You can remove the main PCB when you disconnect the lead wires on the terminal board without removing the electrical box.</li> </ul>

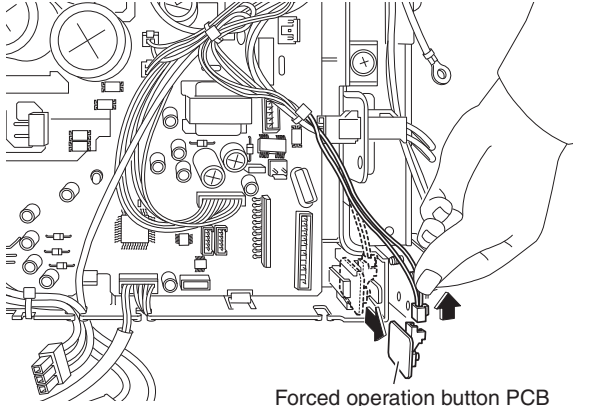
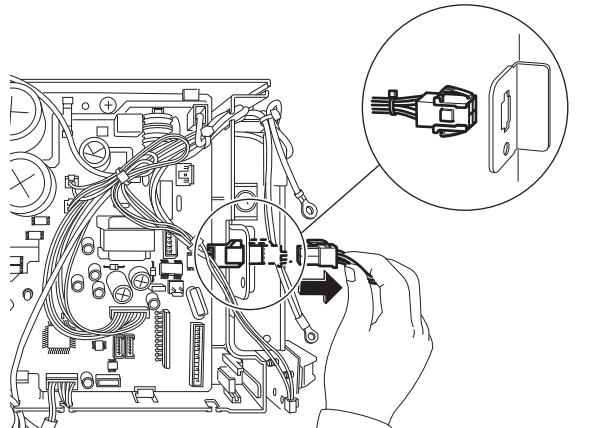
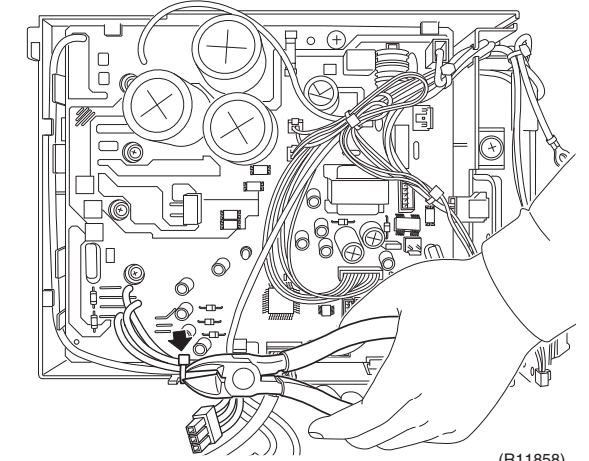
Step	Procedure	Points
4	<p>Pull out the forced operation button PCB. Disconnect the connector [S110] to remove the forced operation button PCB.</p>  <p style="text-align: center;">Forced operation button PCB (R11856)</p>	<ul style="list-style-type: none"> <li>Be careful of a sharp protrusion at the back of the forced operation button PCB.</li> </ul>
5	<p>Disconnect the relay connector.</p>  <p style="text-align: center;">(R11857)</p>	
6	<p>Cut the clamp.</p>  <p style="text-align: center;">(R11858)</p>	

Step	Procedure	Points
7	Release the harness.	
8	Cut the clamps at the 2 locations.	
9	Disconnect the connector for the filter PCB [S10].	

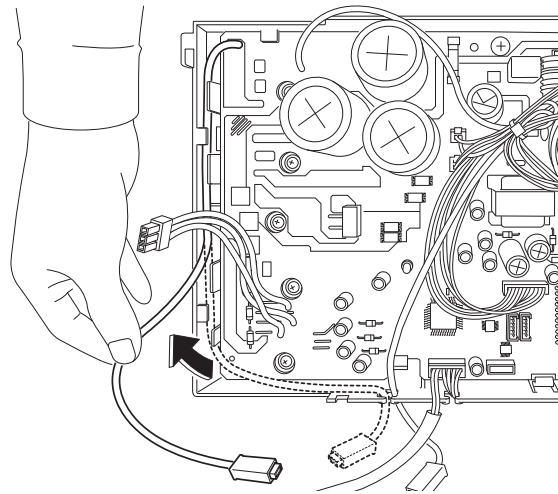

(R11859)

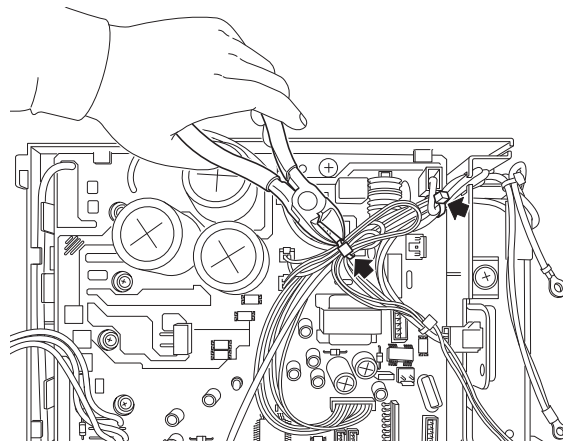

(R11860)

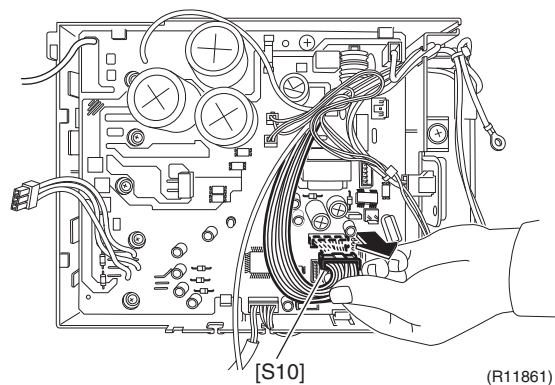

(R11861)

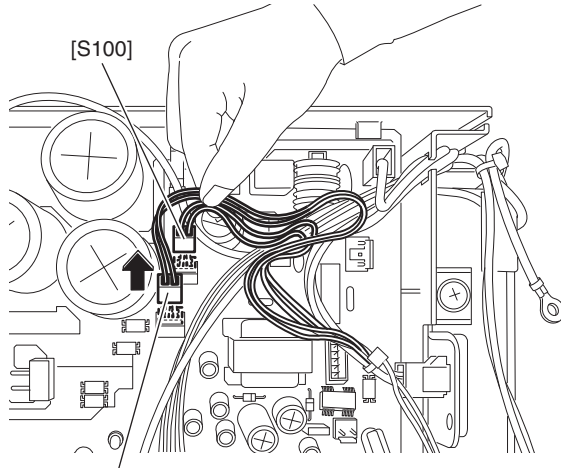
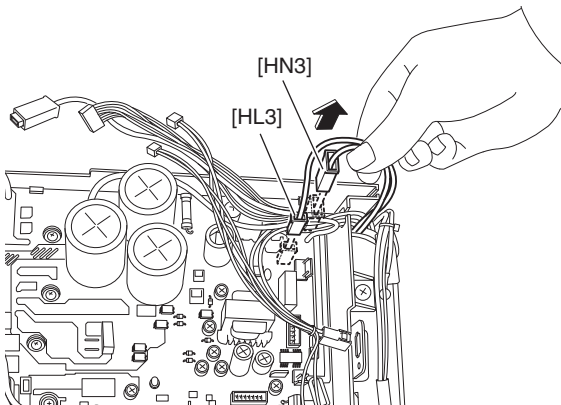
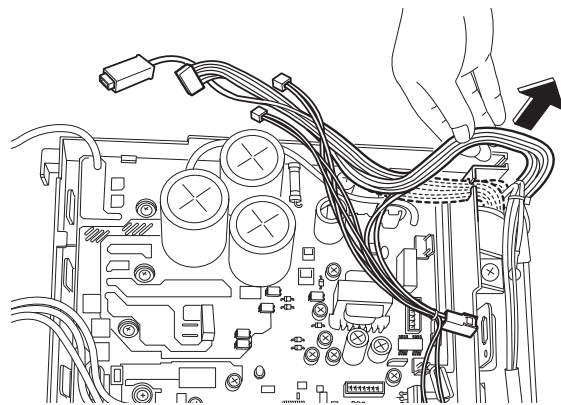
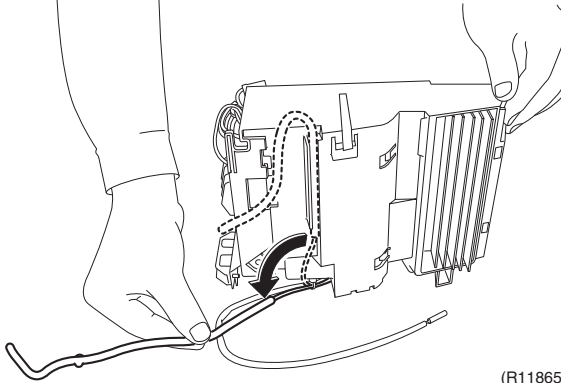
Step	Procedure	Procedure	Points
10	Disconnect the connectors for the magnetic relay [S50] and for the forced operation button PCB [S100].	 <p>[S100]</p> <p>[S50] (R11862)</p>	
11	Disconnect the connector for the filter PCB [HL3] [HN3].	 <p>[HN3]</p> <p>[HL3] (R11863)</p>	
12	Release the harnesses from the hook.	 <p>(R11864)</p>	
13	Release the harness for the outdoor temperature thermistor.	 <p>(R11865)</p>	

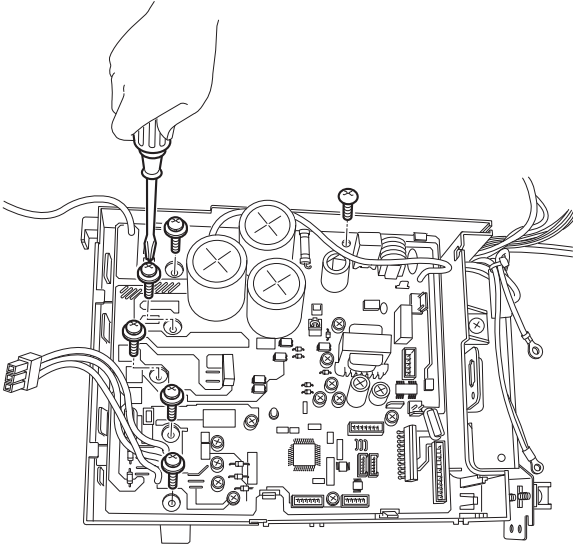
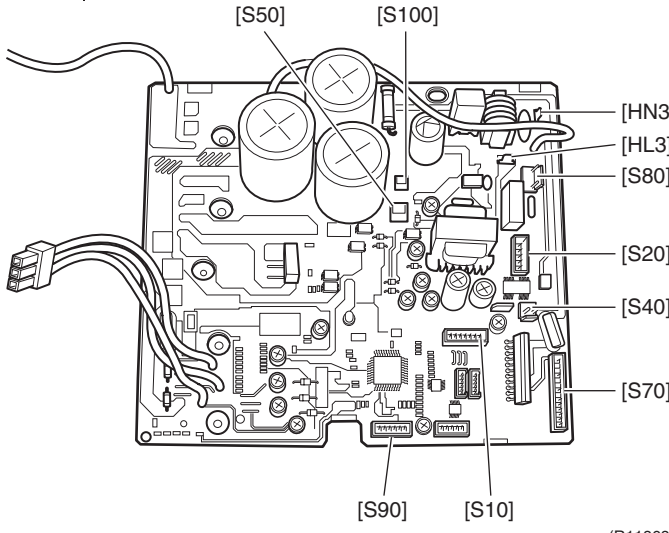
Step	Procedure	Points
<p>14 Remove the 6 screws.</p>	 <p>(R11866)</p>	
<p>15 Unfasten the 4 hooks and remove the main PCB.</p>	 <p>(R11867)</p> <p>(R11868)</p>	<p>■ Refer to page 14 for detail.</p> <p>[S10] [HL3] [HN3]: filter PCB          [S20]: electronic expansion valve coil          [S40]: overload protector          [S50]: magnetic relay          [S70]: fan motor          [S80]: four way valve coil          [S90]: thermistors          [S100]: forced operation button PCB</p>

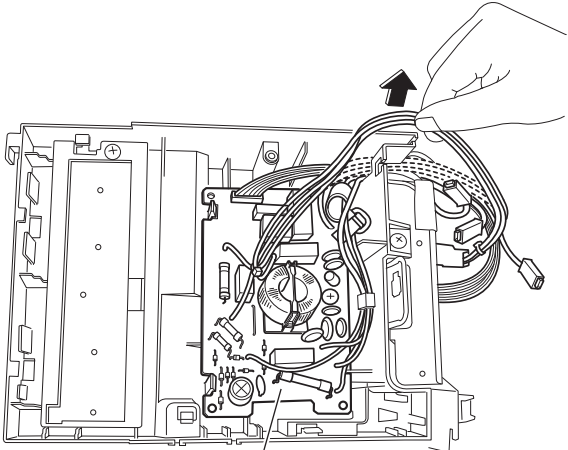
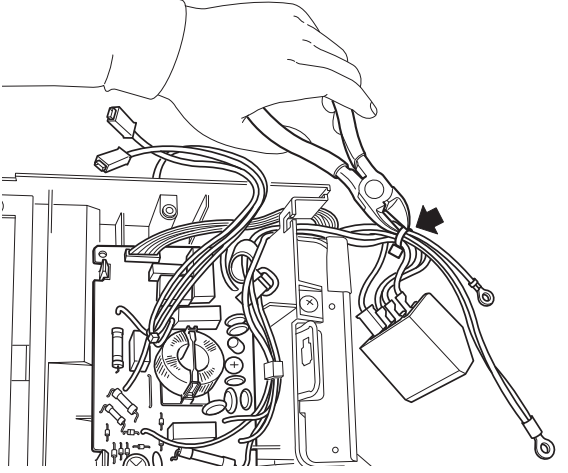
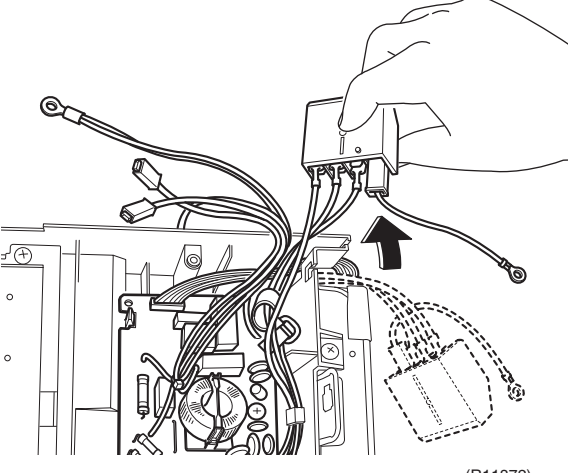

Step	Procedure	Points
2.	Remove the filter PCB.	
1	Release the harnesses from the hook.  <p style="text-align: center;">Filter PCB (R11869)</p>	
2	Cut the clamp.  <p style="text-align: center;">(R11871)</p>	
3	Release the harnesses from the hook.  <p style="text-align: center;">(R11872)</p>	

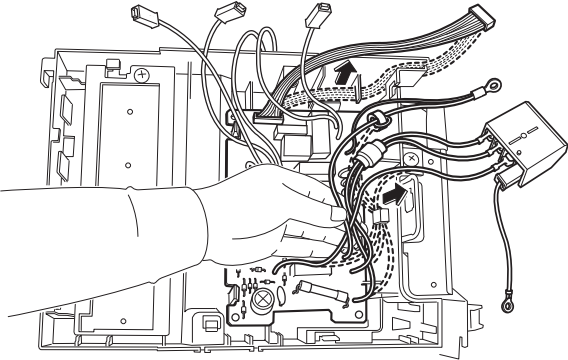
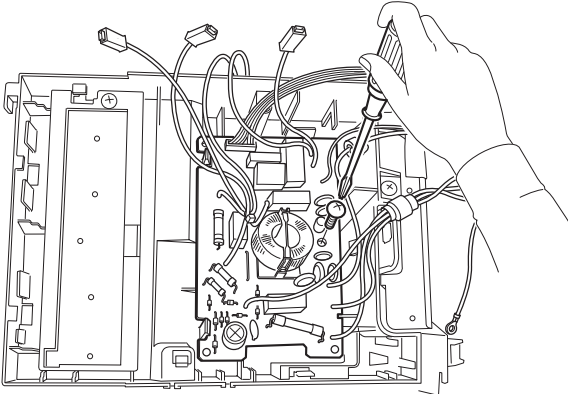
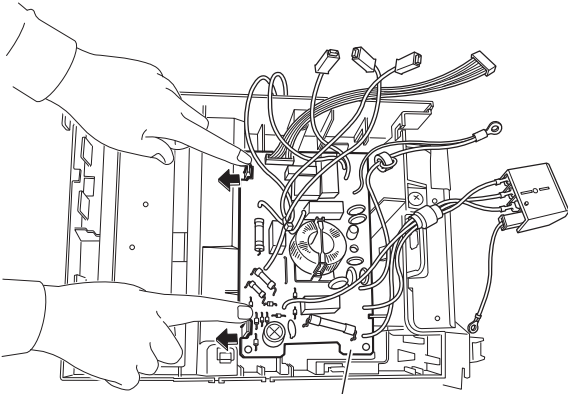
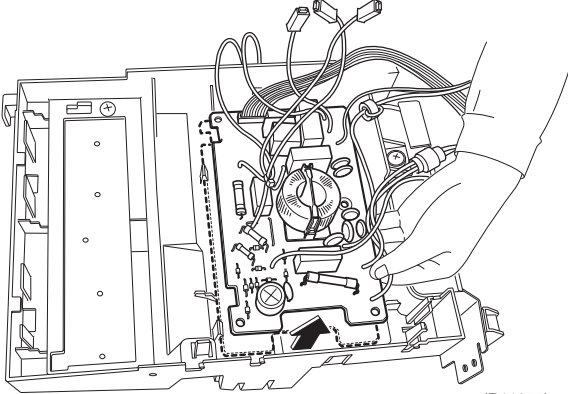
Step	Procedure	Points
4	Release the harnesses from the hooks.	
	 <p>(R11873)</p>	
5	Remove the screw.	
	 <p>(R11874)</p>	
6	Unfasten the 2 hooks.	
	 <p>Filter PCB (R11876)</p>	
7	Lift and pull out the filter PCB.	
	 <p>(R11877)</p>	

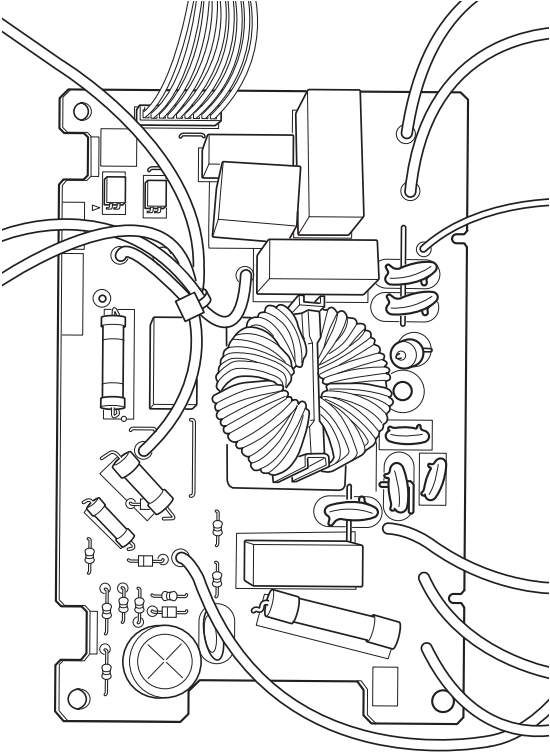
Step	Procedure	Points
8	<p data-bbox="199 217 416 275">Feature of the filter PCB</p>  <p data-bbox="986 994 1054 1016">(R11878)</p>	<ul style="list-style-type: none"> <li data-bbox="1090 217 1437 239">■ Refer to page 14 for detail.</li> </ul>

## 3.5 Removal of Reactor / Partition Plate

### Procedure

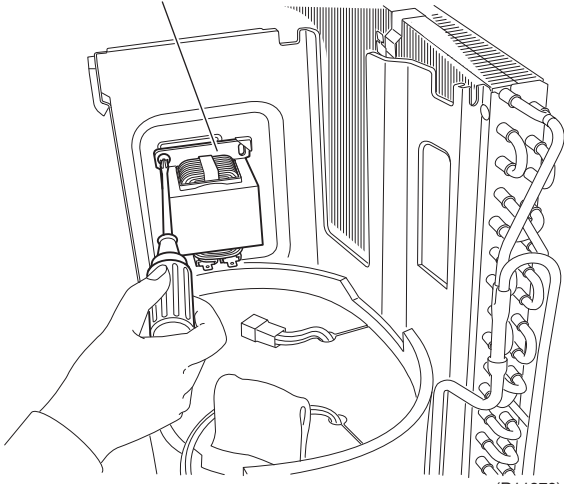
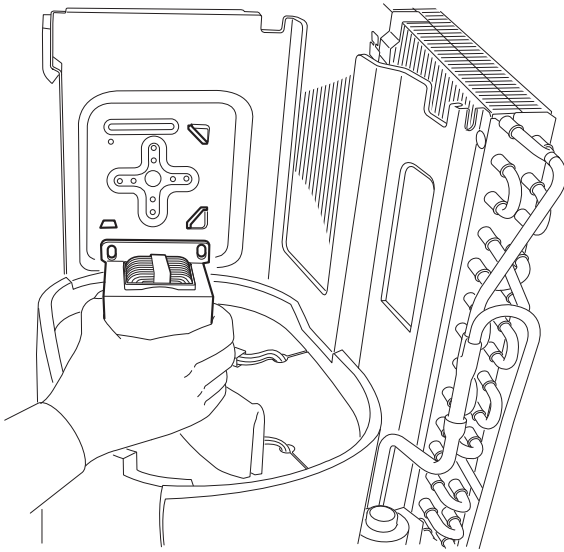
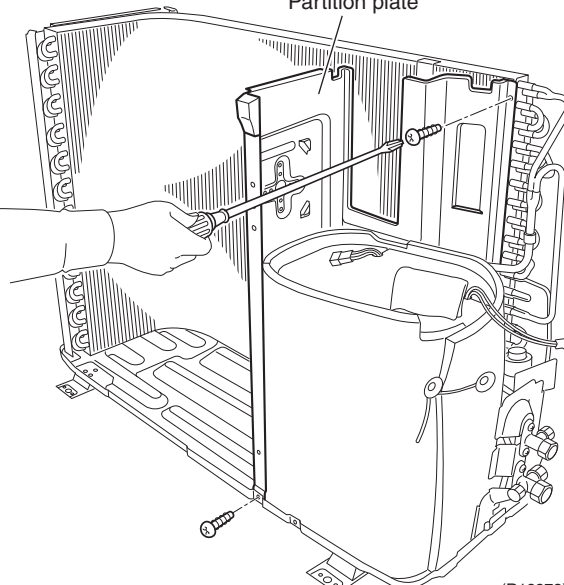

**Warning** Be sure to wait 10 minutes or more after turning off all power supplies before disassembling work.

Step	Procedure	Points
1. Remove the reactor. 1 Remove the screw and remove the reactor.	 <p>(R11879)</p>  <p>(R11880)</p>	<b>Preparation</b> <ul style="list-style-type: none"> <li>■ Remove the outer panels according to the "Removal of Outer Panels / Fan Motor".</li> <li>■ Remove the electrical box according to the "Removal of Electrical Box".</li> </ul>
2. Remove the partition plate. 1 Remove the 2 screws.	 <p>(R12273)</p>	

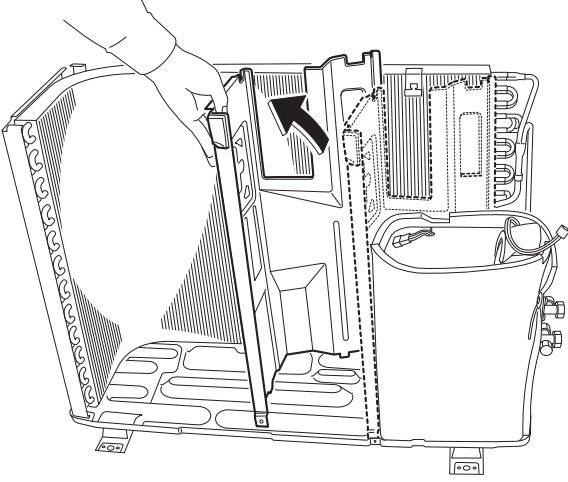
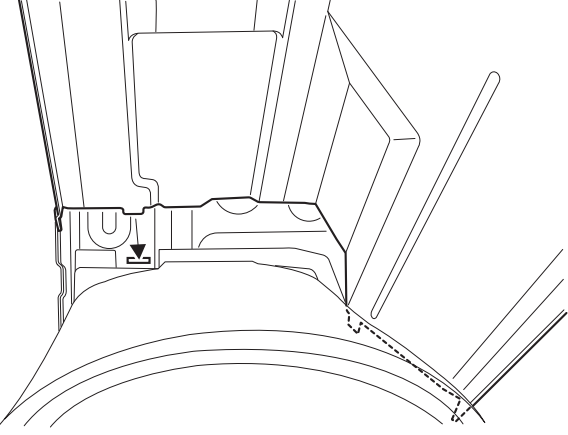
Step	Procedure	Points
<p>2</p>	<p>The partition plate has a hook on the lower side. Lift and pull the partition plate to remove.</p>  <p>(R12280)</p>  <p>(R11883)</p>	<ul style="list-style-type: none"> <li>■ When reassembling, fit the lower hook into the bottom frame.</li> </ul>

## 3.6 Removal of Sound Blanket

### Procedure

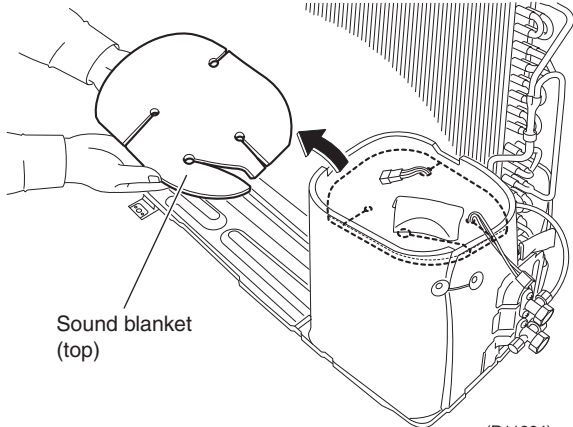
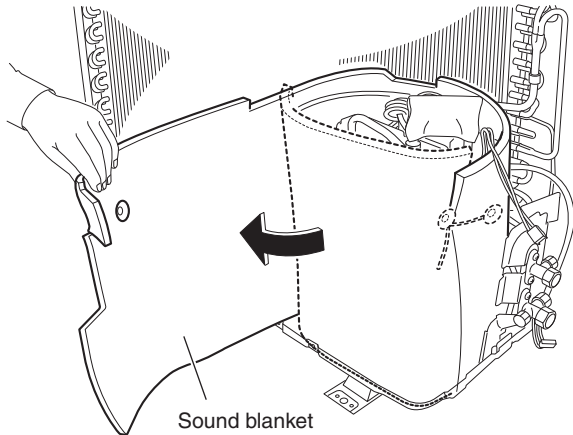
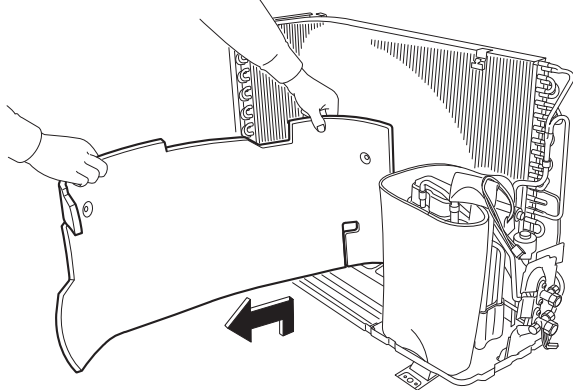

**Warning** Be sure to wait 10 minutes or more after turning off all power supplies before disassembling work.

Step	Procedure	Procedure	Points
1	Remove the sound blanket (top).	 <p style="text-align: right;">(R11884)</p>	<ul style="list-style-type: none"> <li>■ Since the piping ports are torn easily, remove the sound blanket carefully.</li> </ul>
2	Untie the string and open the sound blanket (outer).	 <p style="text-align: right;">(R11885)</p>	
3	Lift and remove the sound blanket (outer).	 <p style="text-align: right;">(R11886)</p>	

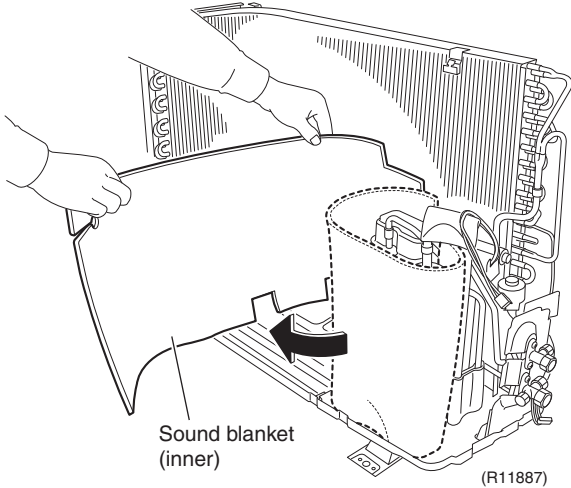
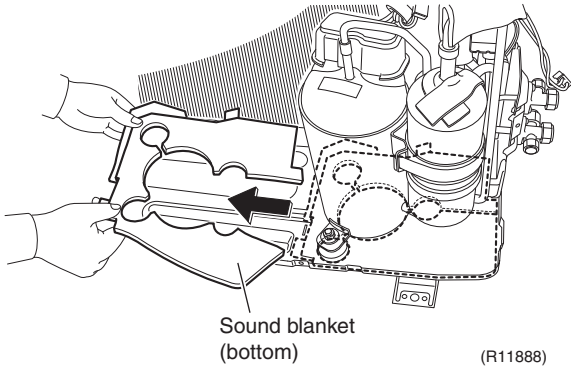
Step	Procedure	Points
4	Pull the sound blanket (inner) out.	
	 <p data-bbox="651 658 788 707">Sound blanket (inner)</p> <p data-bbox="975 703 1042 723">(R11887)</p>	
5	Pull the sound blanket (bottom) out.	
	 <p data-bbox="711 1137 849 1187">Sound blanket (bottom)</p> <p data-bbox="975 1171 1042 1191">(R11888)</p>	

## 3.7 Removal of Four Way Valve

### Procedure

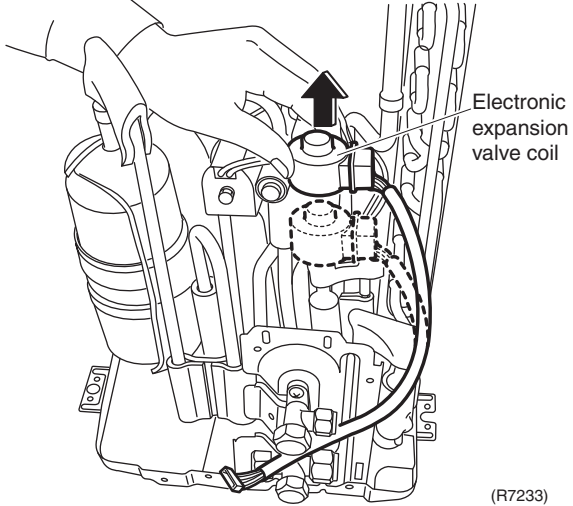
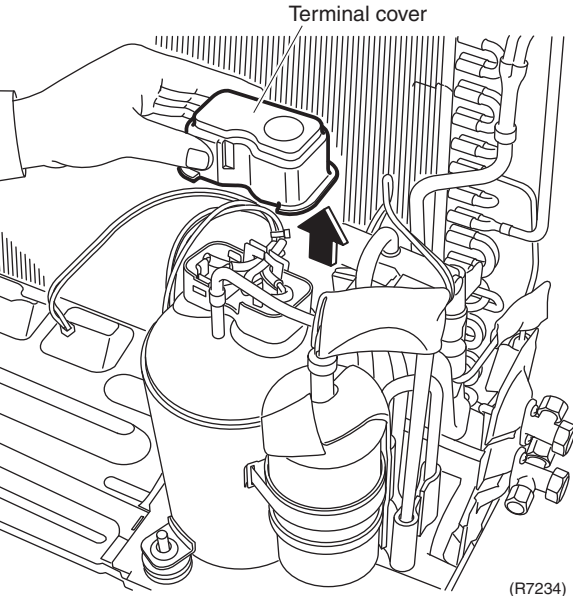
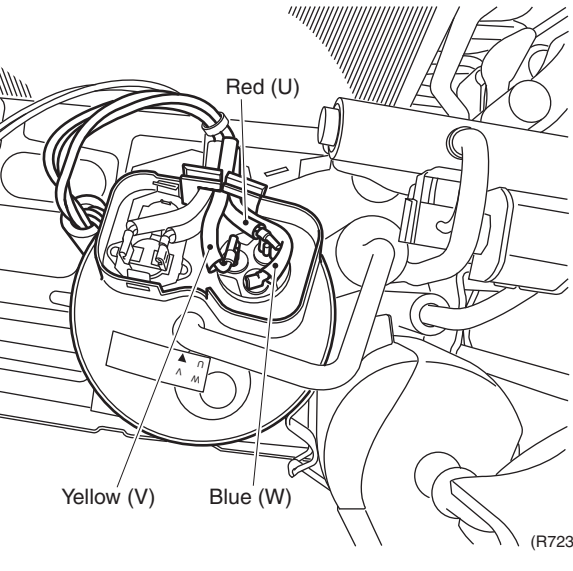

**Warning** Be sure to wait 10 minutes or more after turning off all power supplies before disassembling work.

Step	Procedure	Procedure	Points
1	Pull out the electronic expansion valve coil.	 <p>Electronic expansion valve coil</p> <p>(R7233)</p>	
2	Remove the terminal cover.	 <p>Terminal cover</p> <p>(R7234)</p>	
3	Disconnect the lead wires of the compressor.	 <p>Red (U)</p> <p>Yellow (V)</p> <p>Blue (W)</p> <p>(R7235)</p>	



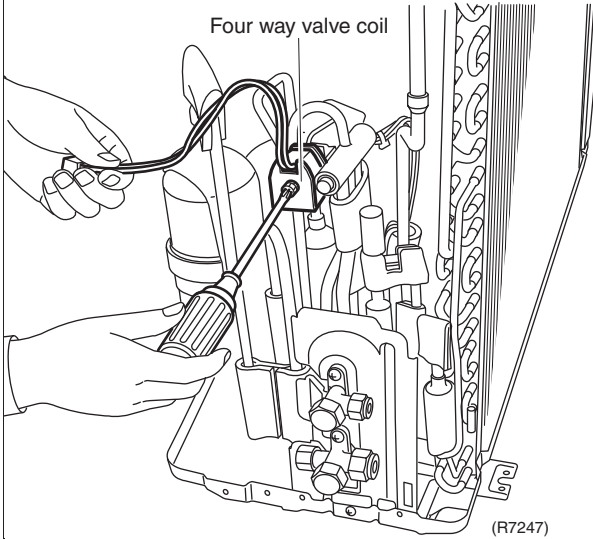
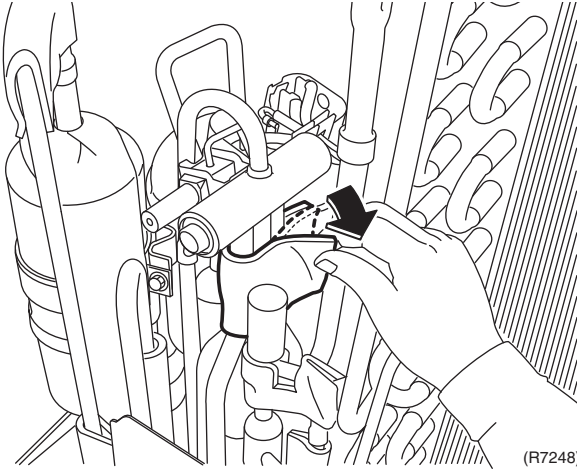
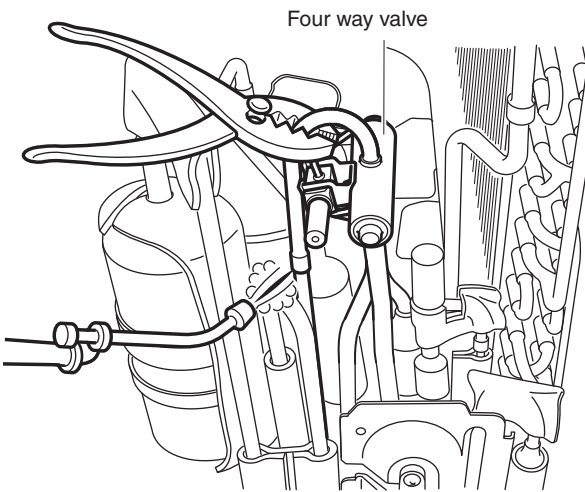

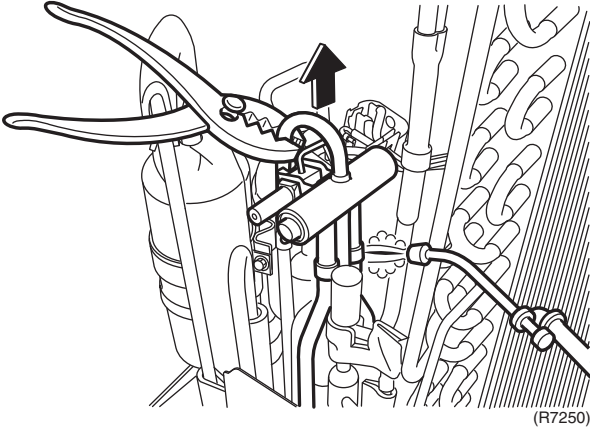



Step	Procedure	Points
<p>4 Remove the screw and remove the four way valve coil.</p>	 <p style="text-align: center;">Four way valve coil</p> <p style="text-align: right;">(R7247)</p>	<p><b>Warning</b> Be careful not to get yourself burnt with the pipes and other parts that are heated by the gas brazing machine.</p> <p><b>Warning</b> If the refrigerant gas leaks during work, ventilate the room. (If the refrigerant gas is exposed to flames, toxic gas may be generated.)</p> <p><b>Caution</b> From the viewpoint of global environment protection, do not discharge the refrigerant gas in the atmosphere. Make sure to collect all the refrigerant gas.</p> <p><b>Cautions for restoration</b></p> <ol style="list-style-type: none"> <li>1. Restore the piping by non-oxidation brazing.</li> <li>2. It is required to prevent the carbonization of the oil inside the four way valve and the deterioration of the gaskets affected by heat. (Keep below 120°C.) For the sake of this, wrap the four way valve with wet cloth and provide water so that the cloth does not dry.</li> </ol>
<p>5 Remove the sheets of putty.</p>	 <p style="text-align: right;">(R7248)</p>	
<ul style="list-style-type: none"> <li>■ Before working, make sure that the refrigerant gas is empty in the circuit.</li> <li>■ Be sure to apply nitrogen replacement when heating up the brazed part.</li> </ul>	 <p style="text-align: center;">Four way valve</p> <p style="text-align: right;">(R7249)</p>	
<p>6 Heat up the brazed part and withdraw the piping with pliers.</p>		<p><b>In case of difficulty with gas brazing machine</b></p> <ol style="list-style-type: none"> <li>1. Disconnect the brazed part where is easy to disconnect and restore.</li> <li>2. Cut pipes on the main unit with a tube cutter in order to make it easy to disconnect.</li> </ol>

Step	Procedure	Points
	 <p>(R7250)</p>	<p><b>Note:</b></p> <ul style="list-style-type: none"><li>■ Do not use a metal saw for cutting pipes by all means because the sawdust comes into the circuit.</li><li>■ When withdrawing the pipes, be careful not to pinch them firmly with pliers. The pipes may get deformed.</li><li>■ Provide a protective sheet or a steel plate so that the brazing flame cannot influence peripheries.</li></ul>

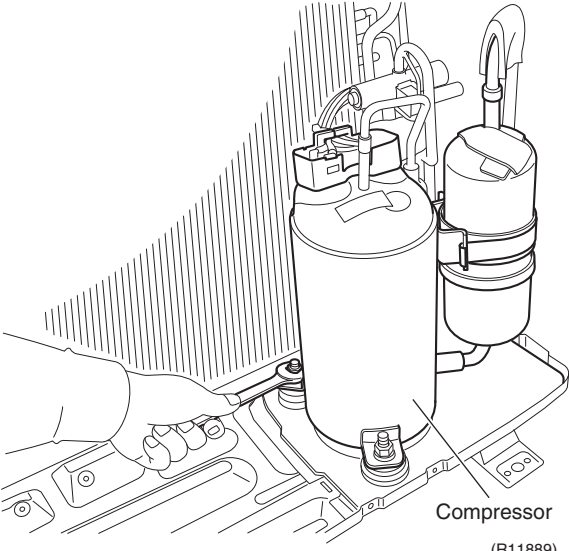
### 3.8 Removal of Compressor

**Procedure**

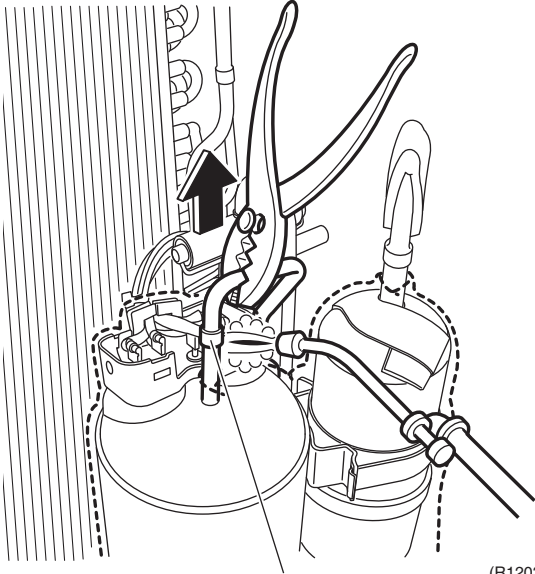
 **Warning** Be sure to wait 10 minutes or more after turning off all power supplies before disassembling work.

Step	Procedure	Points
1	<p>Remove the 2 nuts of the compressor.</p>  <p style="text-align: right;">Compressor (R11889)</p>	<p> <b>Warning</b> Be careful not to get yourself burnt with pipes and other parts that are heated by the gas brazing machine.</p> <p> <b>Warning</b> If the refrigerant gas leaks during work, ventilate the room. (If the refrigerant gas is exposed to flames, toxic gas may be generated.)</p> <p> <b>Warning</b> Since it may happen that the refrigerant oil in the compressor catches fire, prepare wet cloth so as to extinguish fire immediately.</p>
<ul style="list-style-type: none"> <li>■ Before working, make sure that the refrigerant is empty in the circuit.</li> <li>■ Be sure to apply nitrogen replacement when heating up the brazed part.</li> </ul>	 <p style="text-align: center;">Discharge side (R12031)</p>	<p> <b>Caution</b> From the viewpoint of global environment protection, do not discharge the refrigerant gas in the atmosphere. Make sure to collect all the refrigerant gas.</p>
2	<p>Heat up the brazed part of the discharge side and disconnect.</p>	<p><b>Cautions for restoration</b></p> <ol style="list-style-type: none"> <li>1. Restore the piping by non-oxidation brazing.</li> <li>2. It is required to prevent the carbonization of the oil inside the four way valve and the deterioration of the gaskets affected by heat. (Keep below 120°C.) For the sake of this, wrap the four way valve with wet cloth and provide water so that the cloth does not dry.</li> </ol> <p><b>In case of difficulty with gas brazing machine</b></p> <ol style="list-style-type: none"> <li>1. Disconnect the brazed part where is easy to disconnect and restore.</li> <li>2. Cut pipes on the main unit with a tube cutter in order to make it easy to disconnect.</li> </ol>

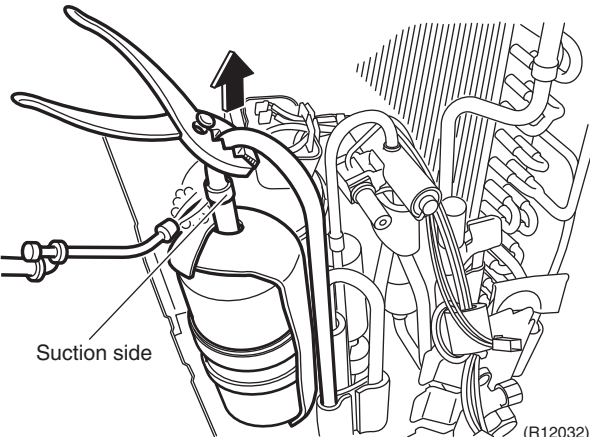
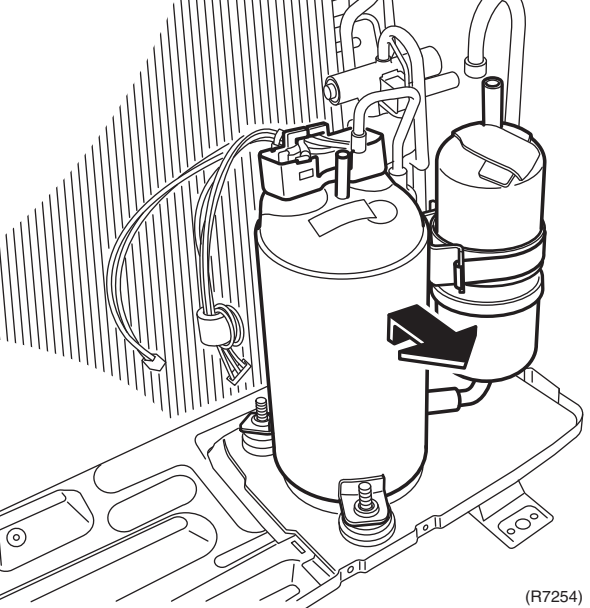
Step		Procedure	Points
3	Heat up the brazed part of the suction side and disconnect.	 <p>Suction side</p> <p>(R12032)</p>	<p><b>Note:</b></p> <ul style="list-style-type: none"> <li>■ Do not use a metal saw for cutting pipes by all means because the sawdust comes into the circuit.</li> <li>■ When withdrawing the pipes, be careful not to pinch them firmly with pliers. The pipes may get deformed.</li> <li>■ Provide a protective sheet or a steel plate so that the brazing flame cannot influence peripheries.</li> </ul>
4	Lift the compressor up and remove it.	 <p>(R7254)</p>	<ul style="list-style-type: none"> <li>■ Be careful so as not to burn the compressor terminals, the name plate, the heat exchanger fin.</li> </ul>

# 4. Outdoor Unit - RXL25G2V1B

## 4.1 Removal of Outer Panels

Procedure



Warning

Be sure to wait 10 minutes or more after turning off all power supplies before disassembling work.

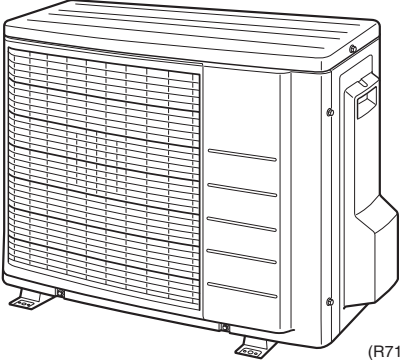
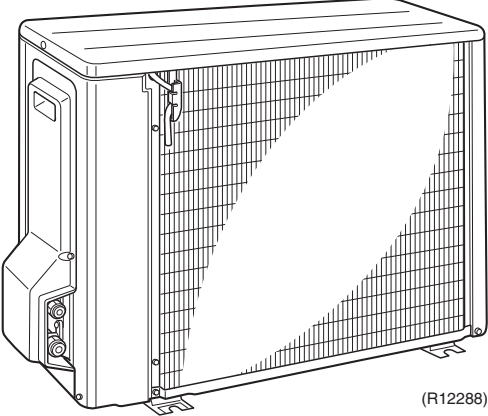
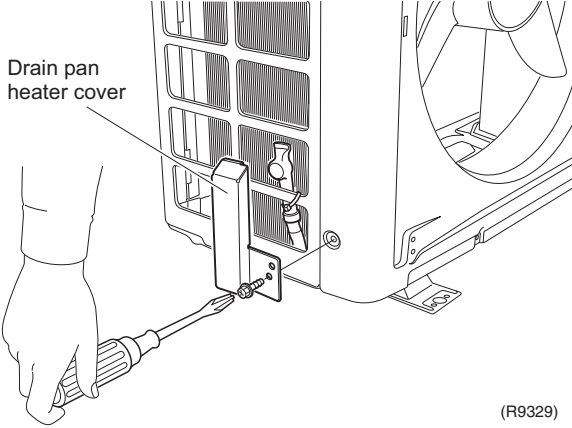
Step	Procedure	Points
1. Appearance features	 <p>(R7186)</p>  <p>(R12288)</p>	
2. Remove the panels.	<p>1 Remove the screw and remove the drain pan heater cover.</p>  <p>Drain pan heater cover</p> <p>(R9329)</p>	

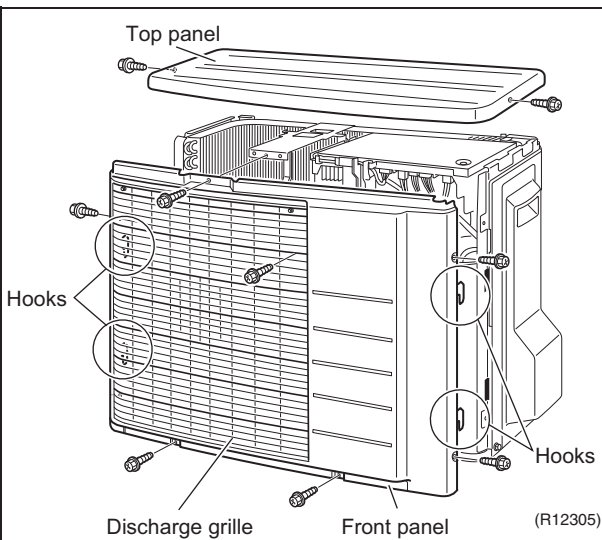
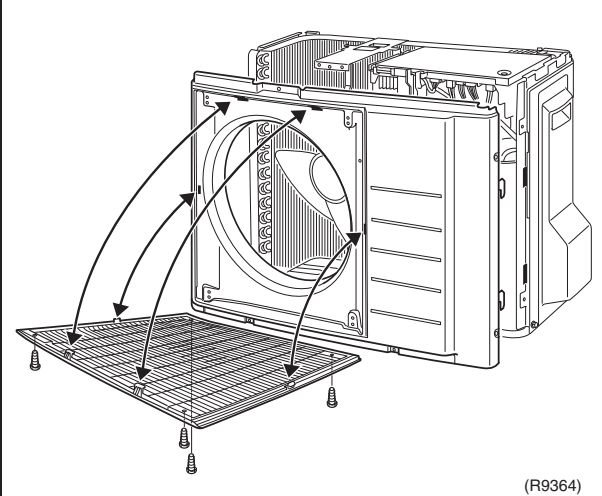
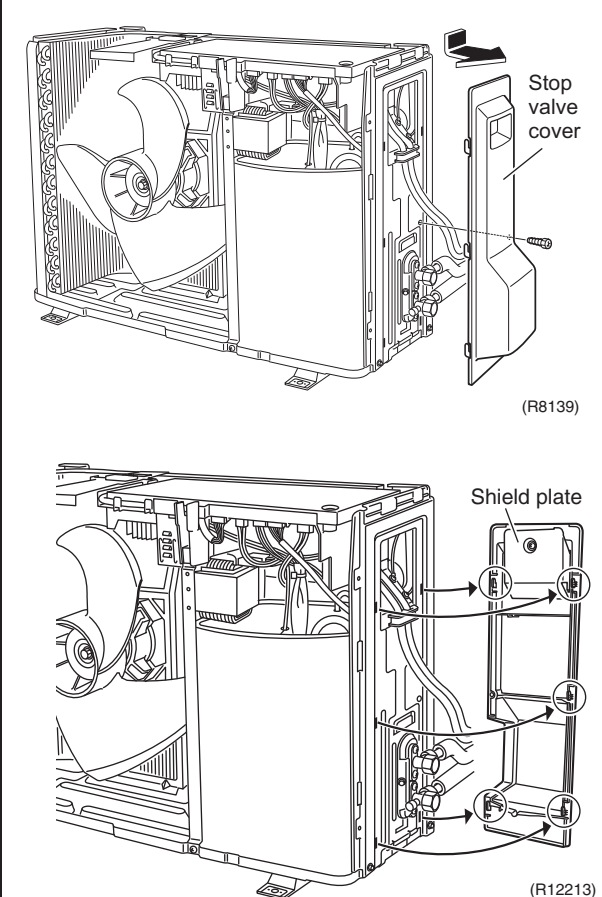
Step		Procedure	Points
2	Remove the 2 screws to remove the top panel, and 7 screws to remove the front panel.		<ul style="list-style-type: none"> <li>■ The front panel has 4 hooks.</li> </ul>
3	Remove the 4 screws and remove the discharge grille.		<ul style="list-style-type: none"> <li>■ When reassembling, make sure to fit the 4 hooks.</li> </ul>
4	Remove the screw and remove the stop valve cover.		<ul style="list-style-type: none"> <li>■ The stop valve cover is united with the shield plate.</li> <li>■ When reassembling, make sure to fit the 5 hooks.</li> </ul>

## 4.2 Removal of Electrical Box

**Procedure**



**Warning**

Be sure to wait 10 minutes or more after turning off all power supplies before disassembling work.

Step	Procedure	Points
<p>1. Disconnect the connecting wires.</p> <p>1 Remove the 3 screws to remove the wiring fixture. Then remove the all screws to disconnect the power supply cables and the connecting wires.</p>		<p>■ When reassembling, fasten the wires with screws on the terminal board.</p>
<p>2. Remove the electrical box.</p> <p>1 Release the outdoor temperature thermistor.</p> <p>2 Remove the 7 screws, and remove the right side panel.</p>		

Step	Procedure	Points
3	Remove the screw of the terminal board.	
4	Disconnect the connectors of the drain pan heater.	
5	Cut the clamp.	
6	Disconnect the connector for the fan motor [S70].	<ul style="list-style-type: none"> <li>■ For removal procedure of the fan motor lead wire, refer to "Removal of Outdoor Fan / Fan Motor".</li> </ul>

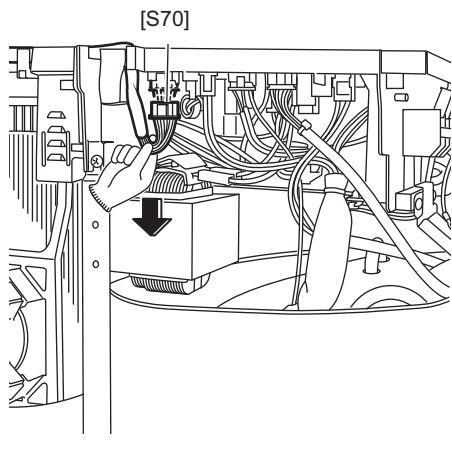
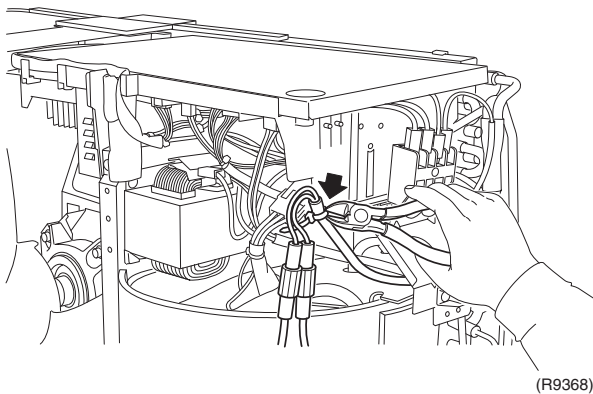
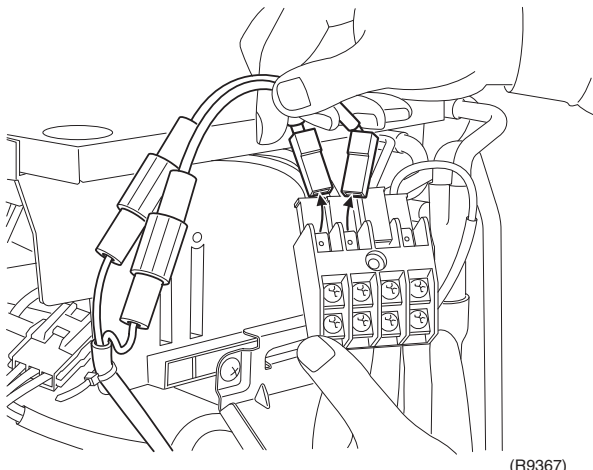
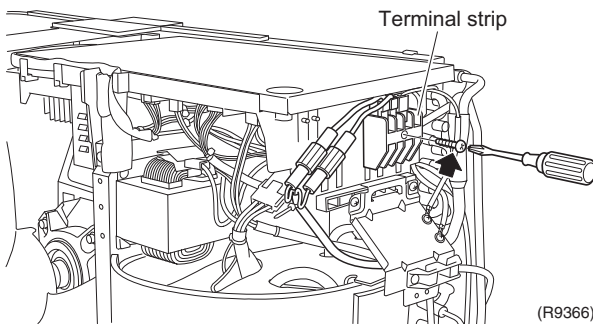



Step	Procedure	Points
7	Disconnect the connector for the overload protector [S40].	(R0255)
8	Disconnect the connector for the electronic expansion valve coil [S20].	(R0256)
9	Disconnect the connector for the four way valve coil [S80].	(R0257)
10	Disconnect the connector for the thermistors [S90].	(R0258)

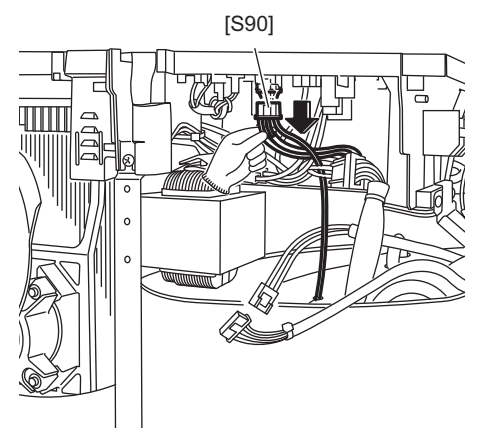
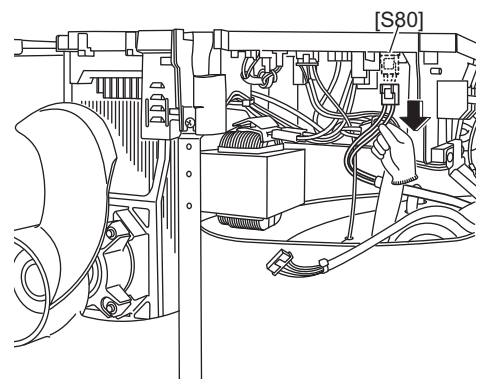
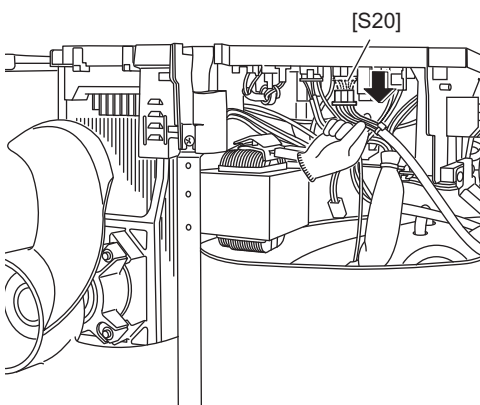
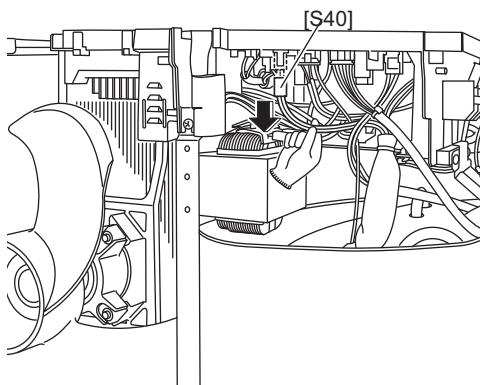

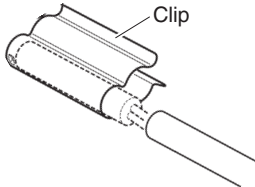
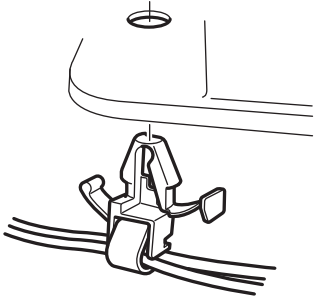
Step	Procedure	Points
11	Disconnect the relay connector for the compressor.	
12	Disconnect the 2 connectors for the reactor.	
13	Release the discharge pipe thermistor.	<p>■ Be careful not to lose the clip for the thermistor.</p>  <p>Clip</p> <p>(R12279)</p>
14	Detach the clamp for the thermistors from the electrical box.	 <p>(R12196)</p>

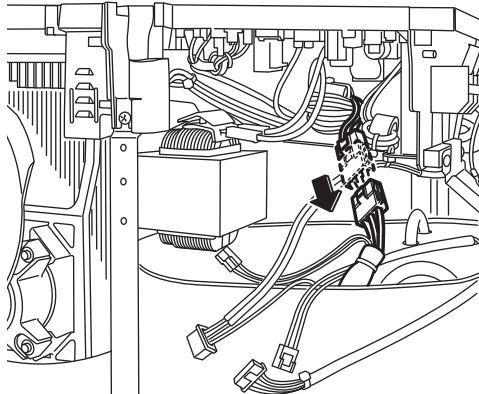

(R0259)

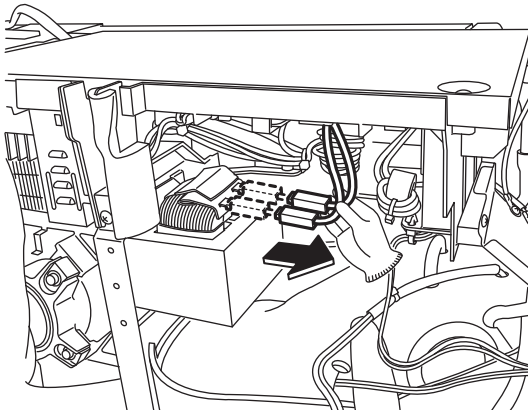

(R0260)

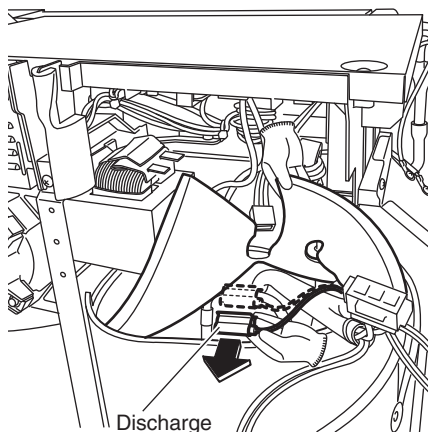

Discharge pipe thermistor

(R12195)

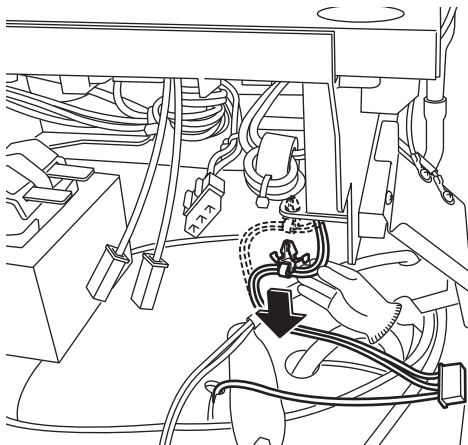

(R0262)

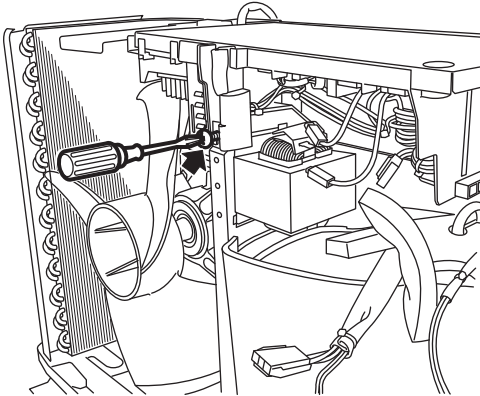
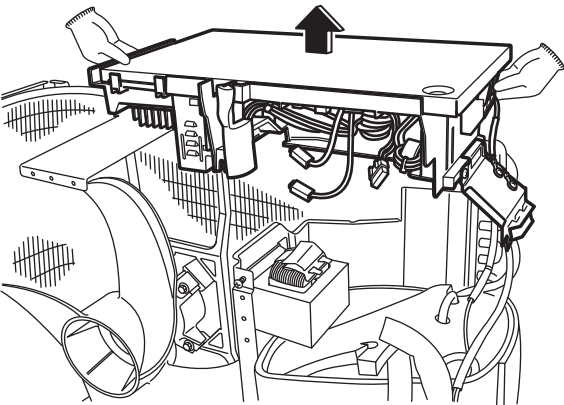
Step	Procedure	Points
15	<p data-bbox="197 217 440 309">Remove the screw in front of the electrical box.</p>  <p data-bbox="986 658 1050 680">(R0263)</p>	
16	<p data-bbox="197 696 419 763">Lift and remove the electrical box.</p>  <p data-bbox="1018 1144 1082 1167">(R0264)</p>	

## 4.3 Removal of PCB

### Procedure



### Warning

Be sure to wait 10 minutes or more after turning off all power supplies before disassembling work.

Step	Procedure	Procedure	Points
1	Remove the screw and remove the electrical box cover.		<p><b>Preparation</b></p> <ul style="list-style-type: none"> <li>■ Remove the panels according to the “Removal of Outer Panels”.</li> <li>■ Remove the electrical box according to the “Removal of Electrical Box”.</li> </ul>
2	Detach the insulation sheet.		<ul style="list-style-type: none"> <li>■ The trimmed part goes front.</li> </ul>
3	Remove the 2 screws of the earth terminals.		

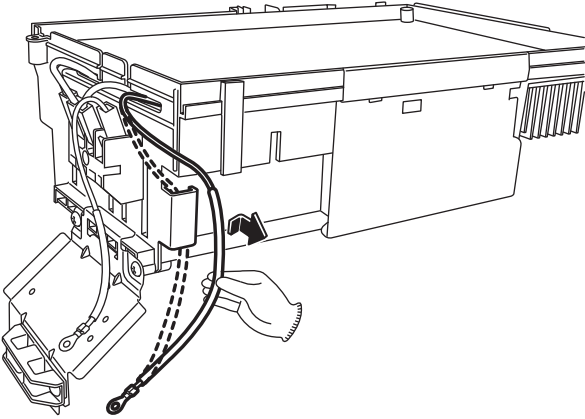
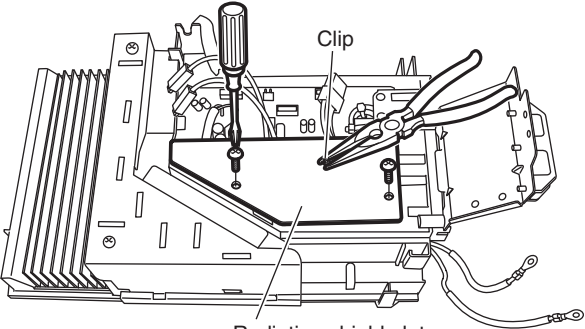
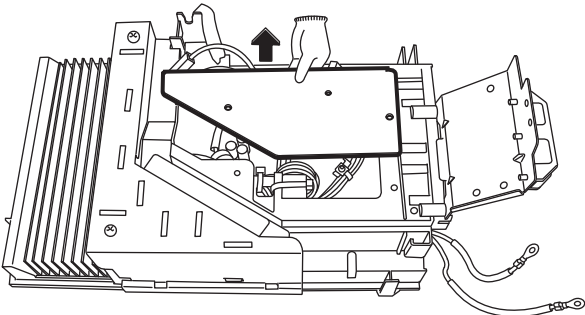
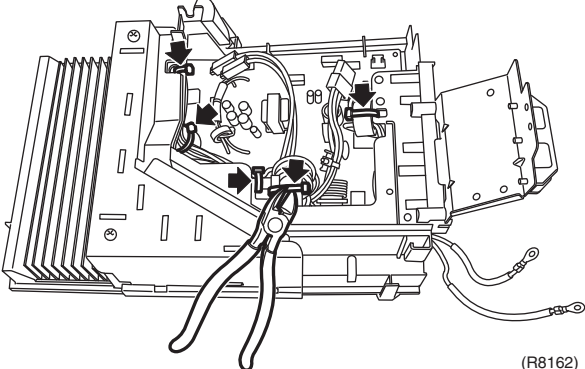
Step	Procedure	Points
4	<p>Release the earth wire from the hook.</p>  <p>(R8159)</p>	
5	<p>Remove the 2 screws and detach the 1 clip to remove the radiation shield plate.</p>  <p>Clip</p> <p>Radiation shield plate</p> <p>(R12198)</p>  <p>(R8161)</p>	
6	<p>Cut off the 5 clamps and disconnect the wire harnesses.</p>  <p>(R8162)</p>	

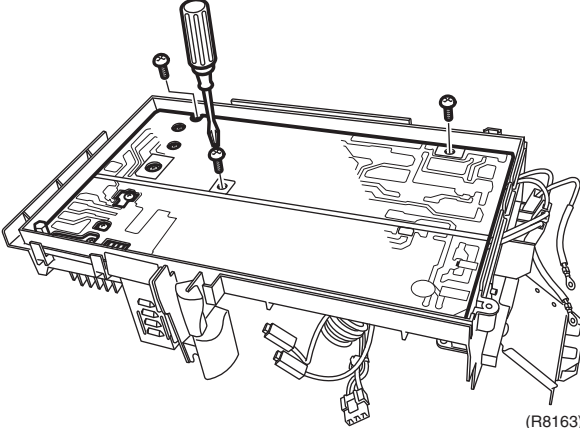
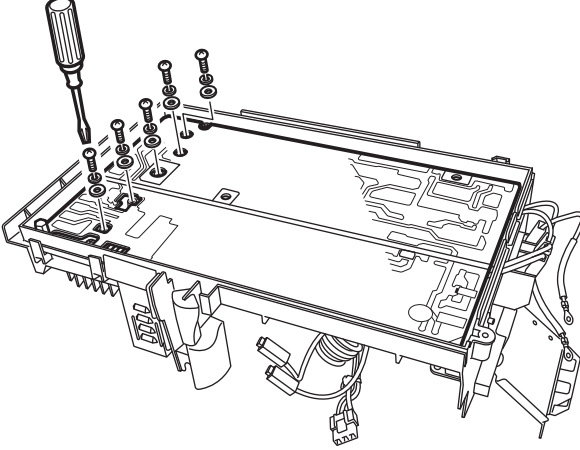
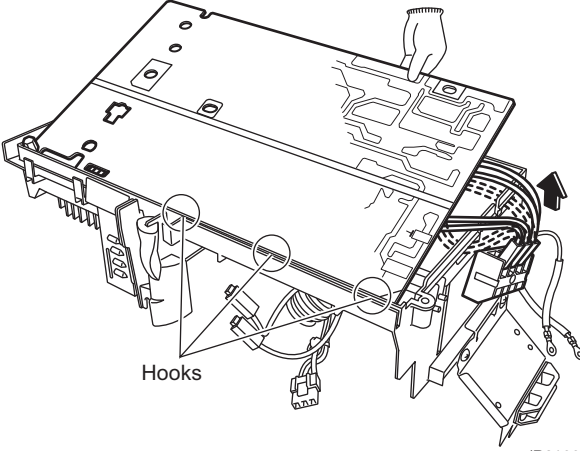
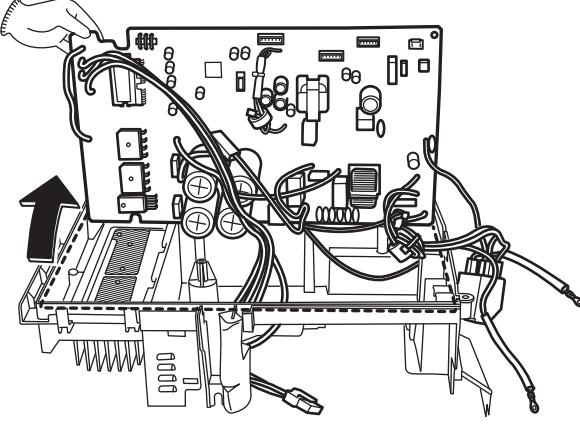
Step	Procedure	Points
7	<p>Remove the 8 screws in total to remove the PCB.</p>  <p>(R8163)</p>  <p>(R8164)</p>	
8	<p>Lift up the back side slightly and unfasten the hooks of the front.</p>  <p>Hooks</p> <p>(R8166)</p>	<ul style="list-style-type: none"> <li>When reassembling, make sure that the hooks of the electrical box are placed on the PCB.</li> </ul>
9	<p>Lift up the PCB.</p>  <p>(R8167)</p>	

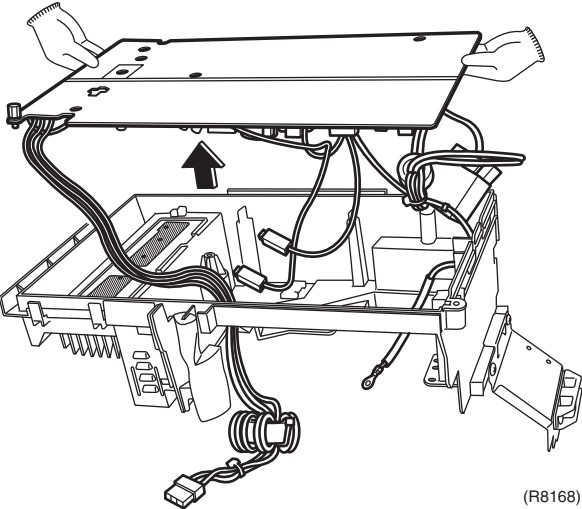
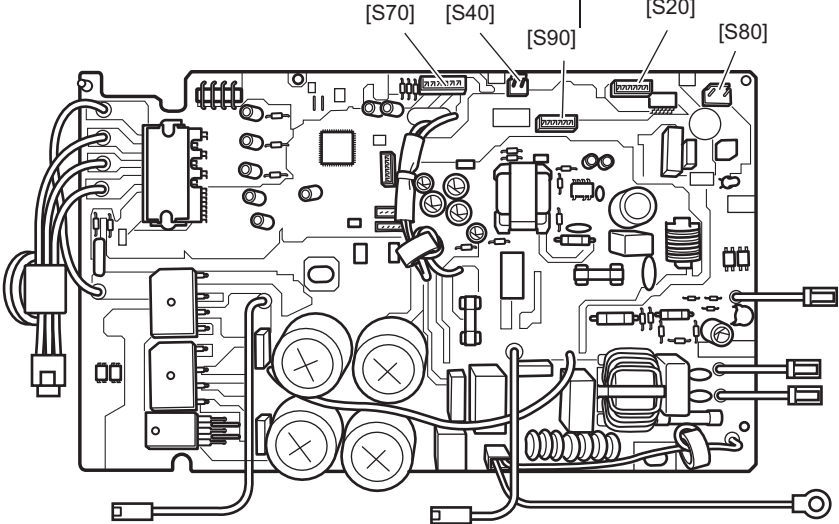
Step	Procedure	Points
10	Remove the PCB.  <p>(R8168)</p>	
11	Detach the terminals from the terminal board.  <p>(R8169)</p>	<p>■ Refer to page 16 for detail.</p> <p>[S20] : electronic expansion valve coil                      [S40] : overload protector                      [S70] : fan motor                      [S80] : four way valve coil                      [S90] : thermistors</p>

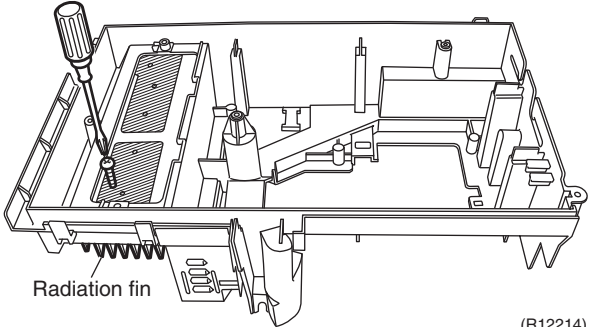
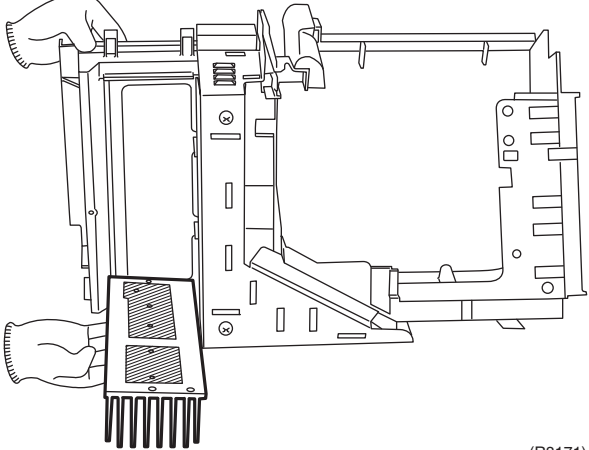
Step	Procedure	Points
12	<p data-bbox="199 219 446 280">Remove the screw of the radiation fin.</p>  <p data-bbox="518 548 638 571">Radiation fin</p> <p data-bbox="1005 582 1077 604">(R12214)</p>  <p data-bbox="1013 1075 1077 1097">(R8171)</p>	



# 4.4 Removal of Drain Pan Heater

**Procedure**

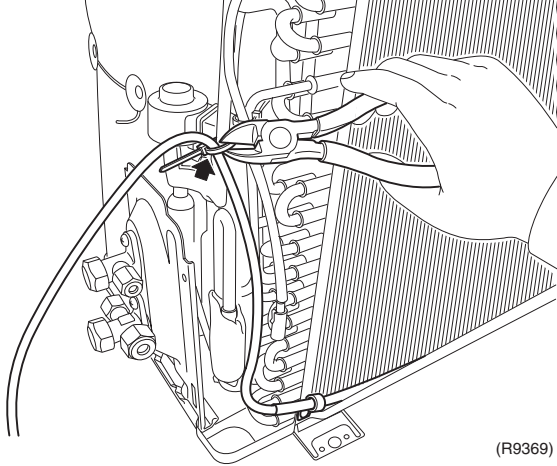
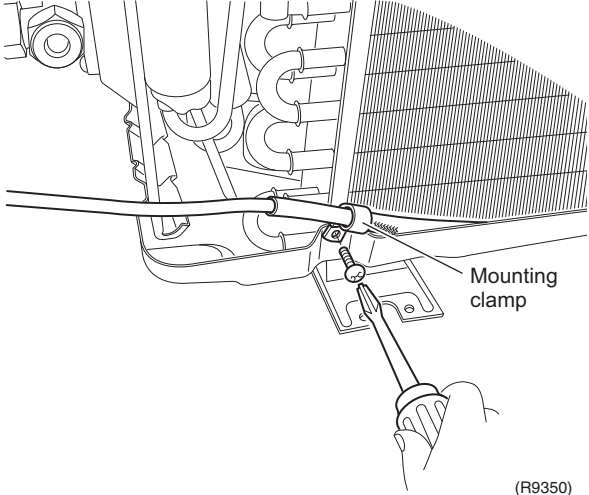
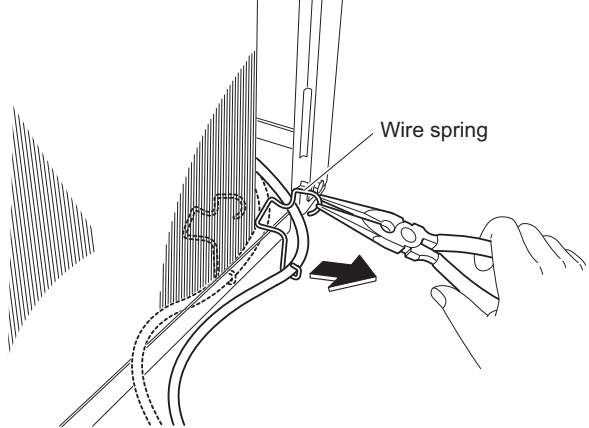
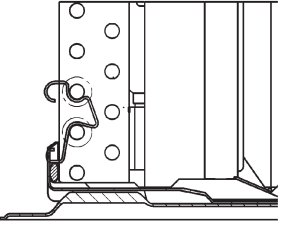

**Warning** Be sure to wait 10 minutes or more after turning off all power supplies before disassembling work.

Step	Procedure	Points
1.	Remove the drain pan heater.	
1	Cut the clamp.	
	 <p>(R9369)</p>	
2	Remove the screw of the mounting clamp.	
3	<p>Release the drain pan heater ASSY from the ditch between the bottom frame and the outdoor heat exchanger ASSY. Remove the wire spring with long nose pliers.</p>  <p>Mounting clamp</p> <p>(R9350)</p>  <p>Wire spring</p> <p>(R9351)</p>	<ul style="list-style-type: none"> <li>■ Take care not to cut your finger by the fins of the outdoor heat exchanger.</li> <li>■ When reassembling, hang the wire spring to the hair pin cooling tube.</li> </ul>  <p>(R9748)</p>

Step	Procedure	Points
4	Cut the clamp.	
5	Remove the 3 screws and remove the left side panel.	
6	The fuses are inside the drain pan heater.	

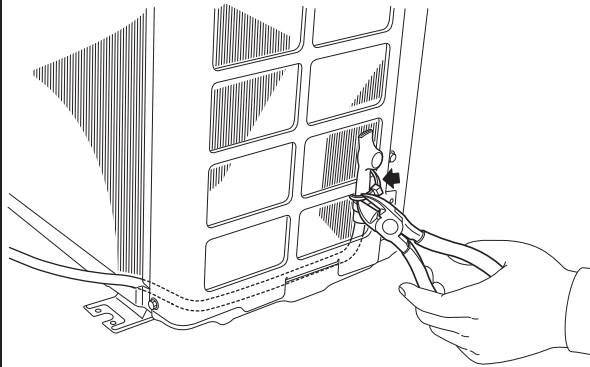

(R9352)

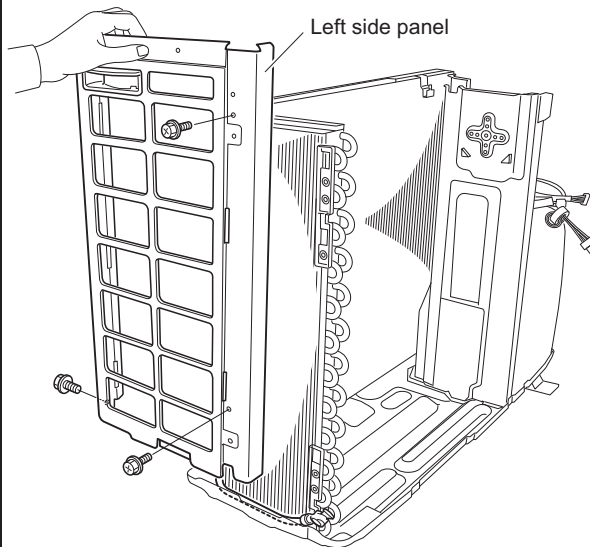

(R12307)

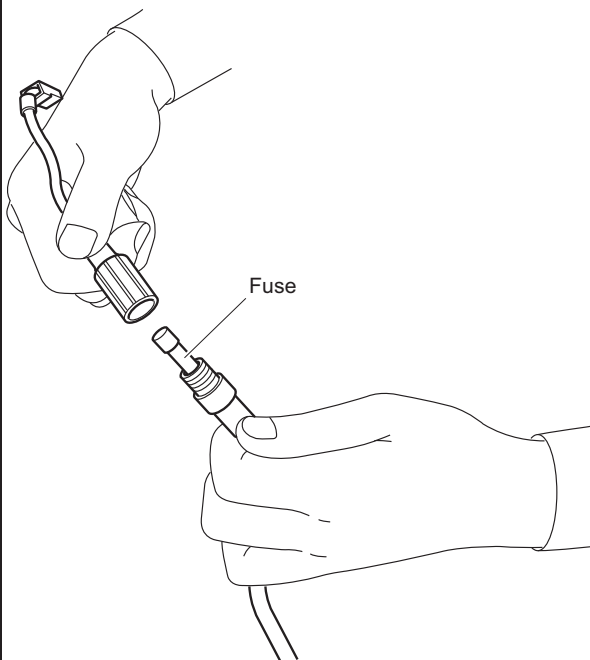

(R9354)

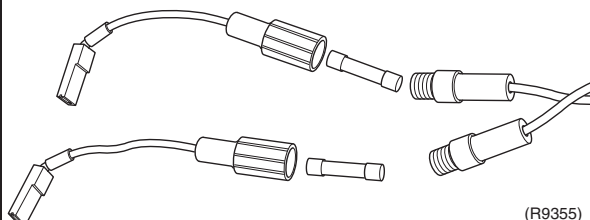

(R9355)

# 4.5 Removal of Sound Blanket

**Procedure**



**Warning**

Be sure to wait 10 minutes or more after turning off all power supplies before disassembling work.

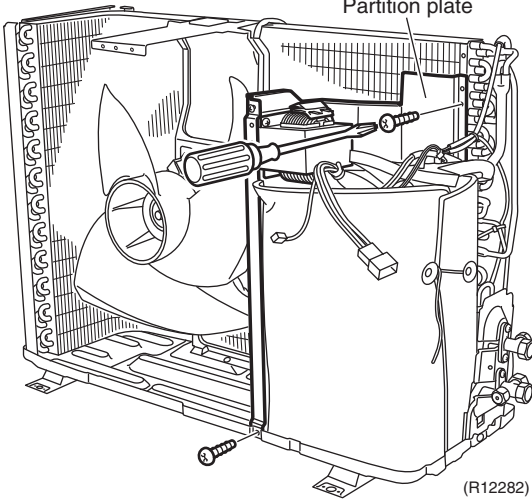
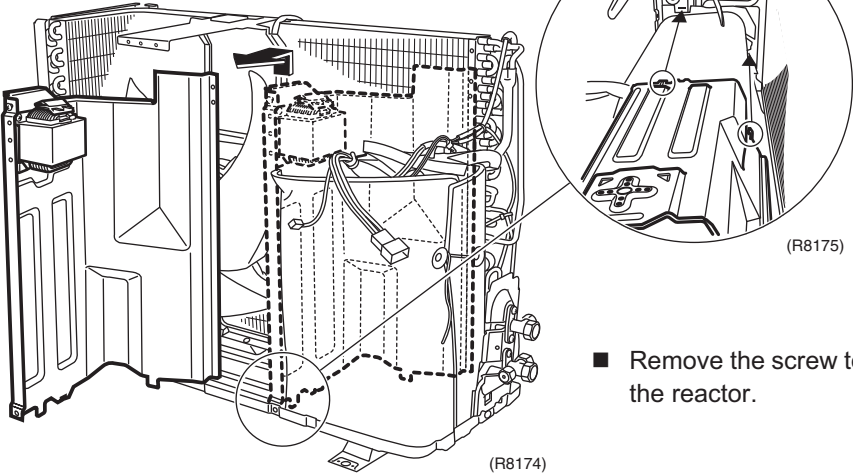
Step	Procedure	Points
1. Remove the partition plate.	<p data-bbox="193 427 454 459">1 Remove the 2 screws.</p>  <p data-bbox="852 412 986 434">Partition plate</p> <p data-bbox="975 893 1043 913">(R12282)</p>	<ul style="list-style-type: none"> <li data-bbox="1094 792 1437 887">■ When reassembling, fit the lower hook into the bottom frame.</li> </ul>
2	<p data-bbox="193 929 454 1088">The partition plate has hooks on the lower side. Lift and pull the partition plate to remove.</p>  <p data-bbox="987 1462 1050 1482">(R8174)</p> <p data-bbox="1289 1245 1351 1265">(R8175)</p>	<ul style="list-style-type: none"> <li data-bbox="1094 1357 1465 1417">■ Remove the screw to remove the reactor.</li> </ul>

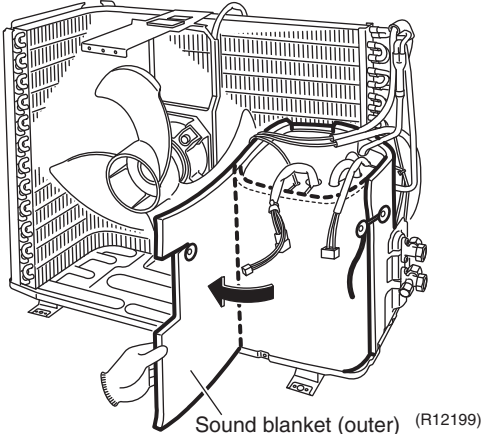
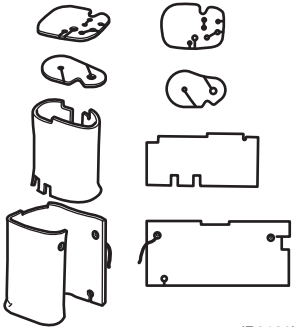
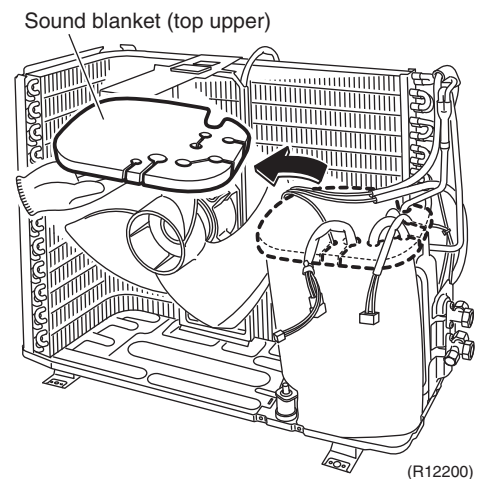
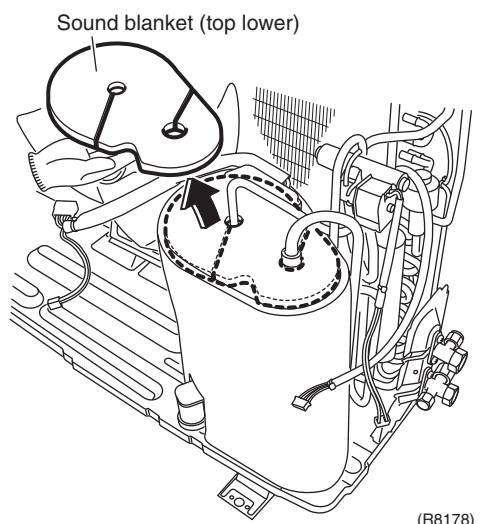
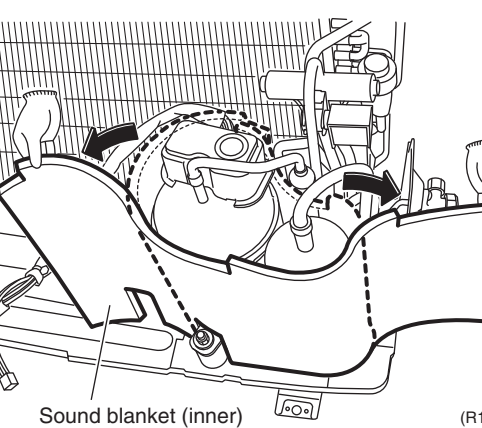
Step	Procedure	Points
2. Remove of the sound blanket.	 <p>Sound blanket (outer) (R12199)</p>	<ul style="list-style-type: none"> <li>Since the piping ports are torn easily, remove the blanket carefully.</li> </ul>  <p>(R8180)</p>
1 Untie the string, open the sound blanket (outer) and pull it out.	<p>2 Remove the sound blanket (top upper).</p>  <p>Sound blanket (top upper)</p> <p>(R12200)</p>	
2 Remove the sound blanket (top upper).	<p>3 Remove the sound blanket (top lower).</p>  <p>Sound blanket (top lower)</p> <p>(R8178)</p>	
3 Remove the sound blanket (top lower).	<p>4 Open the sound blanket (inner) and pull it out.</p>  <p>Sound blanket (inner) (R12201)</p>	

## 4.6 Removal of Outdoor Fan / Fan Motor

**Procedure**



**Warning**

Be sure to wait 10 minutes or more after turning off all power supplies before disassembling work.

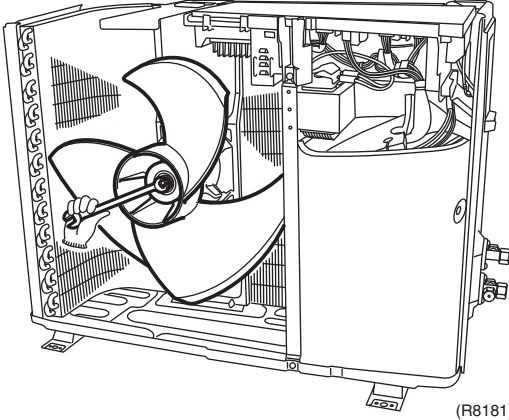
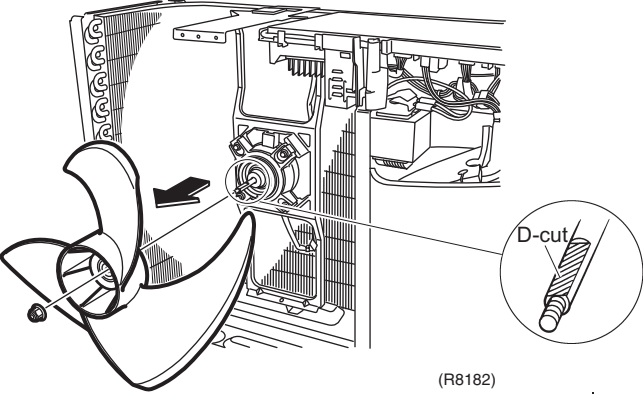
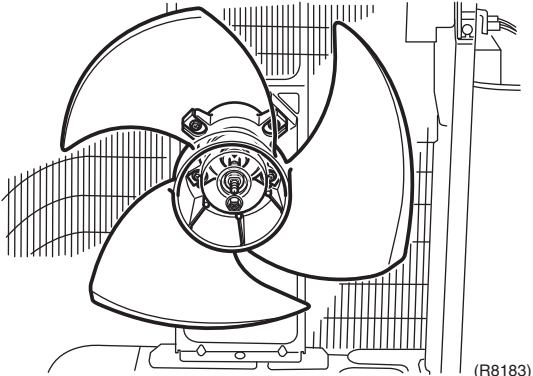
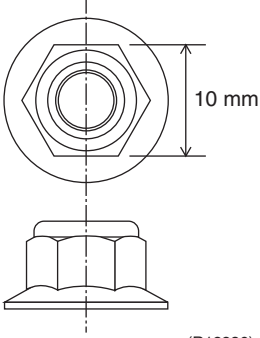
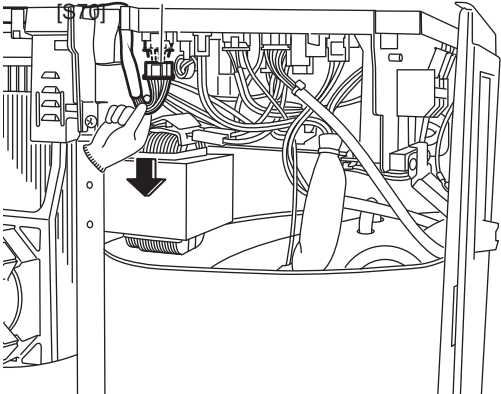
Step	Procedure	Points
<p>1. Remove the outdoor fan.</p> <p>1 Remove the washer fitted nut of the outdoor fan.</p> <p>2 Remove the outdoor fan.</p>	 <p>(R8181)</p>  <p>(R8182)</p>  <p>(R8183)</p>	<ul style="list-style-type: none"> <li>■ The screw has reverse winding.</li> <li>■ Nut size: M6</li> </ul>  <p>10 mm</p> <p>(R12236)</p> <ul style="list-style-type: none"> <li>■ When reassembling, align ▼ mark of the outdoor fan with D-cut section of the motor shaft.</li> </ul>
<p>2. Remove the fan motor.</p> <p>1 Disconnect the connector for the fan motor [S70].</p>	 <p>(R8184)</p>	

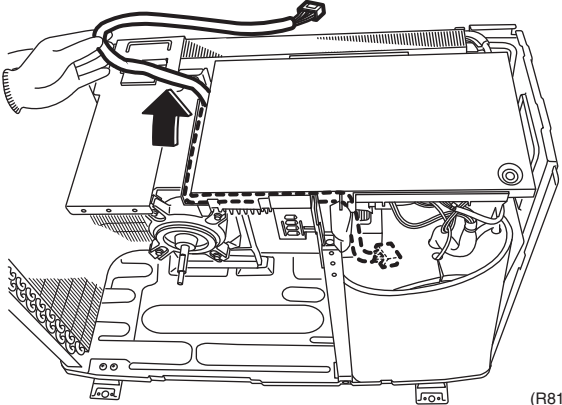
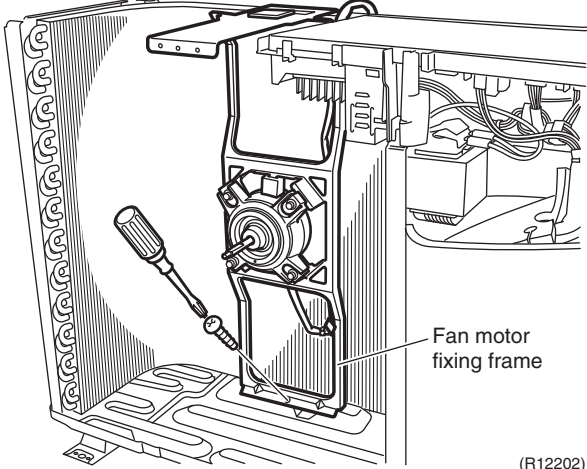
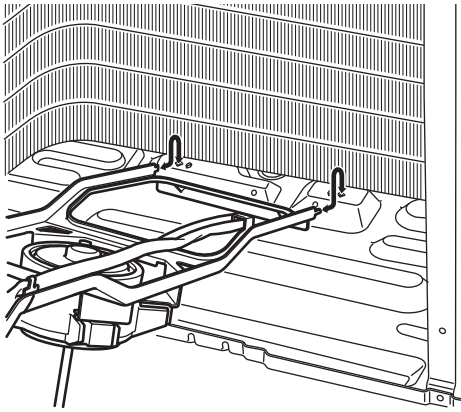
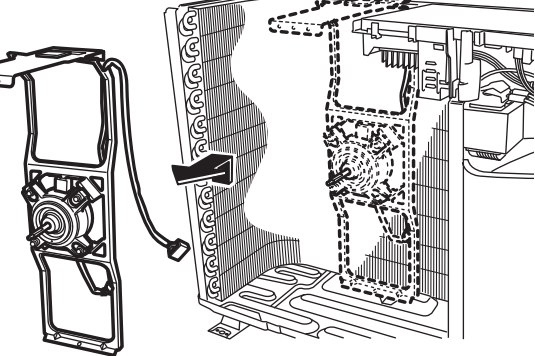
Step	Procedure	Points	Points
2	<p>The figure shows the arrangement of the fan motor lead wire.</p>	 <p>(R8185)</p>	
3	<p>Remove the 1 screw of the fan motor fixing frame.</p>	 <p>Fan motor fixing frame</p> <p>(R12202)</p>  <p>(R8187)</p>	
4	<p>Remove the fan motor fixing frame.</p>	 <p>(R8188)</p>	

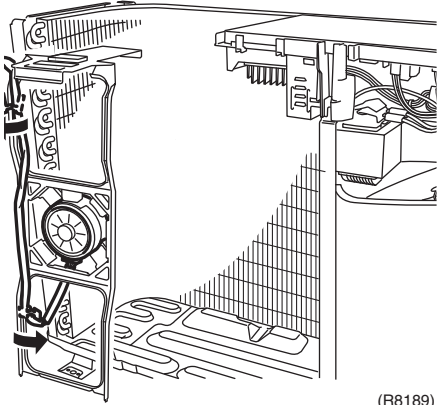
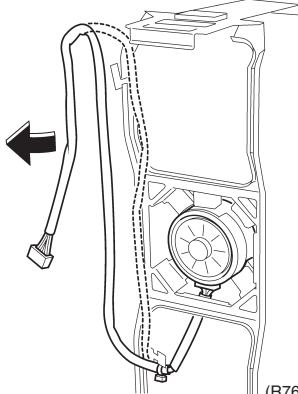
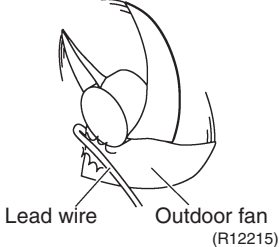
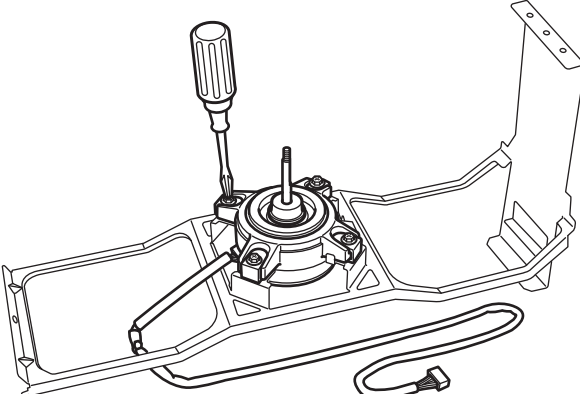
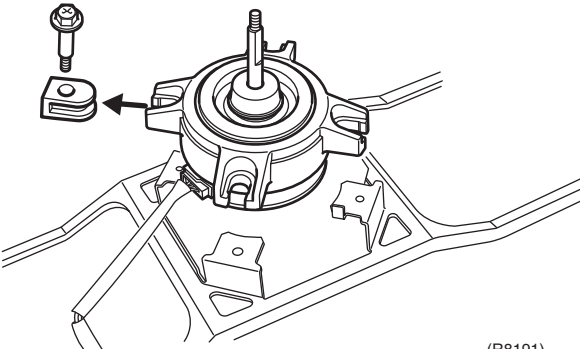
Step	Procedure	Points
5	<p>Turn the fan motor fixing frame backward and open the 2 hooks of the fan motor lead wire.</p>  <p>(R8189)</p>	
6	<p>Release the fan motor lead wire.</p>  <p>(R7627)</p>	<p>■ When reassembling, put the fan motor lead wire through the back of the fan motor (so as not to be entangled with the outdoor fan).</p>  <p>Lead wire Outdoor fan (R12215)</p>
7	<p>Remove the 4 screws and 4 rubber vibration isolators to remove the fan motor.</p>  <p>(R8190)</p>  <p>(R8191)</p>	

## 4.7 Removal of Thermistors

### Procedure



### Warning

Be sure to wait 10 minutes or more after turning off all power supplies before disassembling work.

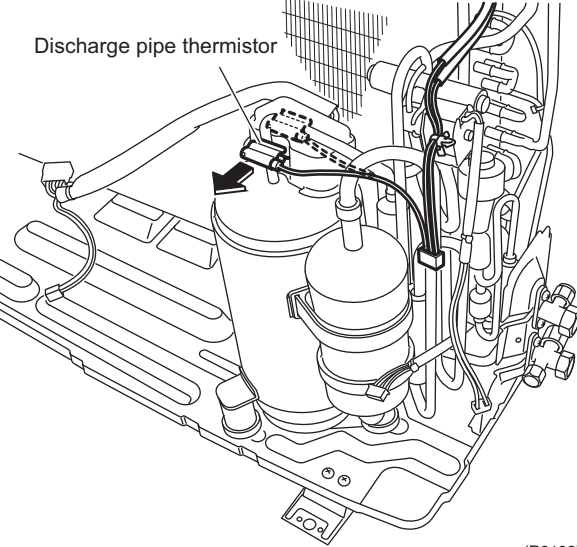
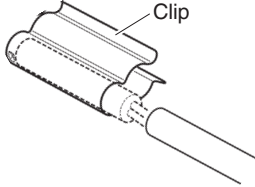
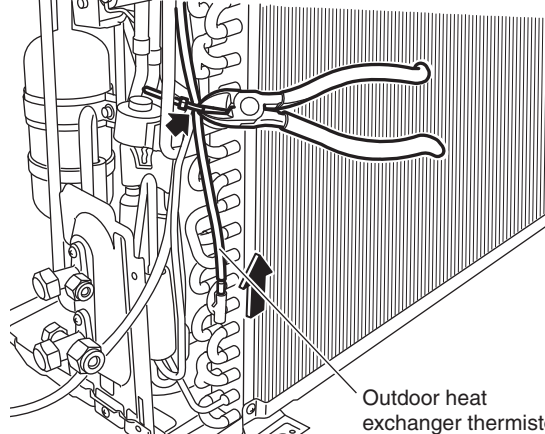
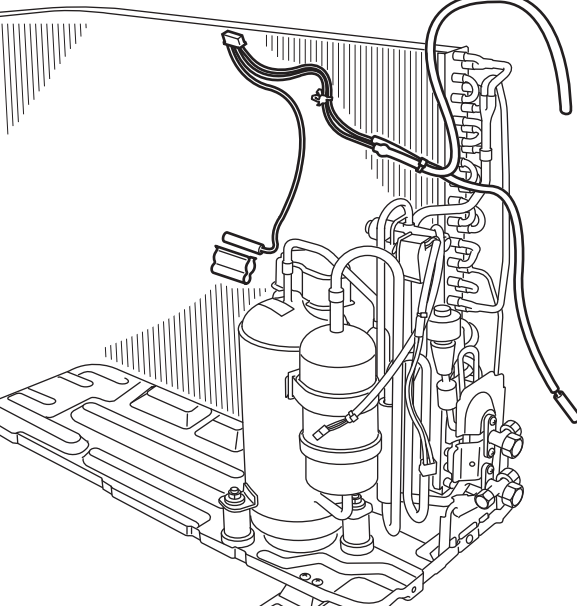
Step	Procedure	Procedure	Points
1	Release the discharge pipe thermistor.	 <p style="text-align: right;">(R8192)</p>	<p>■ Be careful not to lose the clip for the thermistor.</p>  <p style="text-align: right;">(R12279)</p>
2	Cut the clamp and pull out the outdoor heat exchanger thermistor.	 <p style="text-align: right;">(R8193)</p>	
3	The thermistors for outdoor temperature / discharge pipe / outdoor heat exchanger are united as one assembly.	 <p style="text-align: right;">(R8194)</p>	
4	The figure shows the arrangement of the thermistors.		



# 4.8 Removal of Four Way Valve / Electronic Expansion Valve

**Procedure**



**Warning**

Be sure to wait 10 minutes or more after turning off all power supplies before disassembling work.

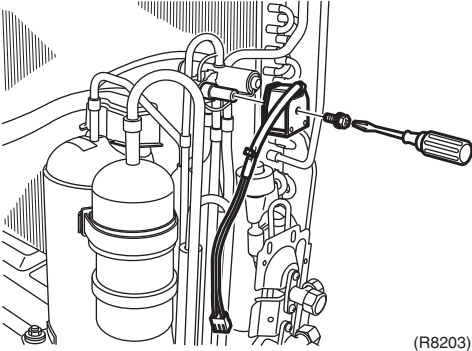
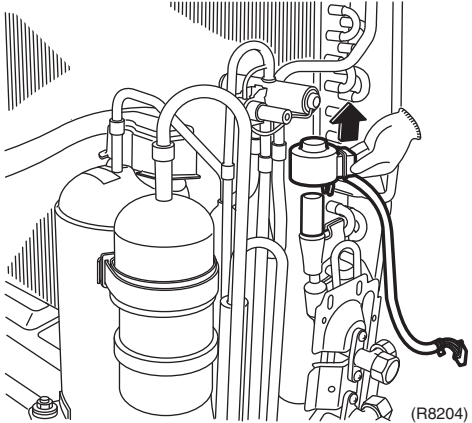
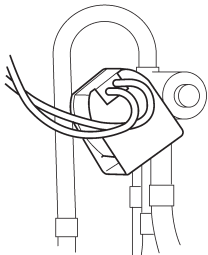
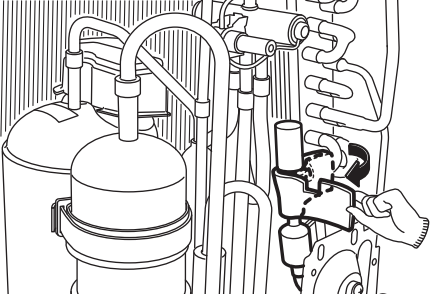
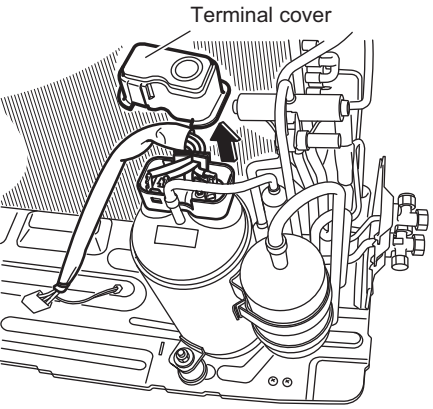
Step	Procedure	Procedure	Points
1.	Remove the peripheries.		<b>Preparation</b>
1	Remove the screw and remove the four way valve coil.	 <p>(R8203)</p>	<ul style="list-style-type: none"> <li>Remove the sound blanket.</li> </ul>
2	Pull out the electronic expansion valve coil.	 <p>(R8204)</p>	 <p>(R7703)</p>
3	Remove the putty.	 <p>(R8205)</p>	<ul style="list-style-type: none"> <li>Detach the four way valve coil and the 2 clamps, and then detach the wire harnesses.</li> </ul>
4	Remove the terminal cover.	 <p>Terminal cover (R8195)</p>	

Step	Procedure	Points
<ul style="list-style-type: none"> <li>■ Before working, make sure that the refrigerant gas is empty in the circuit.</li> <li>■ Be sure to apply nitrogen replacement when heating up the brazed part.</li> </ul>		<p><b>Warning</b> Be careful not to get yourself burnt with the pipes and other parts that are heated by the gas brazing machine.</p>
2.	Remove the four way valve and electronic expansion valve.	<p><b>Warning</b> If the refrigerant gas leaks during work, ventilate the room. (If the refrigerant gas is exposed to flames, toxic gas may be generated.)</p>
1	Heat up the 2 brazed parts of the electronic expansion valve and remove it.	<p><b>Caution</b> From the viewpoint of global environment protection, do not discharge the refrigerant gas in the atmosphere. Make sure to collect all the refrigerant gas.</p>
2	Heat up the brazed parts of the four way valve.	<p><b>Cautions for restoration</b></p> <ol style="list-style-type: none"> <li>1. Restore the piping by non-oxidation brazing.</li> <li>2. It is required to prevent the carbonization of the oil inside the four way valve and the deterioration of the gaskets affected by heat. (Keep below 120°C.) For the sake of this, wrap the four way valve with wet cloth and provide water so that the cloth does not dry.</li> </ol>
3	Pull the pipe with pliers and disconnect.	<p><b>In case of difficulty with gas brazing machine</b></p> <ol style="list-style-type: none"> <li>1. Disconnect the brazed part where is easy to disconnect and restore.</li> <li>2. Cut pipes on the main unit with a tube cutter in order to make it easy to disconnect.</li> </ol>

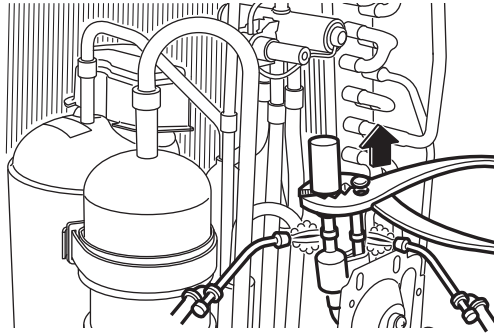

(R820)

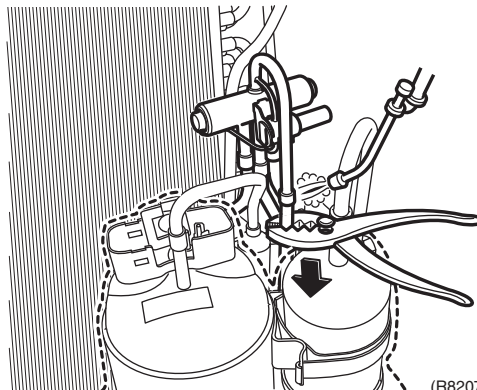

(R8207)

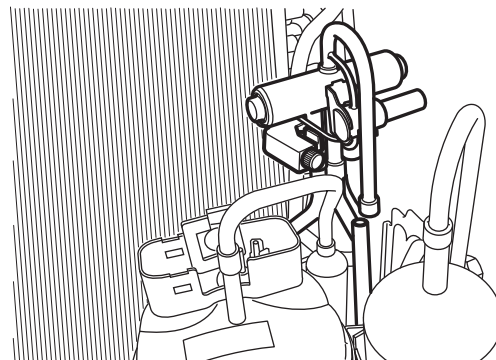

(R8208)

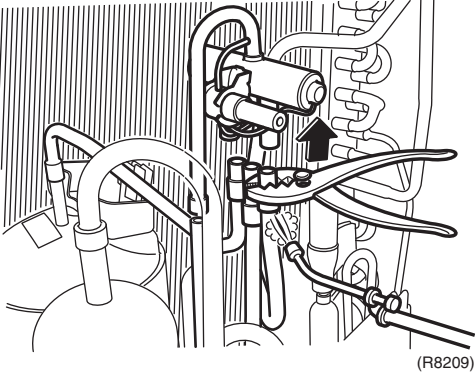
Step	Procedure	Points
	 <p>(R8209)</p>	<p><b>Note:</b></p> <ul style="list-style-type: none"><li>■ Do not use a metal saw for cutting pipes by all means because the sawdust comes into the circuit.</li><li>■ When withdrawing the pipes, be careful not to pinch them firmly with pliers. The pipes may get deformed.</li><li>■ Provide a protective sheet or a steel plate so that the brazing flame cannot influence peripheries.</li></ul>

## 4.9 Removal of Compressor

### Procedure



### Warning

Be sure to wait 10 minutes or more after turning off all power supplies before disassembling work.

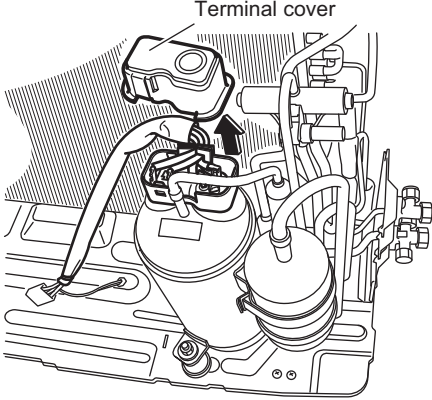
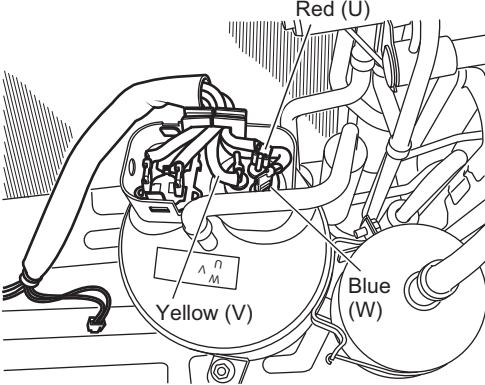
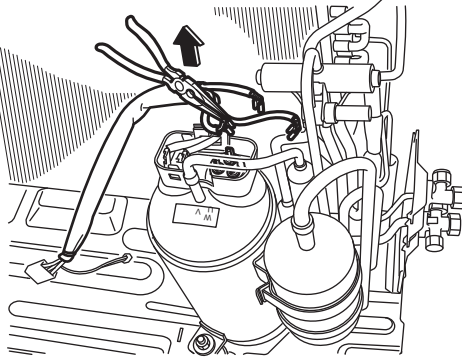
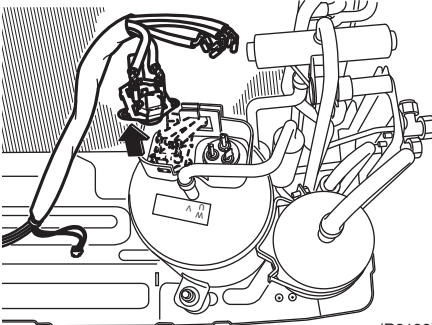
Step	Procedure	Procedure	Points
1	Remove the terminal cover.	 <p style="text-align: center;">Terminal cover</p> <p style="text-align: right;">(R8195)</p>	
2	Disconnect the lead wires of the compressor.	 <p style="text-align: center;">Red (U)</p> <p style="text-align: center;">Yellow (V)</p> <p style="text-align: center;">Blue (W)</p> <p style="text-align: right;">(R8196)</p>  <p style="text-align: right;">(R8197)</p>	
3	Unfasten the hooks with a flat screwdriver to remove the overload protector.	 <p style="text-align: right;">(R8198)</p>	

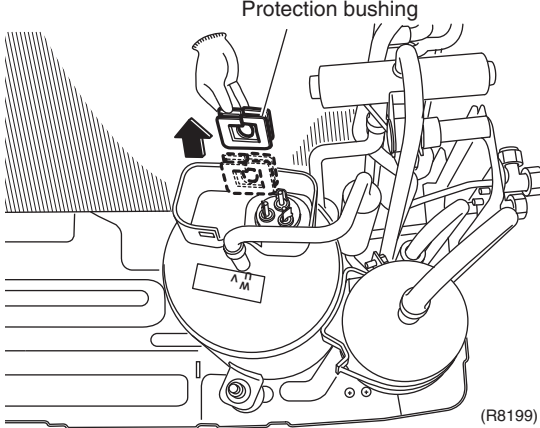
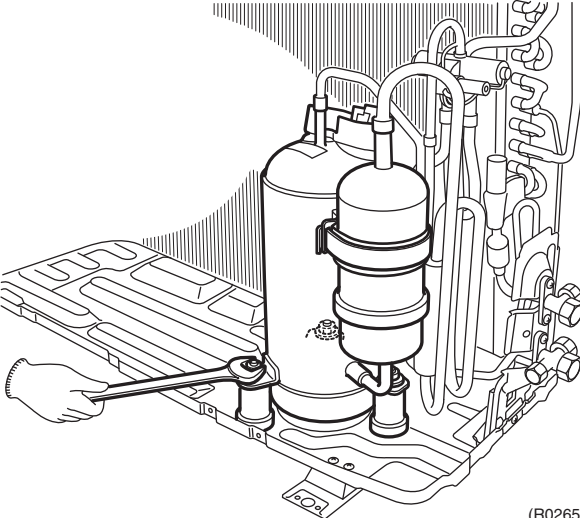
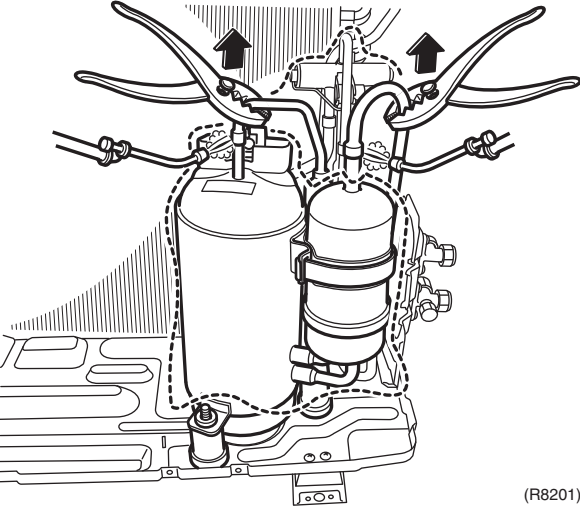
Step	Procedure	Points
4	<p>Remove the protection bushing.</p>  <p style="text-align: center;">Protection bushing</p> <p style="text-align: right;">(R8199)</p>	
5	<p>Remove the 2 nuts of the compressor.</p>  <p style="text-align: right;">(R0265)</p>	<p><b>Warning</b> Be careful not to get yourself burnt with the pipes and other parts that are heated by the gas brazing machine.</p>
6	<p>Heat up the brazed part of the discharge side and disconnect.</p> <p>7 Heat up the brazed part of the suction side and disconnect.</p>  <p style="text-align: right;">(R8201)</p>	<p><b>Warning</b> If the refrigerant gas leaks during work, ventilate the room. (If the refrigerant gas is exposed to flames, toxic gas may be generated.)</p> <p><b>Warning</b> Since it may happen that the refrigerant oil in the compressor catches fire, prepare wet cloth so as to extinguish fire immediately.</p> <p><b>Caution</b> From the viewpoint of global environment protection, do not discharge the refrigerant gas in the atmosphere. Make sure to collect all the refrigerant gas.</p>

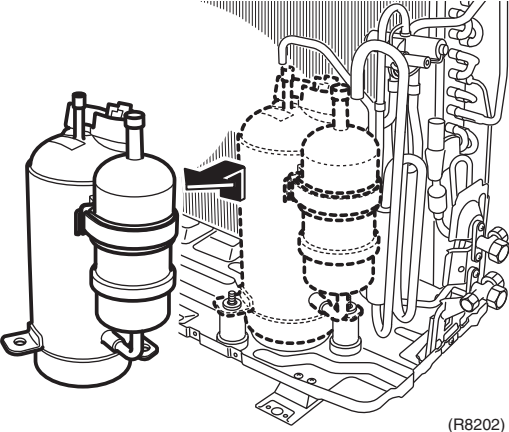
Step	Procedure	Points
8	<p>Lift the compressor up to remove.</p>  <p>(R8202)</p>	<p><b>Cautions for restoration</b></p> <ol style="list-style-type: none"> <li>1. Restore the piping by non-oxidation brazing.</li> <li>2. It is required to prevent the carbonization of the oil inside the four way valve and the deterioration of the gaskets affected by heat. (Keep below 120°C.) For the sake of this, wrap the four way valve with wet cloth and provide water so that the cloth does not dry.</li> </ol> <p><b>In case of difficulty with gas brazing machine</b></p> <ol style="list-style-type: none"> <li>1. Disconnect the brazed part where is easy to disconnect and restore.</li> <li>2. Cut pipes on the main unit with a tube cutter in order to make it easy to disconnect.</li> </ol> <p><b>Note:</b></p> <ul style="list-style-type: none"> <li>■ Do not use a metal saw for cutting pipes by all means because the sawdust comes into the circuit.</li> <li>■ When withdrawing the pipes, be careful not to pinch them firmly with pliers. The pipes may get deformed.</li> <li>■ Provide a protective sheet or a steel plate so that the brazing flame cannot influence peripheries.</li> <li>■ Be careful so as not to burn the compressor terminals, the name plate, the heat exchanger fin.</li> </ul>

# 5. Outdoor Unit - RXL35G2V1B

## 5.1 Removal of Outer Panels

**Procedure**

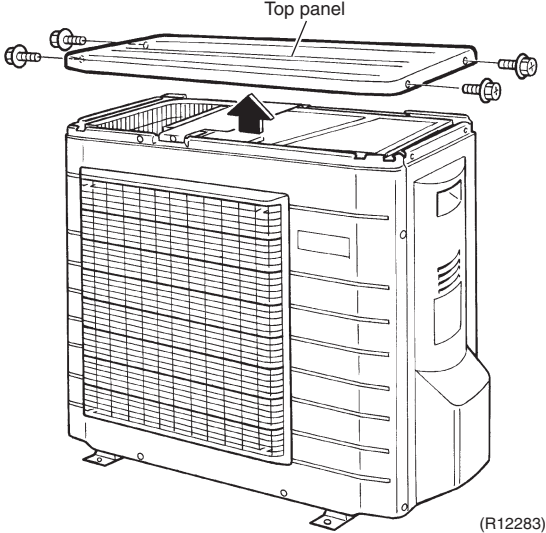
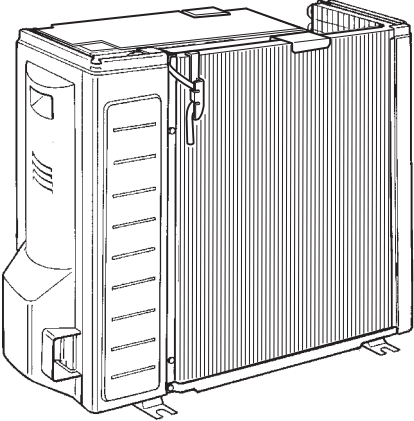
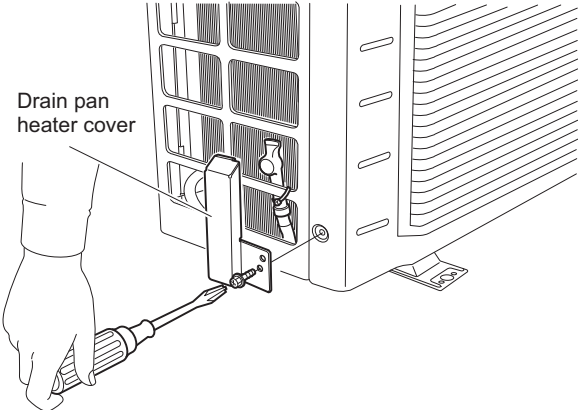

**Warning** Be sure to wait for 10 minutes or more after turning off all power supplies before disassembling work.

Step	Procedure	Points
<p>1. Remove the panels.</p> <p>1 Remove the 4 screws and lift the top panel.</p> <p>2 Remove the screw and remove the drain pan heater cover.</p>	 <p style="text-align: center;">(R12283)</p>  <p style="text-align: center;">(R12290)</p>  <p style="text-align: center;">(R9375)</p>	<ul style="list-style-type: none"> <li>■ Take care not to cut your finger by the fins of the outdoor heat exchanger.</li> </ul>

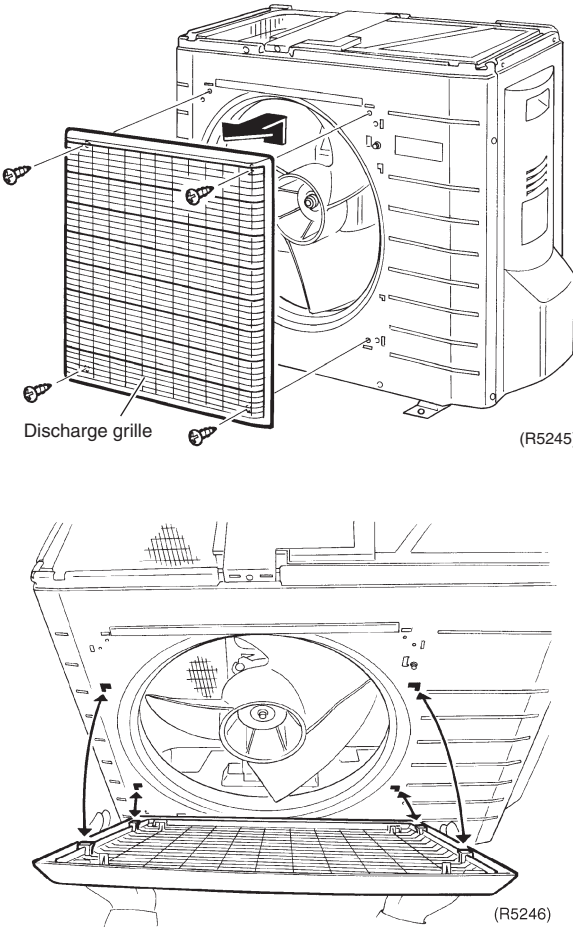
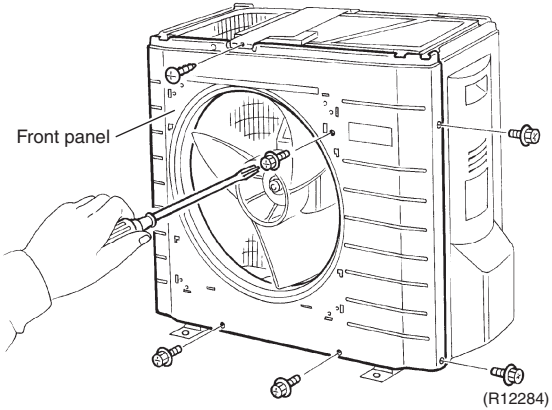
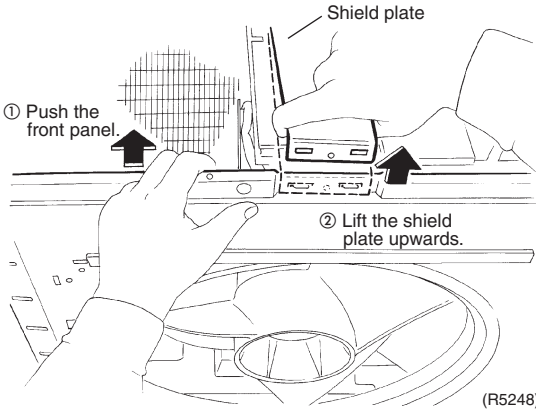
Step	Procedure	Points
3	Remove the 4 screws and remove the discharge grille.	<ul style="list-style-type: none"> <li>■ Slide the discharge grille upwards and remove it.</li> </ul>
	 <p>Discharge grille (R5245)</p> <p>(R5246)</p>	<ul style="list-style-type: none"> <li>■ The discharge grille has 4 hooks.</li> </ul>
4	Remove the 6 screws of the front panel.	
	 <p>Front panel (R12284)</p>	
5	Push the front panel and lift the shield plate to unfasten the hooks.	
	 <p>Shield plate (R5248)</p> <p>① Push the front panel.</p> <p>② Lift the shield plate upwards.</p>	

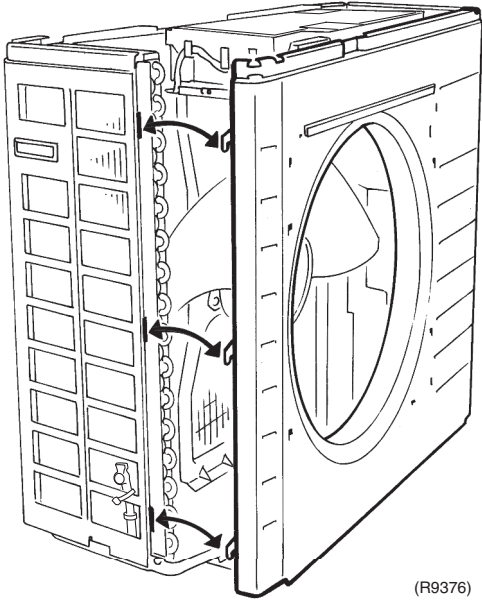
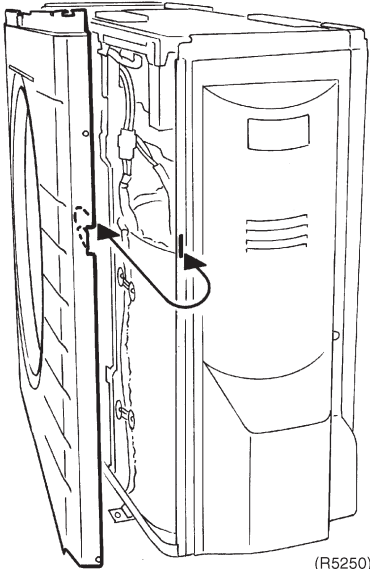
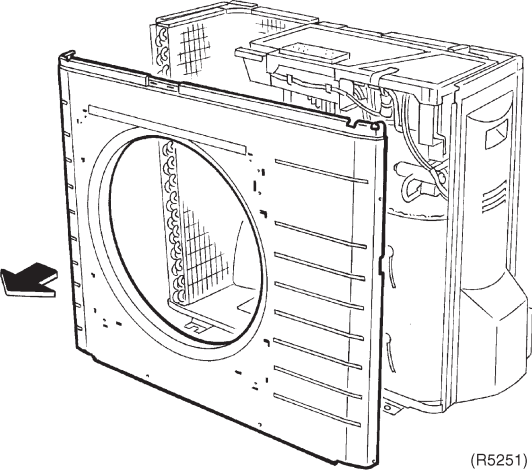

Step	Procedure	Points
<p>6</p>	<p>Unfasten the left side hooks, and then the right side hook. Remove the front panel.</p>  <p>(R9376)</p>  <p>(R5250)</p>  <p>(R5251)</p>	<ul style="list-style-type: none"> <li>■ Lift the front panel while pushing the left side panel inwards.</li>   <li>■ Lift the front panel and unfasten the right side hook.</li>   <li>■ When reassembling, fit the right side of the front panel first.</li> </ul>

Step	Procedure	Points
2.	Remove the stop valve cover.	
1	Remove the screw of the stop valve cover.	
2	Pull down the stop valve cover to unfasten the hooks and remove it.	<p>■ The stop valve cover has 6 hooks.</p>

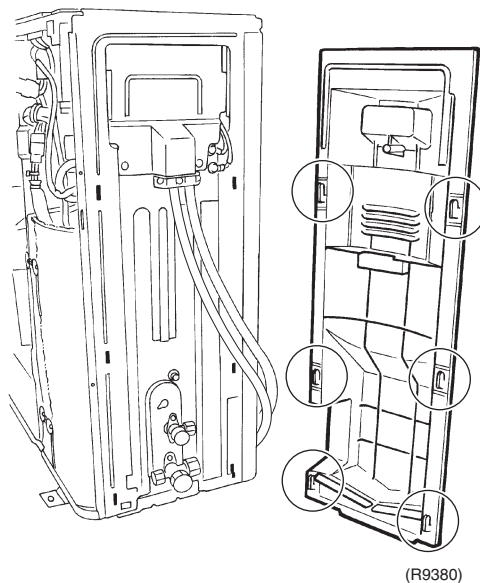
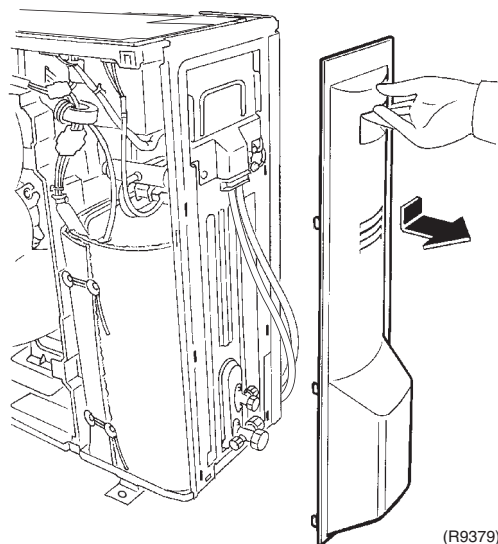
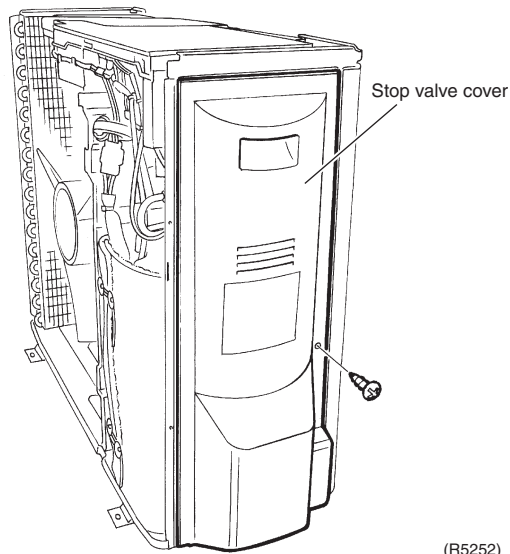

## 5.2 Removal of Outdoor Fan / Fan Motor

**Procedure**

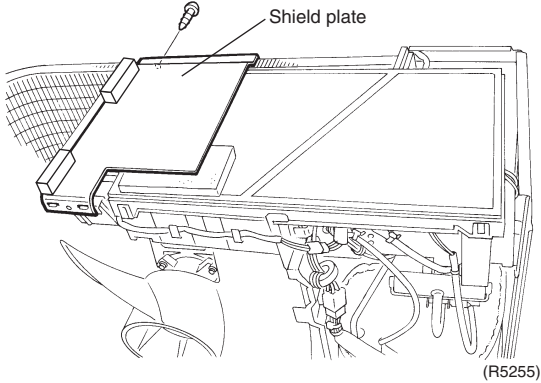
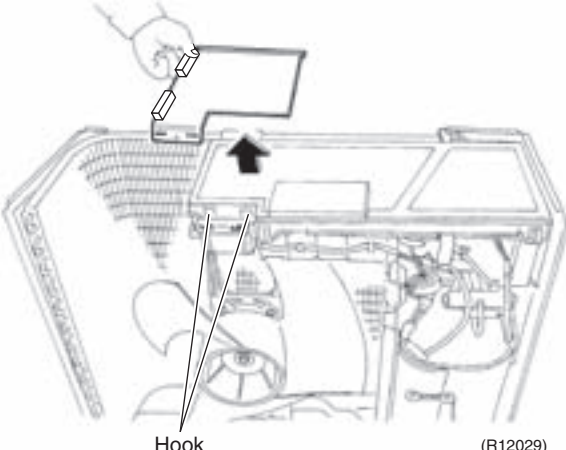
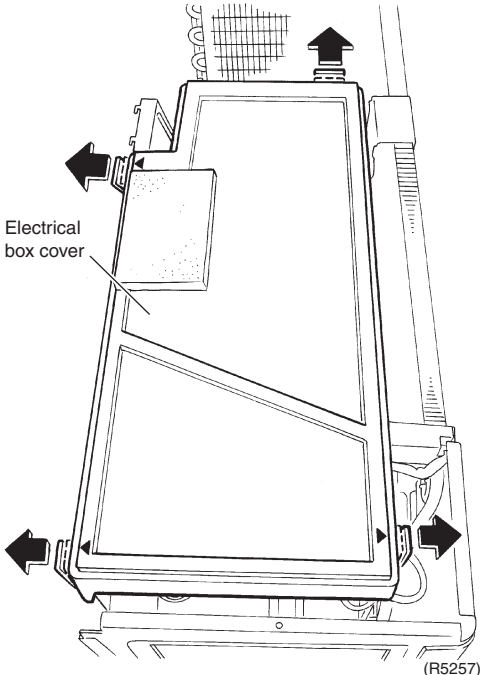

**Warning** Be sure to wait for 10 minutes or more after turning off all power supplies before disassembling work.

Step	Procedure	Points	
1. Remove the electrical box cover.			
1	Remove the screw of the shield plate.	<p><b>Preparation</b></p> <ul style="list-style-type: none"> <li>■ Remove the top panel and the front panel according to the "Removal of Outer Panels".</li> <li>■ This procedure is not necessary to remove the outdoor fan only.</li> </ul>	
2	Unfasten the 2 hooks and remove the shield plate.		 <p style="text-align: right;">(R5255)</p>
3	Unfasten the 4 hooks of the electrical box cover and remove it.		 <p style="text-align: right;">(R12029)</p>
		 <p style="text-align: right;">(R5257)</p>	

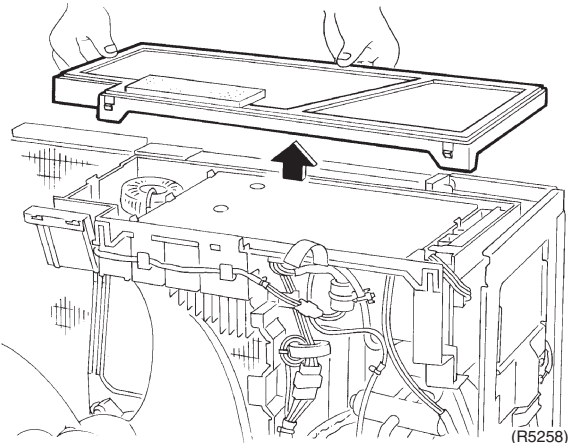
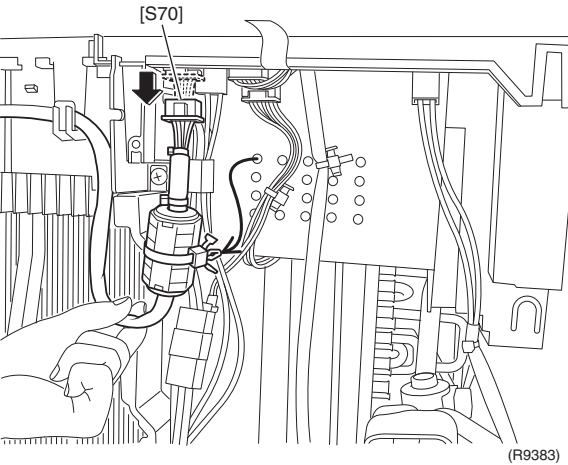
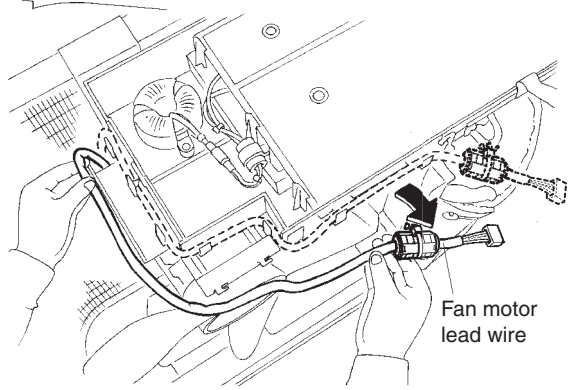
Step	Procedure	Points
		
2. Remove the fan motor.	<p data-bbox="150 779 448 913">1 Detach the clamp and disconnect the connector for the fan motor [S70].</p>  <p data-bbox="150 1317 448 1413">2 Release the fan motor lead wire from the 7 hooks.</p> 	

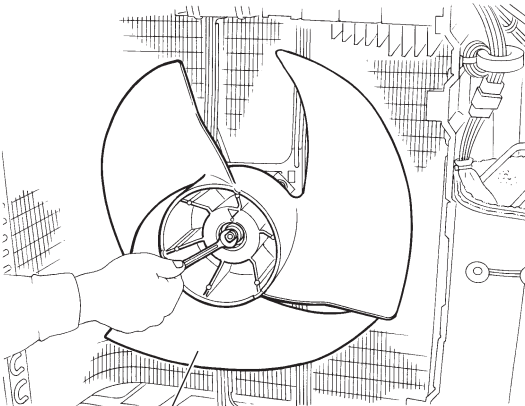
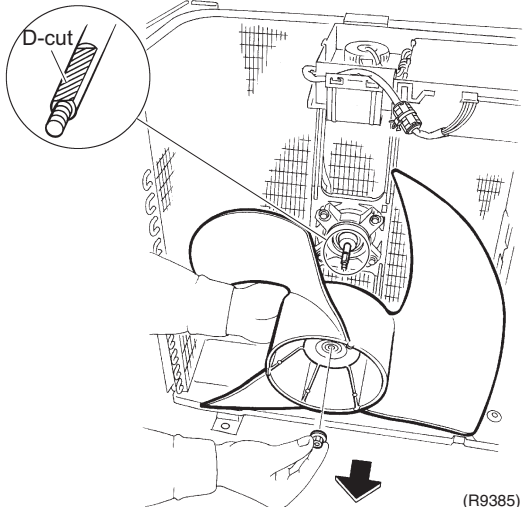
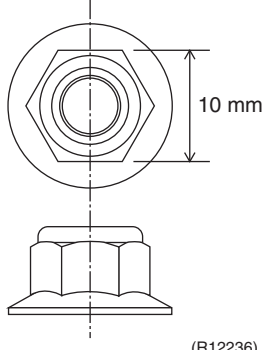
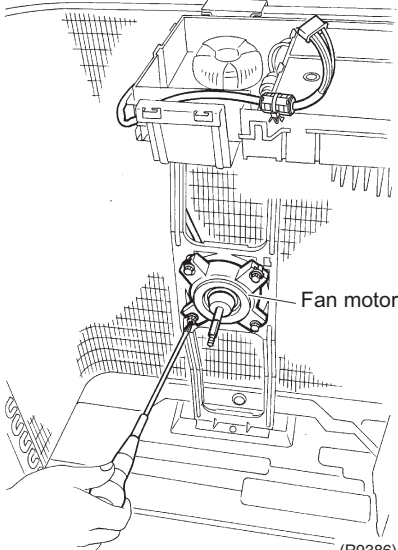
Step	Procedure	Procedure	Points
3	Remove the washer-fitted nut of the outdoor fan.	 <p>Outdoor fan (R5262)</p>  <p>(R9385)</p>	<ul style="list-style-type: none"> <li>■ The screw has reverse winding.</li> <li>■ Nut size: M6</li> </ul>  <p>(R12236)</p> <ul style="list-style-type: none"> <li>■ When reassembling, align ▼ mark of the outdoor fan with D-cut section of the motor shaft.</li> </ul>
4	Remove the lower 2 screws from the fan motor first.	 <p>Fan motor (R9386)</p>	<ul style="list-style-type: none"> <li>■ Be sure to remove the lower screws first. If the upper screws are removed first, the fan motor, the center of gravity of which is toward the front, may tilt down or fall, getting you injured.</li> </ul>
5	Then, remove the upper 2 screws.		

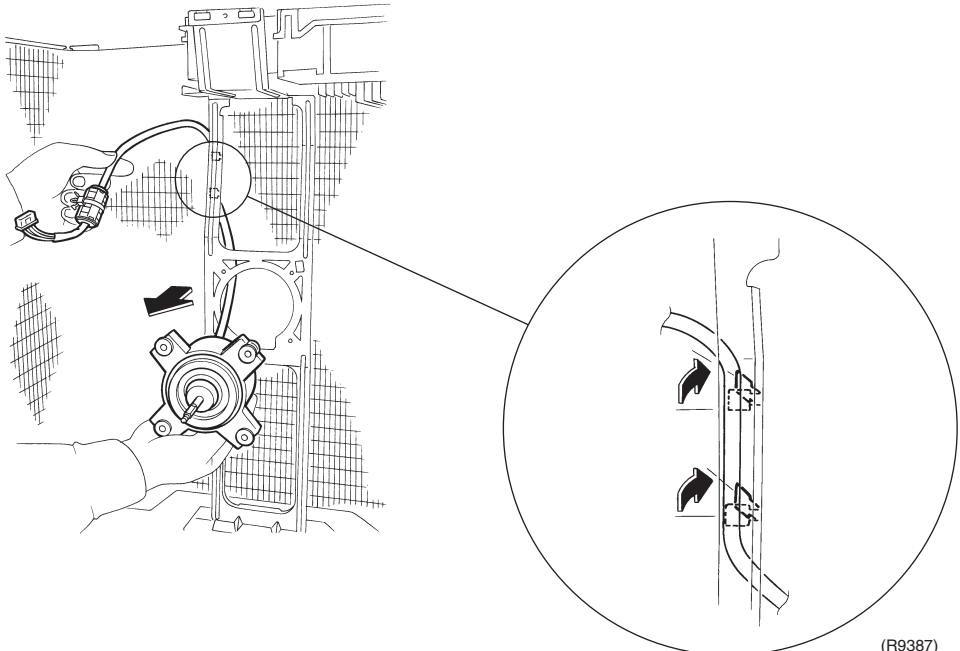
Step	Procedure	Points
6	<p data-bbox="199 219 454 340">Release the fan motor lead wire from the 2 hooks and pull the fan motor out.</p>  <p data-bbox="1374 1055 1433 1077">(R9387)</p>	<ul data-bbox="1088 219 1458 376" style="list-style-type: none"><li>■ When reassembling, put the fan motor lead wire through the back of the fan motor (so as not to be entangled with the outdoor fan).</li></ul>

### 5.3 Removal of Electrical Box

**Procedure**

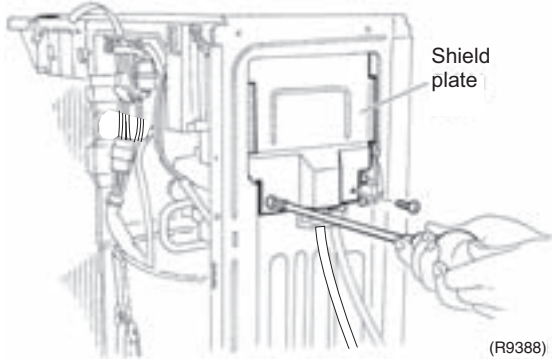
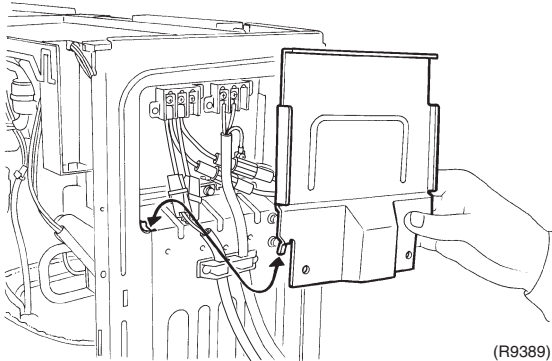
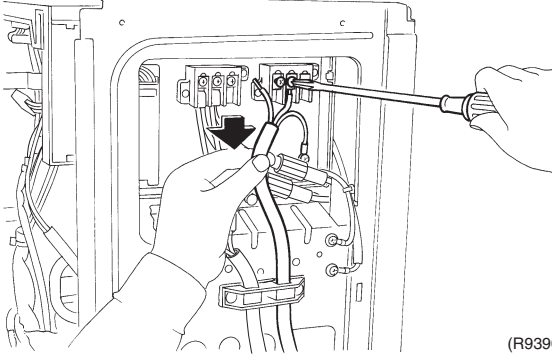

**Warning** Be sure to wait for 10 minutes or more after turning off all power supplies before disassembling work.

Step	Procedure	Procedure	Points
1	Remove the 2 screws of the shield plate.	 <p style="text-align: right;">(R9388)</p>	<p><b>Preparation</b></p> <ul style="list-style-type: none"> <li>■ Remove the top panel and the front panel according to the "Removal of Outer Panels".</li> </ul>
2	Slide the shield plate upward to unfasten the 1 hook on the bottom left, and then remove the shield plate.	 <p style="text-align: right;">(R9389)</p>	
3	Disconnect the 2 power supply cables and the 1 earth wire.	 <p style="text-align: right;">(R9390)</p>	

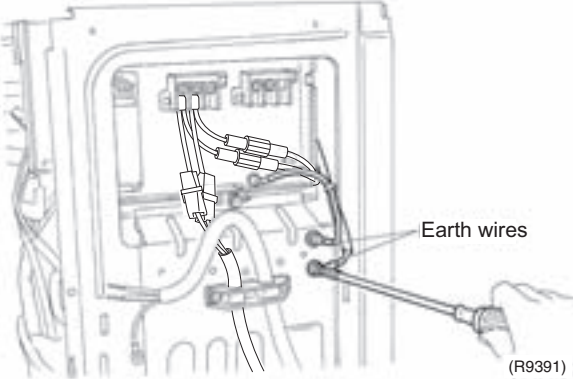
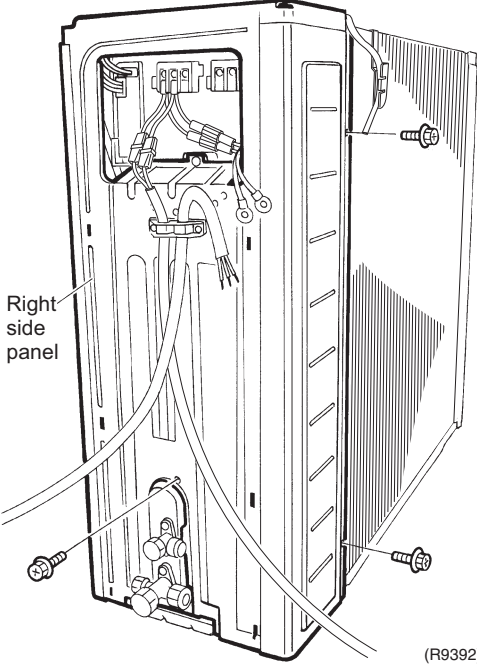
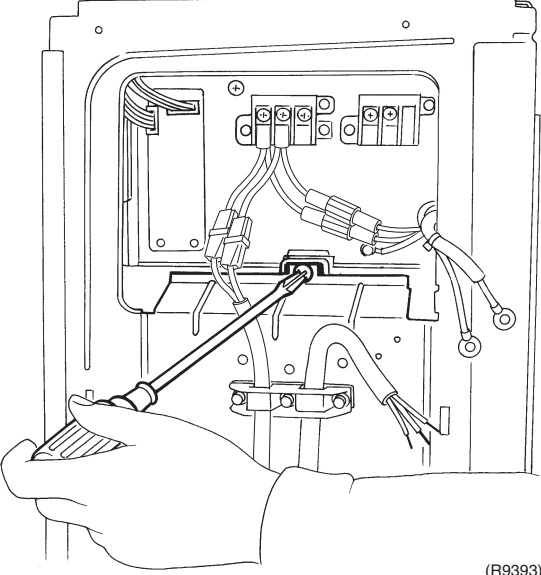
Step	Procedure	Points
4	Disconnect the 2 earth wires.  <p style="text-align: right;">(R9391)</p>	
5	Remove the 3 screws of the right side panel.  <p style="text-align: right;">(R9392)</p>	
6	Remove the screw of the electrical box.  <p style="text-align: right;">(R9393)</p>	

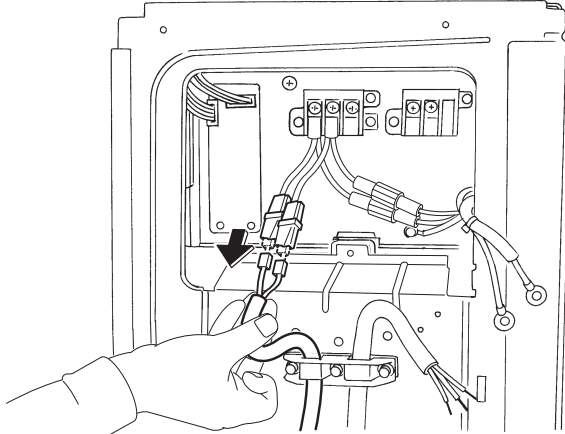
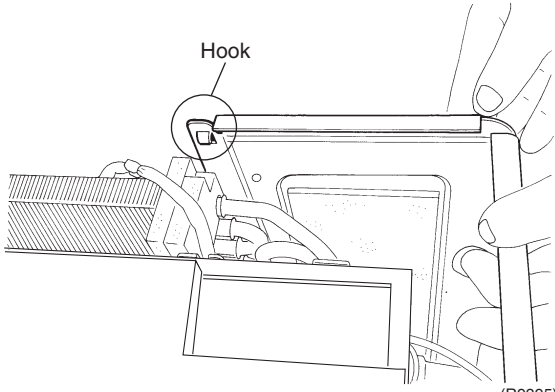
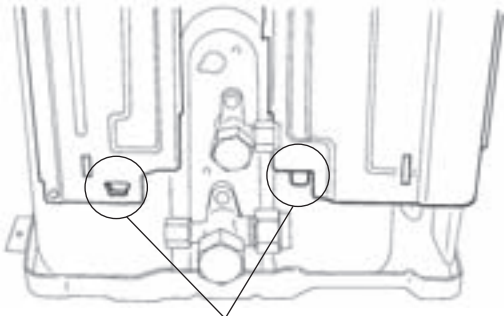
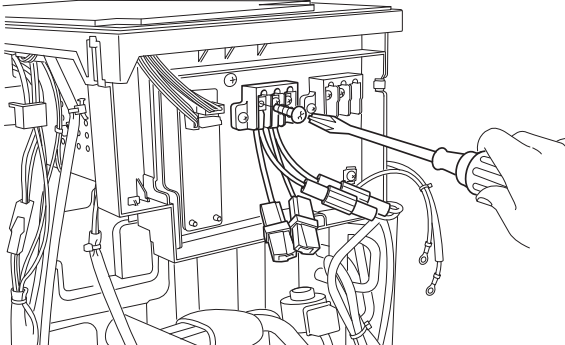

Step	Procedure	Points
7	<p>Disconnect the 2 relay connectors of the drain pan heater.</p>  <p>(R9394)</p>	
8	<p>Unfasten the hooks and remove the right side panel.</p>  <p>(R9395)</p>  <p>(R5273)</p>	<p>■ When reassembling, insert the 2 hooks of the lower part and the 1 hook of the upper back.</p>
9	<p>Remove the screws of the drain pan heater harness.</p>  <p>(R9396)</p>	

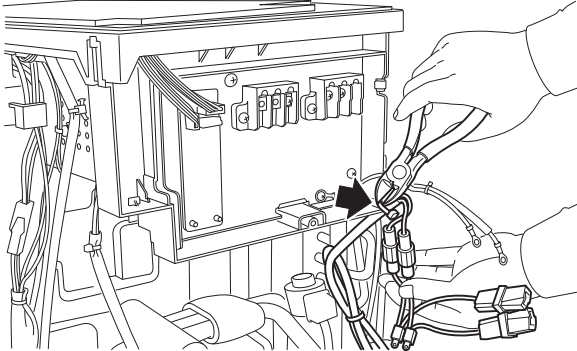
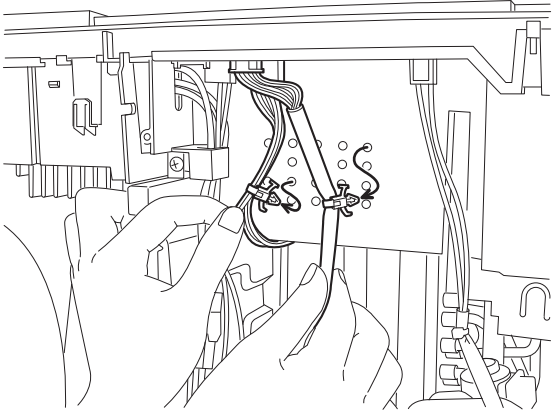
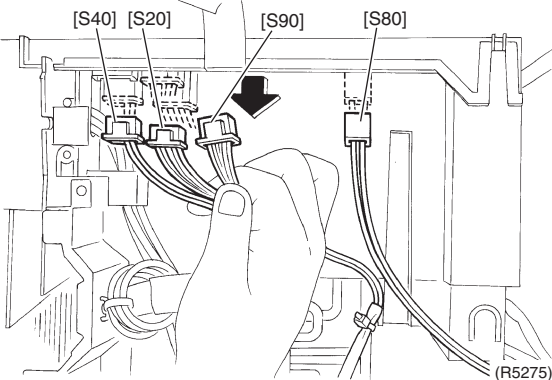
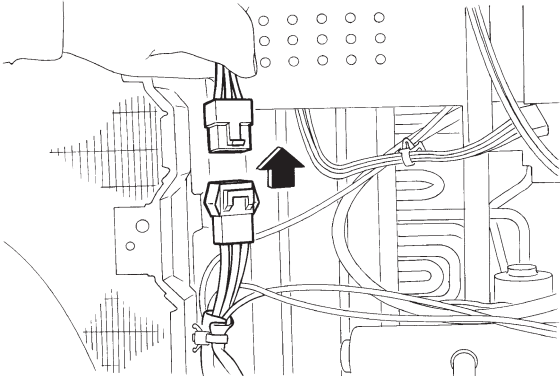
Step	Procedure	Points
10	<p>Cut the clamp.</p>  <p>(R9397)</p>	
11	<p>Detach the 2 wire clamps.</p>  <p>(R9398)</p>	
12	<p>Disconnect the connectors of the front side.</p> <p>[S20]: electronic expansion valve coil  [S40]: overload protector  [S80]: four way valve coil  [S90]: thermistors</p>  <p>(R5275)</p>	
13	<p>Disconnect the relay connector for the compressor.</p>  <p>(R5276)</p>	

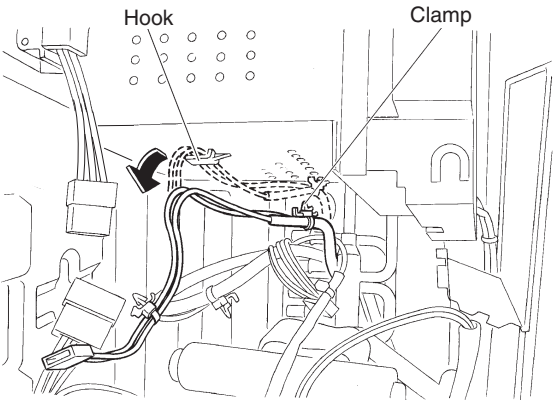
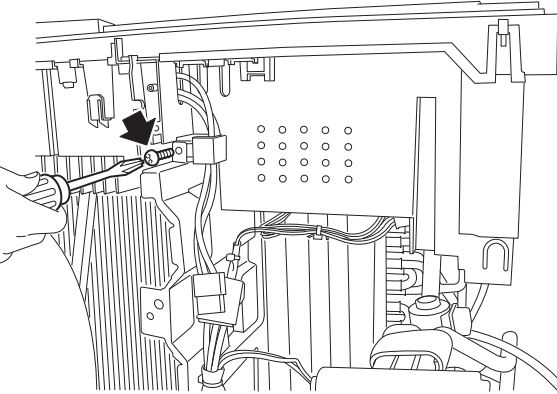
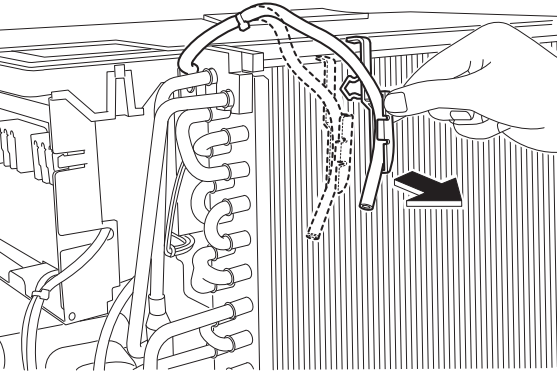
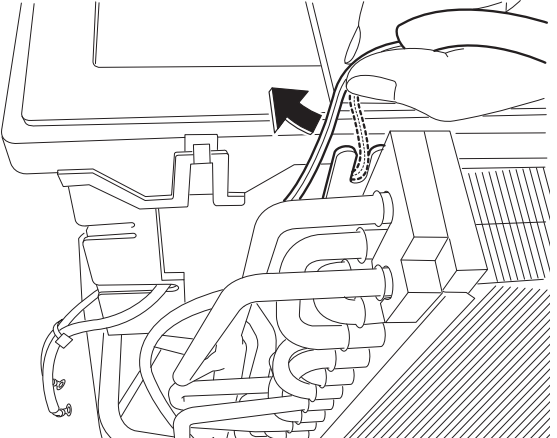
Step	Procedure	Points
14	Detach the clamp and release the thermistor lead wires from the hook.	
	 <p style="text-align: right;">(R9400)</p>	
15	Remove the screw.	
	 <p style="text-align: right;">(R9401)</p>	
16	Release the outdoor temperature thermistor.	
	 <p style="text-align: right;">(R9402)</p>	
17	Release the harness of the outdoor temperature thermistor from the hook.	
	 <p style="text-align: right;">(R9403)</p>	

Step	Procedure	Points
18	Lift and remove the electrical box.	

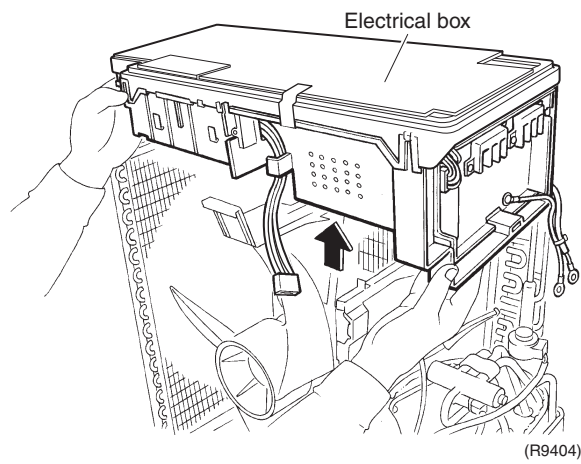

## 5.4 Removal of PCB

**Procedure**

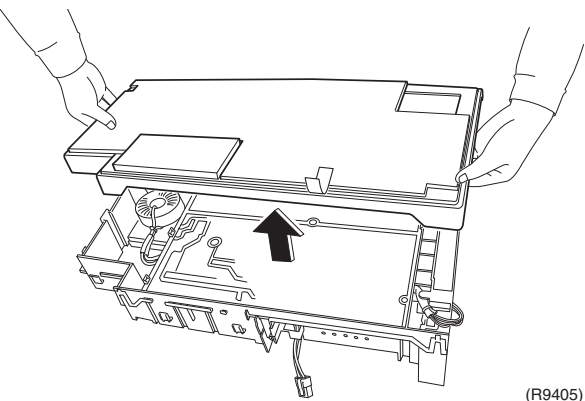
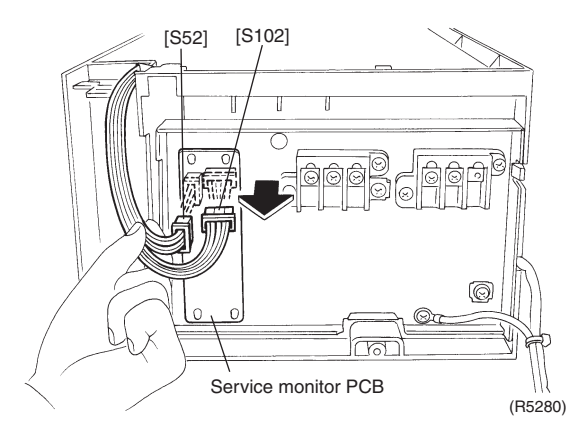
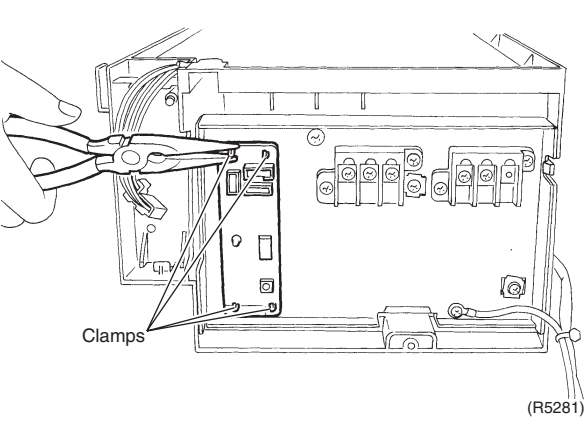
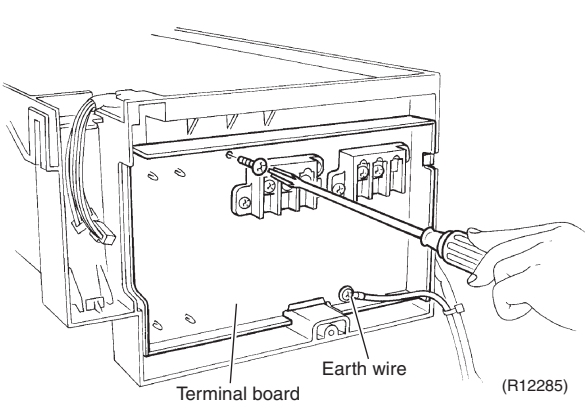

**Warning** Be sure to wait for 10 minutes or more after turning off all power supplies before disassembling work.

Step	Procedure	Procedure	Points
1	Remove the cover of the electrical box.	 <p>(R9405)</p>	<p><b>Preparation</b></p> <ul style="list-style-type: none"> <li>Remove the electrical box according to the "Removal of Electrical Box".</li> </ul>
2	Disconnect the connectors from the service monitor PCB [S52] [S102].	 <p>(R5280)</p>	
3	Detach the 4 clamps with pliers.	 <p>(R5281)</p>	
4	Remove the screws of the terminal board and the earth wire.	 <p>(R12285)</p>	

Step	Procedure	Points
5	Unfasten the hook on the right.	
6	Open the terminal board.	
7	Disconnect the harnesses.	1: Black 2: White 3: Red L1: Black L2: Brown N1: White N2: Blue
8	Disconnect the 2 connectors for the reactor [HR1] [HR2].	

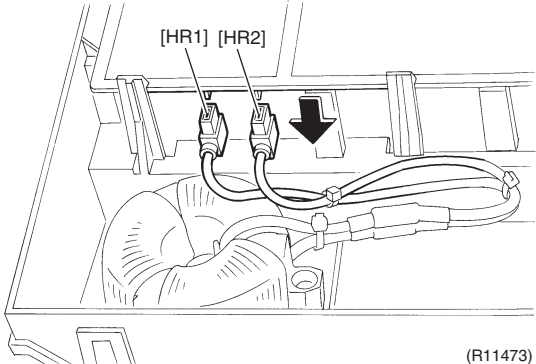
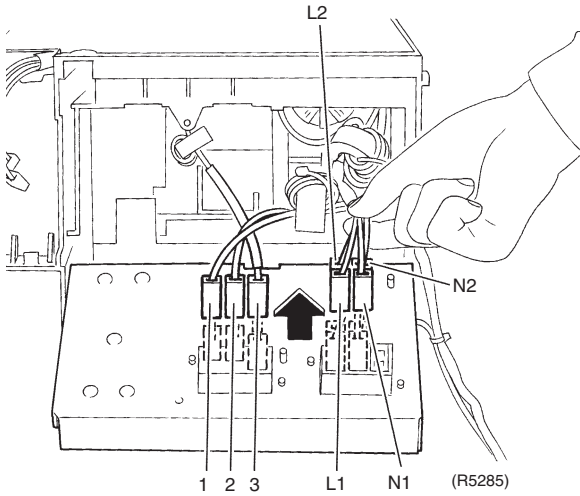
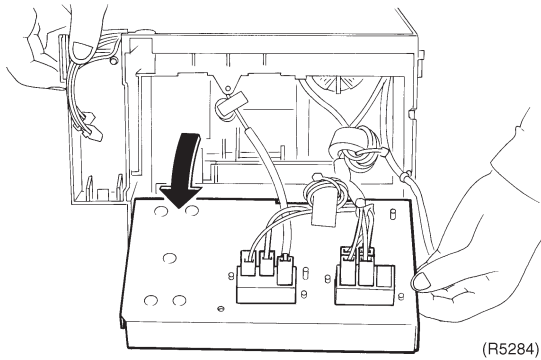
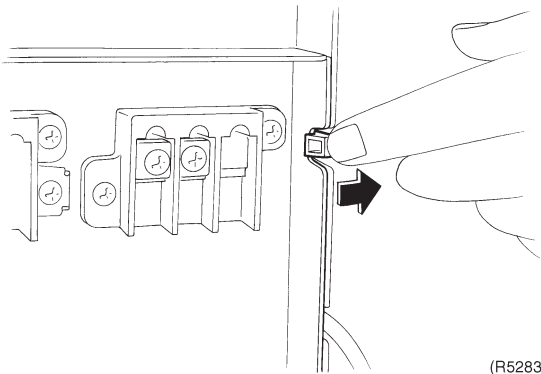

Step	Procedure	Points
9	Remove the 3 screws of the main PCB.	
10	Unfasten the 4 hooks.	
11	Lift up and remove the main PCB.	■ Refer to page 18 for detail.

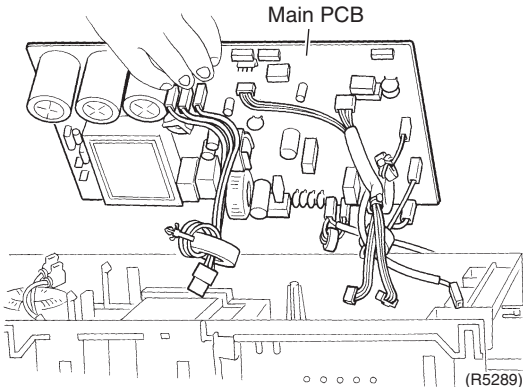
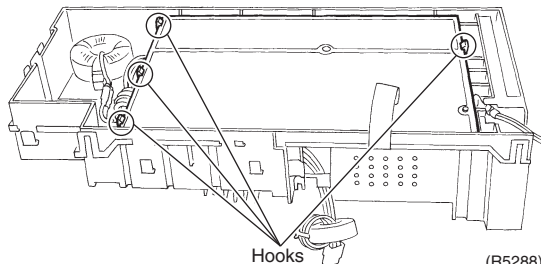
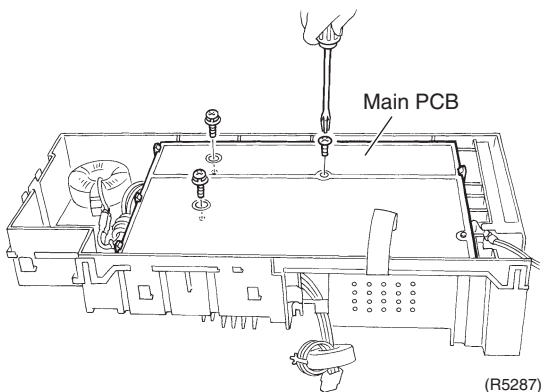

## 5.5 Removal of Drain Pan Heater

### Procedure

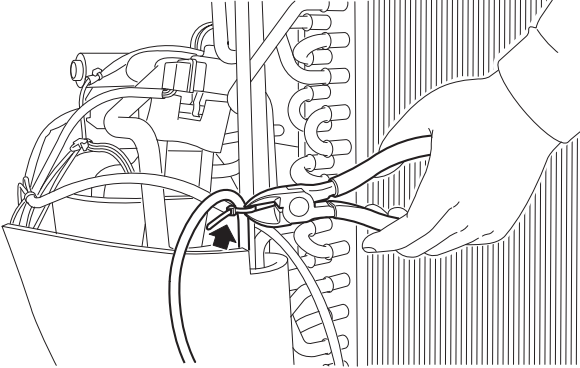
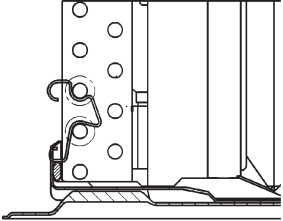
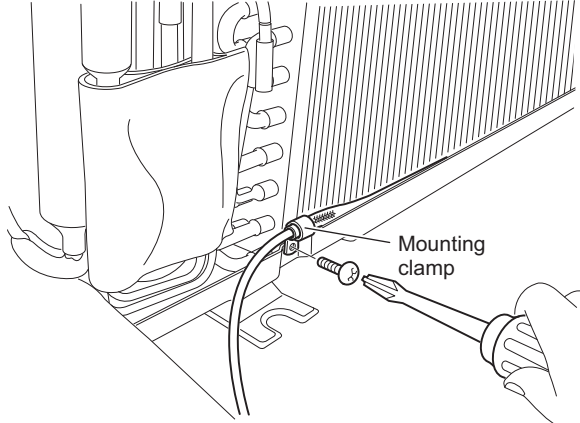
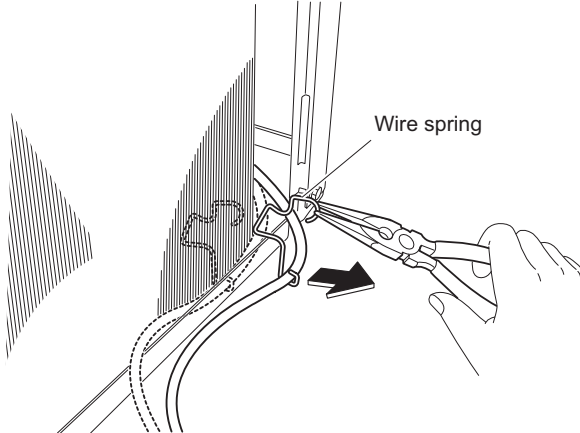

**Warning** Be sure to wait 10 minutes or more after turning off all power supplies before disassembling work.

Step	Procedure	Points
1.	Remove the drain pan heater.	
1	Cut the clamp.	
	 <p style="text-align: right;">(R9406)</p>	
2	Remove the screw of the mounting clamp.	
3	Release the drain pan heater ASSY from the ditch between the bottom frame and the outdoor heat exchanger ASSY. Remove the wire spring with long nose pliers.	<ul style="list-style-type: none"> <li>■ Take care not to cut your finger by the fins of the outdoor heat exchanger.</li> <li>■ When reassembling, hang the wire spring to the hair pin cooling tube.</li> </ul>  <p style="text-align: right;">(R9748)</p>
	 <p style="text-align: right;">(R9407)</p>  <p style="text-align: right;">(R9351)</p>	



Step	Procedure	Points
4	Cut the clamp.	
5	Remove the 3 screws and remove the left side panel.	
6	The fuses are inside the drain pan heater.	

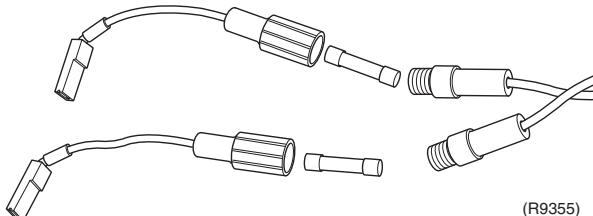
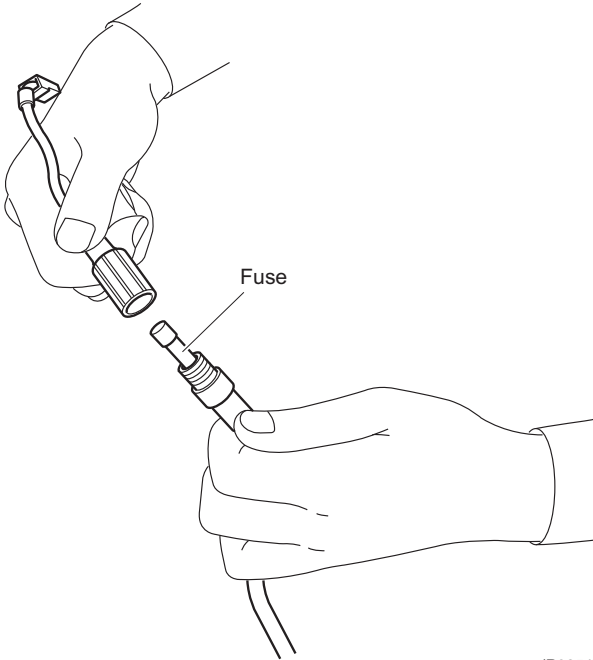
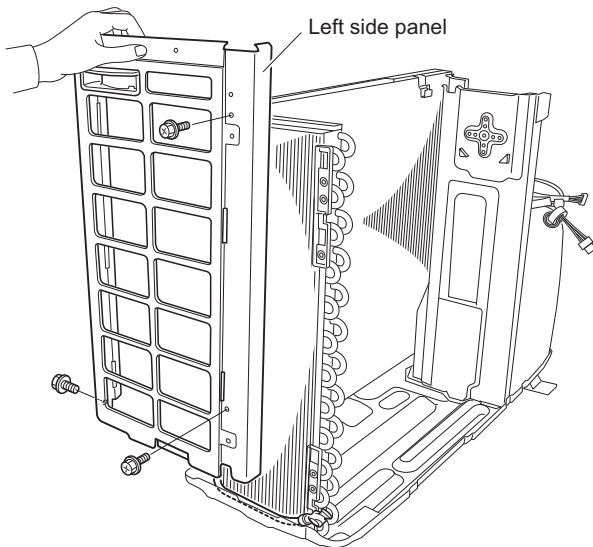
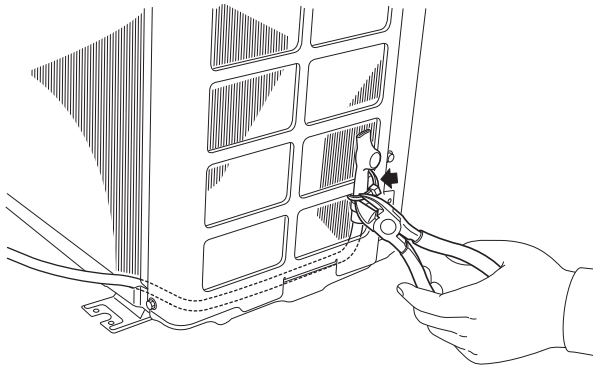

## 5.6 Removal of Sound Blanket / Thermistors

### Procedure

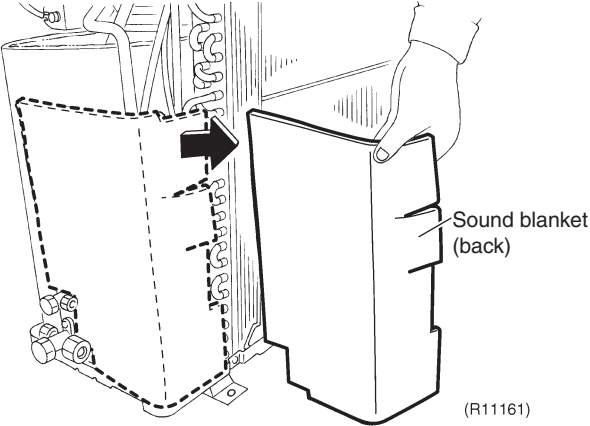
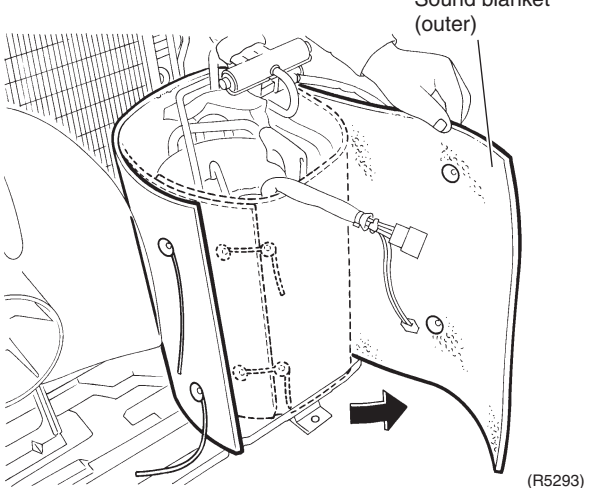
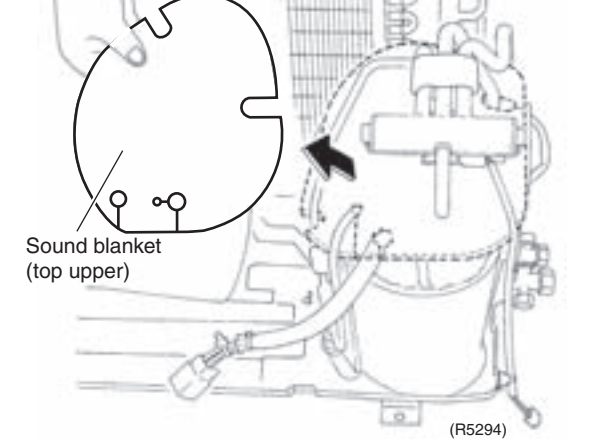

**Warning** Be sure to wait for 10 minutes or more after turning off all power supplies before disassembling work.

Step	Procedure	Procedure	Points
1	Remove the sound blanket (back).	 <p>(R11161)</p>	
2	Remove the sound blanket (outer).	 <p>(R5293)</p>	<ul style="list-style-type: none"> <li>Since the piping ports are torn easily, remove the sound blanket carefully.</li> </ul>
3	Remove the sound blanket (top upper).	 <p>(R5294)</p>	

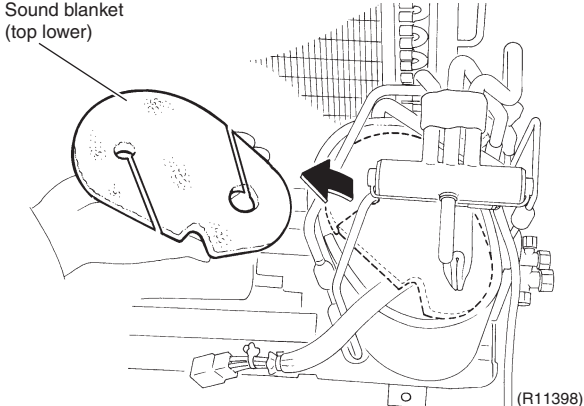
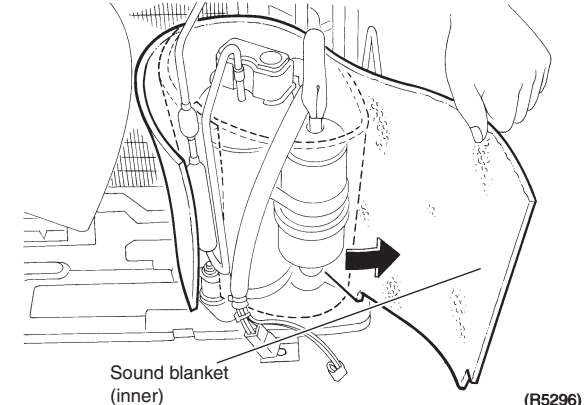
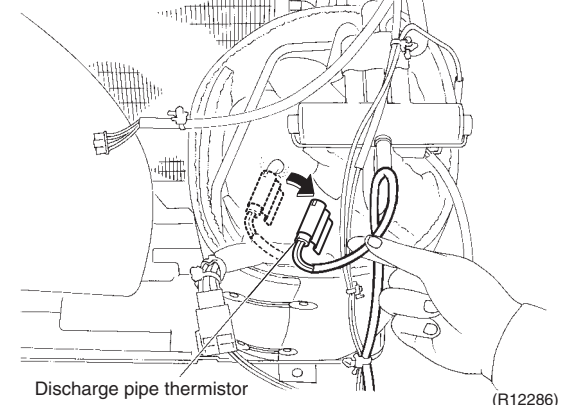
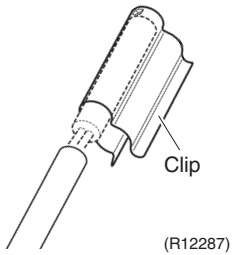
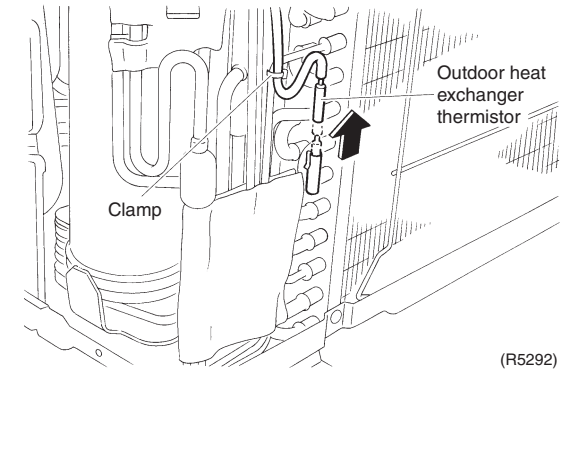
Step	Procedure	Points
4	<p>Remove the sound blanket (top lower).</p> 	
5	<p>Remove the sound blanket (inner).</p> 	
6	<p>Release the discharge pipe thermistor.</p> 	<p>■ Be careful not to lose the clip for the thermistor.</p> 
7	<p>Cut the clamp and pull out the outdoor heat exchanger thermistor.</p> 	

## 5.7 Removal of Four Way Valve

### Procedure

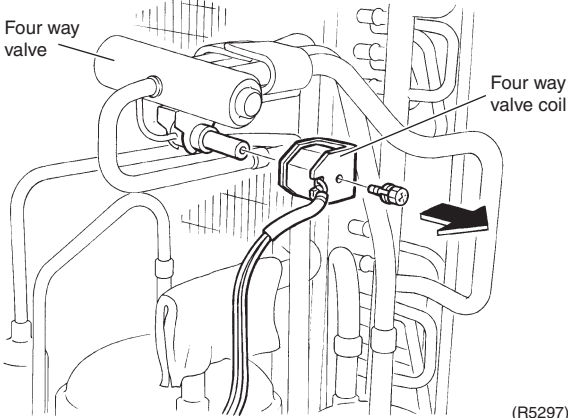
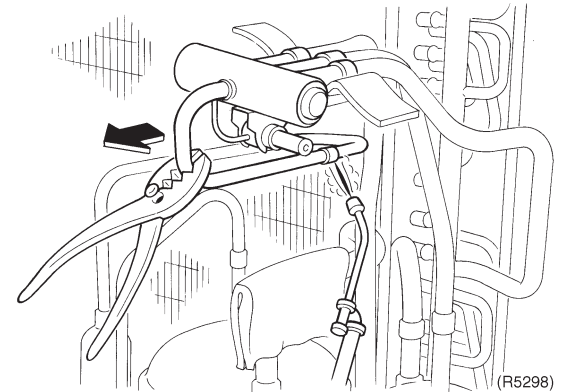
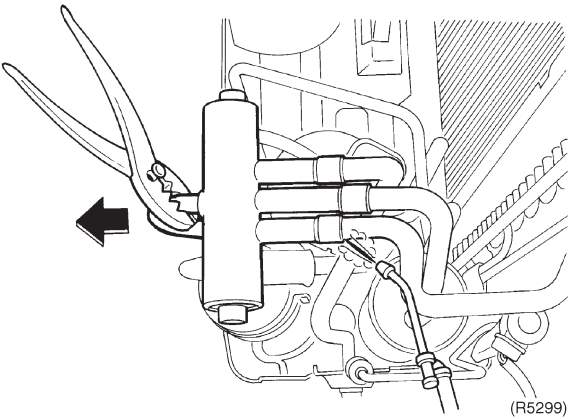

**Warning** Be sure to wait 10 minutes or more after turning off all power supplies before disassembling work.

Step	Procedure	Points
1	<p>Remove the screw and remove the four way valve coil.</p>  <p>(R5297)</p>	<p><b>Warning</b> Be careful not to get yourself burnt with the pipes and other parts that are heated by the gas brazing machine.</p> <p><b>Warning</b> If the refrigerant gas leaks during work, ventilate the room. (If the refrigerant gas is exposed to flames, toxic gas may be generated.)</p> <p><b>Caution</b> From the viewpoint of global environment protection, do not discharge the refrigerant gas in the atmosphere. Make sure to collect all the refrigerant gas.</p>
<ul style="list-style-type: none"> <li>■ Before working, make sure that the refrigerant gas is empty in the circuit.</li> <li>■ Be sure to apply nitrogen replacement when heating up the brazed part.</li> </ul>	 <p>(R5298)</p>	<p><b>Cautions for restoration</b></p> <ol style="list-style-type: none"> <li>1. Restore the piping by non-oxidation brazing.</li> <li>2. It is required to prevent the carbonization of the oil inside the four way valve and the deterioration of the gaskets affected by heat. (Keep below 120°C.) For the sake of this, wrap the four way valve with wet cloth and provide water so that the cloth does not dry.</li> </ol>
2	<p>Heat up the brazed part of the four way valve and disconnect.</p>  <p>(R5299)</p>	<p><b>Note:</b></p> <ul style="list-style-type: none"> <li>■ Do not use a metal saw for cutting pipes by all means because the sawdust comes into the circuit.</li> <li>■ When withdrawing the pipes, be careful not to pinch them firmly with pliers. The pipes may get deformed.</li> <li>■ Provide a protective sheet or a steel plate so that the brazing flame cannot influence peripheries.</li> </ul>
3	<p>Heat up every brazed part in turn and disconnect.</p>	

## 5.8 Removal of Electronic Expansion Valve

**Procedure**

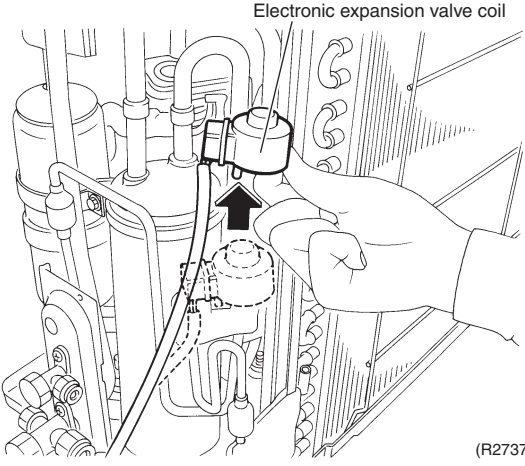
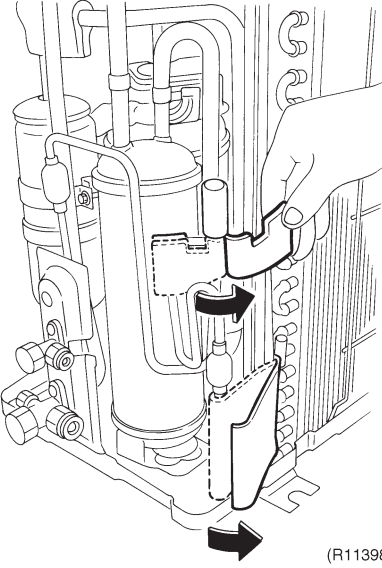
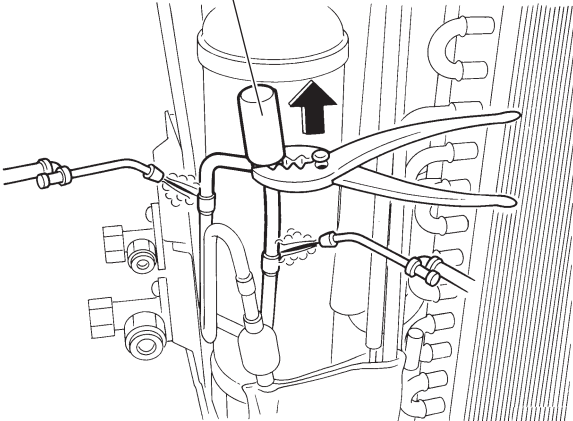

**Warning** Be sure to wait for 10 minutes or more after turning off all power supplies before disassembling work.

Step	Procedure	Procedure	Points
1	Pull out the electronic expansion valve coil.	 <p style="text-align: right;">(R2737)</p>	
2	Remove the sheets of putty.	 <p style="text-align: right;">(R11398)</p>	
<ul style="list-style-type: none"> <li>■ Before working, make sure that the refrigerant gas is empty in the circuit.</li> <li>■ Be sure to apply nitrogen replacement when heating up the brazed part.</li> </ul>		 <p style="text-align: right;">(R2739)</p>	<p><b>Warning</b> Be careful not to get yourself burnt with the pipes and other parts that are heated by the gas brazing machine.</p>
3	Heat up the 2 brazed parts of the electronic expansion valve and remove it.		<p><b>Warning</b> If the refrigerant gas leaks during work, ventilate the room. (If the refrigerant gas is exposed to flames, toxic gas may be generated.)</p> <p><b>Caution</b> From the viewpoint of global environment protection, do not discharge the refrigerant gas in the atmosphere. Make sure to collect all the refrigerant gas.</p>

## 5.9 Removal of Compressor

### Procedure



**Warning** Be sure to wait for 10 minutes or more after turning off all power supplies before disassembling work.

Step	Procedure	Procedure	Points
1	Remove the terminal cover.	<p>(R5301)</p> <p>(R5302)</p>	
2	Disconnect the lead wires of the compressor.	<p>(R12204)</p>	

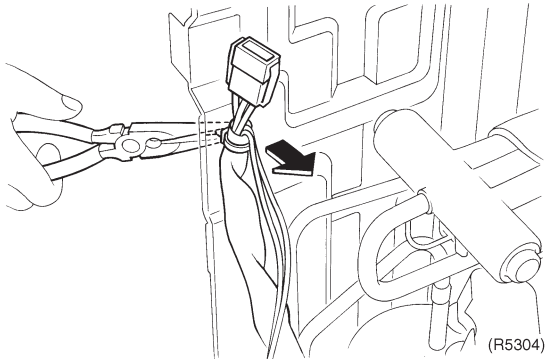
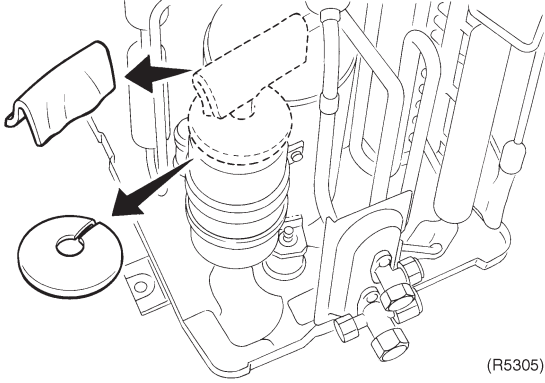
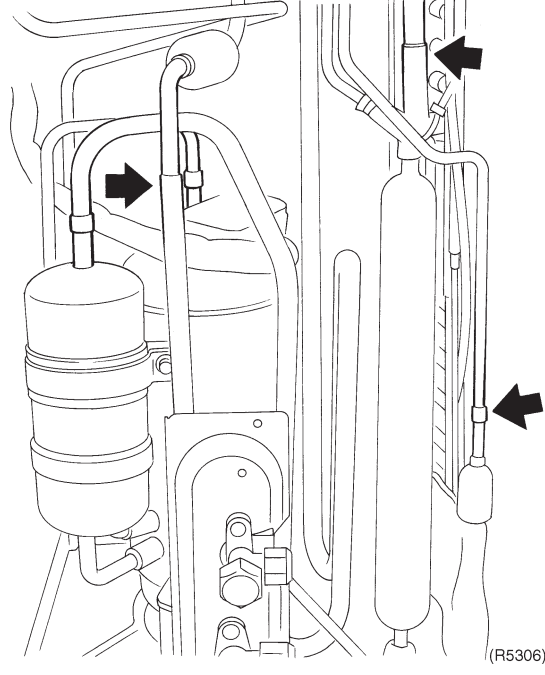
Step	Procedure	Points
3	<p>Release the clamp with pliers to detach the compressor lead wires.</p>  <p>(R5304)</p>	
4	<p>Remove the putty.</p>  <p>(R5305)</p>	
5	<p>Heat up the brazed parts indicated by the arrows.</p>  <p>(R5306)</p>	<p><b>Warning</b> Be careful not to get yourself burnt with the pipes and other parts that are heated by the gas brazing machine.</p> <p><b>Warning</b> If the refrigerant gas leaks during work, ventilate the room. (If the refrigerant gas is exposed to flames, toxic gas may be generated.)</p> <p><b>Warning</b> Since it may happen that the refrigerant oil in the compressor catches fire, prepare wet cloth so as to extinguish fire immediately.</p> <p><b>Caution</b> From the viewpoint of global environment protection, do not discharge the refrigerant gas in the atmosphere. Make sure to collect all the refrigerant gas.</p>
<ul style="list-style-type: none"> <li>■ Before working, make sure that the refrigerant gas is empty in the circuit.</li> <li>■ Be sure to apply nitrogen replacement when heating up the brazed part.</li> </ul>		

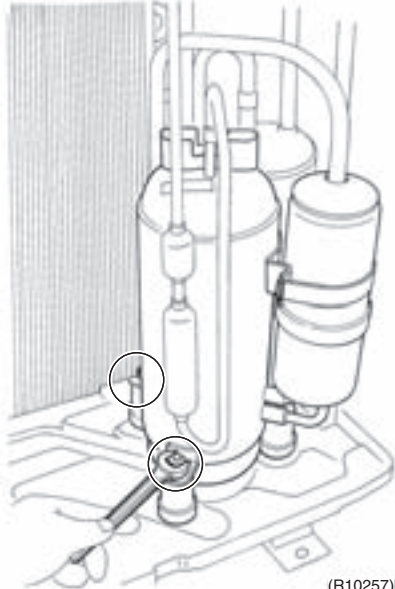
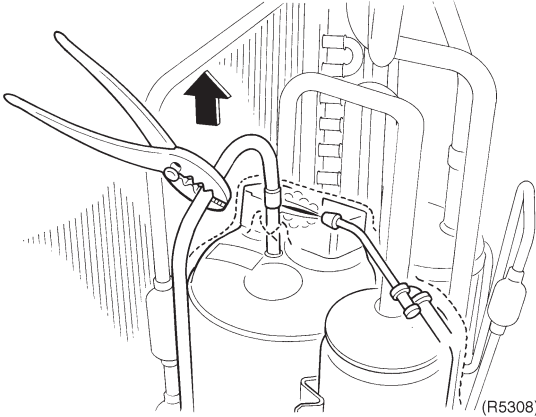
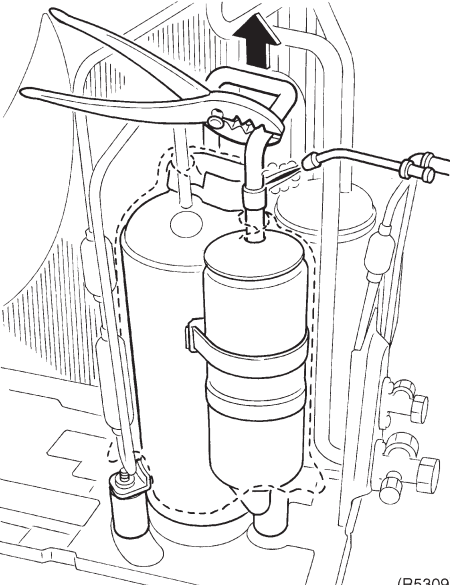
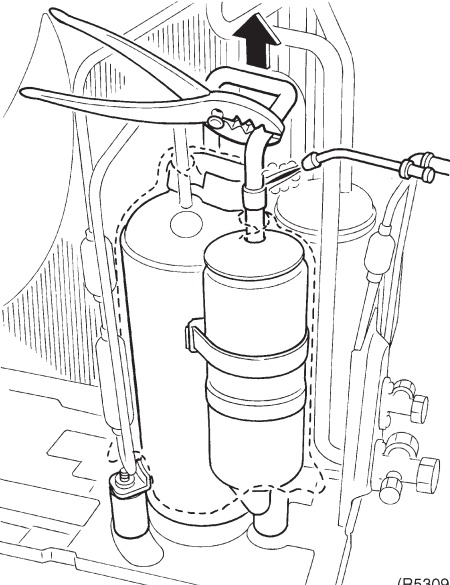
Step	Procedure	Procedure	Points
6	Remove the 2 nuts of the compressor.	 <p>(R10257)</p>	<p><b>Cautions for restoration</b></p> <ol style="list-style-type: none"> <li>1. Restore the piping by non-oxidation brazing.</li> <li>2. It is required to prevent the carbonization of the oil inside the four way valve and the deterioration of the gaskets affected by heat. (Keep below 120°C.) For the sake of this, wrap the four way valve with wet cloth and provide water so that the cloth does not dry.</li> </ol> <p><b>In case of difficulty with gas brazing machine</b></p> <ol style="list-style-type: none"> <li>1. Disconnect the brazed part where is easy to disconnect and restore.</li> <li>2. Cut pipes on the main unit with a tube cutter in order to make it easy to disconnect.</li> </ol>
7	Heat up the brazed part of the discharge side and disconnect.	 <p>(R5308)</p>	<p><b>Note:</b></p> <ul style="list-style-type: none"> <li>■ Do not use a metal saw for cutting pipes by all means because the sawdust comes into the circuit.</li> <li>■ When withdrawing the pipes, be careful not to pinch them firmly with pliers. The pipes may get deformed.</li> </ul>
8	Heat up the brazed part of the suction side and disconnect.	 <p>(R5309)</p>	<ul style="list-style-type: none"> <li>■ Provide a protective sheet or a steel plate so that the brazing flame cannot influence peripheries.</li> <li>■ Be careful so as not to burn the compressor terminals, the name plate, the heat exchanger fin.</li> </ul>
9	Lift the compressor up and remove it.	 <p>(R5309)</p>	



---

# Part 8

## Trial Operation and Field Settings

1. Trial Operation .....	267
2. Field Settings .....	268
2.1 When 2 Units are Installed in 1 Room.....	268
2.2 Standby Electricity Saving.....	269
2.3 Jumper and Switch Settings.....	270
3. Application of Silicon Grease to a Power Transistor and a Diode Bridge .....	271

# 1. Trial Operation

## Outline

1. Measure the supply voltage and make sure that it falls in the specified range.
2. Trial operation should be carried out in either cooling or heating mode.
3. Carry out the trial operation in accordance with the operation manual to ensure that all functions and parts, such as louver movement, are working properly.
  - The air conditioner requires a small amount of power in its standby mode. If the system is not to be used for some time after installation, shut off the circuit breaker to eliminate unnecessary power consumption.
  - If the circuit breaker trips to shut off the power to the air conditioner, the system backs up the operation mode. The system then restarts operation with the previous mode when the circuit breaker is restored.

In cooling mode, select the lowest programmable temperature; in heating mode, select the highest programmable temperature.

- Trial operation may be disabled in either mode depending on the room temperature.
- After trial operation is complete, set the temperature to a normal level.  
(26°C to 28°C in cooling mode, 20°C to 24°C in heating mode)
- For protection, the system does not start for 3 minutes after it is turned off.

## Detail

### ARC452 Series

- (1) Press the ON / OFF button to turn on the system.
- (2) Press the both of TEMP buttons and the MODE button at the same time.
- (3) Press the MODE button twice.  
(“T” appears on the display to indicate that trial operation is selected.)
- (4) Press the MODE button and select operation mode.
- (5) Trial operation terminates in approx. 30 minutes and switches into normal mode. To quit a trial operation, press the ON / OFF button.

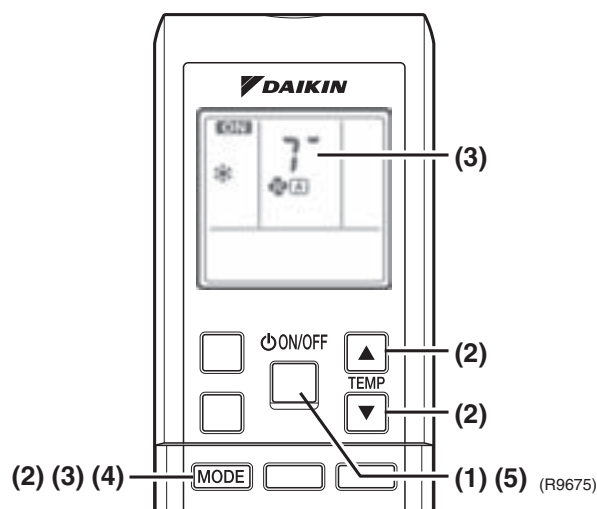

## 2. Field Settings

### 2.1 When 2 Units are Installed in 1 Room

When 2 indoor units are installed in 1 room, 1 of the 2 pairs of indoor unit and infrared remote control can be set for different address.

Both the indoor unit PCB and the infrared remote control need alteration.

#### Indoor Unit PCB

- (1) Remove the front grille. (2 screws)
- (2) Remove the electrical box. (1 screw)
- (3) Remove the shield plate. (4 hooks)
- (4) Cut the address setting jumper JA on the control PCB.

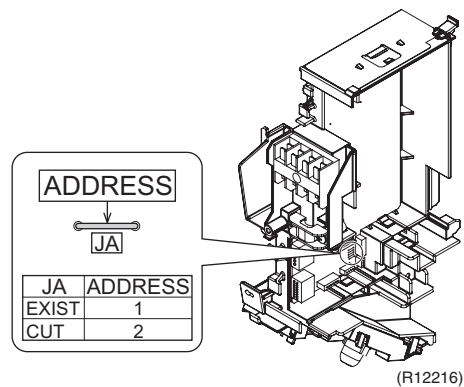

#### Infrared Remote Control

- (1) Remove the cover and take it off.
- (2) Cut the address setting jumper J4.

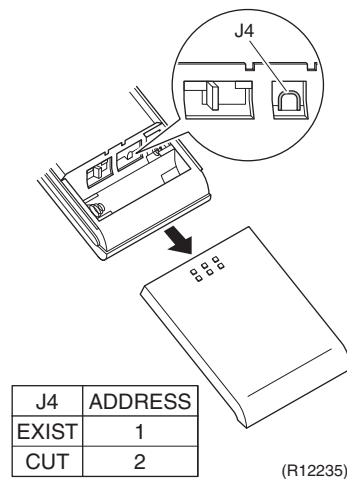

## 2.2 Standby Electricity Saving

### Outline

#### 20/25 Class Only

This function turns power supply OFF to the outdoor unit and sets the indoor unit into energy-saving mode, thus reducing the power consumption of the air conditioner.

### Detail

#### For 20 class models, following procedure is required for turning ON the function.

1. Check that the main power supply is turned OFF. Turn OFF if it has not been turned OFF.
2. Remove the stop valve cover.
3. Disconnect the selective connector for standby electricity saving.
4. Turn ON the main power supply.

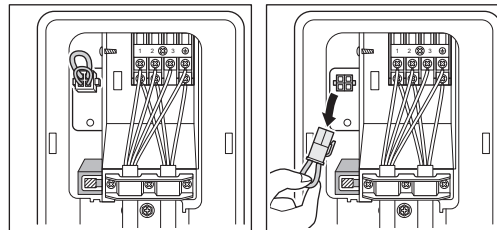

Function OFF

Function ON

The standby electricity saving function is turned OFF before shipping.

(R11820)



### Caution

Before connecting or disconnecting the selective connector for standby electricity saving, make sure that the main power supply is turned OFF.

## 2.3 Jumper and Switch Settings

Jumper	Function	When connected (factory set)	When cut
JB (on indoor unit PCB)	Fan speed setting when compressor stops for thermostat OFF. (effective only at cooling operation)	Fan speed setting ; Remote control setting	Fan rpm is set to "0" <Fan stop>
JC (on indoor unit PCB)	Power failure recovery function	Auto-restart	The unit does not resume operation after recovering from a power failure. Timer ON/OFF settings are cleared.
J5 (on outdoor unit PCB of 20/25 class)	Improvement of defrost performance	Standard control	Reinforced control (ex. The frequency increases, the duration time of defrost lengthens.)



For the location of the jumper, refer to the following pages.

Indoor unit; page 9

Outdoor unit; page 12, 14, 16

Switch	Function	OFF (factory set)	ON
SW4-C (on outdoor unit PCB of 35 class)	Improvement of defrost performance	Standard control	Reinforced control (ex. The frequency increases, the duration time of defrost lengthens.)



For the location of the switch, refer to page 18.

### 3. Application of Silicon Grease to a Power Transistor and a Diode Bridge

#### Applicable Models

All outdoor units using inverter type compressor for room air conditioner.

When the printed circuit board (PCB) of an outdoor unit is replaced, it is required that silicon grease (\*1) is certainly applied to the heat radiation part (the contact point to the radiation fin) of the power transistor and diode bridge.

\*1: Parts number of the silicon grease – 1172698 (Drawing number 3FB03758-1)

#### Details

The silicon grease is an essential article for encouraging the heat radiation of the power transistor and the diode bridge. Applying the paste should be implemented in accordance with the following instruction.

Remark: There is the possibility of failure with smoke in case of bad heat radiation.

- Wipe off the old silicon grease completely on a radiation fin.
- Apply the silicon grease evenly to the whole.
- Do not leave any foreign object such as solder or paper waste between the power transistor and the radiation fin, and also the diode bridge, and the radiation fin.
- Tighten the screws of the power transistor and the diode bridge, and contact to the radiation fin without any gap.

#### <Example>

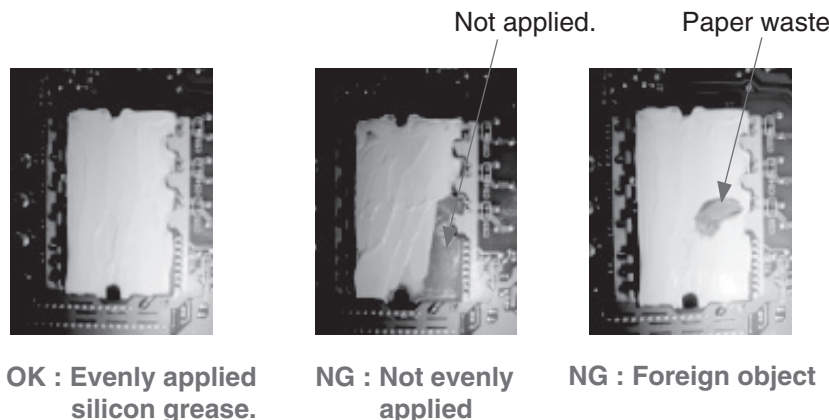
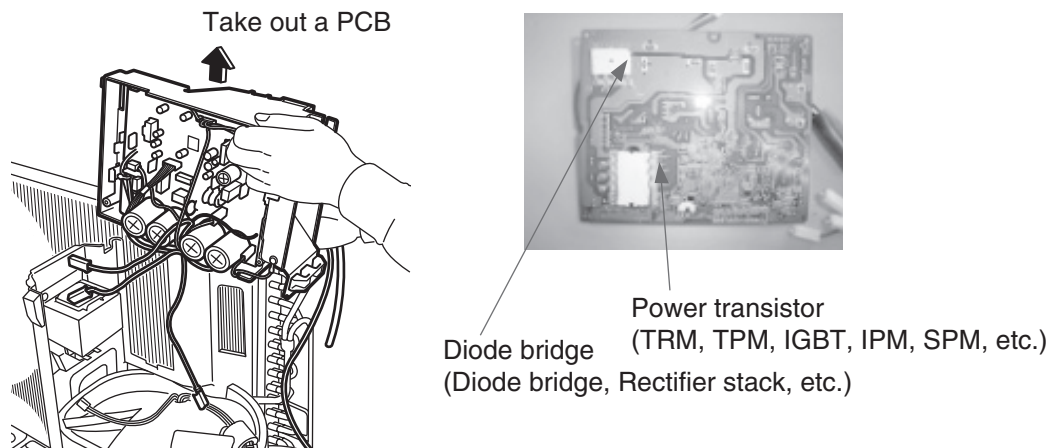

(R9056)

---

# Part 9

# Appendix

1. Piping Diagrams.....	273
1.1 Indoor Unit.....	273
1.2 Outdoor Unit.....	274
2. Wiring Diagrams.....	276
2.1 Indoor Unit.....	276
2.2 Outdoor Unit.....	276

# 1. Piping Diagrams

## 1.1 Indoor Unit

FTXL20/25G2V1B

FTXL35G2V1B

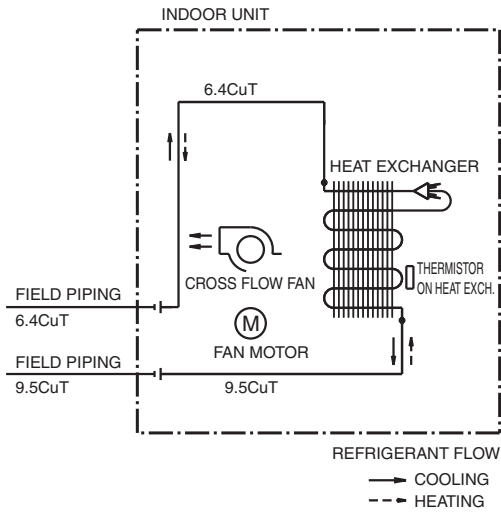

4D058897C

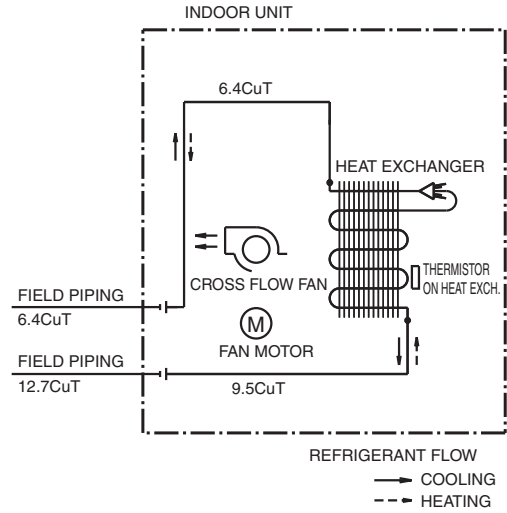

4D058898C



# 1.2 Outdoor Unit

## RXL20G2V1B, RXL20G2V1B9

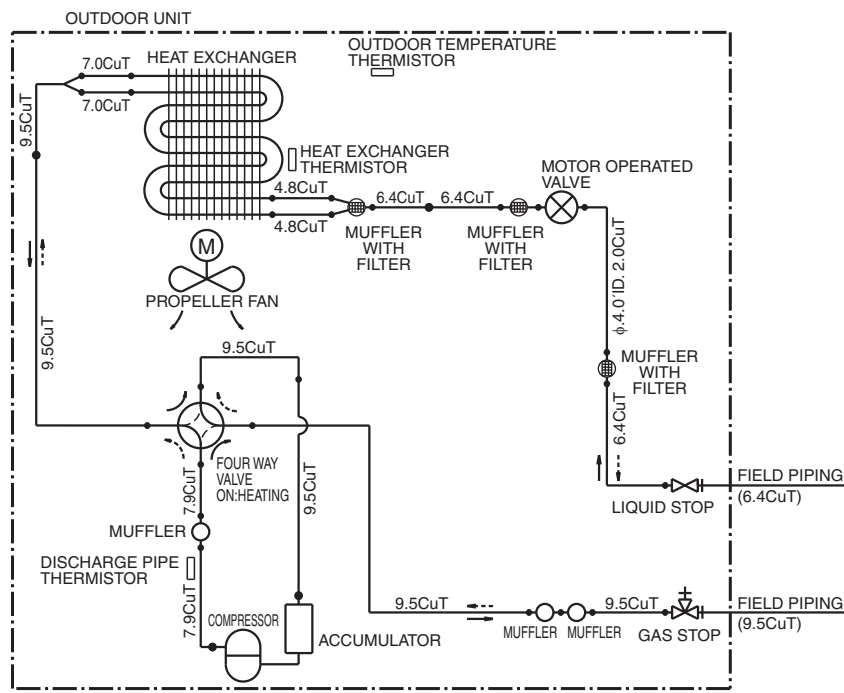

3D059586E

## RXL25G2V1B

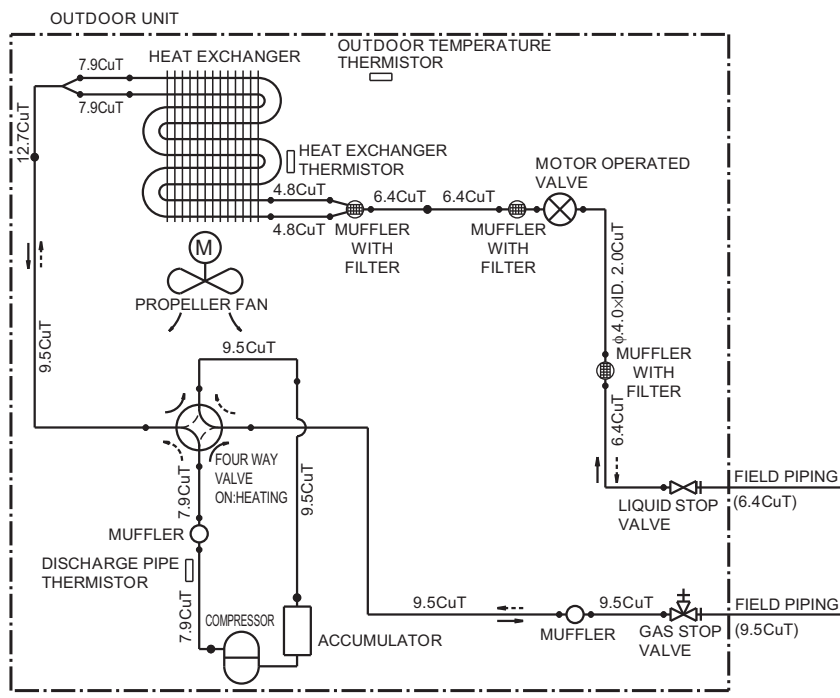

3D059590A

RXL35G2V1B

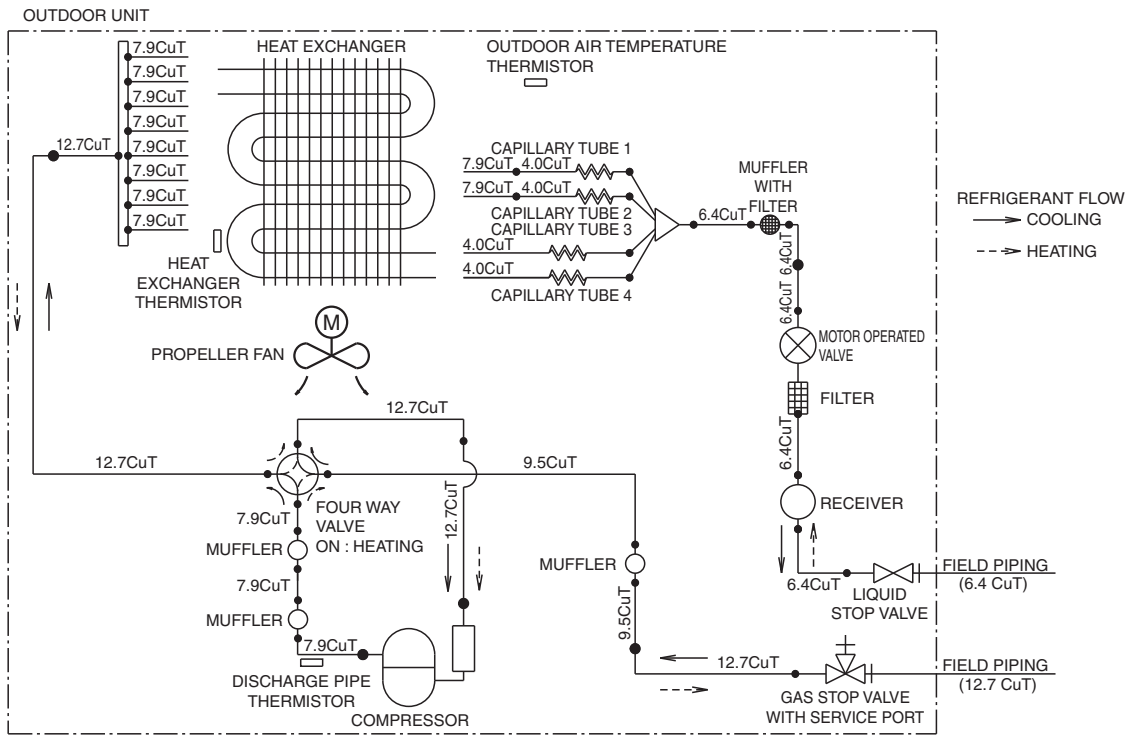

3D051637Q

# 2. Wiring Diagrams

## 2.1 Indoor Unit

### FTXL20/25/35G2V1B

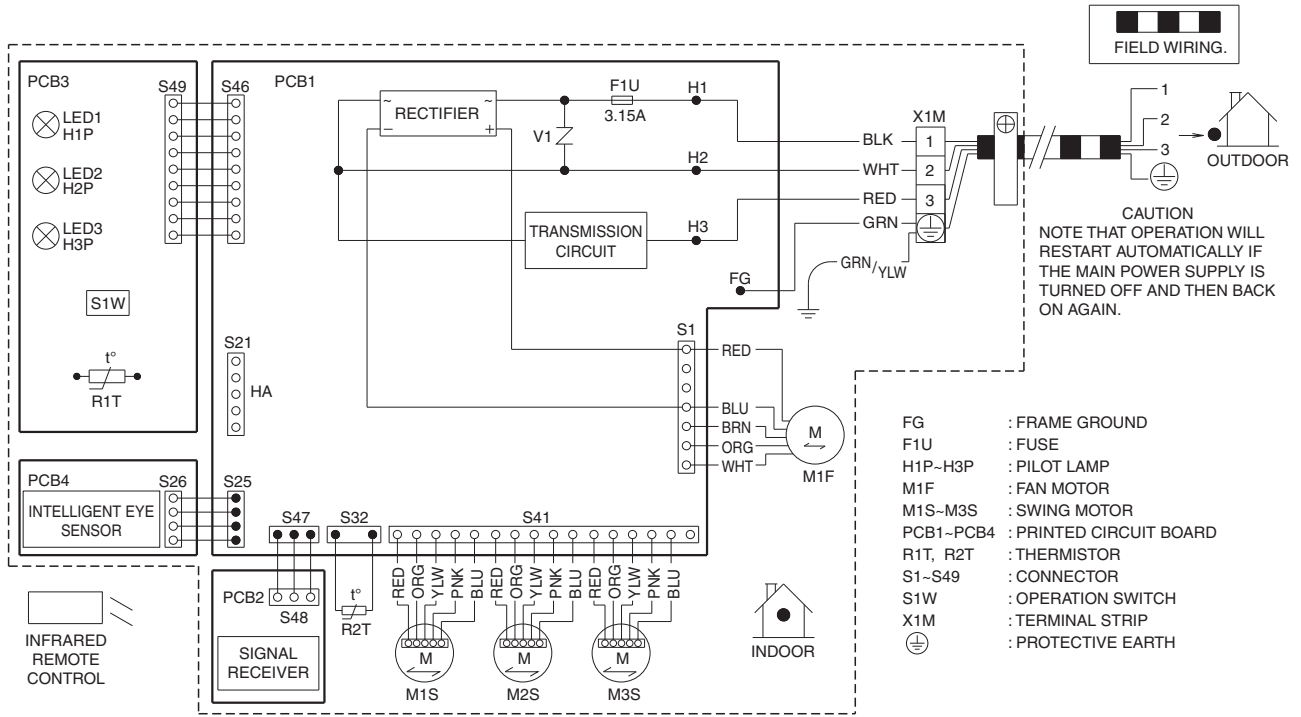

3D058246B

## 2.2 Outdoor Unit

### RXL20G2V1B

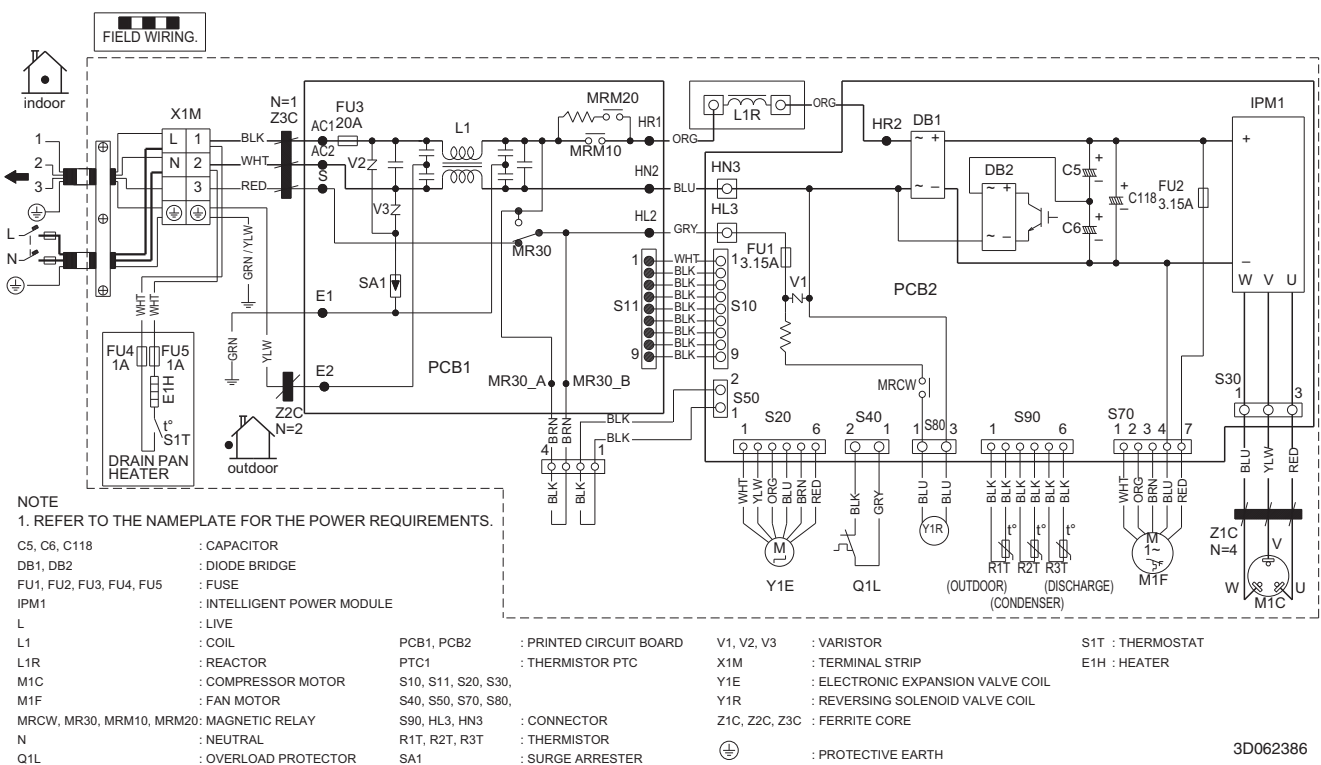

3D062386

RXL20G2V1B9

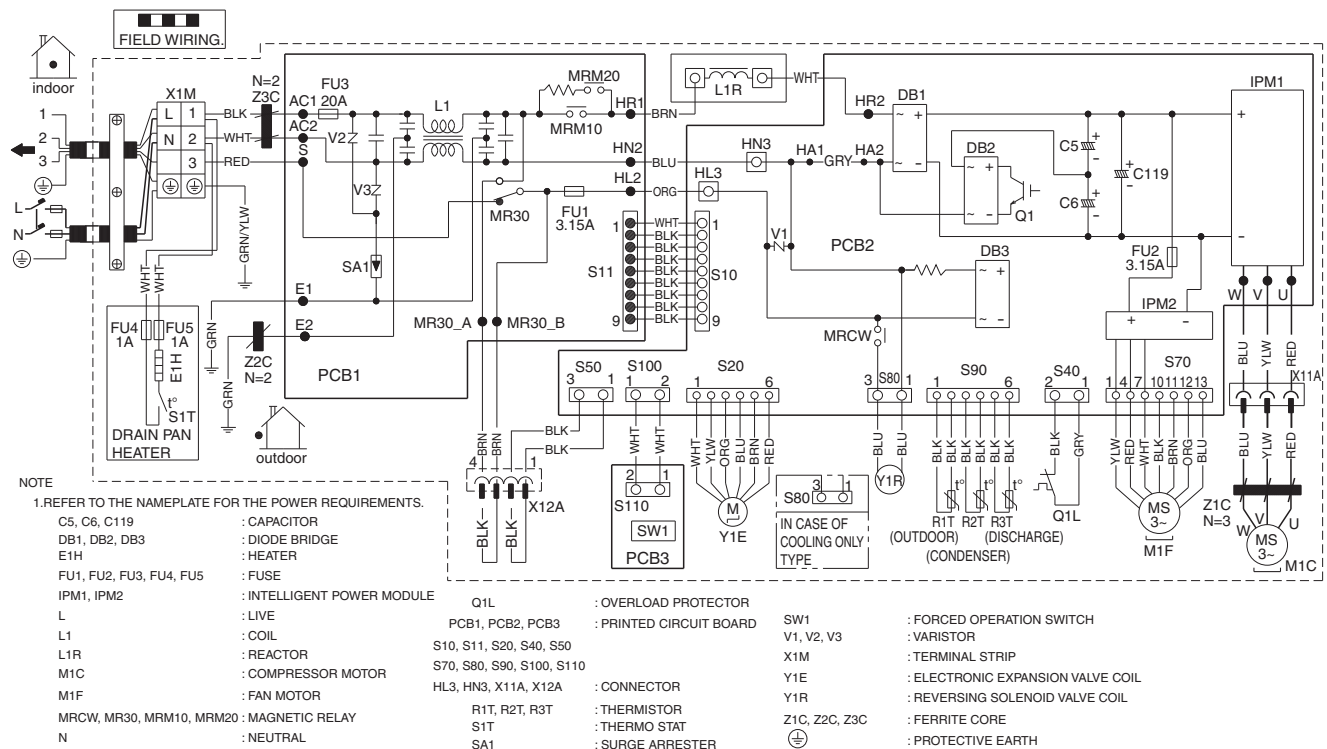

3D065716A

RXL25G2V1B

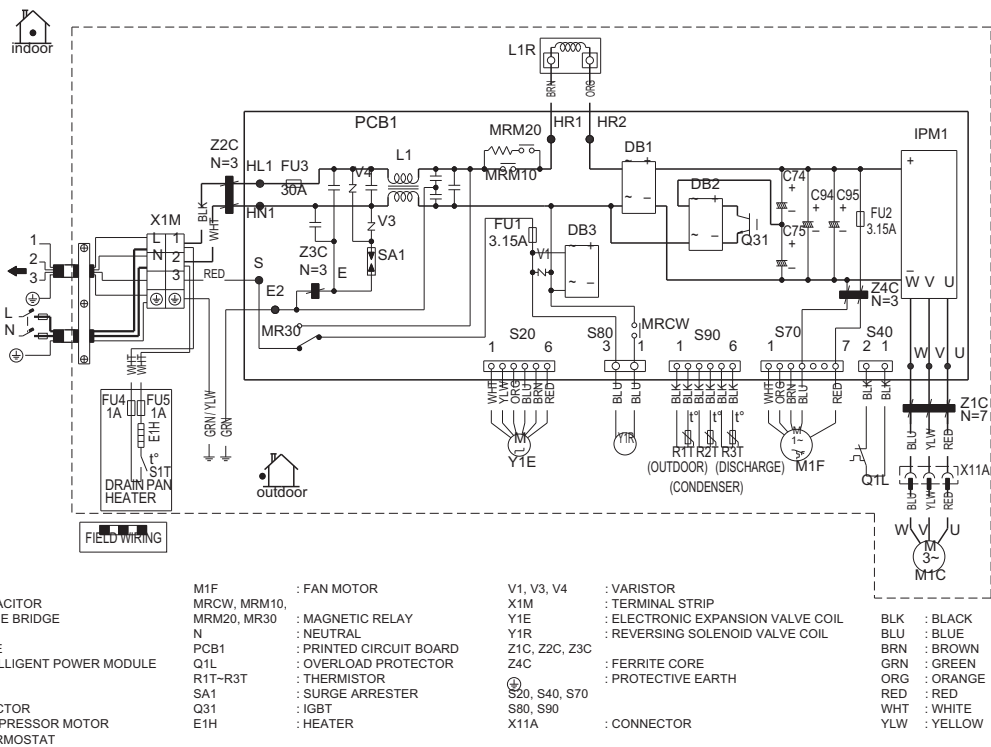

3D062388

RXL35G2V1B

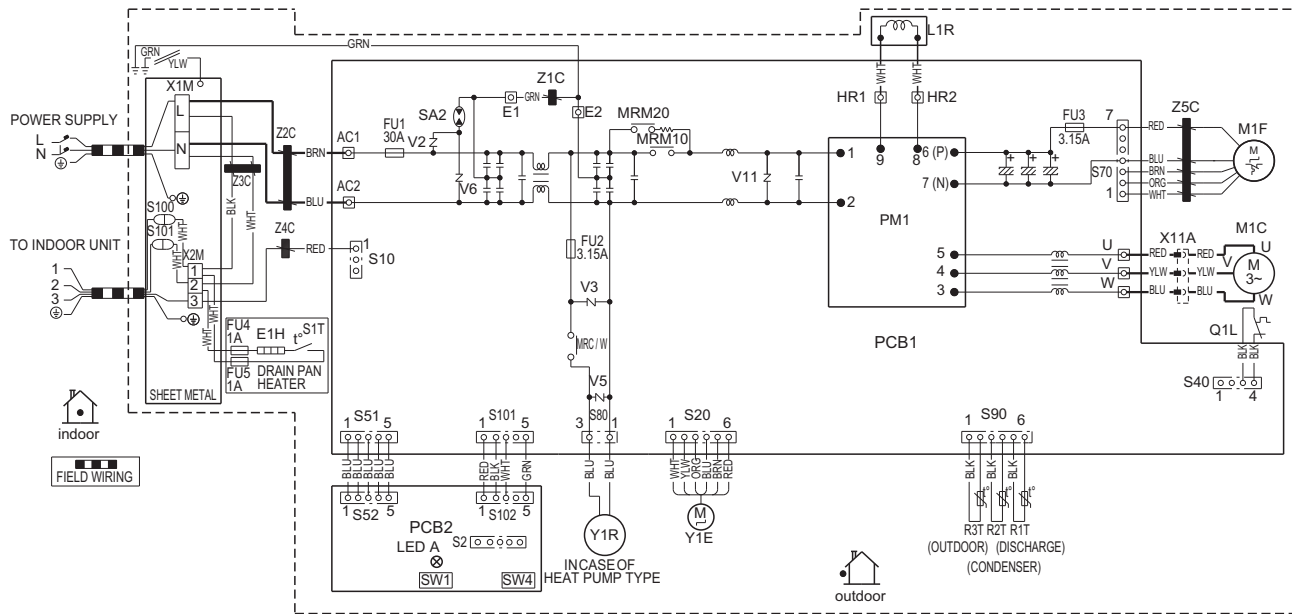

- |                     |                                   |              |                  |     |                                      |             |                                 |
|---------------------|-----------------------------------|--------------|------------------|-----|--------------------------------------|-------------|---------------------------------|
| Z1C-Z5C             | : FERRITE CORE                    | MRM10, MRM20 | : MAGNETIC RELAY | L   | : LIVE                               | M1C         | : COMPRESSOR MOTOR              |
| X1M, X2M            | : TERMINAL STRIP                  | MRC / W      | : MAGNETIC RELAY | N   | : NEUTRAL                            | M1F         | : FAN MOTOR                     |
| Y1E                 | : ELECTRONIC EXPANSION VALVE COIL | R1T-R3T      | : THERMISTOR     | SW1 | : FORCED OPERATION ON / OFF SW (SW1) | L1R         | : REACTOR                       |
| V2, V3, V5, V6, V11 | : VARISTOR                        | S2-S102      | : CONNECTOR      | SW4 | : LOCAL SETTING SW (SW4)             | Q1L         | : OVERLOAD PROTECTOR            |
| SA2                 | : SURGE ARRESTER                  | LEDA         | : PILOT LAMP     | E1H | : HEATER                             | PCB1, 2     | : PRINTED CIRCUIT BOARD         |
| FU1, FU2, FU3       | : FUSE                            | S1T          | : THERMOSTAT     |     |                                      | Y1R         | : REVERSING SOLENOID VALVE COIL |
| FU4, FU5            | : FUSE                            |              |                  |     |                                      | SHEET METAL | : TERMINAL STRIP FIXED PLATE    |
| AC1, AC2            |                                   |              |                  |     |                                      |             |                                 |
| U, V, W, X11A       |                                   |              |                  |     |                                      |             |                                 |
| E1, E2              |                                   |              |                  |     |                                      |             |                                 |
| HR1, HR2            | : CONNECTOR                       |              |                  |     |                                      |             |                                 |

3D062389

In all of us,  
a green heart



Daikin's unique position as a manufacturer of air conditioning equipment, compressors and refrigerants has led to its close involvement in environmental issues. For several years Daikin has had the intension to become a leader in the provision of products that have limited impact on the environment. This challenge demands the eco design and development of a wide range of products and an energy management system, resulting in energy conservation and a reduction of waste.



Daikin Europe N.V. is approved by LRQA for its Quality Management System in accordance with the ISO9001 standard. ISO9001 pertains to quality assurance regarding design, development, manufacturing as well as to services related to the product.



ISO14001 assures an effective environmental management system in order to help protect human health and the environment from the potential impact of our activities, products and services and to assist in maintaining and improving the quality of the environment.



Daikin units comply with the European regulations that guarantee the safety of the product.



Daikin Europe N.V. is participating in the EUROVENT Certification Programme. Products are as listed in the EUROVENT Directory of Certified Products.

"The present publication is drawn up by way of information only and does not constitute an offer binding upon Daikin Europe N.V.. Daikin Europe N.V. has compiled the content of this publication to the best of its knowledge. No express or implied warranty is given for the completeness, accuracy, reliability or fitness for particular purpose of its content and the products and services presented therein. Specifications are subject to change without prior notice. Daikin Europe N.V. explicitly rejects any liability for any direct or indirect damage, in the broadest sense, arising from or related to the use and/or interpretation of this publication. All content is copyrighted by Daikin Europe N.V.."

**DAIKIN EUROPE N.V.**  
Naamloze Vennootschap  
Zandvoordestraat 300  
B-8400 Oostende - Belgium  
www.daikin.eu  
BE 0412 120 336  
RPR Oostende

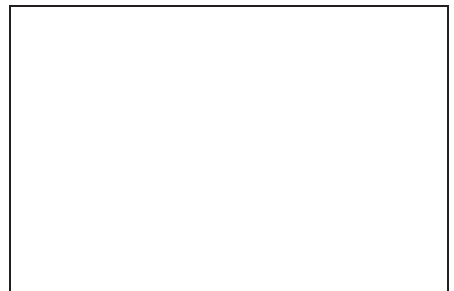

SIENBE04-925\_A