

Service Manual

Inverter Pair Wall Mounted Type J-Series



[Applied Models]

- Inverter Pair : Heat Pump

Inverter Pair Wall Mounted Type J-Series

●Heat Pump

Indoor Unit

FTXG25JV1BW
FTXG25JV1BS

FTXG35JV1BW
FTXG35JV1BS

Outdoor Unit

RXG25J2V1B
RXG35J2V1B

1. Introduction	V
1.1 Safety Cautions	v
1.2 Used Icons	ix
Part 1 List of Functions	1
1. Functions.....	2
Part 2 Specifications	3
1. Specifications	4
Part 3 Printed Circuit Board Connector Wiring Diagram	6
1. Printed Circuit Board Connector Wiring Diagram.....	7
1.1 Indoor Unit.....	7
1.2 Outdoor Unit.....	10
Part 4 Function and Control.....	12
1. Main Functions.....	13
1.1 Frequency Principle.....	13
1.2 Operation Starting Control.....	15
1.3 Airflow Direction Control.....	16
1.4 Fan Speed Control for Indoor Units.....	17
1.5 Program Dry Operation	18
1.6 Automatic Operation.....	19
1.7 Thermostat Control.....	20
1.8 NIGHT SET Mode	21
1.9 ECONO Operation	22
1.10 INTELLIGENT EYE Operation	23
1.11 Inverter POWERFUL Operation	24
1.12 Other Functions.....	26
2. Function of Thermistor	27
3. Control Specification	28
3.1 Mode Hierarchy	28
3.2 Frequency Control.....	29
3.3 Controls at Mode Changing / Start-up.....	31
3.4 Discharge Pipe Temperature Control.....	32
3.5 Input Current Control.....	33
3.6 Freeze-up Protection Control	34
3.7 Heating Peak-cut Control	34
3.8 Outdoor Fan Control.....	35
3.9 Liquid Compression Protection Function.....	35
3.10 Defrost Control	36
3.11 Electronic Expansion Valve Control	37
3.12 Malfunctions	40
3.13 Forced Operation Mode	41
3.14 Standby Electricity Saving.....	41
Part 5 Operation Manual	42
1. System Configuration.....	43

2. Operation Manual.....	44
2.1 Name of Parts	44
2.2 AUTO · DRY · COOL · HEAT · FAN Operation	48
2.3 Adjusting the Airflow Direction and Rate	50
2.4 COMFORT AIRFLOW Operation	52
2.5 INTELLIGENT EYE Operation	53
2.6 POWERFUL Operation	55
2.7 OUTDOOR UNIT QUIET Operation.....	56
2.8 ECONO Operation	57
2.9 OFF TIMER Operation	58
2.10 ON TIMER Operation	59
2.11 WEEKLY TIMER Operation	60

Part 6 Service Diagnosis..... 66

1. Caution for Diagnosis.....	67
1.1 Troubleshooting with LED	67
2. Problem Symptoms and Measures	68
3. Service Check Function	69
4. Troubleshooting	72
4.1 Error Codes and Description	72
4.2 Indoor Unit PCB Abnormality	73
4.3 Freeze-up Protection Control or Heating Peak-cut Control.....	74
4.4 Fan Motor (DC Motor) or Related Abnormality.....	76
4.5 Thermistor or Related Abnormality (Indoor Unit).....	78
4.6 Front Panel Open / Close Fault.....	79
4.7 Signal Transmission Error (between Indoor Unit and Outdoor Unit)	80
4.8 Unspecified Voltage (between Indoor Unit and Outdoor Unit)	81
4.9 Outdoor Unit PCB Abnormality.....	82
4.10 OL Activation (Compressor Overload)	83
4.11 Compressor Lock	84
4.12 DC Fan Lock	85
4.13 Input Overcurrent Detection	86
4.14 Four Way Valve Abnormality	87
4.15 Discharge Pipe Temperature Control.....	89
4.16 High Pressure Control in Cooling	90
4.17 Compressor System Sensor Abnormality	92
4.18 Position Sensor Abnormality	93
4.19 DC Voltage / Current Sensor Abnormality.....	95
4.20 Thermistor or Related Abnormality (Outdoor Unit).....	96
4.21 Electrical Box Temperature Rise.....	98
4.22 Radiation Fin Temperature Rise	100
4.23 Output Overcurrent Detection	102
4.24 Refrigerant Shortage	104
4.25 Low-voltage Detection or Over-voltage Detection.....	106
5. Check	107
5.1 How to Check.....	107

Part 7 Removal Procedure..... 114





1. Indoor Unit.....	115
1.1 Removal of Air Filter / Front Panel	115

1.2	Removal of Horizontal Blades	119
1.3	Removal of Front Grille	121
1.4	Removal of Front Panel Mechanism ASSY.....	124
1.5	Removal of Display Lens ASSY	126
1.6	Removal of Reduction Motor / Limit Switch.....	127
1.7	Removal of Fan Guard / Electrical Box	129
1.8	Removal of PCB.....	132
1.9	Removal of Swing Motor	138
1.10	Removal of Indoor Heat Exchanger	139
1.11	Removal of Fan Rotor / Fan Motor.....	142
1.12	Removal of Vertical Blade ASSY	145
2.	Outdoor Unit.....	146
2.1	Removal of Outer Panels / Fan Motor.....	146
2.2	Removal of Electrical Box	155
2.3	Removal of PCB.....	158
2.4	Removal of Reactor / Partition Plate	166
2.5	Removal of Sound Blanket.....	168
2.6	Removal of Four Way Valve.....	170
2.7	Removal of Compressor.....	173
Part 8	Others	175
1.	Others	176
1.1	Trial Operation.....	176
1.2	Field Settings.....	177
1.3	Application of Silicon Grease to a Power Transistor and a Diode Bridge.....	178
Part 9	Appendix.....	179
1.	Piping Diagrams.....	180
1.1	Indoor Unit.....	180
1.2	Outdoor Unit.....	180
2.	Wiring Diagrams.....	181
2.1	Indoor Unit.....	181
2.2	Outdoor Unit.....	181







1. Introduction



1.1 Safety Cautions









Cautions and Warnings

- Be sure to read the following safety cautions before conducting repair work.
- The caution items are classified into “ **Warning**” and “ **Caution**”. The “ **Warning**” items are especially important since they can lead to death or serious injury if they are not followed closely. The “ **Caution**” items can also lead to serious accidents under some conditions if they are not followed. Therefore, be sure to observe all the safety caution items described below.
- About the pictograms
 - △ This symbol indicates the item for which caution must be exercised.
The pictogram shows the item to which attention must be paid.
 - This symbol indicates the prohibited action.
The prohibited item or action is shown in the illustration or near the symbol.
 - This symbol indicates the action that must be taken, or the instruction.
The instruction is shown in the illustration or near the symbol.
- After the repair work is complete, be sure to conduct a test operation to ensure that the equipment operates normally, and explain the cautions for operating the product to the customer.











1.1.1 Cautions Regarding Safety of Workers





 Warning	
Be sure to disconnect the power cable plug from the plug socket before disassembling the equipment for repair. Working on the equipment that is connected to the power supply may cause an electrical shock. If it is necessary to supply power to the equipment to conduct the repair or inspecting the circuits, do not touch any electrically charged sections of the equipment.	
If the refrigerant gas is discharged during the repair work, do not touch the discharged refrigerant gas. The refrigerant gas may cause frostbite.	
When disconnecting the suction or discharge pipe of the compressor at the welded section, evacuate the refrigerant gas completely at a well-ventilated place first. If there is a gas remaining inside the compressor, the refrigerant gas or refrigerating machine oil discharges when the pipe is disconnected, and it may cause injury.	
If the refrigerant gas leaks during the repair work, ventilate the area. The refrigerant gas may generate toxic gases when it contacts flames.	
The step-up capacitor supplies high-voltage electricity to the electrical components of the outdoor unit. Be sure to discharge the capacitor completely before conducting repair work. A charged capacitor may cause an electrical shock.	
Do not start or stop the air conditioner operation by plugging or unplugging the power cable plug. Plugging or unplugging the power cable plug to operate the equipment may cause an electrical shock or fire.	







 Warning	
Be sure to wear a safety helmet, gloves, and a safety belt when working at a high place (more than 2 m). Insufficient safety measures may cause a fall accident.	
In case of R-410A refrigerant models, be sure to use pipes, flare nuts and tools for the exclusive use of the R-410A refrigerant. The use of materials for R-22 refrigerant models may cause a serious accident such as a damage of refrigerant cycle as well as an equipment failure.	





 Caution	
Do not repair the electrical components with wet hands. Working on the equipment with wet hands may cause an electrical shock.	
Do not clean the air conditioner by splashing water. Washing the unit with water may cause an electrical shock.	
Be sure to provide the grounding when repairing the equipment in a humid or wet place, to avoid electrical shocks.	
Be sure to turn off the power switch and unplug the power cable when cleaning the equipment. The internal fan rotates at a high speed, and cause injury.	
Be sure to conduct repair work with appropriate tools. The use of inappropriate tools may cause injury.	
Be sure to check that the refrigerating cycle section has cooled down enough before conducting repair work. Working on the unit when the refrigerating cycle section is hot may cause burns.	
Use the welder in a well-ventilated place. Using the welder in an enclosed room may cause oxygen deficiency.	

1.1.2 Cautions Regarding Safety of Users

 Warning	
<p>Be sure to use parts listed in the service parts list of the applicable model and appropriate tools to conduct repair work. Never attempt to modify the equipment. The use of inappropriate parts or tools may cause an electrical shock, excessive heat generation or fire.</p>	
<p>If the power cable and lead wires have scratches or deteriorated, be sure to replace them. Damaged cable and wires may cause an electrical shock, excessive heat generation or fire.</p>	
<p>Do not use a joined power cable or extension cable, or share the same power outlet with other electrical appliances, since it may cause an electrical shock, excessive heat generation or fire.</p>	
<p>Be sure to use an exclusive power circuit for the equipment, and follow the local technical standards related to the electrical equipment, the internal wiring regulations, and the instruction manual for installation when conducting electrical work. Insufficient power circuit capacity and improper electrical work may cause an electrical shock or fire.</p>	
<p>Be sure to use the specified cable for wiring between the indoor and outdoor units. Make the connections securely and route the cable properly so that there is no force pulling the cable at the connection terminals. Improper connections may cause excessive heat generation or fire.</p>	
<p>When wiring between the indoor and outdoor units, make sure that the terminal cover does not lift off or dismount because of the cable. If the cover is not mounted properly, the terminal connection section may cause an electrical shock, excessive heat generation or fire.</p>	
<p>Do not damage or modify the power cable. Damaged or modified power cable may cause an electrical shock or fire. Placing heavy items on the power cable, and heating or pulling the power cable may damage the cable.</p>	
<p>Do not mix air or gas other than the specified refrigerant (R-410A / R-22) in the refrigerant system. If air enters the refrigerating system, an excessively high pressure results, causing equipment damage and injury.</p>	
<p>If the refrigerant gas leaks, be sure to locate the leaking point and repair it before charging the refrigerant. After charging refrigerant, make sure that there is no refrigerant leak. If the leaking point cannot be located and the repair work must be stopped, be sure to perform pump-down and close the service valve, to prevent the refrigerant gas from leaking into the room. The refrigerant gas itself is harmless, but it may generate toxic gases when it contacts flames, such as fan and other heaters, stoves and ranges.</p>	
<p>When relocating the equipment, make sure that the new installation site has sufficient strength to withstand the weight of the equipment. If the installation site does not have sufficient strength and if the installation work is not conducted securely, the equipment may fall and cause injury.</p>	





 Warning	
Check to make sure that the power cable plug is not dirty or loose, then insert the plug into a power outlet securely. If the plug has dust or loose connection, it may cause an electrical shock or fire.	
Be sure to install the product correctly by using the provided standard installation frame. Incorrect use of the installation frame and improper installation may cause the equipment to fall, resulting in injury.	For unitary type only 
Be sure to install the product securely in the installation frame mounted on the window frame. If the unit is not securely mounted, it may fall and cause injury.	For unitary type only 
When replacing the coin battery in the remote controller, be sure to disposed of the old battery to prevent children from swallowing it. If a child swallows the coin battery, see a doctor immediately.	

 Caution	
Installation of a leakage breaker is necessary in some cases depending on the conditions of the installation site, to prevent electrical shocks.	
Do not install the equipment in a place where there is a possibility of combustible gas leaks. If the combustible gas leaks and remains around the unit, it may cause a fire.	
Check to see if the parts and wires are mounted and connected properly, and if the connections at the soldered or crimped terminals are secure. Improper installation and connections may cause excessive heat generation, fire or an electrical shock.	
If the installation platform or frame has corroded, replace it. Corroded installation platform or frame may cause the unit to fall, resulting in injury.	
Check the grounding, and repair it if the equipment is not properly grounded. Improper grounding may cause an electrical shock.	

 Caution	
Be sure to measure the insulation resistance after the repair, and make sure that the resistance is 1 MΩ or higher. Faulty insulation may cause an electrical shock.	
Be sure to check the drainage of the indoor unit after the repair. Faulty drainage may cause the water to enter the room and wet the furniture and floor.	
Do not tilt the unit when removing it. The water inside the unit may spill and wet the furniture and floor.	
Be sure to install the packing and seal on the installation frame properly. If the packing and seal are not installed properly, water may enter the room and wet the furniture and floor.	For unitary type only 

1.2 Used Icons

Icons are used to attract the attention of the reader to specific information. The meaning of each icon is described in the table below:

Icon	Type of Information	Description
 Note:	Note	A “note” provides information that is not indispensable, but may nevertheless be valuable to the reader, such as tips and tricks.
 Caution	Caution	A “caution” is used when there is danger that the reader, through incorrect manipulation, may damage equipment, lose data, get an unexpected result or has to restart (part of) a procedure.
 Warning	Warning	A “warning” is used when there is danger of personal injury.
	Reference	A “reference” guides the reader to other places in this binder or in this manual, where he/she will find additional information on a specific topic.

Part 1

List of Functions

1. Functions.....2

1. Functions

Category	Functions	FTXG25/35JV1BW(S) RXG25/35J2V1B	Category	Functions	FTXG25/35JV1BW(S) RXG25/35J2V1B
Basic Function	Inverter (with Inverter Power Control)	○	Health & Clean	Air-Purifying Filter	—
	Operation Limit for Cooling (°CDB)	-10 ~46		Photocatalytic Deodorizing Filter	—
	Operation Limit for Heating (°CWB)	-15 ~20		Air-Purifying Filter with Photocatalytic Deodorizing Function	—
	PAM Control	○		Titanium Apatite Photocatalytic Air-Purifying Filter	○
	Standby Electricity Saving	○		Air Filter (Prefilter)	○
Compressor	Oval Scroll Compressor	—	Wipe-Clean Flat Panel	Wipe-Clean Flat Panel	○
	Swing Compressor	○		Washable Grille	—
	Rotary Compressor	—		Mold Proof Operation	—
	Reluctance DC Motor	○		Heating Dry Operation	—
Comfortable Airflow	Power-Airflow Flap	—	Timer	Good-Sleep Cooling Operation	—
	Power-Airflow Dual Flaps	○		WEEKLY TIMER Operation	○
	Power-Airflow Diffuser	—		24-Hour ON/OFF TIMER	○
	Wide-Angle Louvers	○	Worry Free "Reliability & Durability"	NIGHT SET Mode	○
	Vertical Auto-Swing (Up and Down)	○		Auto-Restart (after Power Failure)	○
	Horizontal Auto-Swing (Right and Left)	—		Self-Diagnosis (Digital, LED) Display	○
	3-D Airflow	—		Wiring Error Check	—
COMFORT AIRFLOW Operation	○	Flexibility	Anti-Corrosion Treatment of Outdoor Heat Exchanger	○	
Comfort Control	Auto Fan Speed		○	Multi-Split / Split Type Compatible Indoor Unit	○
	Indoor Unit Quiet Operation		○	Flexible Voltage Correspondence	—
	NIGHT QUIET Mode (Automatic)		—	High Ceiling Application	—
	OUTDOOR UNIT QUIET Operation (Manual)		○	Chargeless	10 m
	INTELLIGENT EYE Operation		○	Either Side Drain (Right or Left)	○
	Quick Warming Function (Preheating Operation)		○	Power Selection	—
	Hot-Start Function	○	Remote Control	5-Rooms Centralized Controller (Option)	○
Automatic Defrosting	○	Remote Control Adaptor (Normal Open Pulse Contact) (Option)		○	
Operation	Automatic Operation	○		Remote Control Adaptor (Normal Open Contact) (Option)	○
	Program Dry Operation	○	DIII-NET Compatible (Adaptor) (Option)	○	
	Fan Only	○	Remote Controller	Wireless	○
Lifestyle Convenience	New POWERFUL Operation (Non-Inverter)	—		Wired (Option)	○
	Inverter POWERFUL Operation	○			
	Priority-Room Setting	—			
	COOL / HEAT Mode Lock	—			
	HOME LEAVE Operation	—			
	ECONO Operation	○			
	Indoor Unit ON/OFF Button	○			
	Signal Receiving Sign	○			
	Multi-Colored Indicator Lamp (Multi-Monitor Lamp)	○			
	R / C with Back Light	○			
Temperature Display	—				

Note: ○ : Holding Functions
 — : No Functions

Part 2 Specifications

1. Specifications4

1. Specifications

50 Hz, 220 - 230 - 240 V

Models	Indoor Unit		FTXG25JV1BW		FTXG25JV1BS	
	Outdoor Unit		RXG25J2V1B		RXG25J2V1B	
			Cooling	Heating	Cooling	Heating
Capacity Rated (Min. ~ Max.)	kW		2.5 (1.3 ~ 3.0)	3.4 (1.3 ~ 4.5)	2.5 (1.3 ~ 3.0)	3.4 (1.3 ~ 4.5)
	Btu/h		8,500 (4,400 ~ 10,200)	11,600 (4,400 ~ 15,400)	8,500 (4,400 ~ 10,200)	11,600 (4,400 ~ 15,400)
	kcal/h		2,150 (1,120 ~ 2,580)	2,920 (1,120 ~ 3,870)	2,150 (1,120 ~ 2,580)	2,920 (1,120 ~ 3,870)
Running Current (Rated)	A		3.2 - 3.0 - 2.9	4.4 - 4.2 - 4.1	3.2 - 3.0 - 2.9	4.4 - 4.2 - 4.1
Power Consumption Rated (Min. ~ Max.)	W		560 (350 ~ 820)	780 (320 ~ 1,320)	560 (350 ~ 820)	780 (320 ~ 1,320)
Power Factor	%		79.5 - 81.2 - 80.5	80.6 - 80.7 - 79.3	79.5 - 81.2 - 80.5	80.6 - 80.7 - 79.3
EER (Cooling) / COP (Heating) Rated (Min. ~ Max.)	W/W		4.46 (3.71 ~ 3.66)	4.36 (4.06 ~ 3.41)	4.46 (3.71 ~ 3.66)	4.36 (4.06 ~ 3.41)
Piping Connections	Liquid	mm	φ 6.4		φ 6.4	
	Gas	mm	φ 9.5		φ 9.5	
	Drain	mm	φ 16.0 or φ 18.0		φ 16.0 or φ 18.0	
Heat Insulation			Both Liquid and Gas Pipes		Both Liquid and Gas Pipes	
Max. Interunit Piping Length	m		20		20	
Max. Interunit Height Difference	m		15		15	
Chargeless	m		10		10	
Amount of Additional Charge of Refrigerant	g/m		20		20	
Indoor Unit		FTXG25JV1BW		FTXG25JV1BS		
Front Panel Color			White		Silver	
Airflow Rate	m³/min (cfm)	H	8.8 (311)	9.6 (339)	8.8 (311)	9.6 (339)
		M	6.8 (240)	7.9 (279)	6.8 (240)	7.9 (279)
		L	4.7 (166)	6.2 (219)	4.7 (166)	6.2 (219)
		SL	3.8 (134)	5.4 (191)	3.8 (134)	5.4 (191)
Fan	Type		Cross Flow Fan		Cross Flow Fan	
	Motor Output	W	29		29	
	Speed	Steps	5 Steps, Quiet, Auto		5 Steps, Quiet, Auto	
Air Direction Control			Right, Left, Horizontal, Downward		Right, Left, Horizontal, Downward	
Air Filter			Removable / Washable / Mildew Proof		Removable / Washable / Mildew Proof	
Running Current (Rated)	A		0.09 - 0.08 - 0.08	0.12 - 0.11 - 0.11	0.09 - 0.08 - 0.08	0.12 - 0.11 - 0.11
Power Consumption (Rated)	W		18 - 18 - 18	24 - 24 - 24	18 - 18 - 18	24 - 24 - 24
Power Factor	%		90.9 - 97.8 - 93.8	90.9 - 94.9 - 90.9	90.9 - 97.8 - 93.8	90.9 - 94.9 - 90.9
Temperature Control			Microcomputer Control		Microcomputer Control	
Dimensions (H x W x D)	mm		295 x 915 x 155		295 x 915 x 155	
Packaged Dimensions (H x W x D)	mm		285 x 1,003 x 377		285 x 1,003 x 377	
Weight	kg		11		11	
Gross Weight	kg		15		16	
Operation Sound	H / M / L / SL	dBA	38 / 32 / 25 / 22	39 / 34 / 28 / 25	38 / 32 / 25 / 22	39 / 34 / 28 / 25
Sound Power		dBA	54	55	54	55
Outdoor Unit		RXG25J2V1B		RXG25J2V1B		
Casing Color			Ivory White		Ivory White	
Compressor	Type		Hermetically Sealed Swing Type		Hermetically Sealed Swing Type	
	Model		1YC23AEXD		1YC23AEXD	
	Motor Output	W	600		600	
Refrigerant Oil	Type		FVC50K		FVC50K	
	Charge	L	0.375		0.375	
Refrigerant	Type		R-410A		R-410A	
	Charge	kg	1.05		1.05	
Airflow Rate	m³/min (cfm)	H	33.5 (1,183)	30.2 (1,066)	33.5 (1,183)	30.2 (1,066)
		SL	30.1 (1,063)	25.6 (904)	30.1 (1,063)	25.6 (904)
Fan	Type		Propeller		Propeller	
	Motor Output	W	23		23	
Running Current (Rated)	A		3.11 - 2.92 - 2.82	4.28 - 4.09 - 3.99	3.11 - 2.92 - 2.82	4.28 - 4.09 - 3.99
Power Consumption (Rated)	W		542 - 542 - 542	756 - 756 - 756	542 - 542 - 542	756 - 756 - 756
Power Factor	%		79.2 - 80.7 - 80.1	80.3 - 80.4 - 79.0	79.2 - 80.7 - 80.1	80.3 - 80.4 - 79.0
Starting Current	A		4.4		4.4	
Dimensions (H x W x D)	mm		550 x 765 x 285		550 x 765 x 285	
Packaged Dimensions (H x W x D)	mm		612 x 906 x 364		612 x 906 x 364	
Weight	kg		34		34	
Gross Weight	kg		38		38	
Operation Sound	H / SL	dBA	46 / 43	47 / 44	46 / 43	47 / 44
Sound Power	H	dBA	61	62	61	62
Drawing No.			3D066165A		3D066436A	

Note: ■ The data are based on the conditions shown in the table below.

Cooling	Heating	Piping Length
Indoor ; 27°CDB / 19°CWB	Indoor ; 20°CDB	5 m
Outdoor ; 35°CDB / 24°CWB	Outdoor ; 7°CDB / 6°CWB	

Conversion Formulae
kcal/h = kW × 860
Btu/h = kW × 3412
cfm = m³/min × 35.3

50 Hz, 220 - 230 - 240 V

Models	Indoor Unit		FTXG35JV1BW		FTXG35JV1BS	
	Outdoor Unit		RXG35J2V1B		RXG35J2V1B	
			Cooling	Heating	Cooling	Heating
Capacity Rated (Min. ~ Max.)	kW		3.5 (1.4 ~ 3.8)	4.0 (1.4 ~ 5.0)	3.5 (1.4 ~ 3.8)	4.0 (1.4 ~ 5.0)
	Btu/h		11,900 (4,800 ~ 13,000)	13,600 (4,800 ~ 17,100)	11,900 (4,800 ~ 13,000)	13,600 (4,800 ~ 17,100)
	kcal/h		3,010 (1,200 ~ 3,270)	3,440 (1,200 ~ 4,300)	3,010 (1,200 ~ 3,270)	3,440 (1,200 ~ 4,300)
Running Current (Rated)	A		5.1 - 4.8 - 4.6	5.6 - 5.3 - 5.1	5.1 - 4.8 - 4.6	5.6 - 5.3 - 5.1
Power Consumption Rated (Min. ~ Max.)	W		890 (360 ~ 1,220)	990 (320 ~ 1,500)	890 (360 ~ 1,220)	990 (320 ~ 1,500)
Power Factor	%		79.3 - 80.6 - 80.6	80.4 - 81.2 - 80.9	79.3 - 80.6 - 80.6	80.4 - 81.2 - 80.9
EER (Cooling) / COP (Heating) Rated (Min. ~ Max.)	W/W		3.93 (3.89 ~ 3.11)	4.04 (4.38 ~ 3.33)	3.93 (3.89 ~ 3.11)	4.04 (4.38 ~ 3.33)
Piping Connections	Liquid	mm	φ 6.4		φ 6.4	
	Gas	mm	φ 9.5		φ 9.5	
	Drain	mm	φ 16.0 or φ 18.0		φ 16.0 or φ 18.0	
Heat Insulation			Both Liquid and Gas Pipes		Both Liquid and Gas Pipes	
Max. Interunit Piping Length	m		20		20	
Max. Interunit Height Difference	m		15		15	
Chargeless	m		10		10	
Amount of Additional Charge of Refrigerant	g/m		20		20	
Indoor Unit		FTXG35JV1BW		FTXG35JV1BS		
Front Panel Color			White		Silver	
Airflow Rate	m ³ /min (cfm)	H	10.1 (357)	10.8 (381)	10.1 (357)	10.8 (381)
		M	7.3 (258)	8.6 (304)	7.3 (258)	8.6 (304)
		L	4.6 (162)	6.4 (226)	4.6 (162)	6.4 (226)
		SL	3.9 (138)	5.6 (198)	3.9 (138)	5.6 (198)
Fan	Type		Cross Flow Fan		Cross Flow Fan	
	Motor Output	W	29		29	
	Speed	Steps	5 Steps, Quiet, Auto		5 Steps, Quiet, Auto	
Air Direction Control			Right, Left, Horizontal, Downward		Right, Left, Horizontal, Downward	
Air Filter			Removable / Washable / Mildew Proof		Removable / Washable / Mildew Proof	
Running Current (Rated)	A		0.13 - 0.12 - 0.12	0.16 - 0.15 - 0.14	0.13 - 0.12 - 0.12	0.16 - 0.15 - 0.14
Power Consumption (Rated)	W		26 - 26 - 26	32 - 32 - 32	26 - 26 - 26	32 - 32 - 32
Power Factor	%		90.9 - 94.2 - 90.3	90.9 - 92.8 - 95.2	90.9 - 94.2 - 90.3	90.9 - 92.8 - 95.2
Temperature Control			Microcomputer Control		Microcomputer Control	
Dimensions (H x W x D)	mm		295 x 915 x 155		295 x 915 x 155	
Packaged Dimensions (H x W x D)	mm		285 x 1,003 x 377		285 x 1,003 x 377	
Weight	kg		11		11	
Gross Weight	kg		15		16	
Operation Sound	H / M / L / SL	dBA	42 / 34 / 26 / 23	42 / 36 / 29 / 26	42 / 34 / 26 / 23	42 / 36 / 29 / 26
Sound Power		dBA	58	58	58	58
Outdoor Unit		RXG35J2V1B		RXG35J2V1B		
Casing Color			Ivory White		Ivory White	
Compressor	Type		Hermetically Sealed Swing Type		Hermetically Sealed Swing Type	
	Model		1YC23AEXD		1YC23AEXD	
	Motor Output	W	600		600	
Refrigerant Oil	Type		FVC50K		FVC50K	
	Charge	L	0.375		0.375	
Refrigerant	Type		R-410A		R-410A	
	Charge	kg	1.05		1.05	
Airflow Rate	m ³ /min (cfm)	H	36.0 (1,271)	30.2 (1,066)	36.0 (1,271)	30.2 (1,066)
		SL	30.1 (1,063)	25.6 (904)	30.1 (1,063)	25.6 (904)
Fan	Type		Propeller		Propeller	
	Motor Output	W	23		23	
Running Current (Rated)	A		4.97 - 4.68 - 4.48	5.44 - 5.15 - 4.96	4.97 - 4.68 - 4.48	5.44 - 5.15 - 4.96
Power Consumption (Rated)	W		864 - 864 - 864	958 - 958 - 958	864 - 864 - 864	958 - 958 - 958
Power Factor	%		79.0 - 80.3 - 80.3	80.1 - 80.9 - 80.5	79.0 - 80.3 - 80.3	80.1 - 80.9 - 80.5
Starting Current	A		5.6		5.6	
Dimensions (H x W x D)	mm		550 x 765 x 285		550 x 765 x 285	
Packaged Dimensions (H x W x D)	mm		612 x 906 x 364		612 x 906 x 364	
Weight	kg		34		34	
Gross Weight	kg		38		38	
Operation Sound	H / SL	dBA	48 / 44	48 / 45	48 / 44	48 / 45
Sound Power	H	dBA	63	63	63	63
Drawing No.			3D066437A		3D066438A	

Note: ■ The data are based on the conditions shown in the table below.

Cooling	Heating	Piping Length
Indoor ; 27°CDB / 19°CWB	Indoor ; 20°CDB	5 m
Outdoor ; 35°CDB / 24°CWB	Outdoor ; 7°CDB / 6°CWB	

Conversion Formulae
kcal/h = kW × 860
Btu/h = kW × 3412
cfm = m ³ /min × 35.3

Part 3 Printed Circuit Board Connector Wiring Diagram

1. Printed Circuit Board Connector Wiring Diagram.....	7
1.1 Indoor Unit.....	7
1.2 Outdoor Unit.....	10

1. Printed Circuit Board Connector Wiring Diagram

1.1 Indoor Unit

Connectors and Other Parts

PCB (1): Control PCB

- | | |
|----------------------|---|
| 1) S21 | Connector for centralized control (HA) |
| 2) S25 | Connector for INTELLIGENT EYE sensor PCB |
| 3) S32 | Connector for indoor heat exchanger thermistor |
| 4) S41 | Connector for swing motors |
| 5) S42 | Connector for reduction motor (front panel mechanism) and limit switch |
| 6) S46 | Connector for signal receiver / display PCB |
| 7) S200 | Connector for fan motor |
| 8) H1, H2, H3,
FG | Connector for terminal board |
| 9) JB | Fan speed setting when compressor stops for thermostat OFF |
| JC | Power failure recovery function (auto-restart)
* Refer to page 177 for detail. |
| 10) LED A | LED for service monitor (green) |
| 11) F1U | Fuse (3.15 A, 250 V) |
| 12) V1 | Varistor |

PCB (2): Signal Receiver / Display PCB

- | | |
|--------|---|
| 1) S51 | Connector for control PCB |
| 2) S52 | Connector for room temperature thermistor |
| 3) S1W | Forced operation ON/OFF button |
| 4) H1P | LED for operation (multi-color) |
| 5) H2P | LED for INTELLIGENT EYE (green) |
| 6) JA | Address setting jumper
* Refer to page 177 for detail. |

PCB (3): INTELLIGENT EYE Sensor PCB

- | | |
|--------|---------------------------|
| 1) S36 | Connector for control PCB |
|--------|---------------------------|

PCB Detail

PCB (1): Control PCB

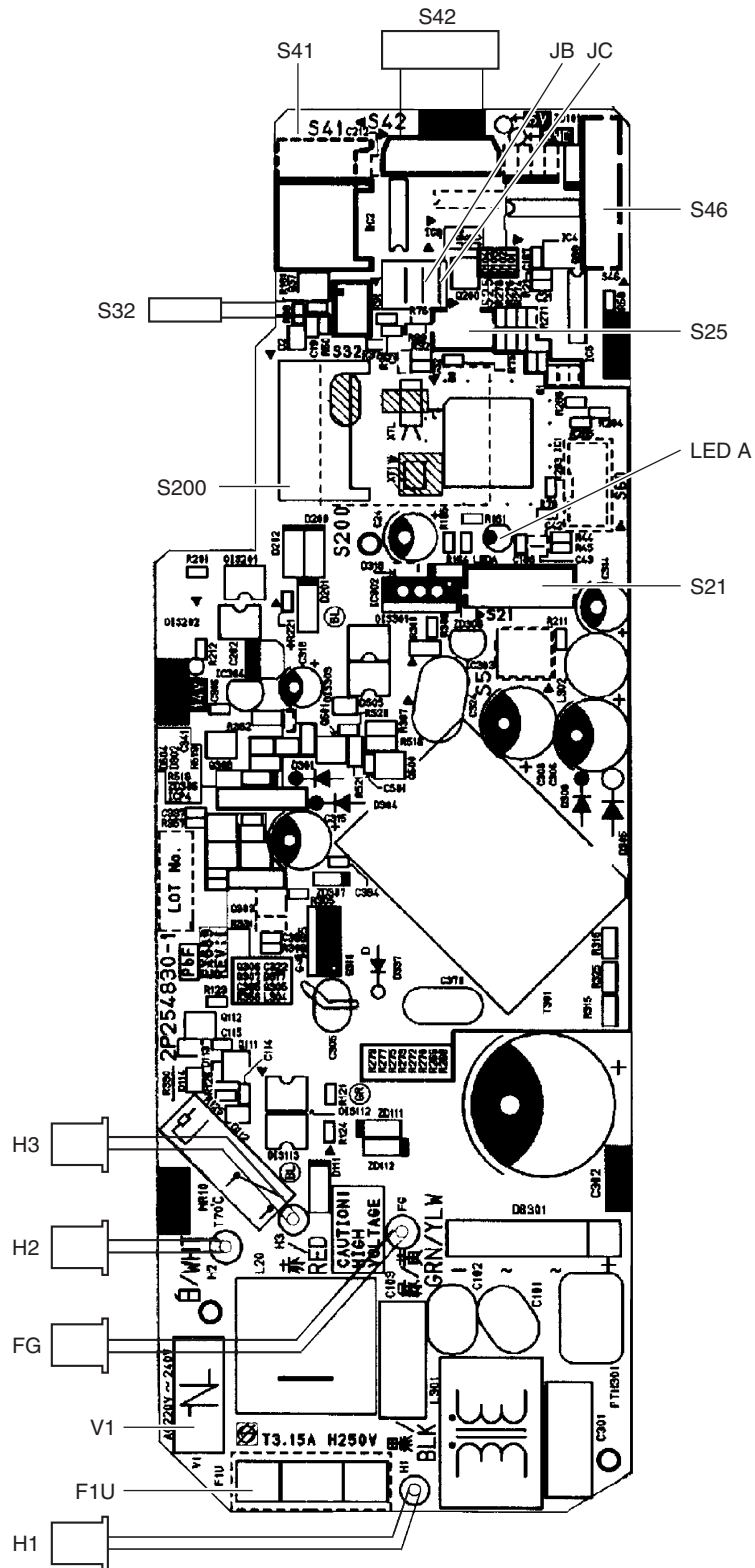

2P254830-1

PCB (2): Signal Receiver / Display PCB

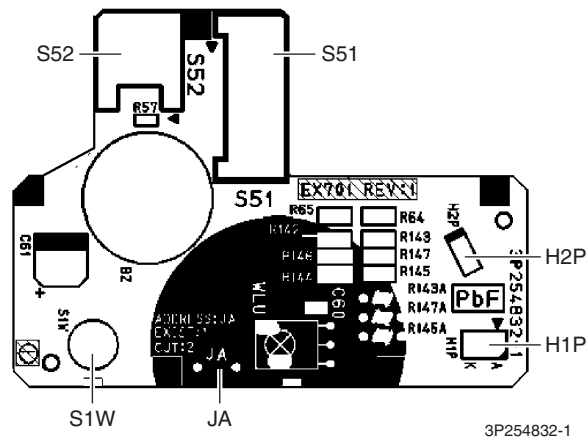

PCB (3): INTELLIGENT EYE Sensor PCB

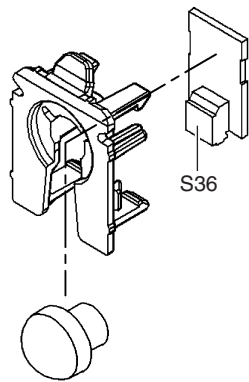

3P255914-1

1.2 Outdoor Unit

Connectors and Other Parts

PCB(1): Filter PCB

- | | |
|----------------|------------------------------|
| 1) S11 | Connector for main PCB |
| 2) AC1, AC2, S | Connector for terminal board |
| 3) E1, E2 | Terminal for earth |
| 4) HL2, HN2 | Connector for main PCB |
| 5) HR1 | Connector for reactor |
| 6) FU1 | Fuse (3.15 A, 250 V) |
| 7) FU3 | Fuse (20 A, 250 V) |
| 8) V2, V3 | Varistor |

PCB(2): Main PCB

- | | |
|-------------|--|
| 1) S10 | Connector for filter PCB |
| 2) S20 | Connector for electronic expansion valve coil |
| 3) S40 | Connector for overload protector |
| 4) S50 | Connector for magnetic relay |
| 5) S70 | Connector for fan motor |
| 6) S80 | Connector for four way valve coil |
| 7) S90 | Connector for thermistors
(outdoor temperature, outdoor heat exchanger, discharge pipe) |
| 8) S100 | Connector for forced operation button PCB |
| 9) HL3, HN3 | Connector for filter PCB |
| 10)HR2 | Connector for reactor |
| 11)U, V, W | Connector for compressor |
| 12)FU2 | Fuse (3.15 A, 250 V) |
| 13)LED A | LED for service monitor (green) |
| 14)V1 | Varistor |
| 15)J5 | Jumper for improvement of defrost performance
* Refer to page 177 for detail. |

PCB(3): Forced Operation Button PCB

- | | |
|---------|--------------------------------|
| 1) S110 | Connector for main PCB |
| 2) SW1 | Forced operation ON/OFF button |

PCB Detail

PCB(1): Filter PCB

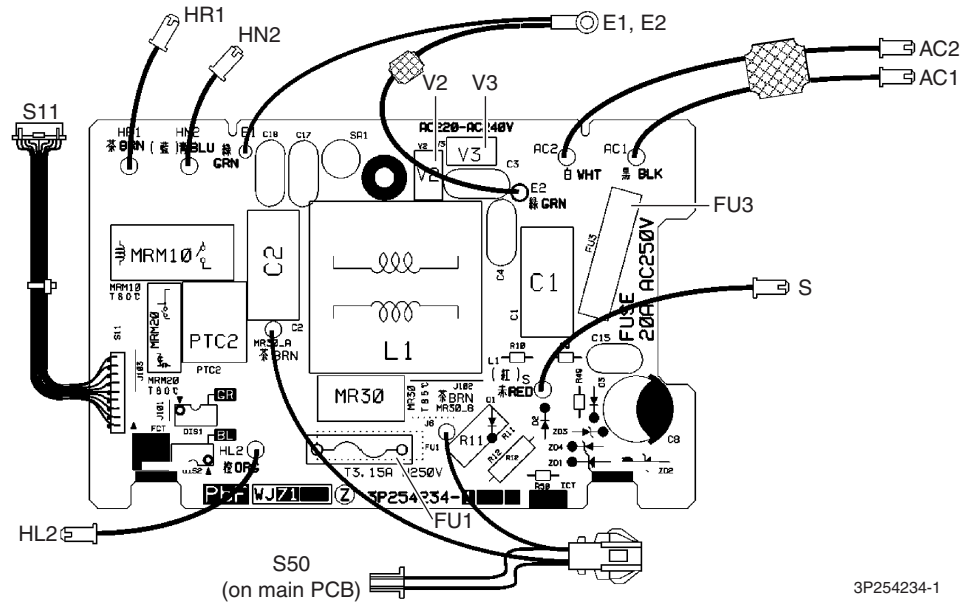

PCB(2): Main PCB

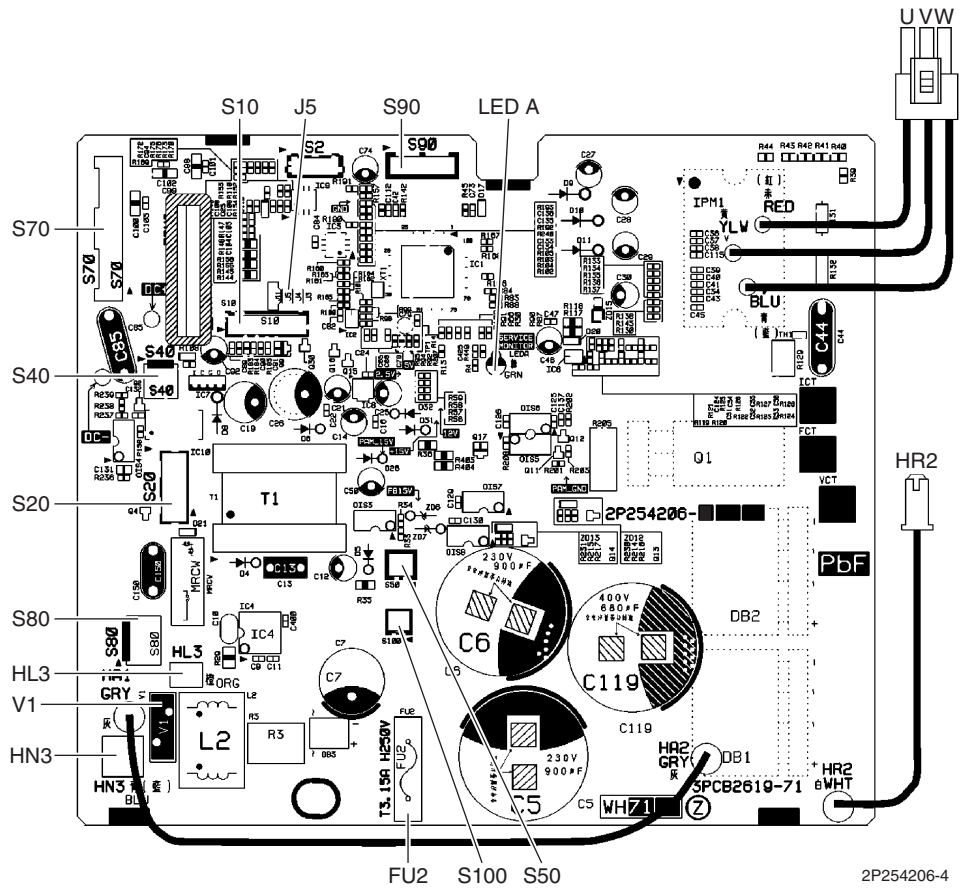

PCB(3): Forced Operation Button PCB

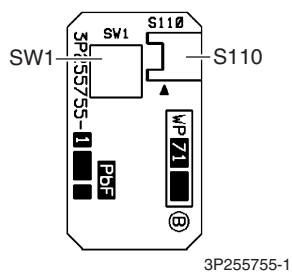

Part 4

Function and Control

1. Main Functions.....	13
1.1 Frequency Principle.....	13
1.2 Operation Starting Control.....	15
1.3 Airflow Direction Control.....	16
1.4 Fan Speed Control for Indoor Units.....	17
1.5 Program Dry Operation	18
1.6 Automatic Operation.....	19
1.7 Thermostat Control.....	20
1.8 NIGHT SET Mode	21
1.9 ECONO Operation	22
1.10 INTELLIGENT EYE Operation	23
1.11 Inverter POWERFUL Operation	24
1.12 Other Functions.....	26
2. Function of Thermistor	27
3. Control Specification	28
3.1 Mode Hierarchy	28
3.2 Frequency Control.....	29
3.3 Controls at Mode Changing / Start-up.....	31
3.4 Discharge Pipe Temperature Control.....	32
3.5 Input Current Control.....	33
3.6 Freeze-up Protection Control	34
3.7 Heating Peak-cut Control	34
3.8 Outdoor Fan Control.....	35
3.9 Liquid Compression Protection Function.....	35
3.10 Defrost Control	36
3.11 Electronic Expansion Valve Control	37
3.12 Malfunctions	40
3.13 Forced Operation Mode	41
3.14 Standby Electricity Saving.....	41

1. Main Functions

1.1 Frequency Principle

Main Control Parameters

The compressor is frequency-controlled during normal operation. The target frequency is set by the following 2 parameters coming from the operating indoor unit:

- The load condition of the operating indoor unit
- The difference between the room temperature and the target temperature

Additional Control Parameters

The target frequency is adapted by additional parameters in the following cases:

- Frequency restrictions
- Initial settings
- Forced cooling operation

Inverter Principle

To regulate the capacity, a frequency control is needed. The inverter makes it possible to vary the rotation speed of the compressor. The following table explains the conversion principle:

Phase	Description
1	The supplied AC power source is converted into the DC power source for the present.
2	The DC power source is reconverted into the three phase AC power source with variable frequency. <ul style="list-style-type: none"> ■ When the frequency increases, the rotation speed of the compressor increases resulting in an increased refrigerant circulation. This leads to a higher amount of the heat exchange per unit. ■ When the frequency decreases, the rotation speed of the compressor decreases resulting in a decreased refrigerant circulation. This leads to a lower amount of the heat exchange per unit.

Drawing of Inverter

The following drawing shows a schematic view of the inverter principle:

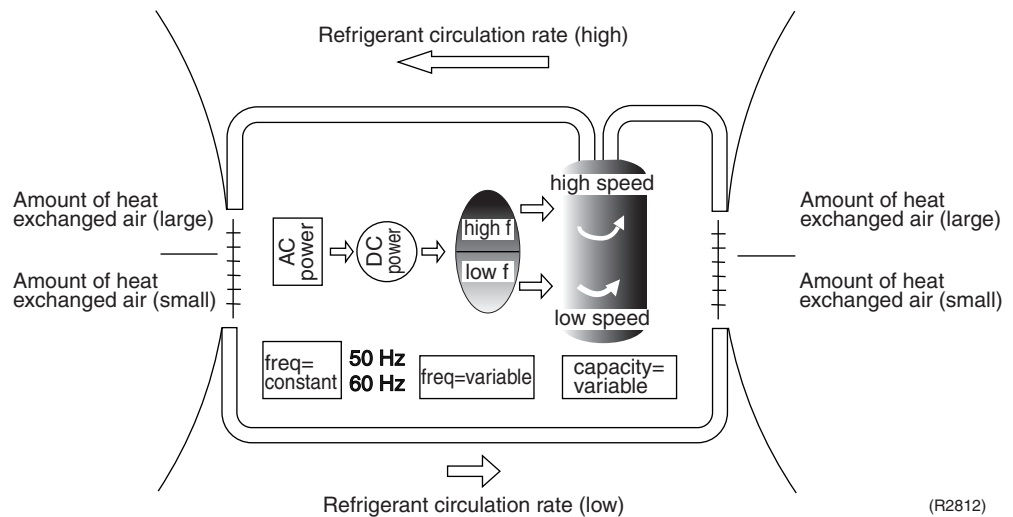

Inverter Features

The inverter provides the following features:

- The regulating capacity can be changed according to the changes in the outdoor temperature and cooling / heating load.
- Quick heating and quick cooling
The compressor rotational speed is increased when starting the heating (or cooling). This enables to reach the set temperature quickly.
- Even during extreme cold weather, the high capacity is achieved. It is maintained even when the outdoor temperature is 2°C.
- Comfortable air conditioning
A fine adjustment is integrated to keep the room temperature constant.
- Energy saving heating and cooling
Once the set temperature is reached, the energy saving operation enables to maintain the room temperature at low power.

Frequency Limits

The following functions regulate the minimum and maximum frequency:

Frequency	Functions
Low	<ul style="list-style-type: none"> ■ Four way valve operation compensation. Refer to page 31.
High	<ul style="list-style-type: none"> ■ Compressor protection function. Refer to page 32. ■ Discharge pipe temperature control. Refer to page 32. ■ Input current control. Refer to page 33. ■ Freeze-up protection control. Refer to page 34. ■ Heating peak-cut control. Refer to page 34. ■ Defrost control. Refer to page 36.

Forced Cooling Operation

Refer to "Forced operation mode" on page 41 for detail.

1.2 Operation Starting Control

The system carries out the following control at the beginning to conduct every functional parts properly.

1. Opening the front panel fully
2. Output of the ΔD signal after the front panel starts moving
3. Opening the flap fully after the front panel opens fully
4. Making the fan rotate when the flap passes over the fan-banned area

Control Flow

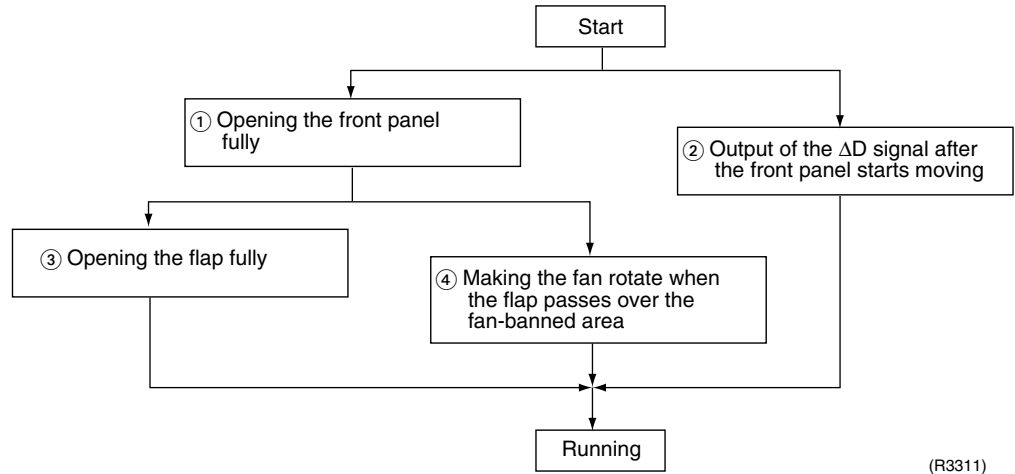

Timing Chart

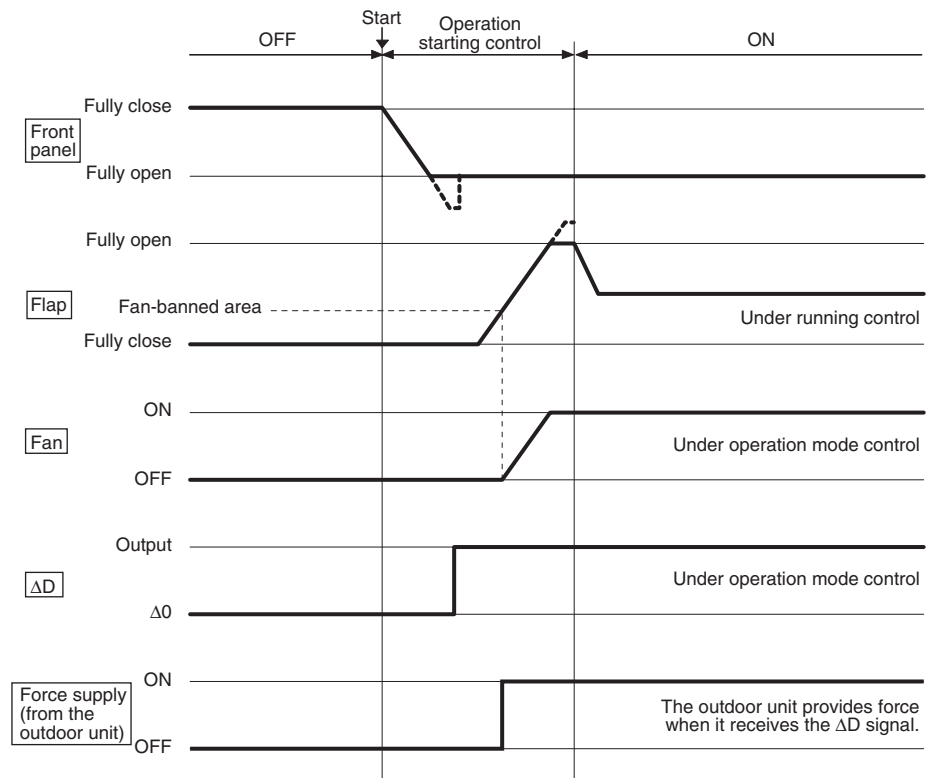

1.3 Airflow Direction Control

Power-Airflow Dual Flaps

The large flaps send a large volume of air downwards to the floor. The flap provides an optimum control in cooling, dry, and heating mode.

Cooling / Dry Mode

During cooling or dry mode, the flap retracts into the indoor unit. Then, cool air can be blown far and pervaded all over the room.

Heating Mode

During heating mode, the large flap directs airflow downwards to spread the warm air to the entire room.

Wide-Angle Louvers

The louvers, made of elastic synthetic resin, provide a wide range of airflow that guarantees a comfortable air distribution.

Auto-Swing

The following table explains the auto swing process for cooling, dry, heating, and fan :

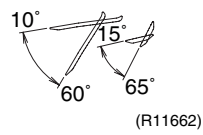
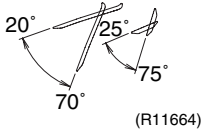
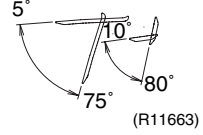
Vertical Swing (up and down)		
Cooling / Dry	Heating	Fan
 <p>(R11662)</p>	 <p>(R11664)</p>	 <p>(R11663)</p>

COMFORT AIRFLOW Operation

The vertical swing flap is controlled not to blow the air directly on the person in the room.

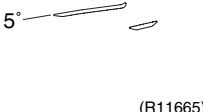
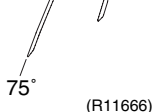
Cooling	Heating
 <p>(R11665)</p>	 <p>(R11666)</p>

1.4 Fan Speed Control for Indoor Units

Outline

Phase control and fan speed control contains 9 steps: LLL, LL, SL, L, ML, M, MH, H, and HH. The airflow rate can be automatically controlled depending on the difference between the room temperature and the target temperature. This is done through phase control and Hall IC control.



For more information about Hall IC, refer to the troubleshooting for fan motor on page 76.

Automatic Fan Speed Control

In automatic fan speed operation, the step "SL" is not available.

Step	Cooling	Heating
LLL	 (R6833)	 (R6834)
LL		
L		
ML		
M		
MH		
H		
HH (POWERFUL)		

= The airflow rate is automatically controlled within this range when the FAN setting button is set to automatic.

<Cooling>

The following drawing explains the principle of fan speed control for cooling.

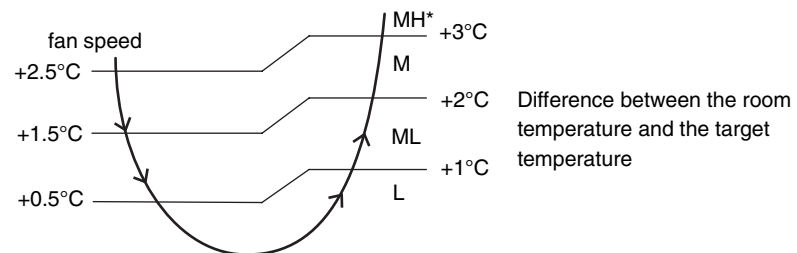

(R11809)

*In automatic fan speed operation, upper limit is at M tap in 30 minutes from the operation start.

<Heating>

On heating mode, the fan speed is regulated according to the indoor heat exchanger temperature and the difference between the room temperature and the target temperature.



Note:

1. During POWERFUL operation, fan rotates at H tap + 50 rpm.
2. Fan stops during defrost operation.
3. In time of thermostat OFF, the fan rotates at the following speed.
Cooling: The fan keeps rotating at the set tap.
Heating: The fan stops.

COMFORT AIRFLOW Operation

- The fan speed is controlled automatically within the following steps.
Cooling: L tap – MH tap (same as AUTOMATIC)
Heating: ML tap – Equivalent to ML tap – MH tap
- The latest command has the priority between POWERFUL and COMFORT AIRFLOW.

1.5 Program Dry Operation

Outline

Program dry operation removes humidity while preventing the room temperature from lowering. Since the microcomputer controls both the temperature and airflow rate, the temperature adjustment and fan adjustment buttons are inoperable in this mode.

Detail

The microcomputer automatically sets the temperature and airflow rate. The difference between the room temperature at start-up and the target temperature is divided into two zones. Then, the unit operates in the dry mode with an appropriate capacity for each zone to maintain the temperature and humidity at a comfortable level.

Room temperature at start-up	Target temperature X	Thermostat OFF point Y	Thermostat ON point Z
24°C or more	Room temperature at start-up	$X - 2.5^{\circ}\text{C}$	$X - 0.5^{\circ}\text{C}$ or $Y + 0.5^{\circ}\text{C}$ (zone B) continues for 10 min.
23.5°C ⋮ 18°C		$X - 2.0^{\circ}\text{C}$	$X - 0.5^{\circ}\text{C}$ or $Y + 0.5^{\circ}\text{C}$ (zone B) continues for 10 min.
17.5°C ⋮		$X - 2.0^{\circ}\text{C}$	$X - 0.5^{\circ}\text{C} = 17.5^{\circ}\text{C}$ or $Y + 0.5^{\circ}\text{C}$ (zone B) continues for 10 min.

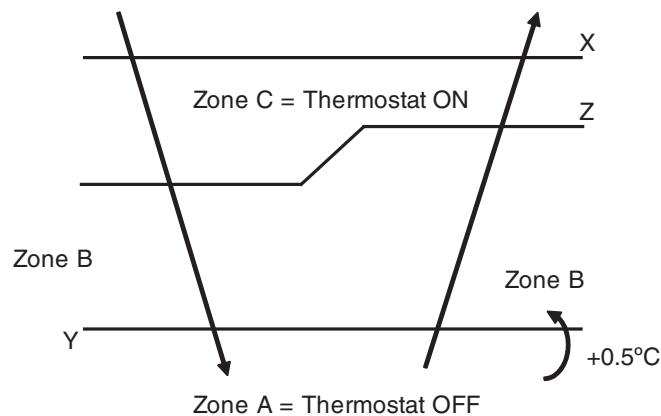

(R11581)

1.6 Automatic Operation

Outline

Automatic Cooling / Heating Function

When the AUTO mode is selected with the remote controller, the microcomputer automatically determines the operation mode as cooling or heating according to the room temperature and the set temperature at start-up, and automatically operates in that mode.

The unit automatically switches the operation mode to maintain the room temperature at the set temperature.

Detail

Tc: temperature set by remote controller

Tt: target temperature

Tr: room temperature

C: correction value

- The temperature set by remote controller (Tc) determines the target temperature (Tt).
(Tc = 18 ~ 30°C).
- The target temperature (Tt) is calculated as;

$$Tt = Tc + C$$
 where C is the correction value.

$$C = 0^{\circ}\text{C}$$
- Thermostat ON/OFF point and mode switching point are as follows.
 Tr means the room temperature.
 - Heating → Cooling switching point:

$$Tr \geq Tt + 3.0^{\circ}\text{C}$$
 - Cooling → Heating switching point:

$$Tr < Tt - 2.5^{\circ}\text{C}$$
 - Thermostat ON/OFF point is the same as the ON/OFF point of cooling or heating operation.
- During initial operation
 - $Tr \geq Tc$: Cooling operation
 - $Tr < Tc$: Heating operation

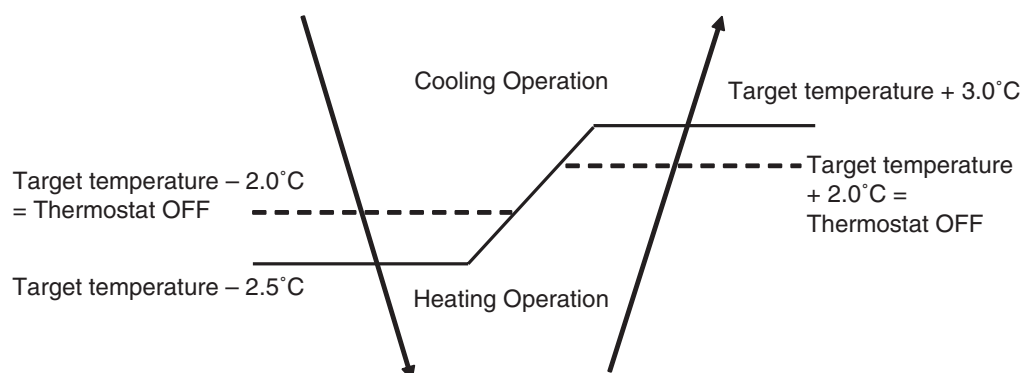

(R11810)

Ex: When the target temperature is 25°C

Cooling → 23°C: Thermostat OFF → 22°C: Switch to heating

Heating → 27°C: Thermostat OFF → 28°C: Switch to cooling

1.7 Thermostat Control

Thermostat control is based on the difference between the room temperature and the target temperature.

Thermostat OFF Condition

- ◆ The temperature difference is in the zone A.

Thermostat ON Condition

- ◆ The temperature difference returns to the zone C after being in the zone A.
- ◆ The system resumes from defrost control in any zones except A.
- ◆ The operation turns on in any zones except A.
- ◆ The monitoring time has passed while the temperature difference is in the zone B.
(Cooling / Dry : 10 minutes, Heating : 10 seconds)

Cooling / Dry

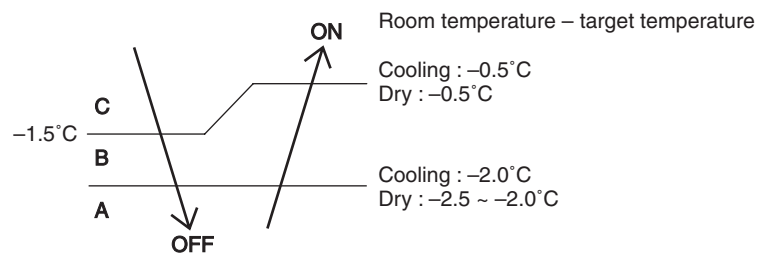

Heating

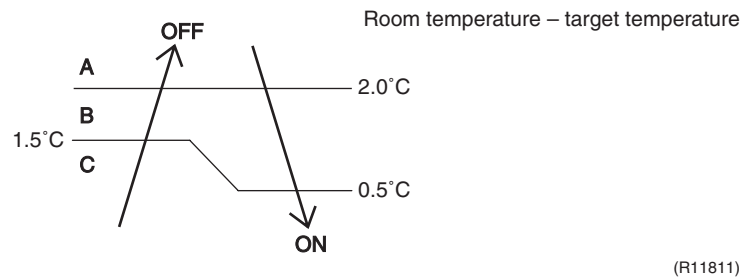

1.8 NIGHT SET Mode

Outline

When the OFF timer is set, the NIGHT SET Mode is automatically activated. The NIGHT SET Mode keeps the airflow rate setting.

Detail

The NIGHT SET Mode continues operation at the target temperature for the first one hour, then automatically raises the target temperature slightly in the case of cooling, or lowers it slightly in the case of heating. This prevents excessive cooling in summer and excessive heating in winter to ensure comfortable sleeping conditions, and also conserves electricity.

Cooling

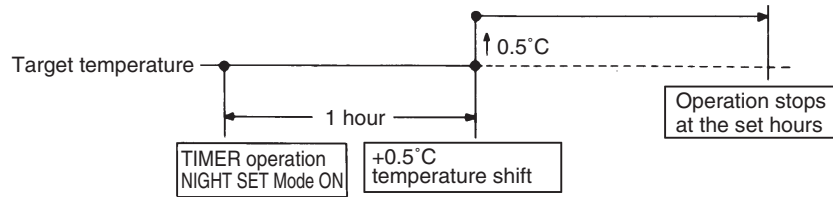

(R10870)

Heating

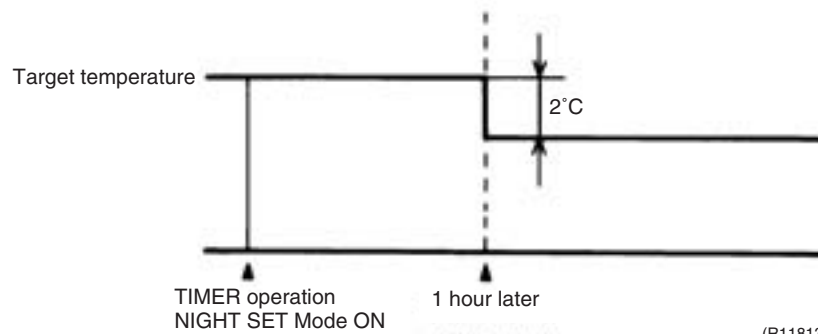

(R11813)

1.9 ECONO Operation

Outline

The "ECONO operation" reduces the maximum operating current and power consumption. This operation is particularly convenient for energy-saving-oriented users. It is also a major bonus for those whose breaker capacities do not allow the use of multiple electrical devices and air conditioners.

It is easily activated from the wireless remote controller by pushing the ECONO button.

- When this function is activated, the maximum capacity also decreases.
- The remote controller can send the ECONO command when the unit is in COOL, HEAT, DRY, or AUTO operation. This function can only be set when the unit is running. Pressing the ON/OFF button on the remote controller cancels the function.
- This function and POWERFUL operation cannot be used at the same time. The latest command has the priority.

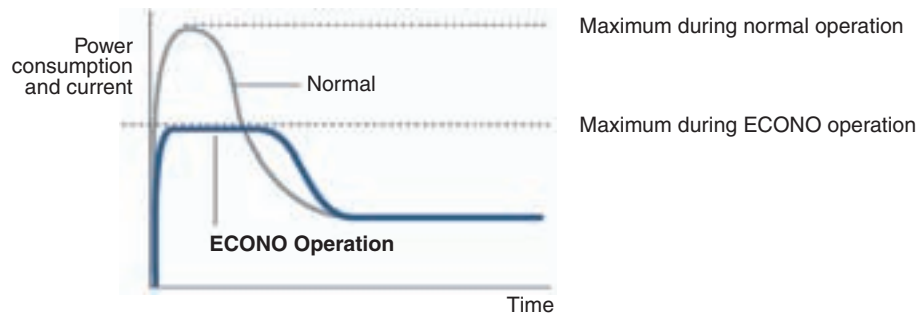

(R9288)

Detail

- When the ECONO command is valid, the input current has upper limit. (Refer to "Input current control" on page 33.)

1.10 INTELLIGENT EYE Operation

Outline

This is the function that detects existence of humans in the room by a human motion sensor (INTELLIGENT EYE) and reduces the capacity when there is nobody in the room in order to save electricity.

Detail

1. Detection method by INTELLIGENT EYE

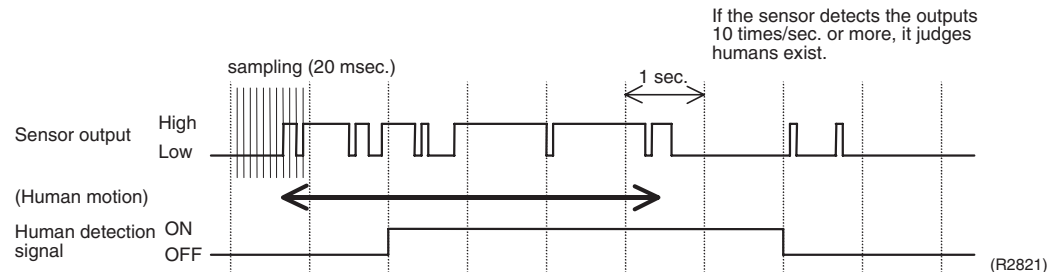

- This sensor detects human motion by receiving infrared rays and displays the pulse wave output.
- A microcomputer in an indoor unit carries out a sampling every 20 msec. and if it detects 10 cycles of the wave in one second in total (corresponding to $20 \text{ msec.} \times 10 = 200 \text{ msec.}$), it judges human is in the room as the motion signal is ON.

2. Motions (for example: in cooling)

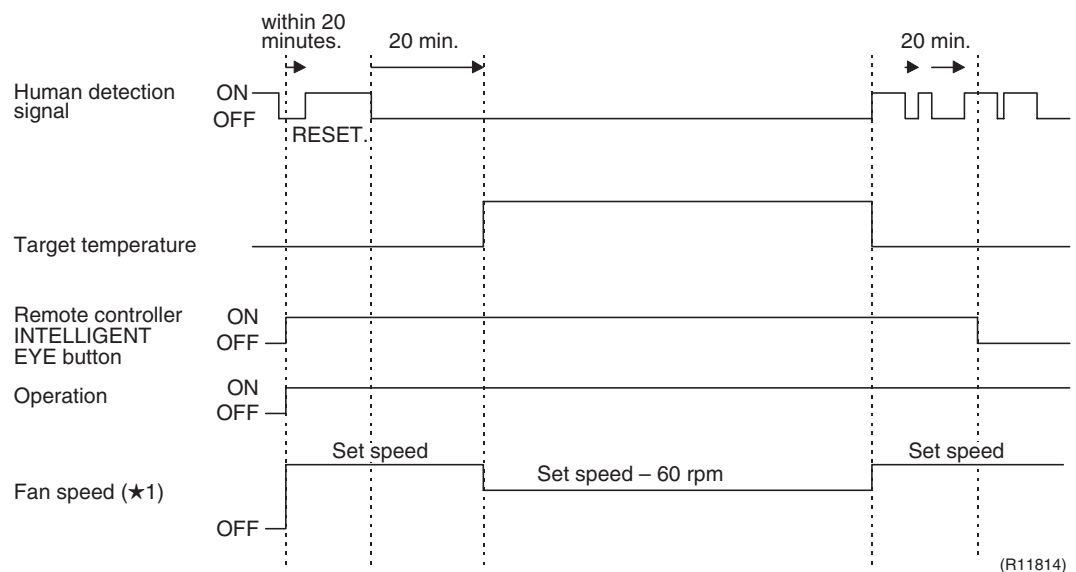

- When a microcomputer does not have a signal from the sensor in 20 minutes, it judges that nobody is in the room and operates the unit in the temperature shifted from the target temperature. (Cooling : 2°C higher, Dry : 1°C higher, Heating : 2°C lower, Auto : according to the operation mode at that time.)

★1 In case of FAN mode, the fan speed reduces by 60 rpm.

Others

- For dry operation, you cannot set the temperature with a remote controller, but internally the target temperature is shifted by 1°C.

1.11 Inverter POWERFUL Operation

Outline In order to exploit the cooling and heating capacity to full extent, operate the air conditioner by increasing the indoor fan rotating speed and the compressor frequency.

Detail When POWERFUL button is pressed, the fan speed and target temperature are converted to the following states for 20 minutes.

Operation mode	Fan speed	Target temperature
COOL	H tap + 50 rpm	18°C
DRY	Dry rotating speed + 50 rpm	Lowered by 2.5°C
HEAT	H tap + 50 rpm	31°C
FAN	H tap + 50 rpm	—
AUTO	Same as cooling / heating in POWERFUL operation	The target temperature is kept unchanged.

Ex.) : POWERFUL operation in cooling mode.

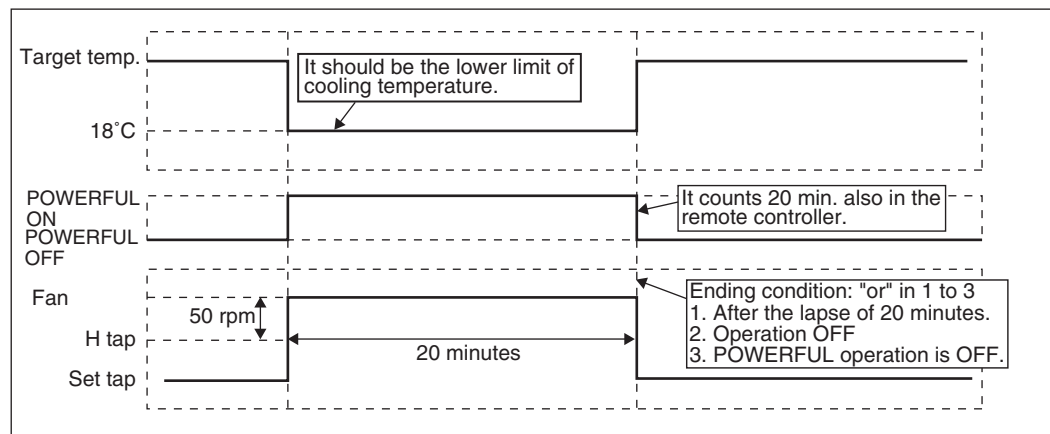

(R7096)

1.11.1 Multi-Colored Indicator Lamp / TIMER Lamp

Features Current operation mode is displayed in color of the lamp of the indoor unit. Operating status can be monitored even in automatic operation in accordance with the mode of actual operation.

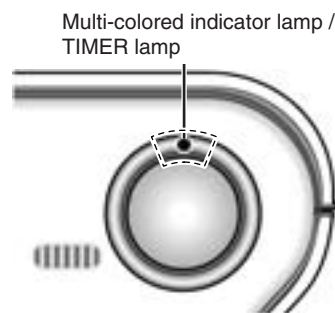

(R11815)

The lamp color changes according to the operation.

- * AUTO Red / Blue
- * DRY Green
- * COOL Blue
- * HEAT Red
- * FAN White
- * TIMER Orange

Brightness Setting

The brightness of the multi-colored indicator lamp can be adjusted L (low), H (high), or OFF.

1. Press the center of the Temp button and the Mode button at the same time.

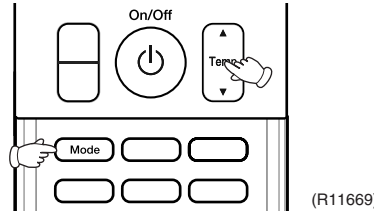

“5℃” is displayed on the LCD.

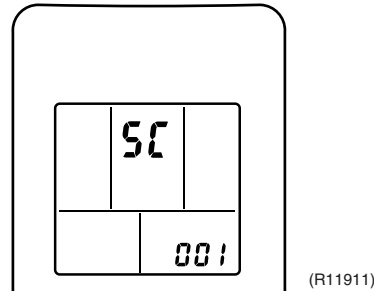

2. Select “L” (light) with the Temp ▲ or ▼ button.

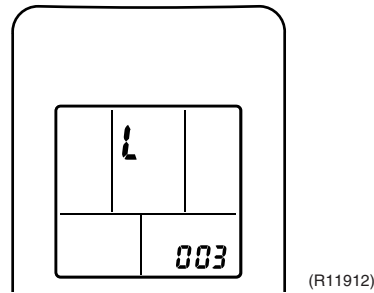

3. Press the Mode button to enter the brightness setting mode.
4. Press the Temp ▲ or ▼ button to adjust the brightness of the multi-colored indicator lamp.

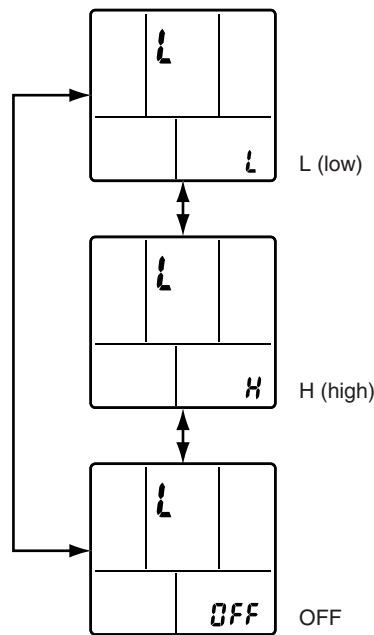

5. Press the Mode button for 5 seconds to exit from the brightness setting mode.
(When the remote controller is left untouched for 60 seconds, it returns to the normal mode also.)

1.12 Other Functions

1.12.1 Hot-Start Function

In order to prevent the cold air blast that normally comes when heating operation is started, the temperature of the indoor heat exchanger is detected, and either the airflow is stopped or is made very weak thereby carrying out comfortable heating of the room.

*The cold air blast is also prevented using a similar control when the defrosting operation is started or when the thermostat is turned ON.

1.12.2 Signal Receiving Sign

When the indoor unit receives a signal from the remote controller, the unit emits a signal receiving sound.

1.12.3 Indoor Unit ON/OFF Button

An ON/OFF button is provided on the display of the unit.

- Press this button once to start operation. Press once again to stop it.
- This button is useful when the remote controller is missing or the battery has run out.
- The operation mode refers to the following table.

Mode	Temperature setting	Airflow rate
AUTO	25°C	Automatic

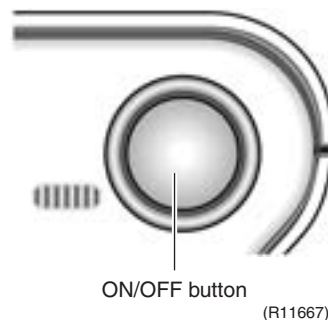

<Forced operation mode>

Forced operation mode can be started by pressing the ON/OFF button for 5 to 9 seconds while the unit is not operating.

Refer to "Forced operation mode" on page 41 for detail.



Note: When the ON/OFF button is pressed for 10 seconds or more, the forced operation is stopped.

1.12.4 Titanium Apatite Photocatalytic Air-Purifying Filter

This filter combines the Air-Purifying Filter and Titanium Apatite Photocatalytic Deodorizing Filter as a single highly effective filter. The filter traps microscopic particles, decompose odors and even deactivates bacteria and viruses. It lasts for 3 years without replacement if washed about once every 6 months.

1.12.5 Auto-restart Function

Even if a power failure (including one for just a moment) occurs during the operation, the operation restarts automatically when the power is restored in the same condition as before the power failure.



Note: It takes 3 minutes to restart the operation because the 3-minute standby function is activated.

1.12.6 WEEKLY TIMER Operation

Up to 4 timer settings can be saved for each day of the week (up to 28 settings in total). Those 3 items of "ON/OFF", "temperature" and "time" can be set.



Refer to "WEEKLY TIMER Operation" on page 60 for detail.

2. Function of Thermistor

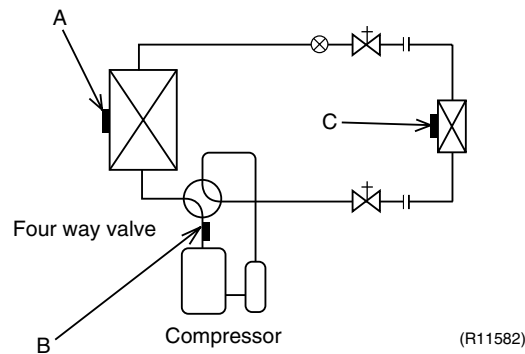

A Outdoor Heat Exchanger Thermistor

1. The outdoor heat exchanger thermistor is used for controlling target discharge pipe temperature. The system sets the target discharge pipe temperature according to the outdoor and indoor heat exchanger temperature, and controls the electronic expansion valve opening so that the target discharge pipe temperature can be obtained.
2. In cooling operation, the outdoor heat exchanger thermistor is used for detecting disconnection of the discharge pipe thermistor. When the discharge pipe temperature becomes lower than the outdoor heat exchanger temperature, the discharge pipe thermistor is judged as disconnected.
3. In cooling operation, the outdoor heat exchanger thermistor is used for high pressure protection.

B Discharge Pipe Thermistor

1. The discharge pipe thermistor is used for controlling discharge pipe temperature. If the discharge pipe temperature (used in place of the inner temperature of the compressor) rises abnormally, the operating frequency becomes lower or the operation halts.
2. The discharge pipe thermistor is used for detecting disconnection of the discharge pipe thermistor.

C Indoor Heat Exchanger Thermistor

1. The indoor heat exchanger thermistor is used for controlling target discharge pipe temperature. The system sets the target discharge pipe temperature according to the outdoor and indoor heat exchanger temperature, and controls the electronic expansion valve opening so that the target discharge pipe temperature can be obtained.
2. In cooling operation, the indoor heat exchanger thermistor is used for freeze-up protection control. If the indoor heat exchanger temperature drops abnormally, the operating frequency becomes lower or the operation halts.
3. In heating operation, the indoor heat exchanger thermistor is used for detecting disconnection of the discharge pipe thermistor. When the discharge pipe temperature becomes lower than the indoor heat exchanger temperature, the discharge pipe thermistor is judged as disconnected.

3. Control Specification

3.1 Mode Hierarchy

Outline There are two modes; the one is the normal operation mode and the other is the forced operation mode for installation and providing service.

Detail There are following modes; stop, cooling (includes drying), heating (include defrosting)

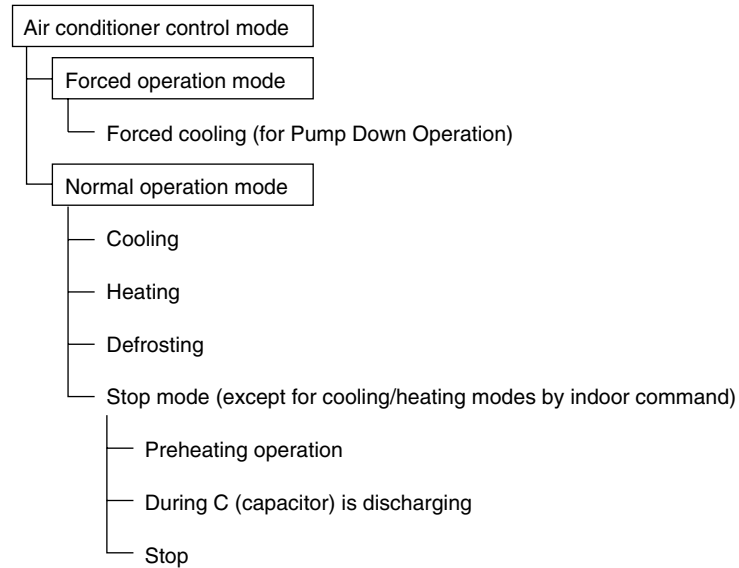

(R2829)



Note: Unless specified otherwise, an indoor dry operation command is regarded as cooling operation.

3.2 Frequency Control

Outline

Frequency is determined according to the difference between the room temperature and the target temperature.

The function is explained as follows.

1. How to determine frequency
2. Frequency command from the indoor unit (Difference between the room temperature and the target temperature)
3. Frequency initial setting
4. PI control

When the shift of the frequency is less than zero ($\Delta F < 0$) by PI control, the target frequency is used as the command frequency.

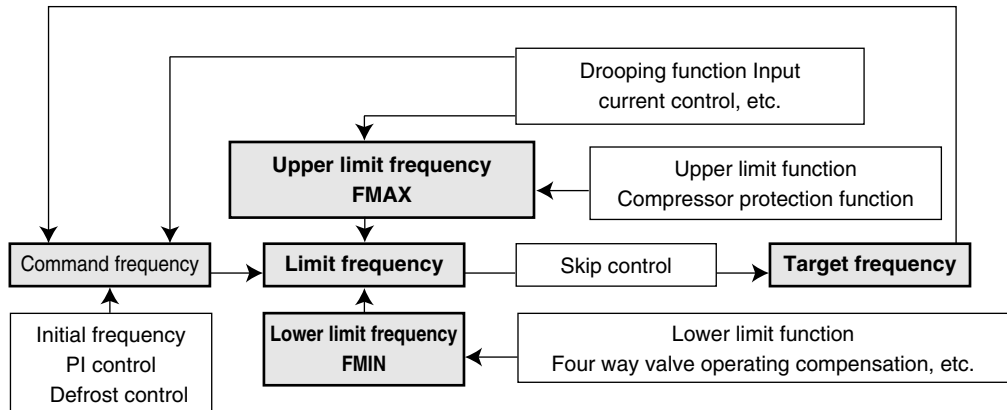

(R2831)

Detail

How to Determine Frequency

The compressor's frequency is determined by taking the following steps.

1. Determine command frequency

- ◆ Command frequency is determined in the following order of priority.

1. Limiting defrost control time
2. Forced cooling
3. Indoor frequency command

2. Determine upper limit frequency

- ◆ The minimum value is set as an upper limit frequency among the frequency upper limits of the following functions:

Compressor protection, input current, discharge pipe temperature, heating peak-cut, freeze-up protection, defrost.

3. Determine lower limit frequency

- ◆ The maximum value is set as a lower limit frequency among the frequency lower limits of the following functions:

Four way valve operation compensation, draft prevention, pressure difference upkeep.

4. Determine prohibited frequency

- ◆ There is a certain prohibited frequency such as a power supply frequency.

Indoor Frequency Command (ΔD signal)

The difference between the room temperature and the target temperature is taken as the “ ΔD signal” and is used for frequency command.

Temperature difference	ΔD signal	Temperature difference	ΔD signal	Temperature difference	ΔD signal	Temperature difference	ΔD signal
-2.0	*Th OFF	0	4	2.0	8	4.0	C
-1.5	1	0.5	5	2.5	9	4.5	D
-1.0	2	1.0	6	3.0	A	5.0	E
-0.5	3	1.5	7	3.5	B	5.5	F

*Th OFF = Thermostat OFF

Frequency Initial Setting**<Outline>**

When starting the compressor, the frequency is initialized according to the ΔD value and the Q value of the indoor unit.

Q value: Indoor unit output determined from indoor unit volume, airflow rate and other factors.

PI Control (Determine Frequency Up / Down by ΔD Signal)**1. P control**

The ΔD value is calculated in each sampling time (20 seconds), and the frequency is adjusted according to its difference from the frequency previously calculated.

2. I control

If the operating frequency does not change for more than a certain fixed time, the frequency is adjusted according to the ΔD value.

When the ΔD value is small, the frequency is lowered.

When the ΔD value is large, the frequency is increased.

3. Frequency management when other controls are functioning

- ◆ When frequency is drooping;
Frequency management is carried out only when the frequency droops.
- ◆ For limiting lower limit
Frequency management is carried out only when the frequency rises.

4. Upper and lower limit of frequency by PI control

The frequency upper and lower limits are set according to the command on indoor unit.

When the indoor or outdoor unit quiet operation command comes from the indoor unit, the upper limit frequency is lowered than the usual setting.

3.3 Controls at Mode Changing / Start-up

3.3.1 Preheating Operation

Outline The inverter operation in open phase starts with the conditions of the preheating command from the indoor unit, the outdoor temperature, and the discharge pipe temperature.

Detail Outdoor temperature $\geq 7^{\circ}\text{C}$ → Control A
Outdoor temperature $< 7^{\circ}\text{C}$ → Control B

Control A

- ◆ ON condition
Discharge pipe temperature $< 10^{\circ}\text{C}$
- ◆ OFF condition
Discharge pipe temperature $> 12^{\circ}\text{C}$
Radiation fin temperature $\geq 90^{\circ}\text{C}$

Control B

- ◆ ON condition
Discharge pipe temperature $< 20^{\circ}\text{C}$
- ◆ OFF condition
Discharge pipe temperature $> 22^{\circ}\text{C}$
Radiation fin temperature $\geq 90^{\circ}\text{C}$

3.3.2 Four Way Valve Switching

Outline In heating operation, current is conducted, and in cooling and defrosting, current is not conducted. In order to eliminate the switching sound when the heating is stopped, as the four way valve coil switches from ON to OFF, the OFF delay switch of the four way valve is carried out after the operation stopped.

Detail **OFF delay switch of four way valve:**
The four way valve coil is energized for 160 seconds after the operation is stopped.

3.3.3 Four Way Valve Operation Compensation

Outline At the beginning of the operation as the four way valve is switched, the differential pressure to activate the four way valve is acquired by having output frequency which is more than a certain fixed frequency, for a certain fixed time.

Detail **Starting Conditions**

1. When starting compressor for heating.
2. When the operation mode changes to cooling from heating.
3. When starting compressor for defrosting or resetting.
4. When starting compressor for the first time after the reset with the power is ON.
5. When starting compressor for heating next to the suspension of defrosting.
6. When starting compressor next to the fault of switching over cooling / heating.

Set the lower limit frequency A Hz for B seconds with any conditions 1 through 6 above.

	Cooling	Heating
A (Hz)	68	66
B (seconds)	45	

3.3.4 3-minute Standby

Turning on the compressor is prohibited for 3 minutes after turning it off.
(Except when defrosting.)

3.3.5 Compressor Protection Function

When turning the compressor from OFF to ON, the upper limit of frequency is set as follows.
(The function is not activated when defrosting.)

FCG 1	48	Hz
FCG 2	64	
FCG 3	88	
TCG 1	240	seconds
TCG 2	360	
TCG 3	180	

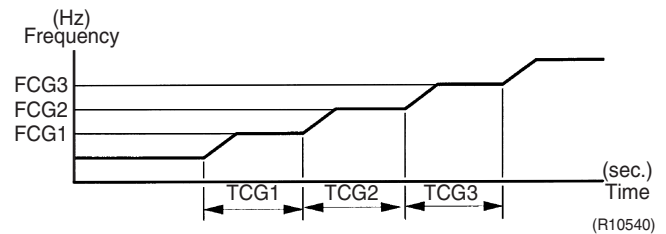

3.4 Discharge Pipe Temperature Control

Outline

The discharge pipe temperature is used as the internal temperature of the compressor. If the discharge pipe temperature rises above a certain level, the upper limit of frequency is set to keep this temperature from going up further.

Detail

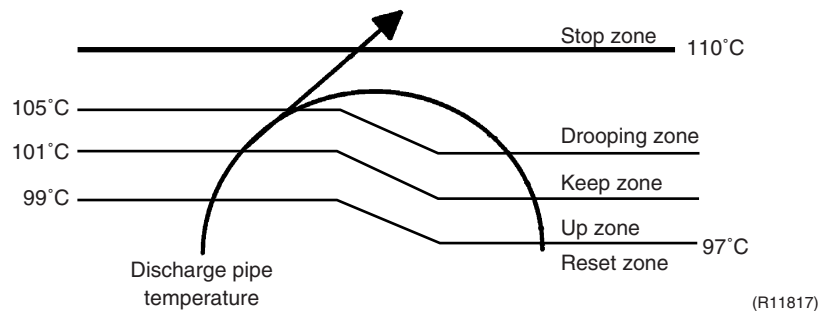

Zone	Control
Stop zone	When the temperature reaches the stop zone, the compressor stops.
Drooping zone	The timer starts, and the frequency is drooping.
Keep zone	The upper limit of frequency is kept.
Up zone	The upper limit of frequency is increased.
Reset zone	The upper limit of frequency is canceled.

3.5 Input Current Control

Outline

The microcomputer calculates the input current during the compressor is running, and sets the frequency upper limit from the input current.

In case of heat pump model, this control which is the upper limit control of the frequency takes priority to the lower limit of control of four way valve operation compensation.

Detail

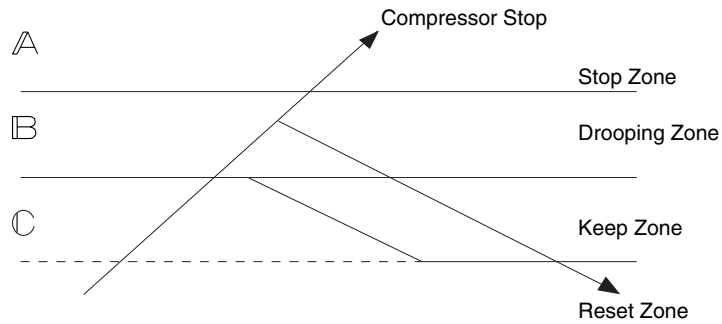

(R4304)

Frequency control in each zone

Stop zone

- After 2.5 seconds in this zone, the compressor is stopped.

Drooping zone

- The upper limit of the compressor frequency is defined as operation frequency – 2 Hz.
- After this, the output frequency is pulled down by 2 Hz every second until it reaches the keep zone.

Keep zone

- The present maximum frequency goes on.

Reset zone

- Limit of the frequency is canceled.

		25 class		35 class	
		Cooling	Heating	Cooling	Heating
A (A)		9.25		9.25	
B (A)	Normal mode	6.25	7.5	8.25	
	ECONO mode	3.25		3.25	
C (A)	Normal mode	5.5	6.75	7.5	
	ECONO mode	2.5		2.5	

Limitation of current drooping and stop value according to the outdoor temperature

- The current droops when outdoor temperature becomes higher than a certain level (model by model).

3.6 Freeze-up Protection Control

Outline During cooling operation, the signal sent from the indoor unit controls the operating frequency limitation and prevents freezing of the indoor heat exchanger. (The signal from the indoor unit is divided into zones.)

Detail The operating frequency limitation is judged with the indoor heat exchanger temperature.

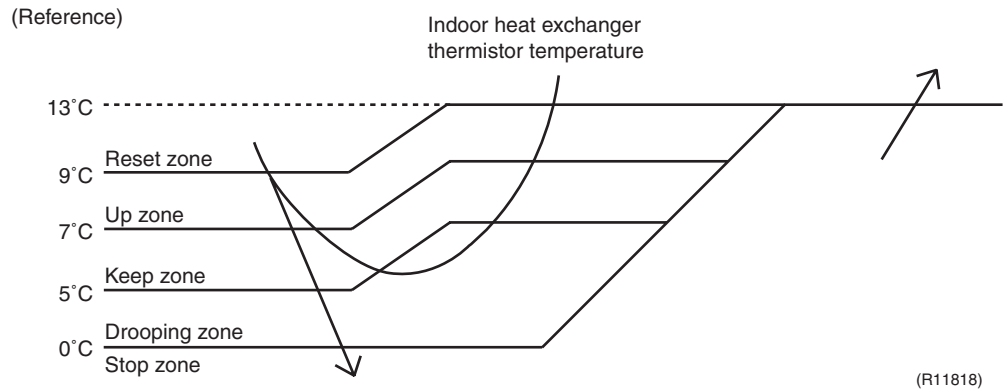

3.7 Heating Peak-cut Control

Outline During heating operation, the indoor heat exchanger temperature determines the frequency upper limit to prevent abnormal high pressure.

Detail

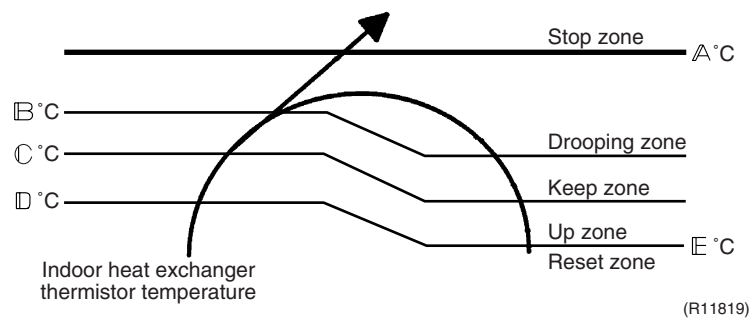

Zone	Control
Stop zone	When the temperature reaches the stop zone, the compressor stops.
Drooping zone	The timer starts, and the frequency is drooping.
Keep zone	The upper limit of frequency is kept.
Up zone	The upper limit of frequency is increased.
Reset zone	The upper limit of frequency is canceled.

A (°C)	65
B (°C)	56
C (°C)	53
D (°C)	51
E (°C)	46

3.8 Outdoor Fan Control

1. Fan OFF delay when stopped

The outdoor fan is turned OFF 60 seconds after the compressor stops.

2. Fan ON control to cool down the electrical box

The outdoor fan is turned ON when the electrical box temperature is high while the compressor is OFF.

3. Fan OFF control while defrosting

The outdoor fan is turned OFF while defrosting.

4. Fan ON/OFF control when operation starts / stops

The outdoor fan is turned ON when the operation starts. The outdoor fan is turned OFF when the operation stops.

5. Fan control while forced operation

The outdoor fan is controlled as well as normal operation while the forced operation.

6. Fan speed control while indoor / outdoor quiet operation

The rotation speed of the outdoor fan is reduced by the command of the indoor/outdoor quiet operation.

7. Fan control for POWERFUL operation

The rotation speed of the outdoor fan is increased while the POWERFUL operation.

8. Fan speed control for pressure difference upkeep

The rotation speed of the outdoor fan is controlled for keeping the pressure difference while cooling with low outdoor temperature.

- ◆ When the pressure difference is small, the rotation speed of the outdoor fan is reduced.
- ◆ When the pressure difference is large, the rotation speed of the outdoor fan is increased.

3.9 Liquid Compression Protection Function

Outline

In order to obtain the dependability of the compressor, the compressor is stopped according to the outdoor temperature and temperature of the outdoor heat exchanger.

Detail

- Operation stops depending on the outdoor temperature

Compressor turns off under the conditions that the system is in cooling operation and outdoor temperature is below -12°C .

3.10 Defrost Control

Outline

Defrosting is carried out by the cooling cycle (reverse cycle). The defrosting time or outdoor heat exchanger temperature must be more than a certain value to finish.

Detail

Conditions for Starting Defrost

- The starting conditions is determined with the outdoor temperature and the outdoor heat exchanger temperature.
- The system is in heating operation.
- The compressor operates for 6 minutes.
- More than 28 minutes of accumulated time pass since the start of the operation, or ending the previous defrosting.

Conditions for Canceling Defrost

The judgment is made with outdoor heat exchanger temperature. (4°C ~ 18°C)

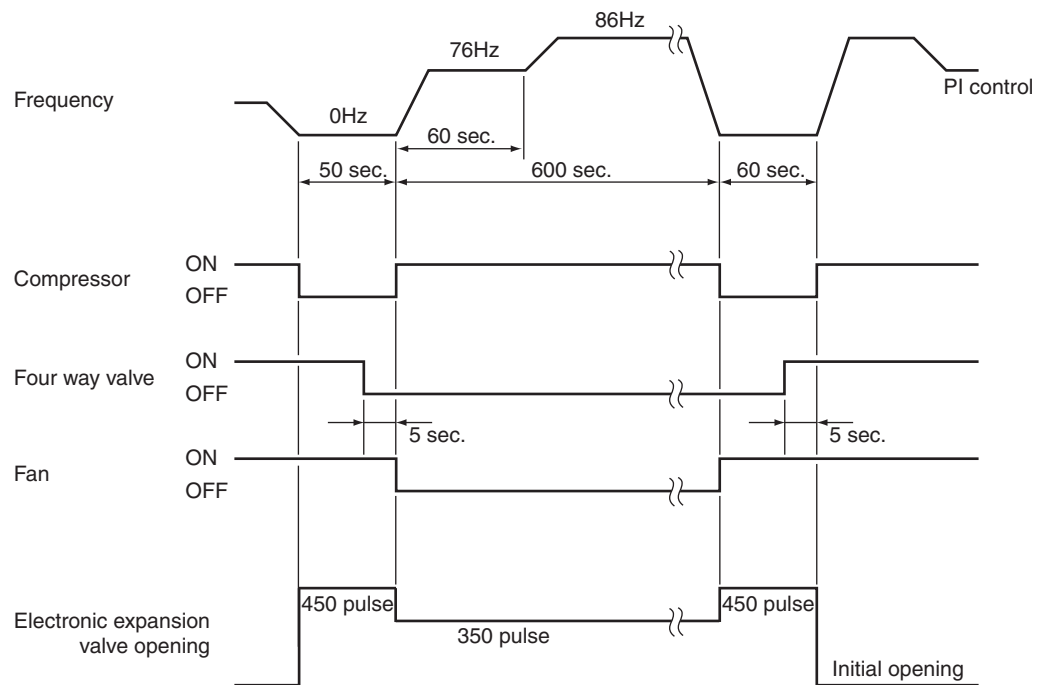

(R10724)

3.11 Electronic Expansion Valve Control

Outline

The following items are included in the electronic expansion valve control.

Electronic expansion valve is fully closed

1. Electronic expansion valve is fully closed when turning on the power.
2. Pressure equalizing control

Open Control

1. Electronic expansion valve control when starting operation
2. Electronic expansion valve control when frequency changed
3. Electronic expansion valve control for defrosting
4. Electronic expansion valve control when the discharge pipe temperature is abnormally high
5. Electronic expansion valve control when the discharge pipe thermistor is disconnected

Feedback Control

1. Discharge pipe temperature control

Detail

The followings are the examples of control which function in each mode by the electronic expansion valve control.

Operation pattern		Control when frequency changed	Control for abnormally high discharge pipe temperature	
When power is turned ON	○ : function × : not function	×	×	
↓		Fully closed when power is turned ON	×	×
Cooling operation		Open control when starting	×	○
↓		(Control of target discharge pipe temperature)	○	○
Stop		Pressure equalizing control	×	×
Heating operation		Open control when starting	×	○
↓		(Control of target discharge pipe temperature)	○	○
↓		Pressure equalizing control	×	×
Stop		Open control when starting	×	×
Heating operation		Continue	×	○
↓		Control of discharge pipe thermistor disconnection	×	×
Stop		Pressure equalizing control	×	×

(R2833)

3.11.1 Fully Closing with Power ON

The electronic expansion valve is initialized when turning on the power. The opening position is set and the pressure equalization is developed.

3.11.2 Pressure Equalization Control

When the compressor is stopped, the pressure equalization control is activated. The electronic expansion valve opens, and develops the pressure equalization.

3.11.3 Opening Limit

Outline

A maximum and minimum opening of the electronic expansion valve are limited.

Detail

- ◆ Maximum opening : 480 pulse
- ◆ Minimum opening : 52 pulse

The electronic expansion valve is fully closed when cooling operation stops, and is opened with fixed opening during defrosting.

3.11.4 Starting Operation Control

The electronic expansion valve opening is controlled when the operation starts, and prevents the superheating or liquid compression.

3.11.5 High Discharge Pipe Temperature

When the compressor is operating, if the discharge pipe temperature exceeds a certain value, the electronic expansion valve opens and the refrigerant runs to the low pressure side. This procedure lowers the discharge pipe temperature.

3.11.6 Disconnection of the Discharge Pipe Thermistor

Outline

The disconnection of the discharge pipe thermistor is detected by comparing the discharge pipe temperature with the condensation temperature. If the discharge pipe thermistor is disconnected, the electronic expansion valve opens according to the outdoor temperature and the operation frequency, and operates for a specified time, and then stops.

After 3 minutes of waiting, the operation restarts and checks if the discharge pipe thermistor is disconnected. If the discharge pipe thermistor is disconnected, the system stops after operating for a specified time.

If the disconnection is detected 5 times in succession, then the system is shut down. When the compressor runs for 60 minutes without any error, the error counter is reset.

Detail

When the starting control (cooling : 10 seconds, heating : 120 seconds) finishes, the detection timer for disconnection of the discharge pipe thermistor (810 seconds) starts. When the timer is over, the following adjustment is made.

1. When the operation mode is cooling

When the following condition is fulfilled, the discharge pipe thermistor disconnection is ascertained.

Discharge pipe temperature + 6°C < outdoor heat exchanger temperature

2. When the operation mode is heating

When the following condition is fulfilled, the discharge pipe thermistor disconnection is ascertained.

Discharge pipe temperature + 6°C < indoor heat exchanger temperature

Adjustment when the thermistor is disconnected

When the disconnection is ascertained, the compressor continues operation for 9 minutes and then stops.

When the compressor stops repeatedly, the system is shut down.

3.11.7 Control when frequency is changed

When the target discharge pipe temperature control is active, if the target frequency is changed for a specified value in a certain time period, the target discharge pipe temperature control is canceled and the target opening of the electronic expansion valve is changed according to the shift.

3.11.8 Target Discharge Pipe Temperature Control

The target discharge pipe temperature is obtained from the indoor and outdoor heat exchanger temperature, and the electronic expansion valve opening is adjusted so that the actual discharge pipe temperature becomes close to the target discharge pipe temperature. (Indirect SH (superheating) control using the discharge pipe temperature)

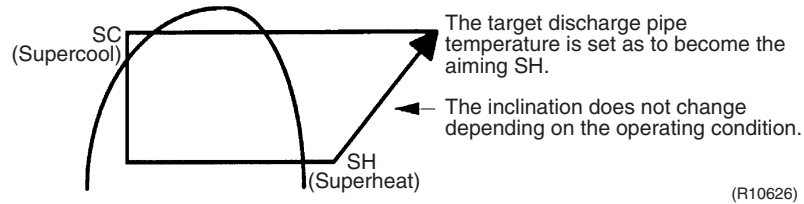

(R10626)

The electronic expansion valve opening and the target discharge pipe temperature are adjusted every 20 seconds. The target discharge pipe temperature is controlled by indoor heat exchanger temperature and outdoor heat exchanger temperature. The opening degree of the electronic expansion valve is controlled by followings.

- ◆ Target discharge pipe temperature
- ◆ Actual discharge pipe temperature
- ◆ Previous discharge pipe temperature

3.12 Malfunctions

3.12.1 Sensor Malfunction Detection

Sensor malfunction may occur in the thermistor.

Relating to Thermistor Malfunction

1. Outdoor heat exchanger thermistor
2. Discharge pipe thermistor
3. Radiation fin thermistor
4. Outdoor temperature thermistor

3.12.2 Detection of Overcurrent and Overload

Outline

An excessive output current is detected and, the OL temperature is observed to protect the compressor.

Detail

- If the OL (compressor head) temperature exceeds 120°C (depending on the model), the system shuts down the compressor.
- If the inverter current exceeds 9.25 A, the system shuts down the compressor.

3.12.3 Refrigerant Shortage Control

Outline

I Detecting by power consumption

If the power consumption is below the specified value and the frequency is higher than the specified frequency, it is regarded as refrigerant shortage.

The power consumption is small comparing with that in the normal operation when refrigerant is insufficient, and refrigerant shortage is detected by checking a power consumption.

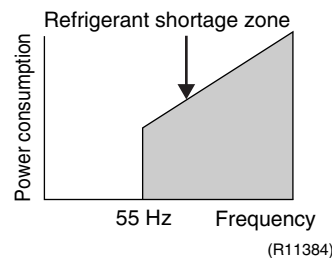

II Detecting by discharge pipe temperature

If the discharge pipe temperature is higher than the target discharge pipe temperature, and the electronic expansion valve is fully open for more than the specified time, it is regarded as refrigerant shortage.

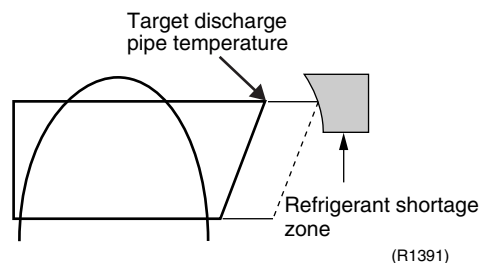

III Detecting by the difference of temperature

If the difference between suction and discharge temperature is smaller than the specified value, it is regarded as refrigerant shortage.



Refer to "Refrigerant shortage" on page 104 for detail.

3.13 Forced Operation Mode

Outline Forced operation mode includes only forced cooling.

Detail

Item	Forced Cooling
Conditions	1) The outdoor unit is not abnormal and not in the 3-minute standby mode.
	2) The outdoor unit is not operating.
	The forced operation is allowed when the above both conditions are met.
Start	1) Press the forced operation ON/OFF button (SW1) on the indoor unit for 5 seconds.
	2) Press the forced operation ON/OFF button (SW1) on the outdoor unit.
Command frequency	58 Hz
End	1) The operation ends automatically after 15 minutes.
	2) Press the forced operation ON/OFF button (SW1) on the indoor unit again.
	3) Press the ON/OFF button on the remote controller.
	4) Press the forced operation ON/OFF button (SW1) on the outdoor unit.
Others	The protection functions are prior to all others in the forced operation.

3.14 Standby Electricity Saving

Outline This function turns power supply OFF to the outdoor unit and sets the indoor unit into energy-saving mode, thus reducing the power consumption of the air conditioner.

Detail

- ◆ **Procedure for turning ON the standby electricity saving function**
 1. Check that the main power supply is turned OFF. Turn OFF if it has not been turned OFF.
 2. Remove the stop valve cover.
 3. Disconnect the selective connector for standby electricity saving.
 4. Turn ON the main power supply.

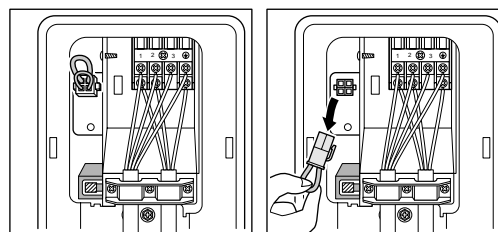

Function OFF

Function ON

The standby electricity saving function is turned OFF before shipping.

(R11820)



Caution

Before connecting or disconnecting the selective connector for standby electricity saving, make sure that the main power supply is turned OFF.

Part 5

Operation Manual

1. System Configuration.....	43
2. Operation Manual.....	44
2.1 Name of Parts	44
2.2 AUTO · DRY · COOL · HEAT · FAN Operation	48
2.3 Adjusting the Airflow Direction and Rate	50
2.4 COMFORT AIRFLOW Operation	52
2.5 INTELLIGENT EYE Operation	53
2.6 POWERFUL Operation	55
2.7 OUTDOOR UNIT QUIET Operation.....	56
2.8 ECONO Operation	57
2.9 OFF TIMER Operation	58
2.10 ON TIMER Operation.....	59
2.11 WEEKLY TIMER Operation	60

1. System Configuration

After the installation and test operation of the room air conditioner have been completed, it should be operated and handled as described below. Every user would like to know the correct method of operation of the room air conditioner, to check if it is capable of cooling (or heating) well, and to know a clever method of using it.

In order to meet this expectation of the users, giving sufficient explanations taking enough time can be said to reduce about 80% of the requests for servicing. However good the installation work is and however good the functions are, the customer may blame either the room air conditioner or its installation work because of improper handling. The installation work and handing over of the unit can only be considered to have been completed when its handling has been explained to the user without using technical terms but giving full knowledge of the equipment.

2. Operation Manual

2.1 Name of Parts

Name of Parts

Indoor Unit

- Appearance of the indoor unit may differ.

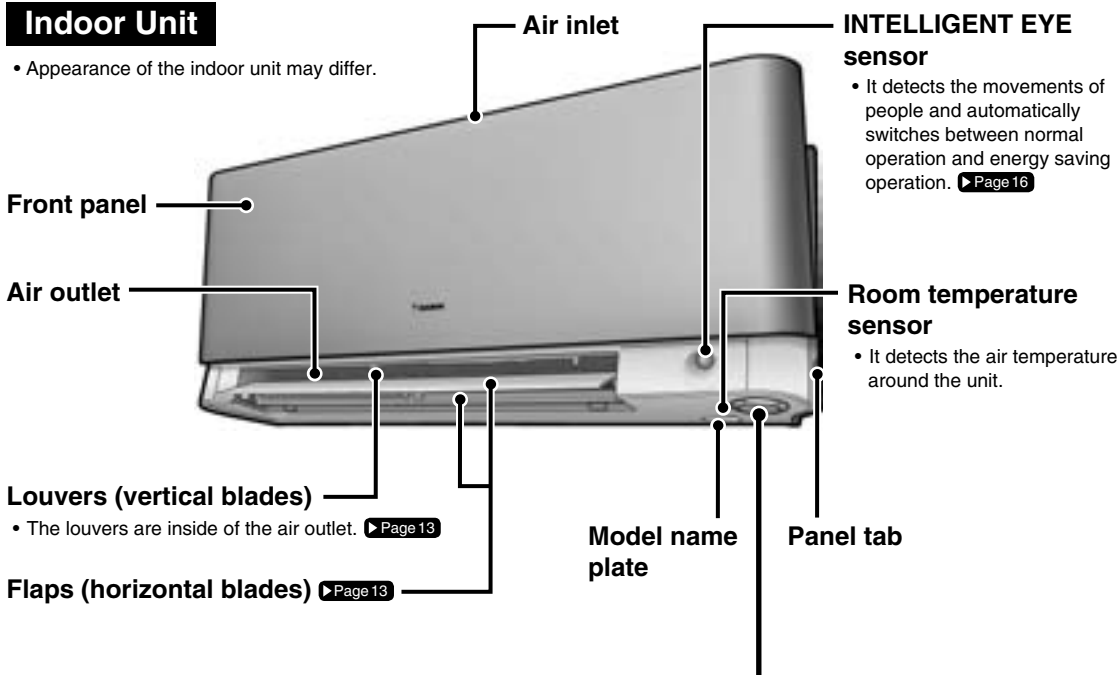

Display

INTELLIGENT EYE lamp (green) ▶Page 16

Signal receiver and Indoor unit ON/OFF switch

Signal receiver

- It receives signals from the remote controller.
- When the unit receives a signal, you will hear a beep sound.

Case	Sound type
Operation start	beep-beep
Setting changed	beep
Operation stop	long beep

Indoor unit ON/OFF switch

- Press this switch once to start operation. Press once again to stop it.
- The operation mode refer to the following table.

Mode	Temperature setting	Airflow rate
AUTO	25°C	AUTO

- This switch is useful when the remote controller is missing.

Multi-monitor lamp and TIMER lamp

Multi-monitor lamp

- The lamp colour changes according to the operation.

Operation	Multi-monitor lamp
AUTO	Red/Blue
DRY	Green
COOL	Blue
HEAT	Red
FAN	White
TIMER	Orange

TIMER lamp

- When operation by timer has been set, the multi-monitor lamp periodically changes to orange. After lighting orange for about 5 seconds, it returns to the colour of the operation mode. The multi-monitor lamp will turn orange on and off in cyclic manner while the air conditioner is not in operation.

TIMER lamp colour : For COOL

TIMER lamp colour

- DRY : Green → Orange
- COOL : Blue → Orange
- HEAT : Red → Orange
- FAN : White → Orange
- Stop : Off → Orange

■ Open the front panel

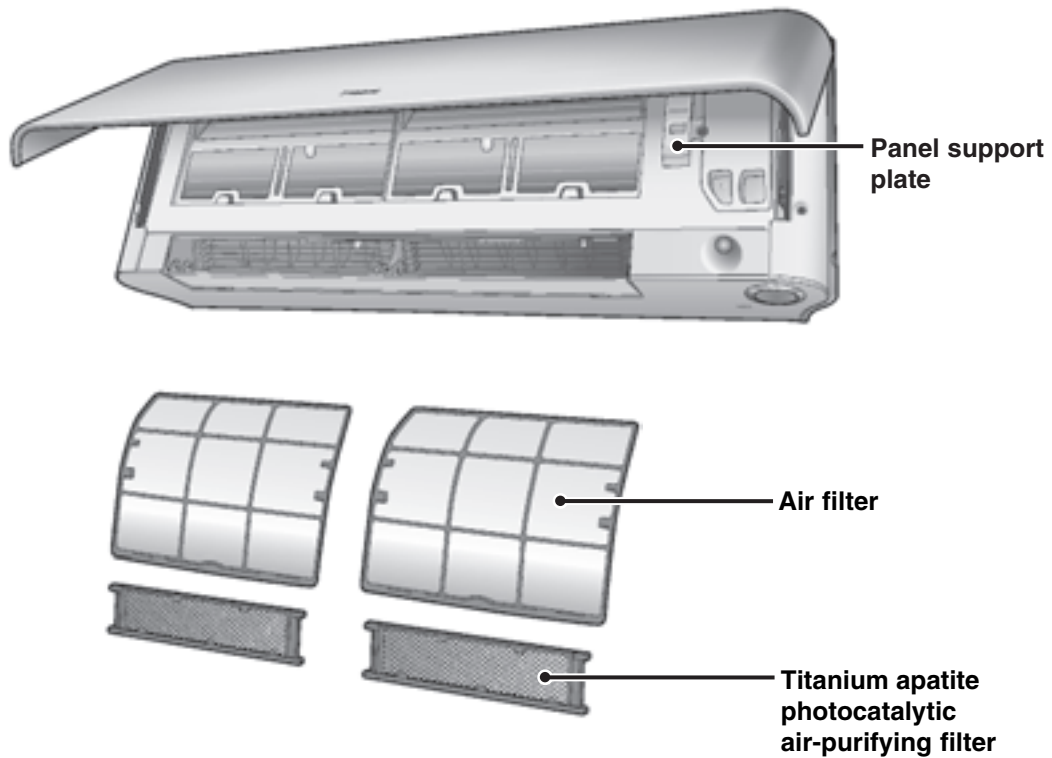

Outdoor Unit

- Appearance of the outdoor unit may differ from some models.

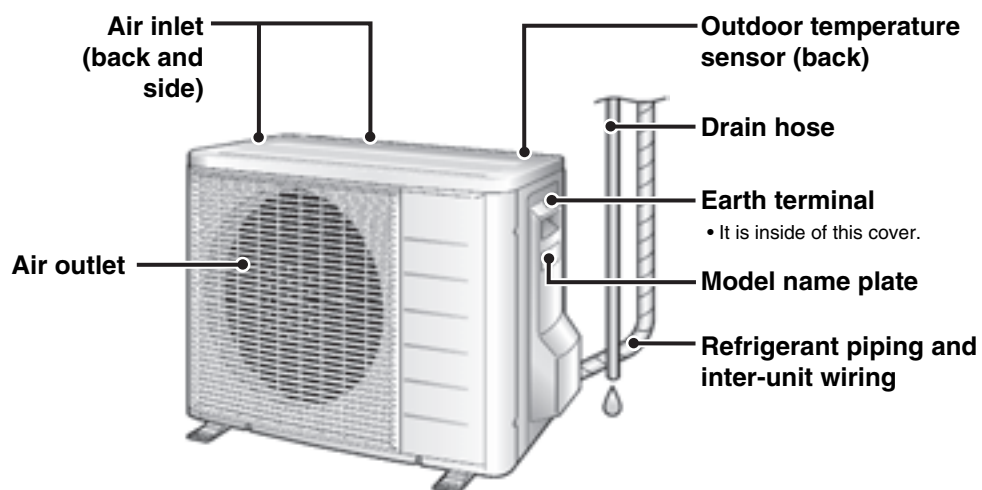

Name of Parts

Remote Controller

Signal transmitter

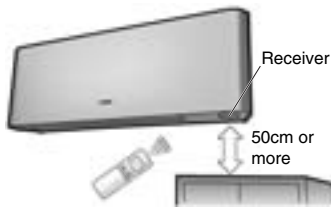

- To use the remote controller, aim the transmitter at the indoor unit. If there is anything to block signals between the unit and the remote controller, such as a curtain, the unit will not operate.
- Do not drop the remote controller. Do not get it wet.
- The maximum distance for communication is approx. 6m. Make sure that there are no obstacles within 50cm under the signal receiver. Such obstacles, if any, may have an adverse influence on the reception performance of the receiver and the reception distance may be shortened.

FAN setting button

- It selects the airflow rate setting. [▶ Page 14](#)

POWERFUL button

- POWERFUL operation. [▶ Page 18](#)

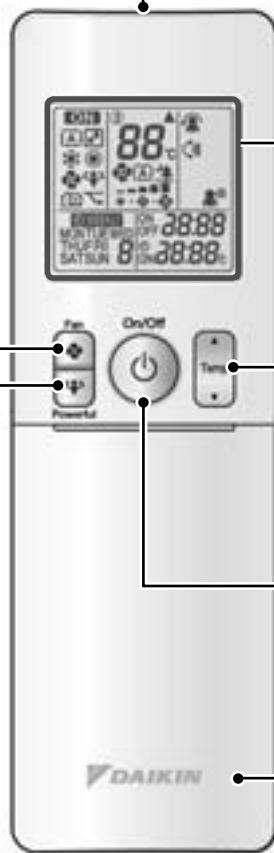

Display (LCD)

- It displays the current settings. (In this illustration, each section is shown with its displays on for the purpose of explanation.)

TEMPERATURE adjustment buttons

- It changes the temperature setting. [▶ Page 12](#)

ON/OFF button

- Press this button once to start operation. Press once again to stop it. [▶ Page 11](#)

Front cover

- Open the front cover. [▶ Page 8](#)

Model	ARC466A1
-------	----------

■ Open the front cover



MODE selector button

• It selects the operation mode.
(AUTO/DRY/COOL/HEAT/
FAN) ▶Page 11

ECONO button

• ECONO operation. ▶Page 20

SWING button

• Adjusting the airflow direction.
▶Page 13

QUIET button

• OUTDOOR UNIT QUIET
operation. ▶Page 19

COMFORT button

• COMFORT AIRFLOW
operation. ▶Page 15

**INTELLIGENT EYE
button**

• INTELLIGENT EYE
operation. ▶Page 16

OFF TIMER button

▶Page 21

**TIMER CANCEL
button**

• It cancels the timer setting.
▶Page 21,22
• It cannot be used for the
WEEKLY TIMER operation.

Weekly

◀ : WEEKLY button

⬆ : PROGRAM button

Copy

▶ : COPY button

Back

▶ : BACK button

Next

▶ : NEXT button

• WEEKLY TIMER operation.
▶Page 23

SELECT button

• It changes the ON/OFF
TIMER and WEEKLY TIMER
settings. ▶Page 21,22,23

ON TIMER button

▶Page 22

CLOCK button

2.2 AUTO · DRY · COOL · HEAT · FAN Operation



AUTO · DRY · COOL · HEAT · FAN Operation



The air conditioner operates with the operation mode of your choice. From the next time on, the air conditioner will operate with the same operation mode.

■ To start operation

1. Press **Mode** and select a operation mode.

- Each pressing of the button advances the mode setting in sequence.

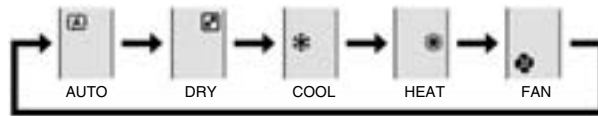

2. Press .

- “**ON**” is displayed on the LCD.
- The multi-monitor lamp lights up. The colour of the lamp varies depending on the operation mode.

Operation	Multi-monitor lamp
AUTO	Red/Blue
DRY	Green
COOL	Blue
HEAT	Red
FAN	White

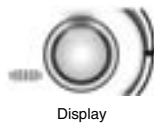

■ To stop operation

Press  again.

- “**ON**” disappears from the LCD.
- The multi-monitor lamp goes off.

NOTE

MODE	Notes on each operation mode
HEAT	<ul style="list-style-type: none"> • Since this air conditioner heats the room by taking heat from outdoor air to indoors, the heating capacity becomes smaller in lower outdoor temperatures. If the heating effect is insufficient, it is recommended to use another heating appliance in combination with the air conditioner. • The heat pump system heats the room by circulating hot air around all parts of the room. After the start of HEAT operation, it takes some time before the room gets warmer. • In HEAT operation, frost may occur on the outdoor unit and lower the heating capacity. In that case, the system switches into defrosting operation to take away the frost. • During defrosting operation, hot air does not flow out of indoor unit.
COOL	<ul style="list-style-type: none"> • This air conditioner cools the room by blowing the hot air in the room outside, so if the outside temperature is high, the performance of the air conditioner drops.
DRY	<ul style="list-style-type: none"> • The computer chip works to rid the room of humidity while maintaining the temperature as much as possible. It automatically controls temperature and airflow rate, so manual adjustment of these functions is unavailable.
AUTO	<ul style="list-style-type: none"> • In AUTO operation, the system selects a temperature setting and an appropriate operation mode (COOL or HEAT) based on the room temperature at the start of the operation. • The system automatically reselects setting at a regular interval to bring the room temperature to user-setting level.
FAN	<ul style="list-style-type: none"> • This mode is valid for fan only.



■ To change the temperature setting

Press .

- The displayed items on the LCD will change whenever either one of the buttons is pressed.

COOL operation	HEAT operation	AUTO operation	DRY or FAN operation
18-32°C	10-30°C	18-30°C	The temperature setting is not variable.
Press ▲ to raise the temperature and press ▼ to lower the temperature.			

■ Operating conditions

■ Recommended temperature setting

- For cooling: 26-28°C
- For heating: 20-24°C

■ Tips for saving energy

- Be careful not to cool (heat) the room too much.
Keeping the temperature setting at a moderate level helps save energy.
- Cover windows with a blind or a curtain.
Blocking sunlight and air from outdoors increases the cooling (heating) effect.
- Clogged air filters cause inefficient operation and waste energy. Clean them once in about every 2 weeks.

■ Notes on the operating conditions

- The outdoor unit consumes some power to have its electric components work even while it is not operating.
Connecting outdoor unit RXG25/35: 1-15W
Other outdoor units: 15-20W
The outdoor unit consumes 40 to 55W of power at the time of compressor preheating.
- If you are not going to use the air conditioner for a long period, for example in spring or autumn, turn the breaker off.
- Use the air conditioner in the following conditions.

MODE	Operating conditions	If operation is continued out of this range
COOL	Outdoor temperature : <2/3/4/5MXS> -10-46°C <RXG> -10-46°C Indoor temperature : 18-32°C Indoor humidity : 80% max.	<ul style="list-style-type: none"> • A safety device may work to stop the operation. (In multi system, it may work to stop the operation of the outdoor unit only.) • Condensation may occur on the indoor unit and drip.
HEAT	Outdoor temperature : <2MXS> -10-24°C <3/4/5MXS> -15-24°C <RXG> -15-24°C Indoor temperature : 10-30°C	<ul style="list-style-type: none"> • A safety device may work to stop the operation.
DRY	Outdoor temperature : <2/3/4/5MXS> -10-46°C <RXG> -10-46°C Indoor temperature : 18-32°C Indoor humidity : 80% max.	<ul style="list-style-type: none"> • A safety device may work to stop the operation. • Condensation may occur on the indoor unit and drip.

- Operation outside this humidity or temperature range may cause a safety device to disable the system.

2.3 Adjusting the Airflow Direction and Rate



Adjusting the Airflow Direction and Rate



You can adjust the airflow direction to increase your comfort.

■ To start auto swing

Upper and lower airflow direction

Press  **Swing**.

- “” is displayed on the LCD.
- The flaps (horizontal blades) will begin to swing.



■ To set the flaps at desired position

- This function is effective while flaps are in auto swing mode.

Press  **Swing** when the flaps have reached the desired position.

- “” disappears from the LCD.

■ To adjust the louvers at desired position

Hold the knob and move the louvers.

- You will find a knob on the left-side and the right-side blades.
- When the unit is installed in the corner of a room, the direction of the louvers (vertical blades) should be facing away from the wall.

If they face the wall, the wall will block off the wind, causing the cooling (or heating) efficiency to drop.

- If the flaps are in the way, press  on the remote controller to move the flaps out of the way and then adjust the louvers.







■ To adjust the airflow rate setting

Press .

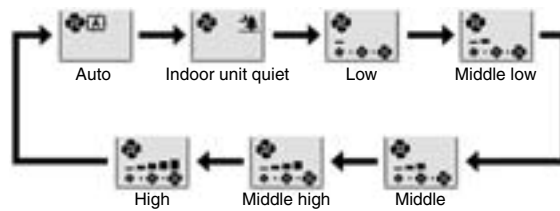
- Each pressing of  advances the airflow rate setting in sequence.



- When the airflow is set to “”, indoor unit quiet operation will start and the noise from the unit will become quieter.
- In indoor unit quiet operation, the airflow rate is set to a weak level.
- In DRY mode, the airflow rate setting is not variable.

NOTE

■ Note on the angles of the flaps

- The flaps swinging range depends on the operation. (See the figure.)

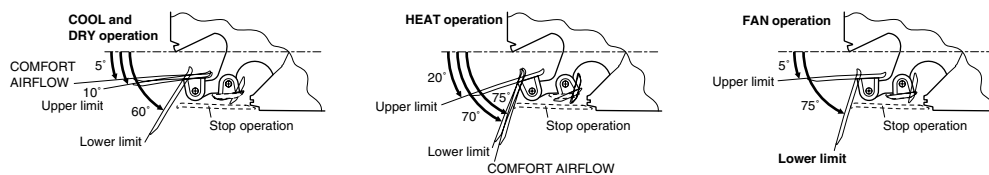

■ Note on airflow rate setting

- At smaller airflow rates, the cooling (heating) effect is also smaller.
- If the air conditioner is operated in COOL or DRY operation with the flaps kept stopped in the downward direction, the flaps will automatically start operating in approximately an hour in order to prevent dew condensation.

CAUTION

- Always use a remote controller to adjust the angles of the flaps. If you attempt to move it forcibly with hand when it is swinging, the mechanism may be broken.
- Be careful when adjusting the louvers.
Inside the air outlet, a fan is rotating at a high speed.

2.4 COMFORT AIRFLOW Operation



COMFORT AIRFLOW Operation



The flow of air will be in the upward direction while in COOL operation and in the downward direction while in HEAT operation, which will provide a comfortable wind that will not come in direct contact with people.

■ To start COMFORT AIRFLOW operation

Press .

- “” is displayed on the LCD.
- Airflow rate is set to Auto.
COOL/DRY: The flaps will go up.
HEAT: The flaps will go down.

■ To cancel COMFORT AIRFLOW operation

Press  again.

- The flaps will return to the memory position from before COMFORT AIRFLOW operation.
- “” disappears from the LCD.



COOL operation



HEAT operation

NOTE

■ Notes on COMFORT AIRFLOW operation

- The flaps position will change, preventing air from blowing directly on the occupants of the room.
- POWERFUL operation and COMFORT AIRFLOW operation cannot be used at the same time.
Priority is given to the function of whichever button is pressed last.
- The airflow rate will be set to Auto. If the upper and lower airflow direction is selected, the COMFORT AIRFLOW operation will be canceled.

2.5 INTELLIGENT EYE Operation



INTELLIGENT EYE Operation



“INTELLIGENT EYE” is the infrared sensor which detects the human movement. If nobody in the room for more than 20 minutes, the operation automatically changes to energy saving operation.

■ To start INTELLIGENT EYE operation

Press .

- “” is displayed on the LCD.
- The INTELLIGENT EYE lamp lights up.

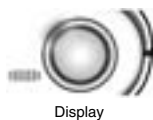

Display

■ To cancel INTELLIGENT EYE operation

Press  again.

- “” disappears from the LCD.
- The INTELLIGENT EYE lamp goes off.



INTELLIGENT EYE Operation

[Example]

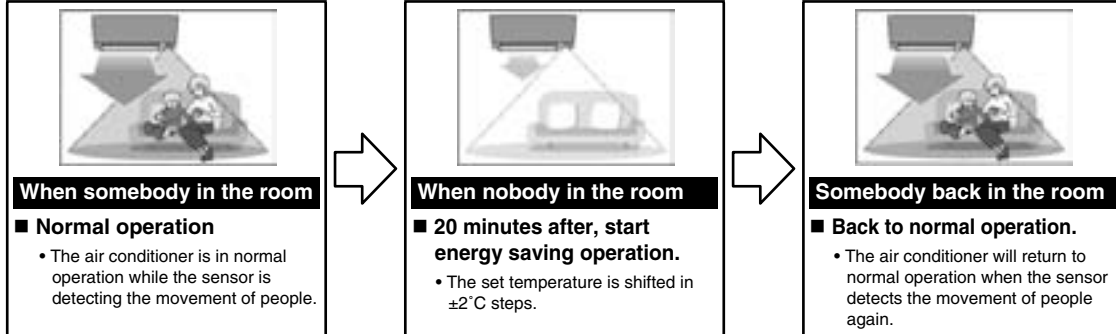

INTELLIGENT EYE operation is useful for energy saving

- **Energy saving operation**
 - If no presence detected in the room for 20 minutes, the energy saving operation will start.
 - This operation changes the temperature -2°C in HEAT / $+2^{\circ}\text{C}$ in COOL / $+1^{\circ}\text{C}$ in DRY operation from set temperature.
 - This operation decreases the airflow rate slightly in FAN operation only.

NOTE

■ **Notes on INTELLIGENT EYE operation**

- Application range is as follows.

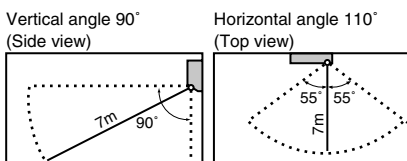

- Sensor may not detect moving objects further than 7m away. (Check the application range.)
- Sensor detection sensitivity changes according to indoor unit location, the speed of passersby, temperature range, etc.
- The sensor also mistakenly detects pets, sunlight, fl uttering curtains and light refl ected off of mirrors as passersby.
- INTELLIGENT EYE operation will not go on during POWERFUL operation.
- NIGHT SET mode [▶Page21](#) will not go on during use of INTELLIGENT EYE operation.

CAUTION

- Do not place large objects near the sensor.
Also keep heating units or humidifiers outside the sensor's detection area. This sensor can detect undesirable objects.
- Do not hit or violently push the INTELLIGENT EYE sensor. This can lead to damage and malfunction.

2.6 POWERFUL Operation



POWERFUL Operation



POWERFUL operation quickly maximizes the cooling (heating) effect in any operation mode. You can get the maximum capacity.

■ To start POWERFUL operation

Press  during operation.

- POWERFUL operation ends in 20 minutes. Then the system automatically operates again with the previous settings which were used before POWERFUL operation.
- “” is displayed on the LCD.

■ To cancel POWERFUL operation

Press  again.

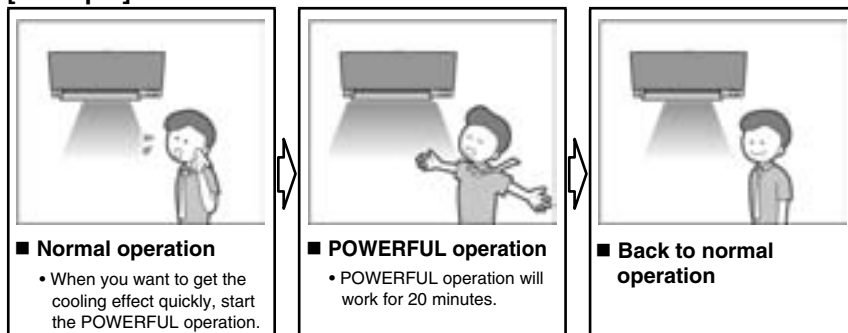

- “” disappears from the LCD.

[Example]



NOTE

■ Notes on POWERFUL operation

- When using POWERFUL operation, there are some functions which are not available.
- POWERFUL operation cannot be used together with ECONO, COMFORT AIRFLOW or OUTDOOR UNIT QUIET operation. Priority is given to the function of whichever button is pressed last.
- POWERFUL operation can only be set when the unit is running. Pressing  causes the settings to be canceled, and the “” disappears from the LCD.
- POWERFUL operation will not increase the capacity of the air conditioner if the air conditioner is already in operation with its maximum capacity demonstrated.
- **In COOL and HEAT operation**
To maximize the cooling (heating) effect, the capacity of outdoor unit must be increased and the airflow rate be fixed to the maximum setting. The temperature and airflow settings are not variable.
- **In DRY operation**
The temperature setting is lowered by 2.5°C and the airflow rate is slightly increased.
- **In FAN operation**
The airflow rate is fixed to the maximum setting.
- **In AUTO operation**
To maximize the cooling (heating) effect, the capacity of outdoor unit must be increased and the airflow rate be fixed to the maximum setting.

2.7 OUTDOOR UNIT QUIET Operation



OUTDOOR UNIT QUIET Operation



OUTDOOR UNIT QUIET operation lowers the noise level of the outdoor unit by changing the frequency and fan speed on the outdoor unit. This function is convenient during the night.

■ To start OUTDOOR UNIT QUIET operation

Press .

- “” is displayed on the LCD.

■ To cancel OUTDOOR UNIT QUIET operation

Press  again.

- “” disappears from the LCD.

[Example] Using the OUTDOOR UNIT QUIET operation during the night.



- The noise level of the outdoor unit will be lower.
This is convenient when you need to consideration for your neighborhood.

NOTE

■ Notes on OUTDOOR UNIT QUIET operation

- This function is available in COOL, HEAT, and AUTO operation.
This is not available in FAN and DRY operation.
- POWERFUL operation and OUTDOOR UNIT QUIET operation cannot be used at the same time.
Priority is given to the function of whichever button is pressed last.
- Even the operation is stopped using the remote controller or the indoor unit ON/OFF switch when using OUTDOOR UNIT QUIET operation, “” will remain on the remote controller display.
- OUTDOOR UNIT QUIET operation will drop neither the frequency nor fan speed if they have been already dropped low enough.

2.8 ECONO Operation



ECONO Operation



ECONO operation is a function which enables efficient operation by limiting the maximum power consumption value.

This function is useful for cases in which attention should be paid to ensure a circuit breaker will not trip when the product runs alongside other appliances.

■ To start ECONO operation

Press  during operation.

- “” is displayed on the LCD.

■ To cancel ECONO operation

Press  again.

- “” disappears from the LCD.

[Example]

Normal operation



- In case the air conditioner and other appliances which require high power consumption are used at same time, a circuit breaker may trip if the air conditioner operate with its maximum capacity.

ECONO operation



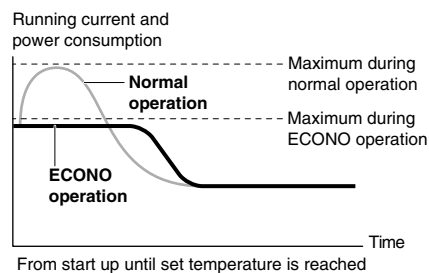

- The maximum power consumption of the air conditioner is limited by using ECONO operation. The circuit breaker will hardly trip even if the air conditioner and other appliances are used at same time.



- This diagram is a representation for illustrative purposes only. The maximum running current and power consumption of the air conditioner in ECONO operation vary with the connecting outdoor unit.

NOTE

■ Notes on ECONO operation

- ECONO operation can only be set when the unit is running. Pressing  causes the settings to be canceled, and the “” disappears from the LCD.
- ECONO operation is a function which enables efficient operation by limiting the power consumption of the outdoor unit (operating frequency).
- ECONO operation functions in AUTO, COOL, DRY, and HEAT operation.
- POWERFUL and ECONO operation cannot be used at the same time. Priority is given to the function of whichever button is pressed last.
- If the level of power consumption is already low, ECONO operation will not drop the power consumption.

2.9 OFF TIMER Operation



OFF TIMER Operation



Timer functions are useful for automatically switching the air conditioner on or off at night or in the morning. You can also use OFF TIMER and ON TIMER in combination.

■ To use OFF TIMER operation

- Check that the clock is correct.
If not, set the clock to the present time.

1. Press .



- "0:00" is displayed on the LCD.
- "OFF" blinks.

- "⊕" and day of the week disappear from the LCD.

2. Press until the time setting reaches the point you like.

- Each pressing of either button increases or decreases the time setting by 10 minutes.
Holding down either button changes the time setting rapidly.

3. Press again.

- "OFF" and setting time are displayed on the LCD.
- The multi-monitor lamp blinks twice.

The TIMER lamp periodically lights orange. [▶Page 5](#)

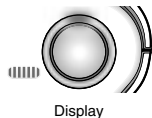

■ To cancel OFF TIMER operation

Press .

- "OFF" and setting time disappear from the LCD.
- "⊕" and day of the week are displayed on the LCD.

NOTE

■ Notes on TIMER operation

- When TIMER is set, the present time is not displayed.
- Once you set ON/OFF TIMER, the time setting is kept in the memory. The memory is canceled when remote controller batteries are replaced.
- When operating the unit via the ON/OFF TIMER, the actual length of operation may vary from the time entered by the user. (Maximum approx. 10 minutes)

■ NIGHT SET mode

- When the OFF TIMER is set, the air conditioner automatically adjusts the temperature setting (0.5°C up in COOL, 2.0°C down in HEAT) to prevent excessive cooling (heating) for your pleasant sleep.

2.10 ON TIMER Operation



ON TIMER Operation



■ To use ON TIMER operation

- Check that the clock is correct.
If not, set the clock to the present time.

1. Press .

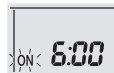

- “6:00” is displayed on the LCD.
- “ON” blinks.

- “⊕” and day of the week disappear from the LCD.

2. Press until the time setting reaches the point you like.

- Each pressing of either button increases or decreases the time setting by 10 minutes.
Holding down either button changes the setting rapidly.

3. Press again.

- “ON” and setting time are displayed on the LCD.
- The multi-monitor lamp blinks twice.
The TIMER lamp periodically lights orange. ▶ Page 5



Display

■ To cancel ON TIMER operation

Press .

- “ON” and setting time disappear from the LCD.
- “⊕” and day of the week are displayed on the LCD.

■ To combine ON TIMER and OFF TIMER

- A sample setting for combining the 2 timers is shown below.

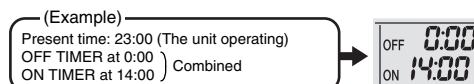

NOTE

- In the following cases, set the timer again.
 - After a breaker has turned off.
 - After a power failure.
 - After replacing batteries in the remote controller.

2.11 WEEKLY TIMER Operation



WEEKLY TIMER Operation

Up to 4 timer settings can be saved for each day of the week. It is convenient if the WEEKLY TIMER is set according to the family's life style.

■ Using in these cases of WEEKLY TIMER

Example: The same timer settings are made for the week from Monday through Friday while different timer settings are made for the weekend.

<p>[Monday]</p>	<p>Make timer settings up to programs 1-4. ▶Page24</p> <div style="display: flex; justify-content: space-around;"> <div style="text-align: center;"> <p>Program 1</p> <p>ON</p> <p>25°C</p> <p>6:00 — 8:30</p> </div> <div style="text-align: center;"> <p>Program 2</p> <p>OFF</p> <p>8:30</p> </div> <div style="text-align: center;"> <p>Program 3</p> <p>ON</p> <p>17:30</p> <p>27°C</p> </div> <div style="text-align: center;"> <p>Program 4</p> <p>OFF</p> <p>22:00</p> </div> </div>
<p>[Tuesday] to [Friday]</p>	<p>Use the copy mode to make settings for Tuesday to Friday, because these settings are the same as those for Monday. ▶Page26</p> <div style="display: flex; justify-content: space-around;"> <div style="text-align: center;"> <p>Program 1</p> <p>ON</p> <p>25°C</p> <p>6:00 — 8:30</p> </div> <div style="text-align: center;"> <p>Program 2</p> <p>OFF</p> <p>8:30</p> </div> <div style="text-align: center;"> <p>Program 3</p> <p>ON</p> <p>17:30</p> <p>27°C</p> </div> <div style="text-align: center;"> <p>Program 4</p> <p>OFF</p> <p>22:00</p> </div> </div>
<p>[Saturday]</p>	<p>No timer settings</p>
<p>[Sunday]</p>	<p>Make timer settings up to programs 1-4. ▶Page24</p> <div style="display: flex; justify-content: space-around;"> <div style="text-align: center;"> <p>Program 1</p> <p>ON</p> <p>25°C</p> <p>8:00 — 10:00</p> </div> <div style="text-align: center;"> <p>Program 2</p> <p>OFF</p> <p>10:00</p> </div> <div style="text-align: center;"> <p>Program 3</p> <p>OFF</p> <p>19:00</p> <p>27°C</p> </div> <div style="text-align: center;"> <p>Program 4</p> <p>ON</p> <p>21:00</p> <p>27°C</p> </div> </div>

- Up to 4 reservations per day and 28 reservations per week can be set in the WEEKLY TIMER. The effective use of the copy mode ensures ease of making reservations.
- The use of ON-ON-ON-ON settings, for example, makes it possible to schedule operating mode and set temperature changes. Furthermore, by using OFF-OFF-OFF-OFF settings, only the turn off time of each day can be set. This will turn off the air conditioner automatically if the user forgets to turn it off.



■ To use WEEKLY TIMER operation

Setting mode

- Make sure the day of the week and time are set. If not, set the day of the week and time.

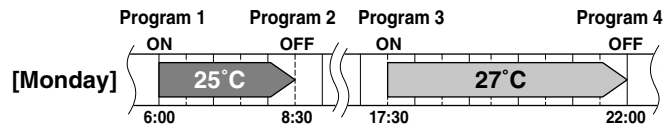

Setting Displays

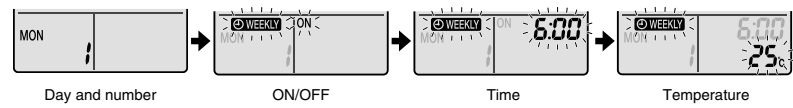

1. Press .

- The day of the week and the reservation number of the current day will be displayed.
- 1 to 4 settings can be made per day.

2. Press to select the desired day of the week and reservation number.

- Pressing  changes the reservation number and the day of the week.

3. Press .

- The day of the week and reservation number will be set.
- "WEEKLY" and "ON" blink.

4. Press to select the desired mode.

- Pressing  changes "ON" or "OFF" setting in sequence.

Pressing  alternates the following items appearing on the LCD in rotational sequence.

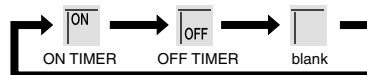

- In case the reservation has already been set, selecting "blank" deletes the reservation.
- Go to step 9 if "blank" is selected.
- To return to the day of the week and reservation number setting, press .

5. Press .

- The ON/OFF TIMER mode will be set.
- "WEEKLY" and the time blink.



WEEKLY TIMER Operation



6. Press to select the desired time.

- The time can be set between 0:00 and 23:50 in 10 minute intervals.
- To return to the ON/OFF TIMER mode setting, press .
- Go to step 9 when setting the OFF TIMER.

7. Press .

- The time will be set.
- “ WEEKLY” and the temperature blink.

8. Press to select the desired temperature.

- The temperature can be set between 10°C and 32°C.
COOL or AUTO: The unit operates at 18°C even if it is set at 10 to 17°C.
HEAT or AUTO: The unit operates at 30°C even if it is set at 31 to 32°C.
- To return to the time setting, press .
- The set temperature is only displayed when the mode setting is on.

9. Press .

- Be sure to direct the remote controller toward the indoor unit and check for a receiving tone and flashing the multi-monitor lamp.
- The temperature is set while in ON TIMER operation, and the time is set while in OFF TIMER operation.
- The next reservation screen will appear.
- To continue further settings, repeat the procedure from step 4.
- The multi-monitor lamp blinks twice.
The TIMER lamp periodically lights orange. [▶Page 5](#)
The multi-monitor lamp will not blink orange if all the reservation settings are deleted.

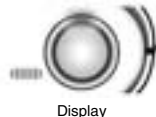

Display

10. Press to complete the setting.

- “ WEEKLY” is displayed on the LCD and WEEKLY TIMER operation is activated.
- A reservation made once can be easily copied and the same settings used for another day of the week. Refer to copy mode. [▶Page 26](#)

NOTE

■ Notes on WEEKLY TIMER operation

- Do not forget to set the clock on the remote controller first.
- The day of the week, ON/OFF TIMER mode, time and set temperature (only for ON TIMER mode) can be set with WEEKLY TIMER. Other settings for ON TIMER are based on the settings just before the operation.
- Both WEEKLY TIMER and ON/OFF TIMER operation cannot be used at the same time. The ON/OFF TIMER operation has priority if it is set while WEEKLY TIMER is still active. The WEEKLY TIMER will go into standby state, and “ WEEKLY” will disappear from the LCD. When ON/OFF TIMER is up, the WEEKLY TIMER will automatically become active.
- Shutting the breaker off, power failure, and other similar events will render operation of the indoor unit's internal clock inaccurate. Reset the clock.



Copy mode

- A reservation made once can be copied to another day of the week. The whole reservation of the selected day of the week will be copied.

[Monday]

Program 1 ON 25°C 6:00 8:30 Program 2 OFF Program 3 ON 27°C 17:30 Program 4 OFF 22:00





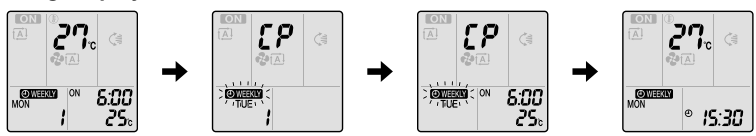

[Tuesday to Friday]

Program 1 ON 25°C 6:00 8:30 Program 2 OFF Program 3 ON 27°C 17:30 Program 4 OFF 22:00

Setting Displays



Confirmation → Copy → Paste → Normal

1. Press .
2. Press  to confirm the day of the week to be copied.
3. Press .
 - The whole reservation of the selected day of the week will be copied.
4. Press  to select the destination day of the week.
5. Press .
 - Be sure to direct the remote controller toward the indoor unit and check for a receiving tone and flashing the multi-monitor lamp.
 - The reservation will be copied to the selected day of the week. The whole reservation of the selected day of the week will be copied.
 - To continue copying the settings to other days of the week, repeat step 4 and step 5.
 - The multi-monitor lamp blinks twice. The TIMER lamp periodically lights orange.
6. Press  to complete the setting.
 - "WEEKLY" is displayed on the LCD and WEEKLY TIMER operation is activated.

NOTE

- **Note on copy mode**
 - The entire reservation of the source day of the week is copied in the copy mode.

In the case of making a reservation change for any day of the week individually after copying the content of weekly reservations, press  and change the settings in the steps of setting mode. ▶Page24



WEEKLY TIMER Operation



■ Confirming a reservation

- The reservation can be confirmed.

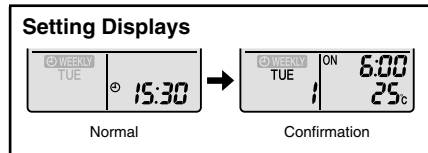

1. Press .

- The day of the week and the reservation number of the current day will be displayed.

2. Press to select the day of the week and the reservation number to be confirmed.

- Pressing displays the reservation details.
- To change the confirmed reserved settings, select the reservation number and press .
The mode is switched to setting mode. Go to setting mode step 2. [▶Page 24](#)

3. Press to exit confirming mode.

■ To deactivate WEEKLY TIMER operation

Press while “ WEEKLY” is displayed on the LCD.

- The “ WEEKLY” will disappear from the LCD.
- The TIMER lamp goes off.
- To reactivate the WEEKLYTIMER operation, press again.
- If a reservation deactivated with is activated once again, the last reservation mode will be used.





CAUTION

- If not all the reservation settings are reflected, deactivate the WEEKLY TIMER operation once. Then press again to reactivate the WEEKLY TIMER operation.





■ To delete reservations

The individual reservation

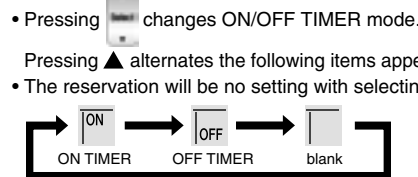

1. Press .
 - The day of the week and the reservation number will be displayed.
2. Press  to select the day of the week and the reservation number to be deleted.
3. Press .
 - "WEEKLY" and "ON" or "OFF" blink.
4. Press  and select "blank".



5. Press .
 - The selected reservation will be deleted.
6. Press .
 - If there are still other reservations, WEEKLY TIMER operation will be activated.

The reservations for each day of the week

- This function can be used for deleting reservations for each day of the week.
- It can be used while confirming or setting reservations.

1. Press  to select the day of the week to be deleted.
2. Hold  for 5 seconds.
 - The reservation of the selected day of the week will be deleted.

All reservations

Hold  for 5 seconds while normal display.

- Be sure to direct the remote controller toward the indoor unit and check for a receiving tone.
- This operation is not effective while WEEKLY TIMER is being set.
- All reservations will be deleted.

Part 6

Service Diagnosis

1. Caution for Diagnosis.....	67
1.1 Troubleshooting with LED	67
2. Problem Symptoms and Measures	68
3. Service Check Function	69
4. Troubleshooting	72
4.1 Error Codes and Description	72
4.2 Indoor Unit PCB Abnormality	73
4.3 Freeze-up Protection Control or Heating Peak-cut Control.....	74
4.4 Fan Motor (DC Motor) or Related Abnormality.....	76
4.5 Thermistor or Related Abnormality (Indoor Unit).....	78
4.6 Front Panel Open / Close Fault.....	79
4.7 Signal Transmission Error (between Indoor Unit and Outdoor Unit)	80
4.8 Unspecified Voltage (between Indoor Unit and Outdoor Unit)	81
4.9 Outdoor Unit PCB Abnormality.....	82
4.10 OL Activation (Compressor Overload)	83
4.11 Compressor Lock	84
4.12 DC Fan Lock	85
4.13 Input Overcurrent Detection	86
4.14 Four Way Valve Abnormality	87
4.15 Discharge Pipe Temperature Control.....	89
4.16 High Pressure Control in Cooling	90
4.17 Compressor System Sensor Abnormality	92
4.18 Position Sensor Abnormality	93
4.19 DC Voltage / Current Sensor Abnormality.....	95
4.20 Thermistor or Related Abnormality (Outdoor Unit).....	96
4.21 Electrical Box Temperature Rise	98
4.22 Radiation Fin Temperature Rise	100
4.23 Output Overcurrent Detection	102
4.24 Refrigerant Shortage	104
4.25 Low-voltage Detection or Over-voltage Detection.....	106
5. Check	107
5.1 How to Check.....	107

1. Caution for Diagnosis

1.1 Troubleshooting with LED

Indoor Unit

The multi-colored indicator lamp blinks when any of the following errors is detected.

1. When a protection device of the indoor or outdoor unit is activated, or when the thermistor malfunctions.
 2. When a signal transmission error occurs between the indoor and outdoor units.
- In either case, conduct the diagnostic procedure described in the following pages.

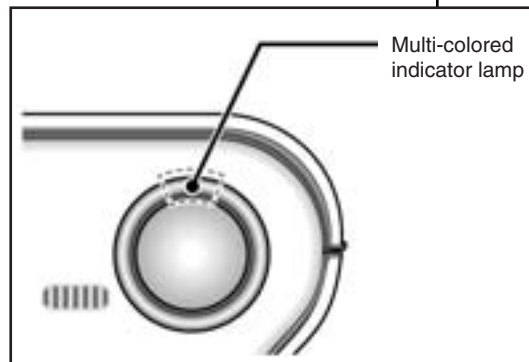

Outdoor Unit

The outdoor unit has one green LED (LED A) on the PCB. The blinking green LED indicates normal condition of microcomputer operation.

2. Problem Symptoms and Measures

Symptom	Check Item	Details of Measure	Reference Page
The units does not operate.	Check the power supply.	Check to make sure that the rated voltage is supplied.	—
	Check the type of the indoor units.	Check to make sure that the indoor unit type is compatible with the outdoor unit.	—
	Check the outdoor temperature.	Heating operation cannot be used when the outdoor temperature is 24°C or higher, and cooling operation cannot be used when the outdoor temperature is below -10°C.	—
	Diagnose with remote controller indication.	—	72
	Check the remote controller addresses.	Check to make sure that address settings for the remote controller and indoor unit are correct.	—
Operation sometimes stops.	Check the power supply.	A power failure of 2 to 10 cycles stops air conditioner operation. (Operation lamp OFF)	—
	Check the outdoor temperature.	Heating operation cannot be used when the outdoor temperature is 24°C or higher, and cooling operation cannot be used when the outdoor temperature is below -10°C.	—
	Diagnose with remote controller indication.	—	72
The unit operates but does not cool, or does not heat.	Check for wiring and piping errors in the connection between the indoor and outdoor units.	Conduct the wiring/piping error check described on the product diagnosis label.	—
	Check for thermistor detection errors.	Check to make sure that the thermistor is mounted securely.	—
	Check for faulty operation of the electronic expansion valve.	Set the units to cooling operation, and check the temperature of the liquid pipe to see the electronic expansion valve works.	—
	Diagnose with remote controller indication.	—	72
	Diagnose by service port pressure and operating current.	Check for refrigerant shortage.	104
Large operating noise and vibrations	Check the output voltage of the power module.	—	112
	Check the power module.	—	—
	Check the installation condition.	Check to make sure that the required spaces for installation (specified in the installation manual, etc.) are provided.	—

3. Service Check Function

Check Method 1

1. When the timer cancel button is held down for 5 seconds, "00" indication appears on the temperature display section.

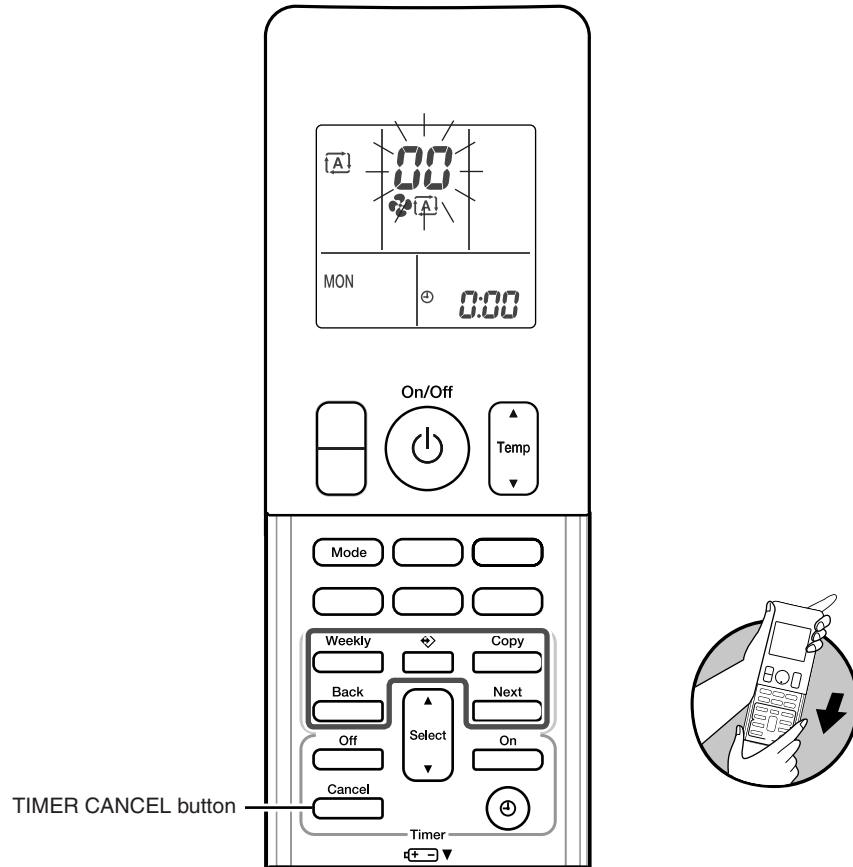

< ARC466 Series >

(R11668)

2. Press the timer cancel button repeatedly until a long beep sounds.
 - The code indication changes in the sequence shown below.

No.	Code	No.	Code	No.	Code
1	00	13	07	25	UR
2	04	14	R3	26	UM
3	15	15	H8	27	P4
4	E6	16	H9	28	L3
5	H6	17	09	29	L4
6	H0	18	04	30	H7
7	R6	19	05	31	U2
8	E7	20	J3	32	ER
9	U0	21	J6	33	RM
10	F3	22	E5	34	FR
11	R5	23	R1	35	H1
12	F6	24	E1	36	P9



Note:

1. A short beep "pi" and two consecutive beeps "pi pi" indicate non-corresponding codes.
2. To return to the normal mode, hold the timer cancel button down for 5 seconds. When the remote controller is left untouched for 60 seconds, it also returns to the normal mode.

Check Method 2

1. Press the center of the Temp button and the Mode button at the same time.

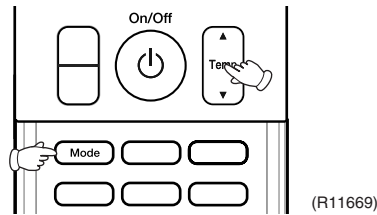

“5ㇿ” is displayed on the LCD.

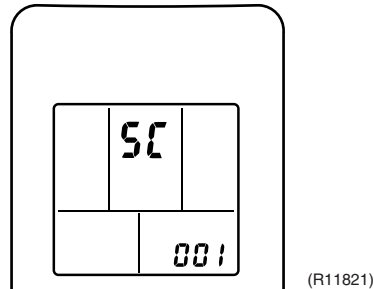

2. Select “5ㇿ” (service check) with the Temp▲ or ▼ button.
3. Press the Mode button to enter the service check mode.
The figure of the ten’s place blinks.

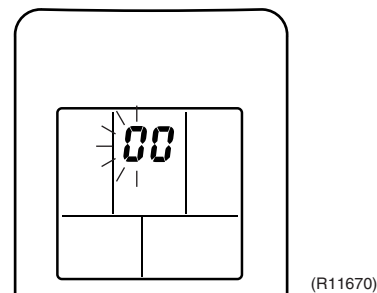

4. Press the Temp▲ or ▼ button and change the figure until you hear the sound of “beep” or “pi pi”.

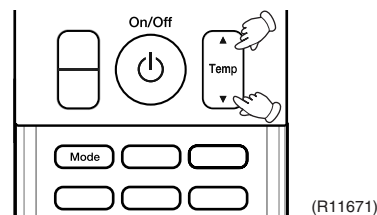

5. Diagnose by the sound.
 - ★“pi” : The figure of the ten’s place does not accord with the error code.
 - ★“pi pi” : The figure of the ten’s place accords with the error code but the one’s not.
 - ★“beep” : The both figures of the ten’s and one’s place accord with the error code.
(→ See 9.)

6. Press the Mode button.

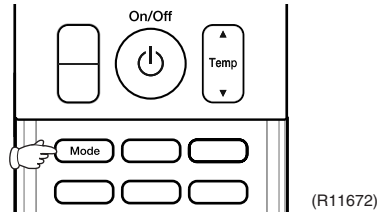

The figure of the one's place blinks.

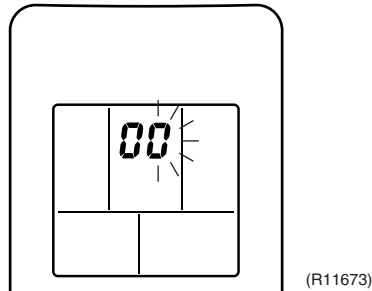

7. Press the Temp ▲ or ▼ button and change the figure until you hear the sound of “beep”.

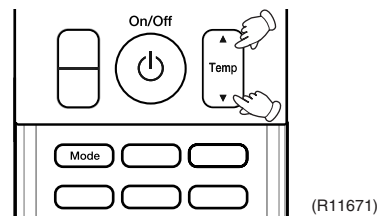

8. Diagnose by the sound.

- ★“pi” : The figure of the ten's place does not accord with the error code.
- ★“pi pi” : The figure of the ten's place accords with the error code but the one's not.
- ★“beep” : The both figures of the ten's and one's place accord with the error code.

9. Determine the error code.

The figures indicated when you hear the “beep” sound are error code.
(Error codes and description → Refer to page 72.)

10. Press the Mode button for 5 seconds to exit from the service check mode.
(When the remote controller is left untouched for 60 seconds, it returns to the normal mode also.)

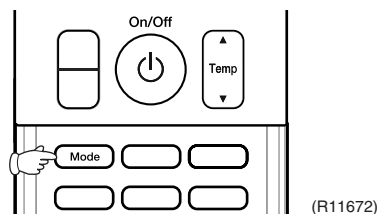

4. Troubleshooting

4.1 Error Codes and Description

	Error Codes	Description	Reference Page
System	00	Normal	—
	U0★	Refrigerant shortage	104
	U2	Low-voltage detection or over-voltage detection	106
	U4	Signal transmission error (between indoor unit and outdoor unit)	80
	UR	Unspecified voltage (between indoor unit and outdoor unit)	81
Indoor Unit	R1	Indoor unit PCB abnormality	73
	R5	Freeze-up protection control or heating peak-cut control	74
	R6	Fan motor (DC motor) or related abnormality	76
	C4	Indoor heat exchanger thermistor or related abnormality	78
	C7	Front panel open / close fault	79
	C9	Room temperature thermistor or related abnormality	78
Outdoor Unit	E1	Outdoor unit PCB abnormality	82
	E5★	OL activation (compressor overload)	83
	E6★	Compressor lock	84
	E7	DC fan lock	85
	E8	Input overcurrent detection	86
	E9	Four way valve abnormality	87
	F3	Discharge pipe temperature control	89
	F6	High pressure control in cooling	90
	H0	Compressor system sensor abnormality	92
	H5	Position sensor abnormality	93
	H8	DC voltage / current sensor abnormality	95
	H9	Outdoor temperature thermistor or related abnormality	96
	J3	Discharge pipe thermistor or related abnormality	96
	J6	Outdoor heat exchanger thermistor or related abnormality	96
	L3	Electrical box temperature rise	98
	L4	Radiation fin temperature rise	100
	L5	Output overcurrent detection	102
	P4	Radiation fin thermistor or related abnormality	96

★: Displayed only when system-down occurs.

4.2 Indoor Unit PCB Abnormality

Remote
Controller
Display



Method of
Malfunction
Detection

The system checks if the circuit works properly within the microcomputer of the indoor unit.

Malfunction
Decision
Conditions

The system cannot set the internal settings.

Supposed
Causes

- Wrong models interconnected
- Defective indoor unit PCB
- Disconnection of connector

Troubleshooting

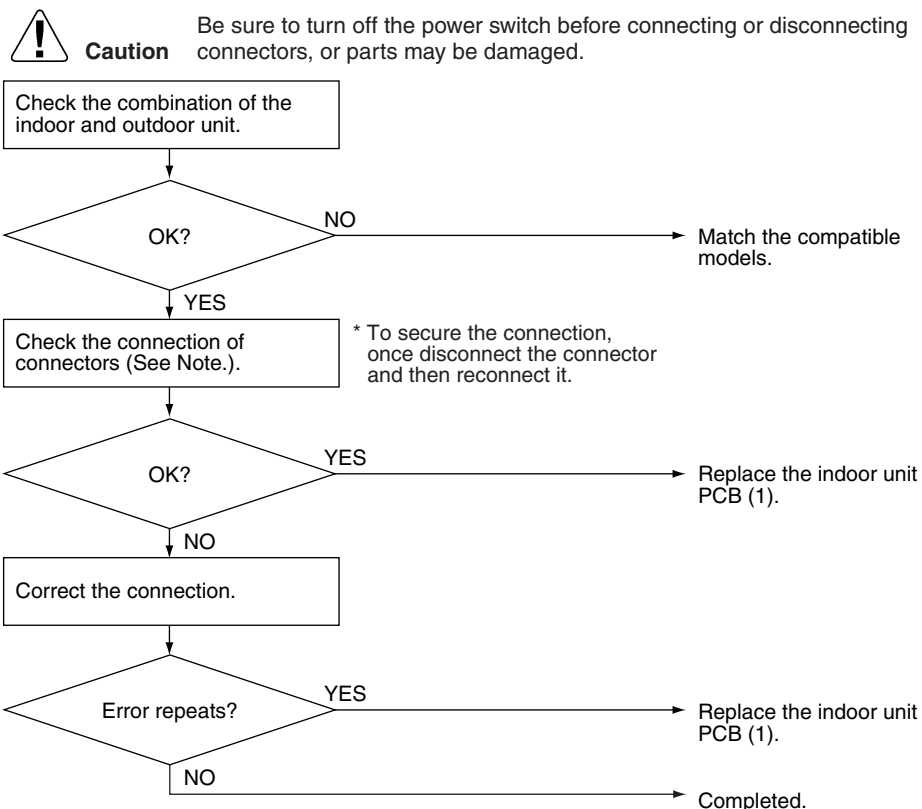

(R11704)



Note: Check the following connector.

Model Type	Connector
Wall Mounted Type	Terminal board ~ Control PCB

4.3 Freeze-up Protection Control or Heating Peak-cut Control

Remote
Controller
Display

85

Method of
Malfunction
Detection

- Freeze-up protection control
During cooling operation, the freeze-up protection control (operation halt) is activated according to the temperature detected by the indoor heat exchanger thermistor.
- Heating peak-cut control
During heating operation, the temperature detected by the indoor heat exchanger thermistor is used for the heating peak-cut control (operation halt, outdoor fan stop, etc.)

Malfunction
Decision
Conditions

- Freeze-up protection control
During cooling operation, the indoor heat exchanger temperature is below 0°C.
- Heating peak-cut control
During heating operation, the indoor heat exchanger temperature is above 65°C

Supposed
Causes

- Short-circuited air
- Clogged air filter of the indoor unit
- Dust accumulation on the indoor heat exchanger
- Defective indoor heat exchanger thermistor
- Defective indoor unit PCB

Troubleshooting



Check No.06
Refer to P.109

**Caution**

Be sure to turn off the power switch before connecting or disconnecting connectors, or parts may be damaged.

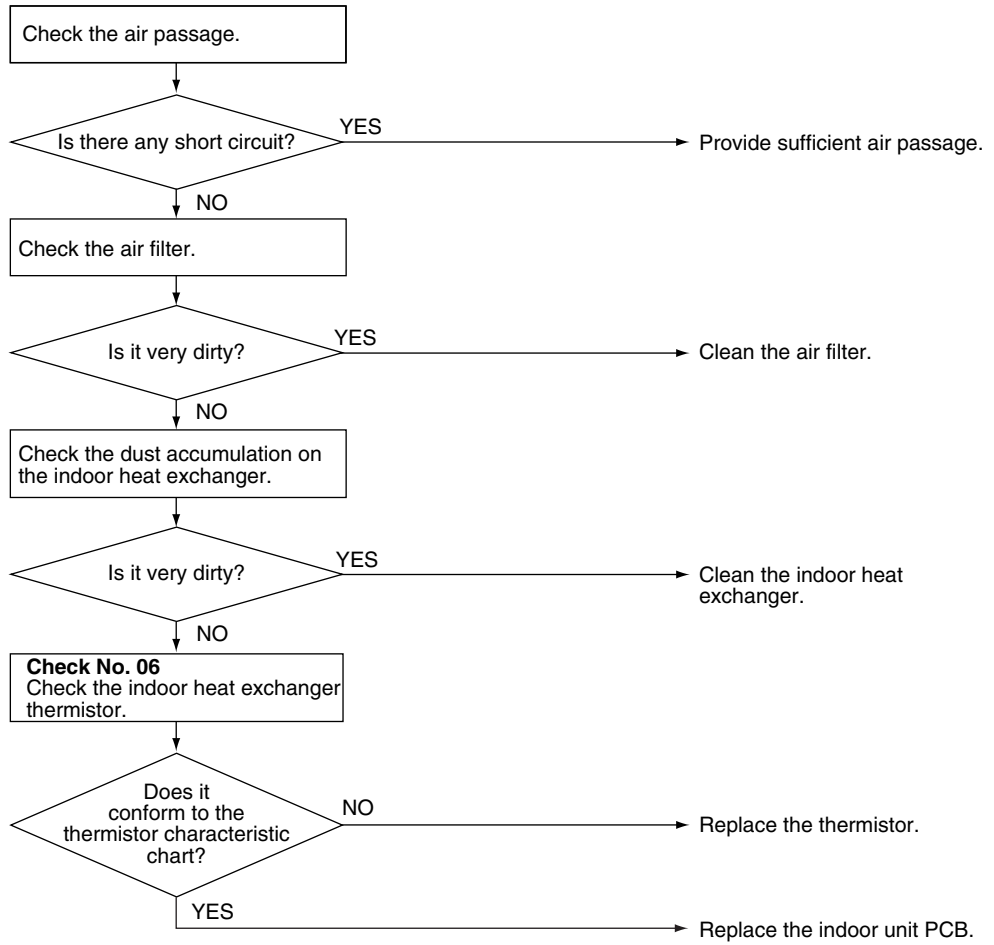

(R7131)

4.4 Fan Motor (DC Motor) or Related Abnormality

<p>Remote Controller Display</p>	<p></p>
<p>Method of Malfunction Detection</p>	<p>The rotation speed detected by the Hall IC during fan motor operation is used to determine abnormal fan motor operation.</p>
<p>Malfunction Decision Conditions</p>	<p>The detected rotation speed does not reach the demanded rotation speed of the target tap, and is less than 50% of the maximum fan motor rotation speed.</p>
<p>Supposed Causes</p>	<ul style="list-style-type: none"> ■ Layer short inside the fan motor winding ■ Breaking of wire inside the fan motor ■ Breaking of the fan motor lead wires ■ Defective capacitor of the fan motor ■ Defective indoor unit PCB

Troubleshooting



Check No.01
Refer to P.107



Caution

Be sure to turn off the power switch before connecting or disconnecting connectors, or parts may be damaged.

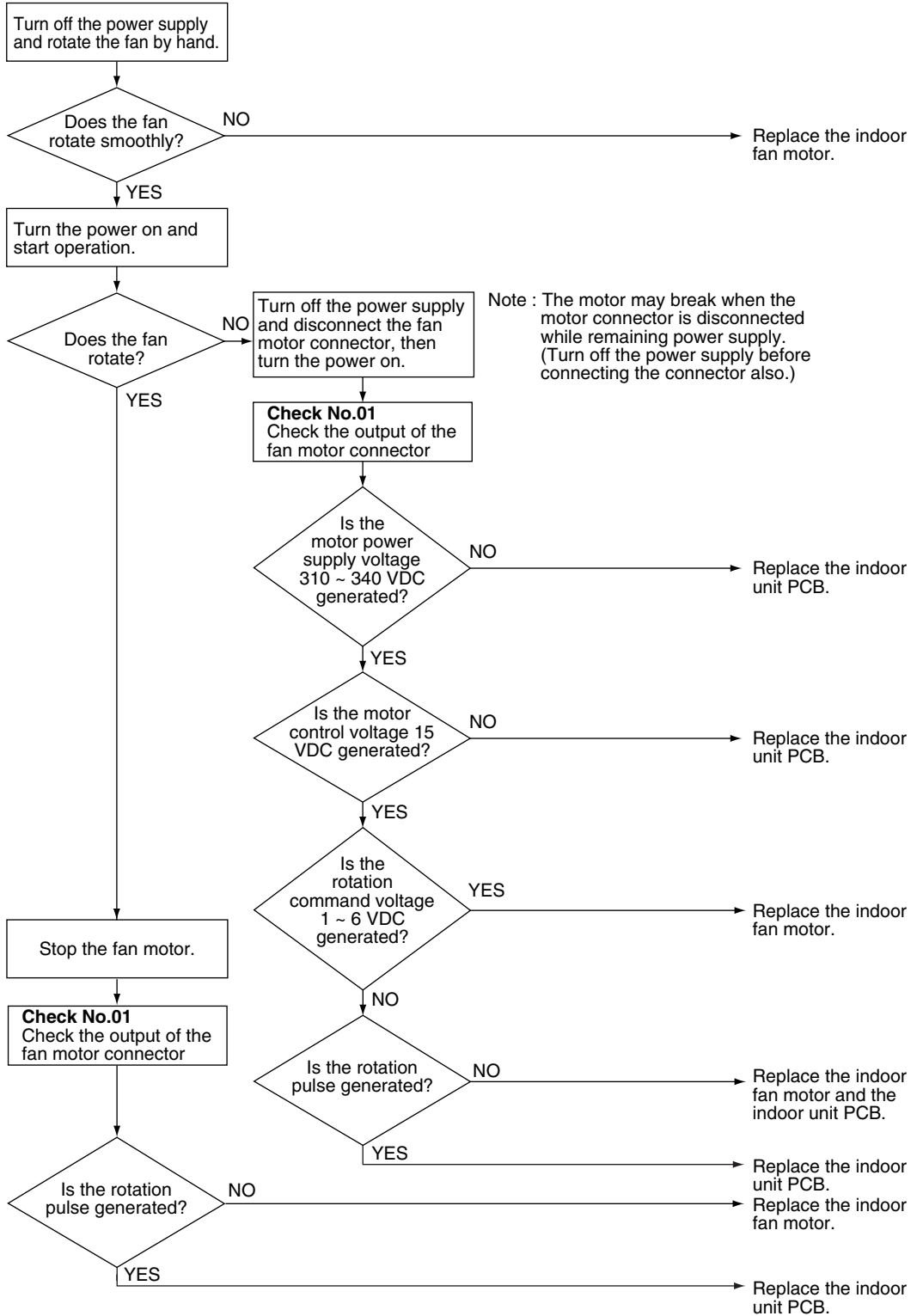

(R12033)

4.5 Thermistor or Related Abnormality (Indoor Unit)

Remote Controller Display	⌘4,⌘9
Method of Malfunction Detection	The temperatures detected by the thermistors determine thermistor errors.
Malfunction Decision Conditions	The thermistor input is more than 4.96 V or less than 0.04 V during compressor operation.
Supposed Causes	<ul style="list-style-type: none"> ■ Disconnection of connector ■ Defective thermistor ■ Defective indoor unit PCB

Troubleshooting

Check No.06
 Refer to P.109

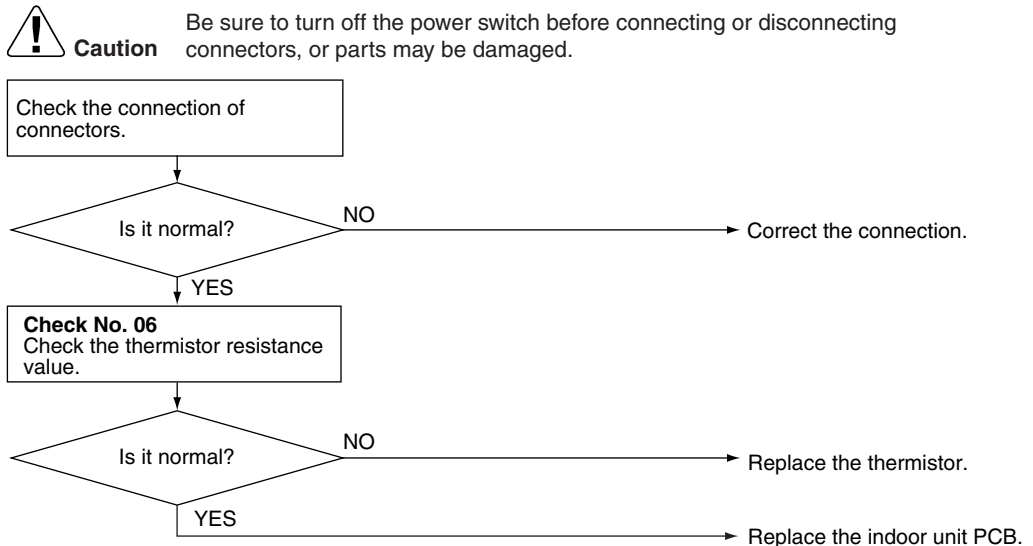

(R7134)

⌘4 : Indoor heat exchanger thermistor
 ⌘9 : Room temperature thermistor

4.6 Front Panel Open / Close Fault

Remote
Controller
Display



Method of
Malfunction
Detection

Malfunction
Decision
Conditions

- If the error repeats twice, the system is shut down.

Supposed
Causes

- Defective reduction motor
- Malfunction or deterioration of the front panel mechanism
- Defective limit switch

Troubleshooting

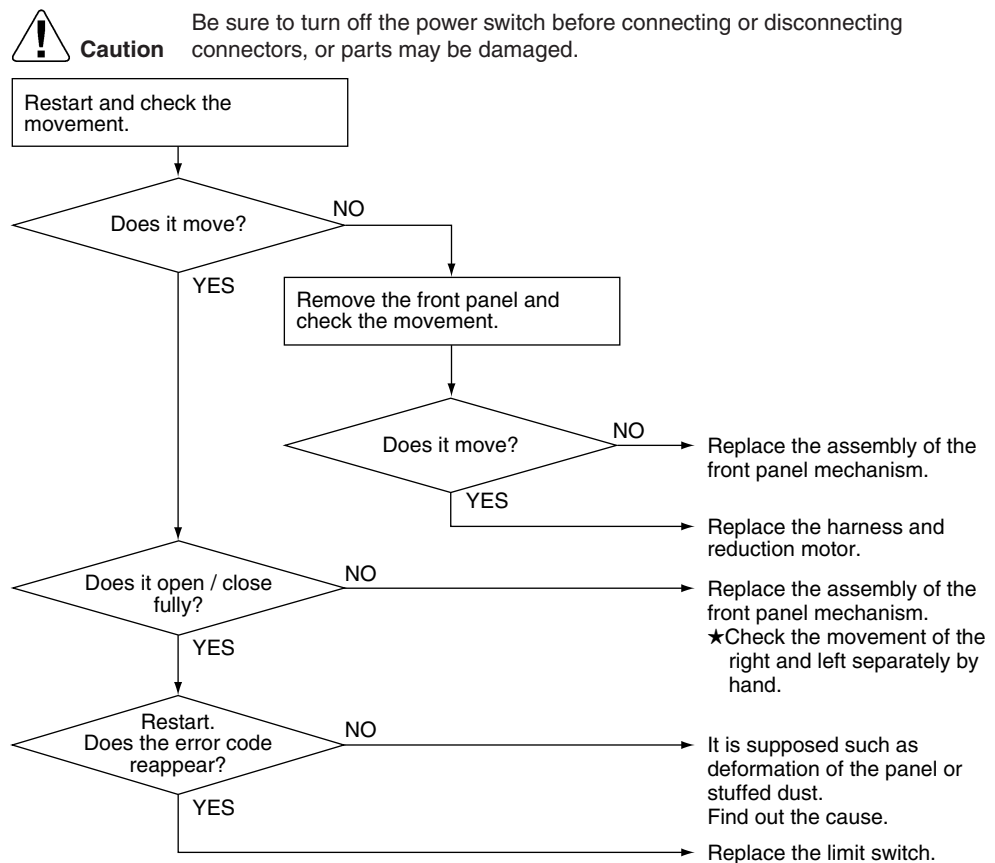

(R12180)



Note: You cannot operate the unit by the remote controller when the front panel mechanism breaks down.

<To the dealers: temporary measure before repair>

1. Turn off the power.
2. Remove the front panel.
3. Turn on the power.
(Wait until the initialization finishes.)
4. Operate the unit by the indoor unit ON/OFF button.

4.7 Signal Transmission Error (between Indoor Unit and Outdoor Unit)

Remote Controller Display



Method of Malfunction Detection

The data received from the outdoor unit in indoor unit-outdoor unit signal transmission is checked whether it is normal.

Malfunction Decision Conditions

The data sent from the outdoor unit cannot be received normally, or the content of the data is abnormal.

Supposed Causes

- Wiring error
- Breaking of the connection wires between the indoor and outdoor units (wire No. 3)
- Defective outdoor unit PCB
- Defective indoor unit PCB
- Disturbed power supply waveform

Troubleshooting



Check No.10
Refer to P.111

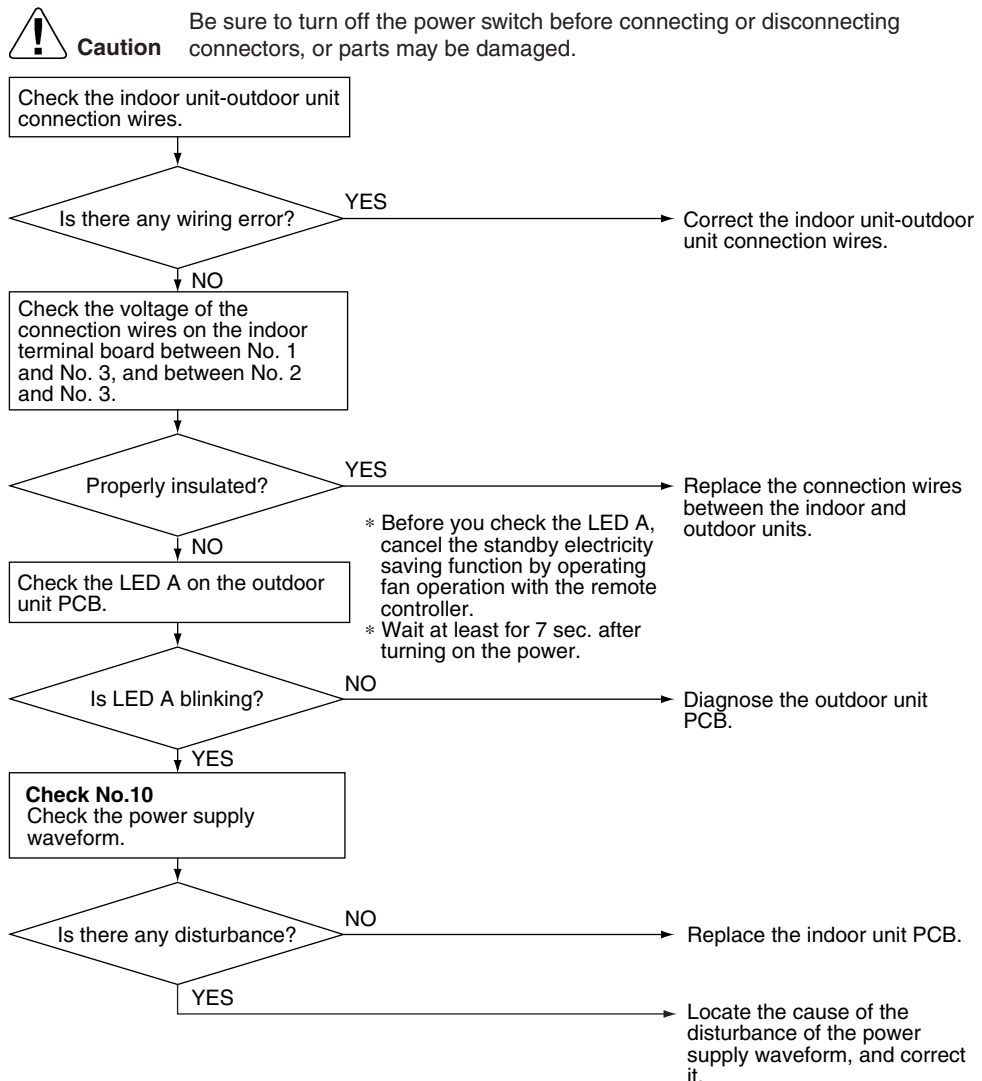

(R12160)

4.8 Unspecified Voltage (between Indoor Unit and Outdoor Unit)

Remote
Controller
Display

UR

Method of
Malfunction
Detection

The supply power is detected for its requirements (different from pair type and multi type) by the indoor / outdoor transmission signal.

Malfunction
Decision
Conditions

The pair type and multi type are interconnected.

Supposed
Causes

- Wrong models interconnected
- Wrong wiring of connecting wires
- Wrong indoor unit PCB or outdoor unit PCB mounted
- Defective indoor unit PCB
- Defective outdoor unit PCB

Troubleshooting



Caution

Be sure to turn off the power switch before connecting or disconnecting connectors, or parts may be damaged.

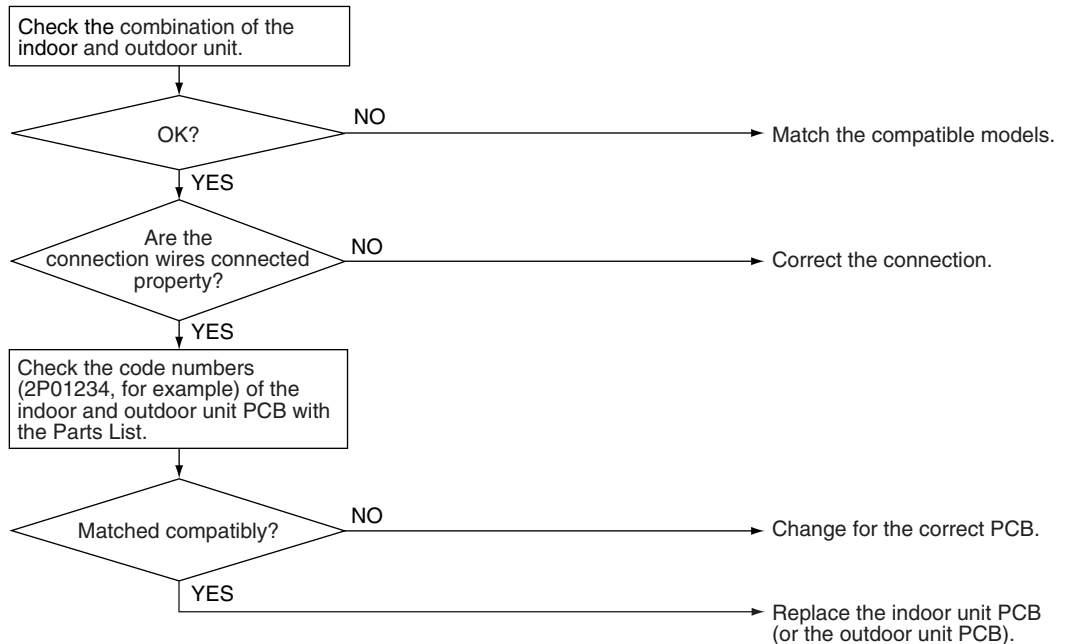

(R11707)

4.9 Outdoor Unit PCB Abnormality

Remote
Controller
Display

E1

Method of
Malfunction
Detection

- The system follows the microprocessor program as specified.
- The system checks to see if the zero-cross signal comes in properly.

Malfunction
Decision
Conditions

- The microprocessor program runs out of control.
- The zero-cross signal is not detected.

Supposed
Causes

- Defective outdoor unit PCB
- Broken harness between PCBs
- Noise
- Momentary fall of voltage
- Momentary power failure, etc

Troubleshooting

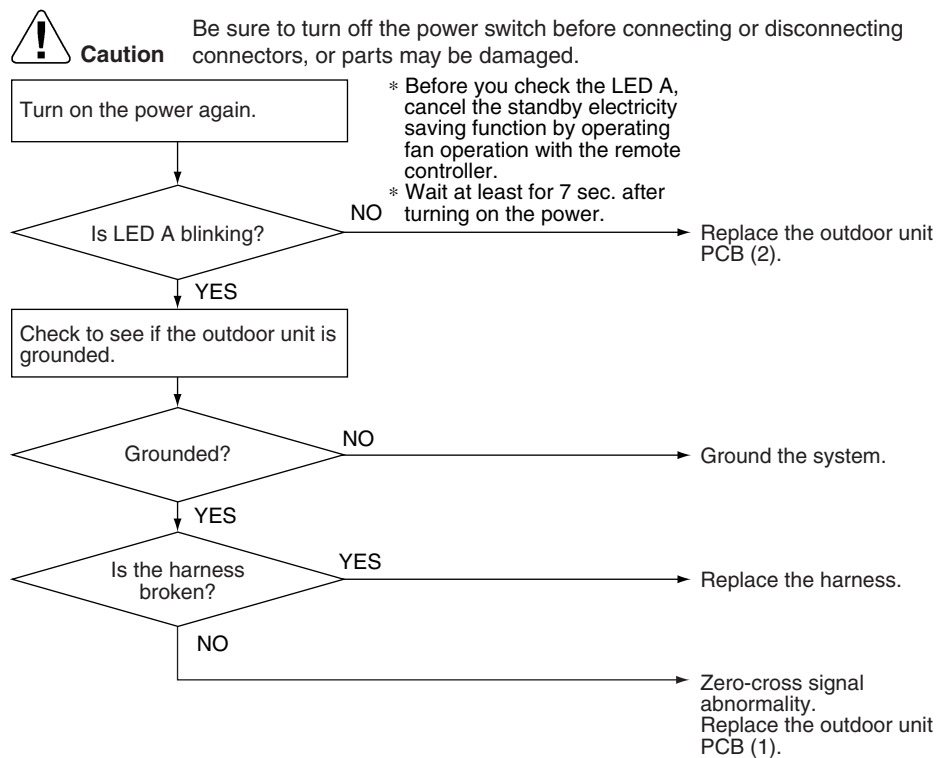

(R12161)

4.10 OL Activation (Compressor Overload)

Remote
Controller
Display



Method of
Malfunction
Detection

A compressor overload is detected through compressor OL.

Malfunction
Decision
Conditions

- If the error repeats twice, the system is shut down.
- Reset condition: Continuous run for about 60 minutes without any other error
- * The operating temperature condition is not specified.

Supposed
Causes

- Defective discharge pipe thermistor
- Defective electronic expansion valve or coil
- Defective four way valve or coil
- Defective outdoor unit PCB
- Refrigerant shortage
- Water mixed in refrigerant
- Defective stop valve

Troubleshooting



Check No.04
Refer to P.107



Check No.05
Refer to P.108



Check No.06
Refer to P.109



Check No.11
Refer to P.111



Caution

Be sure to turn off the power switch before connecting or disconnecting connectors, or parts may be damaged.

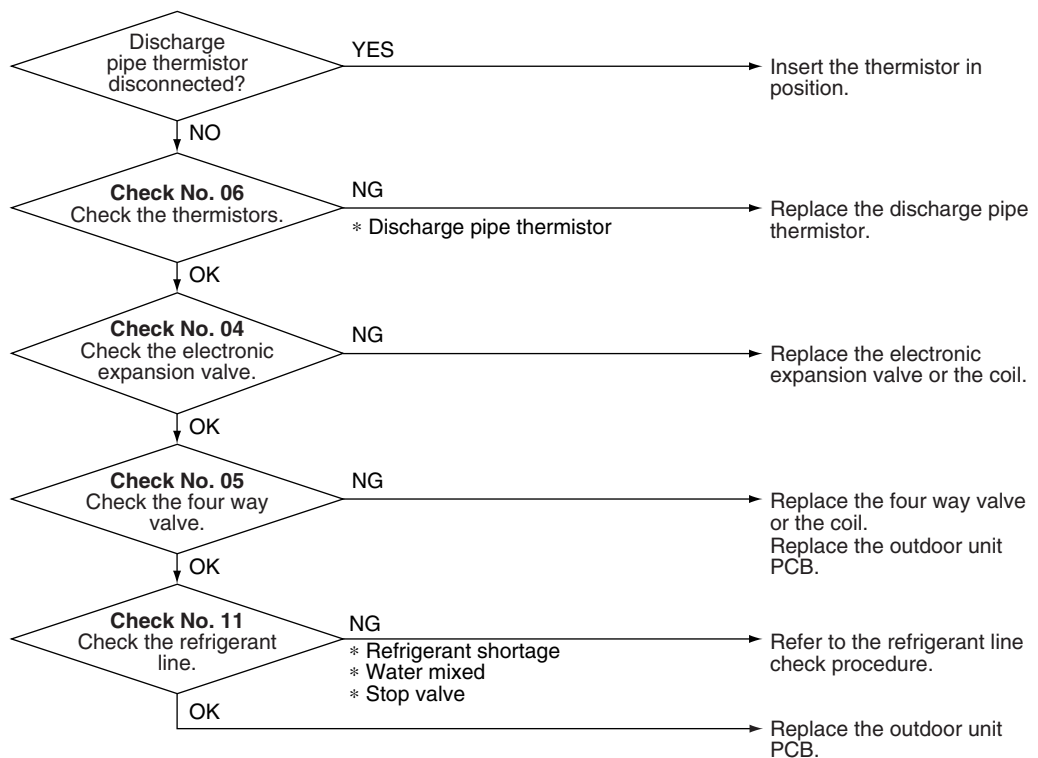

(R11999)

4.11 Compressor Lock

Remote Controller Display	
Method of Malfunction Detection	A compressor lock is detected by checking the compressor running condition through the position detection circuit.
Malfunction Decision Conditions	<ul style="list-style-type: none"> ■ Operation stops due to overcurrent. ■ If the error repeats 16 times, the system is shut down. ■ Reset condition: Continuous run for about 11 minutes without any other error
Supposed Causes	<ul style="list-style-type: none"> ■ Compressor locked ■ Compressor harness disconnected

Troubleshooting

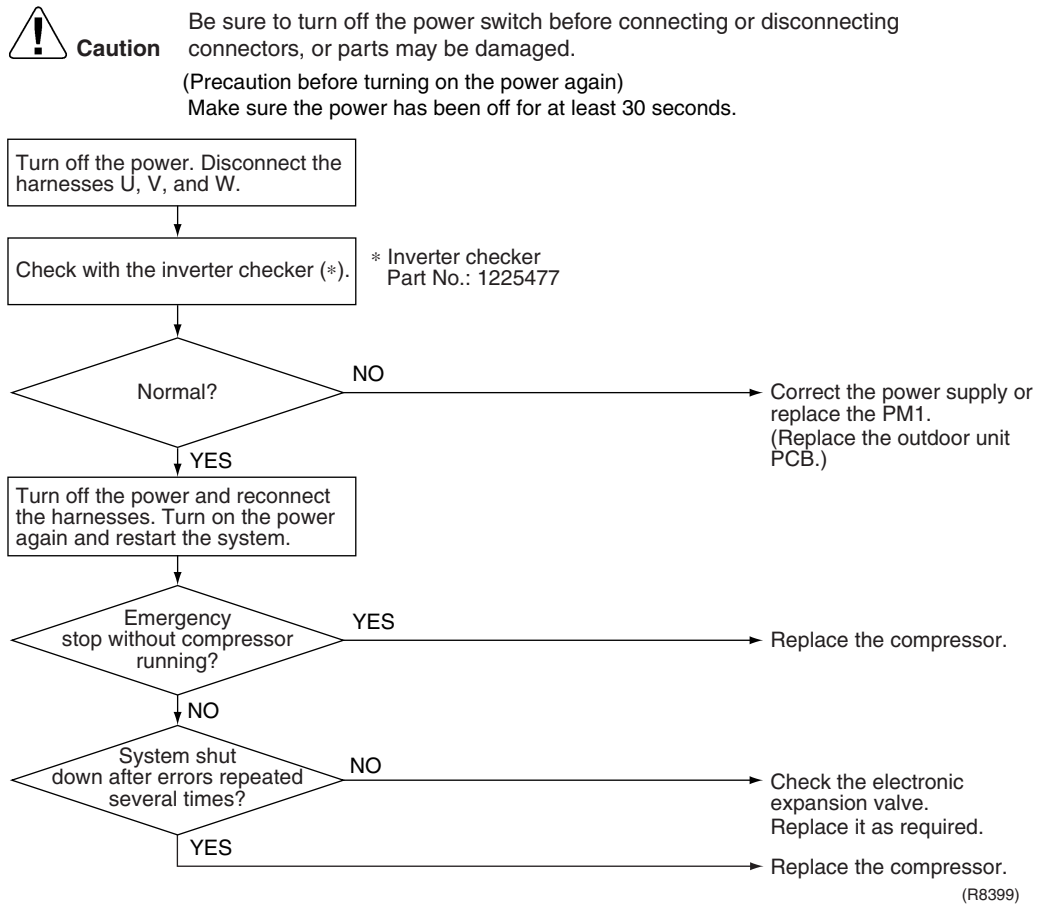

4.12 DC Fan Lock

Remote
Controller
Display



Method of
Malfunction
Detection

An error is determined with the high-voltage fan motor rotation speed detected by the Hall IC.

Malfunction
Decision
Conditions

- The fan does not start in 15 seconds even when the fan motor is running.
- If the error repeats 16 times, the system is shut down.
- Reset condition: Continuous run for about 11 minutes without any other error

Supposed
Causes

- Disconnection of the fan motor
- Foreign matters stuck in the fan
- Defective fan motor
- Defective outdoor unit PCB

Troubleshooting



Check No.15
Refer to P.112



Caution

Be sure to turn off the power switch before connecting or disconnecting connectors, or parts may be damaged.

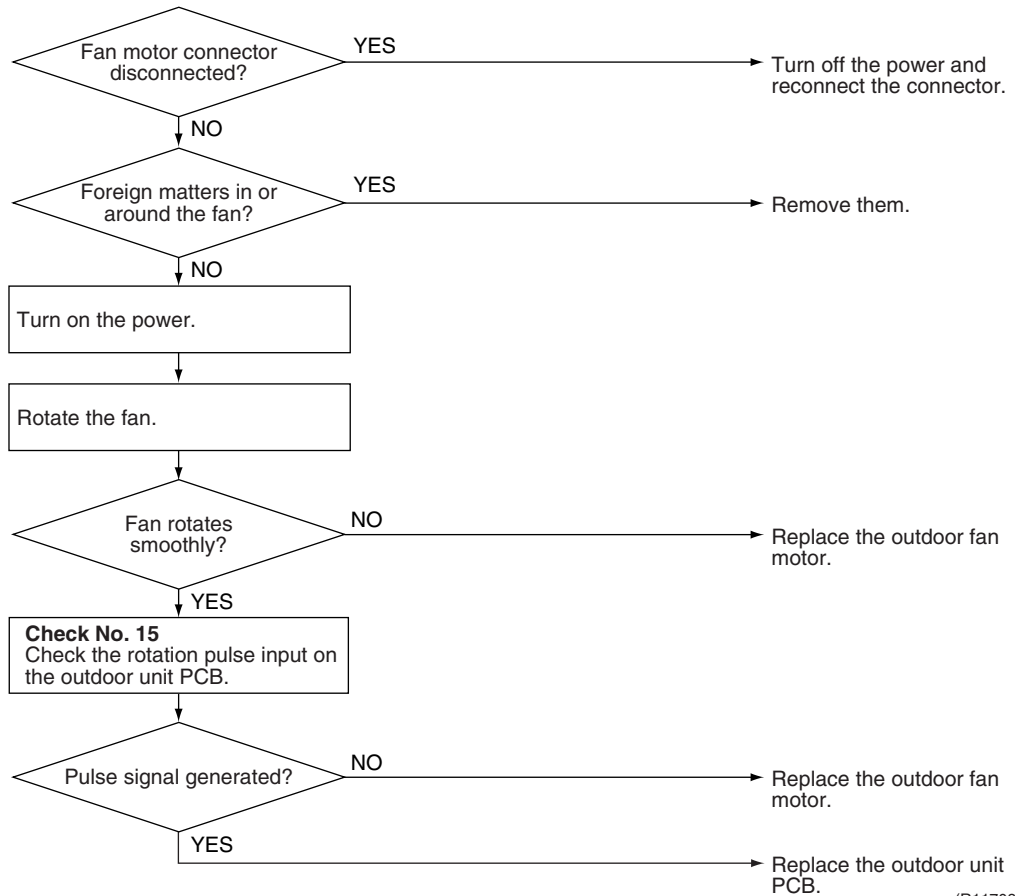

(R11708)

4.13 Input Overcurrent Detection

Remote Controller Display



Method of Malfunction Detection

An input overcurrent is detected by checking the input current value with the compressor running.

Malfunction Decision Conditions

- The following current with the compressor running continues for 2.5 seconds.
Cooling / Heating: Above 9.25 A

Supposed Causes

- Defective compressor
- Defective power module
- Defective outdoor unit PCB
- Short circuit

Troubleshooting



Check No.07
Refer to P.110



Check No.08
Refer to P.110



Caution

Be sure to turn off the power switch before connecting or disconnecting connectors, or parts may be damaged.

* An input overcurrent may result from wrong internal wiring. If the wires have been disconnected and reconnected for part replacement, for example, and the system is interrupted by an input overcurrent, take the following procedure.

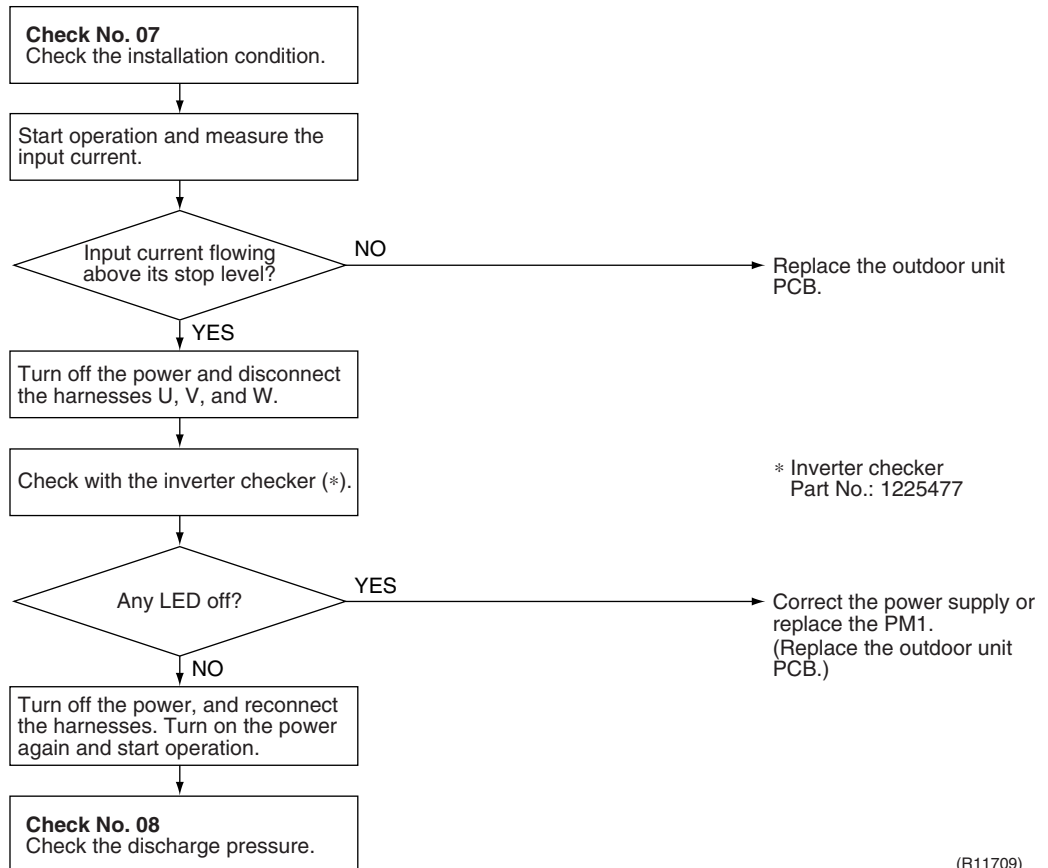

(R11709)

4.14 Four Way Valve Abnormality

Remote
Controller
Display

ER

Method of
Malfunction
Detection

The room temperature thermistor, the indoor heat exchanger thermistor, the outdoor temperature thermistor, and the outdoor heat exchanger thermistor are checked if they function within their normal ranges in each operation mode.

Malfunction
Decision
Conditions

- A following condition continues over 10 minutes after operating for 5 minutes.
- Cooling / Dry
(room temp. – indoor heat exchanger temp.) < –5°C
 - Heating
(indoor heat exchanger temp. – room temp.) < –5°C
 - If the error repeats twice, the system is shut down.
 - Reset condition: Continuous run for about 60 minutes without any other error

Supposed
Causes

- Disconnection of four way valve coil
- Defective four way valve, coil, or harness
- Defective outdoor unit PCB
- Defective thermistor
- Refrigerant shortage
- Water mixed in refrigerant
- Defective stop valve

Troubleshooting



Check No.05
Refer to P.108



Check No.06
Refer to P.109



Check No.11
Refer to P.111



Caution Be sure to turn off the power switch before connecting or disconnecting connectors, or parts may be damaged.

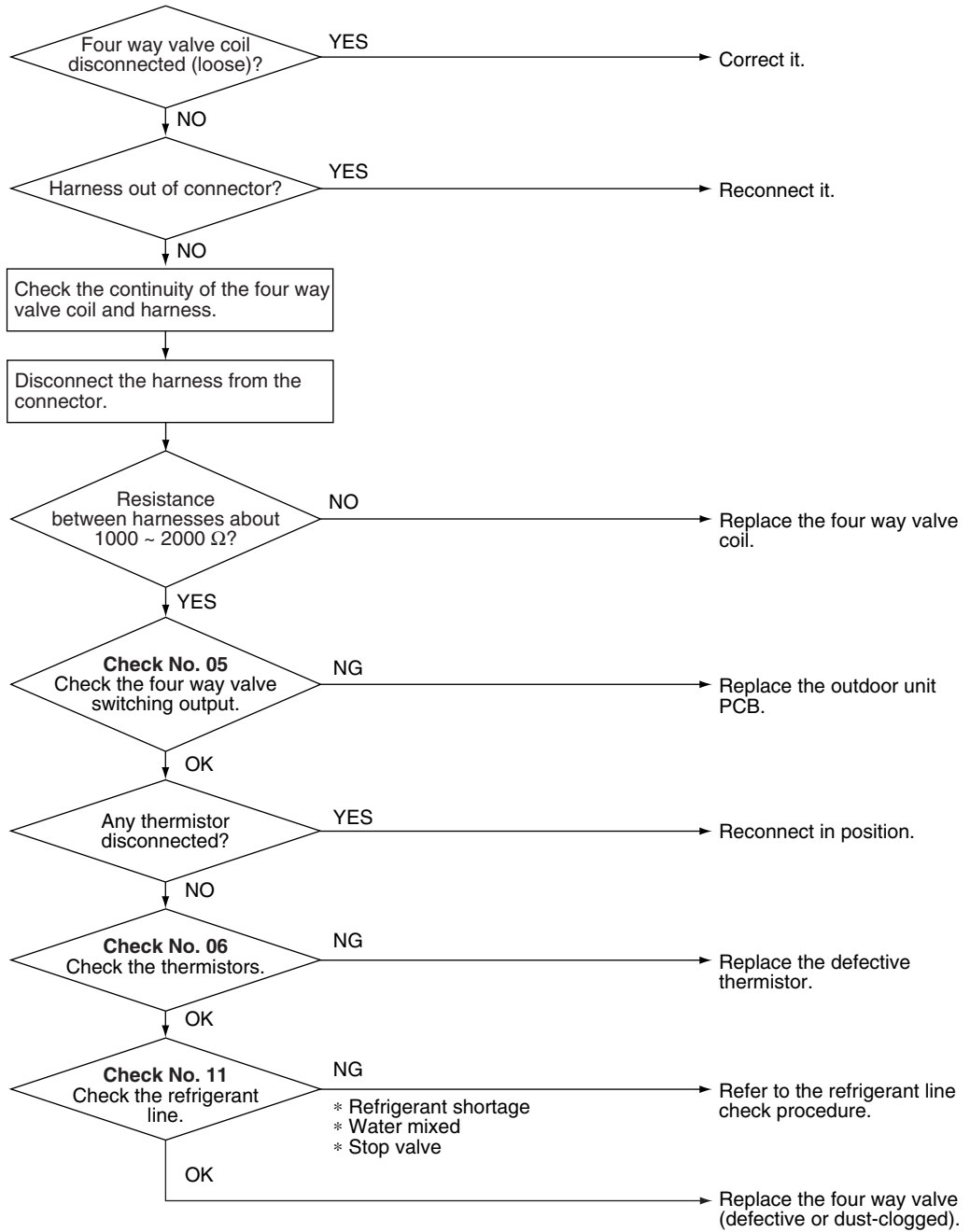

(R11710)

4.15 Discharge Pipe Temperature Control

Remote
Controller
Display



Method of
Malfunction
Detection

An error is determined with the temperature detected by the discharge pipe thermistor.

Malfunction
Decision
Conditions

- If the temperature detected by the discharge pipe thermistor rises above A °C, the compressor stops.
- The error is cleared when the discharge pipe temperature has dropped below B °C.

Stop temperatures	A (°C)	B (°C)
(1) above 45 Hz (rising), above 40 Hz (dropping)	110	97
(2) 30 ~ 45 Hz (rising), 25 ~ 40 Hz (dropping)	105	92
(3) below 30 Hz (rising), below 25 Hz (dropping)	99	86

- If the error repeats 4 times, the system is shut down.
- Reset condition: Continuous run for about 60 minutes without any other error

Supposed
Causes

- Defective discharge pipe thermistor
(Defective outdoor heat exchanger thermistor or outdoor temperature thermistor)
- Defective electronic expansion valve or coil
- Refrigerant shortage
- Defective four way valve
- Water mixed in refrigerant
- Defective stop valve
- Defective outdoor unit PCB

Troubleshooting

- Check No.04**
Refer to P.107
- Check No.06**
Refer to P.109
- Check No.11**
Refer to P.111

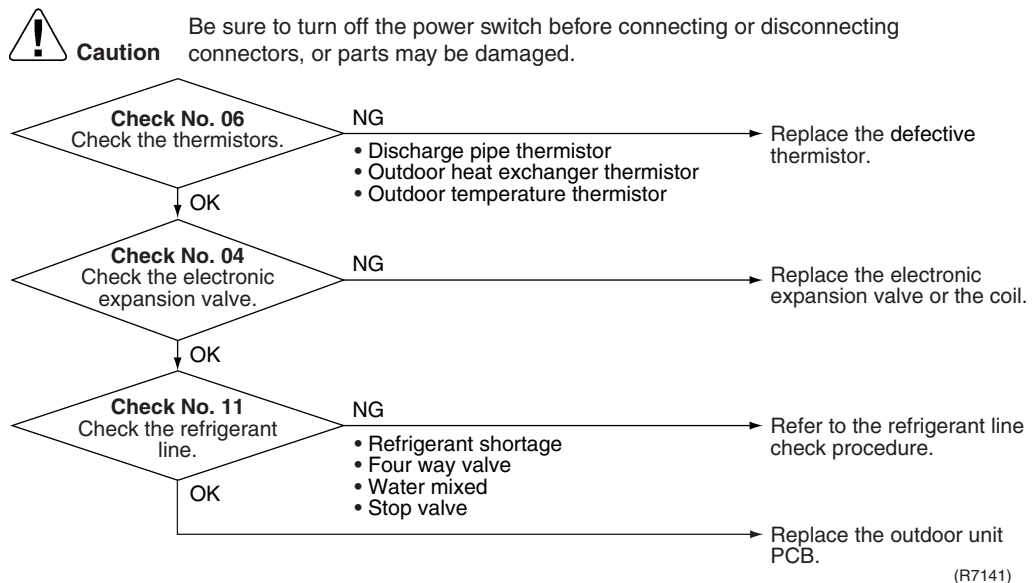

4.16 High Pressure Control in Cooling

Remote
Controller
Display



Method of
Malfunction
Detection

High-pressure control (operation halt, frequency drop, etc.) is activated in cooling operation if the temperature sensed by the outdoor heat exchanger thermistor exceeds the limit.

Malfunction
Decision
Conditions

- The temperature sensed by the outdoor heat exchanger thermistor rises above A°C .
- The error is cleared when the temperature drops below B°C .

A°C	65
B°C	52

Supposed
Causes

- The installation space is not large enough.
- Dirty outdoor heat exchanger
- Defective outdoor fan motor
- Defective stop valve
- Defective electronic expansion valve or coil
- Defective outdoor heat exchanger thermistor
- Defective outdoor unit PCB

Troubleshooting



Check No.04
Refer to P.107



Check No.06
Refer to P.109



Check No.07
Refer to P.110



Check No.08
Refer to P.110



Check No.09
Refer to P.111



Caution Be sure to turn off the power switch before connecting or disconnecting connectors, or parts may be damaged.

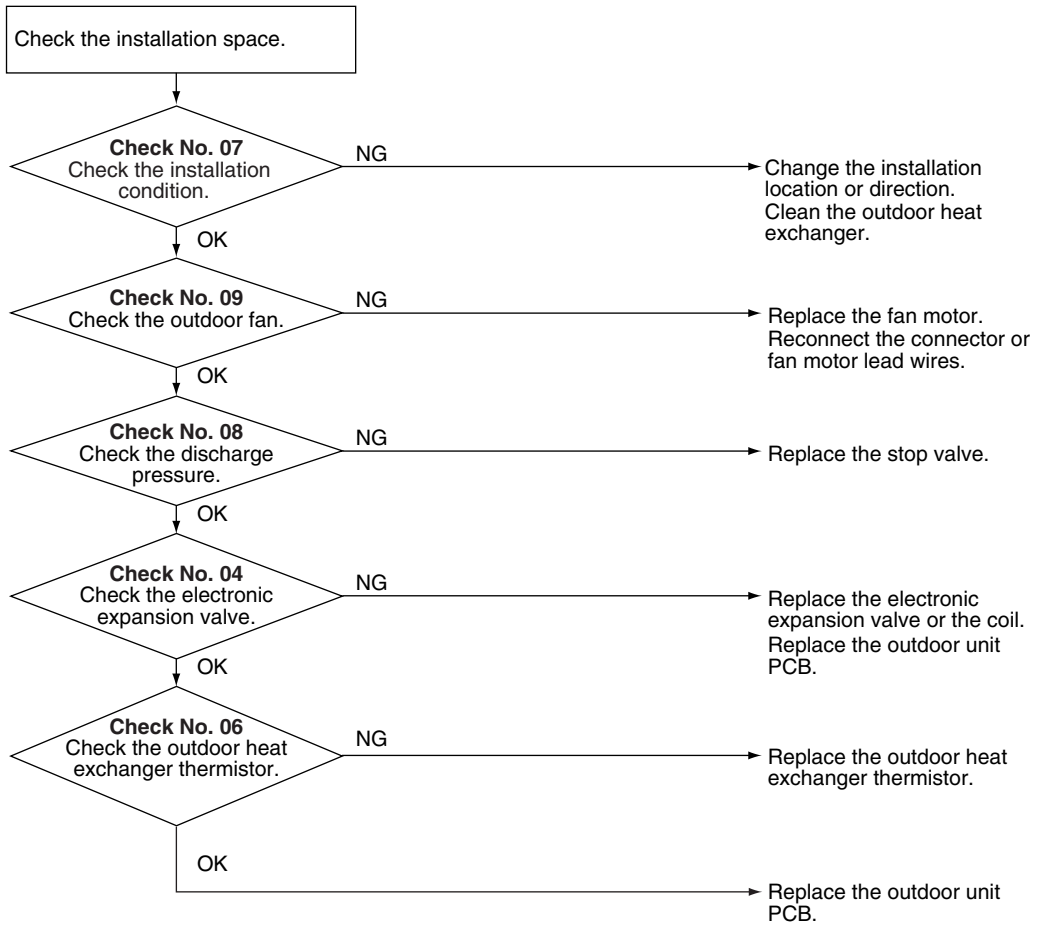

(R11897)

4.17 Compressor System Sensor Abnormality

Remote
Controller
Display



Method of
Malfunction
Detection

- The system checks the DC current before the compressor starts.

Malfunction
Decision
Conditions

- The DC current before compressor start-up is out of the range 0.5 ~ 4.5 V (sensor output converted to voltage value)
- The DC voltage before compressor start-up is below 50 V.

Supposed
Causes

- Broken or disconnection of harness
- Defective outdoor unit PCB

Troubleshooting

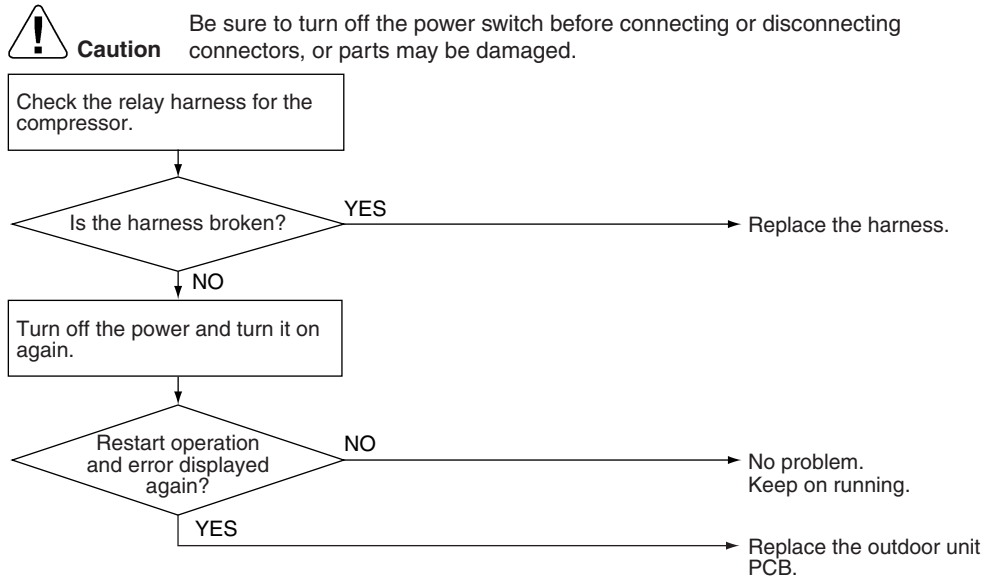

(R11712)

4.18 Position Sensor Abnormality

Remote
Controller
Display



Method of
Malfunction
Detection

A compressor start-up failure is detected by checking the compressor running condition through the position detection circuit.

Malfunction
Decision
Conditions

- If the error repeats 16 times, the system is shut down.
 - Reset condition: Continuous run for about 11 minutes without any other error
-

Supposed
Causes

- Disconnection of the compressor relay cable
- Defective compressor
- Defective outdoor unit PCB
- Start-up failure caused by the closed stop valve
- Input voltage is out of specification

Troubleshooting



Check No.29
Refer to P.113



Caution Be sure to turn off the power switch before connecting or disconnecting connectors, or parts may be damaged.

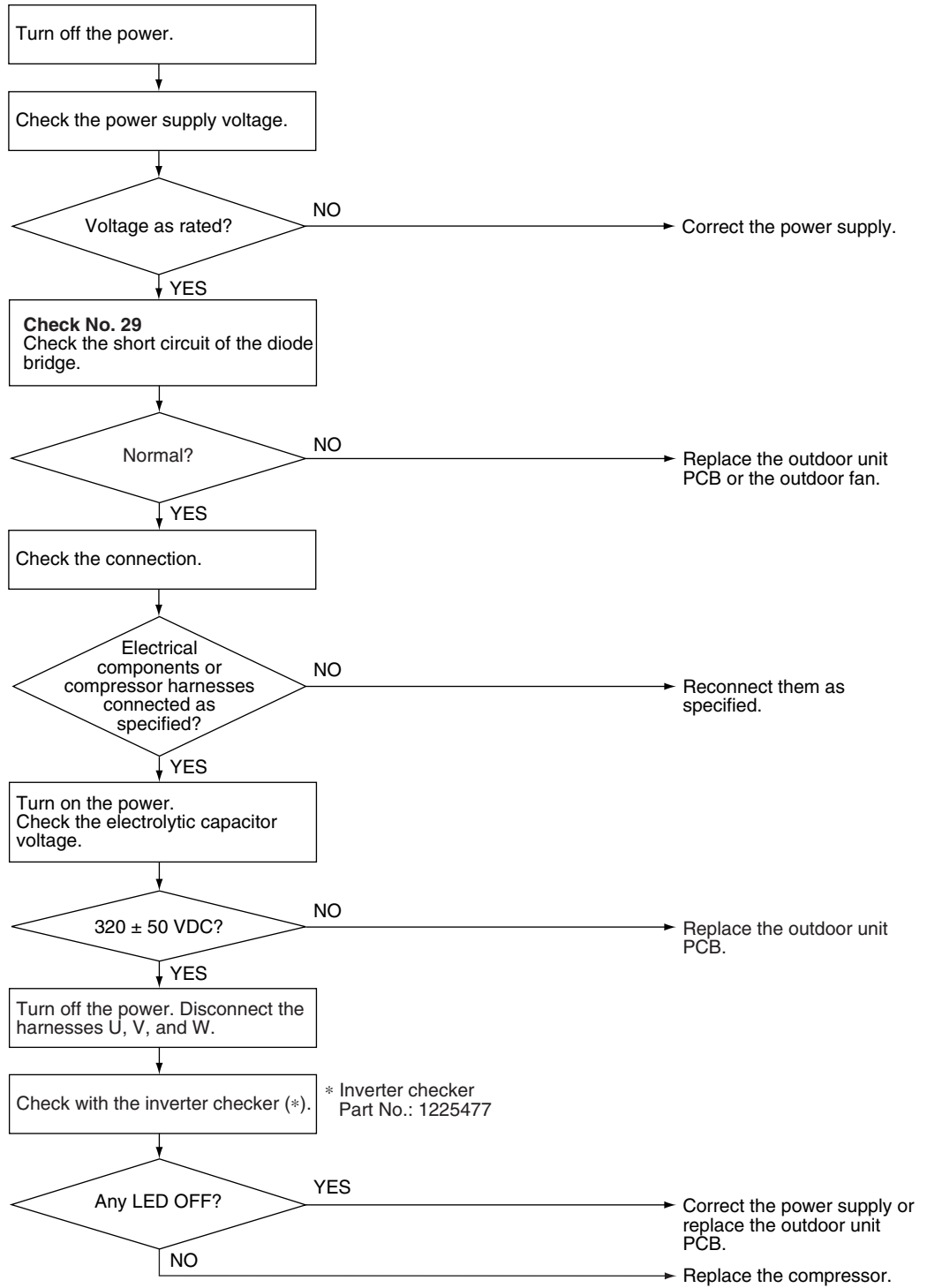

(R11380)

4.19 DC Voltage / Current Sensor Abnormality

Remote
Controller
Display



Method of
Malfunction
Detection

DC voltage or DC current sensor abnormality is identified based on the compressor running frequency and the input current.

Malfunction
Decision
Conditions

- The compressor running frequency is above 52 Hz.
- If the error repeats 4 times, the system is shut down.
- Reset condition: Continuous run for about 60 minutes without any other error

Supposed
Causes

- Defective outdoor unit PCB

Troubleshooting



Caution Be sure to turn off the power switch before connecting or disconnecting connectors, or parts may be damaged.

Replace the outdoor unit PCB.

4.20 Thermistor or Related Abnormality (Outdoor Unit)

Remote
Controller
Display

H3, U3, U5, P4

Method of
Malfunction
Detection

This fault is identified based on the thermistor input voltage to the microcomputer.
A thermistor fault is identified based on the temperature sensed by each thermistor.

Malfunction
Decision
Conditions

- The thermistor input voltage is above 4.96 V or below 0.04 V with the power on.
- U3 error is judged if the discharge pipe temperature is lower than the heat exchanger temperature.

Supposed
Causes

- Disconnection of the connector for the thermistor
- Defective thermistor
- Defective heat exchanger thermistor in the case of U3 error (outdoor heat exchanger thermistor in cooling operation, or indoor heat exchanger thermistor in heating operation)
- Defective outdoor unit PCB
- Defective indoor unit PCB

Troubleshooting

In case of “P4”



Caution

Be sure to turn off the power switch before connecting or disconnecting connectors, or parts may be damaged.

Replace the outdoor unit PCB.

P4 : Radiation fin thermistor

Troubleshooting



Check No.06
Refer to P.109

In case of "H3" "J3" "J5"



Caution Be sure to turn off the power switch before connecting or disconnecting connectors, or parts may be damaged.

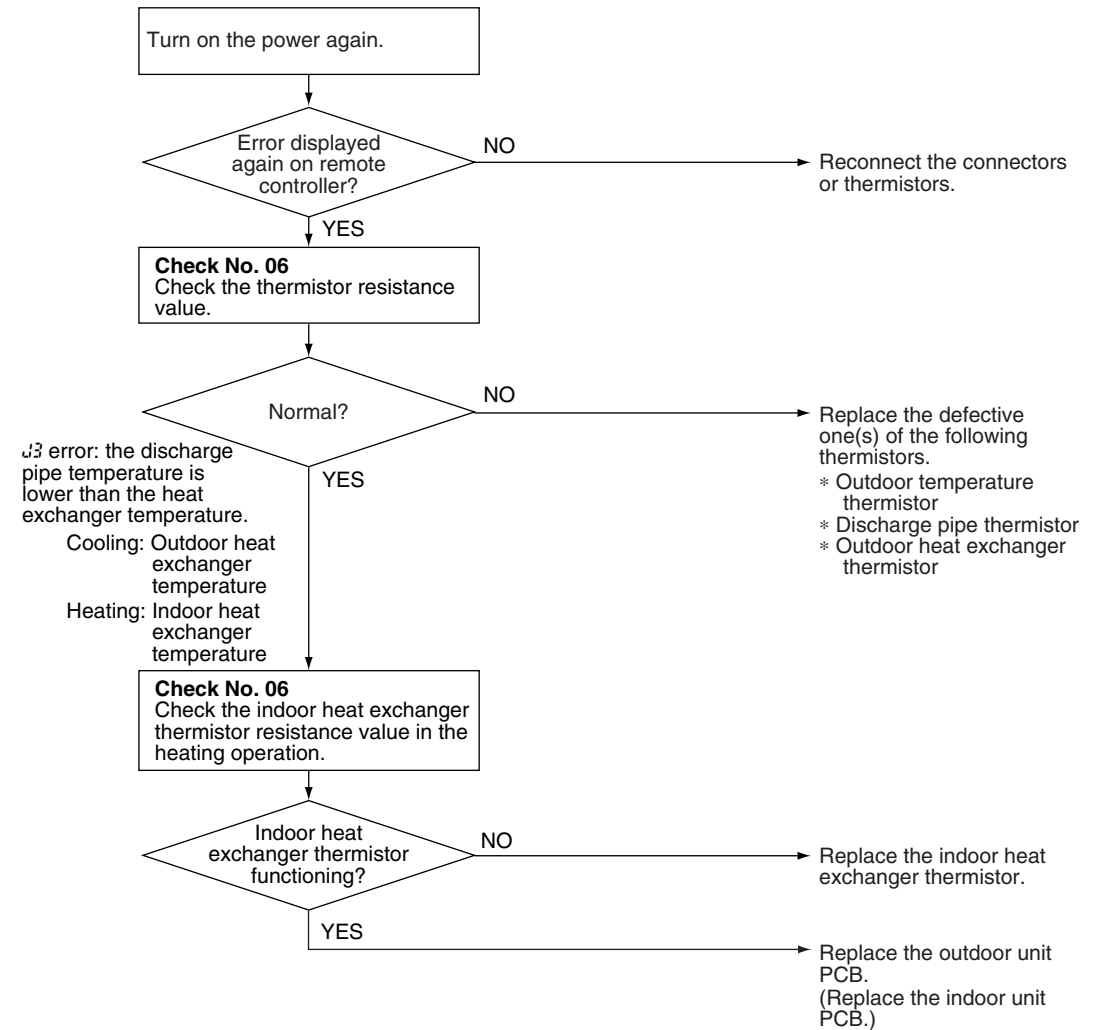

(R11905)

- H3 : Outdoor temperature thermistor
- J3 : Discharge pipe thermistor
- J5 : Outdoor heat exchanger thermistor

4.21 Electrical Box Temperature Rise

Remote
Controller
Display



Method of
Malfunction
Detection

An electrical box temperature rise is detected by checking the radiation fin thermistor with the compressor off.

Malfunction
Decision
Conditions

- With the compressor off, the radiation fin temperature is above A°C.
- The error is cleared when the radiation fin temperature drops below B°C.
- To cool the electrical components, the outdoor fan starts when the radiation fin temperature rises above C°C and stops when it drops below B°C.

A (°C)	98
B (°C)	75
C (°C)	83

Supposed
Causes

- Defective outdoor fan motor
- Short circuit
- Defective radiation fin thermistor
- Disconnection of connector
- Defective outdoor unit PCB

Troubleshooting



Check No.07
Refer to P.110



Check No.09
Refer to P.111



Caution

Be sure to turn off the power switch before connecting or disconnecting connectors, or parts may be damaged.

Turn off the power and turn it on again.

WARNING

To cool the electrical components, the outdoor fan starts when the radiation fin temperature rises above $C^{\circ}C$ and stops when it drops below $B^{\circ}C$.

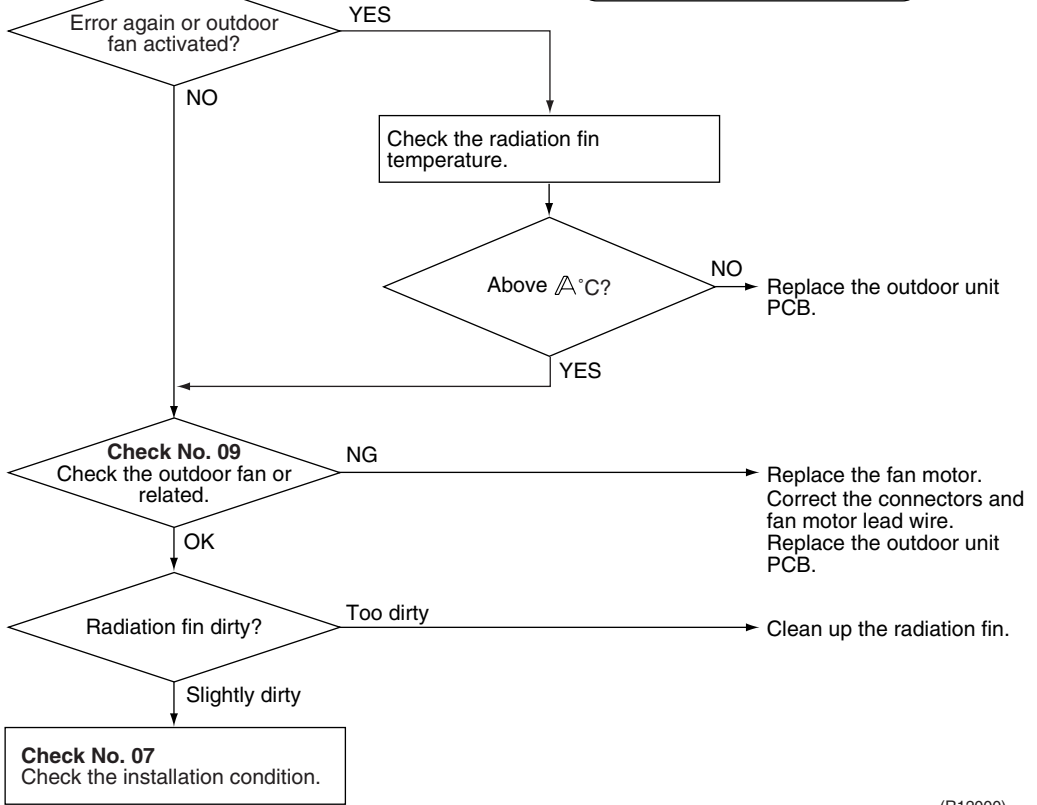

(R12000)

A (°C)	98
B (°C)	75
C (°C)	83

4.22 Radiation Fin Temperature Rise

Remote
Controller
Display

L4

Method of
Malfunction
Detection

A radiation fin temperature rise is detected by checking the radiation fin thermistor with the compressor on.

Malfunction
Decision
Conditions

- If the radiation fin temperature with the compressor on is above A °C.
- The error is cleared when the radiation fin temperature drops below B °C.
- If the error repeats, the system is shut down.
- Reset condition: Continuous run for about 60 minutes without any other error

A (°C)	98
B (°C)	78

Supposed
Causes

- Defective outdoor fan motor
- Short circuit
- Defective radiation fin thermistor
- Disconnection of connector
- Defective outdoor unit PCB
- Silicon grease is not applied properly on the radiation fin after replacing the outdoor unit PCB.

Troubleshooting



Check No.07
Refer to P.110



Check No.09
Refer to P.111



Caution

Be sure to turn off the power switch before connecting or disconnecting connectors, or parts may be damaged.

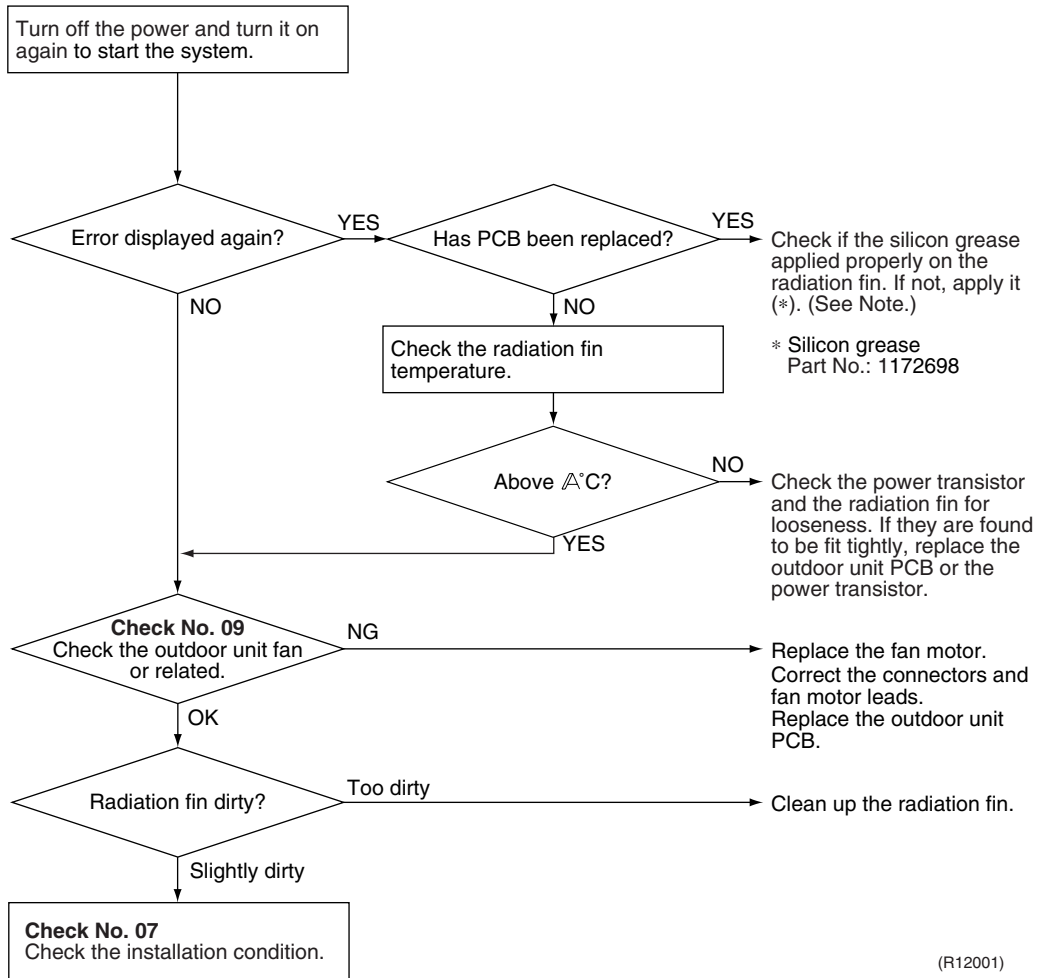

(R12001)

A (°C)	98
--------	----



Note: Refer to “Application of silicon grease to a power transistor and a diode bridge” on page 178 for detail.

4.23 Output Overcurrent Detection

Remote
Controller
Display

LS

Method of
Malfunction
Detection

An output overcurrent is detected by checking the current that flows in the inverter DC section.

Malfunction
Decision
Conditions

- A position signal error occurs while the compressor is running.
 - A speed error occurs while the compressor is running.
 - An output overcurrent signal is fed from the output overcurrent detection circuit to the microcomputer.
 - If the error repeats, the system is shut down.
 - Reset condition: Continuous run for about 11 minutes without any other error
-

Supposed
Causes

- Poor installation condition
- Closed stop valve
- Defective power module
- Wrong internal wiring
- Abnormal supply voltage
- Defective outdoor unit PCB
- Defective compressor

Troubleshooting



Check No.07
Refer to P.110



Check No.08
Refer to P.110



Check No.13
Refer to P.112

Caution Be sure to turn off the power switch before connecting or disconnecting connectors, or parts may be damaged.

* An output overcurrent signal may result from wrong internal wiring. If the wires have been disconnected and reconnected and the system is interrupted by an output overcurrent, take the following procedure.

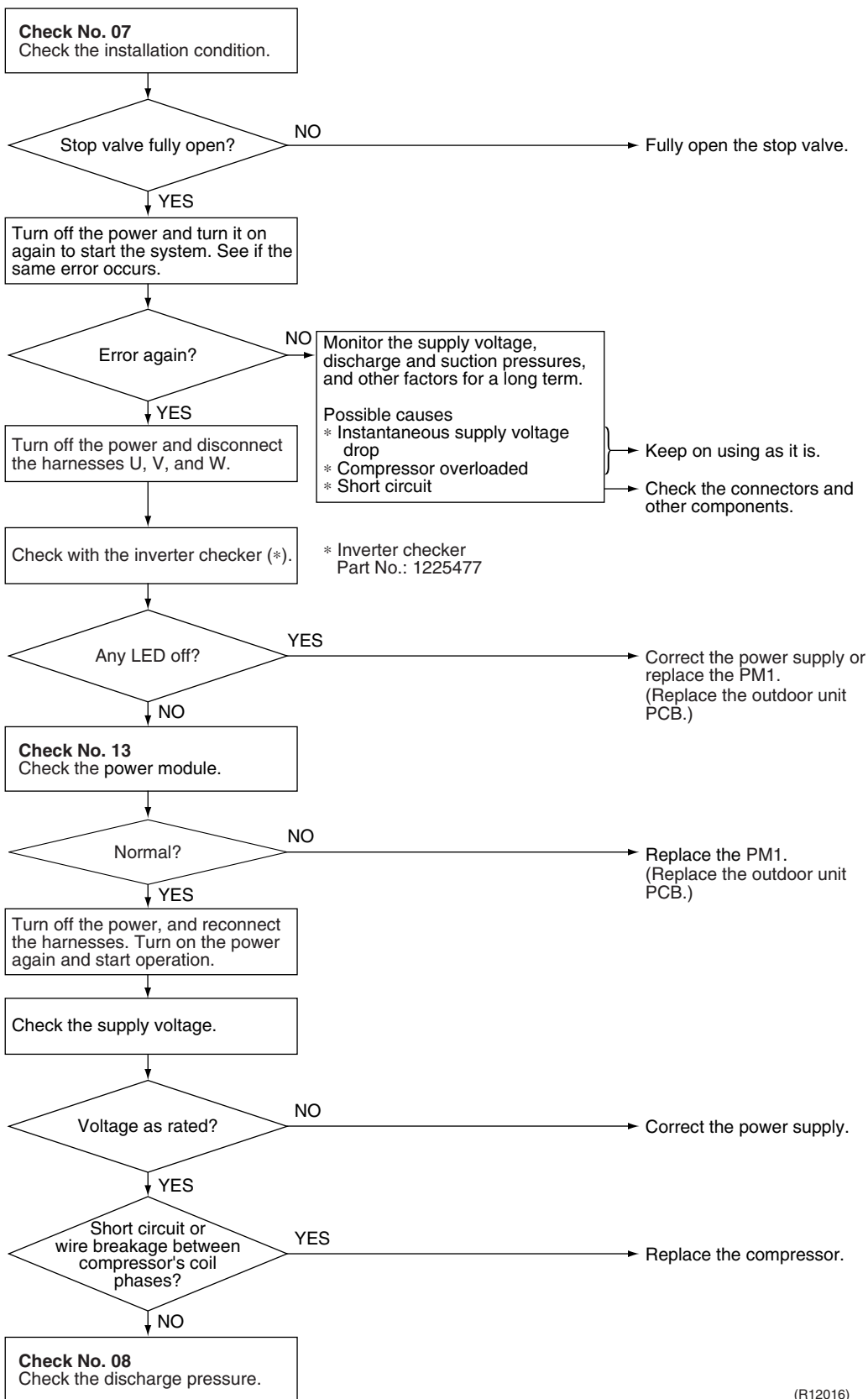

(R12016)

4.24 Refrigerant Shortage

Remote
Controller
Display



Method of
Malfunction
Detection

Refrigerant shortage detection I:

Refrigerant shortage is detected by checking the input current value and the compressor running frequency. If the refrigerant is short, the input current is smaller than the normal value.

Refrigerant shortage detection II:

Refrigerant shortage is detected by checking the discharge pipe temperature and the opening of the electronic expansion valve. If the refrigerant is short, the discharge pipe temperature tends to rise.

Refrigerant shortage detection III:

Refrigerant shortage is detected by checking the difference between suction and discharge temperature.

Malfunction
Decision
Conditions

Refrigerant shortage detection I:

The following conditions continue for 7 minutes.

- ◆ Input current × input voltage ≤ A × output frequency + B
- ◆ Output frequency > C

A (-)	B (W)	C (Hz)
640/256	0	55

Refrigerant shortage detection II :

The following conditions continue for 80 seconds.

- ◆ Opening of the electronic expansion valve ≥ D
- ◆ Discharge pipe temperature > E × target discharge pipe temperature + F

D (pulse)	E (-)	F (°C)
480	128/128	30

Refrigerant shortage detection III :

When the difference of the temperature is smaller than G °C, it is regarded as refrigerant shortage.

		G (°C)
Cooling	room temperature – indoor heat exchanger temperature	4.0
	outdoor heat exchanger temperature – outdoor temperature	4.0
Heating	indoor heat exchanger temperature – room temperature	3.0
	outdoor temperature – outdoor heat exchanger temperature	3.0

- If the error repeats 4 times, the system is shut down.
- Reset condition: Continuous run for about 60 minutes without any other error

Supposed
Causes

- Disconnection of the discharge pipe thermistor, indoor or outdoor heat exchanger thermistor, room or outdoor temperature thermistor
- Closed stop valve
- Refrigerant shortage (refrigerant leakage)
- Poor compression performance of compressor
- Defective electronic expansion valve

Troubleshooting



Check No.04
Refer to P.107



Check No.06
Refer to P.109



Caution Be sure to turn off the power switch before connecting or disconnecting connectors, or parts may be damaged.

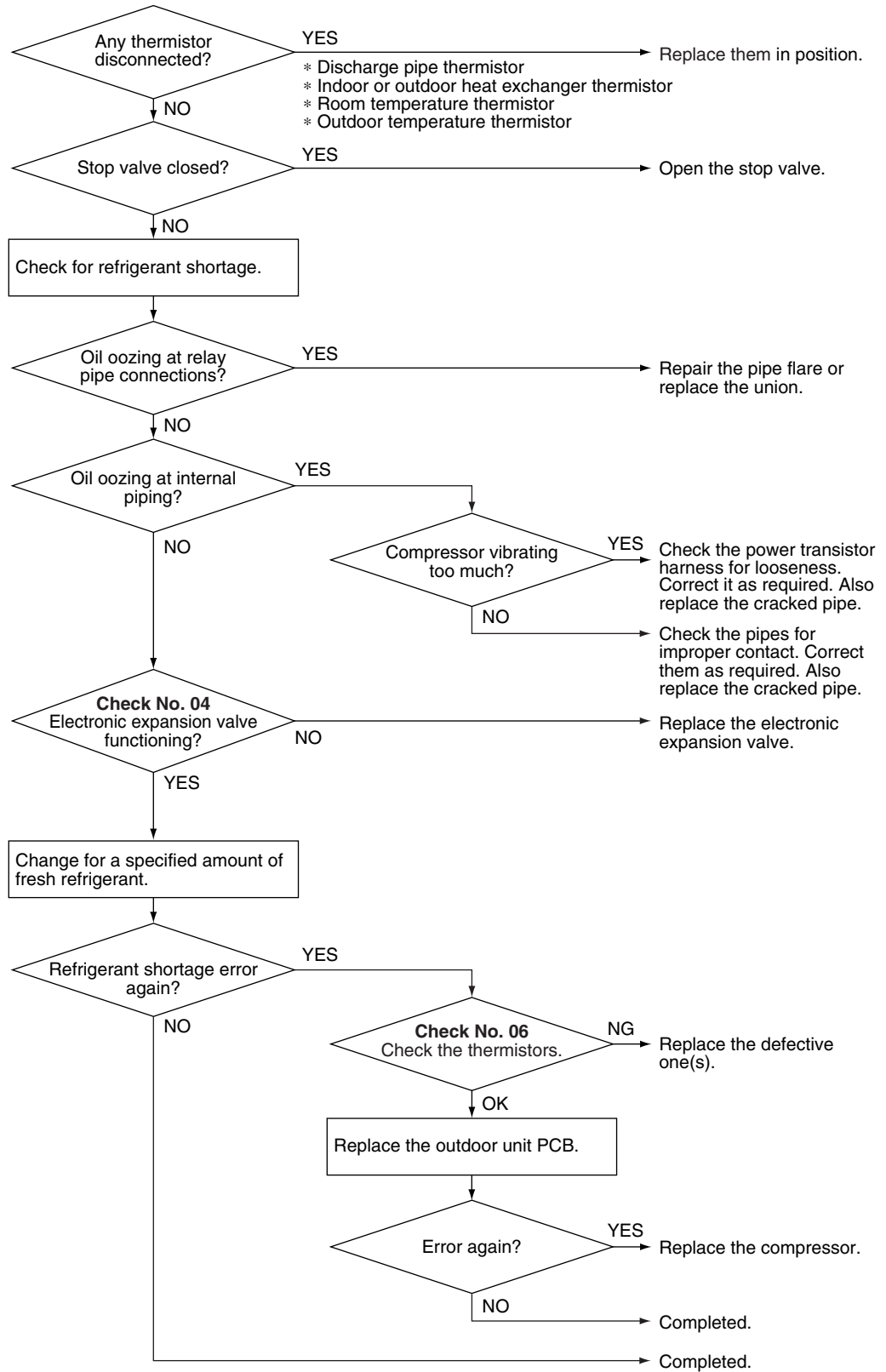

(R12015)

4.25 Low-voltage Detection or Over-voltage Detection

<p>Remote Controller Display</p>	<p>U2</p>
<p>Method of Malfunction Detection</p>	<p>Low-voltage detection: An abnormal voltage drop is detected by the DC voltage detection circuit.</p> <p>Over-voltage detection: An abnormal voltage rise is detected by the over-voltage detection circuit.</p>
<p>Malfunction Decision Conditions</p>	<p>Low-voltage detection:</p> <ul style="list-style-type: none"> ■ The voltage detected by the DC voltage detection circuit is below 180 V. <p>Over-voltage detection:</p> <ul style="list-style-type: none"> ■ An over-voltage signal is fed from the over-voltage detection circuit to the microcomputer. (The voltage is over 400 V.) ■ If the error repeats, the system is shut down. ■ Reset condition: Continuous run for about 11 minutes without any other error
<p>Supposed Causes</p>	<ul style="list-style-type: none"> ■ Supply voltage is not as specified. ■ Defective DC voltage detection circuit ■ Defective over-voltage detection circuit ■ Defective PAM control part ■ Layer short inside the fan motor winding

Troubleshooting

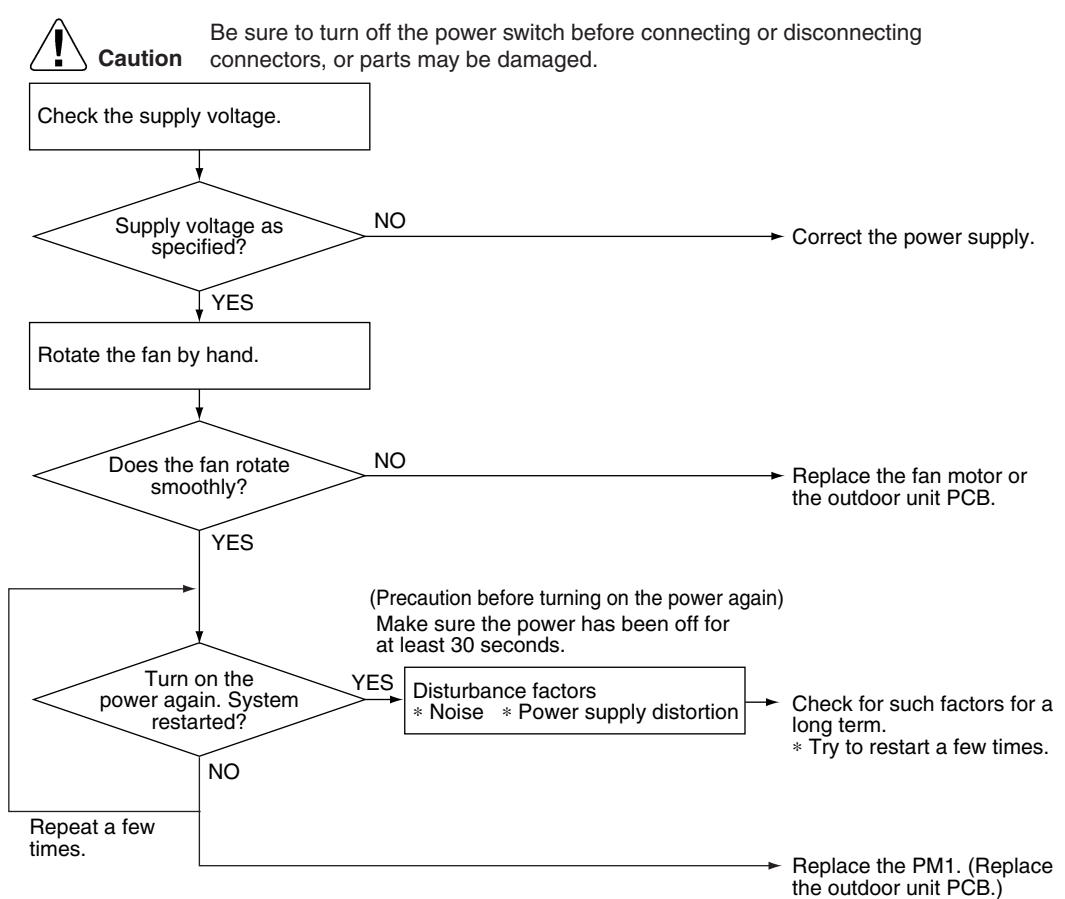

(R8402)

5. Check

5.1 How to Check

5.1.1 Fan Motor Connector Output Check

Check No.01

1. Check the connection of connector.
2. Check the motor power supply voltage output (pins 4 - 7).
3. Check the motor control voltage (pins 4 - 3).
4. Check the rotation command voltage (pins 4 - 2).
5. Check the rotation pulse (pins 4 - 1).

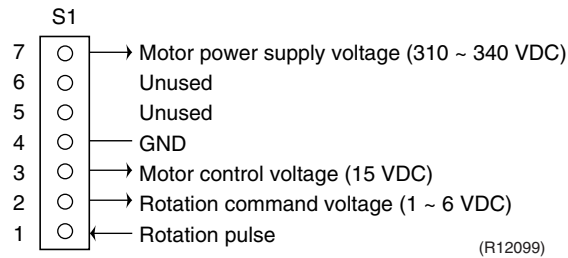

5.1.2 Electronic Expansion Valve Check

Check No.04

Conduct the followings to check the electronic expansion valve (EV).

1. Check to see if the EV connector is correctly connected to the PCB.
2. Turn the power off and on again, and check to see if the EV generate latching sound.
3. If the EV does not generate latching sound in the above step 2, disconnect the connector and check the continuity using a tester.
4. Check the continuity between the pins 1 - 6 and 3 - 6, and between the pins 2 - 5 and 4 - 5. If there is no continuity between the pins, the EV coil is faulty.

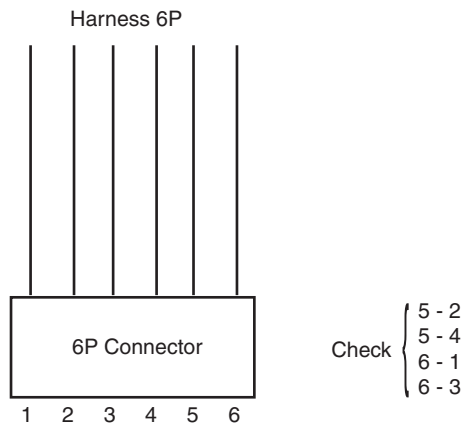

(R1082)

5. If the continuity is confirmed in the above step 3, the outdoor unit PCB is faulty.



Note: Please note that the latching sound varies depending on the valve type.

5.1.3 Four Way Valve Performance Check

Check No.05

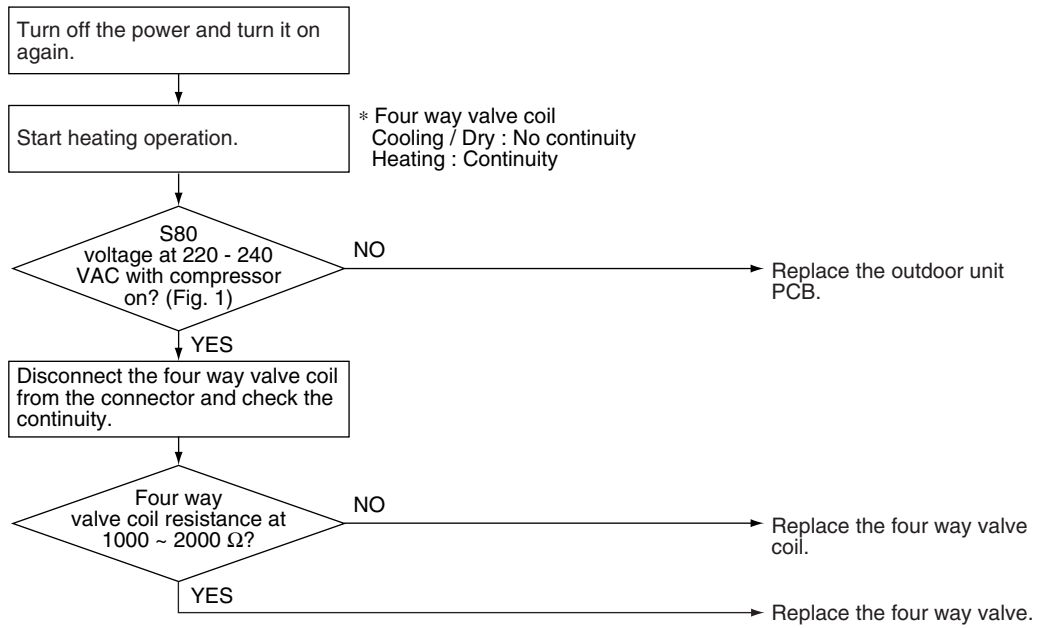

(R11903)

(Fig. 1)

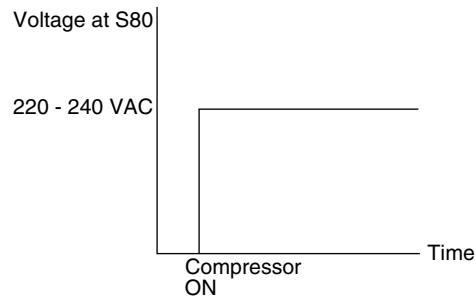

(R11904)

5.1.4 Thermistor Resistance Check

Check No.06

Disconnect the connectors of the thermistors from the PCB, and measure the resistance of each thermistor using tester.

The relationship between normal temperature and resistance is shown in the table and the graph below.

Temperature (°C)	Thermistor R25°C = 20 kΩ, B = 3950
-20	211.0 (kΩ)
-15	150.0
-10	116.5
-5	88.0
0	67.2
5	51.9
10	40.0
15	31.8
20	25.0
25	20.0
30	16.0
35	13.0
40	10.6
45	8.7
50	7.2

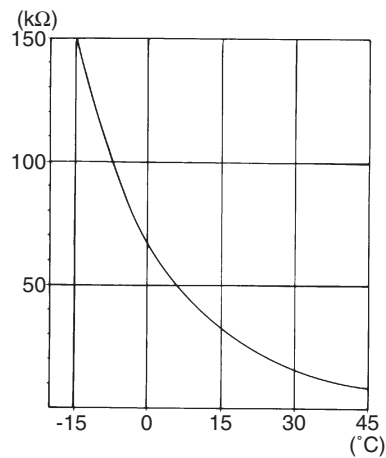

(R11905)

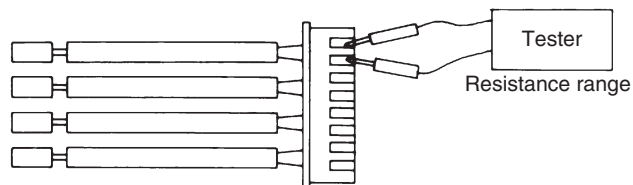

(R11906)

- For the models in which the thermistor is directly mounted on the PCB, disconnect the connector for the PCB and measure.

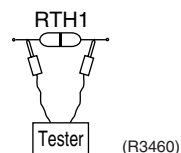

(R3460)

5.1.5 Installation Condition Check

Check No.07

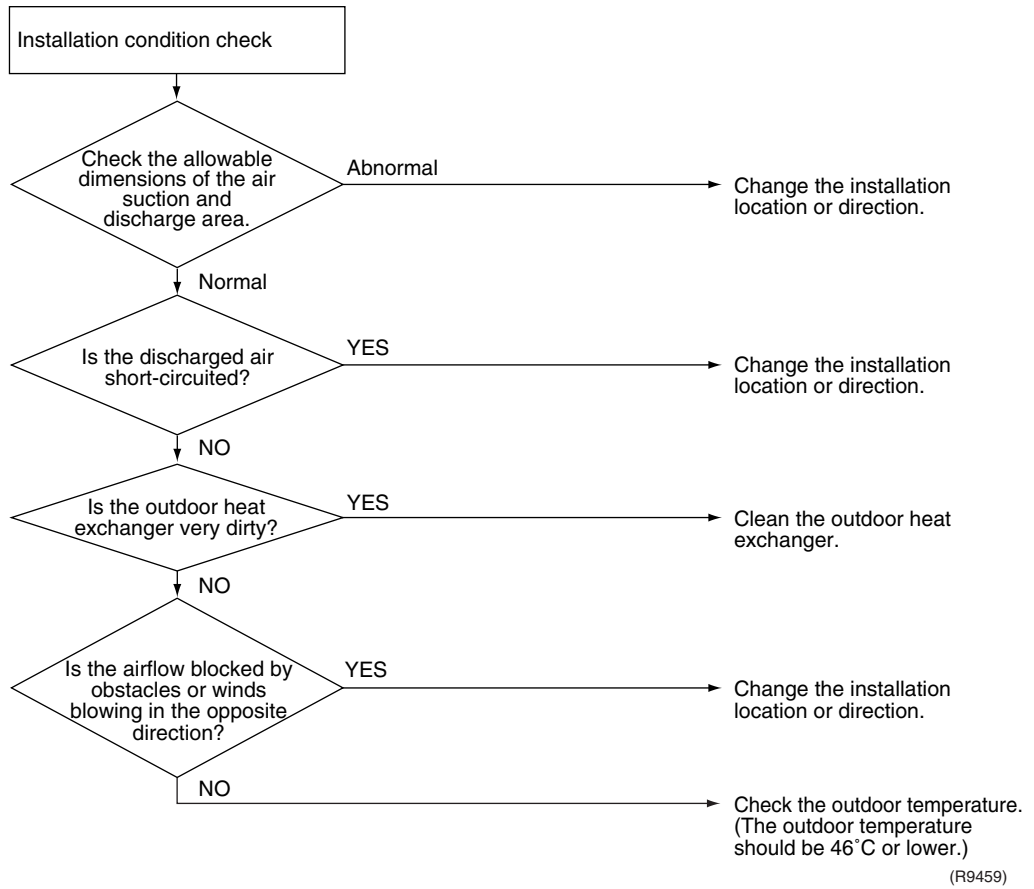

5.1.6 Discharge Pressure Check

Check No.08

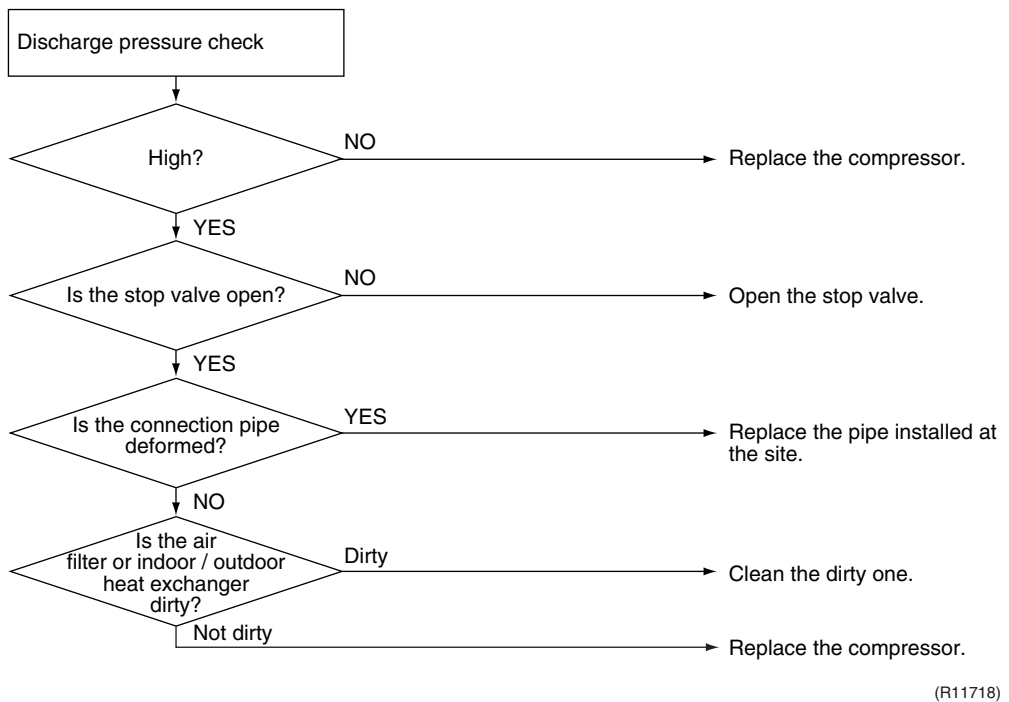

5.1.7 Outdoor Fan System Check

Check No.09

DC motor

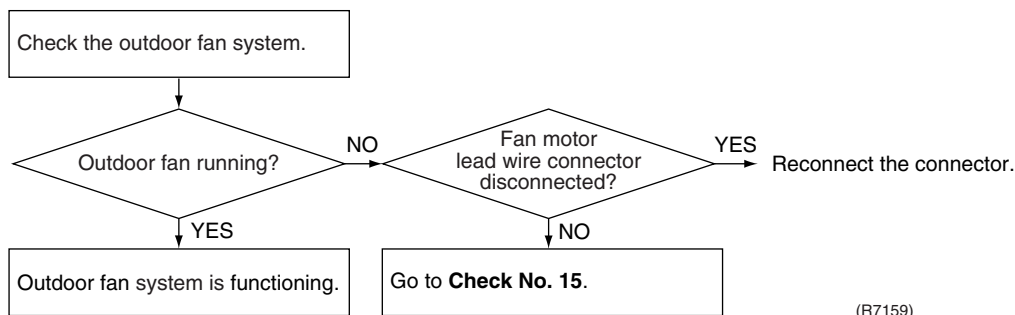

(R7159)

5.1.8 Power Supply Waveforms Check

Check No.10

Measure the power supply waveform between No. 1 and No. 2 on the terminal board, and check the waveform disturbance.

- Check to see if the power supply waveform is a sine wave. (Fig.1)
- Check to see if there is waveform disturbance near the zero cross. (sections circled in Fig.2)

Fig.1

Fig.2

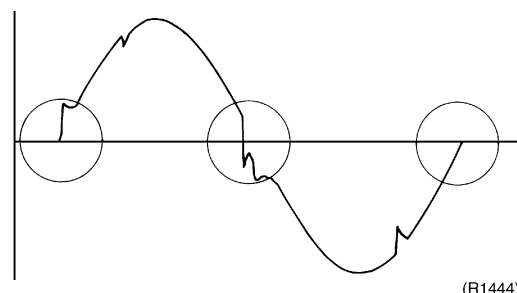
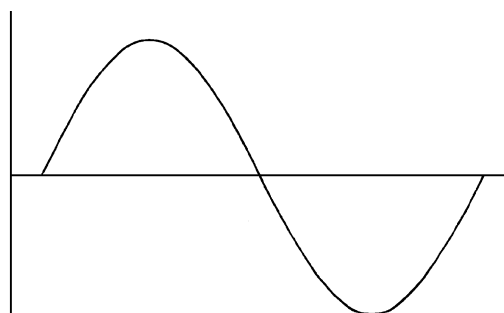

(R1736)

(R1444)

5.1.9 Inverter Units Refrigerant System Check

Check No.11

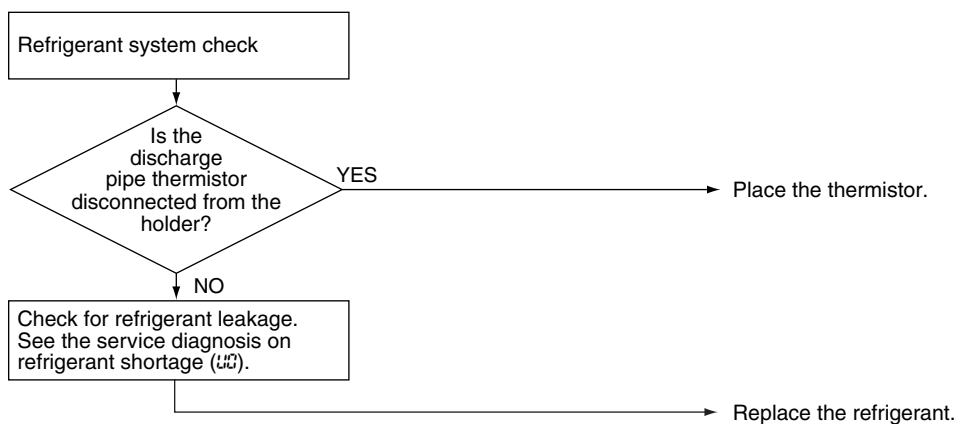

(R8259)

5.1.10 Power Module Check

Check No.13



Note: Check to make sure that the voltage between (+) and (-) of the diode bridge (DB1) is approx. 0 V before checking.

- Disconnect the compressor harness connector from the outdoor unit PCB. To disengage the connector, press the protrusion on the connector.
- Follow the procedure below to measure resistance between the terminals of the DB1 and the terminals of the compressor with a multi-tester. Evaluate the measurement results for a judgment.

Negative (-) terminal of tester (positive terminal (+) for digital tester)	DB1 (+)	UVW	DB1 (-)	UVW
Positive (+) terminal of tester (negative terminal (-) for digital tester)	UVW	DB1 (+)	UVW	DB1 (-)
Resistance in OK	several kΩ ~ several MΩ			
Resistance in NG	0 Ω or ∞			

5.1.11 Rotation Pulse Check on the Outdoor Unit PCB

Check No.15

<Outdoor fan motor>

1. Check that the voltage between the pins 10-11 is 15 VDC.
2. Check if the Hall IC generates the rotation pulse (0 ~ 15 VDC) 4 times between the pins 10-12, 10-13, when the fan motor is manually rotated once.

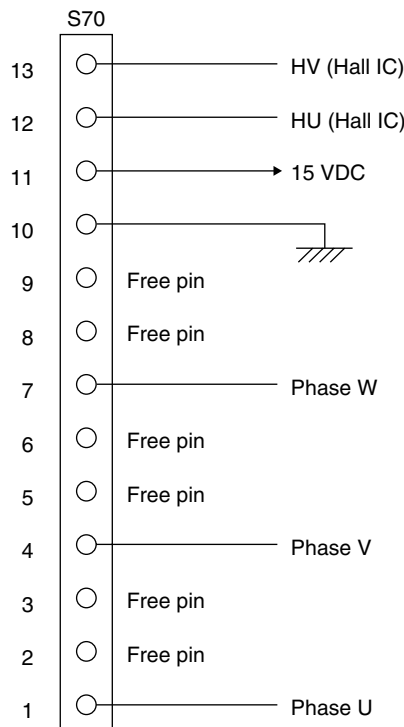

(R11907)

5.1.12 Main Circuit Short Check

Check No.29



Note: Check to make sure that the voltage between (+) and (-) of the diode bridge (DB1) is approx. 0 V before checking.

- Measure the resistance between the pins of the DB1 as below.
- If the resistance is ∞ or less than 1 k Ω , short circuit occurs on the main circuit.

(-) terminal of the tester (in case of digital, (+) terminal)	~ (2, 3)	+ (4)	~ (2, 3)	- (1)
(+) terminal of the tester (in case of digital, (-) terminal)	+ (4)	~ (2, 3)	- (1)	~ (2, 3)
Resistance in OK	several k Ω ~ several M Ω	∞	∞	several k Ω ~ several M Ω
Resistance in NG	0 Ω or ∞	0	0	0 Ω or ∞

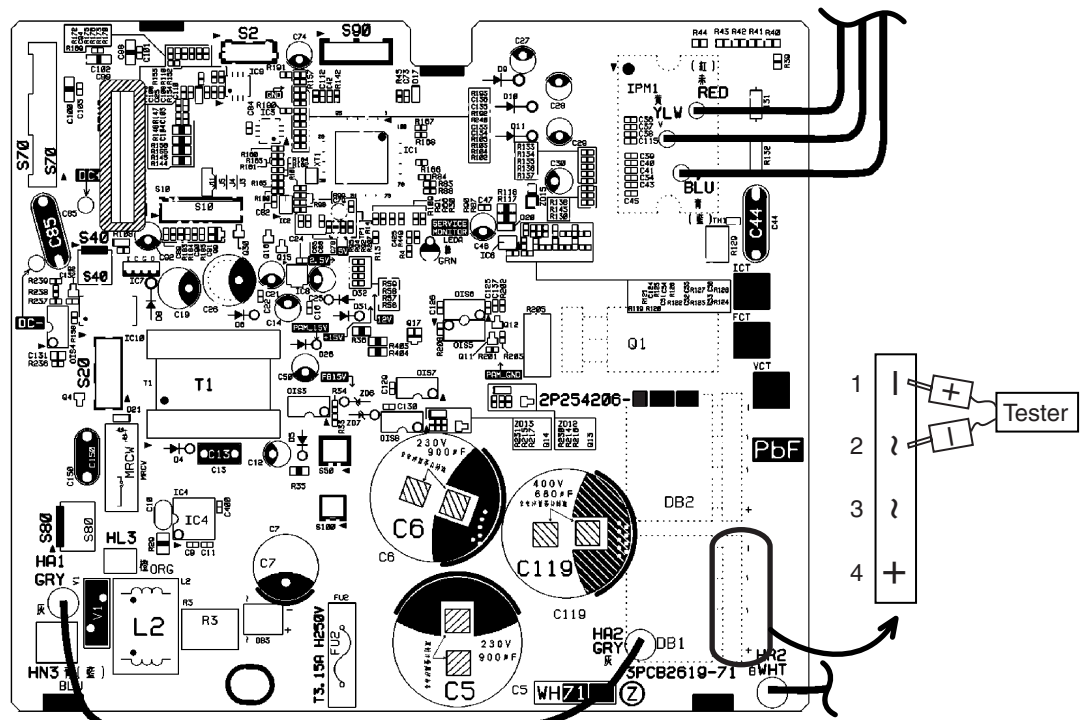

(R12035)

Part 7

Removal Procedure

1. Indoor Unit.....	115
1.1 Removal of Air Filter / Front Panel	115
1.2 Removal of Horizontal Blades	119
1.3 Removal of Front Grille	121
1.4 Removal of Front Panel Mechanism ASSY.....	124
1.5 Removal of Display Lens ASSY	126
1.6 Removal of Reduction Motor / Limit Switch.....	127
1.7 Removal of Fan Guard / Electrical Box	129
1.8 Removal of PCB.....	132
1.9 Removal of Swing Motor	138
1.10 Removal of Indoor Heat Exchanger	139
1.11 Removal of Fan Rotor / Fan Motor.....	142
1.12 Removal of Vertical Blade ASSY	145
2. Outdoor Unit.....	146
2.1 Removal of Outer Panels / Fan Motor.....	146
2.2 Removal of Electrical Box	155
2.3 Removal of PCB.....	158
2.4 Removal of Reactor / Partition Plate	166
2.5 Removal of Sound Blanket.....	168
2.6 Removal of Four Way Valve.....	170
2.7 Removal of Compressor.....	173

1. Indoor Unit

1.1 Removal of Air Filter / Front Panel

Procedure



Warning

Be sure to wait for 10 minutes or more after turning off all power supplies before disassembling work.

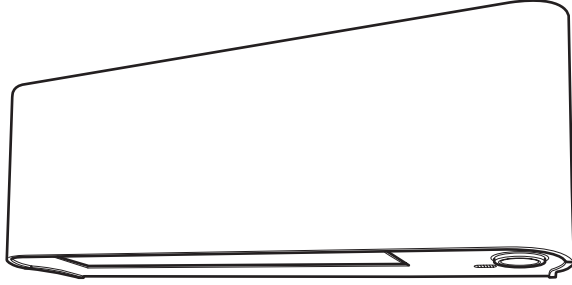
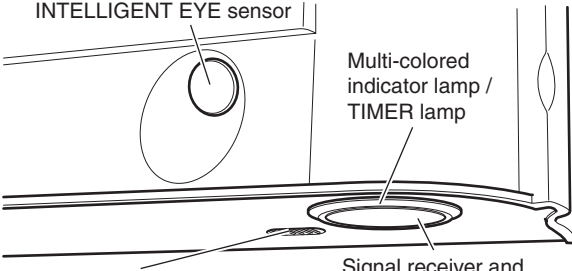
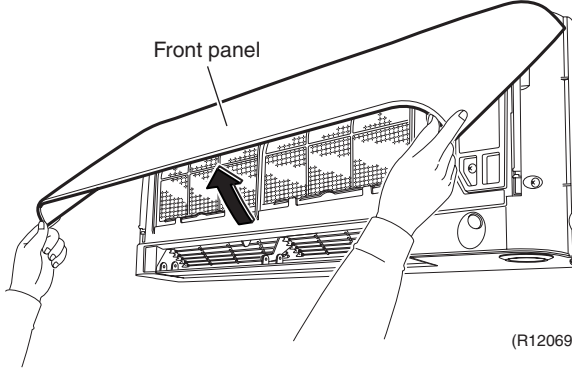
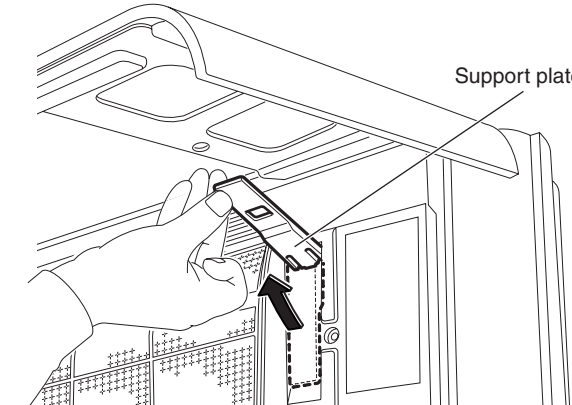
Step	Procedure	Points
1. Appearance feature	 <p>(R12067)</p>  <p>(R12068)</p>	<ul style="list-style-type: none"> When the signal receiver catches a signal from the remote controller, it produces beep sound and the color of the lamp changes. Refer to page 44 for detail.
2. Remove the air filter.	<p>1 Open the front panel.</p>  <p>(R12069)</p> <p>2 Keep the front panel open with the support plate.</p>  <p>(R12070)</p>	

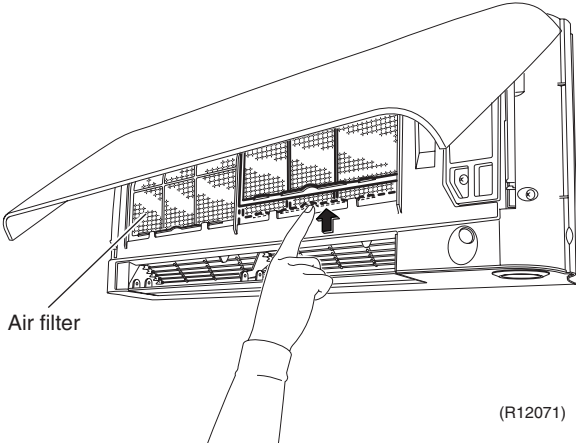
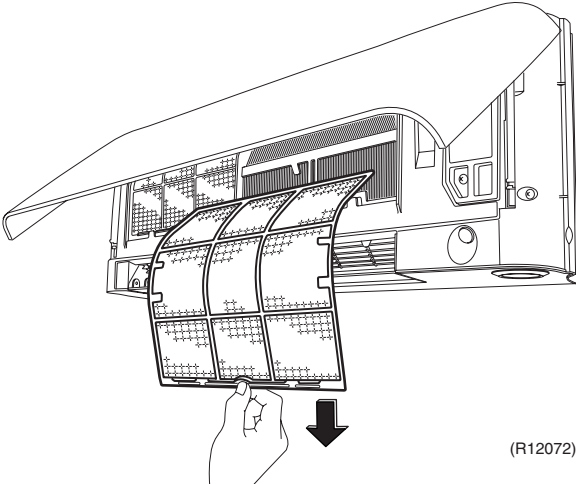
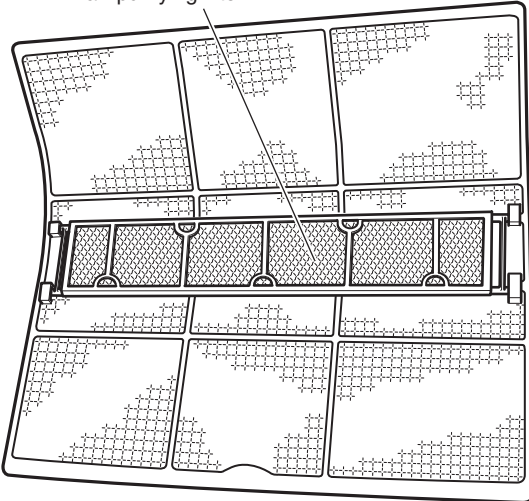
Step	Procedure	Points
<p>3</p>	<p>Lift the air filter upwards slightly, and then pull it out downwards.</p>  <p>Air filter</p> <p>(R12071)</p>  <p>(R12072)</p>	<ul style="list-style-type: none"> ■ The air filter is not marked for difference between the right and left sides. ■ The air filter can be set easily by inserting it along the guides. ■ Be sure to insert the hooks (at 2 lower positions) when mounting the air filter.
<p>3.</p>	<p>Remove the Titanium apatite photocatalytic air-purifying filter.</p>  <p>Titanium apatite photocatalytic air-purifying filter</p> <p>(R12073)</p>	<ul style="list-style-type: none"> ■ The Titanium apatite photocatalytic air-purifying filter is not marked for difference between the right and left sides.
<p>1</p>	<p>The Titanium apatite photocatalytic air-purifying filter is attached to the rear of the air filter.</p>	

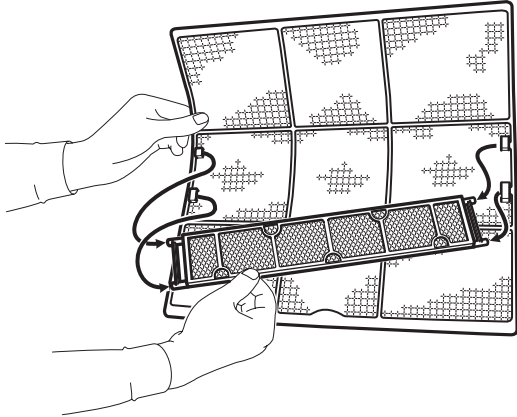
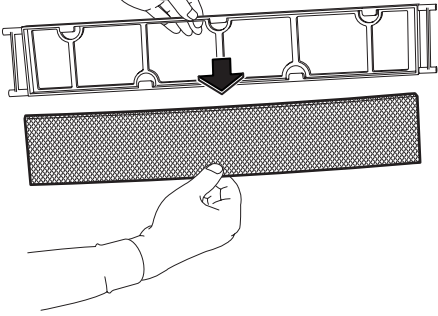
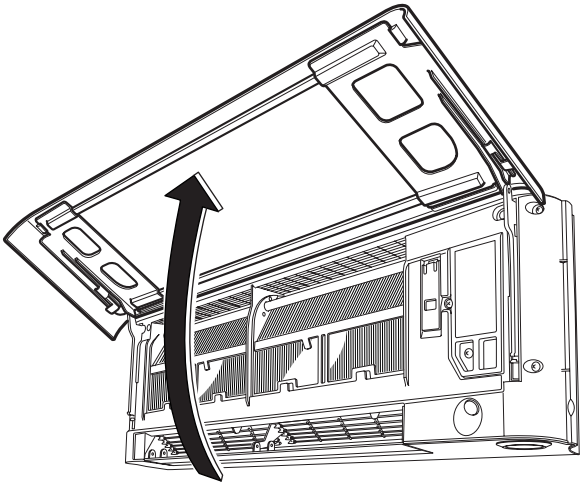
Step	Procedure	Points
2	<p>Release the protrusions and remove the Titanium apatite photocatalytic air-purifying filter frame.</p> 	
3	<p>Remove the Titanium apatite photocatalytic air-purifying filter.</p>  <p>(R12074)</p>	
4. Remove the front panel.	<p>1 Open the front panel at least 90 degrees.</p>  <p>(R12075)</p>	

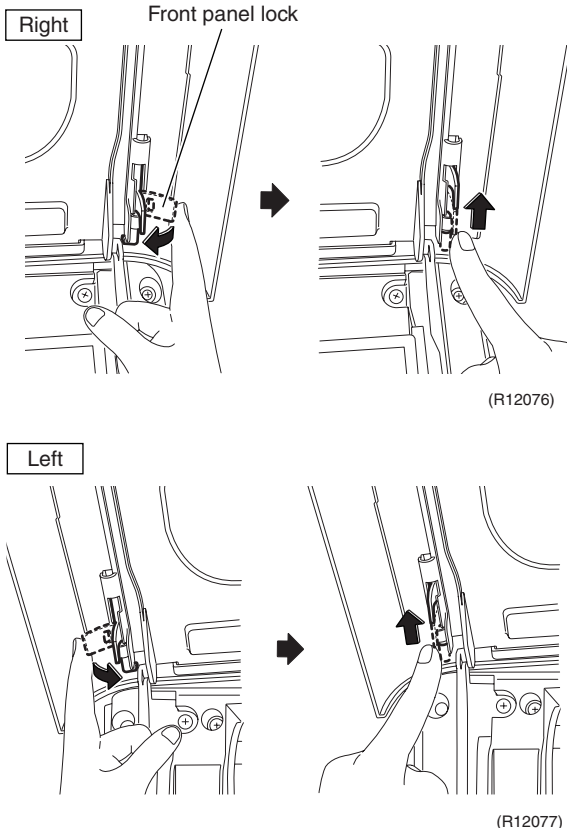
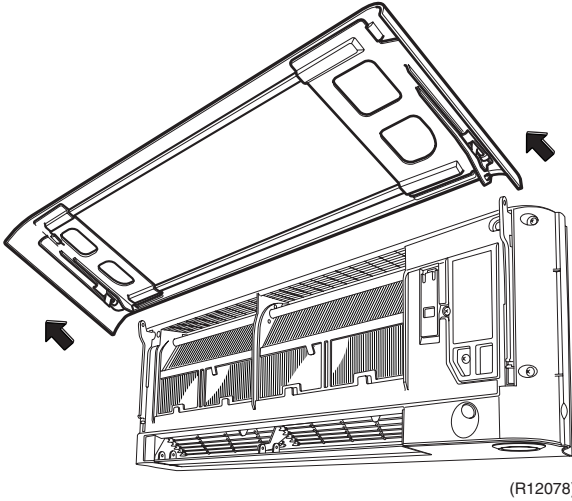
Step	Procedure	Points
2	<p>Release the front panel locks on each side.</p>  <p>Right</p> <p>Front panel lock</p> <p>(R12076)</p> <p>Left</p> <p>(R12077)</p>	
3	<p>Remove the front panel.</p>  <p>(R12078)</p>	

1.2 Removal of Horizontal Blades

Procedure



Warning

Be sure to wait for 10 minutes or more after turning off all power supplies before disassembling work.

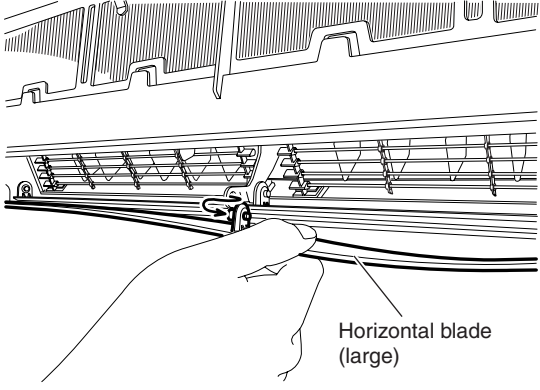
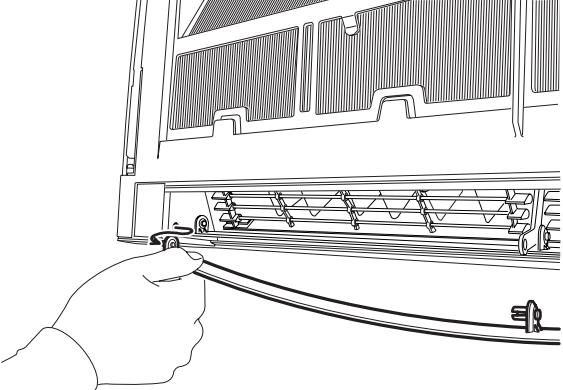
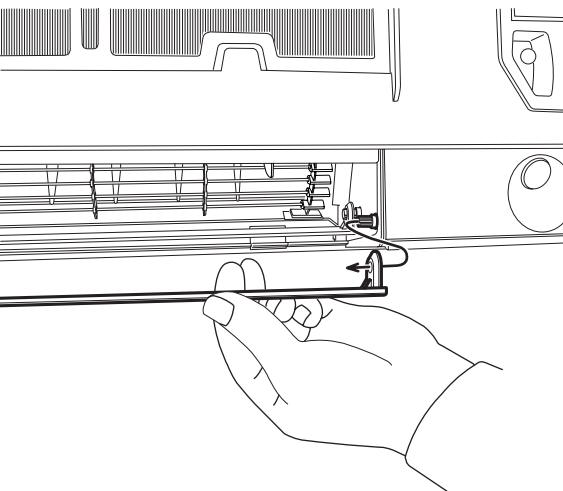
Step	Procedure	Points
1.	Remove the horizontal blade (large).	
1	Bend the horizontal blade (large) slightly and release the center shaft.	
	 <p style="text-align: right;">(R12079)</p>	
2	Release the left shaft.	
	 <p style="text-align: right;">(R12080)</p>	
3	Slide the horizontal blade (large) to the left and release the right shaft.	
	 <p style="text-align: right;">(R12081)</p>	

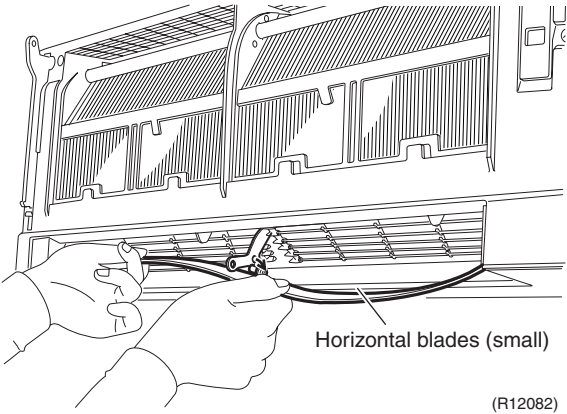
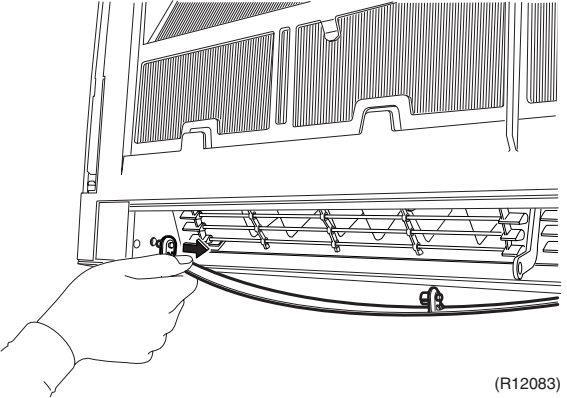
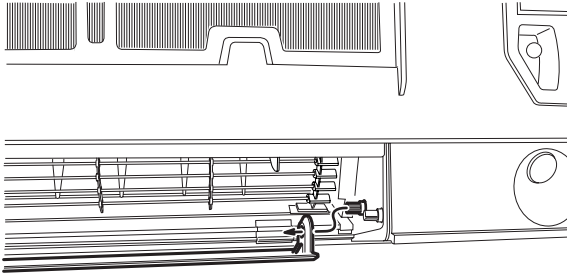
Step	Procedure	Points
2.	Remove the horizontal blade (small).	
1	<p>Bend the horizontal blade (small) slightly and release the center shaft.</p>  <p>Horizontal blades (small)</p> <p>(R12082)</p>	
2	<p>Release the left shaft.</p>  <p>(R12083)</p>	
3	<p>Slide the horizontal blade (small) to the left and release the right shaft.</p>  <p>(R12084)</p>	

1.3 Removal of Front Grille

Procedure



Warning

Be sure to wait for 10 minutes or more after turning off all power supplies before disassembling work.

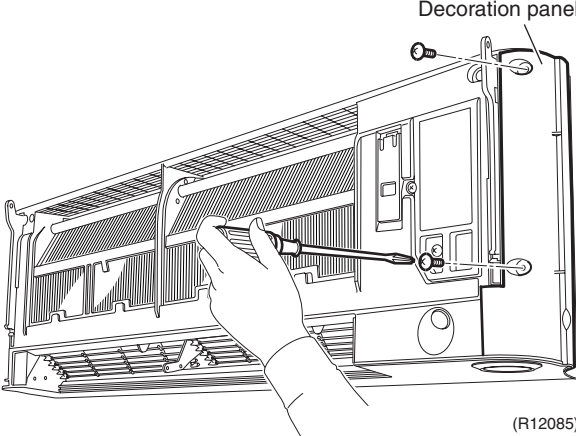
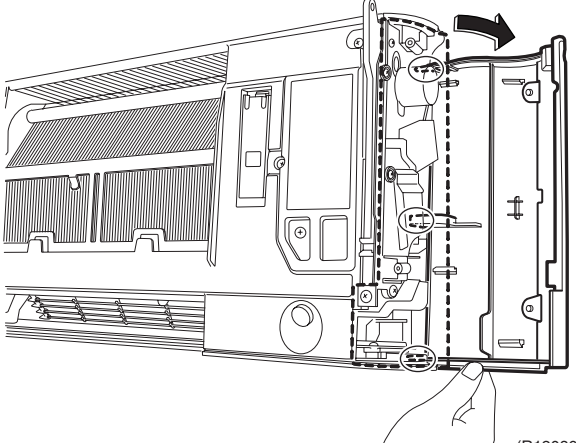
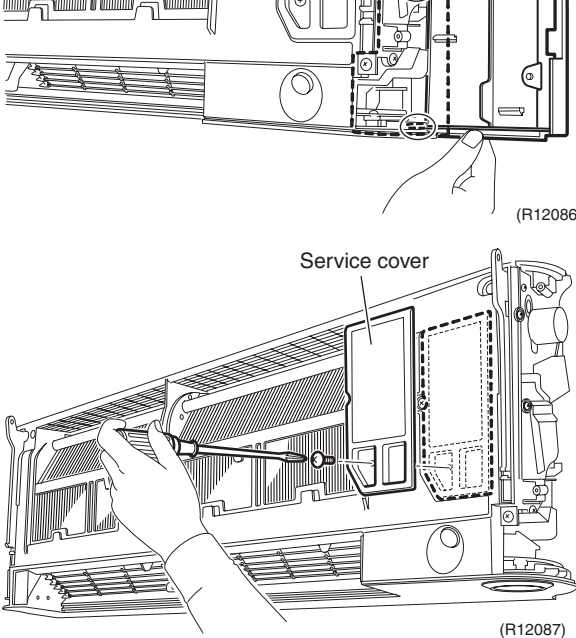
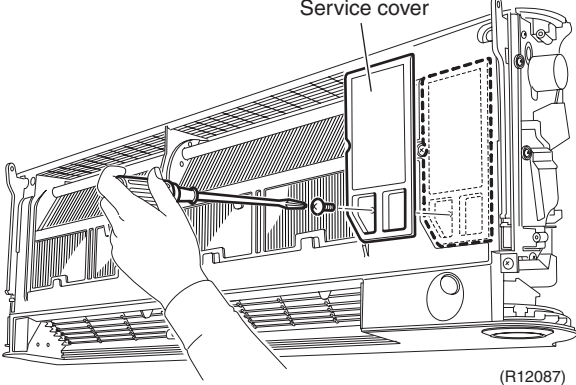
Step	Procedure	Procedure	Points
1	Remove the 2 screws of the decoration panel (right).	 <p style="text-align: right;">(R12085)</p>	
2	Open the decoration panel (right). Unfasten the 3 hooks and remove it.	 <p style="text-align: right;">(R12086)</p>	
3	Remove the decoration panel (left) in the same way.	 <p style="text-align: right;">(R12087)</p>	
4	Remove the screw and remove the service cover.	 <p style="text-align: right;">(R12087)</p>	

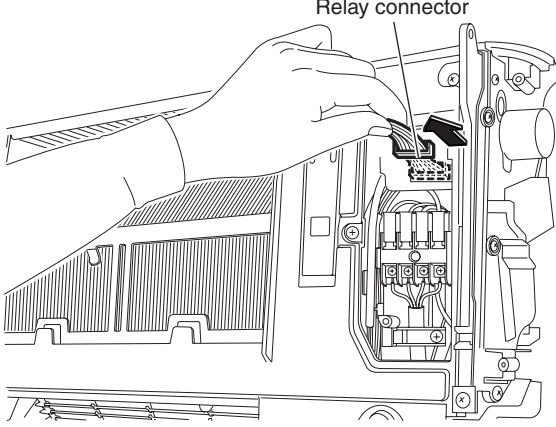
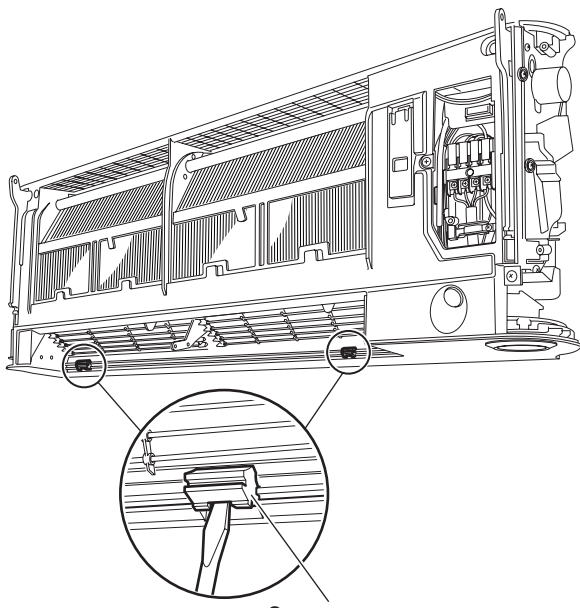
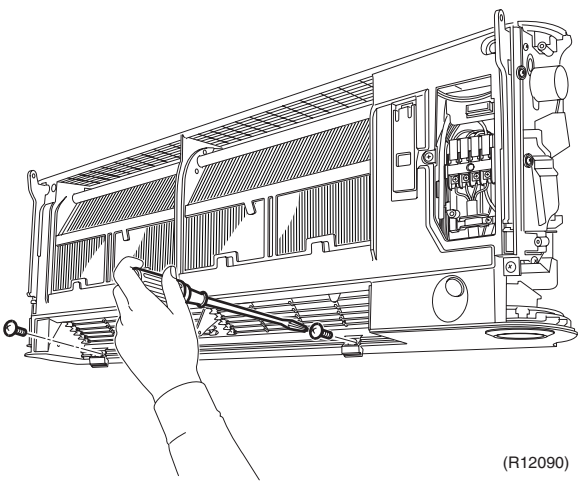
Step	Procedure	Procedure	Points
5	Disconnect the relay connector for the reduction motor.	 <p>Relay connector</p> <p>(R12088)</p>	
6	Open the 2 screw covers with a flat screwdriver.	 <p>Screw cover</p> <p>(R12089)</p>	
7	Remove the 2 screws.	 <p>(R12090)</p>	

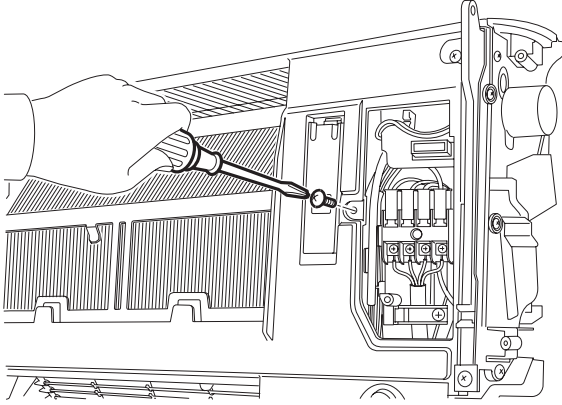
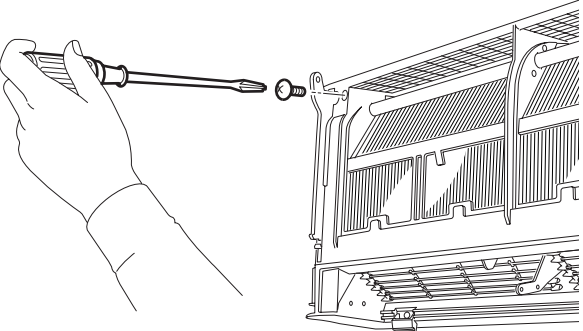
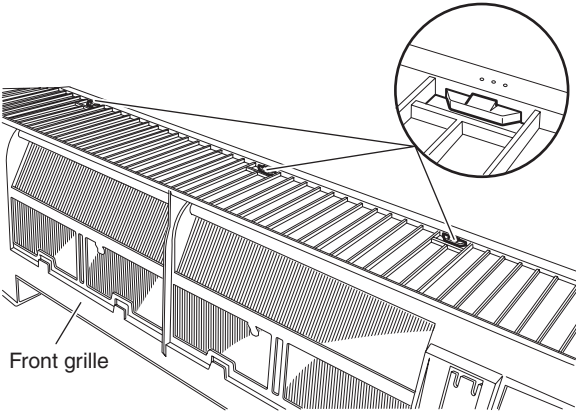
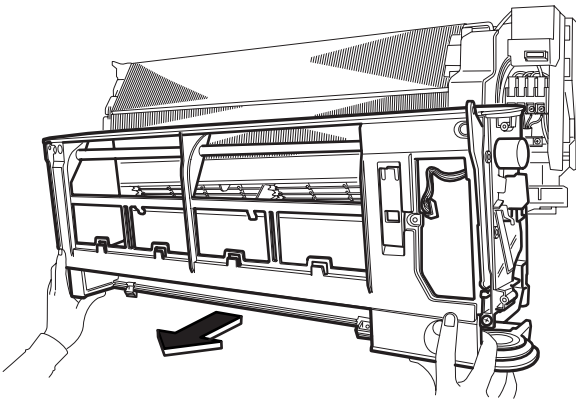
Step		Procedure	Points
8	Remove the screw.	 <p>(R12091)</p>	
9	Remove the screw.	 <p>(R12164)</p>	
10	Unfasten the 3 hooks on the top of the front grille.	 <p>Front grille</p> <p>(R12092)</p>	
11	Remove the front grille.	 <p>(R12093)</p>	

1.4 Removal of Front Panel Mechanism ASSY



Procedure



Warning

Be sure to wait for 10 minutes or more after turning off all power supplies before disassembling work.

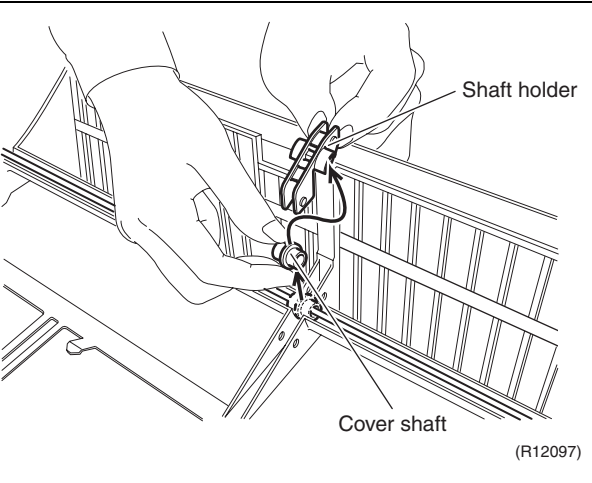
Step	Procedure	Procedure	Points
1	Remove the 2 screws of the front grille (right).	<p>(R12094)</p>	
2	Remove the guide panel.	<p>Guide panel</p> <p>(R12095)</p>	
3	Remove the front panel mechanism ASSY (right), holding the shaft.	<p>Shaft</p> <p>Front panel mechanism ASSY</p> <p>(R12096)</p>	<p>■ Remove the front panel mechanism ASSY (left) in the same way.</p>

Step	Procedure	Points
4	<p>Remove the shaft holder and the cover shaft.</p> 	
5	<p>Remove the shaft.</p> 	

1.5 Removal of Display Lens ASSY

Procedure



Warning

Be sure to wait for 10 minutes or more after turning off all power supplies before disassembling work.

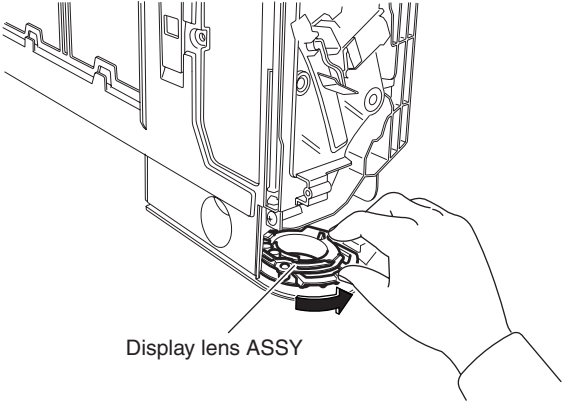
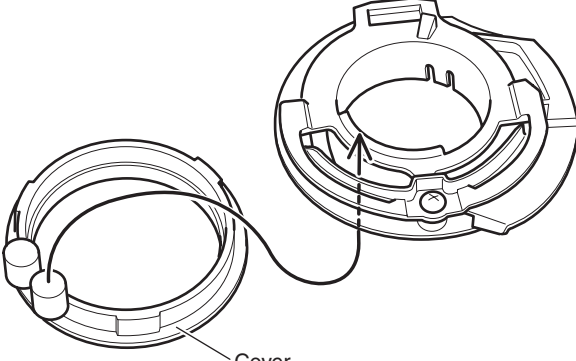
Step	Procedure	Procedure	Points
1	Remove the display lens ASSY by turning it counterclockwise.	 <p style="text-align: right;">(R12102)</p>	
2	Unfasten the hook and remove the cover.	 <p style="text-align: right;">(R12103)</p>	

1.6 Removal of Reduction Motor / Limit Switch

Procedure



Warning

Be sure to wait for 10 minutes or more after turning off all power supplies before disassembling work.

Step	Procedure	Procedure	Points
1	Cut the clamp of the front panel mechanism ASSY (right).	<p>(R12104)</p>	
2	Release the harness from the hooks.	<p>(R12105)</p>	
3	Pull out the terminals of the limit switch.	<p>Limit switch (R12106)</p>	

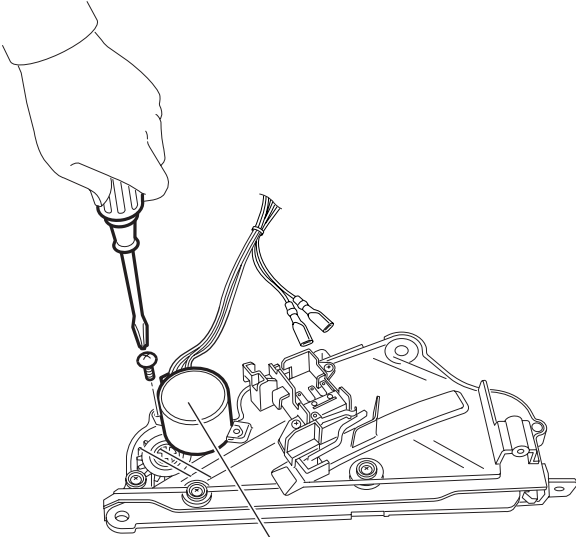
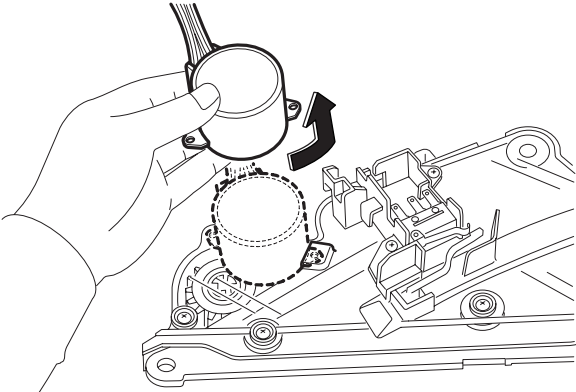
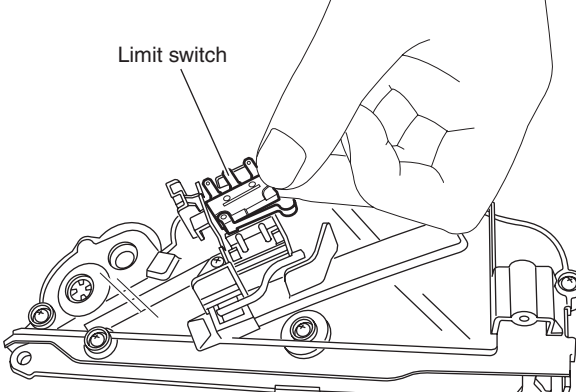
Step	Procedure	Points
4	Remove the screw of the reduction motor.	
	 <p style="text-align: center;">Reduction motor</p> <p style="text-align: right;">(R12107)</p>	
5	Remove the reduction motor by turning it counterclockwise.	
	 <p style="text-align: right;">(R12108)</p>	
6	Remove the limit switch.	
	 <p style="text-align: right;">(R12109)</p>	

1.7 Removal of Fan Guard / Electrical Box

Procedure



Warning

Be sure to wait for 10 minutes or more after turning off all power supplies before disassembling work.

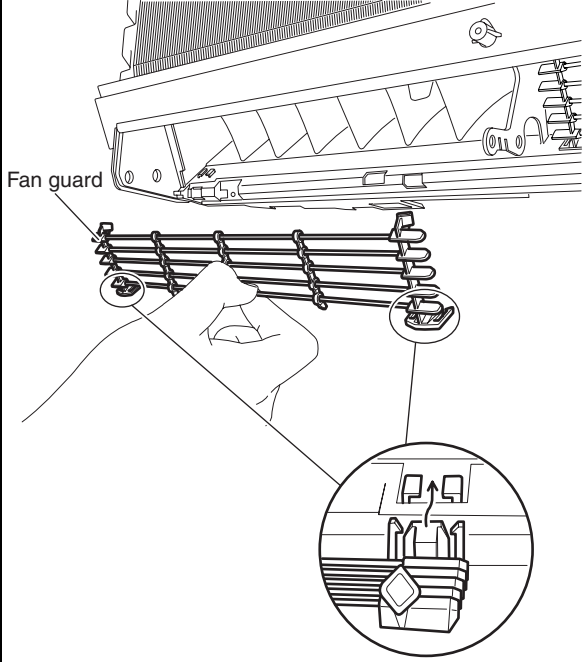
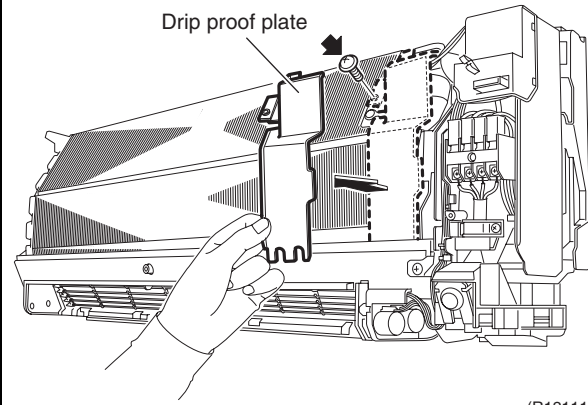
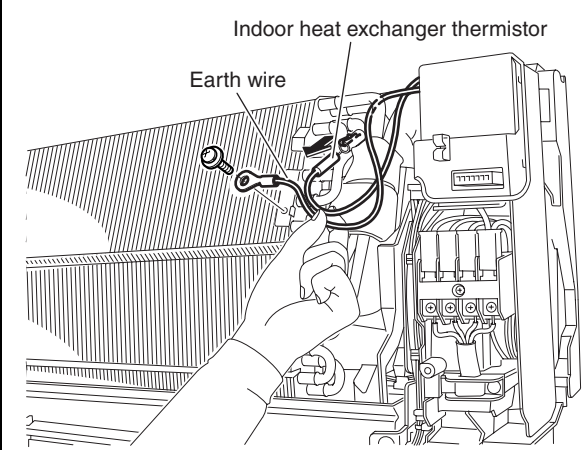
Step	Procedure	Points
1. Remove the fan guard. 1 Unfasten the 2 hooks and remove the fan guard.	 <p>Fan guard</p> <p>(R12110)</p>	<ul style="list-style-type: none"> Use a sharp tool such as an awl to unfasten the lower hooks.
2. Remove the electrical box. 1 Remove the screw and remove the drip proof plate. 2 Remove the screw and release the earth wire. Pull out the indoor heat exchanger thermistor.	 <p>Drip proof plate</p> <p>(R12111)</p>  <p>Indoor heat exchanger thermistor</p> <p>Earth wire</p> <p>(R12112)</p>	<p>Preparation</p> <ul style="list-style-type: none"> Remove the front grille according to the "Removal of Front Grille".

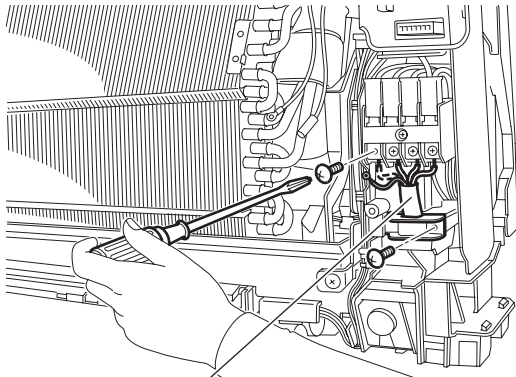
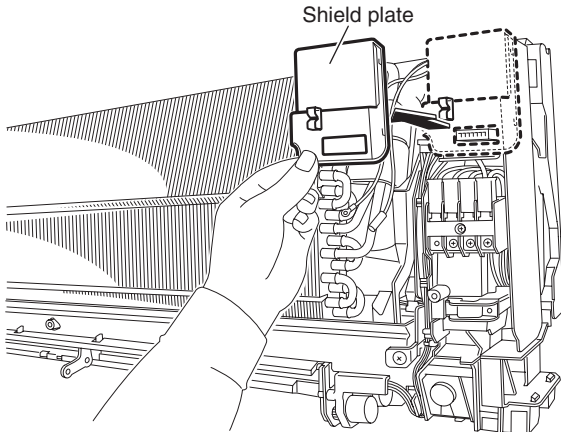
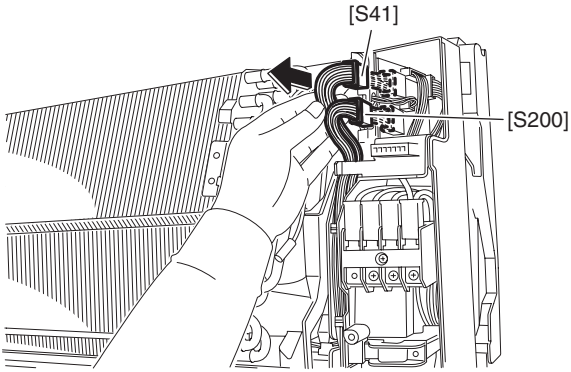
Step	Procedure	Points
3	<p>Remove the screws and release the connecting wires.</p>  <p style="text-align: center;">Connecting wire</p> <p style="text-align: right;">(R12113)</p>	
4	<p>Remove the shield plate.</p>  <p style="text-align: right;">(R12114)</p>	
5	<p>Disconnect the connectors for the swing motors [S41] and for the fan motor [S200].</p>  <p style="text-align: right;">(R12115)</p>	

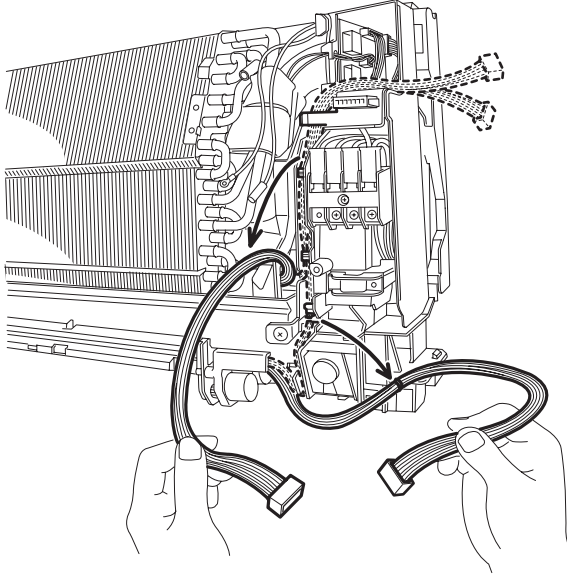
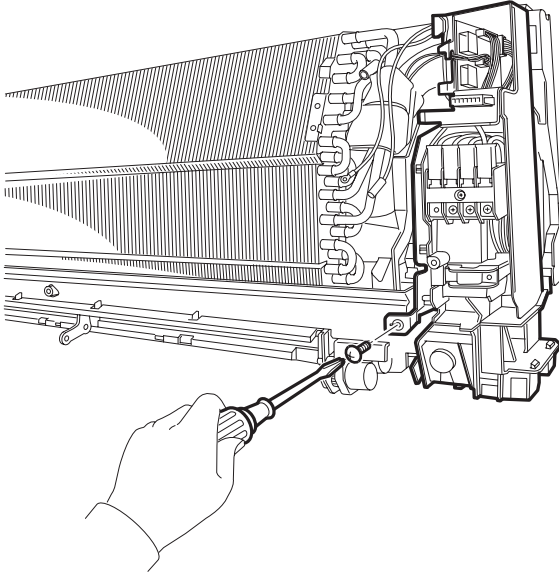
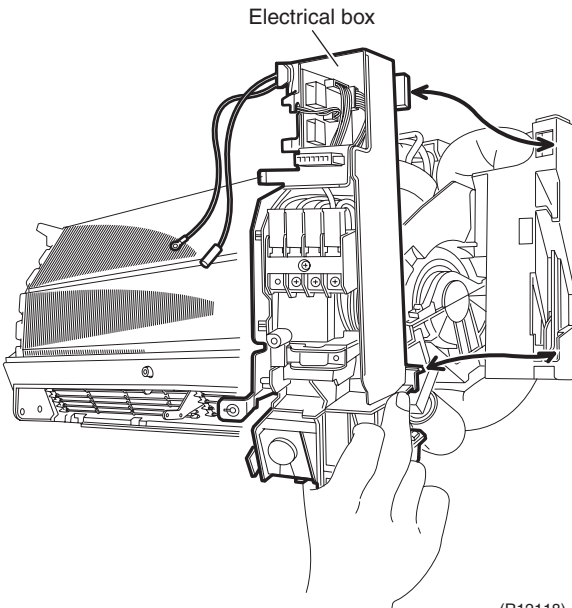
Step	Procedure	Points
6	<p>Release the harnesses.</p>  <p>(R12116)</p>	
7	<p>Remove the screw.</p>  <p>(R12117)</p>	
8	<p>Unfasten the 2 hooks and remove the electrical box.</p>  <p>(R12118)</p>	<ul style="list-style-type: none"> There are 2 hooks on the bottom frame. When reassembling, fit the rear side of the electrical box to the hooks.

1.8 Removal of PCB

Procedure



Warning

Be sure to wait for 10 minutes or more after turning off all power supplies before disassembling work.

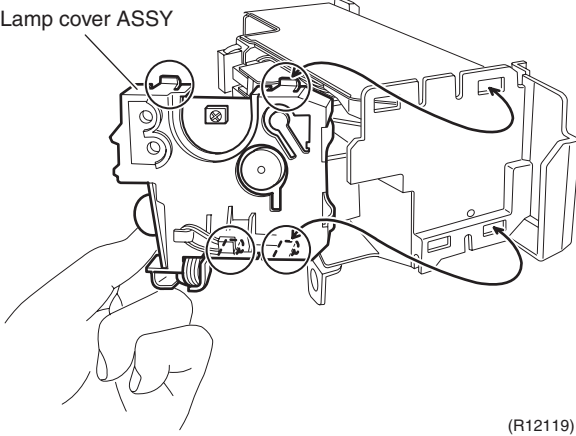
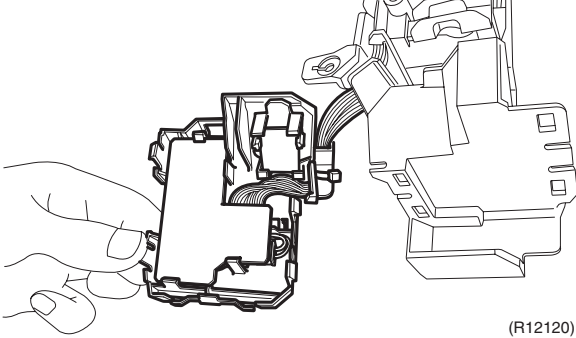
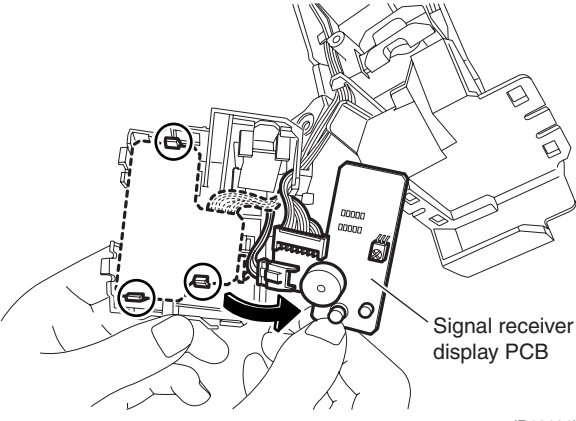
Step	Procedure	Points
1	<p>Unfasten the 4 hooks and remove the lamp cover ASSY from the electrical box.</p>  <p style="text-align: right;">(R12119)</p>	
2	<p>Turn over the lamp cover ASSY.</p>  <p style="text-align: right;">(R12120)</p>	
3	<p>Unfasten the 3 hooks and remove the signal receiver / display PCB.</p>  <p style="text-align: right;">(R12121)</p>	

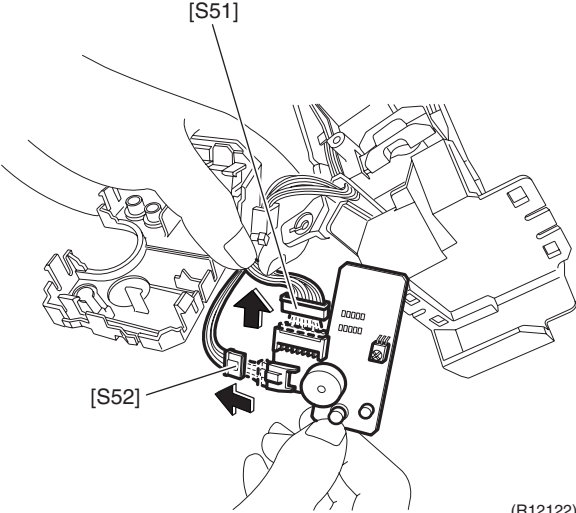
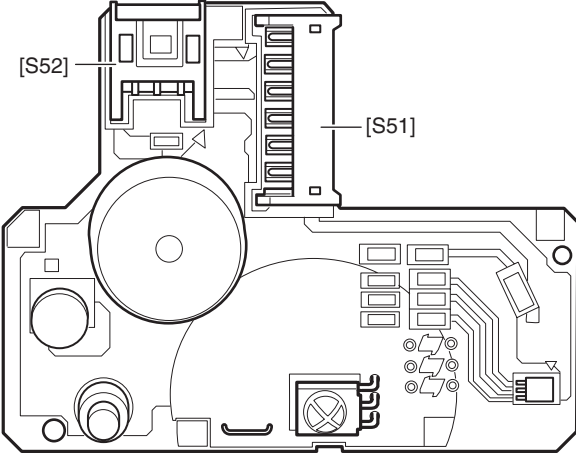
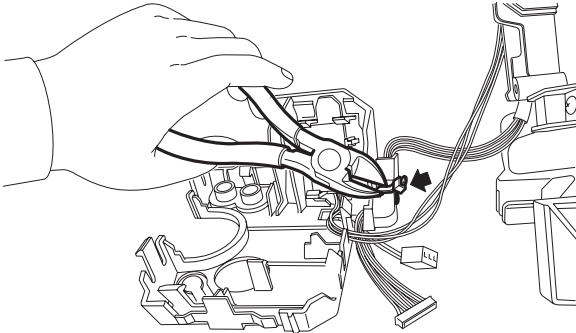
Step	Procedure	Points
<p>4</p>	<p>Disconnect the connectors for the control PCB [S51] and for the room temperature thermistor [S52].</p>  <p>(R12122)</p>  <p>(R12123)</p>	<p>■ Refer to page 7 for detail. [S51]: control PCB [S52]: room temperature thermistor</p>
<p>5</p>	<p>Cut the clamp.</p>  <p>(R12124)</p>	

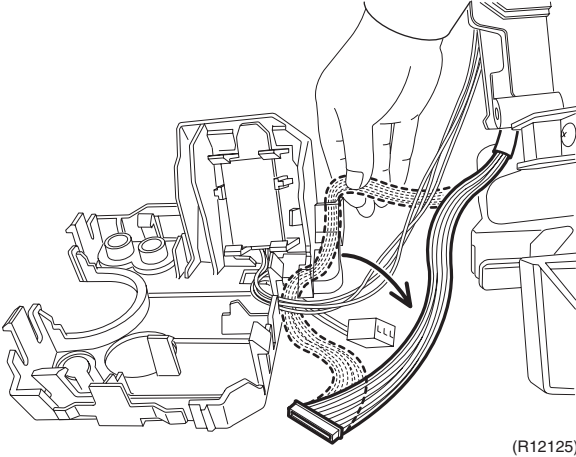
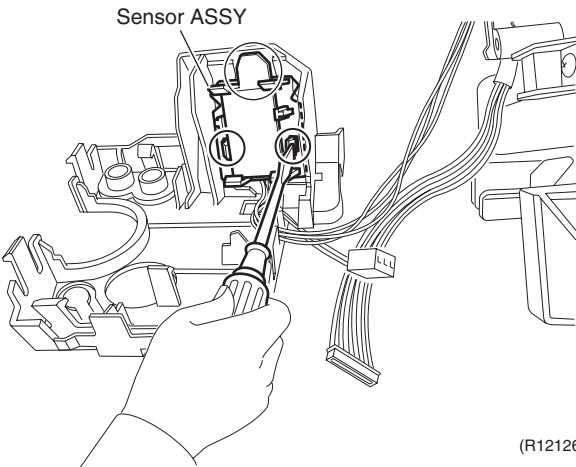
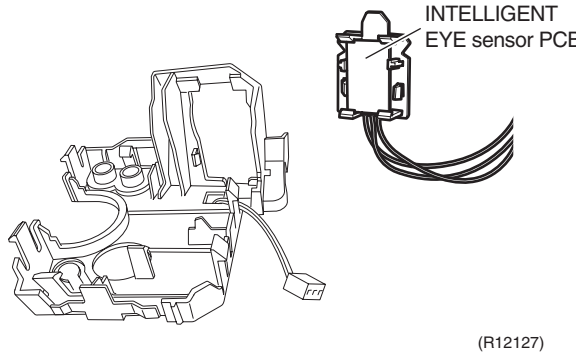
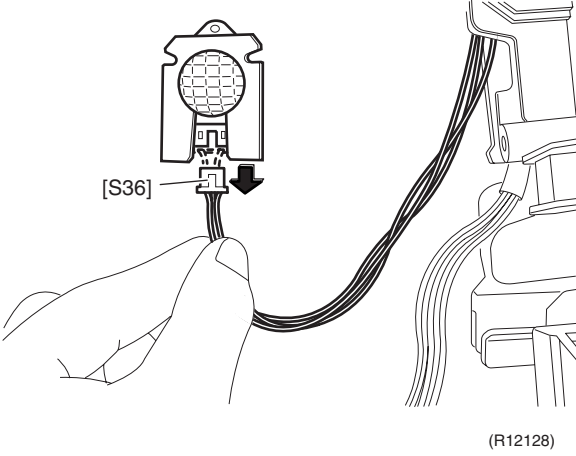
Step	Procedure	Points
6	Release the harness from the hook.	
	 <p>(R12125)</p>	
7	Unfasten the 3 hooks of the sensor ASSY with a flat screwdriver.	
	 <p>Sensor ASSY</p> <p>(R12126)</p>	
8	Remove the sensor ASSY.	
	 <p>INTELLIGENT EYE sensor PCB</p> <p>(R12127)</p>	
9	Disconnect the connector [S36] from the INTELLIGENT EYE sensor PCB.	
	 <p>[S36]</p> <p>(R12128)</p>	

Step	Procedure	Points
10	Cut the clamp.	
11	Remove the shield plate.	
12	Remove the screw of the terminal board.	

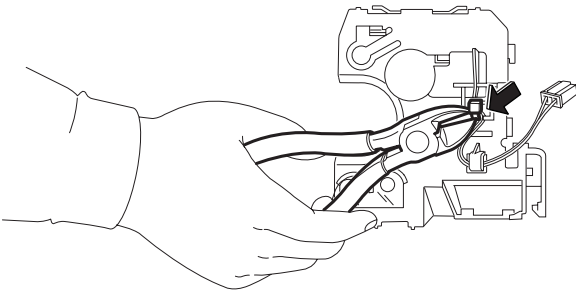

(R12129)

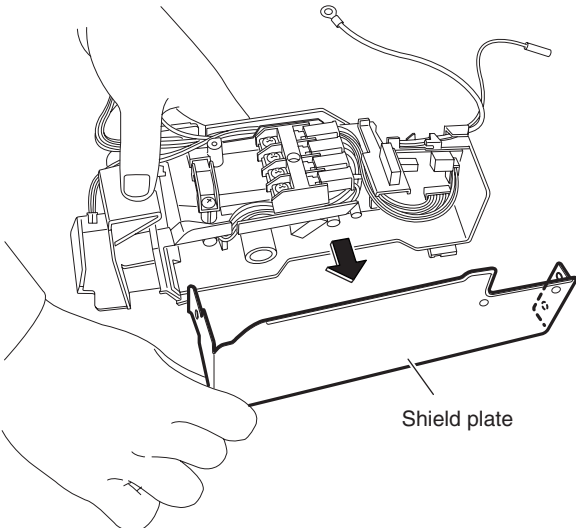

(R12130)

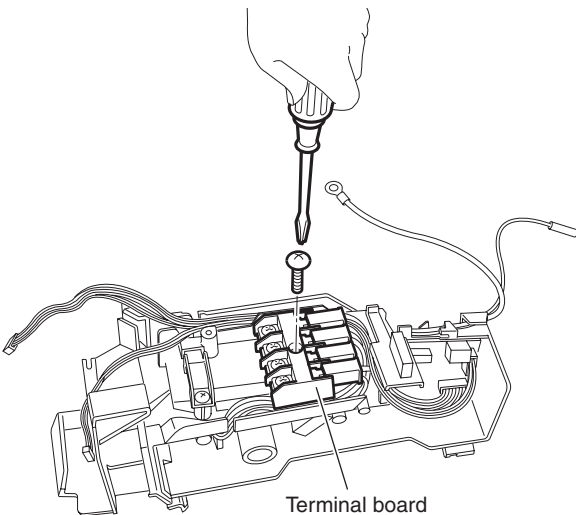

(R12131)

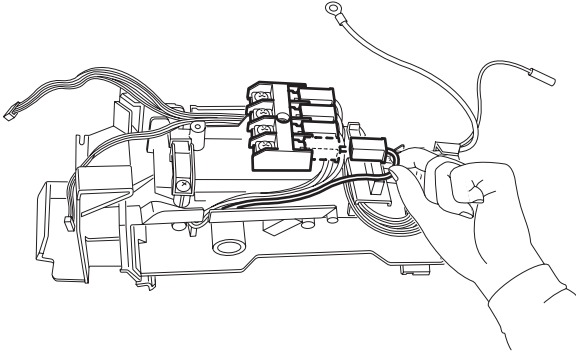
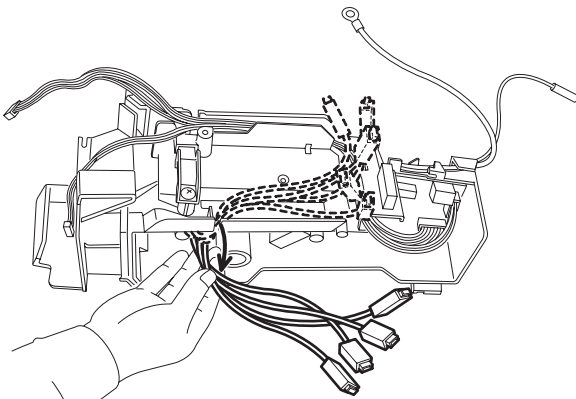
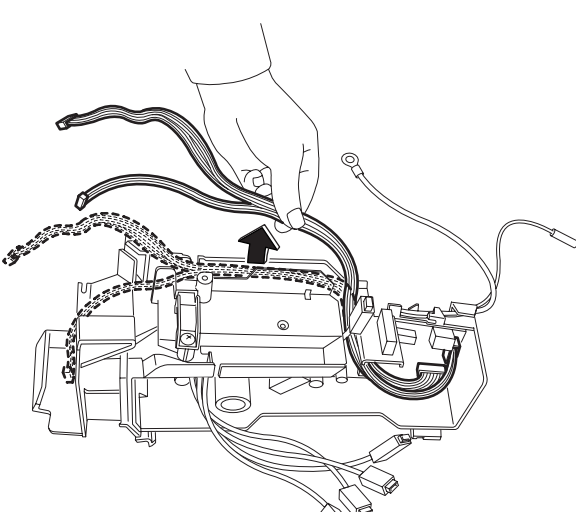
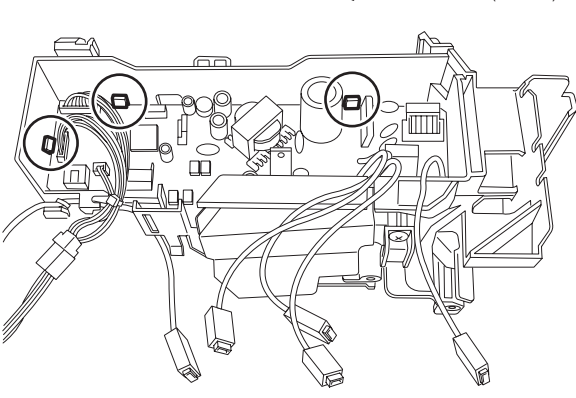
Step	Procedure	Procedure	Points
13	Pull out the terminals and remove the terminal board.	 <p>(R12132)</p>	
14	Release the harnesses from the groove.	 <p>(R12133)</p>	
15	Release the harnesses of the signal receiver / display PCB.	 <p>(R12134)</p>	
16	Unfasten the 3 hooks.	 <p>(R12135)</p>	

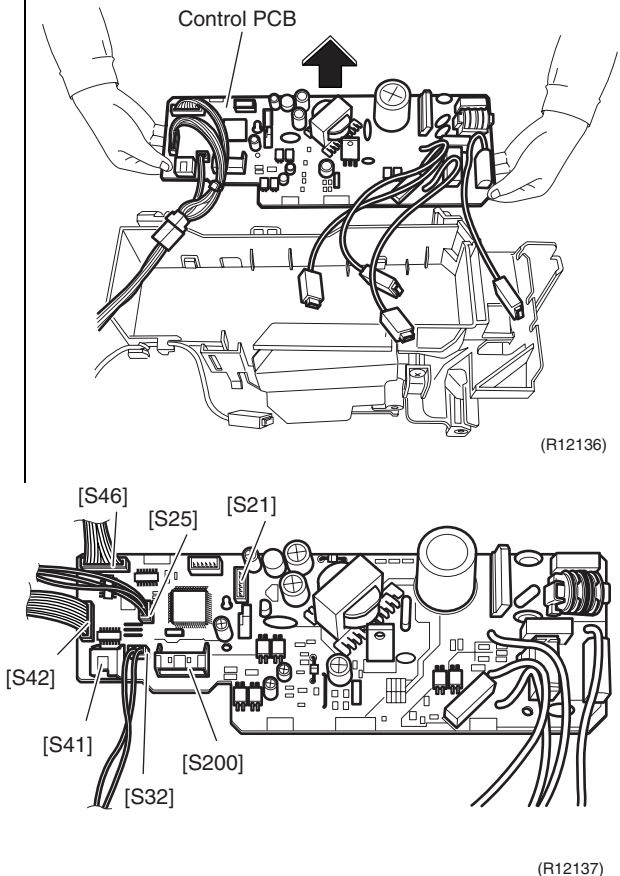
Step	Procedure	Points
17	<p data-bbox="199 219 454 309">Unfasten the other 2 hooks and remove the control PCB.</p> 	<p data-bbox="1093 689 1428 721">■ Refer to page 7 for detail.</p> <p data-bbox="1093 725 1340 757">[S21]: HA connector</p> <p data-bbox="1093 761 1404 819">[S25]: INTELLIGENT EYE sensor PCB</p> <p data-bbox="1093 824 1436 882">[S32]: indoor heat exchanger thermistor</p> <p data-bbox="1093 887 1332 918">[S41]: swing motors</p> <p data-bbox="1093 922 1428 981">[S42]: reduction motor / limit switch</p> <p data-bbox="1093 985 1444 1043">[S46]: signal receiver / display PCB</p> <p data-bbox="1093 1048 1292 1079">[S200]: fan motor</p>

1.9 Removal of Swing Motor

Procedure



Warning

Be sure to wait for 10 minutes or more after turning off all power supplies before disassembling work.

Step	Procedure	Procedure	Points
1	Remove the 2 screws of the swing motor.	<p>Swing motor for upper (large) blade</p> <p>Swing motor for lower (small) blade</p> <p>(R12138)</p>	<ul style="list-style-type: none"> ■ Connector color Upper blade: white Lower blade: red
2	Remove the swing motor.	<p>(R12139)</p>	<ul style="list-style-type: none"> ■ Remove the other swing motor in the same way.

1.10 Removal of Indoor Heat Exchanger

Procedure

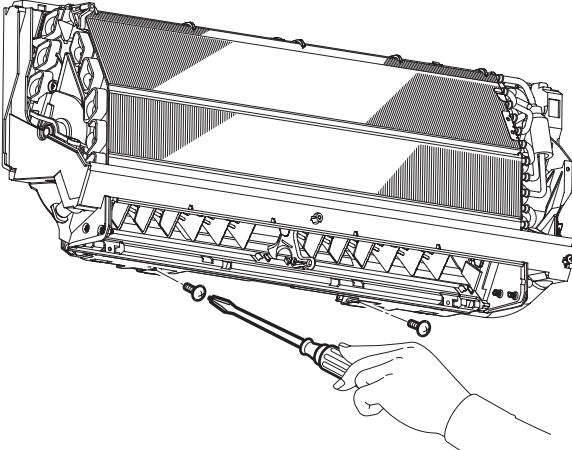
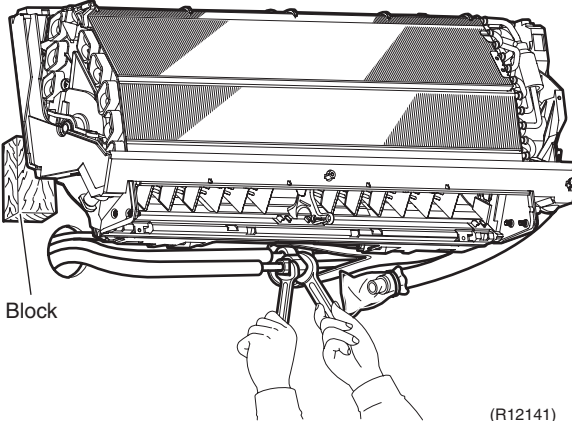
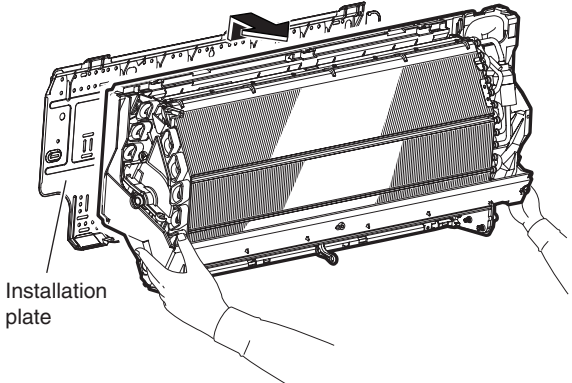

Warning Be sure to wait for 10 minutes or more after turning off all power supplies before disassembling work.

Step	Procedure	Points
<p>1. Disconnect the refrigerant piping.</p> <p>1 Remove the screws fixed to the installation plate.</p> <p>2 Hold the indoor unit up with a block. Disconnect the piping with 2 wrenches.</p>	 <p style="text-align: right;">(R12140)</p>  <p>Block</p> <p style="text-align: right;">(R12141)</p>	<p>Caution</p> <p>In pump-down work, be sure to stop the compressor before disconnecting the refrigerant pipe. If the refrigerant pipe is disconnected with the compressor operating and the stop valve open, air may be sucked in to generate an over-pressure in refrigeration cycle, thus resulting in pipe rupture or accidental injury.</p> <ul style="list-style-type: none"> ■ Place a plastic sheet under the drain pan to prevent from wetting the floor with remaining drain. ■ If the drain hose is embedded in the wall, disconnect the drain hose beforehand. ■ Carry out the removal works with 2 wrench. ■ When the pipings are disconnected, protect the both openings of pipe side and unit side from entering of moisture.
<p>2. Remove the indoor unit.</p> <p>1 Detach the indoor unit from the installation plate.</p>	 <p>Installation plate</p> <p style="text-align: right;">(R12142)</p>	

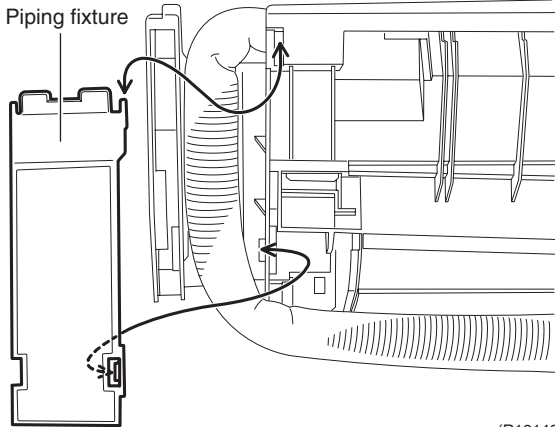
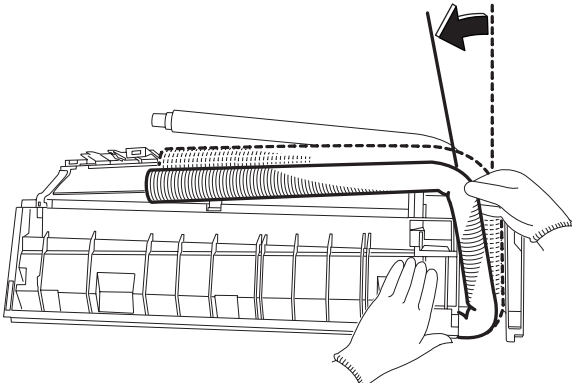
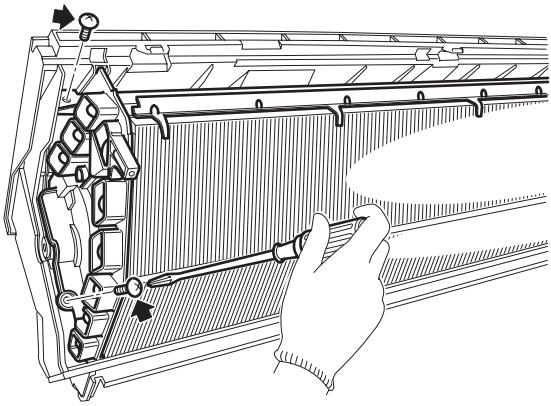
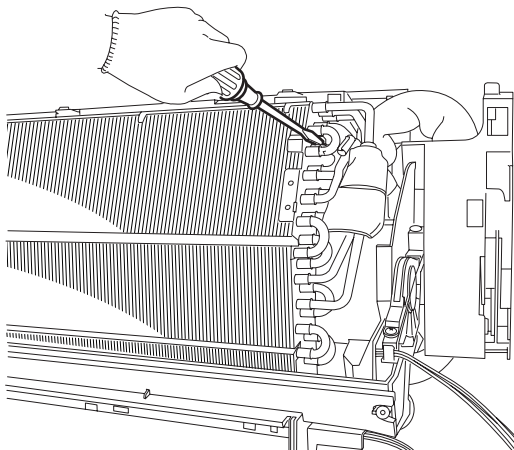
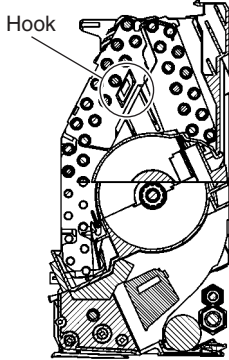
Step	Procedure	Points
3.	Remove the indoor heat exchanger.	
1	<p>Unfasten the hook of the piping fixture at the back of the indoor unit and pull out the pipe.</p>  <p style="text-align: right;">(R12143)</p>	
2	<p>Widen the auxiliary pipe by about 10-20 degrees.</p>  <p style="text-align: right;">(R12144)</p>	<p>⚠ Caution When dismantling or mounting the indoor heat exchanger, be sure to wear gloves or wrap it with cloth before proceeding to the work. (You may be injured by the fins.)</p>
3	<p>Remove the 2 screws on the left side of the unit.</p>  <p style="text-align: right;">(R12145)</p>	
4	<p>Unfasten the hook on the right side of the unit with a flat screwdriver.</p>  <p style="text-align: right;">(R12146)</p>	<p>■ When reassembling, engage the hook.</p>  <p style="text-align: right;">(R12159)</p>

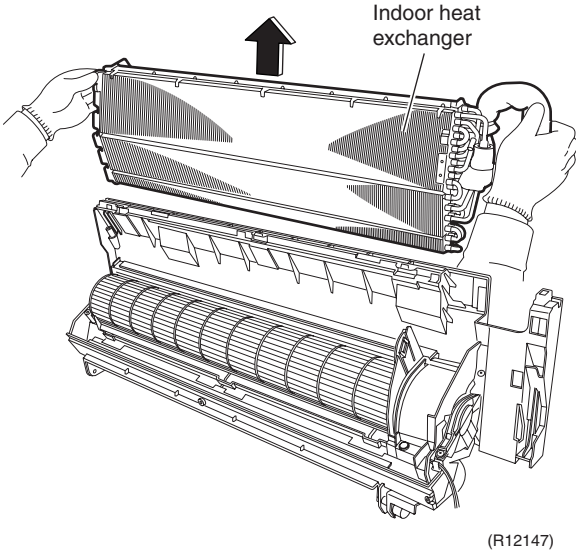
Step	Procedure	Points
5	<p data-bbox="199 219 470 280">Remove the indoor heat exchanger.</p>  <p data-bbox="976 772 1050 795">(R12147)</p>	

1.11 Removal of Fan Rotor / Fan Motor

Procedure



Warning

Be sure to wait for 10 minutes or more after turning off all power supplies before disassembling work.

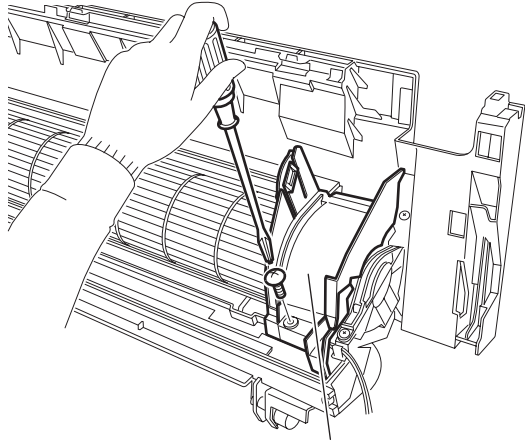
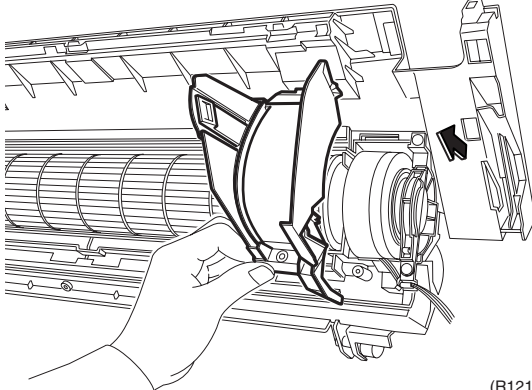
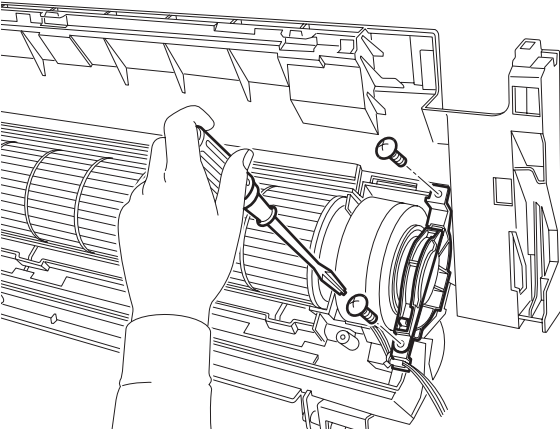
Step	Procedure	Points
1. Remove the right side panel.	 <p style="text-align: right;">Right side panel (R12148)</p>	<p>■ You can remove the fan rotor without detaching the right side panel.</p>
2. Remove the right side panel.	 <p style="text-align: right;">(R12149)</p>	
2. Remove the fan rotor.	 <p style="text-align: right;">(R12150)</p>	

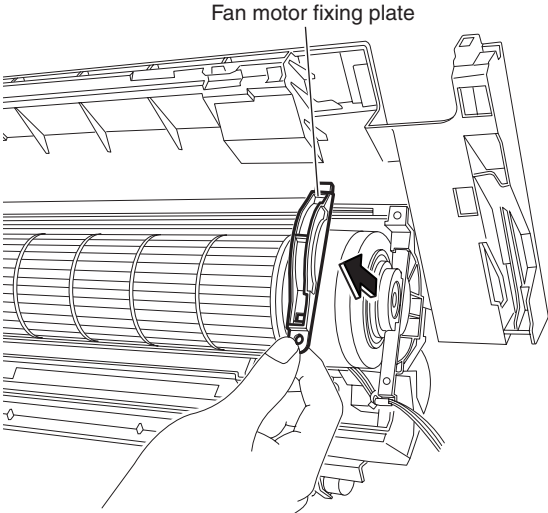
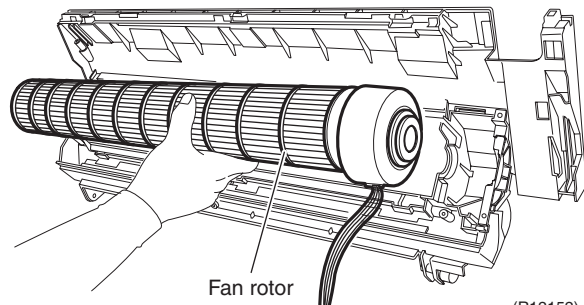
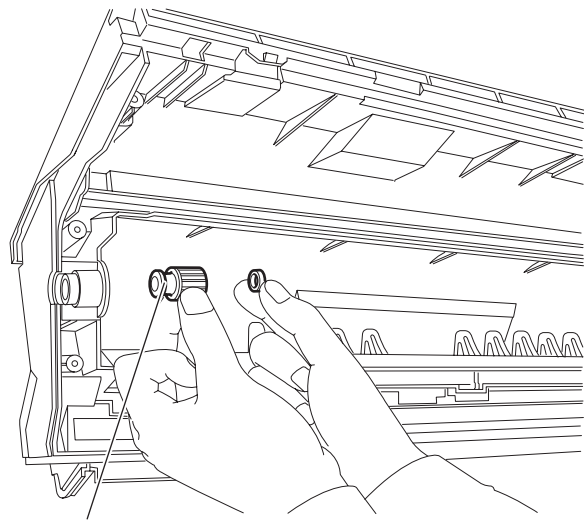
Step		Procedure	Points
2	Remove the fan motor fixing plate.	 <p>Fan motor fixing plate</p>	
3	Remove the fan rotor.	 <p>Fan rotor</p>	(R12151) (R12152)
4	Remove the bearing.	 <p>Bearing</p>	(R12153)

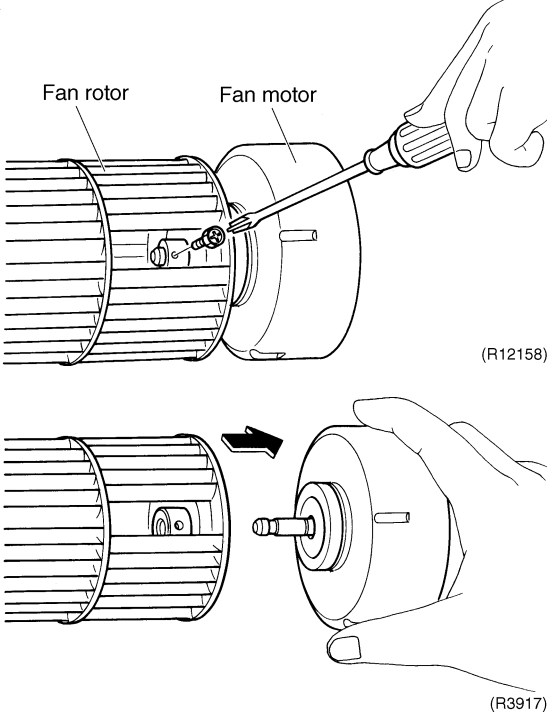
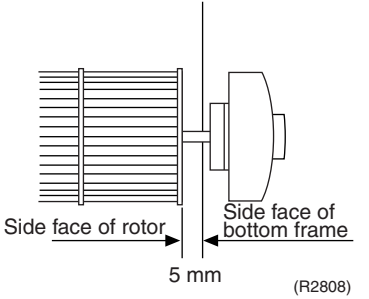
Step	Procedure	Points
3. Remove the fan motor.	<p data-bbox="153 248 464 309">1 Remove the screw and remove the fan motor.</p> 	<ul style="list-style-type: none"> ■ When reassembling the fan motor and the fan rotor, provide as much as 5 mm of play between the side face of the rotor and the bottom frame. 

1.12 Removal of Vertical Blade ASSY

Procedure



Warning

Be sure to wait for 10 minutes or more after turning off all power supplies before disassembling work.

Step	Procedure	Points
1	Unfasten the 3 hooks at the shaft mounting part by pressing them with a flat screwdriver.	<ul style="list-style-type: none"> ■ A vertical blade ASSY has 6 fins. It is impossible to replace only one fin. ■ The vertical blade ASSY is not marked for difference between right and left.
2	Unfasten the hooks at the upper 2 positions with a flat screwdriver.	
3	Remove the vertical blade ASSY.	

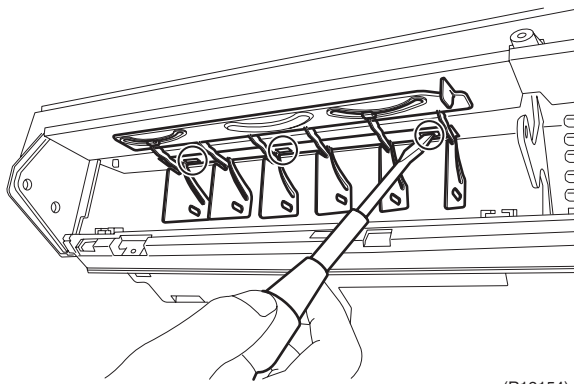

(R12154)

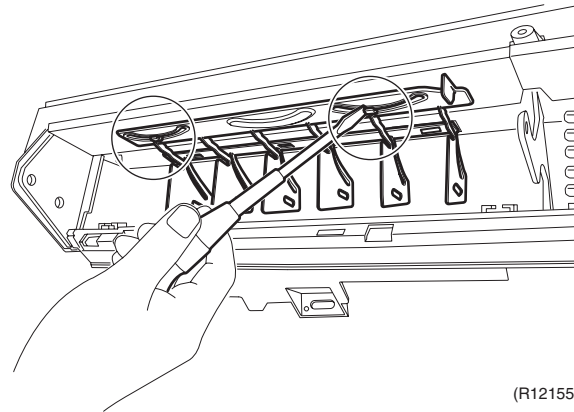

(R12155)

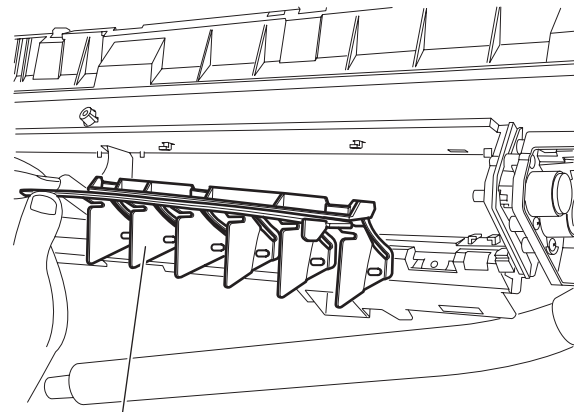

Vertical blade ASSY

(R12156)

2. Outdoor Unit

2.1 Removal of Outer Panels / Fan Motor

Procedure



Warning Be sure to wait 10 minutes or more after turning off all power supplies before disassembling work.

Step	Procedure	Points
<p>1. Appearance features</p>	<p>Handle</p> <p>(R7186)</p> <p>(R11890)</p>	<ul style="list-style-type: none"> ■ Take care not to cut your finger by the fins of the outdoor heat exchanger.
<p>2. Remove the panels.</p> <p>1 Remove the screw of the stop valve cover. Pull down the stop valve cover and remove it.</p>	<p>Stop valve cover</p> <p>Shield plate</p> <p>Hooks</p> <p>(R7188)</p> <p>(R7189)</p>	<ul style="list-style-type: none"> ■ The stop valve cover is united with the shield plate. ■ When reassembling, make sure to fit the 5 hooks.

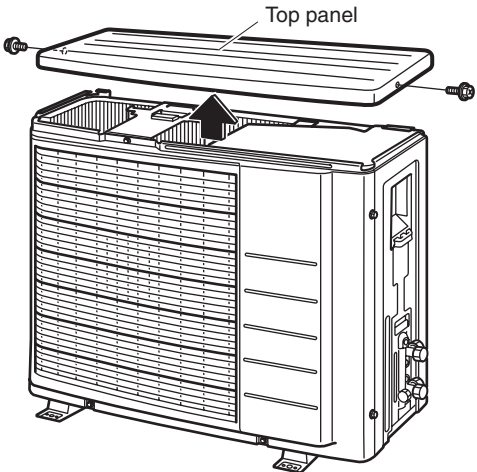
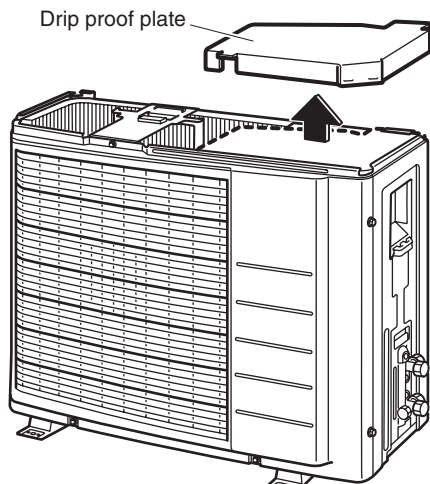
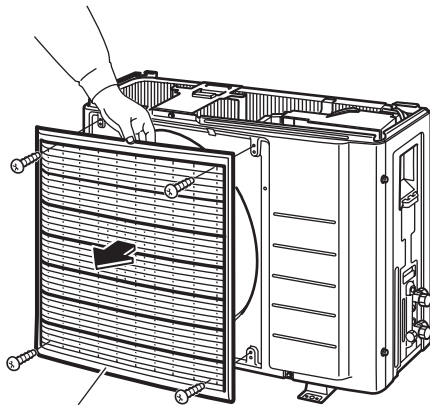
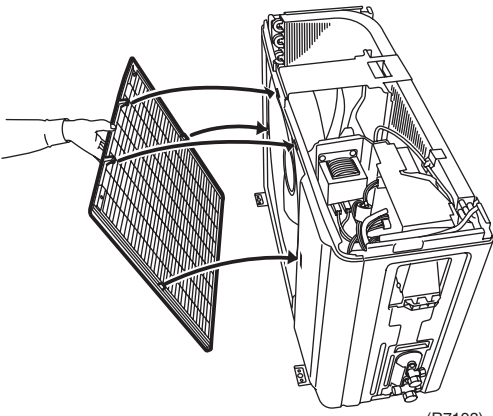
Step		Procedure	Points
2	Remove the 2 screws and lift the top panel.	 <p>Top panel</p> <p>(R7190)</p>	
3	Remove the drip proof plate.	 <p>Drip proof plate</p> <p>(R7191)</p>	
4	Remove the 4 screws and remove the discharge grille.	 <p>Discharge grille</p> <p>(R7192)</p>  <p>(R7193)</p>	<p>■ The discharge grille has 4 hooks.</p>

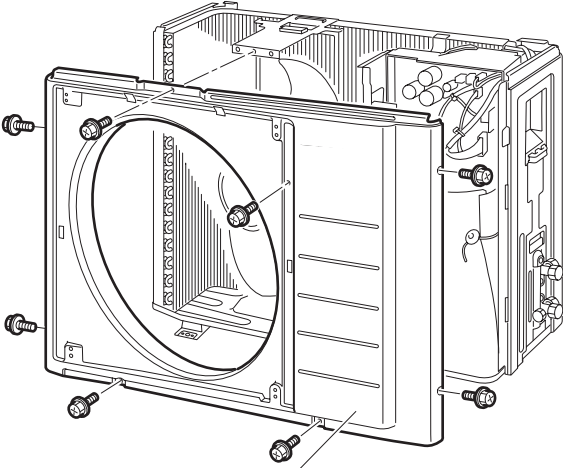
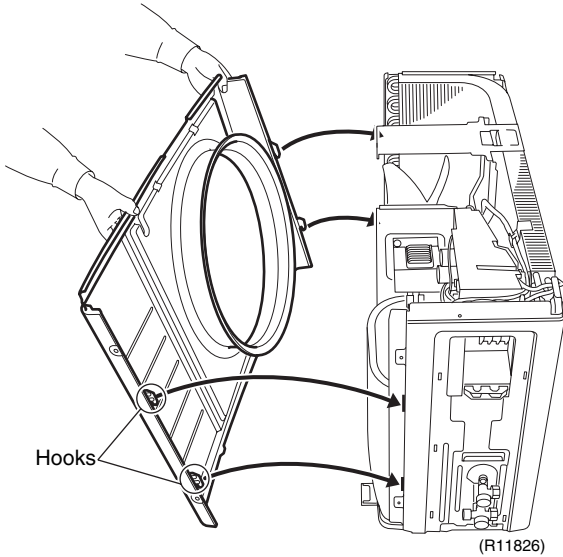
Step	Procedure	Points
<p>5 Remove the 8 screws of the front panel.</p>	 <p>Front panel (R11825)</p>	
<p>6 Unfasten the hooks. Pull and remove the front panel.</p>	 <p>Hooks (R11826)</p>	<p>■ The front panel has 4 hooks.</p>

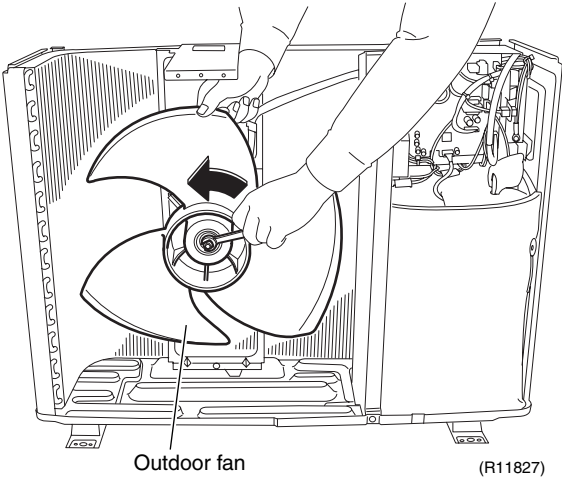
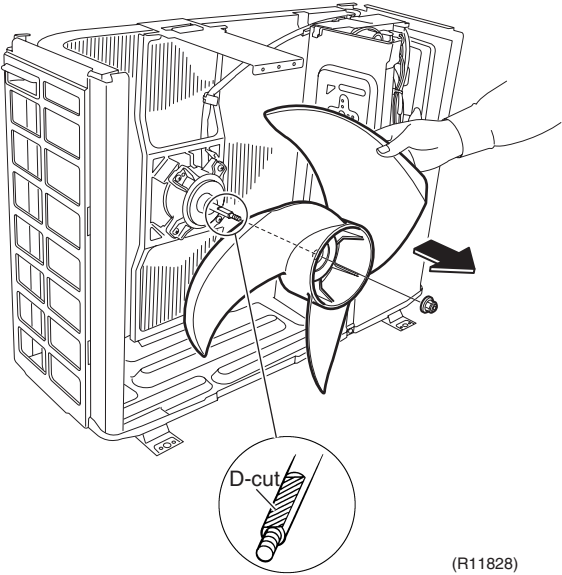
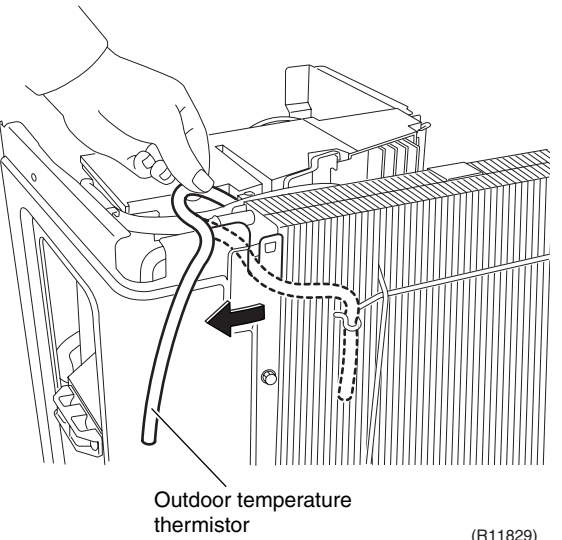
Step	Procedure	Points
<p>3. Remove the fan motor.</p>	<p>1 Unscrew the washer-fitted nut (M6) of the outdoor fan.</p>  <p>Outdoor fan (R11827)</p> <p>2 Remove the outdoor fan.</p>  <p>D-cut (R11828)</p> <p>3 Release the outdoor temperature thermistor from the holder.</p>  <p>Outdoor temperature thermistor (R11829)</p>	<ul style="list-style-type: none"> ■ The screw has reverse winding. ■ Wrench size: 10 mm ■ When reassembling, align ▼ mark of the outdoor fan with D-cut section of the motor shaft.

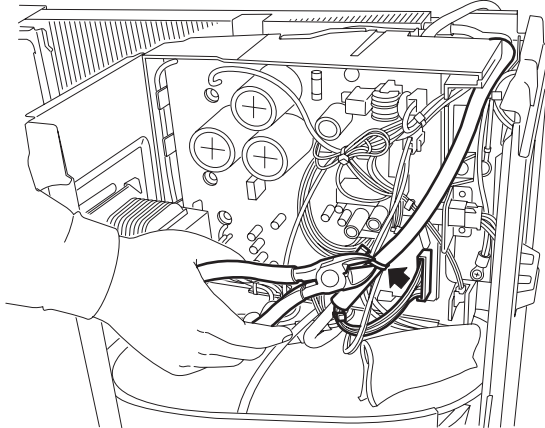
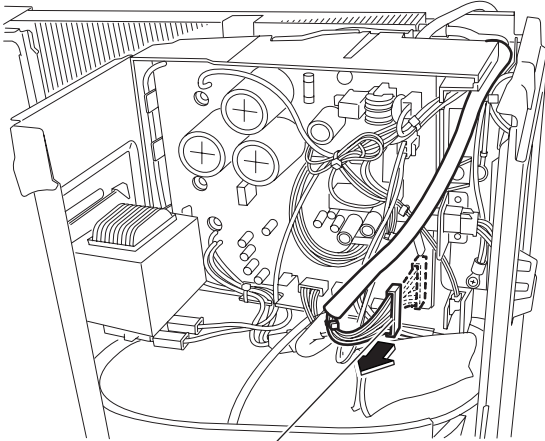
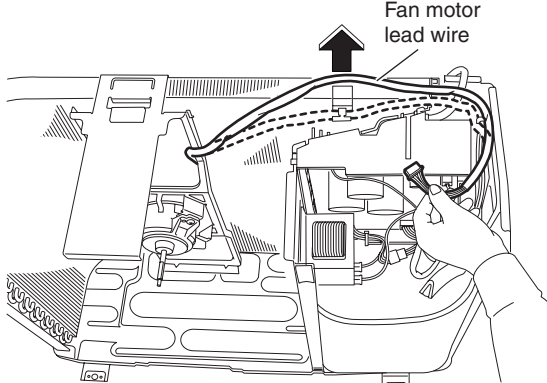
Step	Procedure	Points
4	<p>Cut the clamp.</p>  <p>(R11830)</p>	
5	<p>Disconnect the connector for the fan motor [S70].</p>  <p>[S70] (R11831)</p>	
6	<p>Release the fan motor lead wire from the hook.</p>  <p>Fan motor lead wire</p> <p>(R11832)</p>	

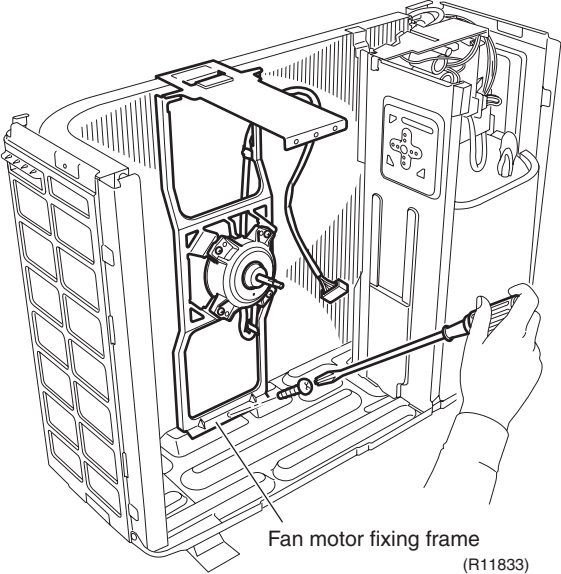
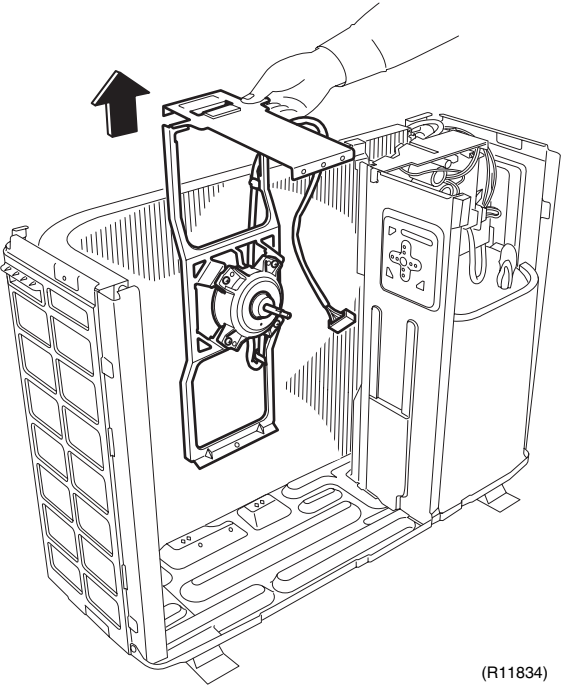
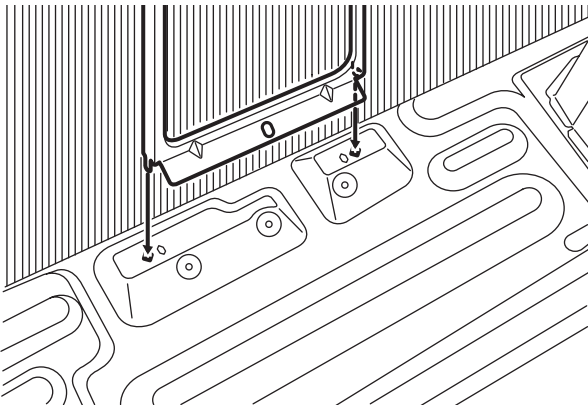
Step	Procedure	Points
7	<p data-bbox="199 219 464 309">Remove the screw and remove the fan motor fixing frame.</p>  <p data-bbox="767 757 1034 806">Fan motor fixing frame (R11833)</p>  <p data-bbox="986 1496 1053 1523">(R11834)</p>  <p data-bbox="1013 1982 1077 2009">(R7206)</p>	<p data-bbox="1093 1541 1449 1635">■ When reassembling, fit the lower hooks into the bottom frame.</p>

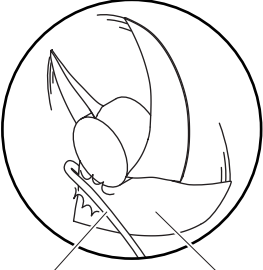
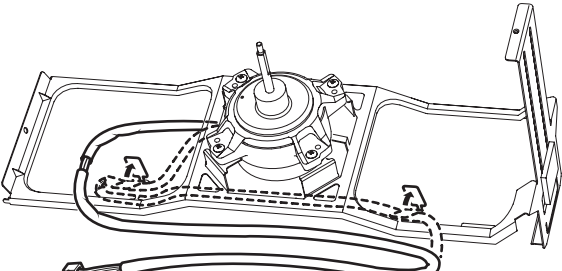
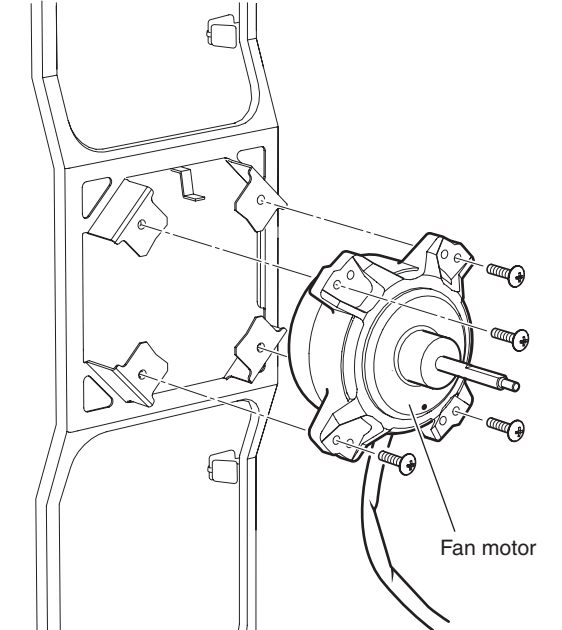
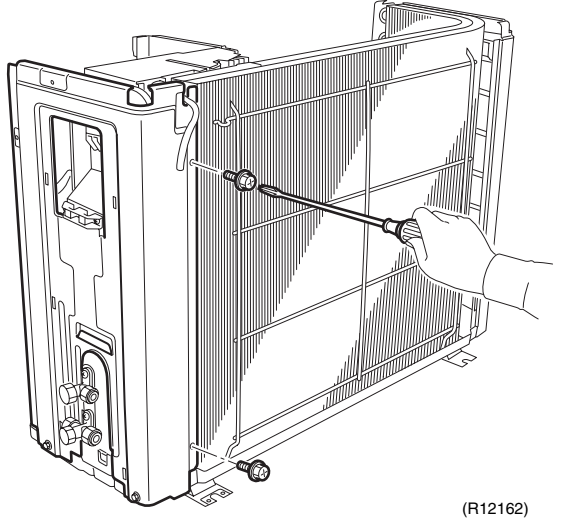
Step	Procedure	Points
8	Open the hooks and release the fan motor lead wire.	<ul style="list-style-type: none"> When reassembling, put the fan motor lead wire through the back of the fan motor (so as not to be entangled with the outdoor fan).
9	Remove the 4 screws and remove the fan motor.	 <p>Lead wire Outdoor fan (R3249)</p>
4. Remove the right side panel.	 <p>(R11835)</p>	
1	Remove the 2 screws on the rear side.	 <p>Fan motor (R11836)</p>
	 <p>(R12162)</p>	

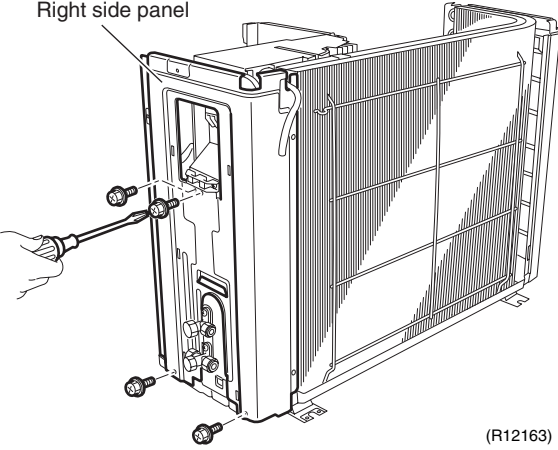
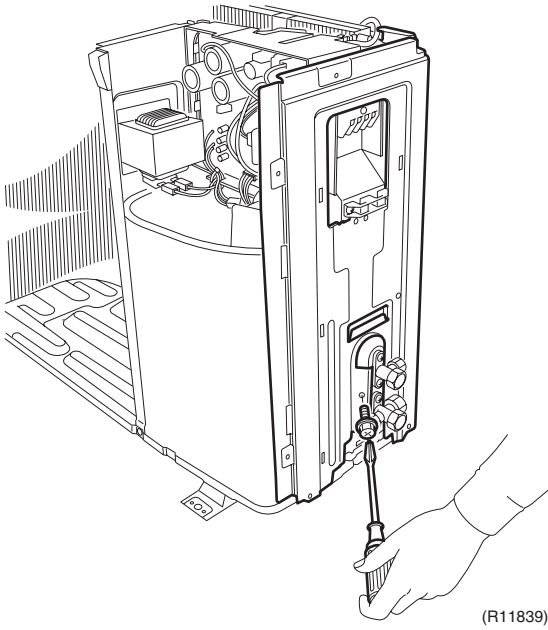
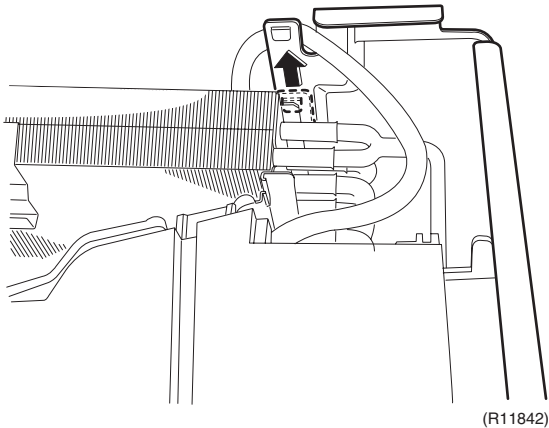
Step	Procedure	Points
2	<p>Remove the 4 screws on the right side panel.</p>  <p>Right side panel</p> <p>(R12163)</p>	
3	<p>Remove the screw near the stop valves.</p>  <p>(R11839)</p>	
4	<p>Unfasten the hook on the rear side.</p>  <p>(R11842)</p>	<p>■ When reassembling, make sure to fit the hook.</p>

Step	Procedure	Points
5	Lift up the right side panel to remove.	<ul style="list-style-type: none"> ■ When reassembling, make sure to fit the hook.
6	Lift up the guard net to remove.	

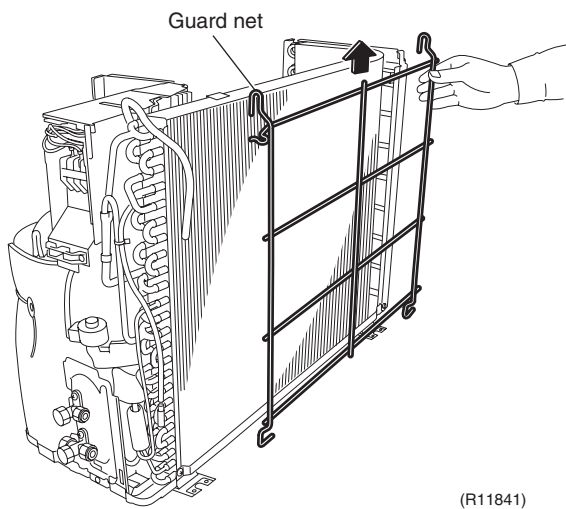
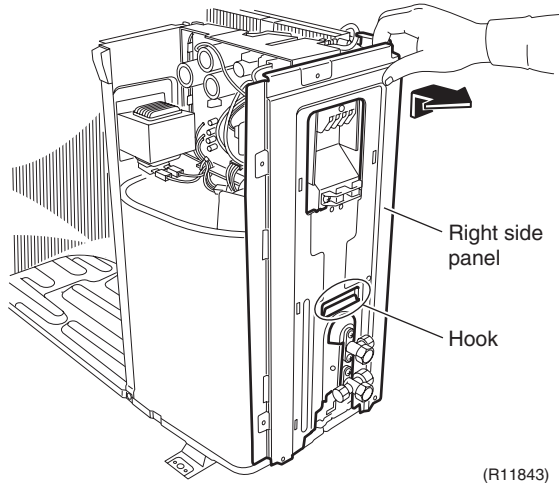

2.2 Removal of Electrical Box

Procedure

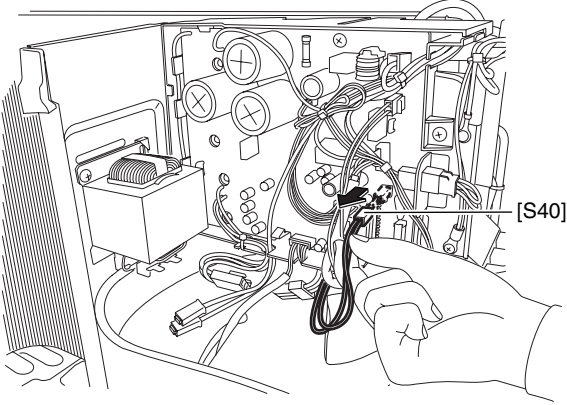
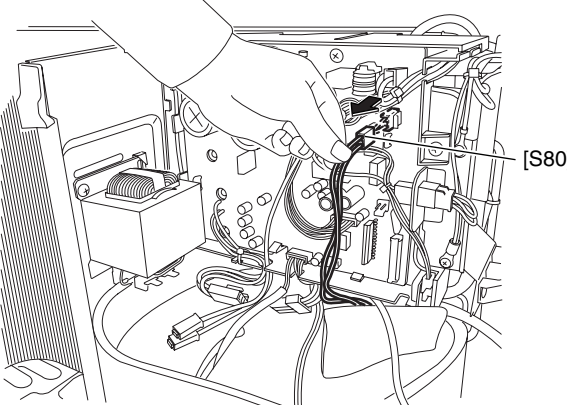
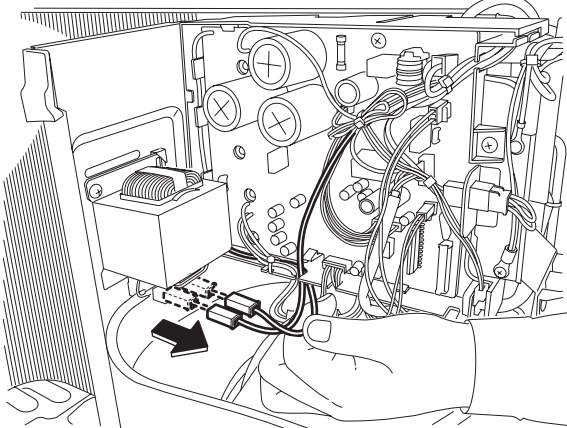

Warning Be sure to wait 10 minutes or more after turning off all power supplies before disassembling work.

Step	Procedure	Points
1. Remove the electrical box.	 <p style="text-align: right;">(R11846)</p>	<p>Preparation</p> <ul style="list-style-type: none"> ■ Remove the panels and disconnect the connector for the fan motor according to the “Removal of Outer Panels / Fan Motor”.
2. Disconnect the connector for the four way valve coil [S80].	 <p style="text-align: right;">(R11848)</p>	
3. Disconnect the 2 connectors for the reactor.	 <p style="text-align: right;">(R11844)</p>	

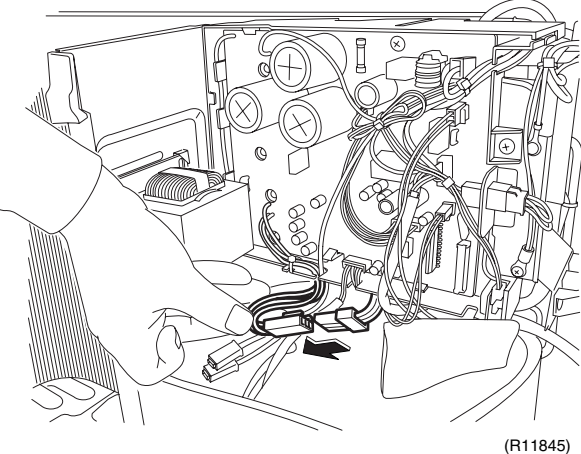
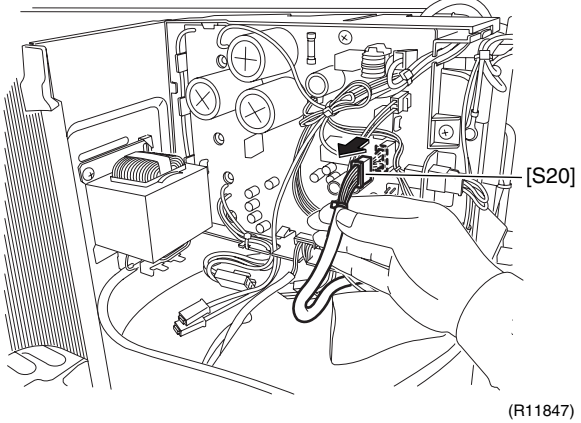
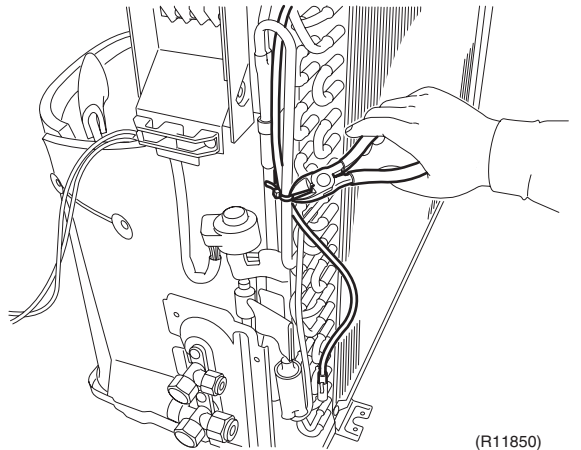
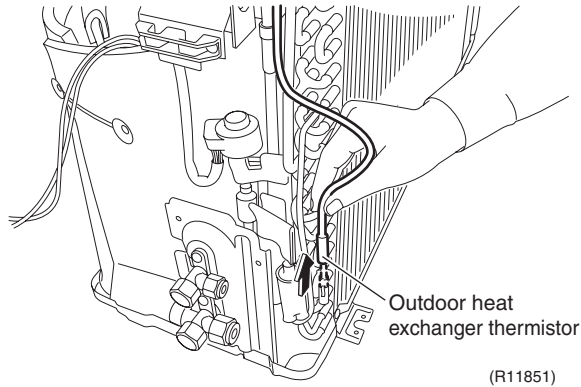
Step	Procedure	Points
4	Disconnect the relay connector for the compressor.	 <p>(R11845)</p>
5	Disconnect the connector for the electronic expansion valve coil [S20].	 <p>(R11847)</p>
6	Cut the clamp.	 <p>(R11850)</p>
7	Pull out the outdoor heat exchanger thermistor.	 <p>(R11851)</p>

■ Be careful not to lose the clip for the thermistor.

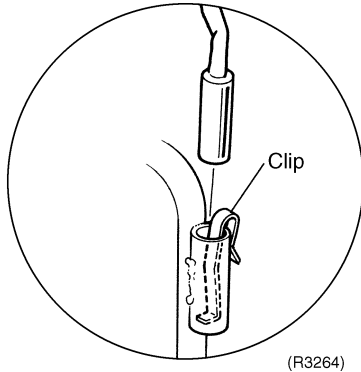

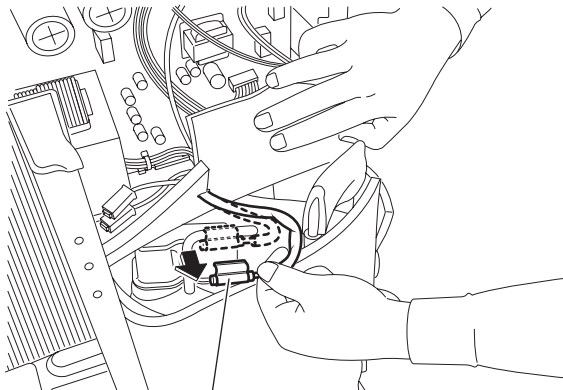
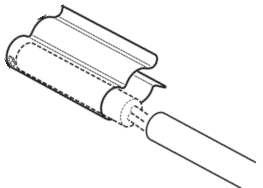
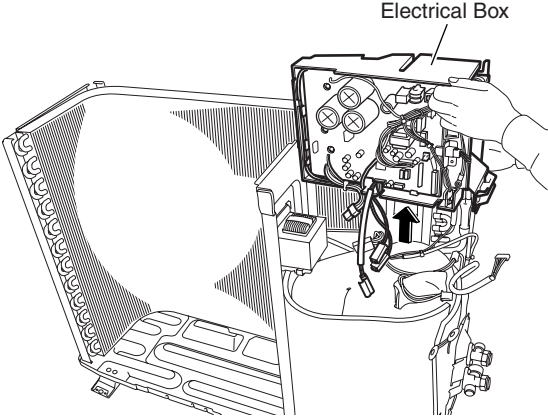
Step	Procedure	Points
8	<p>Release the discharge pipe thermistor.</p>  <p>Discharge pipe thermistor (R11849)</p>	<p>■ Be careful not to lose the clip for the thermistor.</p>  <p>(R7702)</p>
9	<p>Lift and remove the electrical box.</p>  <p>Electrical Box</p> <p>(R11852)</p>	

2.3 Removal of PCB

Procedure

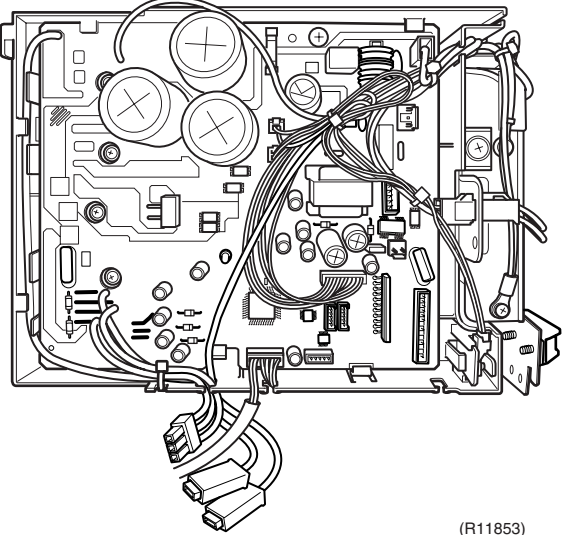
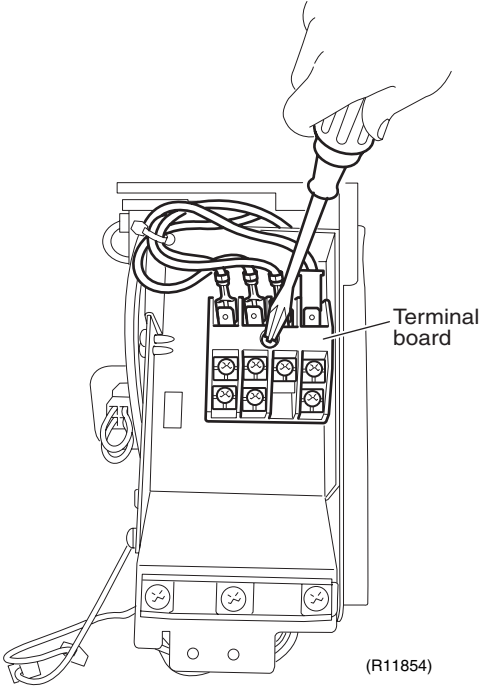
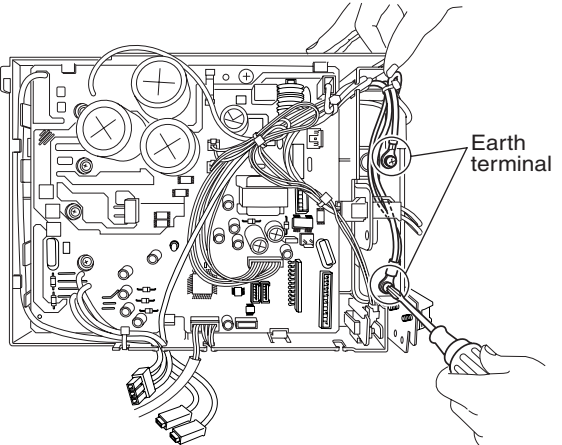

Warning Be sure to wait 10 minutes or more after turning off all power supplies before disassembling work.

Step	Procedure	Points
<p>1. Remove the main PCB.</p> <p>1 Feature of the main PCB</p> <p>2 Remove the screw on the terminal board.</p> <p>3 Release the 2 earth terminals.</p>	 <p>(R11853)</p>  <p>Terminal board</p> <p>(R11854)</p>  <p>Earth terminal</p> <p>(R11855)</p>	<ul style="list-style-type: none"> ■ You can remove the main PCB when you disconnect the read wires on the terminal board without removing the electrical box.

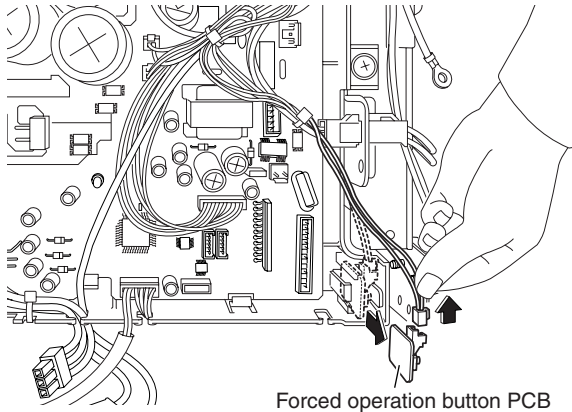
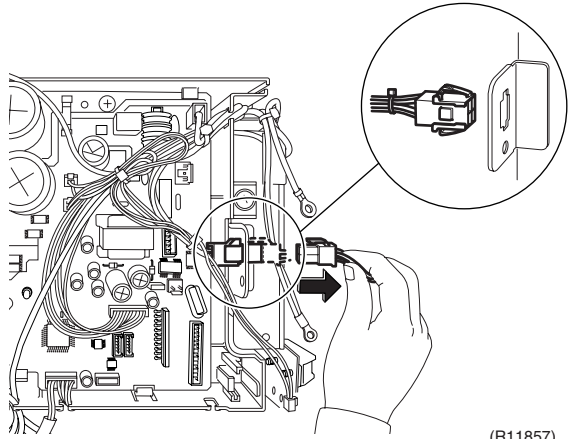
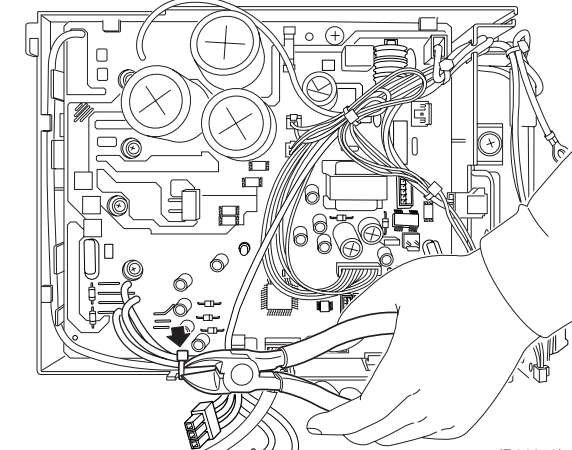
Step	Procedure	Points
4	<p>Pull out the forced operation button PCB. Disconnect the connector [S110] to remove the forced operation button PCB.</p>  <p>Forced operation button PCB (R11856)</p>	<ul style="list-style-type: none"> Be careful of a sharp protrusion at the back of the forced operation button PCB.
5	<p>Disconnect the relay connector.</p>  <p>(R11857)</p>	
6	<p>Cut the clamp.</p>  <p>(R11858)</p>	

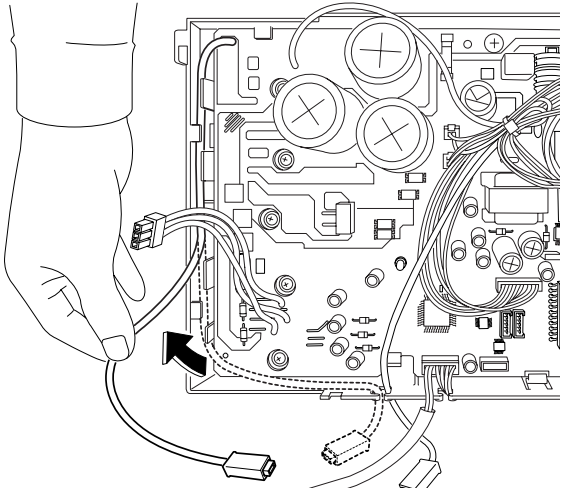
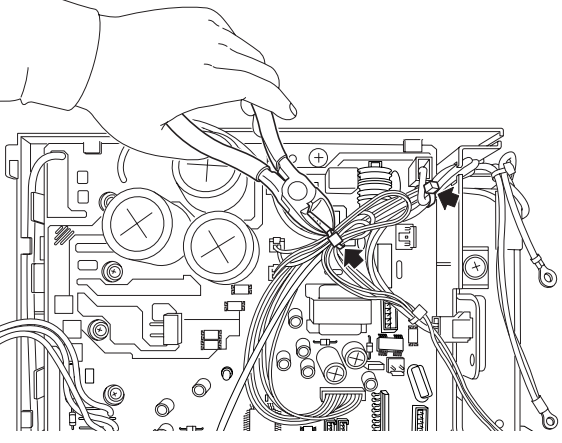
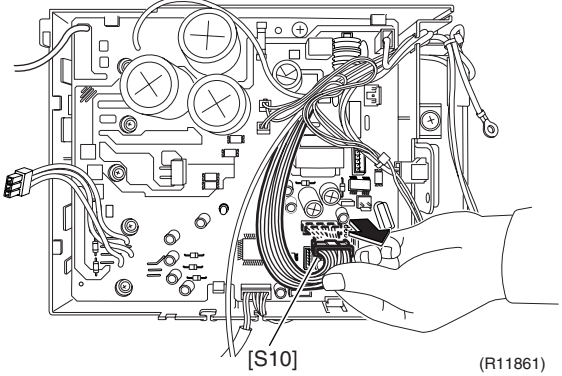
Step	Procedure	Points
7	<p>Release the harness.</p>  <p>(R11859)</p>	
8	<p>Cut the clamps at the 2 locations.</p>  <p>(R11860)</p>	
9	<p>Disconnect the connector for the filter PCB [S10].</p>  <p>[S10] (R11861)</p>	

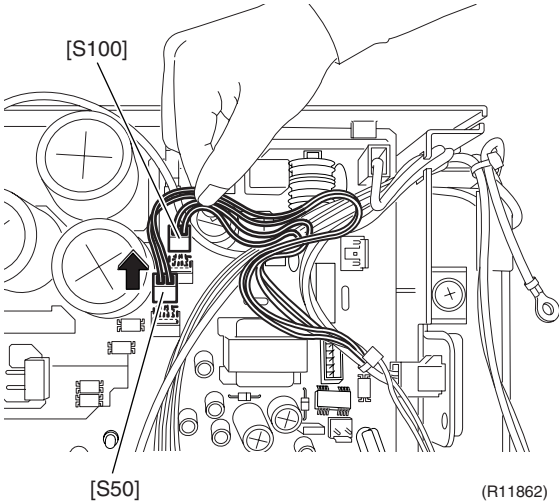
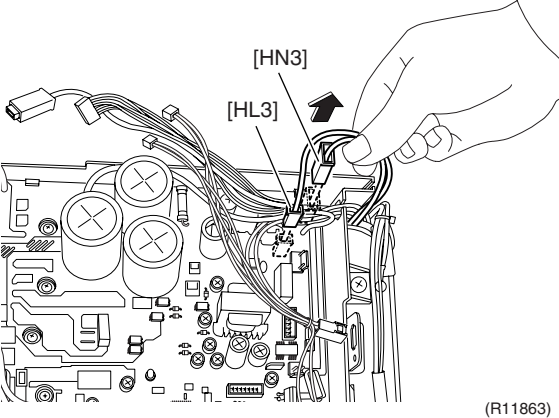
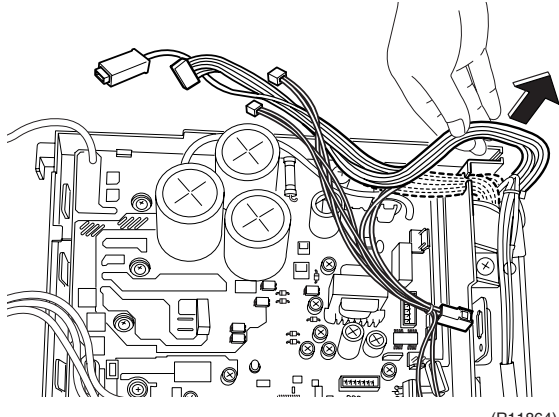
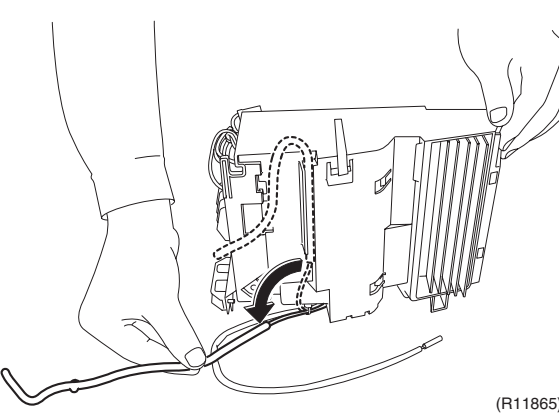
Step	Procedure	Points
10	Disconnect the connectors for the magnetic relay [S50] and for the forced operation button PCB [S100].	
11	Disconnect the connector for the filter PCB [HN3], [HL3].	
12	Release the harnesses from the hook.	
13	Release the harness for the outdoor temperature thermistor.	

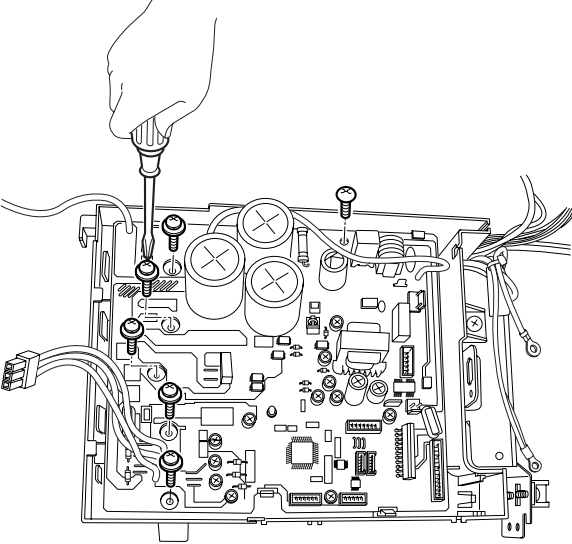
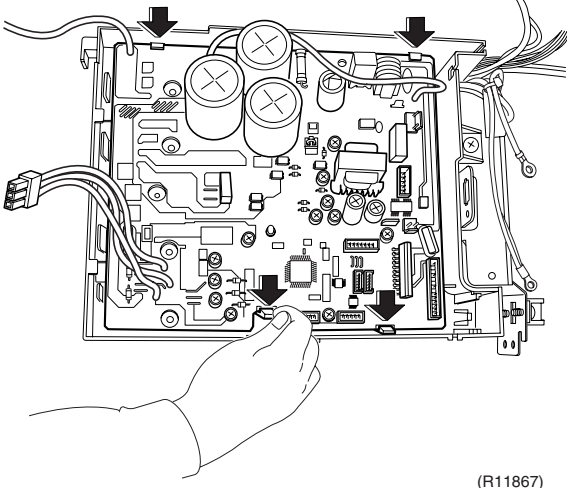
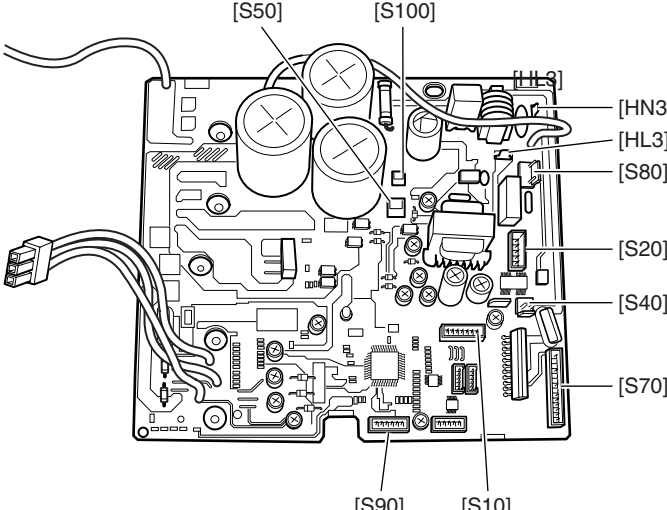
Step	Procedure	Points
14	<p>Remove the 6 screws.</p>  <p>(R11866)</p>	
15	<p>Unfasten the 4 hooks and remove the main PCB.</p>  <p>(R11867)</p>	
	 <p>(R11868)</p>	<p>■ Refer to page 11 for detail.</p> <p>[S10]: filter PCB [S20]: electronic expansion valve coil [S40]: overload protector [S50]: magnetic relay [S70]: fan motor [S80]: four way valve coil [S90]: thermistors [S100]: forced operation button PCB [HL3] [HN3]: filter PCB</p>

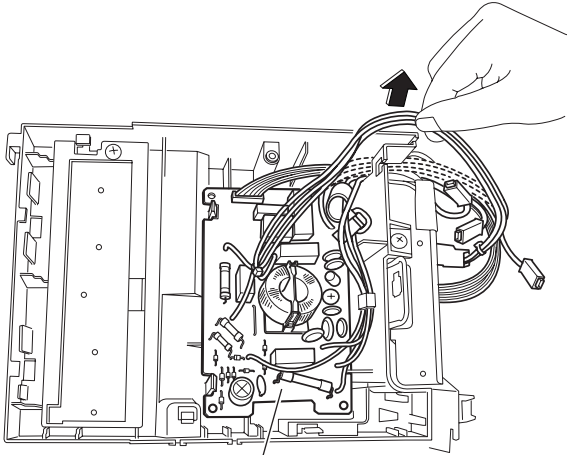
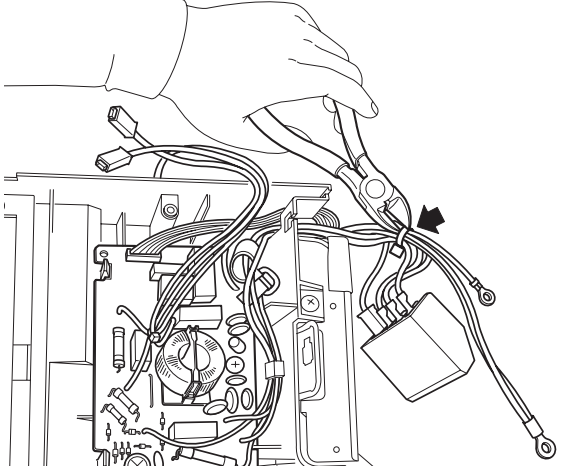
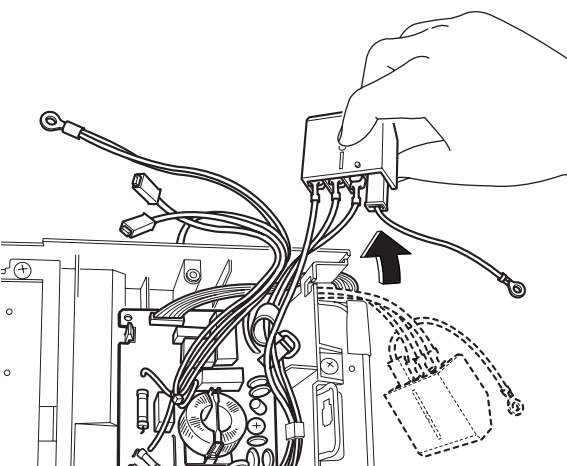
Step	Procedure	Points
<p>2. Remove the filter PCB.</p> <p>1</p>	<p>Release the harnesses from the hook.</p>  <p>Filter PCB (R11869)</p>	
<p>2</p>	<p>Cut the clamp.</p>  <p>(R11871)</p>	
<p>3</p>	<p>Release the harnesses from the hook.</p>  <p>(R11872)</p>	

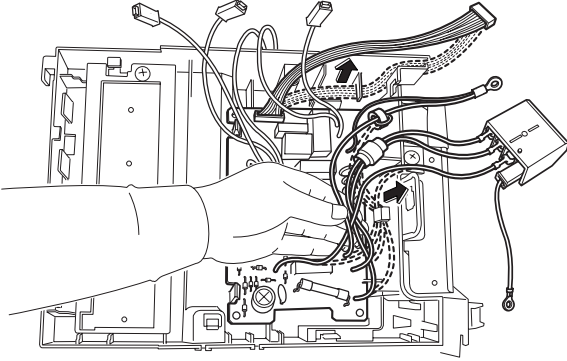
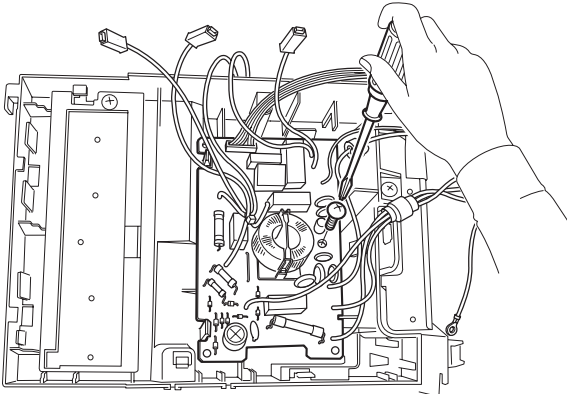
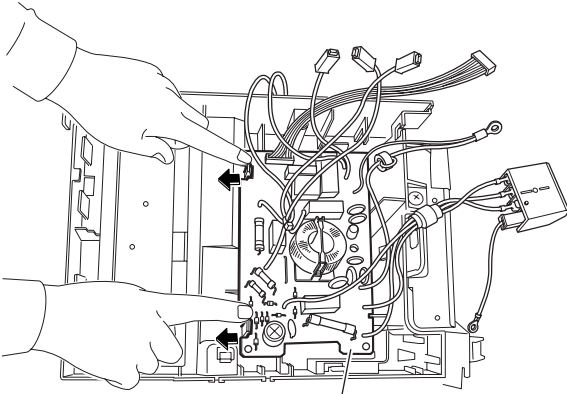
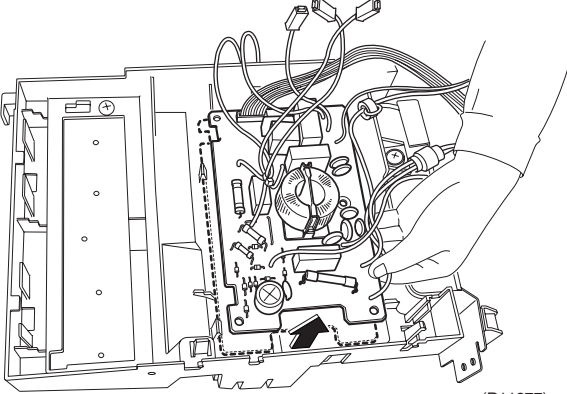
Step	Procedure	Points
4	<p>Release the harnesses from the hooks.</p>  <p>(R11873)</p>	
5	<p>Remove the screw.</p>  <p>(R11874)</p>	
6	<p>Unfasten the 2 hooks. Lift and pull out the filter PCB.</p>  <p>Filter PCB (R11876)</p>  <p>(R11877)</p>	

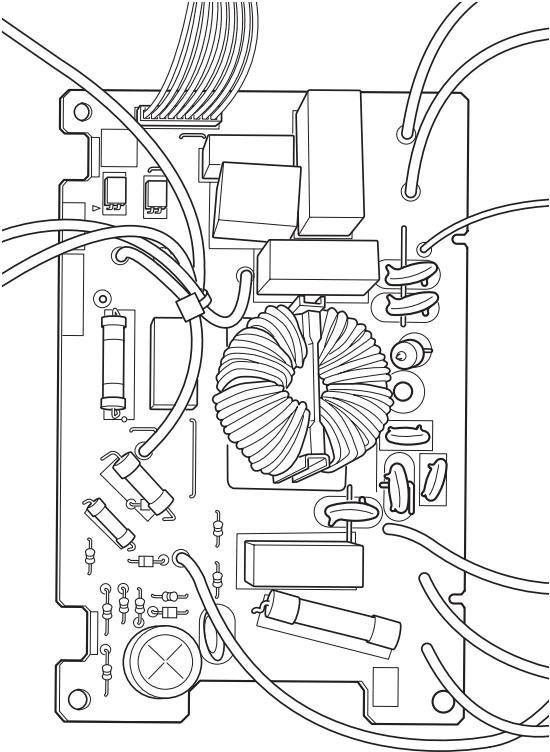
Step	Procedure	Points
7	Feature of the filter PCB	■ Refer to page 10 for detail.
		(R11878)

2.4 Removal of Reactor / Partition Plate

Procedure

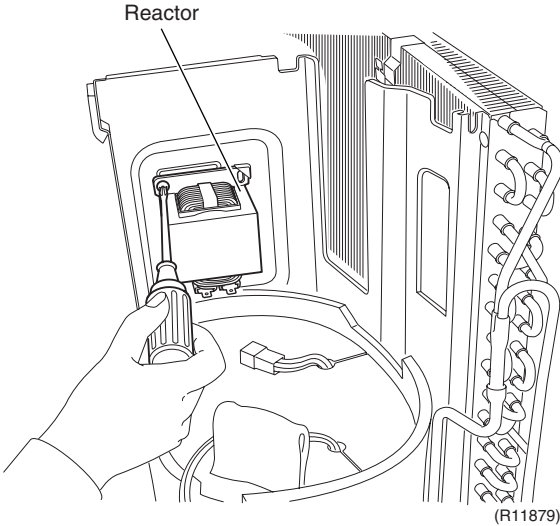
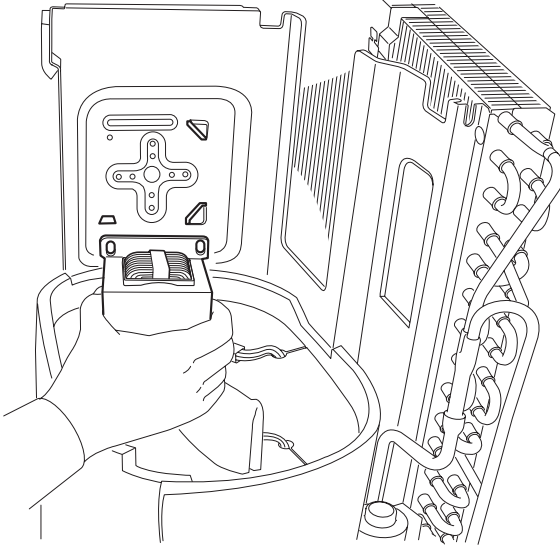
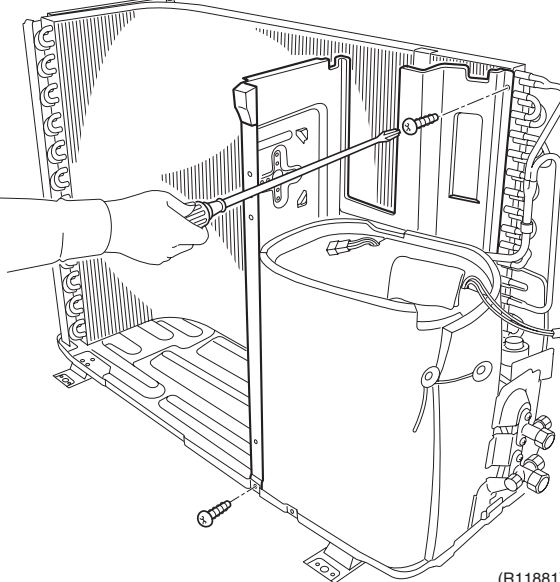

Warning Be sure to wait 10 minutes or more after turning off all power supplies before disassembling work.

Step	Procedure	Points
<p>1. Remove the reactor.</p> <p>1 Remove the screw and remove the reactor.</p>	 <p>(R11879)</p>  <p>(R11880)</p>	<p>Preparation</p> <ul style="list-style-type: none"> ■ Remove the outer panels according to the “Removal of Outer Panels / Fan Motor”. ■ Remove the electrical box according to the “Removal of Electrical Box”.
<p>2. Remove the partition plate.</p> <p>1 Remove the 2 screws.</p>	 <p>(R11881)</p>	

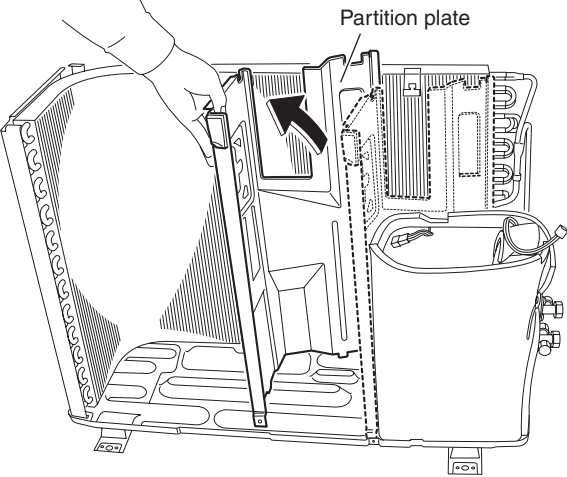
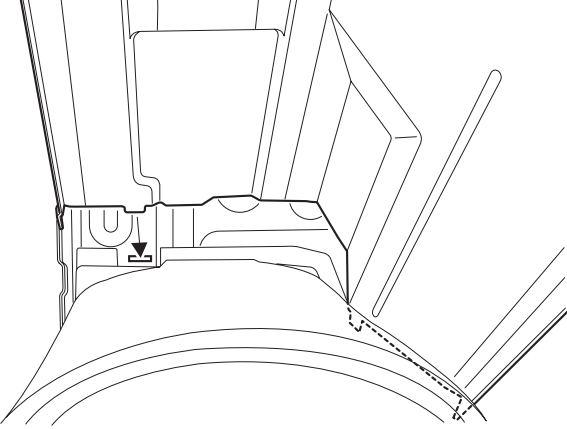
Step	Procedure	Points
2	<p data-bbox="199 219 454 376">The partition plate has a hook on the lower side. Lift and pull the partition plate to remove.</p>  <p data-bbox="979 712 1050 734">(R11882)</p>  <p data-bbox="995 1196 1066 1218">(R11883)</p>	<ul data-bbox="1093 741 1437 831" style="list-style-type: none">■ When reassembling, fit the lower hook into the bottom frame.

2.5 Removal of Sound Blanket

Procedure

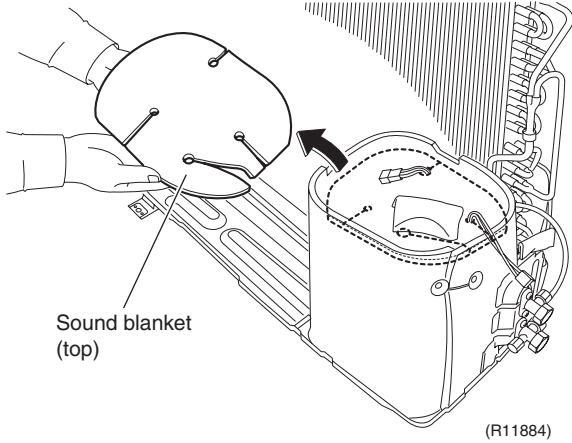
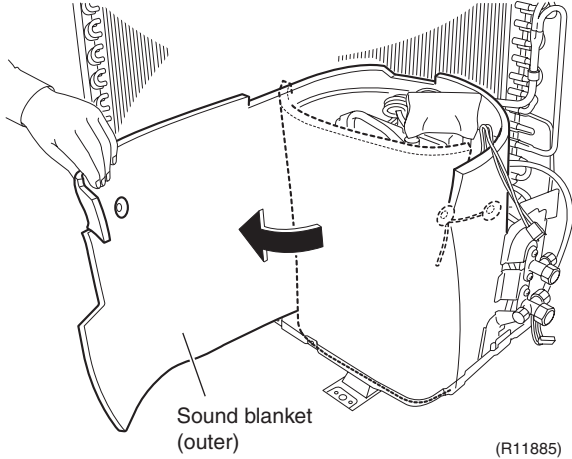
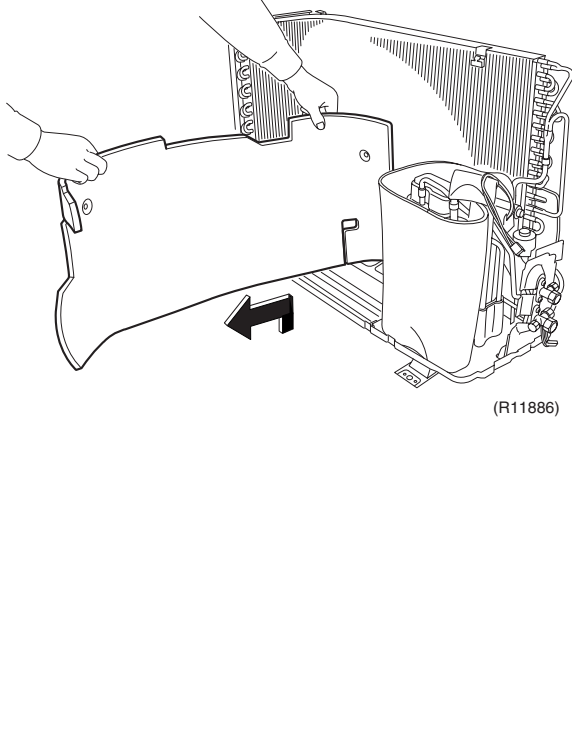

Warning Be sure to wait 10 minutes or more after turning off all power supplies before disassembling work.

Step	Procedure	Points
1. Remove the sound blanket.		
1 Remove the sound blanket (top).	 <p style="text-align: right;">(R11884)</p>	<ul style="list-style-type: none"> ■ Since the piping ports are torn easily, remove the sound blanket carefully.
2 Untie the string and open the sound blanket (outer).	 <p style="text-align: right;">(R11885)</p>	
3 Lift and remove the sound blanket (outer).	 <p style="text-align: right;">(R11886)</p>	

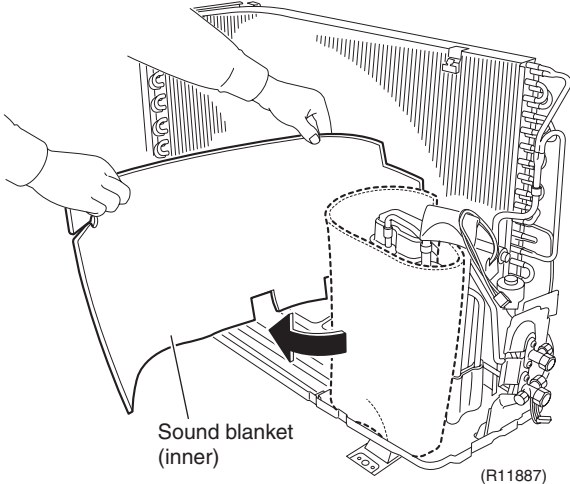
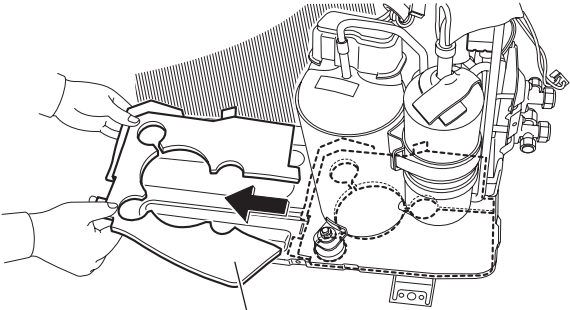
Step	Procedure	Procedure	Points
4	Pull the sound blanket (inner) out.	 <p data-bbox="651 645 794 701">Sound blanket (inner)</p> <p data-bbox="975 696 1046 712">(R11887)</p>	
5	Pull the sound blanket (bottom) out.	 <p data-bbox="710 1144 853 1200">Sound blanket (bottom)</p> <p data-bbox="975 1178 1046 1193">(R11888)</p>	

2.6 Removal of Four Way Valve

Procedure

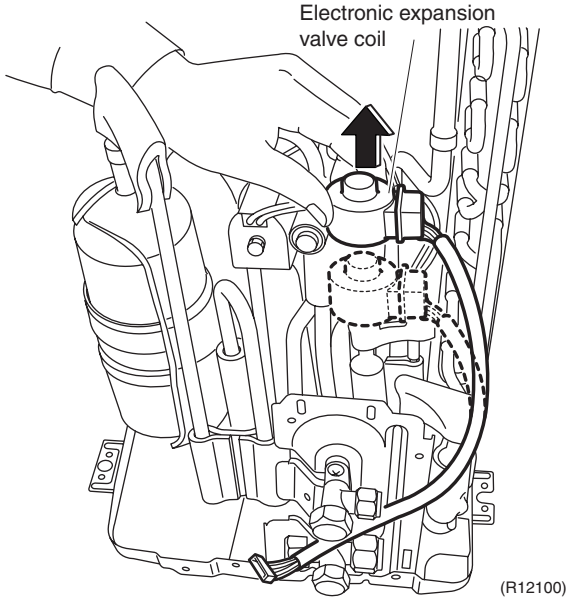
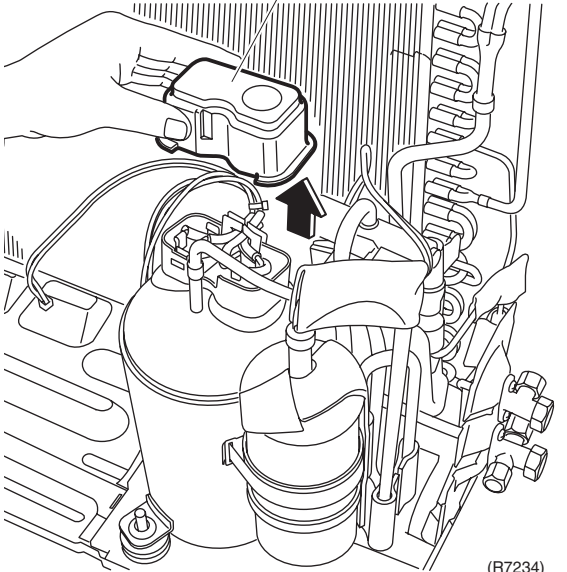
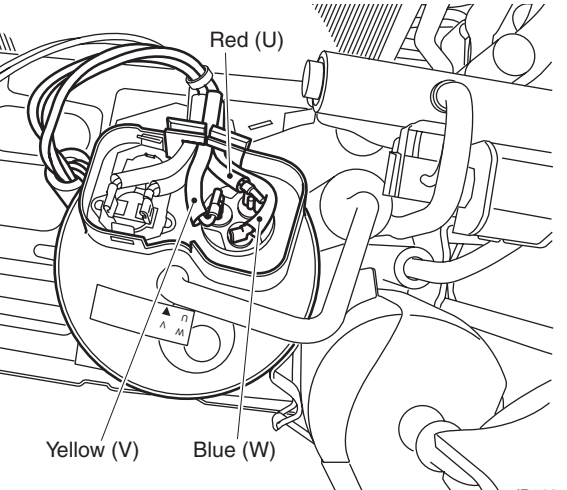

Warning Be sure to wait 10 minutes or more after turning off all power supplies before disassembling work.

Step	Procedure	Points
1. Remove the peripheries.		
1	Pull out the electronic expansion valve coil.	
		 <p>Electronic expansion valve coil</p> <p>(R12100)</p>
2	Remove the terminal cover.	
		 <p>Terminal cover</p> <p>(R7234)</p>
3	Disconnect the lead wires of the compressor.	
		 <p>Red (U)</p> <p>Yellow (V)</p> <p>Blue (W)</p> <p>(R7235)</p>

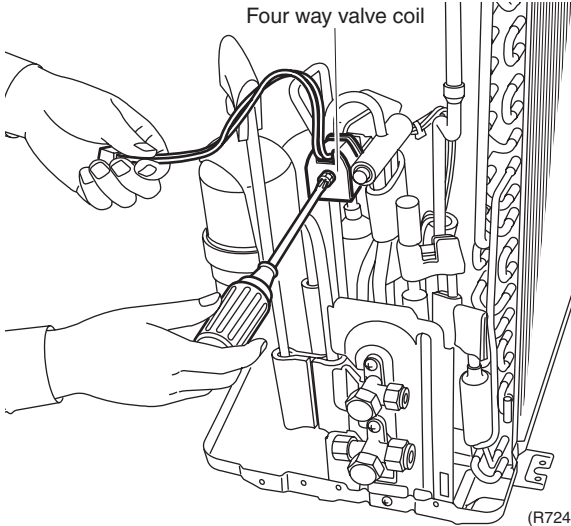
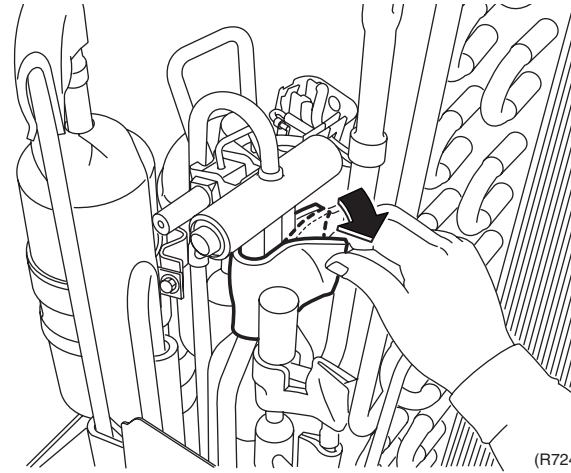
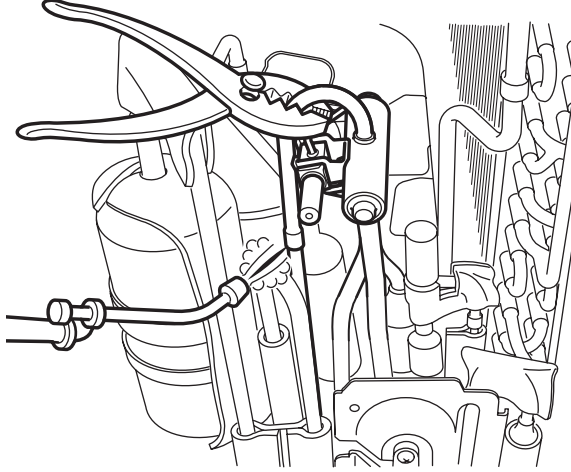
Step	Procedure	Points
<p>4 Remove the screw and remove the four way valve coil.</p>	 <p style="text-align: center;">Four way valve coil</p> <p style="text-align: right;">(R7247)</p>	<p>! Caution Be careful not to get yourself burnt with the pipes and other parts that are heated by the gas brazing machine.</p> <p>! Caution From the viewpoint of global environment protection, do not discharge the refrigerant gas in the atmosphere. Make sure to collect all the refrigerant gas.</p> <p>In case of difficulty with gas brazing machine</p> <ol style="list-style-type: none"> 1. Disconnect the brazed part where is easy to disconnect and restore. 2. Cut pipes on the main unit with a tube cutter in order to make it easy to disconnect. <p>Cautions for restoration</p> <ol style="list-style-type: none"> 1. Restore the piping by non-oxidation brazing. 2. It is required to prevent the carbonization of the oil inside the four way valve and the deterioration of the gaskets affected by heat. For the sake of this, wrap the four way valve with wet cloth and provide water so that the cloth does not dry and avoid excessive heating. (Keep below 120°C)
<p>5 Remove the sheets of putty.</p>	 <p style="text-align: right;">(R7248)</p>	
<ul style="list-style-type: none"> ■ Before working, make sure that the refrigerant gas is empty in the circuit. ■ Be sure to apply nitrogen replacement when heating up the brazed part. 		
<p>6 Heat up the brazed part and withdraw the piping with pliers.</p>	 <p style="text-align: right;">(R7249)</p>	<p>Note:</p> <ul style="list-style-type: none"> ■ Do not use a metal saw for cutting pipes by all means because the sawdust comes into the circuit. ■ Provide a protective sheet or a steel plate so that the brazing flame cannot influence peripheries. ■ Be careful so as not to break the pipes by pressing it excessively with pliers when withdrawing it.

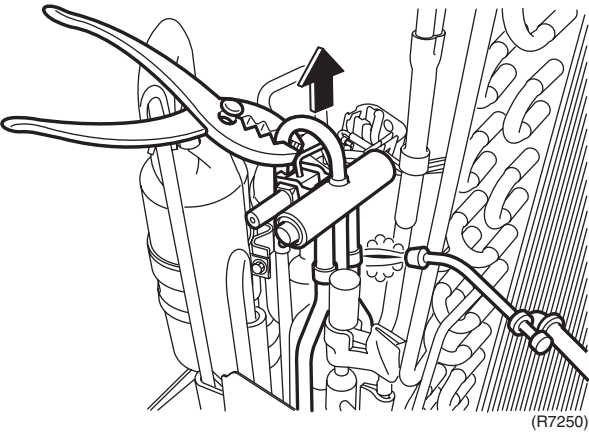
Step	Procedure	Points
	<p data-bbox="199 226 464 510">  Warning If the refrigerant gas leaks during the work, ventilate the room. (If the refrigerant gas is exposed to flames, toxic gas may be generated.) </p> 	

2.7 Removal of Compressor

Procedure

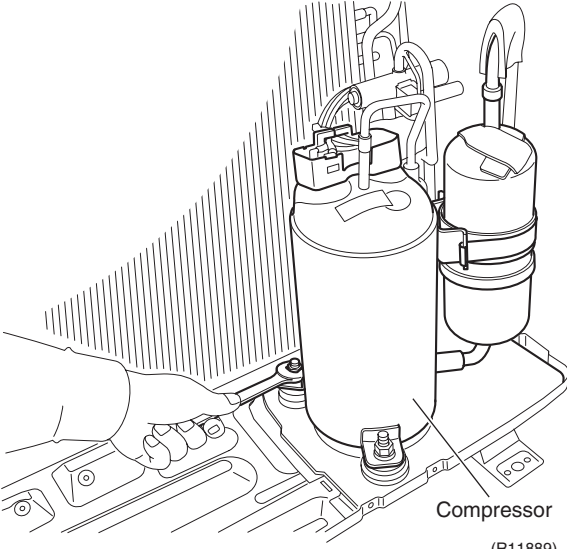
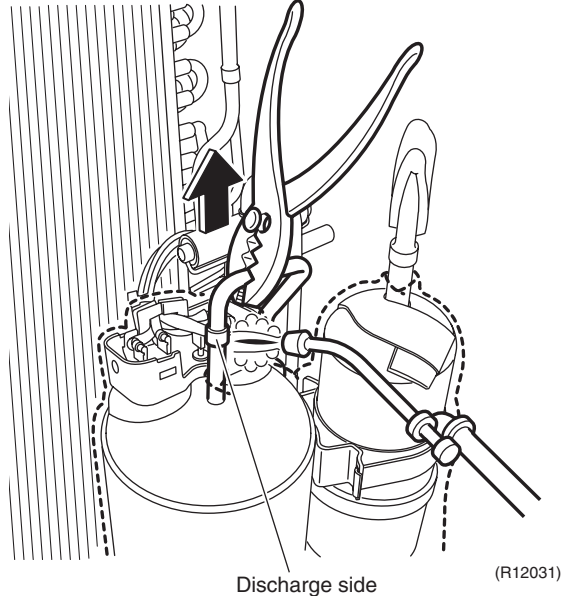

Warning Be sure to wait 10 minutes or more after turning off all power supplies before disassembling work.

Step	Procedure	Points
1.	Remove the compressor.	
1	<p>Unscrew the 2 nuts of the compressor.</p> <ul style="list-style-type: none"> ■ Before working, make sure that the refrigerant is empty in the circuit. ■ Be sure to apply nitrogen replacement when heating up the brazed part. 	<div style="margin-bottom: 20px;">  </div> <div style="margin-bottom: 20px;">  </div> <p>Warning If refrigerant gas leaks during the work, ventilate the room. (If the refrigerant gas is exposed to flames, toxic gas may be generated.)</p> <ul style="list-style-type: none"> ■ Provide a protective sheet or a steel plate so that the brazing flame cannot influence peripheries. ■ Be careful so as not to burn the compressor terminals or the name plate. ■ Be careful so as not to burn the heat exchanger fin. <p>Warning Since it may happen that refrigerant oil in the compressor catches fire, prepare wet cloth so as to extinguish fire immediately.</p> <p>In case of difficulty with gas brazing machine</p> <ol style="list-style-type: none"> 1. Disconnect the brazed part where is easy to disconnect and restore. 2. Cut pipes on the main unit with a tube cutter in order to make it easy to disconnect. <p>Cautions for restoration</p> <ol style="list-style-type: none"> 1. Restore the piping by non-oxidation brazing. 2. It is required to prevent the carbonization of the oil inside the four way valve and the deterioration of the gaskets affected by heat. For the sake of this, wrap the four way valve with wet cloth and provide water so that the cloth does not dry and avoid excessive heating. (Keep below 120°C) <p>Note:</p> <ul style="list-style-type: none"> ■ Do not use a metal saw for cutting pipes by all means because the sawdust comes into the circuit.
2	Heat up the brazed part of the discharge side and disconnect.	

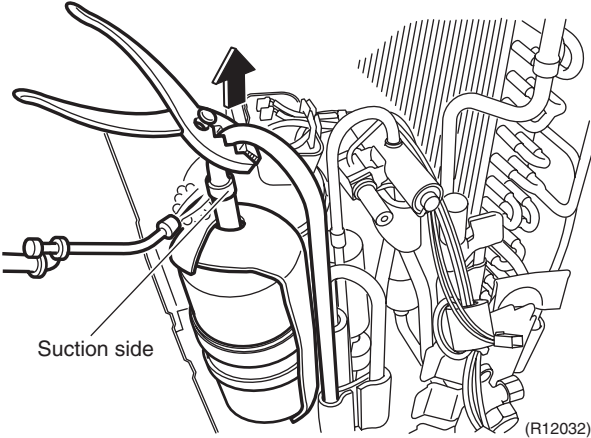
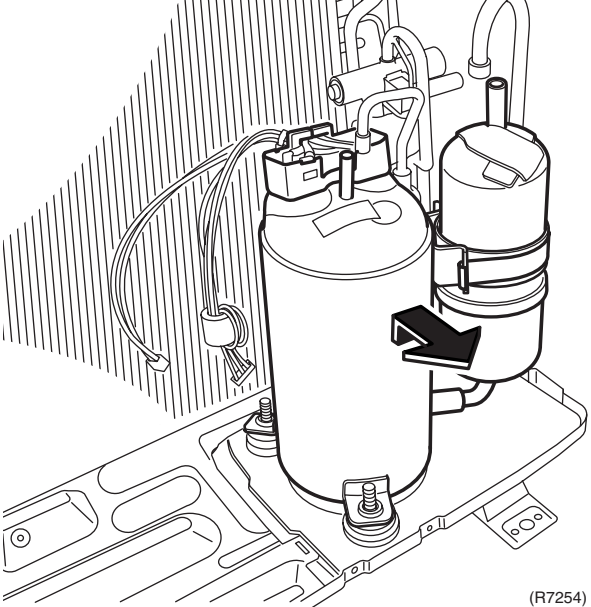
Step	Procedure	Points
3	<p>Heat up the brazed part of the suction side and disconnect.</p> 	
4	<p>Lift the compressor up and remove it.</p> 	

Part 8 Others

1. Others	176
1.1 Trial Operation.....	176
1.2 Field Settings.....	177
1.3 Application of Silicon Grease to a Power Transistor and a Diode Bridge.....	178

1. Others

1.1 Trial Operation

Outline

1. Measure the supply voltage and make sure that it falls in the specified range.
2. Trial operation should be carried out in either cooling or heating mode.
3. Carry out the trial operation in accordance with the operation manual to ensure that all functions and parts, such as flap movement, are working properly.
 - The air conditioner requires a small amount of power in its standby mode. If the system is not to be used for some time after installation, shut off the circuit breaker to eliminate unnecessary power consumption.
 - If the circuit breaker trips to shut off the power to the air conditioner, the system backs up the operation mode. The system then restarts operation with the previous mode when the circuit breaker is restored.

In cooling mode, select the lowest programmable temperature; in heating mode, select the highest programmable temperature.

- Trial operation may be disabled in either mode depending on the room temperature.
- After trial operation is complete, set the temperature to a normal level.
(26°C to 28°C in cooling mode, 20°C to 24°C in heating mode)
- For protection, the system does not start for 3 minutes after it is turned off.

Detail

ARC466 Series

- (1) Press the On/Off button to turn on the system.
- (2) Press the center of the Temp button and the Mode button at the same time.
- (3) Select “?” (trial operation) with the Temp ▲ or ▼ button.
- (4) Press the Mode button to start the trial operation.
- (5) Press the Mode button and select operation mode.
- (6) Trial operation terminates in approx. 30 minutes and switches into normal mode. To quit a trial operation, press the On/Off button.

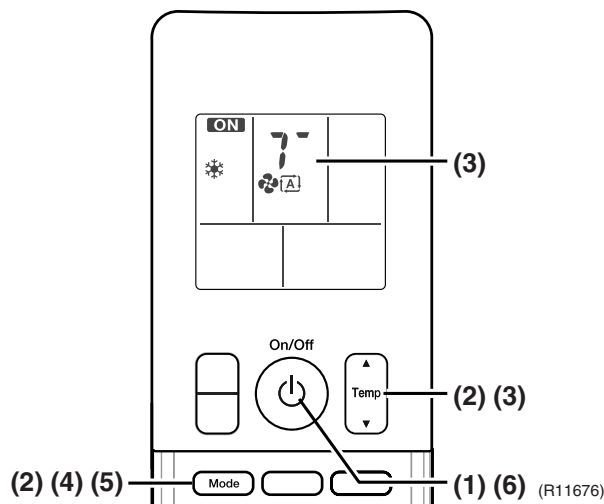

1.2 Field Settings

1.2.1 When 2 Units are Installed in 1 Room

- When 2 indoor units are installed in 1 room, 1 of the 2 pairs of indoor unit and wireless remote controller can be set for different addresses.
Both the indoor unit PCB and the wireless remote controller need alteration.

- Remove the front panel and front grille. (4 screws)
- Cut the address setting jumper (JA) on the signal receiver / display PCB.
- Cut the address setting jumper of the remote controller.

<Indoor unit PCB>

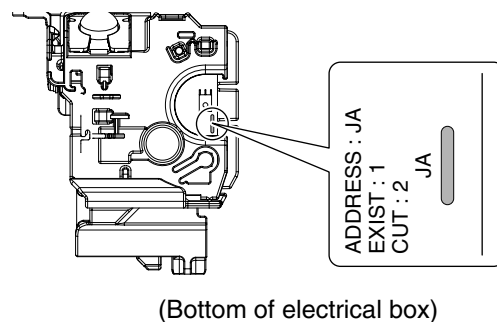

(R12036)

<Wireless Remote Controller>

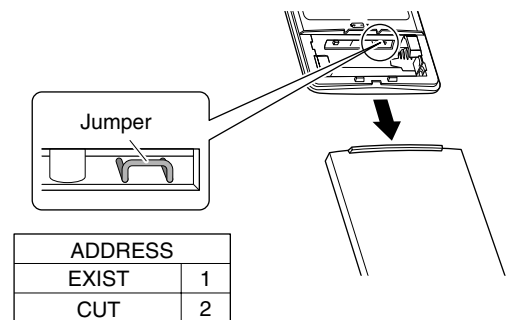

(R12037)

1.2.2 Jumper Settings

Jumper	Function	When connected (factory set)	When cut
JB (on indoor unit PCB)	Fan speed setting when compressor stops for thermostat OFF. (effective only at cooling operation)	Fan speed setting ; Remote controller setting	Fan speed setting; "0" (The fan stops.)
JC (on indoor unit PCB)	Power failure recovery function	Auto-restart	The unit does not resume operation after recovering from a power failure. Timer settings are cleared.
J5 (on outdoor unit PCB)	Improvement of defrost performance	Standard control	Reinforced control (ex. The frequency increases, the duration time of defrost lengthens.)



For the location of the jumper, refer to the following pages.

Indoor unit; page 8

Outdoor unit; page 11

1.3 Application of Silicon Grease to a Power Transistor and a Diode Bridge

Applicable Models

All outdoor units using inverter type compressor for room air conditioner.

When the printed circuit board (PCB) of an outdoor unit is replaced, it is required that silicon grease (*1) is certainly applied to the heat radiation part (the contact point to the radiation fin) of the power transistor and diode bridge.

*1: Parts number of the silicon grease – 1172698 (Drawing number 3FB03758-1)

Details

The silicon grease is an essential article for encouraging the heat radiation of the power transistor and the diode bridge. Applying the paste should be implemented in accordance with the following instruction.

Remark: There is the possibility of failure with smoke in case of bad heat radiation.

- Wipe off the old silicon grease completely on a radiation fin.
- Apply the silicon grease evenly to the whole.
- Do not leave any foreign object such as solder or paper waste between the power transistor and the radiation fin, and also the diode bridge, and the radiation fin.
- Tighten the screws of the power transistor and the diode bridge, and contact to the radiation fin without any gap.

<Example>

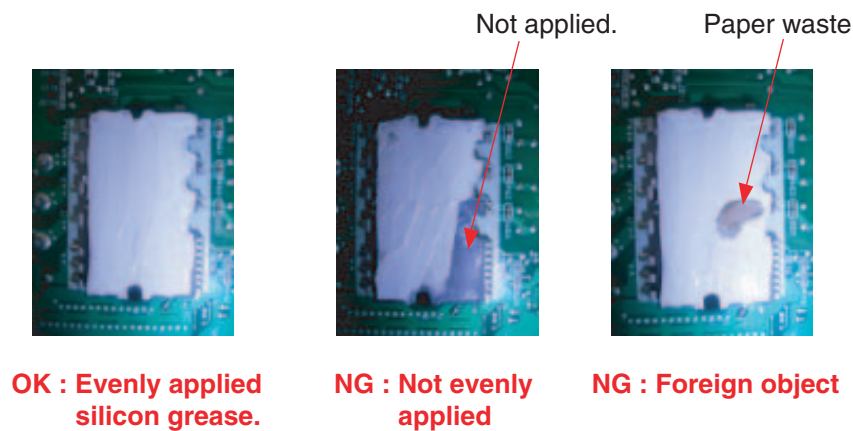
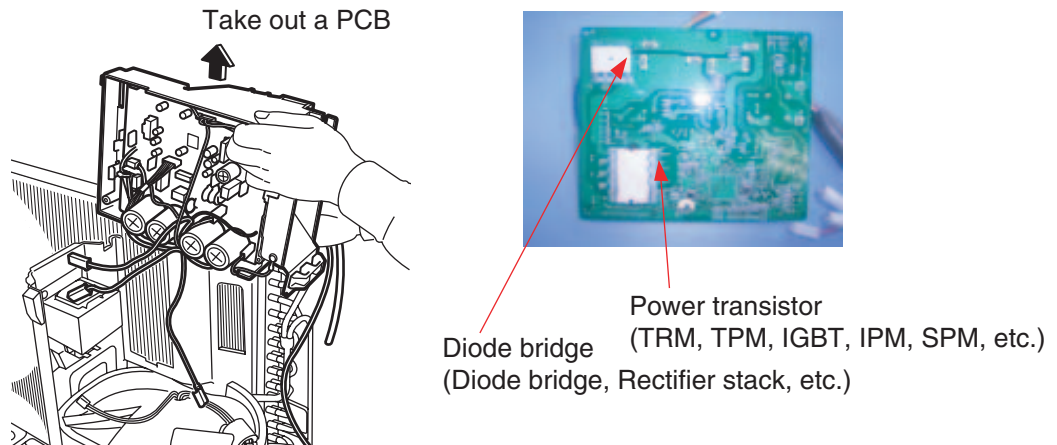

(R9056)

Part 9 Appendix

1. Piping Diagrams.....	180
1.1 Indoor Unit.....	180
1.2 Outdoor Unit.....	180
2. Wiring Diagrams.....	181
2.1 Indoor Unit.....	181
2.2 Outdoor Unit.....	181

1. Piping Diagrams

1.1 Indoor Unit

FTXG25/35JV1BW(S)

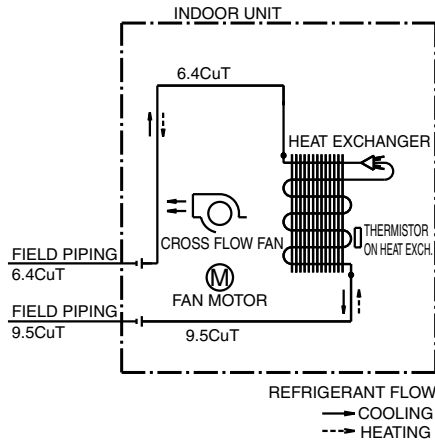

4D065855

1.2 Outdoor Unit

RXG25/35J2V1B

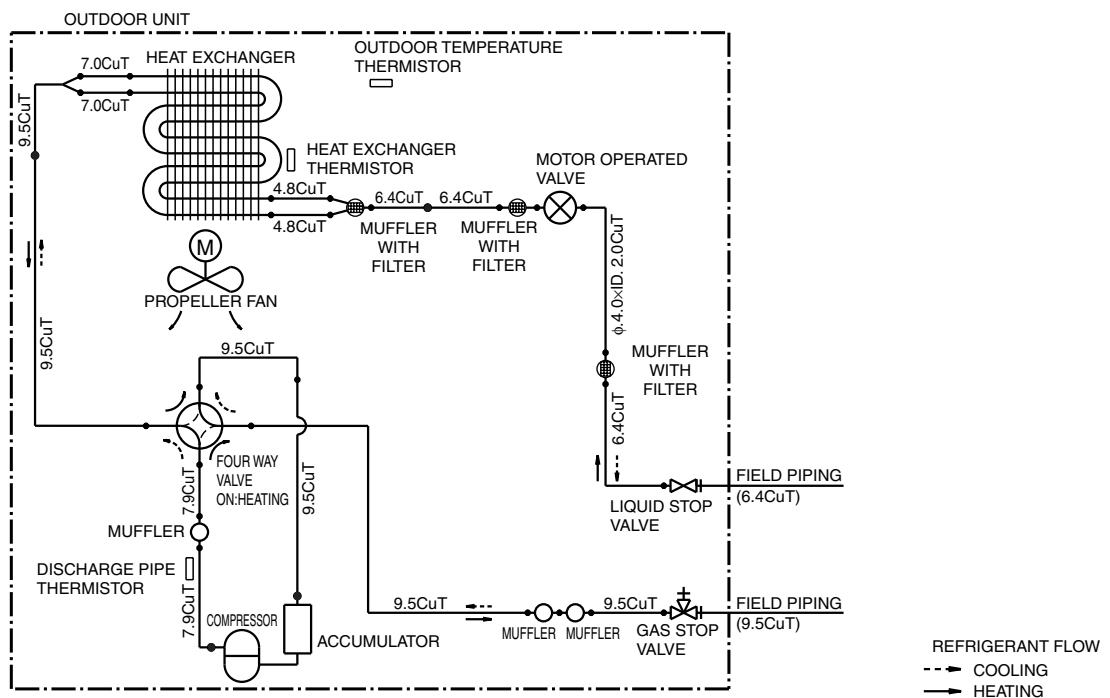

3D059586E

2. Wiring Diagrams

2.1 Indoor Unit

FTXG25/35JV1BW(S)

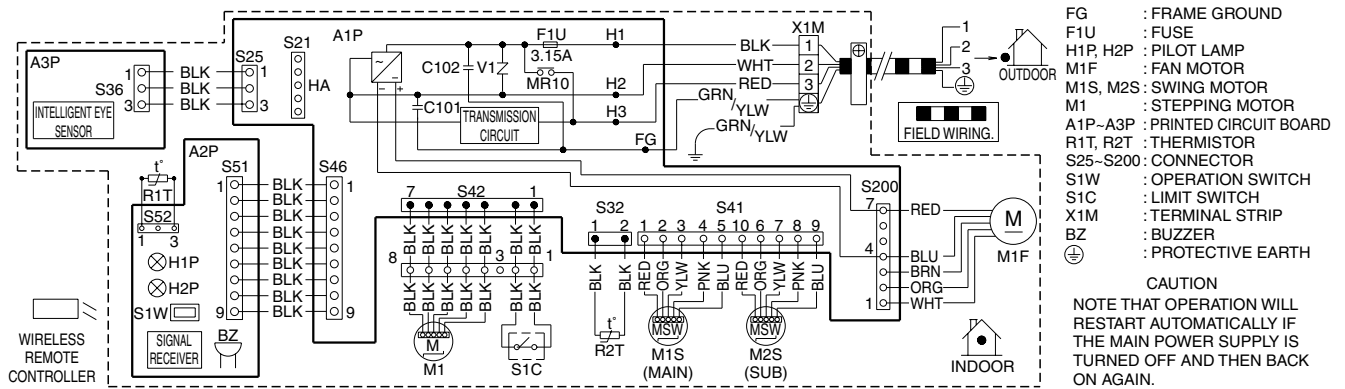

3D065507A

2.2 Outdoor Unit

RXG25/35J2V1B

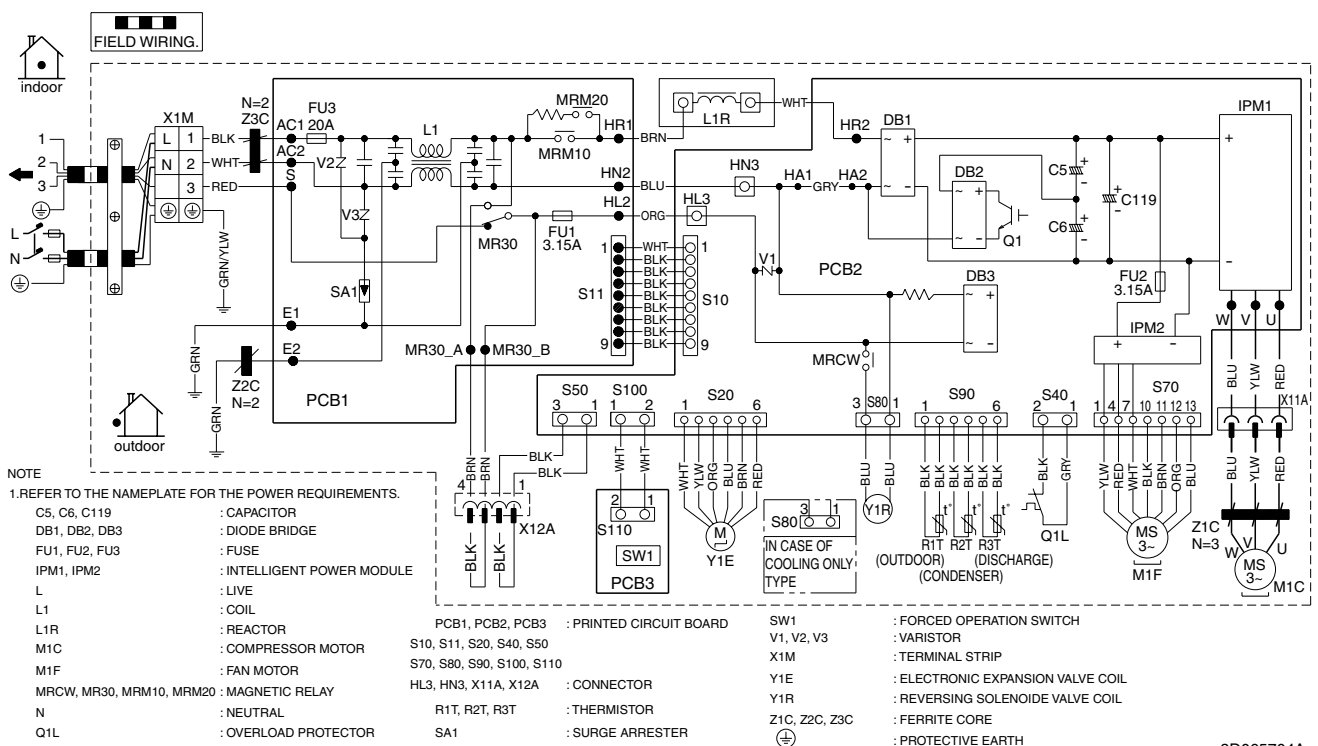

3D065704A



- Daikin Industries, Ltd.'s products are manufactured for export to numerous countries throughout the world. Daikin Industries, Ltd. does not have control over which products are exported to and used in a particular country. Prior to purchase, please therefore confirm with your local authorised importer, distributor and/or retailer whether this product conforms to the applicable standards, and is suitable for use, in the region where the product will be used. This statement does not purport to exclude, restrict or modify the application of any local legislation.
- Ask a qualified installer or contractor to install this product. Do not try to install the product yourself. Improper installation can result in water or refrigerant leakage, electrical shock, fire or explosion.
 - Use only those parts and accessories supplied or specified by Daikin. Ask a qualified installer or contractor to install those parts and accessories. Use of unauthorised parts and accessories or improper installation of parts and accessories can result in water or refrigerant leakage, electrical shock, fire or explosion.
 - Read the User's Manual carefully before using this product. The User's Manual provides important safety instructions and warnings. Be sure to follow these instructions and warnings.

If you have any enquiries, please contact your local importer, distributor and/or retailer.

Cautions on product corrosion

1. Air conditioners should not be installed in areas where corrosive gases, such as acid gas or alkaline gas, are produced.
2. If the outdoor unit is to be installed close to the sea shore, direct exposure to the sea breeze should be avoided. If you need to install the outdoor unit close to the sea shore, contact your local distributor.



JMI-0107

Organization:
DAIKIN INDUSTRIES, LTD.
AIR CONDITIONING MANUFACTURING DIVISION

Scope of Registration:
THE DESIGN/DEVELOPMENT AND MANUFACTURE OF
COMMERCIAL AIR CONDITIONING, HEATING, COOLING,
REFRIGERATING EQUIPMENT, COMMERCIAL HEATING
EQUIPMENT, RESIDENTIAL AIR CONDITIONING
EQUIPMENT, HEAT RECLAIM VENTILATION, AIR
CLEANING EQUIPMENT, MARINE TYPE CONTAINER
REFRIGERATION UNITS, COMPRESSORS AND VALVES.



JQA-1452

Organization:
DAIKIN INDUSTRIES
(THAILAND) LTD.

Scope of Registration:
THE DESIGN/DEVELOPMENT
AND MANUFACTURE OF AIR
CONDITIONERS AND THE
COMPONENTS INCLUDING
COMPRESSORS USED FOR THEM



EC99J2044

All of the Daikin Group's business facilities and subsidiaries in Japan are certified under the ISO 14001 international standard for environment management.

Dealer

DAIKIN INDUSTRIES, LTD.

Head Office:
Umeda Center Bldg., 2-4-12, Nakazaki-Nishi,
Kita-ku, Osaka, 530-8323 Japan

Tokyo Office:
JR Shinagawa East Bldg., 2-18-1, Konan,
Minato-ku, Tokyo, 108-0075 Japan

http://www.daikin.com/global_ac/

©All rights reserved