

Service Manual

Inverter Pair Floor / Ceiling Suspended Dual Type BA-Series

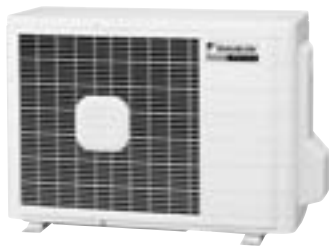

[Applied Models]

- Inverter Pair : Cooling Only
- Inverter Pair : Heat Pump

Inverter Pair Floor / Ceiling Suspended Dual Type BA-Series

●Cooling Only

Indoor Unit

FLKS25BAVMB
FLKS35BAVMB

Outdoor Unit

RKS25E2V1B
RKS35E2V1B

RKS25G2V1B
RKS35G2V1B

RKS25G2V1B9
RKS35G2V1B9

●Heat Pump

Indoor Unit

FLXS25BAVMB
FLXS35BAVMB

Outdoor Unit

RXS25E2V1B
RXS35E2V1B

RXS25G2V1B
RXS35G2V1B

RXS25G2V1B9
RXS35G2V1B9

1. Introduction	V
1.1 Safety Cautions	v
1.2 Used Icons	ix
Part 1 List of Functions	1
1. Functions.....	2
Part 2 Specifications	5
1. Specifications	6
1.1 Cooling Only	6
1.2 Heat Pump	9
Part 3 Printed Circuit Board Connector Wiring Diagram	12
1. Printed Circuit Board Connector Wiring Diagram.....	13
1.1 Indoor Unit.....	13
1.2 Outdoor Unit.....	15
Part 4 Function and Control.....	21
1. Main Functions.....	22
1.1 Temperature Control	22
1.2 Frequency Principle.....	22
1.3 Airflow Direction Control.....	24
1.4 Fan Speed Control for Indoor Units.....	25
1.5 Program Dry Operation	26
1.6 Automatic Operation.....	27
1.7 Thermostat Control.....	28
1.8 NIGHT SET Mode	29
1.9 HOME LEAVE Operation	30
1.10 Inverter POWERFUL Operation	31
1.11 Other Functions.....	32
2. Function of Thermistor	33
3. Control Specification	34
3.1 Mode Hierarchy	34
3.2 Frequency Control.....	35
3.3 Controls at Mode Changing / Start-up.....	37
3.4 Discharge Pipe Temperature Control.....	39
3.5 Input Current Control.....	40
3.6 Freeze-up Protection Control	41
3.7 Heating Peak-cut Control	41
3.8 Outdoor Fan Control.....	42
3.9 Liquid Compression Protection Function.....	42
3.10 Defrost Control	43
3.11 Electronic Expansion Valve Control	44
3.12 Malfunctions	47
3.13 Forced Operation Mode	48
3.14 Standby Electricity Saving.....	48

Part 5 Operation Manual	49
1. System Configuration.....	50
2. Operation Manual.....	51
2.1 Remote Controller	51
2.2 AUTO · DRY · COOL · HEAT · FAN Operation	52
2.3 Adjusting the Airflow Direction.....	54
2.4 POWERFUL Operation	56
2.5 OUTDOOR UNIT QUIET Operation.....	57
2.6 HOME LEAVE Operation	58
2.7 TIMER Operation	60
Part 6 Service Diagnosis.....	62
1. Caution for Diagnosis.....	63
1.1 Troubleshooting with LED	63
2. Problem Symptoms and Measures	64
2.1 ARC433 Series.....	65
3. Troubleshooting	68
3.1 Error Codes and Description	68
3.2 Indoor Unit PCB Abnormality	69
3.3 Freeze-up Protection Control or Heating Peak-cut Control.....	70
3.4 Fan Motor (AC Motor) or Related Abnormality.....	72
3.5 Thermistor or Related Abnormality (Indoor Unit).....	73
3.6 Signal Transmission Error (between Indoor Unit and Outdoor Unit).....	74
3.7 Unspecified Voltage (between Indoor Unit and Outdoor Unit)	75
3.8 Outdoor Unit PCB Abnormality.....	76
3.9 OL Activation (Compressor Overload)	77
3.10 Compressor Lock	78
3.11 DC Fan Lock	79
3.12 Input Overcurrent Detection	80
3.13 Four Way Valve Abnormality	81
3.14 Discharge Pipe Temperature Control.....	83
3.15 High Pressure Control in Cooling	84
3.16 Compressor System Sensor Abnormality	85
3.17 Position Sensor Abnormality	86
3.18 DC Voltage / Current Sensor Abnormality.....	88
3.19 Thermistor or Related Abnormality (Outdoor Unit).....	89
3.20 Electrical Box Temperature Rise	91
3.21 Radiation Fin Temperature Rise	94
3.22 Output Overcurrent Detection	97
3.23 Refrigerant Shortage	99
3.24 Low-voltage Detection or Over-voltage Detection.....	101
4. Check	103
4.1 How to Check.....	103
Part 7 Removal Procedure	112
1. Indoor Unit.....	113
1.1 Removal of Air Filter / Front Grille	113
1.2 Removal of Front Panel.....	116
1.3 Removal of Horizontal Blade.....	118
1.4 Removal of Signal Receiver Unit / Swing Motor.....	119

1.5	Removal of Discharge Grille.....	120
1.6	Removal of Drain Pan	121
1.7	Removal of Electrical Box / PCB	122
1.8	Removal of Fan Rotor / Fan Motor	125
1.9	Removal of Indoor Heat Exchanger	127
2.	Outdoor Unit - RK(X)S25/35E2V1B	129
2.1	Removal of Outer Panels / Fan Motor	129
2.2	Removal of Electrical Box	137
2.3	Removal of PCB.....	141
2.4	Removal of Reactor / Partition Plate	143
2.5	Removal of Sound Blanket.....	145
2.6	Removal of Four Way Valve.....	147
2.7	Removal of Compressor.....	150
3.	Outdoor Unit - RK(X)S25/35G2V1B.....	152
3.1	Removal of Outer Panels / Fan Motor.....	152
3.2	Removal of Electrical Box	161
3.3	Removal of Thermistors	165
3.4	Removal of PCB.....	167
3.5	Removal of Reactor / Partition Plate	170
3.6	Removal of Sound Blanket.....	172
3.7	Removal of Four Way Valve.....	173
3.8	Removal of Compressor.....	176
4.	Outdoor Unit - RK(X)S25/35G2V1B9.....	178
4.1	Removal of Outer Panels / Fan Motor.....	178
4.2	Removal of Electrical Box	187
4.3	Removal of PCB.....	190
4.4	Removal of Reactor / Partition Plate	198
4.5	Removal of Sound Blanket.....	200
4.6	Removal of Four Way Valve.....	202
4.7	Removal of Compressor.....	205

Part 8 Trial Operation and Field Settings..... 207

1.	Trial Operation	208
2.	Field Settings	209
2.1	When 2 Units are Installed in 1 Room.....	209
2.2	Standby Electricity Saving.....	210
2.3	Facility Setting Jumper (cooling at low outdoor temperature)	211
2.4	Jumper and Switch Settings.....	212
3.	Application of Silicon Grease to a Power Transistor and a Diode Bridge	213





Part 9 Appendix..... 214

1.	Piping Diagrams.....	215
1.1	Indoor Unit.....	215
1.2	Outdoor Unit.....	216
2.	Wiring Diagrams.....	218
2.1	Indoor Unit.....	218
2.2	Outdoor Unit.....	218







1. Introduction



1.1 Safety Cautions









Cautions and Warnings

- Be sure to read the following safety cautions before conducting repair work.
- The caution items are classified into “ **Warning**” and “ **Caution**”. The “ **Warning**” items are especially important since they can lead to death or serious injury if they are not followed closely. The “ **Caution**” items can also lead to serious accidents under some conditions if they are not followed. Therefore, be sure to observe all the safety caution items described below.
- About the pictograms
 - △ This symbol indicates the item for which caution must be exercised.
The pictogram shows the item to which attention must be paid.
 - This symbol indicates the prohibited action.
The prohibited item or action is shown in the illustration or near the symbol.
 - This symbol indicates the action that must be taken, or the instruction.
The instruction is shown in the illustration or near the symbol.
- After the repair work is complete, be sure to conduct a test operation to ensure that the equipment operates normally, and explain the cautions for operating the product to the customer.











1.1.1 Cautions Regarding Safety of Workers





 Warning	
Be sure to disconnect the power cable plug from the plug socket before disassembling the equipment for repair. Working on the equipment that is connected to the power supply may cause an electrical shock. If it is necessary to supply power to the equipment to conduct the repair or inspecting the circuits, do not touch any electrically charged sections of the equipment.	
If the refrigerant gas is discharged during the repair work, do not touch the discharged refrigerant gas. The refrigerant gas may cause frostbite.	
When disconnecting the suction or discharge pipe of the compressor at the welded section, evacuate the refrigerant gas completely at a well-ventilated place first. If there is a gas remaining inside the compressor, the refrigerant gas or refrigerating machine oil discharges when the pipe is disconnected, and it may cause injury.	
If the refrigerant gas leaks during the repair work, ventilate the area. The refrigerant gas may generate toxic gases when it contacts flames.	
The step-up capacitor supplies high-voltage electricity to the electrical components of the outdoor unit. Be sure to discharge the capacitor completely before conducting repair work. A charged capacitor may cause an electrical shock.	
Do not start or stop the air conditioner operation by plugging or unplugging the power cable plug. Plugging or unplugging the power cable plug to operate the equipment may cause an electrical shock or fire.	







 Warning	
Be sure to wear a safety helmet, gloves, and a safety belt when working at a high place (more than 2 m). Insufficient safety measures may cause a fall accident.	
In case of R-410A refrigerant models, be sure to use pipes, flare nuts and tools for the exclusive use of the R-410A refrigerant. The use of materials for R-22 refrigerant models may cause a serious accident such as a damage of refrigerant cycle as well as an equipment failure.	





 Caution	
Do not repair the electrical components with wet hands. Working on the equipment with wet hands may cause an electrical shock.	
Do not clean the air conditioner by splashing water. Washing the unit with water may cause an electrical shock.	
Be sure to provide the grounding when repairing the equipment in a humid or wet place, to avoid electrical shocks.	
Be sure to turn off the power switch and unplug the power cable when cleaning the equipment. The internal fan rotates at a high speed, and cause injury.	
Be sure to conduct repair work with appropriate tools. The use of inappropriate tools may cause injury.	
Be sure to check that the refrigerating cycle section has cooled down enough before conducting repair work. Working on the unit when the refrigerating cycle section is hot may cause burns.	
Use the welder in a well-ventilated place. Using the welder in an enclosed room may cause oxygen deficiency.	

1.1.2 Cautions Regarding Safety of Users

 Warning	
<p>Be sure to use parts listed in the service parts list of the applicable model and appropriate tools to conduct repair work. Never attempt to modify the equipment. The use of inappropriate parts or tools may cause an electrical shock, excessive heat generation or fire.</p>	
<p>If the power cable and lead wires have scratches or deteriorated, be sure to replace them. Damaged cable and wires may cause an electrical shock, excessive heat generation or fire.</p>	
<p>Do not use a joined power cable or extension cable, or share the same power outlet with other electrical appliances, since it may cause an electrical shock, excessive heat generation or fire.</p>	
<p>Be sure to use an exclusive power circuit for the equipment, and follow the local technical standards related to the electrical equipment, the internal wiring regulations, and the instruction manual for installation when conducting electrical work. Insufficient power circuit capacity and improper electrical work may cause an electrical shock or fire.</p>	
<p>Be sure to use the specified cable for wiring between the indoor and outdoor units. Make the connections securely and route the cable properly so that there is no force pulling the cable at the connection terminals. Improper connections may cause excessive heat generation or fire.</p>	
<p>When wiring between the indoor and outdoor units, make sure that the terminal cover does not lift off or dismount because of the cable. If the cover is not mounted properly, the terminal connection section may cause an electrical shock, excessive heat generation or fire.</p>	
<p>Do not damage or modify the power cable. Damaged or modified power cable may cause an electrical shock or fire. Placing heavy items on the power cable, and heating or pulling the power cable may damage the cable.</p>	
<p>Do not mix air or gas other than the specified refrigerant (R-410A / R-22) in the refrigerant system. If air enters the refrigerating system, an excessively high pressure results, causing equipment damage and injury.</p>	
<p>If the refrigerant gas leaks, be sure to locate the leaking point and repair it before charging the refrigerant. After charging refrigerant, make sure that there is no refrigerant leak. If the leaking point cannot be located and the repair work must be stopped, be sure to perform pump-down and close the service valve, to prevent the refrigerant gas from leaking into the room. The refrigerant gas itself is harmless, but it may generate toxic gases when it contacts flames, such as fan and other heaters, stoves and ranges.</p>	
<p>When relocating the equipment, make sure that the new installation site has sufficient strength to withstand the weight of the equipment. If the installation site does not have sufficient strength and if the installation work is not conducted securely, the equipment may fall and cause injury.</p>	





 Warning	
Check to make sure that the power cable plug is not dirty or loose, then insert the plug into a power outlet securely. If the plug has dust or loose connection, it may cause an electrical shock or fire.	
Be sure to install the product correctly by using the provided standard installation frame. Incorrect use of the installation frame and improper installation may cause the equipment to fall, resulting in injury.	For unitary type only 
Be sure to install the product securely in the installation frame mounted on the window frame. If the unit is not securely mounted, it may fall and cause injury.	For unitary type only 
When replacing the coin battery in the remote controller, be sure to disposed of the old battery to prevent children from swallowing it. If a child swallows the coin battery, see a doctor immediately.	

 Caution	
Installation of a leakage breaker is necessary in some cases depending on the conditions of the installation site, to prevent electrical shocks.	
Do not install the equipment in a place where there is a possibility of combustible gas leaks. If the combustible gas leaks and remains around the unit, it may cause a fire.	
Check to see if the parts and wires are mounted and connected properly, and if the connections at the soldered or crimped terminals are secure. Improper installation and connections may cause excessive heat generation, fire or an electrical shock.	
If the installation platform or frame has corroded, replace it. Corroded installation platform or frame may cause the unit to fall, resulting in injury.	
Check the grounding, and repair it if the equipment is not properly grounded. Improper grounding may cause an electrical shock.	

 Caution	
Be sure to measure the insulation resistance after the repair, and make sure that the resistance is 1 MΩ or higher. Faulty insulation may cause an electrical shock.	
Be sure to check the drainage of the indoor unit after the repair. Faulty drainage may cause the water to enter the room and wet the furniture and floor.	
Do not tilt the unit when removing it. The water inside the unit may spill and wet the furniture and floor.	
Be sure to install the packing and seal on the installation frame properly. If the packing and seal are not installed properly, water may enter the room and wet the furniture and floor.	For unitary type only 

1.2 Used Icons

Icons are used to attract the attention of the reader to specific information. The meaning of each icon is described in the table below:

Icon	Type of Information	Description
 Note:	Note	A “note” provides information that is not indispensable, but may nevertheless be valuable to the reader, such as tips and tricks.
 Caution	Caution	A “caution” is used when there is danger that the reader, through incorrect manipulation, may damage equipment, lose data, get an unexpected result or has to restart (part of) a procedure.
 Warning	Warning	A “warning” is used when there is danger of personal injury.
	Reference	A “reference” guides the reader to other places in this binder or in this manual, where he/she will find additional information on a specific topic.

Part 1

List of Functions

1. Functions.....2

1. Functions

Category	Functions	FLKS25/35BAYMB RKS25/35E2V1B	FLXS25/35BAYMB RXS25/35E2V1B	Category	Functions	FLKS25/35BAYMB RKS25/35E2V1B	FLXS25/35BAYMB RXS25/35E2V1B	
Basic Function	Inverter (with Inverter Power Control)	○	○	Health & Clean	Air-Purifying Filter	○	○	
	Operation Limit for Cooling (°CDB)	-10 ~46 ★	-10 ~46		Photocatalytic Deodorizing Filter	○	○	
	Operation Limit for Heating (°CWB)	—	-15 ~20		Air-Purifying Filter with Photocatalytic Deodorizing Function	—	—	
	PAM Control	○	○		Titanium Apatite Photocatalytic Air-Purifying Filter	—	—	
	Standby Electricity Saving	—	—		Air Filter (Prefilter)	○	○	
Compressor	Oval Scroll Compressor	—	—	Wipe-Clean Flat Panel	—	—		
	Swing Compressor	○	○	Washable Grille	—	—		
	Rotary Compressor	—	—	MOLD PROOF Operation	—	—		
	Reluctance DC Motor	○	○	Good-Sleep Cooling Operation	—	—		
Comfortable Airflow	Power-Airflow Flap	—	—	Timer	WEEKLY TIMER Operation	—	—	
	Power-Airflow Dual Flaps	—	—		24-Hour ON/OFF TIMER	○	○	
	Power-Airflow Diffuser	—	—		NIGHT SET Mode	○	○	
	Wide-Angle Louvers	—	—	Worry Free "Reliability & Durability"	Auto-Restart (after Power Failure)	○	○	
	Vertical Auto-Swing (Up and Down)	○	○		Self-Diagnosis (Digital, LED) Display	○	○	
	Horizontal Auto-Swing (Right and Left)	—	—		Wiring Error Check Function	—	—	
	3-D Airflow	—	—		Anti-Corrosion Treatment of Outdoor Heat Exchanger	○	○	
Comfort Control	Auto Fan Speed	○	○	Flexibility	Multi-Split/Split Type Compatible Indoor Unit	○	○	
	Indoor Unit Quiet Operation	○	○		Flexible Voltage Correspondence	—	—	
	NIGHT QUIET Mode (Automatic)	—	—		Chargeless	10 m	10 m	
	OUTDOOR UNIT QUIET Operation (Manual)	○	○		Either Side Drain (Right or Left)	—	—	
	INTELLIGENT EYE Operation	—	—		Power Selection	—	—	
	Quick Warming Function (Preheating Operation)	—	○		Remote Control	5-Rooms Centralized Controller (Option)	○	○
	Hot-Start Function	—	○			Remote Control Adaptor (Normal Open Pulse Contact) (Option)	○	○
Operation	Automatic Defrosting	—	○	Remote Control Adaptor (Normal Open Contact) (Option)	Remote Control Adaptor (Normal Open Contact) (Option)	○	○	
	Automatic Operation	—	○		DIII-NET Compatible (Adaptor) (Option)	DIII-NET Compatible (Adaptor) (Option)	○	○
	Program Dry Operation	○	○			Remote Controller	Wireless	○
Lifestyle Convenience	Fan Only	○	○	Wired (Option)	—		—	
	New POWERFUL Operation (Non-Inverter)	—	—					
	Inverter POWERFUL Operation	○	○					
	Priority-Room Setting	—	—					
	COOL/HEAT Mode Lock	—	—					
	HOME LEAVE Operation	○	○					
	ECONO Operation	—	—					
	Indoor Unit ON/OFF Button	○	○					
	Signal Receiving Sign	○	○					
	R/C with Back Light	—	—					
Temperature Display	—	—						

Note: ○ : Holding Functions
— : No Functions

★ : Lower limit can be extended to -15°C by cutting jumper. (facility use only)

Category	Functions	FLKS25/35BAVMB RKS25/35G2V1B	FLXS25/35BAVMB RXS25/35G2V1B	Category	Functions	FLKS25/35BAVMB RKS25/35G2V1B	FLXS25/35BAVMB RXS25/35G2V1B
Basic Function	Inverter (with Inverter Power Control)	○	○	Health & Clean	Air-Purifying Filter	○	○
	Operation Limit for Cooling (°CDB)	-10 ~46 ★	-10 ~46		Photocatalytic Deodorizing Filter	○	○
	Operation Limit for Heating (°CWB)	—	-15 ~20		Air-Purifying Filter with Photocatalytic Deodorizing Function	—	—
	PAM Control	○	○		Titanium Apatite Photocatalytic Air-Purifying Filter	—	—
	Standby Electricity Saving	○	○		Air Filter (Prefilter)	○	○
Compressor	Oval Scroll Compressor	—	—	Wipe-Clean Flat Panel	—	—	
	Swing Compressor	○	○	Washable Grille	—	—	
	Rotary Compressor	—	—	MOLD PROOF Operation	—	—	
	Reluctance DC Motor	○	○	Good-Sleep Cooling Operation	—	—	
Comfortable Airflow	Power-Airflow Flap	—	—	Timer	WEEKLY TIMER Operation	—	—
	Power-Airflow Dual Flaps	—	—		24-Hour ON/OFF TIMER	○	○
	Power-Airflow Diffuser	—	—		NIGHT SET Mode	○	○
	Wide-Angle Louvers	—	—	Worry Free "Reliability & Durability"	Auto-Restart (after Power Failure)	○	○
	Vertical Auto-Swing (Up and Down)	○	○		Self-Diagnosis (Digital, LED) Display	○	○
	Horizontal Auto-Swing (Right and Left)	—	—		Wiring Error Check Function	—	—
	3-D Airflow	—	—		Anti-Corrosion Treatment of Outdoor Heat Exchanger	○	○
Comfort Control	Auto Fan Speed	○	○	Flexibility	Multi-Split/Split Type Compatible Indoor Unit	○	○
	Indoor Unit Quiet Operation	○	○		Flexible Voltage Correspondence	—	—
	NIGHT QUIET Mode (Automatic)	—	—		Chargeless	10 m	10 m
	OUTDOOR UNIT QUIET Operation (Manual)	○	○		Either Side Drain (Right or Left)	—	—
	INTELLIGENT EYE Operation	—	—		Power Selection	—	—
	Quick Warming Function (Preheating Operation)	—	○		5-Rooms Centralized Controller (Option)	○	○
	Hot-Start Function	—	○		Remote Control Adaptor (Normal Open Pulse Contact) (Option)	○	○
	Automatic Defrosting	—	○		Remote Control Adaptor (Normal Open Contact) (Option)	○	○
Operation	Automatic Operation	—	○	Remote Control	DIII-NET Compatible (Adaptor) (Option)	○	○
	Program Dry Operation	○	○		Wireless	○	○
	Fan Only	○	○		Wired (Option)	—	—
Lifestyle Convenience	New POWERFUL Operation (Non-Inverter)	—	—	Remote Controller			
	Inverter POWERFUL Operation	○	○				
	Priority-Room Setting	—	—				
	COOL/HEAT Mode Lock	—	—				
	HOME LEAVE Operation	○	○				
	ECONO Operation	—	—				
	Indoor Unit ON/OFF Button	○	○				
	Signal Receiving Sign	○	○				
	R/C with Back Light	—	—				
Temperature Display	—	—					

Note: ○ : Holding Functions
— : No Functions

★ : Lower limit can be extended to -15°C by cutting jumper. (facility use only)

Category	Functions	FLKS25/35BAVMB RKS25/35G2V1B9	FLXS25/35BAVMB RXS25/35G2V1B9	Category	Functions	FLKS25/35BAVMB RKS25/35G2V1B9	FLXS25/35BAVMB RXS25/35G2V1B9
Basic Function	Inverter (with Inverter Power Control)	○	○	Health & Clean	Air-Purifying Filter	○	○
	Operation Limit for Cooling (°CDB)	-10 ~46 ★	-10 ~46		Photocatalytic Deodorizing Filter	○	○
	Operation Limit for Heating (°CWB)	—	-15 ~20		Air-Purifying Filter with Photocatalytic Deodorizing Function	—	—
	PAM Control	○	○		Titanium Apatite Photocatalytic Air-Purifying Filter	—	—
	Standby Electricity Saving	○	○		Air Filter (Prefilter)	○	○
Compressor	Oval Scroll Compressor	—	—	Wipe-Clean Flat Panel	—	—	
	Swing Compressor	○	○	Washable Grille	—	—	
	Rotary Compressor	—	—	MOLD PROOF Operation	—	—	
	Reluctance DC Motor	○	○	Good-Sleep Cooling Operation	—	—	
Comfortable Airflow	Power-Airflow Flap	—	—	Timer	WEEKLY TIMER Operation	—	—
	Power-Airflow Dual Flaps	—	—		24-Hour ON/OFF TIMER	○	○
	Power-Airflow Diffuser	—	—		NIGHT SET Mode	○	○
	Wide-Angle Louvers	—	—	Worry Free "Reliability & Durability"	Auto-Restart (after Power Failure)	○	○
	Vertical Auto-Swing (Up and Down)	○	○		Self-Diagnosis (Digital, LED) Display	○	○
	Horizontal Auto-Swing (Right and Left)	—	—		Wiring Error Check Function	—	—
	3-D Airflow	—	—		Anti-Corrosion Treatment of Outdoor Heat Exchanger	○	○
Comfort Control	Auto Fan Speed	○	○	Flexibility	Multi-Split/Split Type Compatible Indoor Unit	○	○
	Indoor Unit Quiet Operation	○	○		Flexible Voltage Correspondence	—	—
	NIGHT QUIET Mode (Automatic)	—	—		Chargeless	10 m	10 m
	OUTDOOR UNIT QUIET Operation (Manual)	○	○		Either Side Drain (Right or Left)	—	—
	INTELLIGENT EYE Operation	—	—		Power Selection	—	—
	Quick Warming Function (Preheating Operation)	—	○		5-Rooms Centralized Controller (Option)	○	○
	Hot-Start Function	—	○		Remote Control Adaptor (Normal Open Pulse Contact) (Option)	○	○
	Automatic Defrosting	—	○		Remote Control Adaptor (Normal Open Contact) (Option)	○	○
Operation	Automatic Operation	—	○	Remote Control	DIII-NET Compatible (Adaptor) (Option)	○	○
	Program Dry Operation	○	○		Wireless	○	○
	Fan Only	○	○		Wired (Option)	—	—
Lifestyle Convenience	New POWERFUL Operation (Non-Inverter)	—	—	Remote Controller			
	Inverter POWERFUL Operation	○	○				
	Priority-Room Setting	—	—				
	COOL/HEAT Mode Lock	—	—				
	HOME LEAVE Operation	○	○				
	ECONO Operation	—	—				
	Indoor Unit ON/OFF Button	○	○				
	Signal Receiving Sign	○	○				
	R/C with Back Light	—	—				
Temperature Display	—	—					

Note: ○ : Holding Functions
— : No Functions

★ : Lower limit can be extended to -15°C by cutting jumper. (facility use only)

Part 2

Specifications

1. Specifications	6
1.1 Cooling Only	6
1.2 Heat Pump	9

1. Specifications

1.1 Cooling Only

50 Hz, 220 - 230 - 240 V

Model	Indoor Units		FLKS25BAVMB		FLKS35BAVMB	
	Outdoor Units		RKS25E2V1B		RKS35E2V1B	
Capacity Rated (Min. ~ Max.)	kW		2.5 (1.2 ~ 3.0)		3.5 (1.2 ~ 3.8)	
	Btu/h		8,500 (4,100 ~ 10,200)		11,900 (4,100 ~ 13,000)	
	kcal/h		2,150 (1,030 ~ 2,580)		3,010 (1,030 ~ 3,270)	
Moisture Removal	L/h		1.2		1.9	
Running Current (Rated)	A		3.7 - 3.6 - 3.4		5.3 - 5.1 - 4.9	
Power Consumption Rated (Min. ~ Max.)	W		650 (300 ~ 860)		1,130 (300 ~ 1,260)	
Power Factor	%		79.9 - 78.5 - 79.7		96.9 - 96.3 - 96.1	
COP Rated (Min. ~ Max.)	W/W		3.85 (4.00 ~ 3.49)		3.10 (4.00 ~ 3.02)	
Piping Connections	Liquid	mm	φ 6.4		φ 6.4	
	Gas	mm	φ 9.5		φ 9.5	
	Drain	mm	φ 18.0		φ 18.0	
Heat Insulation			Both Liquid and Gas Pipes		Both Liquid and Gas Pipes	
Max. Interunit Piping Length	m		20		20	
Max. Interunit Height Difference	m		15		15	
Chargeless	m		10		10	
Amount of Additional Charge of Refrigerant	g/m		20		20	
Indoor Unit			FLKS25BAVMB		FLKS35BAVMB	
Front Panel Color			Almond White		Almond White	
Airflow Rate	m³/min (cfm)	H	7.6 (268)		8.6 (304)	
		M	6.8 (240)		7.6 (268)	
		L	6.0 (212)		6.6 (233)	
		SL	5.2 (184)		5.6 (198)	
Fan	Type	Sirocco Fan		Sirocco Fan		
	Motor Output	W	34		34	
	Speed	Steps	5 Steps, Quiet, Auto		5 Steps, Quiet, Auto	
Air Direction Control			Right, Left, Horizontal, Downward		Right, Left, Horizontal, Downward	
Air Filter			Removable / Washable / Mildew Proof		Removable / Washable / Mildew Proof	
Running Current (Rated)	A		0.33 - 0.32 - 0.31		0.38 - 0.36 - 0.35	
Power Consumption (Rated)	W		70 - 70 - 70		78 - 78 - 78	
Power Factor	%		96.4 - 95.1 - 94.1		93.3 - 94.2 - 92.9	
Temperature Control			Microcomputer Control		Microcomputer Control	
Dimensions (H x W x D)	mm		490 x 1,050 x 200		490 x 1,050 x 200	
Packaged Dimensions (H x W x D)	mm		280 x 1,100 x 566		280 x 1,100 x 566	
Weight	kg		16		16	
Gross Weight	kg		22		22	
Operation Sound	H / M / L / SL	dBA	37 / 34 / 31 / 28		38 / 35 / 32 / 29	
Sound Power	dBA		53		54	
Outdoor Unit			RKS25E2V1B		RKS35E2V1B	
Casing Color			Ivory White		Ivory White	
Compressor	Type	Hermetically Sealed Swing Type		Hermetically Sealed Swing Type		
	Model	1YC23NXD		1YC23NXD		
	Motor Output	W	600		600	
Refrigerant Oil	Type	FVC50K		FVC50K		
	Charge	L	0.375		0.375	
Refrigerant	Type	R-410A		R-410A		
	Charge	kg	1.0		1.0	
Airflow Rate	m³/min (cfm)	H	33.5 (1,183)		33.5 (1,183)	
		L	23.4 (826)		23.4 (826)	
Fan	Type	Propeller		Propeller		
	Motor Output	W	23		23	
Running Current (Rated)	A		3.37 - 3.28 - 3.09		4.92 - 4.74 - 4.55	
Power Consumption (Rated)	W		580 - 580 - 580		1,052 - 1,052 - 1,052	
Power Factor	%		78.2 - 76.9 - 78.2		97.2 - 96.5 - 96.3	
Starting Current	A		3.7		5.3	
Dimensions (H x W x D)	mm		550 x 765 x 285		550 x 765 x 285	
Packaged Dimensions (H x W x D)	mm		617 x 882 x 363		617 x 882 x 363	
Weight	kg		32		32	
Gross Weight	kg		38		38	
Operation Sound	H / L	dBA	46 / 43		47 / 44	
Sound Power	H	dBA	61		62	
Drawing No.			3D055004A		3D055005A	

Note: ■ The data are based on the conditions shown in the table below.

Cooling	Piping Length
Indoor ; 27°CDB / 19°CWB Outdoor ; 35°CDB / 24°CWB	7.5 m

Conversion Formulae
kcal/h = kW × 860 Btu/h = kW × 3412 cfm = m³/min × 35.3

50 Hz, 220 - 230 - 240 V

Model	Indoor Units		FLKS25BAVMB		FLKS35BAVMB	
	Outdoor Units		RKS25G2V1B		RKS35G2V1B	
Capacity Rated (Min. ~ Max.)	kW		2.5 (1.2 ~ 3.0)		3.5 (1.2 ~ 3.8)	
	Btu/h		8,500 (4,100 ~ 10,200)		11,900 (4,100 ~ 13,000)	
	kcal/h		2,150 (1,030 ~ 2,580)		3,010 (1,030 ~ 3,270)	
Moisture Removal	L/h		1.2		1.9	
Running Current (Rated)	A		3.7 - 3.6 - 3.4		5.3 - 5.1 - 4.9	
Power Consumption Rated (Min. ~ Max.)	W		650 (300 ~ 860)		1,130 (300 ~ 1,260)	
Power Factor	%		79.9 - 78.5 - 79.7		96.9 - 96.3 - 96.1	
COP Rated (Min. ~ Max.)	W/W		3.85 (4.00 ~ 3.49)		3.10 (4.00 ~ 3.02)	
Piping Connections	Liquid	mm	φ 6.4		φ 6.4	
	Gas	mm	φ 9.5		φ 9.5	
	Drain	mm	φ 18.0		φ 18.0	
Heat Insulation			Both Liquid and Gas Pipes		Both Liquid and Gas Pipes	
Max. Interunit Piping Length	m		20		20	
Max. Interunit Height Difference	m		15		15	
Chargeless	m		10		10	
Amount of Additional Charge of Refrigerant	g/m		20		20	
Indoor Unit			FLKS25BAVMB		FLKS35BAVMB	
Front Panel Color			Almond White		Almond White	
Airflow Rate	m³/min (cfm)	H	7.6 (268)		8.6 (304)	
		M	6.8 (240)		7.6 (268)	
		L	6.0 (212)		6.6 (233)	
		SL	5.2 (184)		5.6 (198)	
Fan	Type	Sirocco Fan		Sirocco Fan		
	Motor Output	W	34		34	
	Speed	Steps	5 Steps, Quiet, Auto		5 Steps, Quiet, Auto	
Air Direction Control			Right, Left, Horizontal, Downward		Right, Left, Horizontal, Downward	
Air Filter			Removable / Washable / Mildew Proof		Removable / Washable / Mildew Proof	
Running Current (Rated)	A		0.33 - 0.32 - 0.31		0.38 - 0.36 - 0.35	
Power Consumption (Rated)	W		70 - 70 - 70		78 - 78 - 78	
Power Factor	%		96.4 - 95.1 - 94.1		93.3 - 94.2 - 92.9	
Temperature Control			Microcomputer Control		Microcomputer Control	
Dimensions (H x W x D)	mm		490 x 1,050 x 200		490 x 1,050 x 200	
Packaged Dimensions (H x W x D)	mm		280 x 1,100 x 566		280 x 1,100 x 566	
Weight	kg		16		16	
Gross Weight	kg		22		22	
Operation Sound	H / M / L / SL	dBA	37 / 34 / 31 / 28		38 / 35 / 32 / 29	
Sound Power	dBA		53		54	
Outdoor Unit			RKS25G2V1B		RKS35G2V1B	
Casing Color			Ivory White		Ivory White	
Compressor	Type	Hermetically Sealed Swing Type		Hermetically Sealed Swing Type		
	Model	1YC23AFXD		1YC23AFXD		
Refrigerant Oil	Type	FVC50K		FVC50K		
	Charge	L	0.375		0.375	
Refrigerant	Type	R-410A		R-410A		
	Charge	kg	1.0		1.2	
Airflow Rate	m³/min (cfm)	H	33.5 (1,183)		36.0 (1,272)	
		SL	31.4 (1,109)		31.4 (1,109)	
Fan	Type	Propeller		Propeller		
	Motor Output	W	50		50	
Running Current (Rated)	A		3.37 - 3.28 - 3.09		4.92 - 4.74 - 4.55	
Power Consumption (Rated)	W		580 - 580 - 580		1,052 - 1,052 - 1,052	
Power Factor	%		78.2 - 76.9 - 78.2		97.2 - 96.5 - 96.3	
Starting Current	A		3.2		4.4	
Dimensions (H x W x D)	mm		550 x 765 x 285		550 x 765 x 285	
Packaged Dimensions (H x W x D)	mm		612 x 906 x 364		612 x 906 x 364	
Weight	kg		34		34	
Gross Weight	kg		40		40	
Operation Sound	H / SL	dBA	46 / 43		48 / 44	
Sound Power	H	dBA	61		63	
Drawing No.			3D059861		3D059862	

Note: ■ The data are based on the conditions shown in the table below.

Cooling	Piping Length
Indoor ; 27°CDB / 19°CWB Outdoor ; 35°CDB / 24°CWB	5 m

Conversion Formulae
kcal/h = kW × 860 Btu/h = kW × 3412 cfm = m³/min × 35.3

50 Hz, 220 - 230 - 240 V

Model	Indoor Units		FLKS25BAVMB		FLKS35BAVMB	
	Outdoor Units		RKS25G2V1B9		RKS35G2V1B9	
Capacity Rated (Min. ~ Max.)	kW		2.5 (1.2 ~ 3.0)		3.5 (1.2 ~ 3.8)	
	Btu/h		8,500 (4,100 ~ 10,200)		11,900 (4,100 ~ 13,000)	
	kcal/h		2,150 (1,030 ~ 2,580)		3,010 (1,030 ~ 3,270)	
Moisture Removal	L/h		1.2		1.9	
Running Current (Rated)	A		3.7 - 3.6 - 3.4		5.3 - 5.1 - 4.9	
Power Consumption Rated (Min. ~ Max.)	W		650 (300 ~ 860)		1,130 (300 ~ 1,260)	
Power Factor	%		79.9 - 78.5 - 79.7		96.9 - 96.3 - 96.1	
COP Rated (Min. ~ Max.)	W/W		3.85 (4.00 ~ 3.49)		3.10 (4.00 ~ 3.02)	
Piping Connections	Liquid	mm	φ 6.4		φ 6.4	
	Gas	mm	φ 9.5		φ 9.5	
	Drain	mm	φ 18.0		φ 18.0	
Heat Insulation			Both Liquid and Gas Pipes		Both Liquid and Gas Pipes	
Max. Interunit Piping Length	m		20		20	
Max. Interunit Height Difference	m		15		15	
Chargeless	m		10		10	
Amount of Additional Charge of Refrigerant	g/m		20		20	
Indoor Unit			FLKS25BAVMB		FLKS35BAVMB	
Front Panel Color			Almond White		Almond White	
Airflow Rate	m³/min (cfm)	H	7.6 (268)		8.6 (304)	
		M	6.8 (240)		7.6 (268)	
		L	6.0 (212)		6.6 (233)	
		SL	5.2 (184)		5.6 (198)	
Fan	Type		Sirocco Fan		Sirocco Fan	
	Motor Output	W	34		34	
	Speed	Steps	5 Steps, Quiet, Auto		5 Steps, Quiet, Auto	
Air Direction Control			Right, Left, Horizontal, Downward		Right, Left, Horizontal, Downward	
Air Filter			Removable / Washable / Mildew Proof		Removable / Washable / Mildew Proof	
Running Current (Rated)	A		0.33 - 0.32 - 0.31		0.38 - 0.36 - 0.35	
Power Consumption (Rated)	W		70 - 70 - 70		78 - 78 - 78	
Power Factor	%		96.4 - 95.1 - 94.1		93.3 - 94.2 - 92.9	
Temperature Control			Microcomputer Control		Microcomputer Control	
Dimensions (H x W x D)	mm		490 x 1,050 x 200		490 x 1,050 x 200	
Packaged Dimensions (H x W x D)	mm		280 x 1,100 x 566		280 x 1,100 x 566	
Weight	kg		16		16	
Gross Weight	kg		22		22	
Operation Sound	H / M / L / SL	dBA	37 / 34 / 31 / 28		38 / 35 / 32 / 29	
Sound Power	dBA		53		54	
Outdoor Unit			RKS25G2V1B9		RKS35G2V1B9	
Casing Color			Ivory White		Ivory White	
Compressor	Type		Hermetically Sealed Swing Type		Hermetically Sealed Swing Type	
	Model		1YC23AEXD		1YC23AEXD	
Refrigerant Oil	Type		FVC50K		FVC50K	
	Charge	L	0.375		0.375	
Refrigerant	Type		R-410A		R-410A	
	Charge	kg	1.0		1.2	
Airflow Rate	m³/min (cfm)	H	33.5 (1,183)		36.2 (1,278)	
		SL	32.7 (1,153)		32.7 (1,153)	
Fan	Type		Propeller		Propeller	
	Motor Output	W	23		23	
Running Current (Rated)	A		3.37 - 3.28 - 3.09		4.92 - 4.74 - 4.55	
Power Consumption (Rated)	W		580 - 580 - 580		1,052 - 1,052 - 1,052	
Power Factor	%		78.2 - 76.9 - 78.2		97.2 - 96.5 - 96.3	
Starting Current	A		3.2		4.4	
Dimensions (H x W x D)	mm		550 x 765 x 285		550 x 765 x 285	
Packaged Dimensions (H x W x D)	mm		612 x 906 x 364		612 x 906 x 364	
Weight	kg		34		34	
Gross Weight	kg		38		38	
Operation Sound	H / SL	dBA	46 / 43		48 / 44	
Sound Power	H	dBA	61		63	
Drawing No.			3D065726		3D065725	

Note: ■ The data are based on the conditions shown in the table below.

Cooling	Piping Length
Indoor ; 27°CDB / 19°CWB Outdoor ; 35°CDB / 24°CWB	5 m

Conversion Formulae
kcal/h = kW × 860 Btu/h = kW × 3412 cfm = m³/min × 35.3

1.2 Heat Pump

50 Hz, 220 - 230 - 240 V

Model	Indoor Units		FLXS25BAVMB		FLXS35BAVMB	
	Outdoor Units		RXS25E2V1B		RXS35E2V1B	
			Cooling	Heating	Cooling	Heating
Capacity Rated (Min. ~ Max.)	kW		2.5 (1.2 ~ 3.0)	3.4 (1.2 ~ 4.5)	3.5 (1.2 ~ 3.8)	4.0 (1.2 ~ 5.0)
	Btu/h		8,500 (4,100 ~ 10,200)	11,600 (4,100 ~ 15,400)	11,900 (4,100 ~ 13,000)	13,600 (4,100 ~ 17,100)
	kcal/h		2,150 (1,030 ~ 2,580)	2,920 (1,030 ~ 3,870)	3,010 (1,030 ~ 3,270)	3,440 (1,030 ~ 4,300)
Moisture Removal	L/h		1.2	—	1.9	—
Running Current (Rated)	A		3.7 - 3.6 - 3.4	4.7 - 4.5 - 4.3	5.3 - 5.1 - 4.9	5.8 - 5.5 - 5.3
Power Consumption Rated (Min. ~ Max.)	W		650 (300 ~ 860)	980 (290 ~ 1,490)	1,130 (300 ~ 1,260)	1,230 (290 ~ 1,850)
Power Factor	%		79.9 - 78.5 - 79.7	94.8 - 94.7 - 95.0	96.9 - 96.3 - 96.1	96.4 - 97.2 - 96.7
COP Rated (Min. ~ Max.)	W/W		3.85 (4.00 ~ 3.49)	3.47 (4.14 ~ 3.02)	3.10 (4.00 ~ 3.02)	3.25 (4.14 ~ 2.70)
Piping Connections	Liquid	mm	φ 6.4		φ 6.4	
	Gas	mm	φ 9.5		φ 9.5	
	Drain	mm	φ 18.0		φ 18.0	
Heat Insulation		Both Liquid and Gas Pipes		Both Liquid and Gas Pipes		
Max. Interunit Piping Length	m		20		20	
Max. Interunit Height Difference	m		15		15	
Chargeless	m		10		10	
Amount of Additional Charge of Refrigerant	g/m		20		20	
Indoor Unit			FLXS25BAVMB		FLXS35BAVMB	
Front Panel Color			Almond White		Almond White	
Airflow Rate	m ³ /min (cfm)	H	7.6 (268)	9.2 (325)	8.6 (304)	9.8 (346)
		M	6.8 (240)	8.3 (293)	7.6 (268)	8.9 (314)
		L	6.0 (212)	7.4 (261)	6.6 (233)	8.0 (282)
		SL	5.2 (184)	6.6 (233)	5.6 (198)	7.2 (254)
Fan	Type		Sirocco Fan		Sirocco Fan	
	Motor Output	W	34		34	
	Speed	Steps	5 Steps, Quiet, Auto		5 Steps, Quiet, Auto	
Air Direction Control		Right, Left, Horizontal, Downward		Right, Left, Horizontal, Downward		
Air Filter		Removable / Washable / Mildew Proof		Removable / Washable / Mildew Proof		
Running Current (Rated)	A		0.33 - 0.32 - 0.31	0.36 - 0.34 - 0.33	0.38 - 0.36 - 0.35	0.38 - 0.36 - 0.35
Power Consumption (Rated)	W		70 - 70 - 70	74 - 74 - 74	78 - 78 - 78	78 - 78 - 78
Power Factor	%		96.4 - 95.1 - 94.1	93.4 - 94.6 - 93.4	93.3 - 94.2 - 92.9	93.3 - 94.2 - 92.9
Temperature Control			Microcomputer Control		Microcomputer Control	
Dimensions (H x W x D)	mm		490 x 1,050 x 200		490 x 1,050 x 200	
Packaged Dimensions (H x W x D)	mm		280 x 1,100 x 566		280 x 1,100 x 566	
Weight	kg		16		16	
Gross Weight	kg		22		22	
Operation Sound	H / M / L / SL	dBA	37 / 34 / 31 / 28	37 / 34 / 31 / 29	38 / 35 / 32 / 29	39 / 36 / 33 / 30
Sound Power		dBA	53	53	54	55
Outdoor Unit			RXS25E2V1B		RXS35E2V1B	
Casing Color			Ivory White		Ivory White	
Compressor	Type		Hermetically Sealed Swing Type		Hermetically Sealed Swing Type	
	Model		1YC23NXD		1YC23NXD	
	Motor Output	W	600		600	
Refrigerant Oil	Model		FVC50K		FVC50K	
	Charge	L	0.375		0.375	
Refrigerant	Model		R-410A		R-410A	
	Charge	kg	1.0		1.0	
Airflow Rate	m ³ /min (cfm)	H	33.5 (1,183)	30.2 (1,066)	33.5 (1,183)	30.2 (1,066)
		L	23.4 (826)	28.3 (999)	23.4 (826)	28.3 (999)
Fan	Type		Propeller		Propeller	
	Motor Output	W	23		23	
Running Current (Rated)	A		3.37 - 3.28 - 3.09	4.34 - 4.16 - 3.97	4.92 - 4.74 - 4.55	5.42 - 5.14 - 4.95
Power Consumption (Rated)	W		580 - 580 - 580	906 - 906 - 906	1,052 - 1,052 - 1,052	1,152 - 1,152 - 1,152
Power Factor	%		78.2 - 76.9 - 78.2	94.9 - 94.7 - 95.1	97.2 - 96.5 - 96.3	96.6 - 97.4 - 97.0
Starting Current	A		4.7		5.8	
Dimensions (H x W x D)	mm		550 x 765 x 285		550 x 765 x 285	
Packaged Dimensions (H x W x D)	mm		617 x 882 x 363		617 x 882 x 363	
Weight	kg		32		32	
Gross Weight	kg		38		38	
Operation Sound	H / L	dBA	46 / 43	47 / 44	47 / 44	48 / 45
Sound Power	H	dBA	61	62	62	63
Drawing No.			3D055002A		3D055003A	

Note: ■ The data are based on the conditions shown in the table below.

Cooling	Heating	Piping Length
Indoor ; 27°CDB / 19°CWB Outdoor ; 35°CDB / 24°CWB	Indoor ; 20°CDB Outdoor ; 7°CDB / 6°CWB	7.5 m

Conversion Formulae
kcal/h = kW × 860 Btu/h = kW × 3412 cfm = m ³ /min × 35.3

50 Hz, 220 - 230 - 240 V

Model	Indoor Units		FLXS25BAVMB		FLXS35BAVMB	
	Outdoor Units		RXS25G2V1B		RXS35G2V1B	
			Cooling	Heating	Cooling	Heating
Capacity Rated (Min. ~ Max.)	kW		2.5 (1.2 ~ 3.0)	3.4 (1.2 ~ 4.5)	3.5 (1.2 ~ 3.8)	4.0 (1.2 ~ 5.0)
	Btu/h		8,500 (4,100 ~ 10,200)	11,600 (4,100 ~ 15,400)	11,900 (4,100 ~ 13,000)	13,600 (4,100 ~ 17,100)
	kcal/h		2,150 (1,030 ~ 2,580)	2,920 (1,030 ~ 3,870)	3,010 (1,030 ~ 3,270)	3,440 (1,030 ~ 4,300)
Moisture Removal	L/h		1.2	—	1.9	—
Running Current (Rated)	A		3.7 - 3.6 - 3.4	4.7 - 4.5 - 4.3	5.3 - 5.1 - 4.9	5.8 - 5.5 - 5.3
Power Consumption Rated (Min. ~ Max.)	W		650 (300 ~ 860)	980 (290 ~ 1,490)	1,130 (300 ~ 1,260)	1,230 (290 ~ 1,850)
Power Factor	%		79.9 - 78.5 - 79.7	94.8 - 94.7 - 95.0	96.9 - 96.3 - 96.1	96.4 - 97.2 - 96.7
COP Rated (Min. ~ Max.)	W/W		3.85 (4.00 ~ 3.49)	3.47 (4.14 ~ 3.02)	3.10 (4.00 ~ 3.02)	3.25 (4.14 ~ 2.70)
Piping Connections	Liquid	mm	φ 6.4		φ 6.4	
	Gas	mm	φ 9.5		φ 9.5	
	Drain	mm	φ 18.0		φ 18.0	
Heat Insulation			Both Liquid and Gas Pipes		Both Liquid and Gas Pipes	
Max. Interunit Piping Length	m		20		20	
Max. Interunit Height Difference	m		15		15	
Chargeless	m		10		10	
Amount of Additional Charge of Refrigerant	g/m		20		20	
Indoor Unit			FLXS25BAVMB		FLXS35BAVMB	
Front Panel Color			Almond White		Almond White	
Airflow Rate	m ³ /min (cfm)	H	7.6 (268)	9.2 (325)	8.6 (304)	9.8 (346)
		M	6.8 (240)	8.3 (293)	7.6 (268)	8.9 (314)
		L	6.0 (212)	7.4 (261)	6.6 (233)	8.0 (282)
		SL	5.2 (184)	6.6 (233)	5.6 (198)	7.2 (254)
Fan	Type		Sirocco Fan		Sirocco Fan	
	Motor Output	W	34		34	
	Speed	Steps	5 Steps, Quiet, Auto		5 Steps, Quiet, Auto	
Air Direction Control			Right, Left, Horizontal, Downward		Right, Left, Horizontal, Downward	
Air Filter			Removable / Washable / Mildew Proof		Removable / Washable / Mildew Proof	
Running Current (Rated)	A		0.33 - 0.32 - 0.31	0.36 - 0.34 - 0.33	0.38 - 0.36 - 0.35	0.38 - 0.36 - 0.35
Power Consumption (Rated)	W		70 - 70 - 70	74 - 74 - 74	78 - 78 - 78	78 - 78 - 78
Power Factor	%		96.4 - 95.1 - 94.1	93.4 - 94.6 - 93.4	93.3 - 94.2 - 92.9	93.3 - 94.2 - 92.9
Temperature Control			Microcomputer Control		Microcomputer Control	
Dimensions (H x W x D)	mm		490 x 1,050 x 200		490 x 1,050 x 200	
Packaged Dimensions (H x W x D)	mm		280 x 1,100 x 566		280 x 1,100 x 566	
Weight	kg		16		16	
Gross Weight	kg		22		22	
Operation Sound	H / M / L / SL	dBA	37 / 34 / 31 / 28	37 / 34 / 31 / 29	38 / 35 / 32 / 29	39 / 36 / 33 / 30
Sound Power		dBA	53	53	54	55
Outdoor Unit			RXS25G2V1B		RXS35G2V1B	
Casing Color			Ivory White		Ivory White	
Compressor	Type		Hermetically Sealed Swing Type		Hermetically Sealed Swing Type	
	Model		1YC23AFXD		1YC23AFXD	
Refrigerant Oil	Motor Output	W	600		600	
	Model		FVC50K		FVC50K	
Refrigerant	Charge	L	0.375		0.375	
	Model		R-410A		R-410A	
Refrigerant	Charge	kg	1.0		1.2	
	Model		R-410A		R-410A	
Airflow Rate	m ³ /min (cfm)	H	33.5 (1,183)	30.2 (1,066)	36.0 (1,272)	30.2 (1,066)
		SL	31.4 (1,109)	22.6 (798)	31.4 (1,109)	22.6 (798)
Fan	Type		Propeller		Propeller	
	Motor Output	W	50		50	
Running Current (Rated)	A		3.37 - 3.28 - 3.09	4.34 - 4.16 - 3.97	4.92 - 4.74 - 4.55	5.42 - 5.14 - 4.95
Power Consumption (Rated)	W		580 - 580 - 580	906 - 906 - 906	1,052 - 1,052 - 1,052	1,152 - 1,152 - 1,152
Power Factor	%		78.2 - 76.9 - 78.2	94.9 - 94.7 - 95.1	97.2 - 96.5 - 96.3	96.6 - 97.4 - 97.0
Starting Current	A		4.3		4.8	
Dimensions (H x W x D)	mm		550 x 765 x 285		550 x 765 x 285	
Packaged Dimensions (H x W x D)	mm		612 x 906 x 364		612 x 906 x 364	
Weight	kg		34		34	
Gross Weight	kg		40		40	
Operation Sound	H / SL	dBA	46 / 43	47 / 44	48 / 44	48 / 45
Sound Power	H	dBA	61	62	63	63
Drawing No.			3D059828		3D059829	

Note: ■ The data are based on the conditions shown in the table below.

Cooling	Heating	Piping Length
Indoor ; 27°CDB / 19°CWB Outdoor ; 35°CDB / 24°CWB	Indoor ; 20°CDB Outdoor ; 7°CDB / 6°CWB	5 m

Conversion Formulae
kcal/h = kW × 860 Btu/h = kW × 3412 cfm = m ³ /min × 35.3

50 Hz, 220 - 230 - 240 V

Model	Indoor Units		FLXS25BAVMB		FLXS35BAVMB	
	Outdoor Units		RXS25G2V1B9		RXS35G2V1B9	
			Cooling	Heating	Cooling	Heating
Capacity Rated (Min. ~ Max.)	kW		2.5 (1.2 ~ 3.0)	3.4 (1.2 ~ 4.5)	3.5 (1.2 ~ 3.8)	4.0 (1.2 ~ 5.0)
	Btu/h		8,500 (4,100 ~ 10,200)	11,600 (4,100 ~ 15,400)	11,900 (4,100 ~ 13,000)	13,600 (4,100 ~ 17,100)
	kcal/h		2,150 (1,030 ~ 2,580)	2,920 (1,030 ~ 3,870)	3,010 (1,030 ~ 3,270)	3,440 (1,030 ~ 4,300)
Moisture Removal	L/h		1.2	—	1.9	—
Running Current (Rated)	A		3.7 - 3.6 - 3.4	4.7 - 4.5 - 4.3	5.3 - 5.1 - 4.9	5.8 - 5.5 - 5.3
Power Consumption Rated (Min. ~ Max.)	W		650 (300 ~ 860)	980 (290 ~ 1,490)	1,130 (300 ~ 1,260)	1,230 (290 ~ 1,850)
Power Factor	%		79.9 - 78.5 - 79.7	94.8 - 94.7 - 95.0	96.9 - 96.3 - 96.1	96.4 - 97.2 - 96.7
COP Rated (Min. ~ Max.)	W/W		3.85 (4.00 ~ 3.49)	3.47 (4.14 ~ 3.02)	3.10 (4.00 ~ 3.02)	3.25 (4.14 ~ 2.70)
Piping Connections	Liquid	mm	φ 6.4		φ 6.4	
	Gas	mm	φ 9.5		φ 9.5	
	Drain	mm	φ 18.0		φ 18.0	
Heat Insulation			Both Liquid and Gas Pipes		Both Liquid and Gas Pipes	
Max. Interunit Piping Length	m		20		20	
Max. Interunit Height Difference	m		15		15	
Chargeless	m		10		10	
Amount of Additional Charge of Refrigerant	g/m		20		20	
Indoor Unit			FLXS25BAVMB		FLXS35BAVMB	
Front Panel Color			Almond White		Almond White	
Airflow Rate	m³/min (cfm)	H	7.6 (268)	9.2 (325)	8.6 (304)	9.8 (346)
		M	6.8 (240)	8.3 (293)	7.6 (268)	8.9 (314)
		L	6.0 (212)	7.4 (261)	6.6 (233)	8.0 (282)
		SL	5.2 (184)	6.6 (233)	5.6 (198)	7.2 (254)
Fan	Type		Sirocco Fan		Sirocco Fan	
	Motor Output	W	34		34	
	Speed	Steps	5 Steps, Quiet, Auto		5 Steps, Quiet, Auto	
Air Direction Control			Right, Left, Horizontal, Downward		Right, Left, Horizontal, Downward	
Air Filter			Removable / Washable / Mildew Proof		Removable / Washable / Mildew Proof	
Running Current (Rated)	A		0.33 - 0.32 - 0.31	0.36 - 0.34 - 0.33	0.38 - 0.36 - 0.35	0.38 - 0.36 - 0.35
Power Consumption (Rated)	W		70 - 70 - 70	74 - 74 - 74	78 - 78 - 78	78 - 78 - 78
Power Factor	%		96.4 - 95.1 - 94.1	93.4 - 94.6 - 93.4	93.3 - 94.2 - 92.9	93.3 - 94.2 - 92.9
Temperature Control			Microcomputer Control		Microcomputer Control	
Dimensions (H x W x D)	mm		490 x 1,050 x 200		490 x 1,050 x 200	
Packaged Dimensions (H x W x D)	mm		280 x 1,100 x 566		280 x 1,100 x 566	
Weight	kg		16		16	
Gross Weight	kg		22		22	
Operation Sound	H / M / L / SL	dBA	37 / 34 / 31 / 28	37 / 34 / 31 / 29	38 / 35 / 32 / 29	39 / 36 / 33 / 30
Sound Power		dBA	53	53	54	55
Outdoor Unit			RXS25G2V1B9		RXS35G2V1B9	
Casing Color			Ivory White		Ivory White	
Compressor	Type		Hermetically Sealed Swing Type		Hermetically Sealed Swing Type	
	Model		1YC23AEXD		1YC23AEXD	
Refrigerant Oil	Motor Output	W	600		600	
	Model		FVC50K		FVC50K	
Refrigerant	Charge	L	0.375		0.375	
	Model		R-410A		R-410A	
Refrigerant	Charge	kg	1.0		1.2	
	Model		R-410A		R-410A	
Airflow Rate	m³/min (cfm)	H	33.5 (1,183)	28.3 (999)	36.0 (1,272)	28.3 (999)
		SL	30.1 (1,064)	25.6 (905)	30.1 (1,064)	25.6 (905)
Fan	Type		Propeller		Propeller	
	Motor Output	W	23		23	
Running Current (Rated)	A		3.37 - 3.28 - 3.09	4.34 - 4.16 - 3.97	4.92 - 4.74 - 4.55	5.42 - 5.14 - 4.95
Power Consumption (Rated)	W		580 - 580 - 580	906 - 906 - 906	1,052 - 1,052 - 1,052	1,152 - 1,152 - 1,152
Power Factor	%		78.2 - 76.9 - 78.2	94.9 - 94.7 - 95.1	97.2 - 96.5 - 96.3	96.6 - 97.4 - 97.0
Starting Current	A		4.3		4.8	
Dimensions (H x W x D)	mm		550 x 765 x 285		550 x 765 x 285	
Packaged Dimensions (H x W x D)	mm		612 x 906 x 364		612 x 906 x 364	
Weight	kg		34		34	
Gross Weight	kg		38		38	
Operation Sound	H / SL	dBA	46 / 43	47 / 44	48 / 44	48 / 45
Sound Power	H	dBA	61	62	63	63
Drawing No.			3D065720		3D065721	

Note: ■ The data are based on the conditions shown in the table below.

Cooling	Heating	Piping Length
Indoor ; 27°CDB / 19°CWB Outdoor ; 35°CDB / 24°CWB	Indoor ; 20°CDB Outdoor ; 7°CDB / 6°CWB	5 m

Conversion Formulae
kcal/h = kW × 860 Btu/h = kW × 3412 cfm = m³/min × 35.3

Part 3

Printed Circuit Board

Connector Wiring Diagram

1. Printed Circuit Board Connector Wiring Diagram.....	13
1.1 Indoor Unit.....	13
1.2 Outdoor Unit.....	15

1. Printed Circuit Board Connector Wiring Diagram

1.1 Indoor Unit

Connectors and Other Parts

PCB (1): Control PCB

- | | |
|-----------|--|
| 1) S6 | Connector for swing motor (horizontal swing) |
| 2) S7 | Connector for AC fan motor |
| 3) S21 | Connector for centralized control (HA) |
| 4) S24 | Connector for display PCB |
| 5) S26 | Connector for signal receiver PCB |
| 6) S32 | Connector for indoor heat exchanger thermistor |
| 7) S37 | Connector for power supply PCB |
| 8) JA | Address setting jumper
* Refer to page 209 for detail. |
| JB | Fan speed setting when compressor stops for thermostat OFF |
| JC | Power failure recovery function
* Refer to page 212 for detail. |
| 9) SW2 | Select switch for installation (ceiling or floor)
* Refer to page 212 for detail. |
| 10) LED A | LED for service monitor (green) |

PCB (2): Power Supply PCB

- | | |
|---------------|------------------------------|
| 1) S36 | Connector for control PCB |
| 2) H1, H2, H3 | Connector for terminal board |
| 3) H4, H5, H6 | Connector for AC fan motor |
| 4) V1 | Varistor |
| 5) FU1 | Fuse (3.15A, 250V) |

PCB (3): Display PCB

- | | |
|---------------|------------------------------------|
| 1) S25 | Connector for control PCB |
| 2) LED1 (H1P) | LED for operation (green) |
| 3) LED2 (H2P) | LED for timer (yellow) |
| 4) LED3 (H3P) | LED for HOME LEAVE operation (red) |

PCB (4): Signal Receiver PCB

- | | |
|--------------|---|
| 1) S27 | Connector for control PCB |
| 2) S31 (RTH) | Connector for room temperature thermistor |
| 3) SW1 (S1W) | Forced operation ON/OFF button |

PCB Detail

PCB (1) : Control PCB

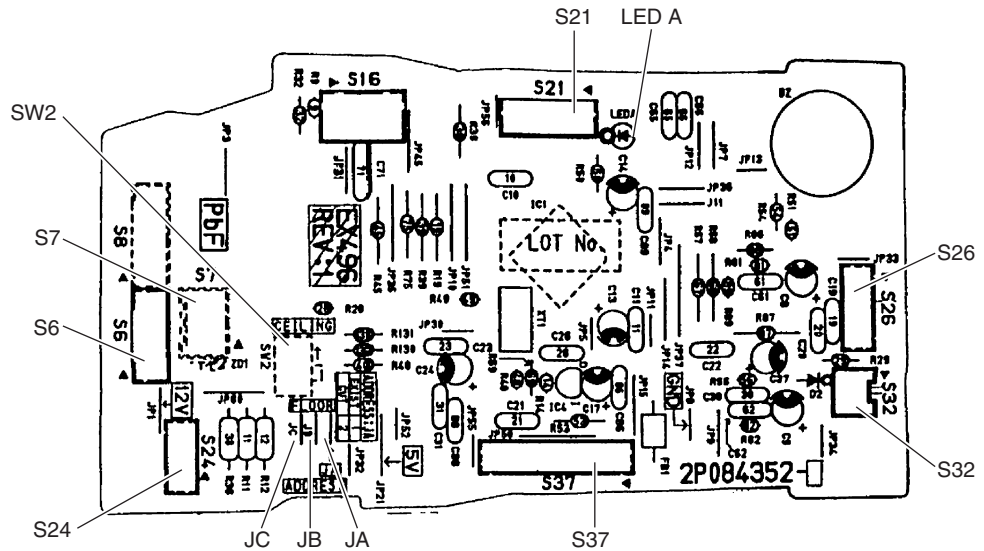

2P084352-3

PCB (2) : Power Supply PCB

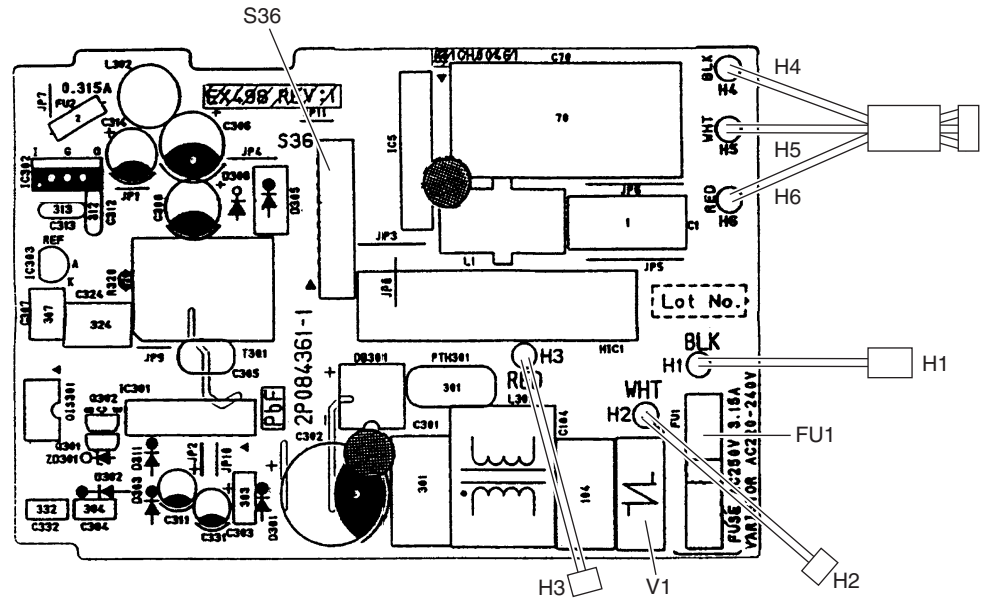

2P084361-1

PCB (3) : Display PCB

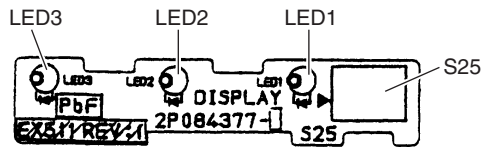

2P084377-5

PCB (4) : Signal Receiver PCB

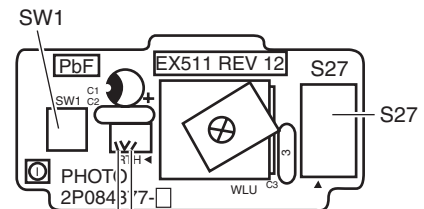

S31 (RTH)

2P084377-5

1.2 Outdoor Unit

1.2.1 RK(X)S25/35E2V1B

Connectors and Other Parts

PCB (1): Filter PCB

- | | |
|-------------------------|------------------------------|
| 1) S11 | Connector for main PCB |
| 2) HL1, HN1, S | Connector for terminal board |
| 3) E | Terminal for earth |
| 4) HC1, HC2
HL2, HN2 | Connector for main PCB |
| 5) HR1 | Connector for reactor |
| 6) FU3 | Fuse (20 A, 250 V) |
| 7) V2, V3 | Varistor |

PCB (2): Main PCB

- | | |
|-------------------------|--|
| 1) S10 | Connector for filter PCB |
| 2) S20 | Connector for electronic expansion valve coil |
| 3) S30 | Connector for compressor |
| 4) S40 | Connector for overload protector |
| 5) S70 | Connector for fan motor |
| 6) S80 | Connector for four way valve coil |
| 7) S90 | Connector for thermistors
(outdoor temperature, outdoor heat exchanger, discharge pipe) |
| 8) HC3, HC4
HL3, HN3 | Connector for filter PCB |
| 9) HR2 | Connector for reactor |
| 10)FU1, FU2 | Fuse (3.15 A, 250 V) |
| 11)LED A | LED for service monitor (green) |
| 12)V1 | Varistor |
| 13)J5 | Jumper for improvement of defrost performance
* Refer to page 212 for detail. |
| 14)J8 | Jumper for facility setting
* Refer to page 211 for detail. |

PCB Detail

PCB (1): Filter PCB

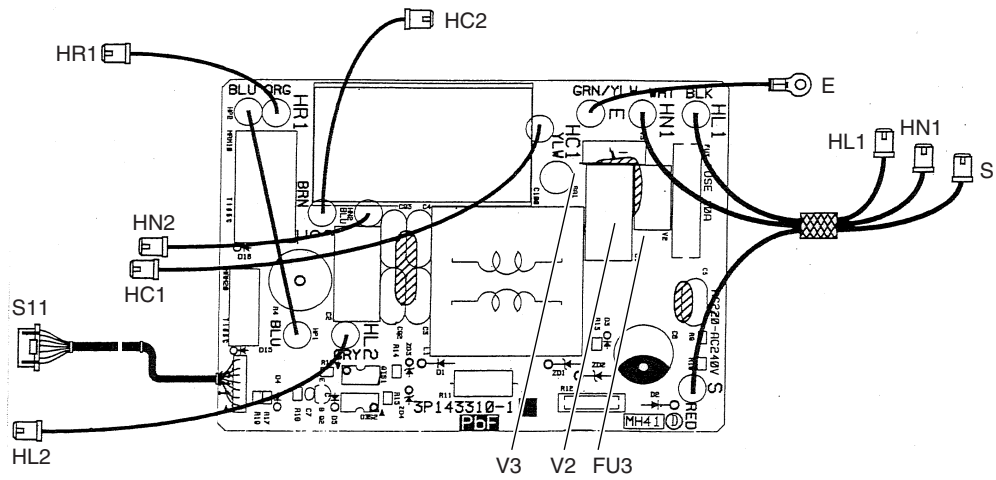

3P143310-1

PCB (2): Main PCB

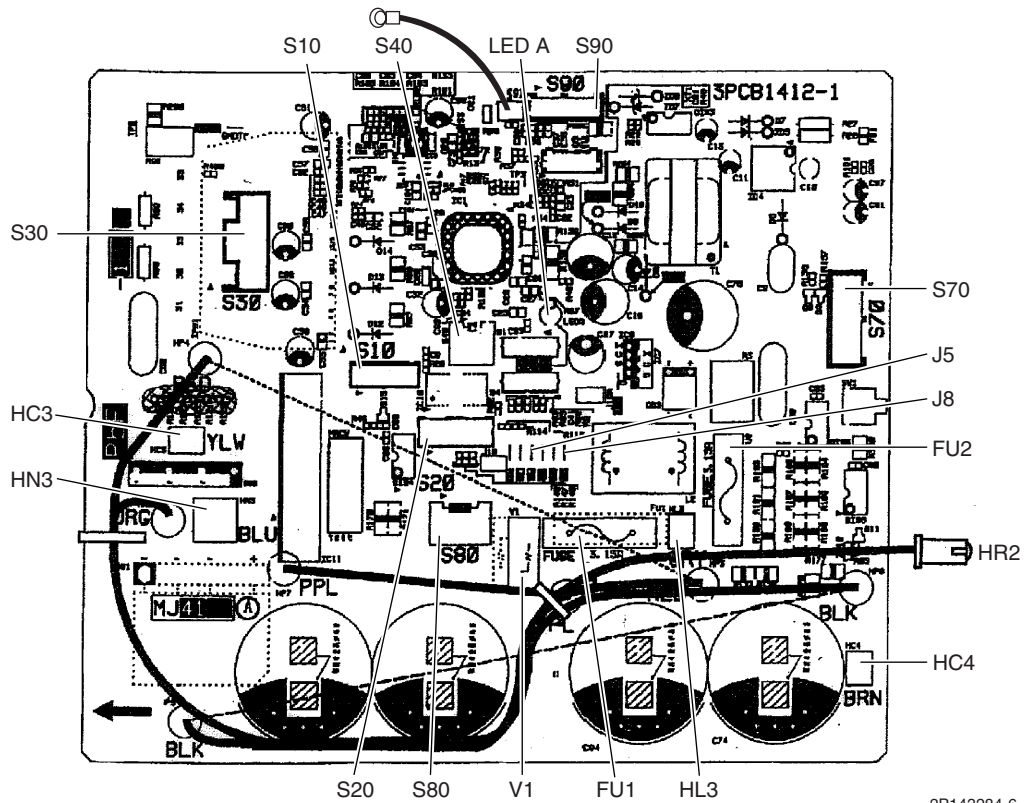

2P143284-6

1.2.2 RK(X)S25/35G2V1B

Connectors and Other Parts

PCB (1): Filter PCB

- | | |
|----------------|--------------------------------------|
| 1) S11 | Connector for main PCB |
| 2) HL1, HN1, S | Connector for terminal board |
| 3) E1 | Terminal for earth |
| 4) E2 | Connector for terminal board (earth) |
| 5) HL2, HN2 | Connector for main PCB |
| 6) HR1 | Connector for reactor |
| 7) FU3 | Fuse (20 A, 250 V) |
| 8) V2, V3 | Varistor |

PCB (2): Main PCB

- | | |
|-------------|--|
| 1) S10 | Connector for filter PCB |
| 2) S20 | Connector for electronic expansion valve coil |
| 3) S30 | Connector for compressor |
| 4) S40 | Connector for overload protector |
| 5) S50 | Connector for magnetic relay |
| 6) S70 | Connector for fan motor |
| 7) S80 | Connector for four way valve coil |
| 8) S90 | Connector for thermistors
(outdoor temperature, outdoor heat exchanger, discharge pipe) |
| 9) HL3, HN3 | Connector for filter PCB |
| 10)HR2 | Connector for reactor |
| 11)FU1, FU2 | Fuse (3.15 A, 250 V) |
| 12)LED A | LED for service monitor (green) |
| 13)V1 | Varistor |
| 14)J5 | Jumper for improvement of defrost performance
* Refer to page 212 for detail. |
| 15)J8 | Jumper for facility setting
* Refer to page 211 for detail. |

PCB Detail

PCB (1): Filter PCB

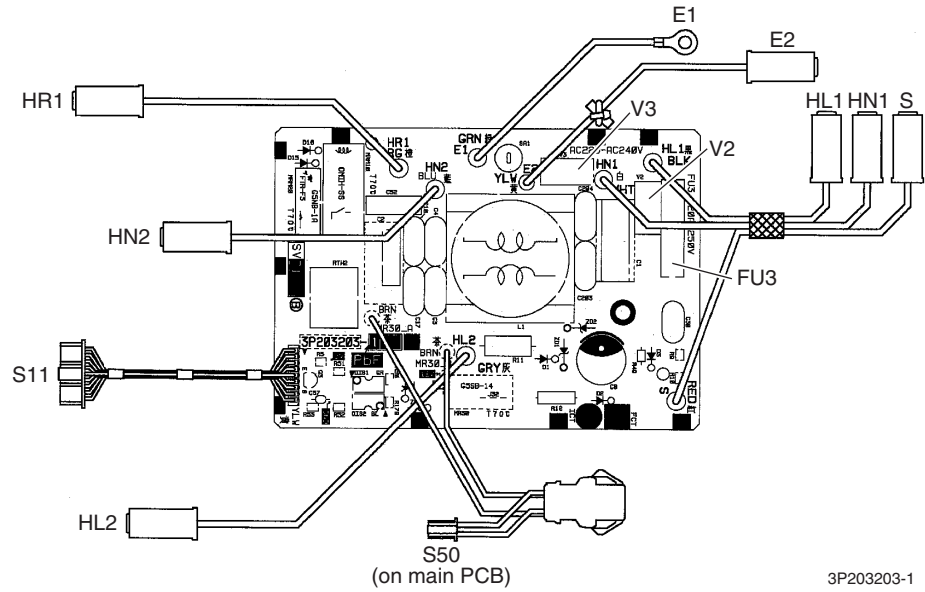

PCB (2): Main PCB

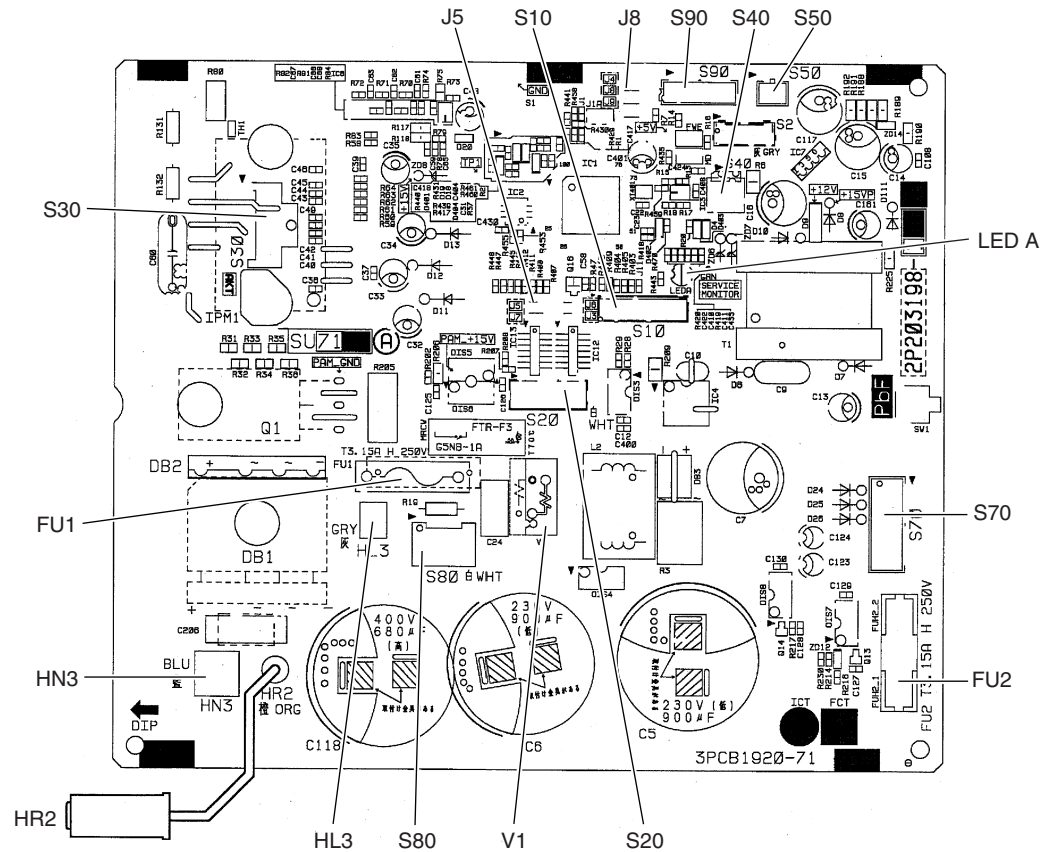

2P203198-1

1.2.3 RK(X)S25/35G2V1B9

Connectors and Other Parts

PCB (1): Filter PCB

- | | |
|----------------|------------------------------|
| 1) S11 | Connector for main PCB |
| 2) AC1, AC2, S | Connector for terminal board |
| 3) E1, E2 | Terminal for earth |
| 4) HL2, HN2 | Connector for main PCB |
| 5) HR1 | Connector for reactor |
| 6) FU1 | Fuse (3.15 A, 250 V) |
| 7) FU3 | Fuse (20 A, 250 V) |
| 8) V2, V3 | Varistor |

PCB (2): Main PCB

- | | |
|-------------|--|
| 1) S10 | Connector for filter PCB |
| 2) S20 | Connector for electronic expansion valve coil |
| 3) S40 | Connector for overload protector |
| 4) S50 | Connector for magnetic relay |
| 5) S70 | Connector for fan motor |
| 6) S80 | Connector for four way valve coil |
| 7) S90 | Connector for thermistors
(outdoor temperature, outdoor heat exchanger, discharge pipe) |
| 8) S100 | Connector for forced operation button PCB |
| 9) HL3, HN3 | Connector for filter PCB |
| 10)HR2 | Connector for reactor |
| 11)U, V, W | Connector for compressor |
| 12)FU2 | Fuse (3.15 A, 250 V) |
| 13)LED A | LED for service monitor (green) |
| 14)V1 | Varistor |
| 15)J4 | Jumper for facility setting
* Refer to page 211 for detail. |
| 16)J5 | Jumper for improvement of defrost performance
* Refer to page 212 for detail. |

PCB (3): Forced Operation Button PCB

- | | |
|---------|--------------------------------|
| 1) S110 | Connector for main PCB |
| 2) SW1 | Forced operation ON/OFF button |

Part 4

Function and Control

1. Main Functions.....	22
1.1 Temperature Control	22
1.2 Frequency Principle.....	22
1.3 Airflow Direction Control.....	24
1.4 Fan Speed Control for Indoor Units.....	25
1.5 Program Dry Operation	26
1.6 Automatic Operation.....	27
1.7 Thermostat Control.....	28
1.8 NIGHT SET Mode	29
1.9 HOME LEAVE Operation	30
1.10 Inverter POWERFUL Operation	31
1.11 Other Functions.....	32
2. Function of Thermistor	33
3. Control Specification	34
3.1 Mode Hierarchy	34
3.2 Frequency Control.....	35
3.3 Controls at Mode Changing / Start-up.....	37
3.4 Discharge Pipe Temperature Control.....	39
3.5 Input Current Control.....	40
3.6 Freeze-up Protection Control	41
3.7 Heating Peak-cut Control	41
3.8 Outdoor Fan Control.....	42
3.9 Liquid Compression Protection Function.....	42
3.10 Defrost Control	43
3.11 Electronic Expansion Valve Control	44
3.12 Malfunctions	47
3.13 Forced Operation Mode	48
3.14 Standby Electricity Saving.....	48

1. Main Functions

1.1 Temperature Control

Definitions of Temperatures

The definitions of temperatures are classified as following.

- ◆ Room temperature: temperature of the lower part of the room
- ◆ Set temperature: temperature set by remote controller
- ◆ Room thermistor temperature: temperature detected by room temperature thermistor
- ◆ Target temperature: temperature determined by microcomputer

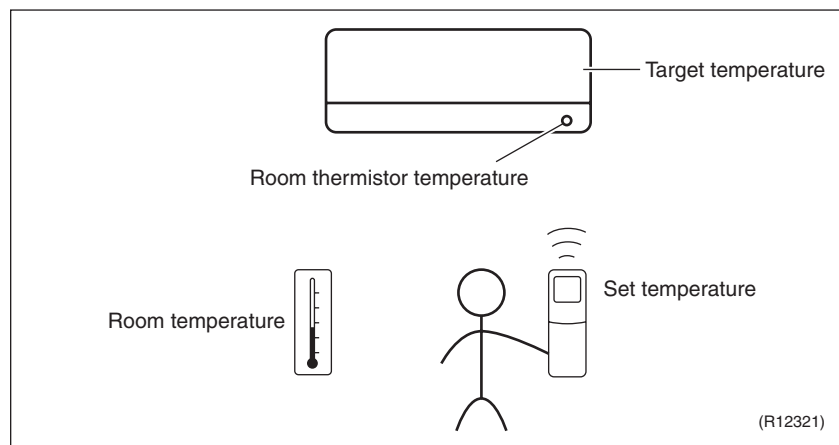

★ The illustration is for wall mounted type as representative.

Temperature Control

The temperature of the room is detected by the room temperature thermistor. However, there is difference between the “temperature detected by room temperature thermistor” and the “temperature of lower part of the room”, depending on the type of the indoor unit or installation condition. Practically, the temperature control is done by the “target temperature appropriately adjusted for the indoor unit” and the “temperature detected by room temperature thermistor”.

1.2 Frequency Principle

Main Control Parameters

The compressor is frequency-controlled during normal operation. The target frequency is set by the following 2 parameters coming from the operating indoor unit:

- The load condition of the operating indoor unit
- The difference between the room thermistor temperature and the target temperature

Additional Control Parameters

The target frequency is adapted by additional parameters in the following cases:

- Frequency restrictions
- Initial settings
- Forced cooling operation

Inverter Principle

To regulate the capacity, a frequency control is needed. The inverter makes it possible to vary the rotation speed of the compressor. The following table explains the conversion principle:

Phase	Description
1	The supplied AC power source is converted into the DC power source for the present.
2	The DC power source is reconverted into the three phase AC power source with variable frequency. <ul style="list-style-type: none"> ■ When the frequency increases, the rotation speed of the compressor increases resulting in an increased refrigerant circulation. This leads to a higher amount of the heat exchange per unit. ■ When the frequency decreases, the rotation speed of the compressor decreases resulting in a decreased refrigerant circulation. This leads to a lower amount of the heat exchange per unit.

Drawing of Inverter

The following drawing shows a schematic view of the inverter principle:

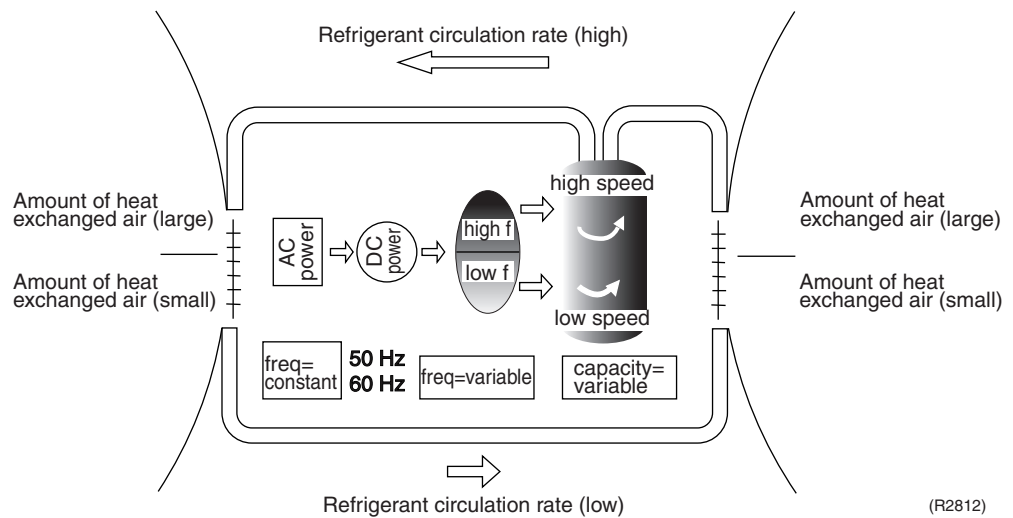

Inverter Features

The inverter provides the following features:

- The regulating capacity can be changed according to the changes in the outdoor temperature and cooling / heating load.
- Quick heating and quick cooling
The compressor rotational speed is increased when starting the heating (or cooling). This enables to reach the set temperature quickly.
- Even during extreme cold weather, the high capacity is achieved. It is maintained even when the outdoor temperature is 2°C.
- Comfortable air conditioning
A fine adjustment is integrated to keep the room temperature constant.
- Energy saving heating and cooling
Once the set temperature is reached, the energy saving operation enables to maintain the room temperature at low power.

Frequency Limits

The following functions regulate the minimum and maximum frequency:

Frequency	Functions
Low	<ul style="list-style-type: none"> ■ Four way valve operation compensation. Refer to page 38.
High	<ul style="list-style-type: none"> ■ Compressor protection function. Refer to page 38. ■ Discharge pipe temperature control. Refer to page 39. ■ Input current control. Refer to page 40. ■ Freeze-up protection control. Refer to page 41. ■ Heating peak-cut control. Refer to page 41. ■ Defrost control. Refer to page 43.

Forced Cooling Operation

Refer to "Forced operation mode" on page 48 for detail.

1.3 Airflow Direction Control

Auto-Swing

The following table explains the auto-swing process for cooling, dry, fan, and heating:

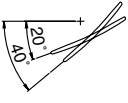
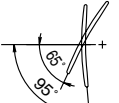
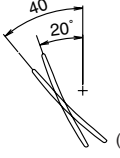
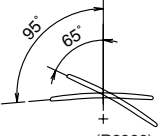
	up and down	
	cooling / dry / fan	heating
ceiling	 <p>(R2964)</p>	 <p>(R2963)</p>
floor	 <p>(R2967)</p>	 <p>(R2966)</p>

1.4 Fan Speed Control for Indoor Units

Outline



Phase control and fan speed control contains 9 steps: LLL, LL, SL, L, ML, M, MH, H, and HH. The airflow rate can be automatically controlled depending on the difference between the room thermistor temperature and the target temperature. This is done through phase control and Hall IC control.



For more information about Hall IC, refer to the troubleshooting for fan motor on page 72.

Automatic Fan Speed Control

In automatic fan speed operation, the step "SL" is not available.

Step	Cooling	Heating
LLL	 (R11577)	 (R11578)
LL		
L		
ML		
M		
MH		
H		
HH (POWERFUL)		

 = The airflow rate is automatically controlled within this range when the FAN setting button is set to automatic.

<Cooling>

The following drawing explains the principle of fan speed control for cooling.

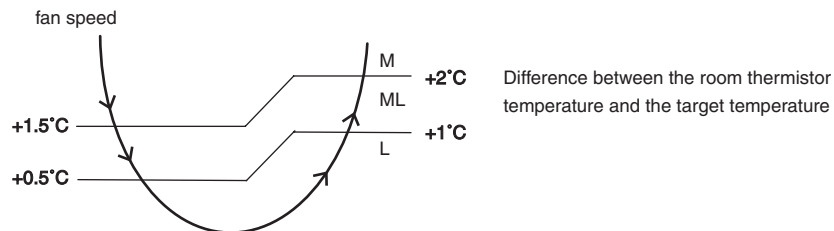

(R12390)

<Heating>

On heating mode, the fan speed is regulated according to the indoor heat exchanger temperature and the difference between the room thermistor temperature and the target temperature.



Note:

1. During POWERFUL operation, the fan rotates at H tap + 50 rpm.
2. The fan stops during defrost operation.

1.5 Program Dry Operation

Outline

Program dry operation removes humidity while preventing the room temperature from lowering. Since the microcomputer controls both the temperature and airflow rate, the temperature adjustment and fan adjustment buttons are inoperable in this mode.

Detail

The microcomputer automatically sets the temperature and airflow rate. The difference between the room thermistor temperature at start-up and the target temperature is divided into two zones. Then, the unit operates in the dry mode with an appropriate capacity for each zone to maintain the temperature and humidity at a comfortable level.

Room thermistor temperature at start-up	Target temperature X	Thermostat OFF point Y	Thermostat ON point Z
24°C or more	Room thermistor temperature at start-up	$X - 2.5^{\circ}\text{C}$	$X - 0.5^{\circ}\text{C}$ or $Y + 0.5^{\circ}\text{C}$ (zone B) continues for 10 min.
23.5°C ⋮ 18°C		$X - 2.0^{\circ}\text{C}$	$X - 0.5^{\circ}\text{C}$ or $Y + 0.5^{\circ}\text{C}$ (zone B) continues for 10 min.
17.5°C ⋮		$X - 2.0^{\circ}\text{C}$	$X - 0.5^{\circ}\text{C} = 17.5^{\circ}\text{C}$ or $Y + 0.5^{\circ}\text{C}$ (zone B) continues for 10 min.

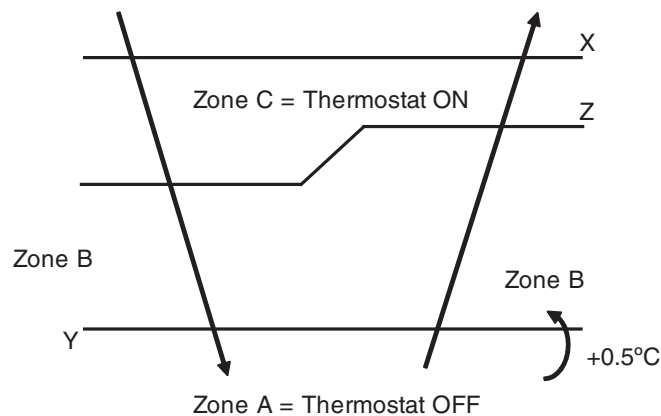

(R11581)

1.6 Automatic Operation

Outline

Automatic Cooling / Heating Function

When the AUTO mode is selected with the remote controller, the microcomputer automatically determines the operation mode as cooling or heating according to the room temperature and the set temperature at start-up, and automatically operates in that mode.

The unit automatically switches the operation mode to maintain the room temperature at the set temperature.

Detail

Ts: set temperature (set by remote controller)

Tt: target temperature (determined by microcomputer)

Tr: room thermistor temperature (detected by room temperature thermistor)

C: correction value

- The set temperature (Ts) determines the target temperature (Tt).
(Ts = 18 ~ 30°C).
- The target temperature (Tt) is calculated as;
 $Tt = Ts + C$
where C is the correction value.
C = 0°C
- Thermostat ON/OFF point and mode switching point are as follows.
Tr means the room thermistor temperature.
 - Heating → Cooling switching point:
 $Tr \geq Tt + 2.5^\circ\text{C}$
 - Cooling → Heating switching point:
 $Tr < Tt - 2.5^\circ\text{C}$
 - Thermostat ON/OFF point is the same as the ON/OFF point of cooling or heating operation.
- During initial operation
 - $Tr \geq Ts$: Cooling operation
 - $Tr < Ts$: Heating operation

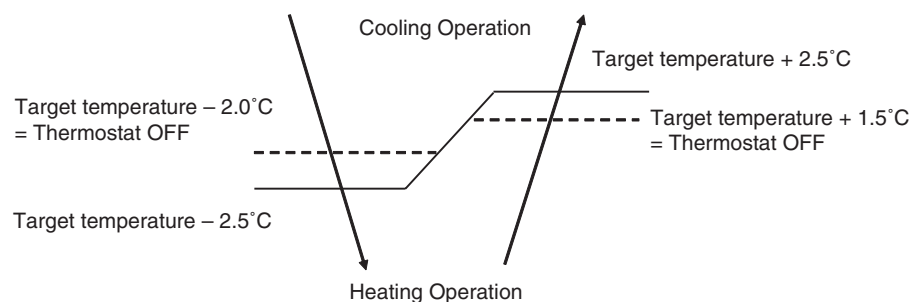

(R11893)

Ex: When the target temperature is 25°C

Cooling → 23°C: Thermostat OFF → 22°C: Switch to heating

Heating → 26.5°C: Thermostat OFF → 27.5°C: Switch to cooling

1.7 Thermostat Control

Thermostat control is based on the difference between the room thermistor temperature and the target temperature.

Thermostat OFF Condition

- ◆ The temperature difference is in the zone A.

Thermostat ON Condition

- ◆ The temperature difference returns to the zone C after being in the zone A.
- ◆ The system resumes from defrost control in any zones except A.
- ◆ The operation turns on in any zones except A.
- ◆ The monitoring time has passed while the temperature difference is in the zone B.
(Cooling / Dry : 10 minutes, Heating : 10 seconds)

Cooling / Dry

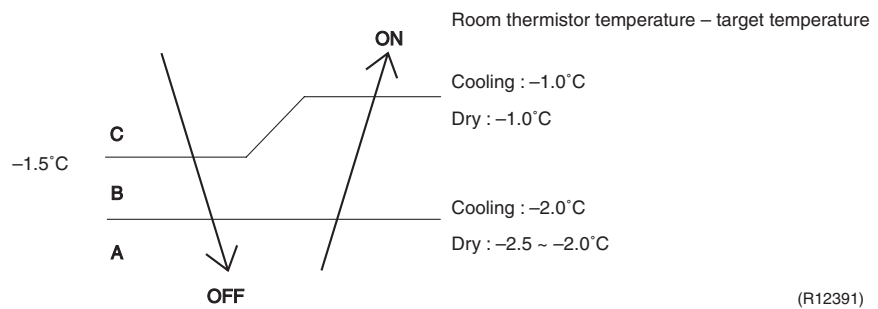

Heating

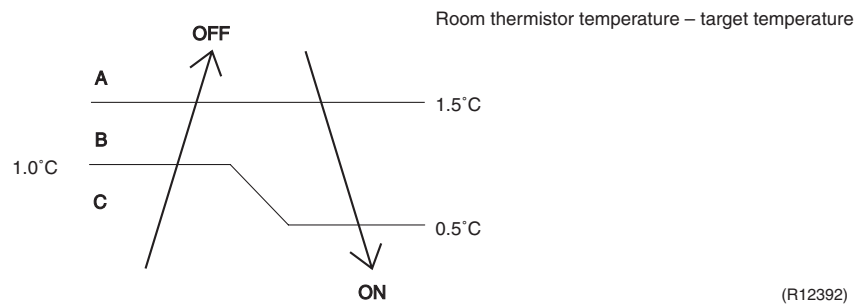

Refer to “Temperature Control” on page 22 for detail.

1.8 NIGHT SET Mode

Outline When the OFF timer is set, the NIGHT SET Mode is automatically activated. The NIGHT SET Mode keeps the airflow rate setting.

Detail The NIGHT SET Mode continues operation at the target temperature for the first one hour, then automatically raises the target temperature slightly in the case of cooling, or lowers it slightly in the case of heating. This prevents excessive cooling in summer and excessive heating in winter to ensure comfortable sleeping conditions, and also conserves electricity.

Cooling

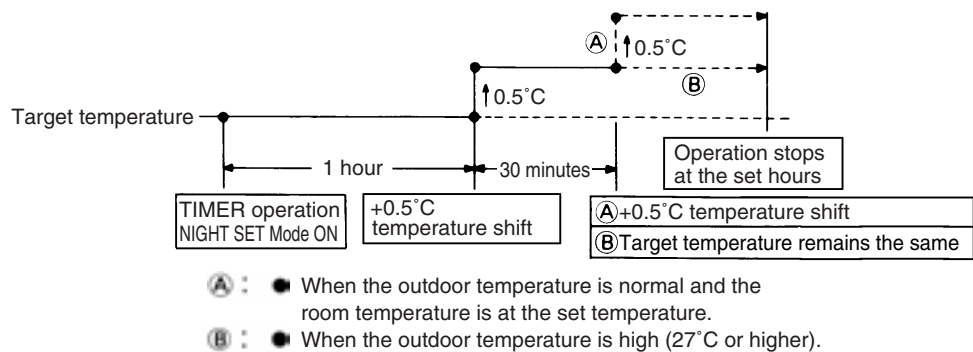

Heating

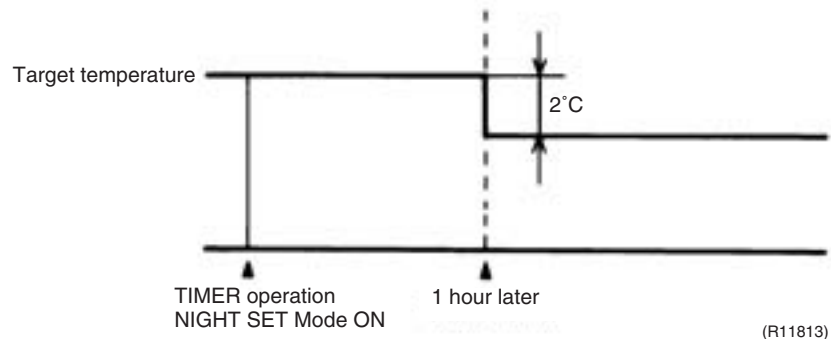

1.9 HOME LEAVE Operation

Outline

HOME LEAVE operation is a function that allows you to record your favorite set temperature and airflow rate. You can start your favorite operation mode simply by pressing the [HOME LEAVE] button on the remote controller.

Detail

1. Start of Function

The function starts when the [HOME LEAVE] button is pressed in cooling mode, heating mode (including POWERFUL operation), or while the operation is stopped. If this button is pressed in POWERFUL operation, the POWERFUL operation is canceled and this function becomes effective.

- The [HOME LEAVE] button is ineffective in dry mode and fan mode.

2. Details of Function

A mark representing HOME LEAVE is indicated on the display of the remote controller. The indoor unit is operated according to the set temperature and airflow rate for HOME LEAVE which were pre-set in the memory of the remote controller.

The LED (red) of indoor unit representing HOME LEAVE lights up. (It goes out when the operation is stopped.)

3. End of Function

The function ends when the [HOME LEAVE] button is pressed again during HOME LEAVE operation or when the [POWERFUL] button is pressed.

<Cooling>



“HOME LEAVE operation”
set temp.



<Heating>



Set temp.
“HOME LEAVE operation”
set temp.



Others

The set temperature and airflow rate are memorized in the remote controller. When the remote controller is reset due to replacement of battery, it is necessary to set the temperature and airflow rate again for HOME LEAVE operation.

1.10 Inverter POWERFUL Operation

Outline

In order to exploit the cooling and heating capacity to full extent, operate the air conditioner by increasing the indoor fan rotating speed and the compressor frequency.

Detail

When POWERFUL button is pressed, the fan speed and target temperature are converted to the following states for 20 minutes.

Operation mode	Fan speed	Target temperature
COOL	H tap + 50 rpm	18°C
DRY	Dry rotating speed + 50 rpm	Lowered by 2.0°C
HEAT	H tap + 50 rpm	30°C
FAN	H tap + 50 rpm	—
AUTO	Same as cooling / heating in POWERFUL operation	The target temperature is kept unchanged.

Ex.) : POWERFUL operation in cooling mode.

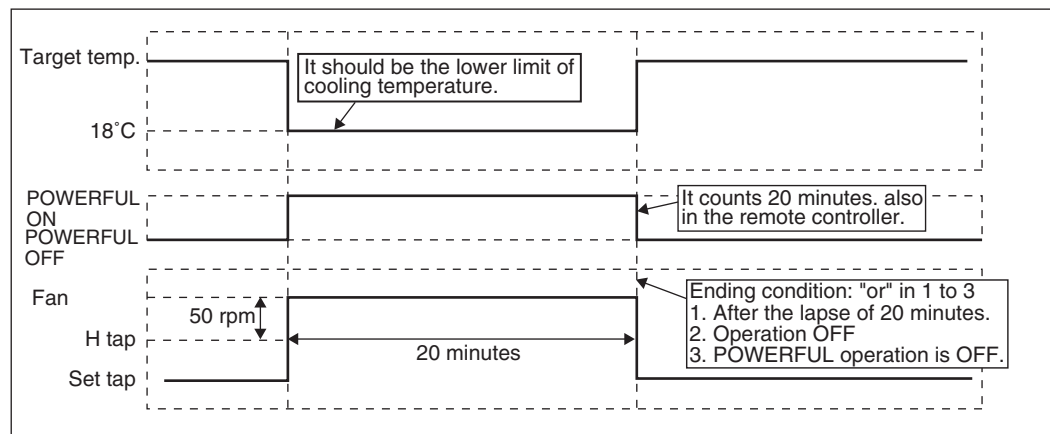

(R7096)

1.11 Other Functions

1.11.1 Hot-Start Function

In order to prevent the cold air blast that normally comes when heating operation is started, the temperature of the indoor heat exchanger is detected, and either the airflow is stopped or is made very weak thereby carrying out comfortable heating of the room.

*The cold air blast is also prevented using a similar control when the defrosting operation is started or when the thermostat is turned ON.

1.11.2 Signal Receiving Sign

When the indoor unit receives a signal from the remote controller, the unit emits a signal receiving sound.

1.11.3 Indoor Unit ON/OFF Button

An ON/OFF button is provided on the display of the unit.

- Press this button once to start operation. Press once again to stop it.
- This button is useful when the remote controller is missing or the battery has run out.
- The operation mode refers to the following table.

	Mode	Temperature setting	Airflow rate
Cooling Only	COOL	22°C	Automatic
Heat Pump	AUTO	25°C	Automatic

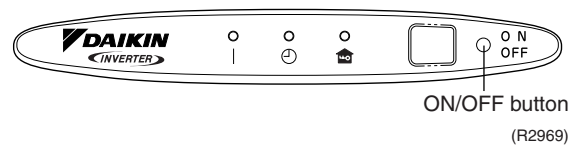

<Forced operation mode>

Forced operation mode can be started by pressing the ON/OFF button for 5 to 9 seconds while the unit is not operating.

Refer to "Forced operation mode" on page 48 for detail.

Note: When the ON/OFF button is pressed for 10 seconds or more, the forced operation is stopped.

1.11.4 Photocatalytic Deodorizing Filter

The photocatalytic deodorizing filter powerfully decomposes odor of tobacco, pet, etc. The deodorizing power is regenerated simply by being exposed to the sunshine. It is recommended to dry the filter in the sun for about 6 hours (after vacuuming the filter) every 6 months.

1.11.5 Air-Purifying Filter

The air-purifying filter collects tobacco smoke, pollen, etc. with electrostatic agency. This filter includes a deodorizing active carbon filter that removes minute particles of odor. Replace the air-purifying filter every 3 months.

1.11.6 Auto-restart Function

Even if a power failure (including one for just a moment) occurs during the operation, the operation restarts automatically when the power is restored in the same condition as before the power failure.

Note: It takes 3 minutes to restart the operation because the 3-minute standby function is activated.

2. Function of Thermistor

Cooling Only

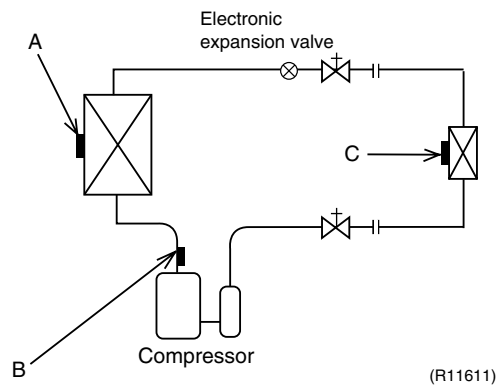

Heat Pump

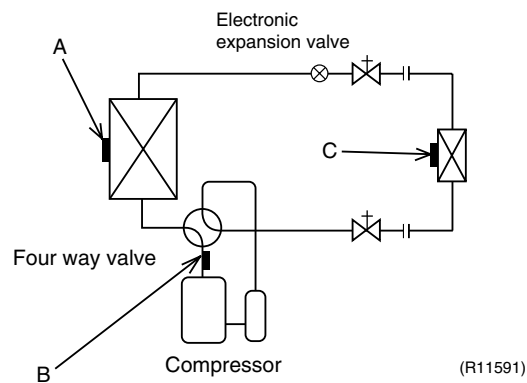

A Outdoor Heat Exchanger Thermistor

1. The outdoor heat exchanger thermistor is used for controlling target discharge pipe temperature. The system sets the target discharge pipe temperature according to the outdoor and indoor heat exchanger temperature, and controls the electronic expansion valve opening so that the target discharge pipe temperature can be obtained.
2. In cooling operation, the outdoor heat exchanger thermistor is used for detecting disconnection of the discharge pipe thermistor. When the discharge pipe temperature becomes lower than the outdoor heat exchanger temperature, the discharge pipe thermistor is judged as disconnected.
3. In cooling operation, the outdoor heat exchanger thermistor is used for high pressure protection.

B Discharge Pipe Thermistor

1. The discharge pipe thermistor is used for controlling discharge pipe temperature. If the discharge pipe temperature (used in place of the inner temperature of the compressor) rises abnormally, the operating frequency becomes lower or the operation halts.
2. The discharge pipe thermistor is used for detecting disconnection of the discharge pipe thermistor.

C Indoor Heat Exchanger Thermistor

1. The indoor heat exchanger thermistor is used for controlling target discharge pipe temperature. The system sets the target discharge pipe temperature according to the outdoor and indoor heat exchanger temperature, and controls the electronic expansion valve opening so that the target discharge pipe temperature can be obtained.
2. In cooling operation, the indoor heat exchanger thermistor is used for freeze-up protection control. If the indoor heat exchanger temperature drops abnormally, the operating frequency becomes lower or the operation halts.
3. In heating operation, the indoor heat exchanger thermistor is used for detecting disconnection of the discharge pipe thermistor. When the discharge pipe temperature becomes lower than the indoor heat exchanger temperature, the discharge pipe thermistor is judged as disconnected.

3. Control Specification

3.1 Mode Hierarchy

Outline

There are two modes; the one is the normal operation mode and the other is the forced operation mode for installation and providing service.

Detail

For Cooling Only Model

There are following modes; stop and cooling (including drying).

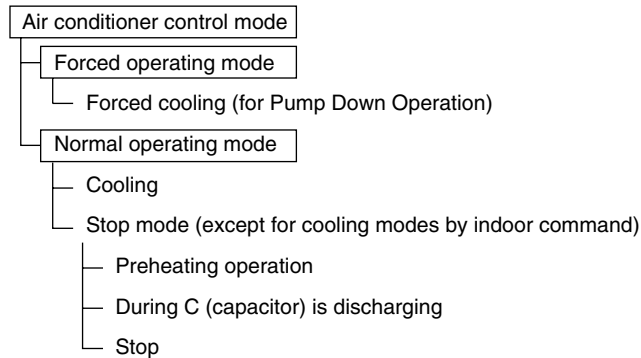

(R2830)

For Heat Pump Model

There are following modes; stop, cooling (includes drying), heating (include defrosting)

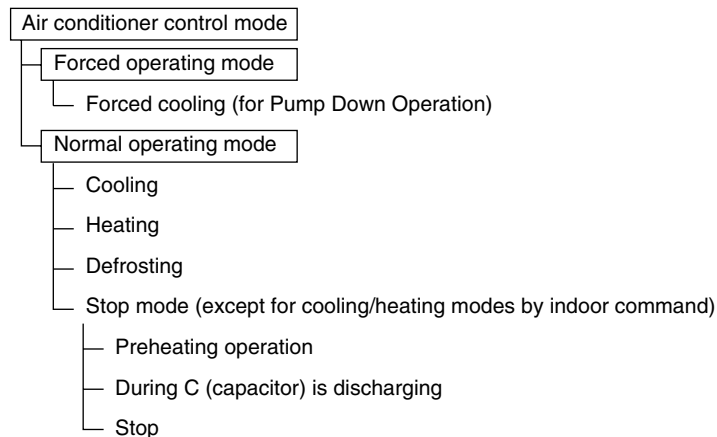

(R2829)



Note: Unless specified otherwise, an indoor dry operation command is regarded as cooling operation.

3.2 Frequency Control

Outline

Frequency is determined according to the difference between the room thermistor temperature and the target temperature.

The function is explained as follows.

1. How to determine frequency
2. Frequency command from the indoor unit (Difference between the room thermistor temperature and the target temperature)
3. Frequency initial setting
4. PI control

When the shift of the frequency is less than zero ($\Delta F < 0$) by PI control, the target frequency is used as the command frequency.

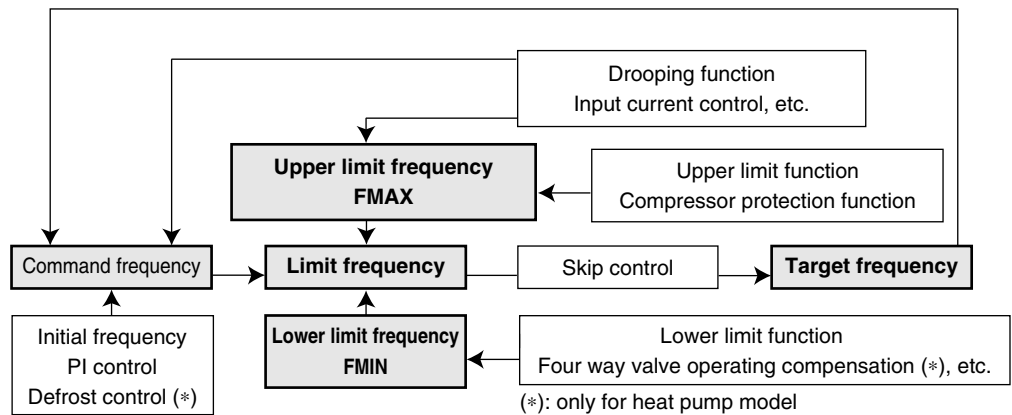

(R11592)

Detail

How to Determine Frequency

The compressor's frequency is determined by taking the following steps.

For Cooling Only Model

1. Determine command frequency

- ◆ Command frequency is determined in the following order of priority.

1. Forced cooling
2. Indoor frequency command

2. Determine upper limit frequency

- ◆ The minimum value is set as an upper limit frequency among the frequency upper limits of the following functions:
Compressor protection, input current, discharge pipe temperature, freeze-up protection

3. Determine lower limit frequency

- ◆ The maximum value is set as a lower limit frequency among the frequency lower limits of the following function:
Pressure difference upkeep

4. Determine prohibited frequency

- ◆ There is a certain prohibited frequency such as a power supply frequency.

For Heat Pump Model

1. Determine command frequency

- ◆ Command frequency is determined in the following order of priority.

1. Limiting defrost control time
2. Forced cooling
3. Indoor frequency command

2. Determine upper limit frequency

- ♦ The minimum value is set as an upper limit frequency among the frequency upper limits of the following functions:
Compressor protection, input current, discharge pipe temperature, heating peak-cut, freeze-up protection, defrost.

3. Determine lower limit frequency

- ♦ The maximum value is set as a lower limit frequency among the frequency lower limits of the following functions:
Four way valve operation compensation, draft prevention, pressure difference upkeep.

4. Determine prohibited frequency

- ♦ There is a certain prohibited frequency such as a power supply frequency.

Indoor Frequency Command (ΔD signal)

The difference between the room thermistor temperature and the target temperature is taken as the " ΔD signal" and is used for frequency command.

Temperature difference	ΔD signal	Temperature difference	ΔD signal	Temperature difference	ΔD signal	Temperature difference	ΔD signal
-2.0	*Th OFF	0	4	2.0	8	4.0	C
-1.5	1	0.5	5	2.5	9	4.5	D
-1.0	2	1.0	6	3.0	A	5.0	E
-0.5	3	1.5	7	3.5	B	5.5	F

*Th OFF = Thermostat OFF

Frequency Initial Setting**<Outline>**

When starting the compressor, the frequency is initialized according to the ΔD value and the Q value of the indoor unit.

Q value: Indoor unit output determined from indoor unit volume, airflow rate and other factors.

PI Control (Determine Frequency Up / Down by ΔD Signal)**1. P control**

The ΔD value is calculated in each sampling time (15 ~ 20 seconds), and the frequency is adjusted according to its difference from the frequency previously calculated.

2. I control

If the operating frequency does not change for more than a certain fixed time, the frequency is adjusted according to the ΔD value.

When the ΔD value is small, the frequency is lowered.

When the ΔD value is large, the frequency is increased.

3. Frequency management when other controls are functioning

- ♦ When frequency is drooping;
Frequency management is carried out only when the frequency droops.
- ♦ For limiting lower limit
Frequency management is carried out only when the frequency rises.

4. Upper and lower limit of frequency by PI control

The frequency upper and lower limits are set according to the command on indoor unit.

When the indoor or outdoor unit quiet operation command comes from the indoor unit, the upper limit frequency is lowered than the usual setting.

3.3 Controls at Mode Changing / Start-up

3.3.1 Preheating Operation

Outline

The inverter operation in open phase starts with the conditions of the preheating command from the indoor unit, the outdoor temperature, and the discharge pipe temperature.

Detail

■ RK(X)S25/35E2V1B, RK(X)S25/35G2V1B

ON Condition

- ◆ When the discharge pipe temperature is below 10°C, the inverter operation in open phase starts.

OFF Condition

- ◆ When the discharge pipe temperature is higher than 12°C, the inverter operation in open phase stops.

■ RK(X)S25/35G2V1B9

Outdoor temperature $\geq 7^{\circ}\text{C}$ → Control A

Outdoor temperature $< 7^{\circ}\text{C}$ → Control B

Control A

- ◆ ON condition
 - Discharge pipe temperature $< 10^{\circ}\text{C}$
- ◆ OFF condition
 - Discharge pipe temperature $> 12^{\circ}\text{C}$
 - Radiation fin temperature $\geq 90^{\circ}\text{C}$

Control B

- ◆ ON condition
 - Discharge pipe temperature $< 20^{\circ}\text{C}$
- ◆ OFF condition
 - Discharge pipe temperature $> 22^{\circ}\text{C}$
 - Radiation fin temperature $\geq 90^{\circ}\text{C}$

3.3.2 Four Way Valve Switching

Outline

In heating operation, current is conducted, and in cooling and defrosting, current is not conducted. In order to eliminate the switching sound when the heating is stopped, as the four way valve coil switches from ON to OFF, the OFF delay switch of the four way valve is carried out after the operation stopped.

Detail

OFF delay switch of four way valve:

The four way valve coil is energized for 160 seconds after the operation is stopped.

3.3.3 Four Way Valve Operation Compensation

Outline

At the beginning of the operation as the four way valve is switched, the differential pressure to activate the four way valve is acquired by having output frequency which is more than a certain fixed frequency, for a certain fixed time.

Detail

Starting Conditions

1. When starting compressor for heating.
 2. When the operation mode changes to cooling from heating.
 3. When starting compressor for defrosting or resetting.
 4. When starting compressor for the first time after the reset with the power is ON.
 5. When starting compressor for heating next to the suspension of defrosting.
 6. When starting compressor next to the fault of switching over cooling / heating.
- Set the lower limit frequency Δ Hz for B seconds with any conditions 1 through 6 above.

	Cooling	Heating
Δ (Hz)	68	66
B (seconds)	45	

3.3.4 3-minute Standby

Turning on the compressor is prohibited for 3 minutes after turning it off.
(Except when defrosting.)

3.3.5 Compressor Protection Function

When turning the compressor from OFF to ON, the upper limit of frequency is set as follows.
(The function is not activated when defrosting.)

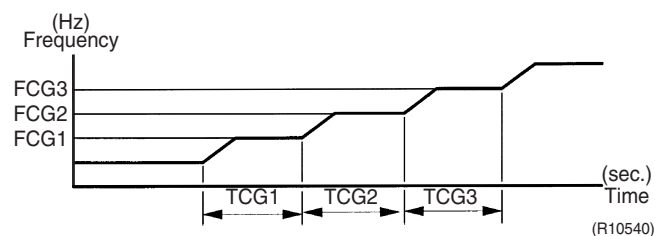

FCG 1	48	Hz
FCG 2	64	
FCG 3	88	
TCG 1	240	seconds
TCG 2	360	
TCG 3	180	

3.4 Discharge Pipe Temperature Control

Outline

The discharge pipe temperature is used as the internal temperature of the compressor. If the discharge pipe temperature rises above a certain level, the upper limit of frequency is set to keep this temperature from going up further.

Detail

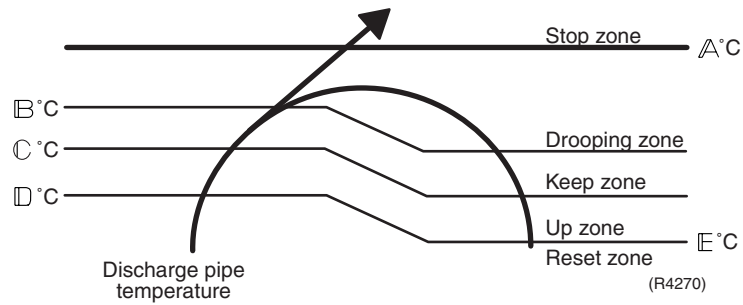

Zone	Control
Stop zone	When the temperature reaches the stop zone, the compressor stops.
Drooping zone	The timer starts, and the frequency is drooping.
Keep zone	The upper limit of frequency is kept.
Up zone	The upper limit of frequency is increased.
Reset zone	The upper limit of frequency is canceled.

A (°C)	110
B (°C)	105
C (°C)	101
D (°C)	99
E (°C)	97

3.5 Input Current Control

Outline

The microcomputer calculates the input current during the compressor is running, and sets the frequency upper limit from the input current.

In case of heat pump model, this control which is the upper limit control of the frequency takes priority to the lower limit of control of four way valve operation compensation.

Detail

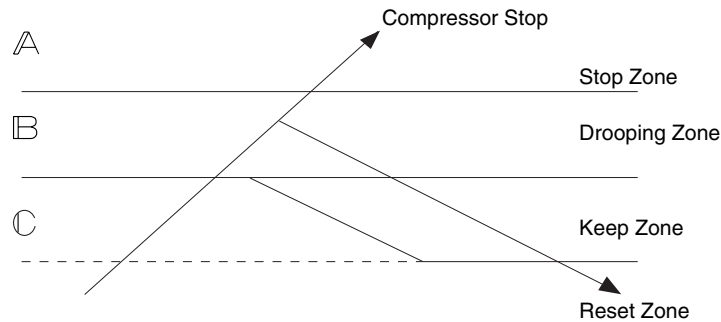

(R4304)

Frequency control in each zone

Stop zone

- After 2.5 seconds in this zone, the compressor is stopped.

Drooping zone

- The upper limit of the compressor frequency is defined as operation frequency – 2 Hz.
- After this, the output frequency is pulled down by 2 Hz every second until it reaches the keep zone.

Keep zone

- The present maximum frequency goes on.

Reset zone

- Limit of the frequency is canceled.

	RK(X)S25E2V1B		RK(X)S25G2V1B		RK(X)S25G2V1B9	
	Cooling	Heating	Cooling	Heating	Cooling	Heating
△ (A)	9.25		9.25		9.25	
▢ (A)	6.0	7.5	6.5	7.5	6.25	7.5
○ (A)	5.25	6.75	5.75	6.75	5.5	6.75

	RK(X)S35E2V1B RK(X)S35G2V1B		RK(X)S35G2V1B9	
	Cooling	Heating	Cooling	Heating
△ (A)	9.25		9.25	
▢ (A)	7.25	8.25	8.25	
○ (A)	6.5	7.5	7.5	

Limitation of current drooping and stop value according to the outdoor temperature

- The current droops when outdoor temperature becomes higher than a certain level (depending on the model).

3.6 Freeze-up Protection Control

Outline During cooling operation, the signal sent from the indoor unit controls the operating frequency limitation and prevents freezing of the indoor heat exchanger. (The signal from the indoor unit is divided into zones.)

Detail The operating frequency limitation is judged with the indoor heat exchanger temperature.

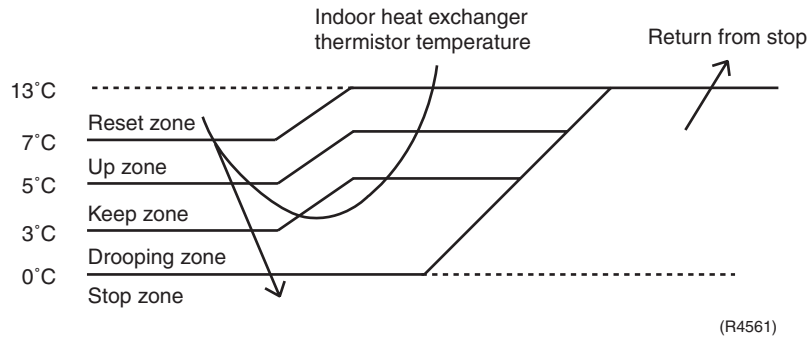

3.7 Heating Peak-cut Control

Outline During heating operation, the indoor heat exchanger temperature determines the frequency upper limit to prevent abnormal high pressure.

Detail

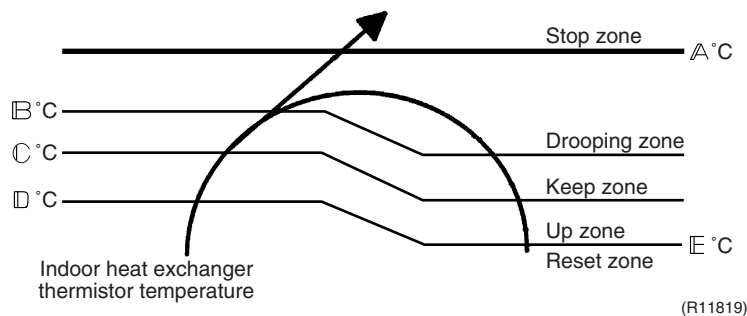

Zone	Control
Stop zone	When the temperature reaches the stop zone, the compressor stops.
Drooping zone	The timer starts, and the frequency is drooping.
Keep zone	The upper limit of frequency is kept.
Up zone	The upper limit of frequency is increased.
Reset zone	The upper limit of frequency is canceled.

A (°C)	65
B (°C)	56
C (°C)	53
D (°C)	51
E (°C)	46

3.8 Outdoor Fan Control

1. Fan OFF delay when stopped

The outdoor fan is turned OFF 60 seconds after the compressor stops.

2. Fan ON control to cool down the electrical box

The outdoor fan is turned ON when the electrical box temperature is high while the compressor is OFF.

3. Fan OFF control while defrosting

The outdoor fan is turned OFF while defrosting.

4. Fan ON/OFF control when operation starts / stops

The outdoor fan is turned ON when the operation starts. The outdoor fan is turned OFF when the operation stops.

5. Fan control while forced operation

The outdoor fan is controlled as well as normal operation while the forced operation.

6. Fan speed control while indoor / outdoor quiet operation

The rotation speed of the outdoor fan is reduced by the command of the indoor/outdoor quiet operation.

7. Fan control for POWERFUL operation

The rotation speed of the outdoor fan is increased while the POWERFUL operation.

8. Fan speed control for pressure difference upkeep

The rotation speed of the outdoor fan is controlled for keeping the pressure difference while cooling with low outdoor temperature.

- ◆ When the pressure difference is small, the rotation speed of the outdoor fan is reduced.
- ◆ When the pressure difference is large, the rotation speed of the outdoor fan is increased.

3.9 Liquid Compression Protection Function

Outline

In order to obtain the dependability of the compressor, the compressor is stopped according to the outdoor temperature and temperature of the outdoor heat exchanger.

Detail

- Operation stops depending on the outdoor temperature

Compressor turns off under the conditions that the system is in cooling operation and outdoor temperature is below -12°C .

3.10 Defrost Control

Outline

Defrosting is carried out by the cooling cycle (reverse cycle). The defrosting time or outdoor heat exchanger temperature must be more than a certain value to finish.

Detail

Conditions for Starting Defrost

- The starting conditions is determined with the outdoor temperature and the outdoor heat exchanger temperature.
- The system is in heating operation.
- The compressor operates for 6 minutes.
- More than Δ minutes of accumulated time pass since the start of the operation, or ending the previous defrosting.

Conditions for Canceling Defrost

The judgment is made with outdoor heat exchanger temperature. ($\text{IL } ^\circ\text{C}$)

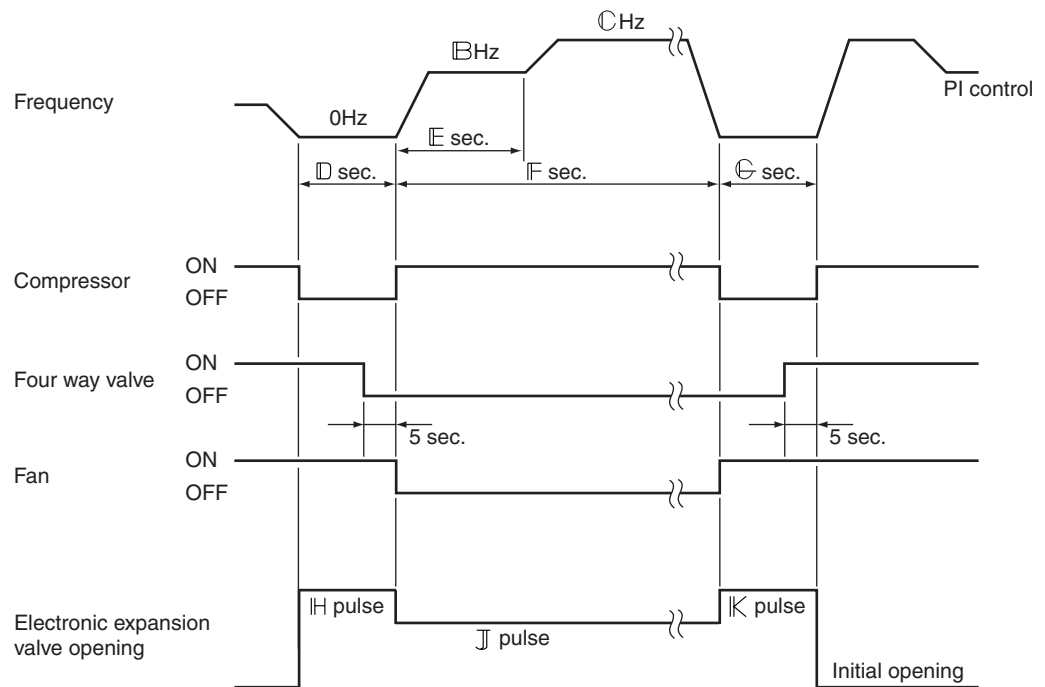

(R12211)

	RK(X)S25/35E2V1B	RK(X)S25/35G2V1B RK(X)S25/35G2V1B9
Δ (minutes)	28	28
B (Hz)	76	76
C (Hz)	86	86
D (seconds)	50	50
E (seconds)	60	60
F (seconds)	600	600
G (seconds)	50	60
IH (pulse)	450	450
J (pulse)	350	350
K (pulse)	450	450
IL ($^\circ\text{C}$)	4 ~ 22	4 ~ 18

3.11 Electronic Expansion Valve Control

Outline

The following items are included in the electronic expansion valve control.

Electronic expansion valve is fully closed

1. Electronic expansion valve is fully closed when turning on the power.
2. Pressure equalizing control

Open Control

1. Electronic expansion valve control when starting operation
2. Electronic expansion valve control when frequency changed
3. Electronic expansion valve control for defrosting
4. Electronic expansion valve control when the discharge pipe temperature is abnormally high
5. Electronic expansion valve control when the discharge pipe thermistor is disconnected

Feedback Control

1. Discharge pipe temperature control

Detail

The followings are the examples of control which function in each mode by the electronic expansion valve control.

Operation pattern		Control when frequency changed	Control for abnormally high discharge pipe temperature	
When power is turned ON	○ : function × : not function	×	×	
↓		Fully closed when power is turned ON	×	×
Cooling operation		Open control when starting	×	○
↓		(Control of target discharge pipe temperature)	○	○
Stop		Pressure equalizing control	×	×
Heating operation		Open control when starting	×	○
↓		(Control of target discharge pipe temperature)	○	○
↓		Pressure equalizing control	×	×
Stop		Open control when starting	×	×
Heating operation		Continue	×	○
↓		Control of discharge pipe thermistor disconnection	×	×
Stop		Pressure equalizing control	×	×

(R2833)

3.11.1 Fully Closing with Power ON

The electronic expansion valve is initialized when turning on the power. The opening position is set and the pressure equalization is developed.

3.11.2 Pressure Equalization Control

When the compressor is stopped, the pressure equalization control is activated. The electronic expansion valve opens, and develops the pressure equalization.

3.11.3 Opening Limit

Outline

A maximum and minimum opening of the electronic expansion valve are limited.

Detail

Maximum opening (pulse)	480
Minimum opening (pulse)	52

The electronic expansion valve is fully closed when cooling operation stops, and is opened at fixed degree during defrosting.

3.11.4 Starting Operation Control

The electronic expansion valve opening is controlled when the operation starts, and prevents the superheating or liquid compression.

3.11.5 High Discharge Pipe Temperature

When the compressor is operating, if the discharge pipe temperature exceeds a certain value, the electronic expansion valve opens and the refrigerant runs to the low pressure side. This procedure lowers the discharge pipe temperature.

3.11.6 Disconnection of the Discharge Pipe Thermistor

Outline

The disconnection of the discharge pipe thermistor is detected by comparing the discharge pipe temperature with the condensation temperature. If the discharge pipe thermistor is disconnected, the electronic expansion valve opens according to the outdoor temperature and the operation frequency, and operates for a specified time, and then stops.

After 3 minutes of waiting, the operation restarts and checks if the discharge pipe thermistor is disconnected. If the discharge pipe thermistor is disconnected, the system stops after operating for a specified time.

If the disconnection is detected 5 times in succession, then the system is shut down. When the compressor runs for 60 minutes without any error, the error counter is reset.

Detail

When the starting control (cooling : A seconds, heating : B seconds) finishes, the detection timer for disconnection of the discharge pipe thermistor (C seconds) starts. When the timer is over, the following adjustment is made.

1. When the operation mode is cooling

When the following condition is fulfilled, the discharge pipe thermistor disconnection is ascertained.

Discharge pipe temperature + 6°C < outdoor heat exchanger temperature

2. When the operation mode is heating

When the following condition is fulfilled, the discharge pipe thermistor disconnection is ascertained.

Discharge pipe temperature + 6°C < indoor heat exchanger temperature

A (seconds)	10
B (seconds)	120
C (seconds)	810

Adjustment when the thermistor is disconnected

When the disconnection is ascertained, the compressor continues operation for 9 minutes and then stops.

When the compressor stops repeatedly, the system is shut down.

3.11.7 Control when frequency is changed

When the target discharge pipe temperature control is active, if the target frequency is changed for a specified value in a certain time period, the target discharge pipe temperature control is canceled and the target opening of the electronic expansion valve is changed according to the shift.

3.11.8 Target Discharge Pipe Temperature Control

The target discharge pipe temperature is obtained from the indoor and outdoor heat exchanger temperature, and the electronic expansion valve opening is adjusted so that the actual discharge pipe temperature becomes close to the target discharge pipe temperature. (Indirect SH (superheating) control using the discharge pipe temperature)

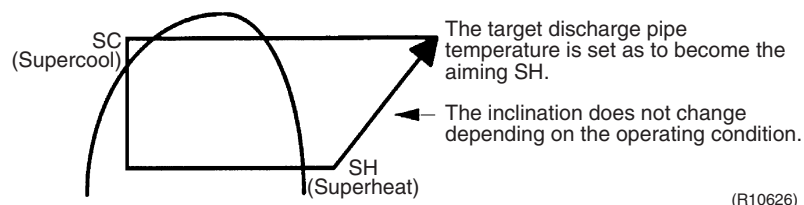

The electronic expansion valve opening and the target discharge pipe temperature are adjusted every 20 seconds. The target discharge pipe temperature is controlled by indoor heat exchanger temperature and outdoor heat exchanger temperature. The opening degree of the electronic expansion valve is controlled by followings.

- ◆ Target discharge pipe temperature
- ◆ Actual discharge pipe temperature
- ◆ Previous discharge pipe temperature

3.12 Malfunctions

3.12.1 Sensor Malfunction Detection

Sensor malfunction may occur in the thermistor.

Relating to Thermistor Malfunction

1. Outdoor heat exchanger thermistor
2. Discharge pipe thermistor
3. Radiation fin thermistor
4. Outdoor temperature thermistor

3.12.2 Detection of Overcurrent and Overload

Outline

An excessive output current is detected and, the OL temperature is observed to protect the compressor.

Detail

- If the OL (compressor head) temperature exceeds 120°C, the system shuts down the compressor.
- If the inverter current exceeds 9.25 A, the system shuts down the compressor.

3.12.3 Refrigerant Shortage Control

Outline

I Detecting by power consumption

If the power consumption is below the specified value and the frequency is higher than the specified frequency, it is regarded as refrigerant shortage.

The power consumption is small comparing with that in the normal operation when refrigerant is insufficient, and refrigerant shortage is detected by checking a power consumption.

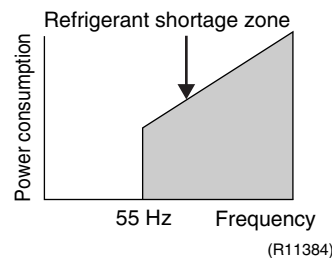

II Detecting by discharge pipe temperature

If the discharge pipe temperature is higher than the target discharge pipe temperature, and the electronic expansion valve is fully open for more than the specified time, it is regarded as refrigerant shortage.

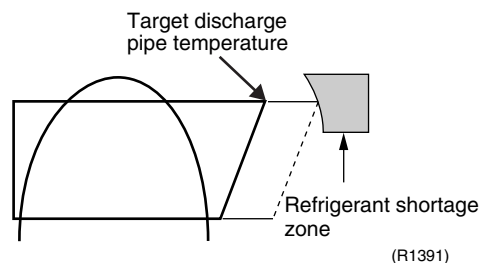

III Detecting by the difference of temperature

If the difference between suction and discharge temperature is smaller than the specified value, it is regarded as refrigerant shortage.



Refer to "Refrigerant shortage" on page 99 for detail.

3.13 Forced Operation Mode

Outline Forced operation mode includes only forced cooling.

Detail

Item	Forced Cooling
Conditions	1) The outdoor unit is not abnormal and not in the 3-minute standby mode.
	2) The outdoor unit is not operating.
	The forced operation is allowed when the above both conditions are met.
Start	The forced operation starts when any of the following conditions is fulfilled. 1) Press the forced operation ON/OFF button (SW1) on the indoor unit for 5 seconds. 2) Press the forced operation ON/OFF button (SW1) on the outdoor unit. (RK(X)S25/35G2V1B9 models only)
Command frequency	RK(X)S25/35E2V1B, RK(X)S25/35G2V1B: 68 Hz RK(X)S25/35G2V1B9: 58 Hz
End	The forced operation ends when any of the following conditions is fulfilled. 1) The operation ends automatically after 15 minutes. 2) Press the forced operation ON/OFF button (SW1) on the indoor unit again. 3) Press the ON/OFF button on the remote controller. 4) Press the forced operation ON/OFF button (SW1) on the outdoor unit.
Others	The protection functions are prior to all others in the forced operation.

3.14 Standby Electricity Saving

RK(X)S25/35G2V1B, RK(X)S25/35G2V1B9 Models Only

This function turns power supply OFF to the outdoor unit and sets the indoor unit into energy-saving mode, thus reducing the power consumption of the air conditioner.

Field setting is required for turning ON the function.



Refer to “Standby Electricity Saving” on page 210 for detail.

Part 5

Operation Manual

1. System Configuration.....	50
2. Operation Manual.....	51
2.1 Remote Controller	51
2.2 AUTO · DRY · COOL · HEAT · FAN Operation	52
2.3 Adjusting the Airflow Direction.....	54
2.4 POWERFUL Operation	56
2.5 OUTDOOR UNIT QUIET Operation	57
2.6 HOME LEAVE Operation	58
2.7 TIMER Operation	60

1. System Configuration

After the installation and test operation of the room air conditioner have been completed, it should be operated and handled as described below. Every user would like to know the correct method of operation of the room air conditioner, to check if it is capable of cooling (or heating) well, and to know a clever method of using it.

In order to meet this expectation of the users, giving sufficient explanations taking enough time can be said to reduce about 80% of the requests for servicing. However good the installation work is and however good the functions are, the customer may blame either the room air conditioner or its installation work because of improper handling. The installation work and handing over of the unit can only be considered to have been completed when its handling has been explained to the user without using technical terms but giving full knowledge of the equipment.

2. Operation Manual

2.1 Remote Controller

■ Remote Controller

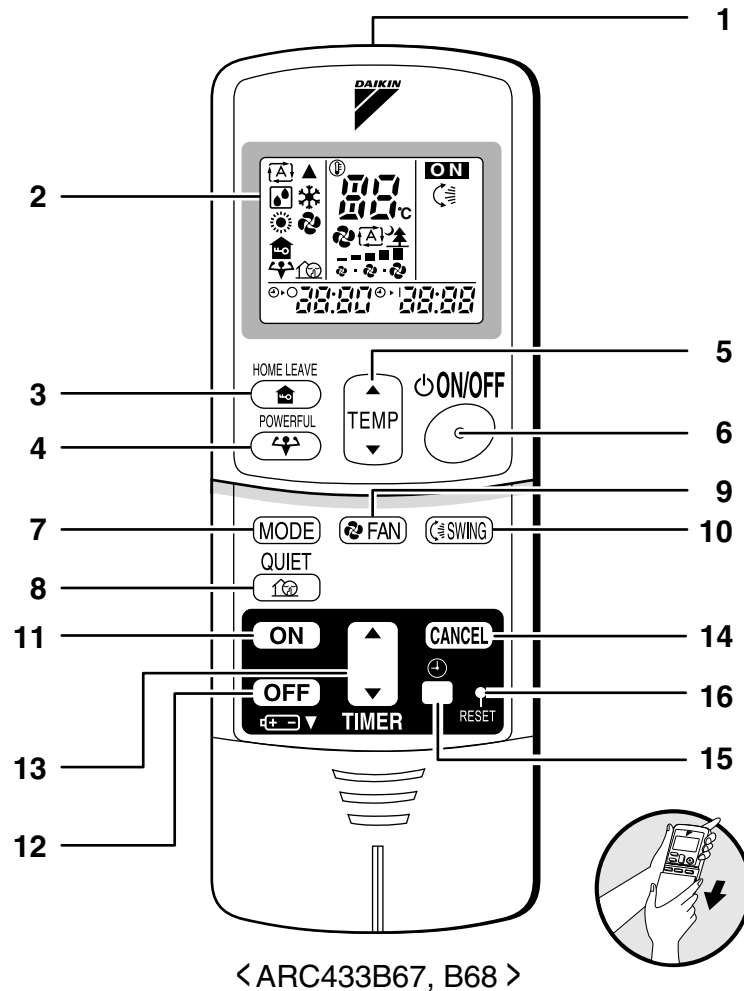

< ARC433B67, B68 >

- 1. Signal transmitter:**
 - It sends signals to the indoor unit.
- 2. Display:**
 - It displays the current settings.
(In this illustration, each section is shown with all its displays ON for the purpose of explanation.)
- 3. HOME LEAVE button:**
HOME LEAVE operation (page 16.)
- 4. POWERFUL button:**
POWERFUL operation (page 14.)
- 5. TEMPERATURE adjustment buttons:**
 - It changes the temperature setting.
- 6. ON/OFF button:**
 - Press this button once to start operation.
Press once again to stop it.
- 7. MODE selector button:**
 - It selects the operation mode.
(AUTO/DRY/COOL/HEAT/FAN) (page 10.)
- 8. QUIET button:** OUTDOOR UNIT QUIET operation (page 15.)
- 9. FAN setting button:**
 - It selects the air flow rate setting.
- 10. SWING button:** (page 12.)
- 11. ON TIMER button:** (page 19.)
- 12. OFF TIMER button:** (page 18.)
- 13. TIMER Setting button:**
 - It changes the time setting.
- 14. TIMER CANCEL button:**
 - It cancels the timer setting.
- 15. CLOCK button**
- 16. RESET button:**
 - Restart the unit if it freezes.
 - Use a thin object to push.

2.2 AUTO · DRY · COOL · HEAT · FAN Operation

AUTO · DRY · COOL · HEAT · FAN Operation

The air conditioner operates with the operation mode of your choice.
From the next time on, the air conditioner will operate with the same operation mode.

■ To start operation

1. Press “MODE selector button” and select a operation mode.

- Each pressing of the button advances the mode setting in sequence.

- : AUTO
- : DRY
- : COOL
- : HEAT
- : FAN

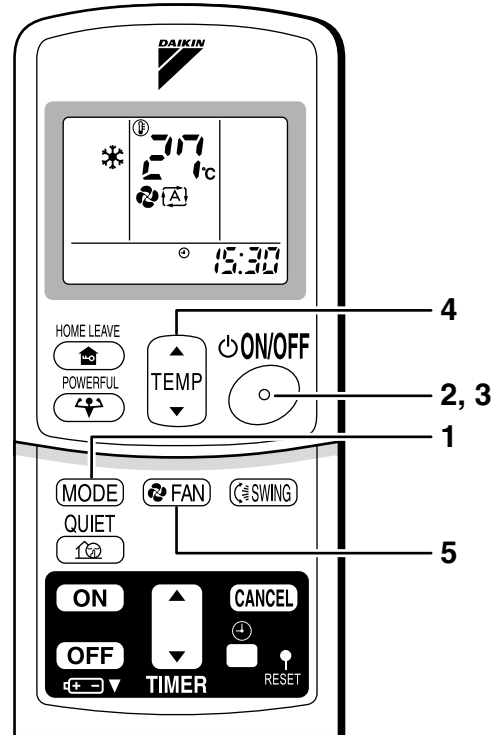
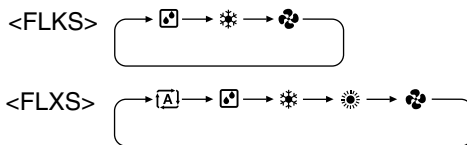

2. Press “ON/OFF button” .

- The OPERATION lamp lights up.

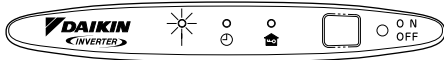

■ To stop operation

3. Press “ON/OFF button” again.

- Then OPERATION lamp goes off.





■ To change the temperature setting

4. Press “TEMPERATURE adjustment button”.

DRY or FAN mode	AUTO or COOL or HEAT mode
The temperature setting is not variable.	Press “▲” to raise the temperature and press “▼” to lower the temperature.
	Set to the temperature you like.

■ To change the air flow rate setting

5. Press “FAN setting button”.

DRY mode	AUTO or COOL or HEAT or FAN mode
The air flow rate setting is not variable.	Five levels of air flow rate setting from “  ” to “  ” plus “  ” “  ” are available. 

- Indoor unit quiet operation

When the air flow is set to “”, the noise from the indoor unit will become quieter. Use this when making the noise quieter.

The unit might lose capacity when the air flow rate is set to a weak level.

NOTE

■ Note on HEAT operation

- Since this air conditioner heats the room by taking heat from outdoor air to indoors, the heating capacity becomes smaller in lower outdoor temperatures. If the heating effect is insufficient, it is recommended to use another heating appliance in combination with the air conditioner.
- The heat pump system heats the room by circulating hot air around all parts of the room. After the start of heating operation, it takes some time before the room gets warmer.
- In heating operation, frost may occur on the outdoor unit and lower the heating capacity. In that case, the system switches into defrosting operation to take away the frost.
- During defrosting operation, hot air does not flow out of indoor unit.

■ Note on COOL operation

- This air conditioner cools the room by blowing the hot air in the room outside, so if the outside temperature is high, performance drops.

■ Note on DRY operation

- The computer chip works to rid the room of humidity while maintaining the temperature as much as possible. It automatically controls temperature and fan strength, so manual adjustment of these functions is unavailable.

■ Note on AUTO operation

- In AUTO operation, the system selects a temperature setting and an appropriate operation mode (COOL or HEAT) based on the room temperature at the start of the operation.
- The system automatically reselects setting at a regular interval to bring the room temperature to user-setting level.
- If you do not like AUTO operation, you can manually select the operation mode and setting you like.

■ Note on air flow rate setting

- At smaller air flow rates, the cooling (heating) effect is also smaller.

2.3 Adjusting the Airflow Direction

Adjusting the Air Flow Direction

You can adjust the air flow direction to increase your comfort.

■ To adjust the horizontal blade (flap)

1. Press “SWING button”.

- “” is displayed on the LCD and the flaps will begin to swing.

2. When the flaps have reached the desired position, press “SWING button” once more.

- The flap will stop moving.
- “” disappears from the LCD.

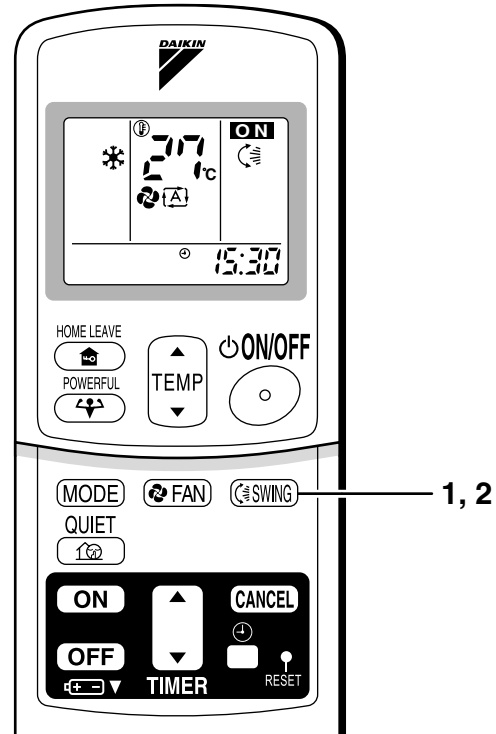

■ To adjust the vertical blades (louvers)

- When adjusting the louver, use a robust and stable stool and watch your steps carefully.
Hold the knob and move the louvers.
(You will find a knob on the left side and the right side blades.)

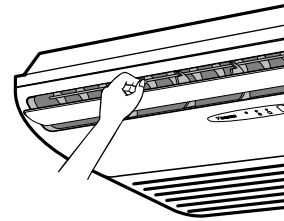

Notes on flap and louvers angles.

- Unless [SWING] is selected, you should set the flap at a near- horizontal angle in COOL or DRY mode to obtain the best performance.
- In COOL or DRY mode, if the flap is fixed at a downward position, the flap automatically moves in about 60 minutes to prevent condensation on it.

■ ATTENTION

- Always use a remote controller to adjust the flap angle.
If you attempt to move it forcibly with hand when it is swinging, the mechanism may be broken.
- Be careful when adjusting the louvers. Inside the air outlet, a fan is rotating at a high speed.

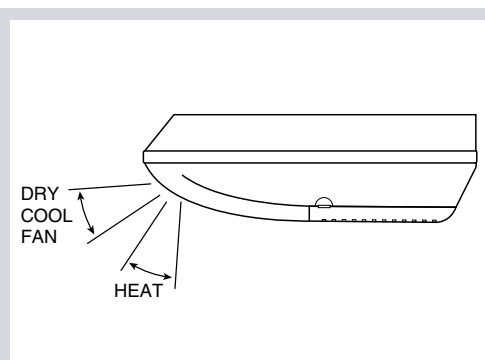

2.4 POWERFUL Operation

POWERFUL Operation

POWERFUL operation quickly maximizes the cooling (heating) effect in any operation mode. You can get the maximum capacity .

■ To start POWERFUL operation

1. Press “POWERFUL button”.

- POWERFUL operation ends in 20 minutes. Then the system automatically operates again with the settings which were used before POWERFUL operation.
- When using POWERFUL operation, there are some functions which are not available.
- “” is displayed on the LCD.

■ To cancel POWERFUL operation

2. Press “POWERFUL button” again.

- “” disappears from the LCD.

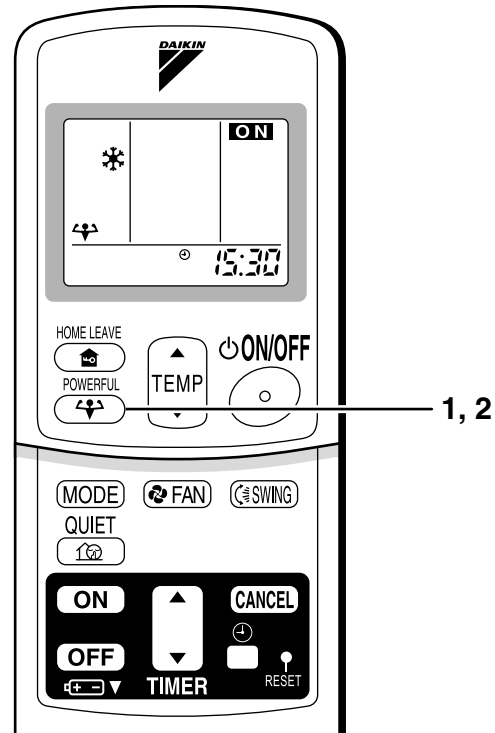

NOTE

■ Notes on POWERFUL operation

• In COOL and HEAT mode

To maximize the cooling (heating) effect, the capacity of outdoor unit must be increased and the air flow rate be fixed to the maximum setting. The temperature and air flow settings are not variable.

• In DRY mode

The temperature setting is lowered by 2.5°C and the air flow rate is slightly increased.

• In FAN mode

The air flow rate is fixed to the maximum setting.

2.5 OUTDOOR UNIT QUIET Operation

OUTDOOR UNIT QUIET Operation

OUTDOOR UNIT QUIET operation lowers the noise level of the outdoor unit by changing the frequency and fan speed on the outdoor unit. This function is convenient during night.

■ To start OUTDOOR UNIT QUIET operation

1. Press “QUIET button”.

- “” is displayed on the LCD.

■ To cancel OUTDOOR UNIT QUIET operation

2. Press “QUIET button” again.

- “” disappears from the LCD.

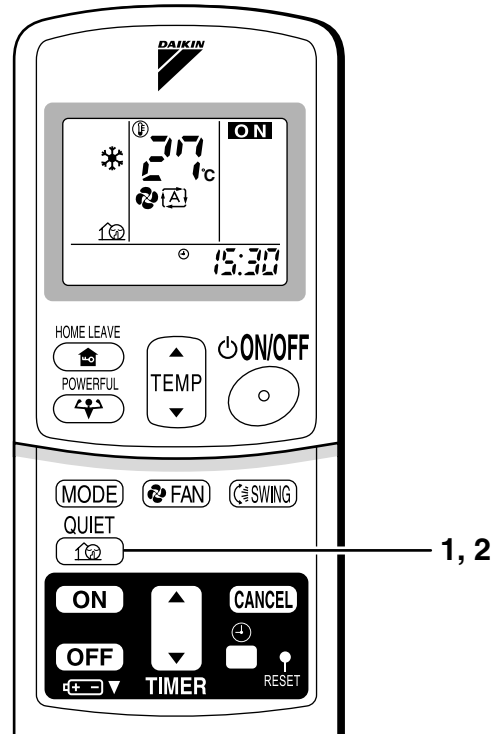

NOTE

■ Note on OUTDOOR UNIT QUIET operation

- This function is available in COOL, HEAT, and AUTO modes. (This is not available in FAN and DRY mode.)
- POWERFUL operation and OUTDOOR UNIT QUIET operation cannot be used at the same time. Priority is given to the function of whichever button is pressed last.
- If operation is stopped using the remote controller or the main unit ON/OFF switch when using OUTDOOR UNIT QUIET operation, “” will remain on the remote controller display.

2.6 HOME LEAVE Operation

HOME LEAVE Operation

HOME LEAVE operation is a function which allows you to record your preferred temperature and air flow rate settings.

■ To start HOME LEAVE operation

1. Press “HOME LEAVE button” .
 - The HOME LEAVE lamp lights up.

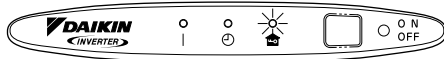

■ To cancel HOME LEAVE operation

2. Press “HOME LEAVE button” again.
 - The HOME LEAVE lamp goes off.

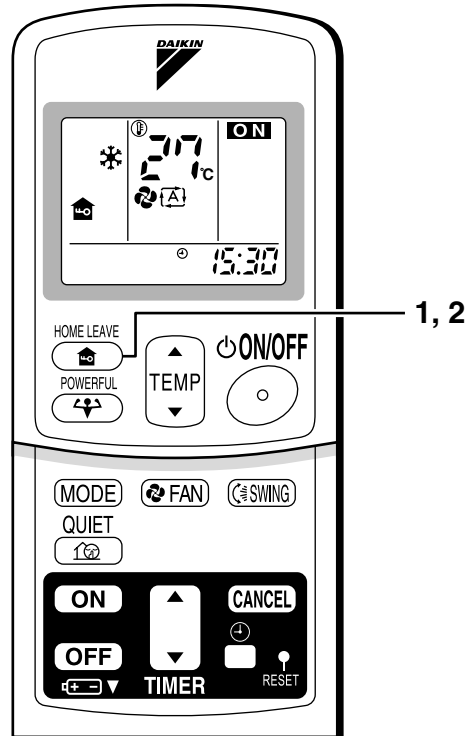

Before using HOME LEAVE operation.

■ To set the temperature and air flow rate for HOME LEAVE operation

When using HOME LEAVE operation for the first time, please set the temperature and air flow rate for HOME LEAVE operation. Record your preferred temperature and air flow rate.

	Initial setting		Selectable range	
	temperature	Air flow rate	temperature	Air flow rate
Cooling	25°C	“”	18-32°C	5 step, “” and “”
Heating	25°C	“”	10-30°C	5 step, “” and “”

1. Press “HOME LEAVE button”. Make sure “” is displayed in the remote controller display.
2. Adjust the set temperature with “” or “” as you like.
3. Adjust the air flow rate with “FAN” setting button as you like.

Home leave operation will run with these settings the next time you use the unit. To change the recorded information, repeat steps 1 – 3.

■ What's the HOME LEAVE operation?

Is there a set temperature and air flow rate which is most comfortable, a set temperature and air flow rate which you use the most? HOME LEAVE operation is a function that allows you to record your favorite set temperature and air flow rate. You can start your favorite operation mode simply by pressing the HOME LEAVE button on the remote controller. This function is convenient in the following situations.

■ Useful in these cases

1. Use as an energy-saving mode.

Set the temperature 2-3°C higher (cooling) or lower (heating) than normal. Setting the fan strength to the lowest setting allows the unit to be used in energy-saving mode. Also convenient for use while you are out or sleeping.

• Every day before you leave the house...

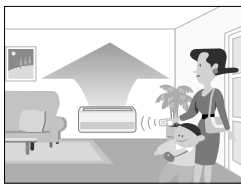

When you go out, push the "HOME LEAVE Operation" button, and the air conditioner will adjust capacity to reach the preset temperature for HOME LEAVE Operation.

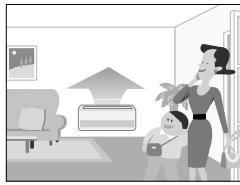

When you return, you will be welcomed by a comfortably air conditioned room.

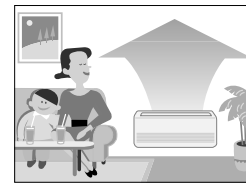

Push the "HOME LEAVE Operation" button again, and the air conditioner will adjust capacity to the set temperature for normal operation.

• Before bed...

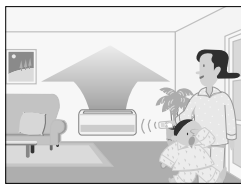

Set the unit to HOME LEAVE Operation before leaving the living room when going to bed.

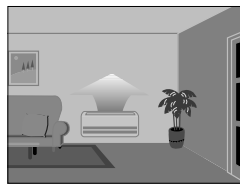

The unit will maintain the temperature in the room at a comfortable level while you sleep.

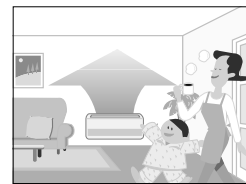

When you enter the living room in the morning, the temperature will be just right. Disengaging HOME LEAVE Operation will return the temperature to that set for normal operation. Even the coldest winters will pose no problem!

2. Use as a favorite mode.

Once you record the temperature and air flow rate settings you most often use, you can retrieve them by pressing HOME LEAVE button. You do not have to go through troublesome remote control operations.

NOTE

- Once the temperature and air flow rate for HOME LEAVE operation are set, those settings will be used whenever HOME LEAVE operation is used in the future. To change these settings, please refer to the "Before using HOME LEAVE operation" section above.
- HOME LEAVE operation is only available in COOL and HEAT mode. Cannot be used in AUTO, DRY, and FAN mode.
- HOME LEAVE operation runs in accordance with the previous operation mode (COOL or HEAT) before using HOME LEAVE operation.
- HOME LEAVE operation and POWERFUL operation cannot be used at the same time. Last button that was pressed has priority.
- The operation mode cannot be changed while HOME LEAVE operation is being used.
- When operation is shut off during HOME LEAVE operation, using the remote controller or the indoor unit ON/OFF switch, "🏠" will remain on the remote controller display.

2.7 TIMER Operation

TIMER Operation

Timer functions are useful for automatically switching the air conditioner on or off at night or in the morning. You can also use OFF TIMER and ON TIMER in combination.

■ To use OFF TIMER operation

- Check that the clock is correct.
If not, set the clock to the present time.

1. Press “OFF TIMER button”.

0:00 is displayed.

⊕-⊖ blinks.

2. Press “TIMER Setting button” until the time setting reaches the point you like.

- Every pressing of either button increases or decreases the time setting by 10 minutes. Holding down either button changes the setting rapidly.

3. Press “OFF TIMER button” again.

- The TIMER lamp lights up.

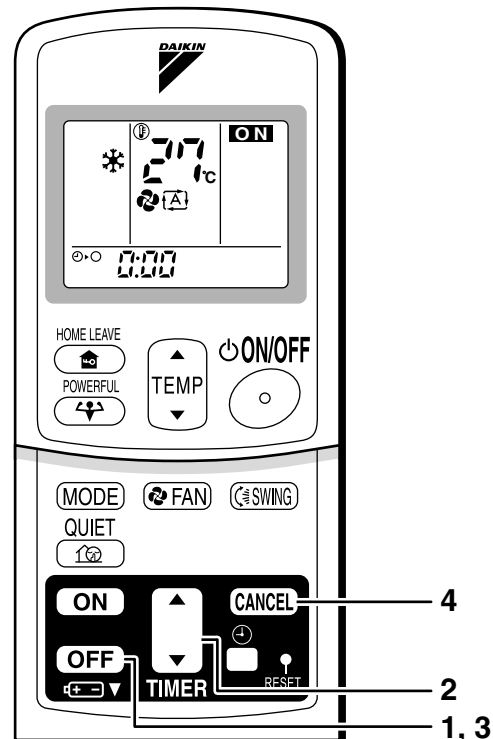
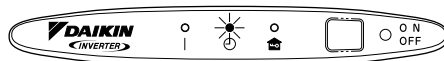

■ To cancel the OFF TIMER operation

4. Press “CANCEL button”.

- The TIMER lamp goes off.

NOTE

- When TIMER is set, the present time is not displayed.
- Once you set ON, OFF TIMER, the time setting is kept in the memory. (The memory is canceled when remote controller batteries are replaced.)
- When operating the unit via the ON/OFF Timer, the actual length of operation may vary from the time entered by the user. (Maximum approx. 10 minutes)

■ NIGHT SET MODE

When the OFF TIMER is set, the air conditioner automatically adjusts the temperature setting (0.5°C up in COOL, 2.0°C down in HEAT) to prevent excessive cooling (heating) for your pleasant sleep.

■ To use ON TIMER operation

- Check that the clock is correct. If not, set the clock to the present time

1. Press “ON TIMER button”.

6:00 is displayed.

⊕·| blinks.

2. Press “TIMER Setting button” until the time setting reaches the point you like.

- Every pressing of either button increases or decreases the time setting by 10 minutes. Holding down either button changes the setting rapidly.

3. Press “ON TIMER button” again.

- The TIMER lamp lights up.

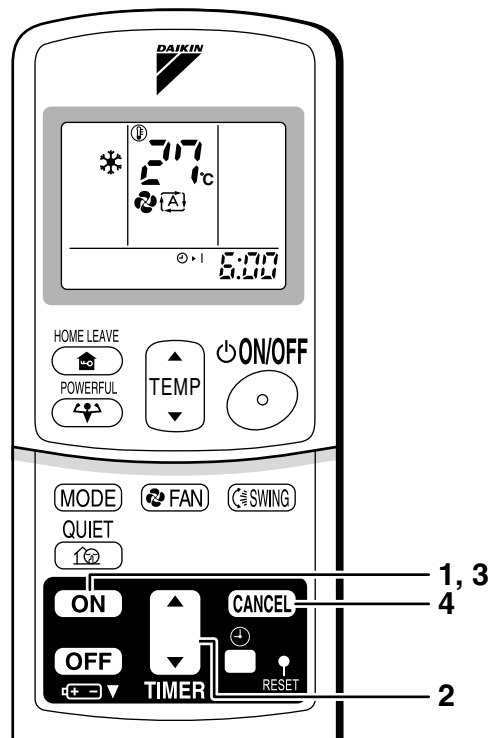
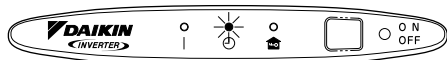

■ To cancel ON TIMER operation

4. Press “CANCEL button”.

- The TIMER lamp goes off.

■ To combine ON TIMER and OFF TIMER

- A sample setting for combining the two timers is shown below.

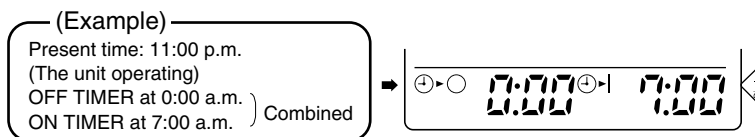

ATTENTION

■ In the following cases, set the timer again.

- After a breaker has turned OFF.
- After a power failure.
- After replacing batteries in the remote controller.

Part 6

Service Diagnosis

1. Caution for Diagnosis.....	63
1.1 Troubleshooting with LED	63
2. Problem Symptoms and Measures	64
2.1 ARC433 Series.....	65
3. Troubleshooting	68
3.1 Error Codes and Description	68
3.2 Indoor Unit PCB Abnormality	69
3.3 Freeze-up Protection Control or Heating Peak-cut Control.....	70
3.4 Fan Motor (AC Motor) or Related Abnormality.....	72
3.5 Thermistor or Related Abnormality (Indoor Unit).....	73
3.6 Signal Transmission Error (between Indoor Unit and Outdoor Unit)	74
3.7 Unspecified Voltage (between Indoor Unit and Outdoor Unit)	75
3.8 Outdoor Unit PCB Abnormality.....	76
3.9 OL Activation (Compressor Overload)	77
3.10 Compressor Lock	78
3.11 DC Fan Lock	79
3.12 Input Overcurrent Detection	80
3.13 Four Way Valve Abnormality	81
3.14 Discharge Pipe Temperature Control.....	83
3.15 High Pressure Control in Cooling	84
3.16 Compressor System Sensor Abnormality	85
3.17 Position Sensor Abnormality	86
3.18 DC Voltage / Current Sensor Abnormality.....	88
3.19 Thermistor or Related Abnormality (Outdoor Unit).....	89
3.20 Electrical Box Temperature Rise.....	91
3.21 Radiation Fin Temperature Rise	94
3.22 Output Overcurrent Detection	97
3.23 Refrigerant Shortage	99
3.24 Low-voltage Detection or Over-voltage Detection.....	101
4. Check	103
4.1 How to Check.....	103

1. Caution for Diagnosis

1.1 Troubleshooting with LED

Indoor Unit

The operation lamp blinks when any of the following errors is detected.

1. When a protection device of the indoor or outdoor unit is activated, or when the thermistor malfunctions.
 2. When a signal transmission error occurs between the indoor and outdoor units.
- In either case, conduct the diagnostic procedure described in the following pages.

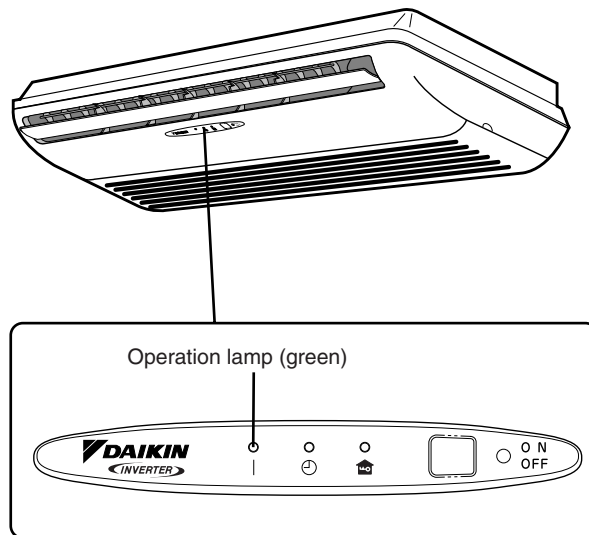

(R2974)

Outdoor Unit

The outdoor unit has one green LED (LED A) on the PCB. When the LED A blinks, the microcomputer works in order.

2. Problem Symptoms and Measures

Symptom	Check Item	Details of Measure	Reference Page
The units does not operate.	Check the power supply.	Check to make sure that the rated voltage is supplied.	—
	Check the type of the indoor units.	Check to make sure that the indoor unit type is compatible with the outdoor unit.	—
	Check the outdoor temperature.	Heating operation cannot be used when the outdoor temperature is 20°C or higher, and cooling operation cannot be used when the outdoor temperature is below -10°C.	—
	Diagnose with remote controller indication.	—	68
	Check the remote controller addresses.	Check to make sure that address settings for the remote controller and indoor unit are correct.	—
Operation sometimes stops.	Check the power supply.	A power failure of 2 to 10 cycles stops air conditioner operation. (Operation lamp OFF)	—
	Check the outdoor temperature.	Heating operation cannot be used when the outdoor temperature is 20°C or higher, and cooling operation cannot be used when the outdoor temperature is below -10°C.	—
	Diagnose with remote controller indication.	—	68
The unit operates but does not cool, or does not heat.	Check for wiring and piping errors in the connection between the indoor and outdoor units.	Conduct the wiring / piping error check described on the product diagnosis label.	—
	Check for thermistor detection errors.	Check to make sure that the thermistor is mounted securely.	—
	Check for faulty operation of the electronic expansion valve.	Set the units to cooling operation, and check the temperature of the liquid pipe to see if the electronic expansion valve works.	—
	Diagnose with remote controller indication.	—	68
	Diagnose by service port pressure and operating current.	Check for refrigerant shortage.	99
Large operating noise and vibrations	Check the output voltage of the power module.	—	108
	Check the power module.	—	—
	Check the installation condition.	Check to make sure that the required spaces for installation (specified in the installation manual, etc.) are provided.	—

2.1 ARC433 Series

- Check Method 1**
- When the timer cancel button is held down for 5 seconds, "00" indication appears on the temperature display section.

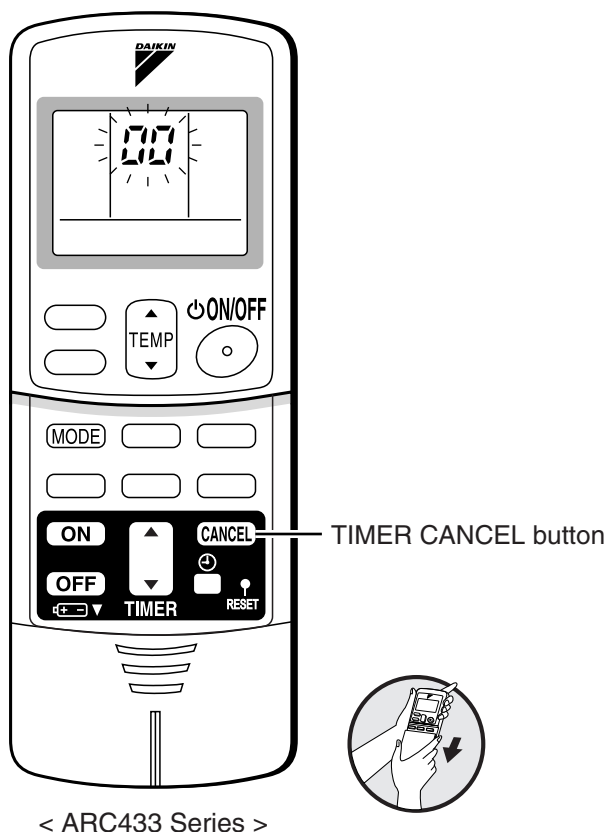

(R11949)

- Press the timer cancel button repeatedly until a long beep sounds.
 - The code indication changes in the sequence shown below.

No.	Code	No.	Code	No.	Code
1	00	12	07	23	40
2	04	13	08	24	41
3	03	14	03	25	44
4	08	15	03	26	43
5	15	16	01	27	44
6	06	17	04	28	46
7	05	18	05	29	47
8	08	19	09	30	42
9	09	20	06	31	44
10	00	21	08	32	48
11	07	22	05	33	44

**Note:**

- A short beep "pi" and two consecutive beeps "pi pi" indicate non-corresponding codes.
- To return to the normal mode, hold the timer cancel button down for 5 seconds. When the remote controller is left untouched for 60 seconds, it also returns to the normal mode.

Check Method 2

1. Press the center of the TEMP button and the MODE button at the same time.

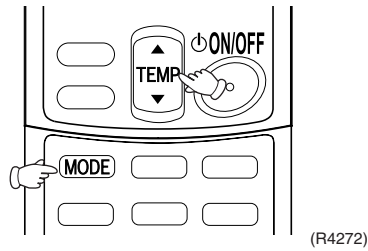

The figure of the ten's place blinks.

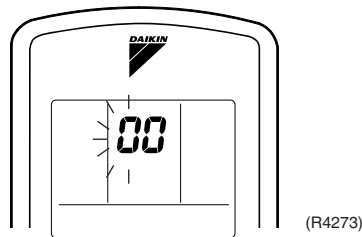

2. Press the TEMP▲ or ▼ button and change the figure until you hear the sound of “beep” or “pi pi”.

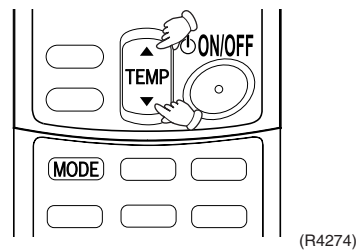

3. Diagnose by the sound.
 - ★“pi” : The figure of the ten's place does not accord with the error code.
 - ★“pi pi” : The figure of the ten's place accords with the error code but the one's not.
 - ★“beep” : The both figures of the ten's and one's place accord with the error code.

The figures indicated when you hear the “beep” sound are error code.
 (Error codes and description → Refer to page 68.)

4. Press the MODE button.

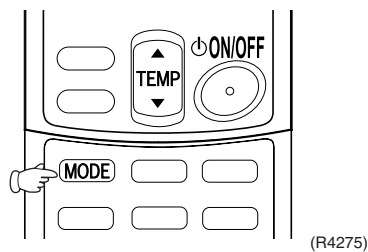

The figure of the one's place blinks.

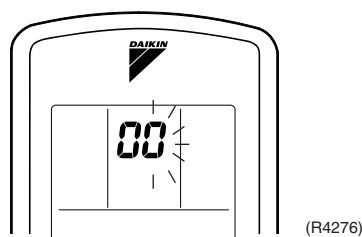

5. Press the TEMP▲ or ▼ button and change the figure until you hear the sound of “beep”.

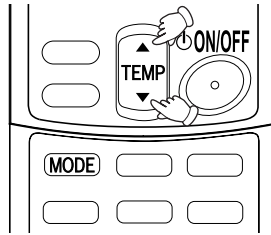

(R4277)

6. Diagnose by the sound.
- ★“pi” : The figure of the ten’s place does not accord with the error code.
 - ★“pi pi” : The figure of the ten’s place accords with the error code but the one’s not.
 - ★“beep” : The both figures of the ten’s and one’s place accord with the error code.

7. Determine the error code.

The figures indicated when you hear the “beep” sound are error code.
(Error codes and description → Refer to page 68.)

8. Press the MODE button to exit from the diagnosis mode.

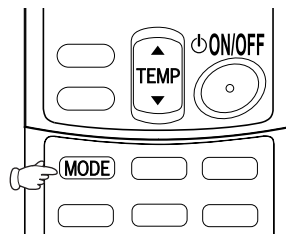

(R4278)

The display “ 7 - ” means the trial operation mode.
(Refer to page 208 for trial operation.)

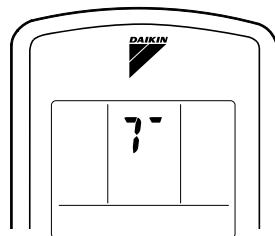

(R9669)

9. Press the ON/OFF button twice to return to the normal mode.

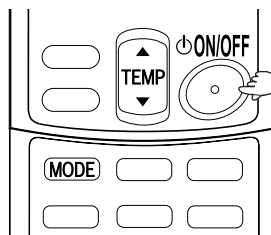

(R9670)



Note: When the remote controller is left untouched for 60 seconds, it returns to the normal mode.

3. Troubleshooting

3.1 Error Codes and Description

	Error Codes	Description	Reference Page
System	00	Normal	—
	U0★	Refrigerant shortage	99
	U2	Low-voltage detection or over-voltage detection	101
	U4	Signal transmission error (between indoor unit and outdoor unit)	74
	U8	Unspecified voltage (between indoor unit and outdoor unit)	75
Indoor Unit	R1	Indoor unit PCB abnormality	69
	R5	Freeze-up protection control or heating peak-cut control	70
	R6	Fan motor (AC motor) or related abnormality	72
	C4	Indoor heat exchanger thermistor or related abnormality	73
	C9	Room temperature thermistor or related abnormality	73
Outdoor Unit	E1	Outdoor unit PCB abnormality	76
	E5★	OL activation (compressor overload)	77
	E6★	Compressor lock	78
	E7	DC fan lock	79
	E8	Input overcurrent detection	80
	E9	Four way valve abnormality	81
	F3	Discharge pipe temperature control	83
	F6	High pressure control in cooling	84
	H0	Compressor system sensor abnormality	85
	H6	Position sensor abnormality	86
	H8	DC voltage / current sensor abnormality	88
	H9	Outdoor temperature thermistor or related abnormality	89
	J3	Discharge pipe thermistor or related abnormality	89
	J5	Outdoor heat exchanger thermistor or related abnormality	89
	L3	Electrical box temperature rise	91
	L4	Radiation fin temperature rise	94
	L5	Output overcurrent detection	97
	P4	Radiation fin thermistor or related abnormality	89

★: Displayed only when system-down occurs.

3.2 Indoor Unit PCB Abnormality

Remote Controller Display	A1
Method of Malfunction Detection	Evaluation of zero-cross detection of power supply by the indoor unit PCB.
Malfunction Decision Conditions	There is no zero-cross detection in approximately 10 seconds.
Supposed Causes	<ul style="list-style-type: none"> ■ Wrong models interconnected ■ Defective indoor unit PCB ■ Disconnection of connector

Troubleshooting

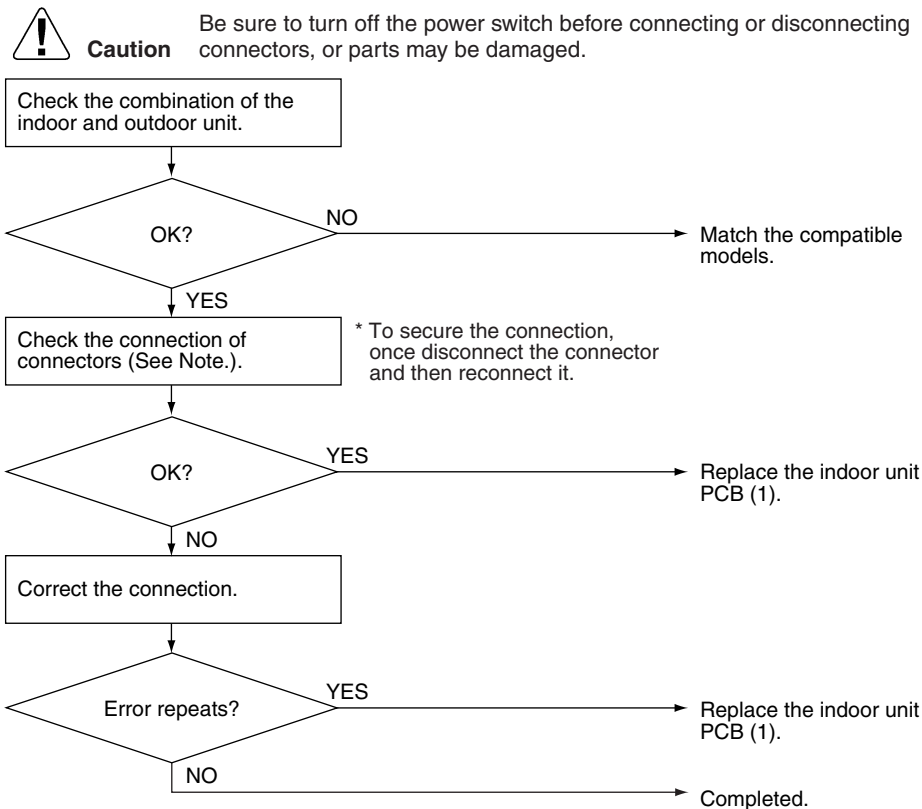

(R11704)

 **Note:** Check the following connector.

Model Type	Connector
Floor / ceiling suspended dual type	S36~S37

3.3 Freeze-up Protection Control or Heating Peak-cut Control

<p>Remote Controller Display</p>	<p>85</p>
<p>Method of Malfunction Detection</p>	<ul style="list-style-type: none"> ■ Freeze-up protection control During cooling operation, the freeze-up protection control (operation halt) is activated according to the temperature detected by the indoor heat exchanger thermistor. ■ Heating peak-cut control During heating operation, the temperature detected by the indoor heat exchanger thermistor is used for the heating peak-cut control (operation halt, outdoor fan stop, etc.)
<p>Malfunction Decision Conditions</p>	<ul style="list-style-type: none"> ■ Freeze-up protection control During cooling operation, the indoor heat exchanger temperature is below 0°C. ■ Heating peak-cut control During heating operation, the indoor heat exchanger temperature is above 65°C
<p>Supposed Causes</p>	<ul style="list-style-type: none"> ■ Short-circuited air ■ Clogged air filter of the indoor unit ■ Dust accumulation on the indoor heat exchanger ■ Defective indoor heat exchanger thermistor ■ Defective indoor unit PCB

Troubleshooting



Check No.06
Refer to P.105

**Caution**

Be sure to turn off the power switch before connecting or disconnecting connectors, or parts may be damaged.

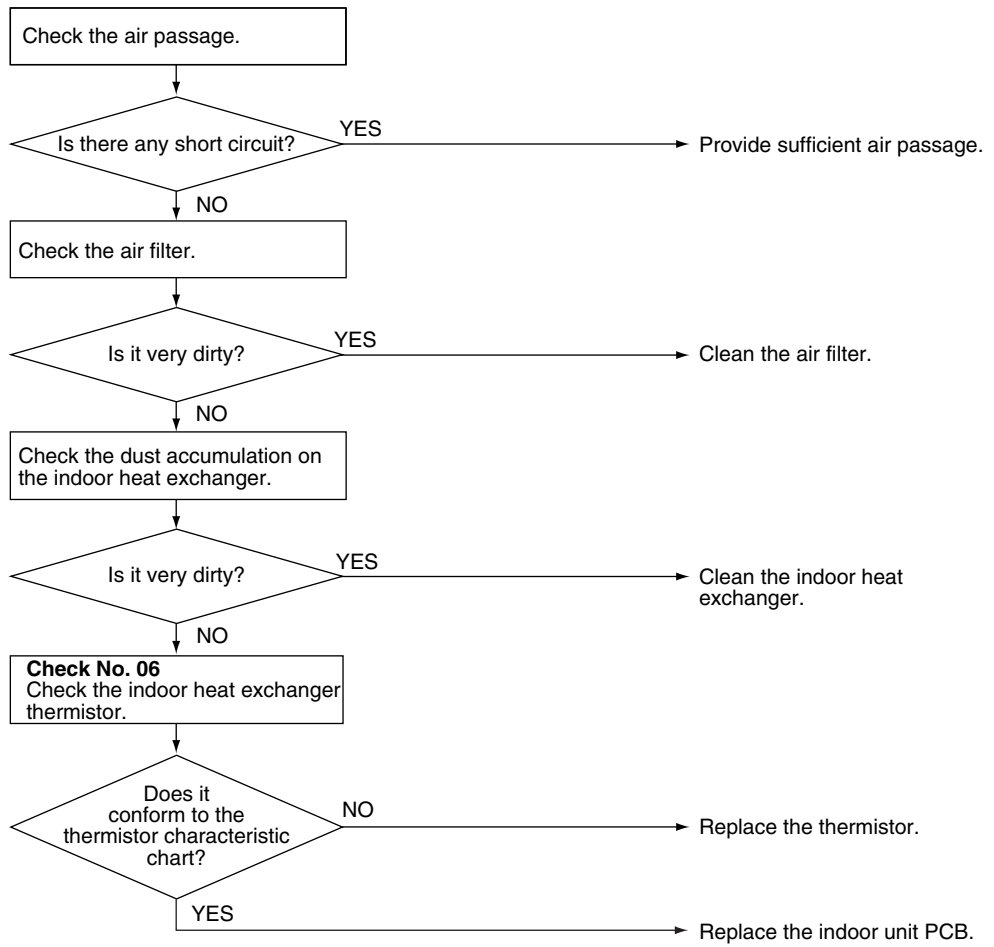

(R7131)

3.4 Fan Motor (AC Motor) or Related Abnormality

Remote
Controller
Display



Method of
Malfunction
Detection

The rotation speed detected by the Hall IC during fan motor operation is used to determine abnormal fan motor operation.

Malfunction
Decision
Conditions

The detected rotation speed does not reach the demanded rotation speed of the target tap, and is less than 50% of the maximum fan motor rotation speed.

Supposed
Causes

- Layer short inside the fan motor winding
- Breaking of wire inside the fan motor
- Breaking of the fan motor lead wires
- Defective capacitor of the fan motor
- Defective indoor unit PCB

Troubleshooting



Check No.16
Refer to P.110

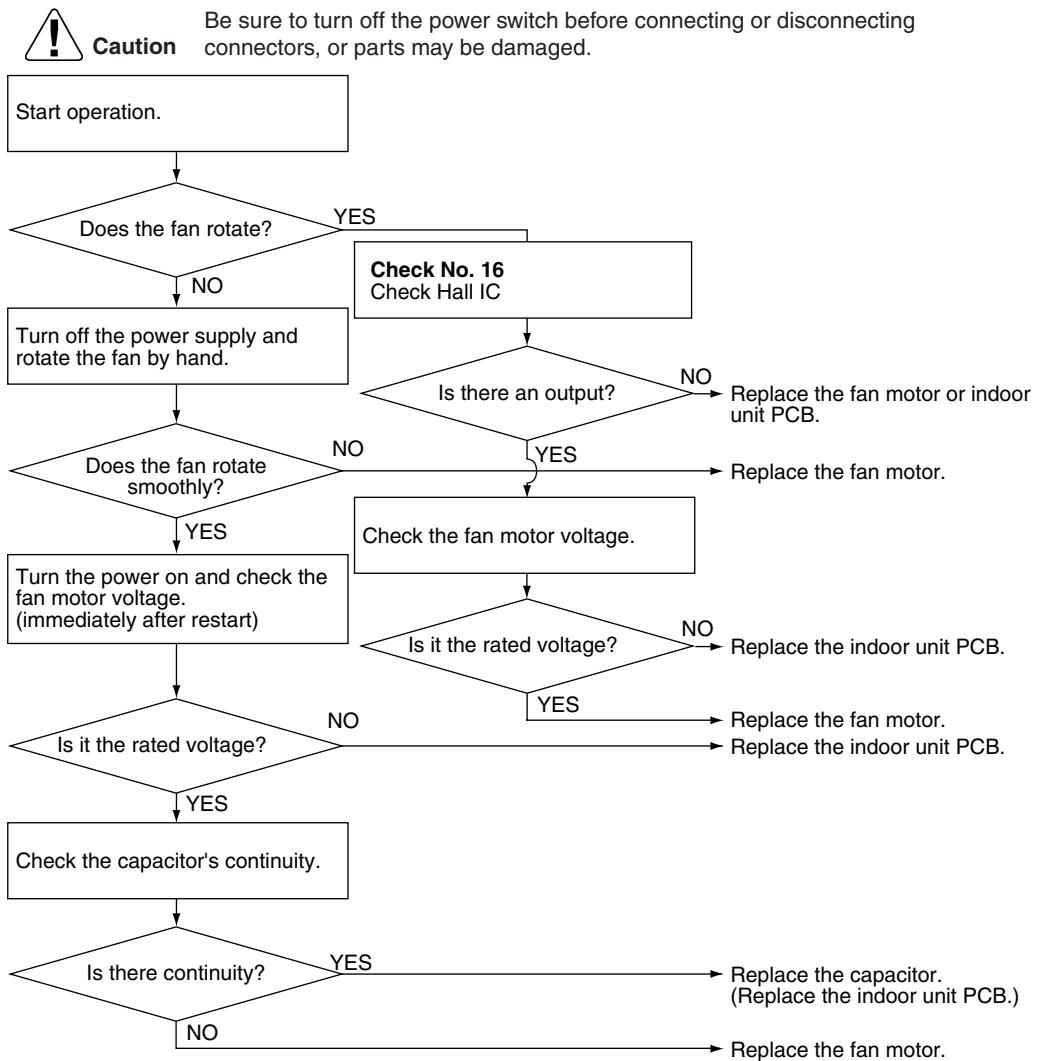

(R3869)

3.5 Thermistor or Related Abnormality (Indoor Unit)

Remote
Controller
Display

Ⓔ4, Ⓔ9

Method of
Malfunction
Detection

The temperatures detected by the thermistors determine thermistor errors.

Malfunction
Decision
Conditions

The thermistor input is more than 4.96 V or less than 0.04 V during compressor operation.

Supposed
Causes

- Disconnection of connector
- Defective thermistor
- Defective indoor unit PCB

Troubleshooting



Check No.06
Refer to P.105



Caution

Be sure to turn off the power switch before connecting or disconnecting connectors, or parts may be damaged.

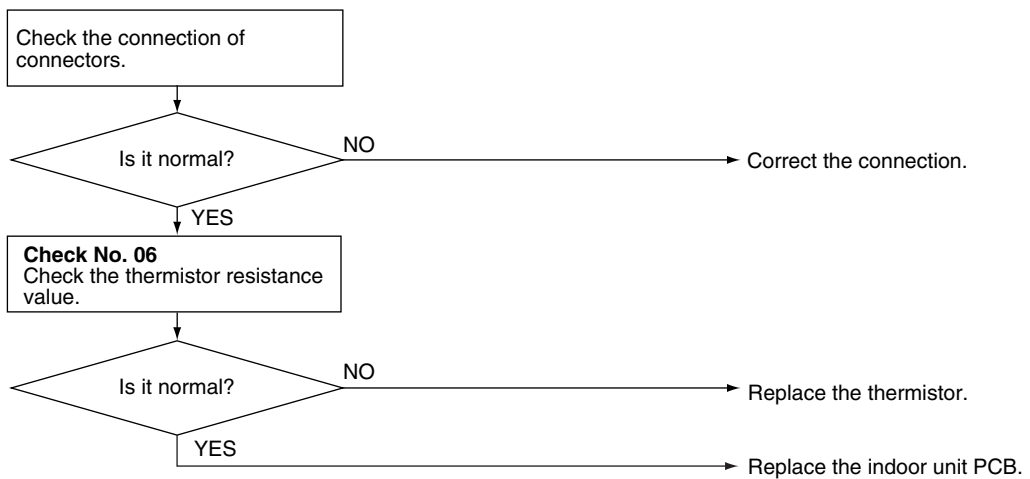

(R7134)

Ⓔ4 : Indoor heat exchanger thermistor

Ⓔ9 : Room temperature thermistor

3.6 Signal Transmission Error (between Indoor Unit and Outdoor Unit)

Remote Controller Display



Method of Malfunction Detection

The data received from the outdoor unit in indoor unit-outdoor unit signal transmission is checked whether it is normal.

Malfunction Decision Conditions

The data sent from the outdoor unit cannot be received normally, or the content of the data is abnormal.

Supposed Causes

- Wiring error
- Breaking of the connection wires between the indoor and outdoor units (wire No. 3)
- Defective outdoor unit PCB
- Defective indoor unit PCB
- Disturbed power supply waveform

Troubleshooting

Check No.10
Refer to P.107

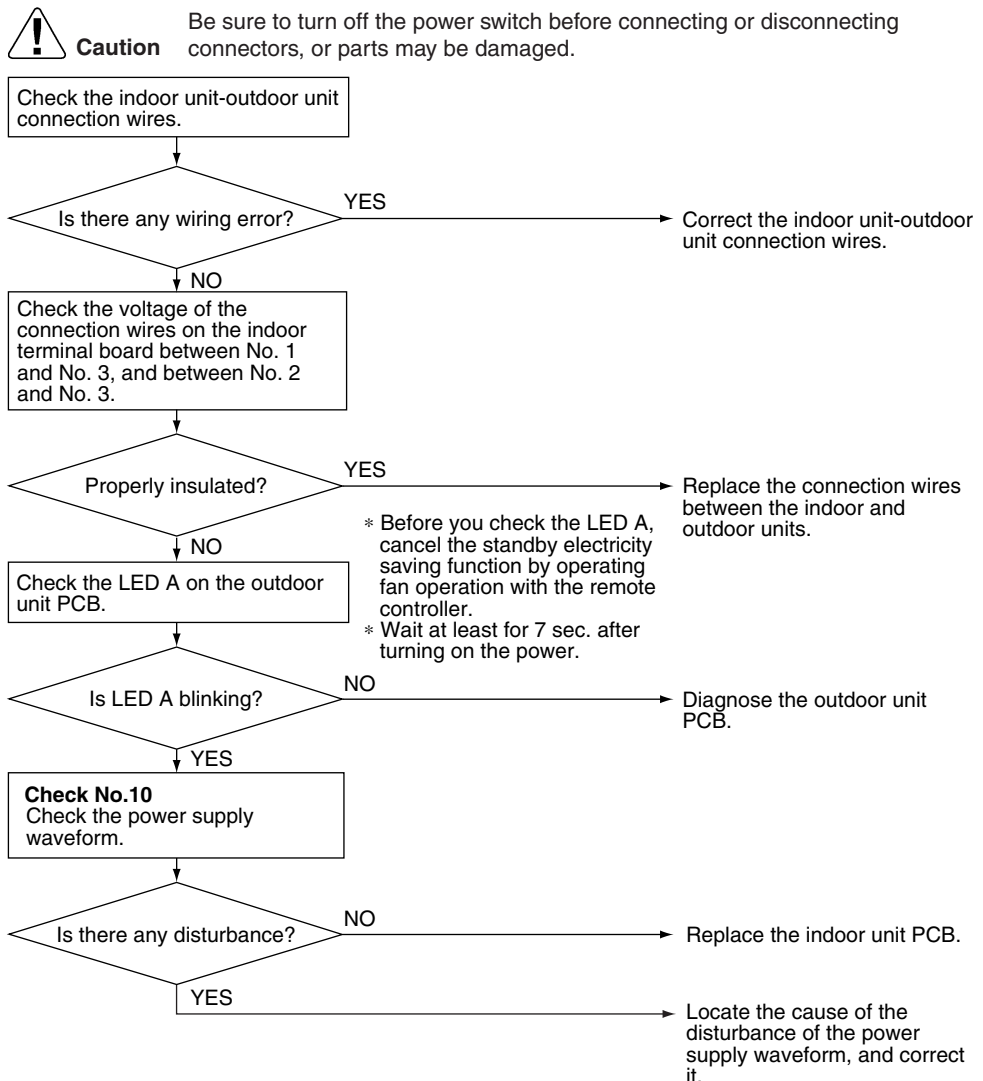

(R12160)

3.7 Unspecified Voltage (between Indoor Unit and Outdoor Unit)

Remote
Controller
Display

UR

Method of
Malfunction
Detection

The supply power is detected for its requirements (different from pair type and multi type) by the indoor / outdoor transmission signal.

Malfunction
Decision
Conditions

The pair type and multi type are interconnected.

Supposed
Causes

- Wrong models interconnected
- Wrong wiring of connecting wires
- Wrong indoor unit PCB or outdoor unit PCB mounted
- Defective indoor unit PCB
- Defective outdoor unit PCB

Troubleshooting

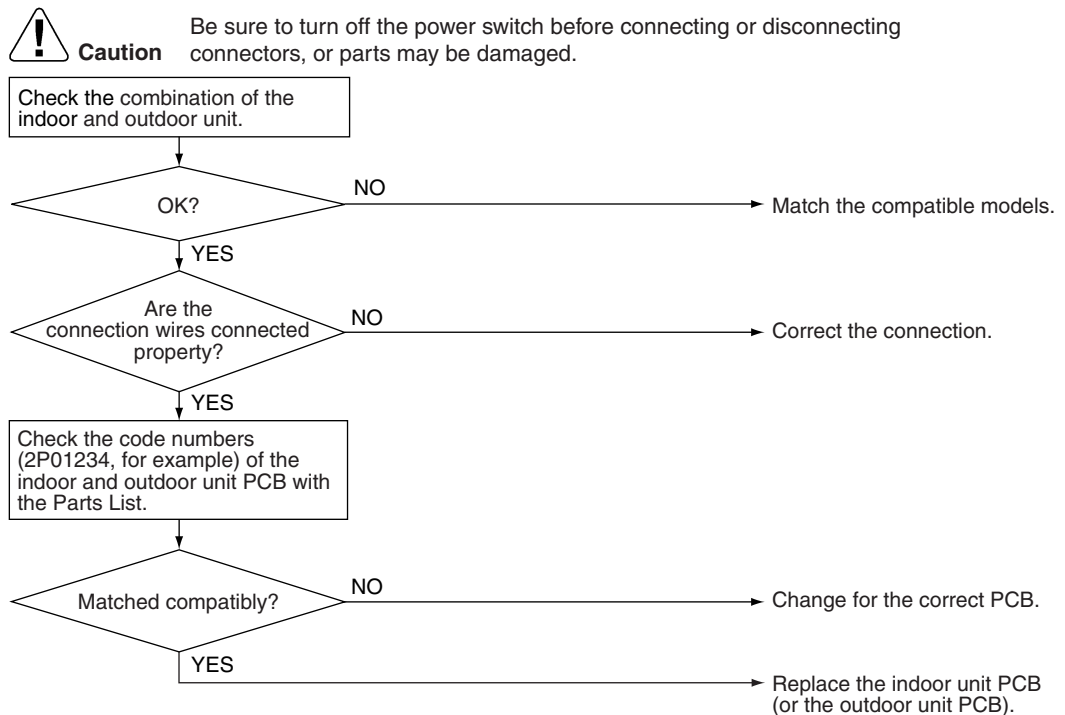

(R11707)

3.8 Outdoor Unit PCB Abnormality

Remote Controller Display	E1
Method of Malfunction Detection	<ul style="list-style-type: none"> ■ The system follows the microprocessor program as specified. ■ The system checks to see if the zero-cross signal comes in properly.
Malfunction Decision Conditions	<ul style="list-style-type: none"> ■ The microprocessor program runs out of control. ■ The zero-cross signal is not detected.
Supposed Causes	<ul style="list-style-type: none"> ■ Defective outdoor unit PCB ■ Broken harness between PCBs ■ Noise ■ Momentary fall of voltage ■ Momentary power failure, etc

Troubleshooting

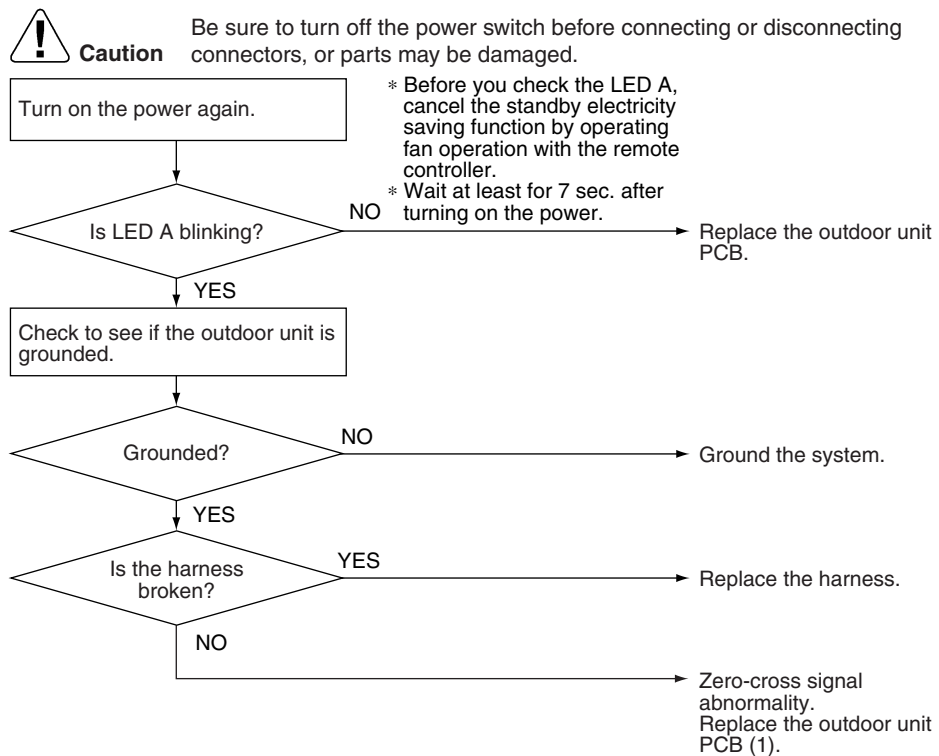

(R12161)

3.9 OL Activation (Compressor Overload)

Remote
Controller
Display



Method of
Malfunction
Detection

A compressor overload is detected through compressor OL.

Malfunction
Decision
Conditions

- If the error repeats twice, the system is shut down.
- Reset condition: Continuous run for about 60 minutes without any other error
- * The operating temperature condition is not specified.

Supposed
Causes

- Defective discharge pipe thermistor
- Defective electronic expansion valve or coil
- Defective four way valve or coil
- Defective outdoor unit PCB
- Refrigerant shortage
- Water mixed in refrigerant
- Defective stop valve

Troubleshooting



Check No.04
Refer to P.103



Check No.05
Refer to P.104



Check No.06
Refer to P.105



Check No.11
Refer to P.107



Caution

Be sure to turn off the power switch before connecting or disconnecting connectors, or parts may be damaged.

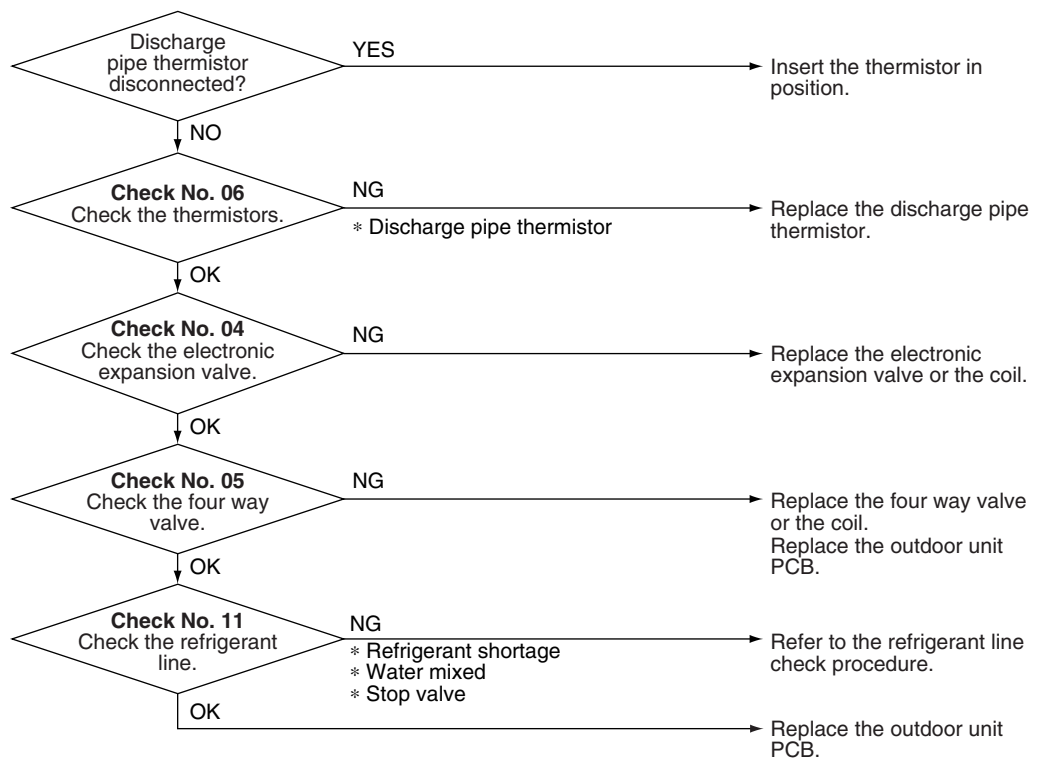

(R11999)

3.10 Compressor Lock

<p>Remote Controller Display</p> 	
<p>Method of Malfunction Detection</p>	<p>A compressor lock is detected by checking the compressor running condition through the position detection circuit.</p>
<p>Malfunction Decision Conditions</p>	<ul style="list-style-type: none"> ■ Operation stops due to overcurrent. ■ If the error repeats 16 times, the system is shut down. ■ Reset condition: Continuous run for about 11 minutes without any other error
<p>Supposed Causes</p>	<ul style="list-style-type: none"> ■ Compressor locked ■ Compressor harness disconnected

Troubleshooting

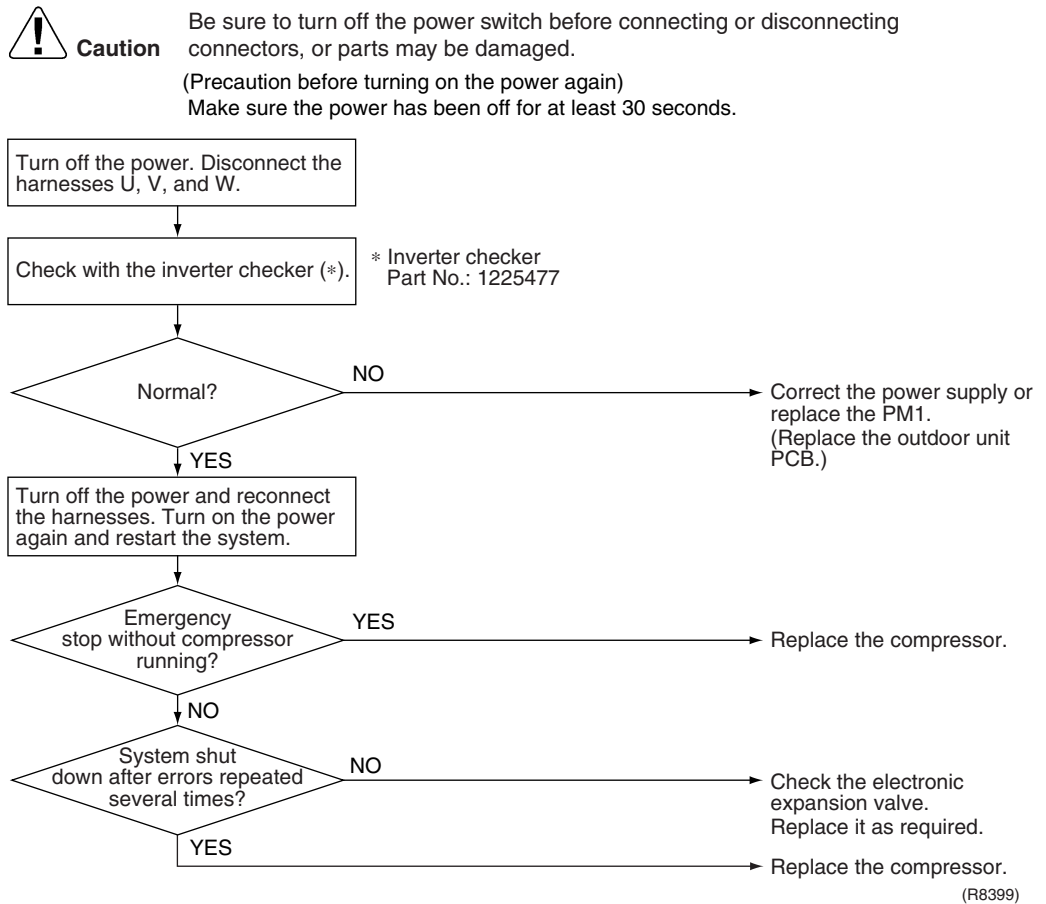

3.11 DC Fan Lock

Remote
Controller
Display

E7

Method of
Malfunction
Detection

An error is determined with the high-voltage fan motor rotation speed detected by the Hall IC.

Malfunction
Decision
Conditions

- The fan does not start in 15 ~ 60 seconds (depending on the model) even when the fan motor is running.
- If the error repeats 16 times, the system is shut down.
- Reset condition: Continuous run for about 11 minutes without any other error

Supposed
Causes

- Disconnection of the fan motor
- Foreign matters stuck in the fan
- Defective fan motor
- Defective outdoor unit PCB

Troubleshooting



Check No.15
Refer to P.109



Caution

Be sure to turn off the power switch before connecting or disconnecting connectors, or parts may be damaged.

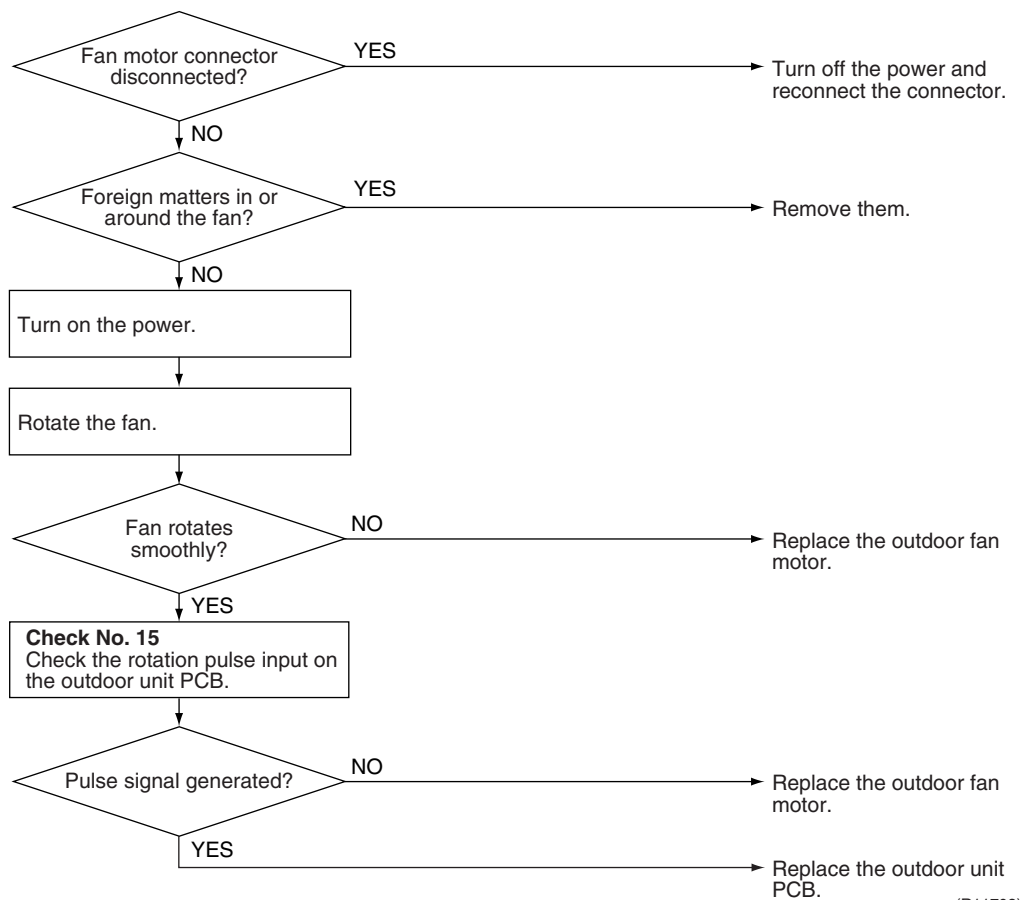

(R11708)

3.12 Input Overcurrent Detection

<p>Remote Controller Display</p>	
<p>Method of Malfunction Detection</p>	<p>An input overcurrent is detected by checking the input current value with the compressor running.</p>
<p>Malfunction Decision Conditions</p>	<ul style="list-style-type: none"> ■ The following current with the compressor running continues for 2.5 seconds. Cooling / Heating: Above 9.25 A (Refer to “Input current control” on page 40 for detail.)
<p>Supposed Causes</p>	<ul style="list-style-type: none"> ■ Defective compressor ■ Defective power module ■ Defective outdoor unit PCB ■ Short circuit

Troubleshooting

Check No.07
 Refer to P.106

Check No.08
 Refer to P.106

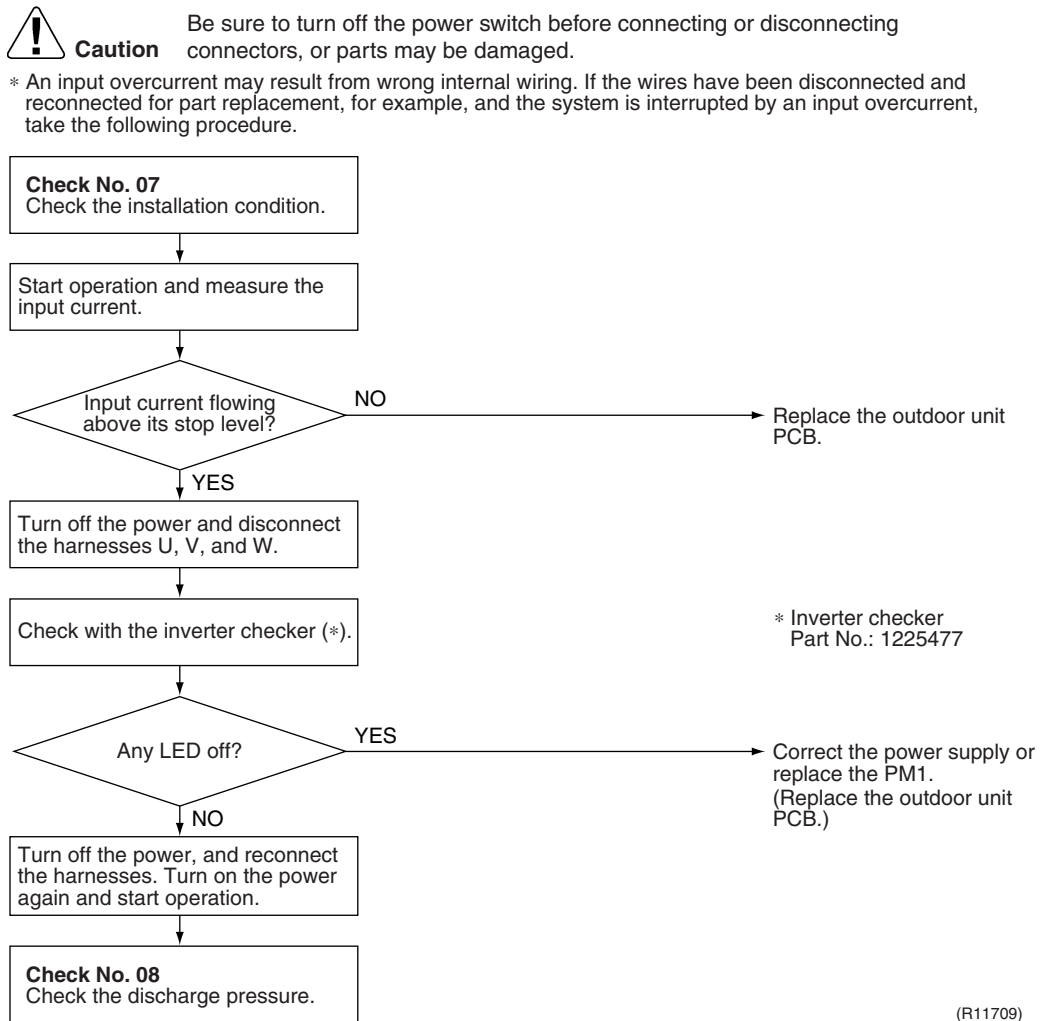

3.13 Four Way Valve Abnormality

Remote
Controller
Display

ER

Method of
Malfunction
Detection

The room temperature thermistor, the indoor heat exchanger thermistor, the outdoor temperature thermistor, and the outdoor heat exchanger thermistor are checked if they function within their normal ranges in each operation mode.

Malfunction
Decision
Conditions

- A following condition continues over 10 minutes after operating for 5 minutes.
- Cooling / Dry
(room thermistor temp. – indoor heat exchanger temp.) < -5°C
 - Heating
(indoor heat exchanger temp. – room thermistor temp.) < -5°C
 - If the error repeats, the system is shut down.
 - Reset condition: Continuous run for about 60 minutes without any other error

Supposed
Causes

- Disconnection of four way valve coil
- Defective four way valve, coil, or harness
- Defective outdoor unit PCB
- Defective thermistor
- Refrigerant shortage
- Water mixed in refrigerant
- Defective stop valve

Troubleshooting



Check No.05
Refer to P.104



Check No.06
Refer to P.105



Check No.11
Refer to P.107



Caution

Be sure to turn off the power switch before connecting or disconnecting connectors, or parts may be damaged.

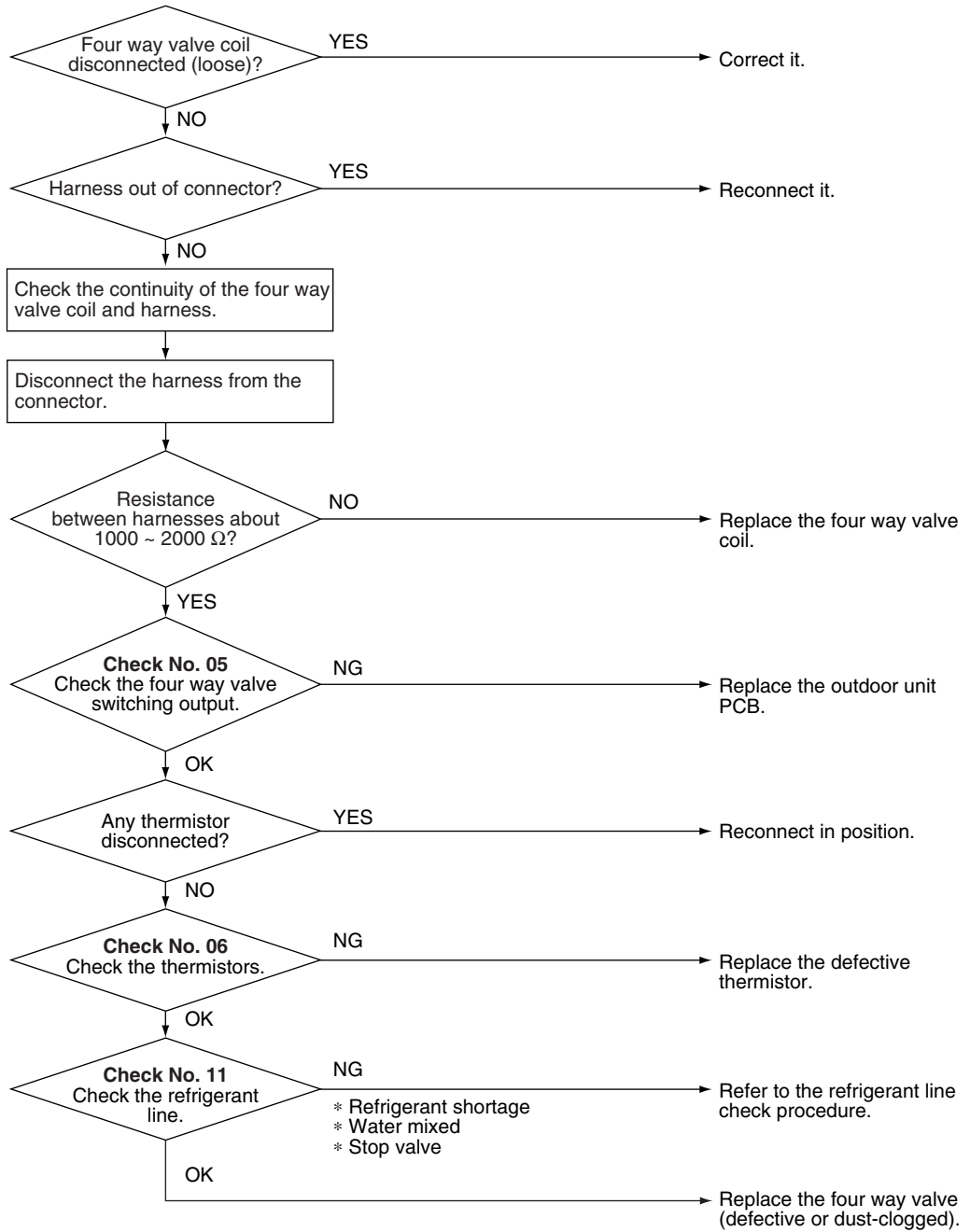

(R11710)

3.14 Discharge Pipe Temperature Control

Remote
Controller
Display



Method of
Malfunction
Detection

An error is determined with the temperature detected by the discharge pipe thermistor.

Malfunction
Decision
Conditions

- If the temperature detected by the discharge pipe thermistor rises above Δ °C, the compressor stops.
- The error is cleared when the discharge pipe temperature has dropped below B °C.

Stop temperatures	Δ (°C)	B (°C)
(1) above 45 Hz (rising), above 40 Hz (dropping)	110	97
(2) 30 ~ 45 Hz (rising), 25 ~ 40 Hz (dropping)	105	92
(3) below 30 Hz (rising), below 25 Hz (dropping)	99	86

- If the error repeats, the system is shut down.
- Reset condition: Continuous run for about 60 minutes without any other error

Supposed
Causes

- Defective discharge pipe thermistor
(Defective outdoor heat exchanger thermistor or outdoor temperature thermistor)
- Defective electronic expansion valve or coil
- Refrigerant shortage
- Defective four way valve
- Water mixed in refrigerant
- Defective stop valve
- Defective outdoor unit PCB

Troubleshooting

- Check No.04**
Refer to P.103
- Check No.06**
Refer to P.105
- Check No.11**
Refer to P.107

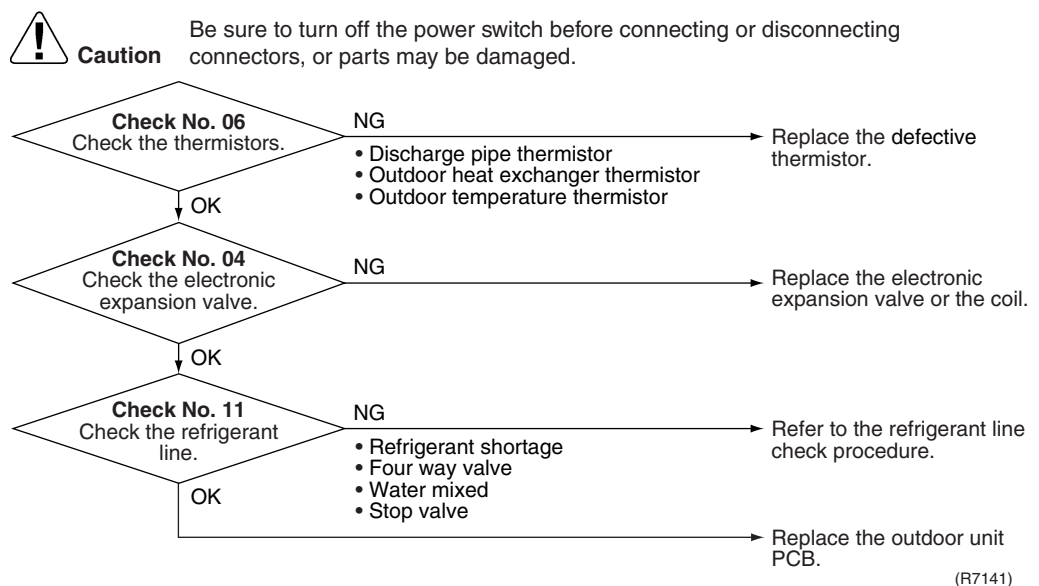

3.15 High Pressure Control in Cooling

Remote
Controller
Display



Method of
Malfunction
Detection

High-pressure control (operation halt, frequency drop, etc.) is activated in cooling operation if the temperature sensed by the outdoor heat exchanger thermistor exceeds the limit.

Malfunction
Decision
Conditions

- The temperature sensed by the outdoor heat exchanger thermistor rises above Δ °C.
- The error is cleared when the temperature drops below B °C.

	Δ (°C)	B (°C)
RK(X)S25/35E2V1B, RK(X)S25/35G2V1B	65	54
RK(X)S25/35G2V1B9	65	52

Supposed
Causes

- The installation space is not large enough.
- Dirty outdoor heat exchanger
- Defective outdoor fan motor
- Defective stop valve
- Defective electronic expansion valve or coil
- Defective outdoor heat exchanger thermistor
- Defective outdoor unit PCB

Troubleshooting

Check No.04
Refer to P.103

Check No.06
Refer to P.105

Check No.07
Refer to P.106

Check No.08
Refer to P.106

Check No.09
Refer to P.107

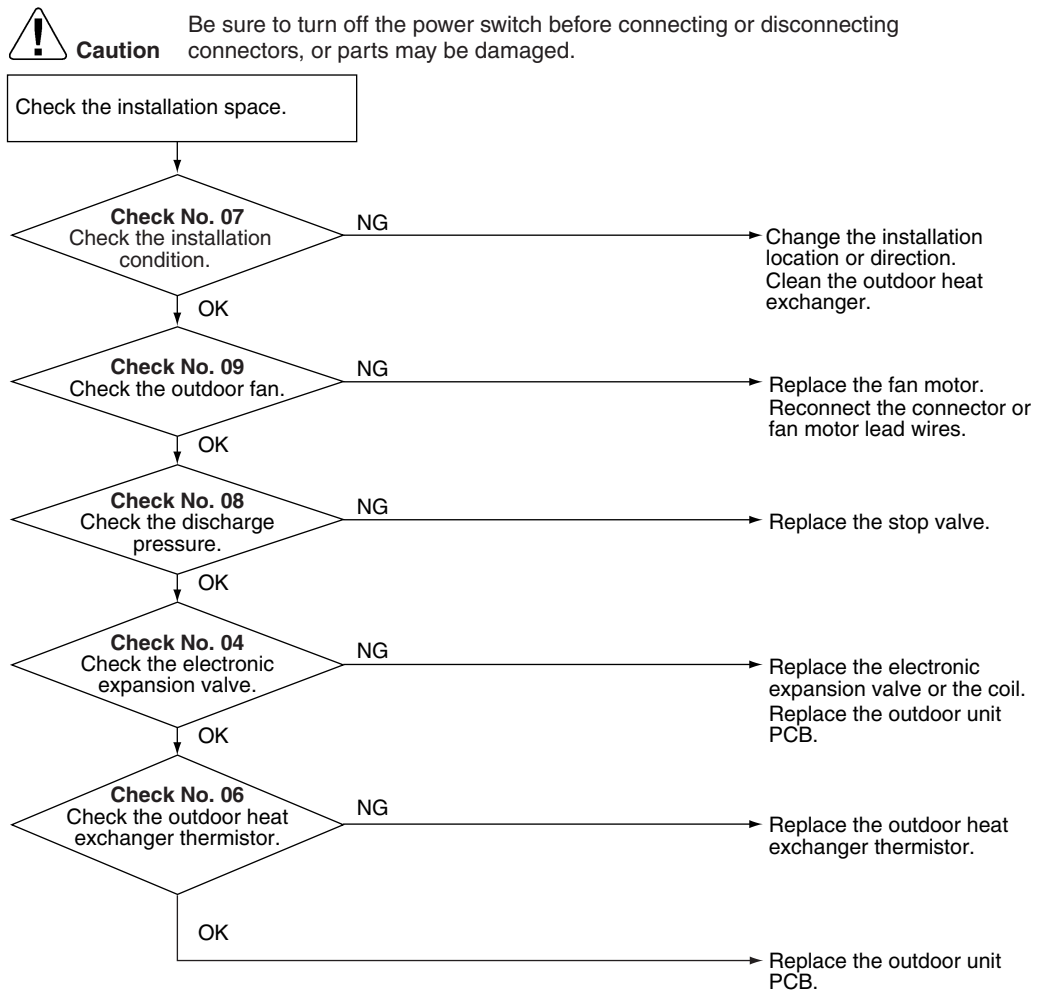

(R11897)

3.16 Compressor System Sensor Abnormality

Remote
Controller
Display



Method of
Malfunction
Detection

- The system checks the DC current before the compressor starts.

Malfunction
Decision
Conditions

- The DC current before compressor start-up is out of the range 0.5 ~ 4.5 V (sensor output converted to voltage value)
- The DC voltage before compressor start-up is below 50 V.

Supposed
Causes

- Broken or disconnection of harness
- Defective outdoor unit PCB

Troubleshooting

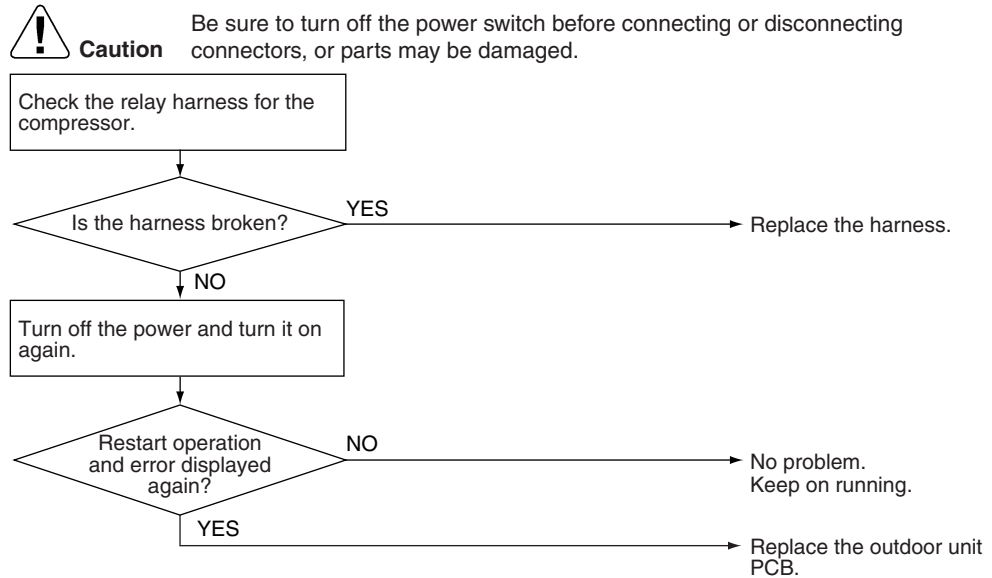

(R11712)

3.17 Position Sensor Abnormality

Remote
Controller
Display



Method of
Malfunction
Detection

A compressor start-up failure is detected by checking the compressor running condition through the position detection circuit.

Malfunction
Decision
Conditions

- If the error repeats, the system is shut down.
 - Reset condition: Continuous run for about 11 minutes without any other error
-

Supposed
Causes

- Disconnection of the compressor relay cable
- Defective compressor
- Defective outdoor unit PCB
- Start-up failure caused by the closed stop valve
- Input voltage is out of specification

Troubleshooting

Check No.29
 Refer to P.110

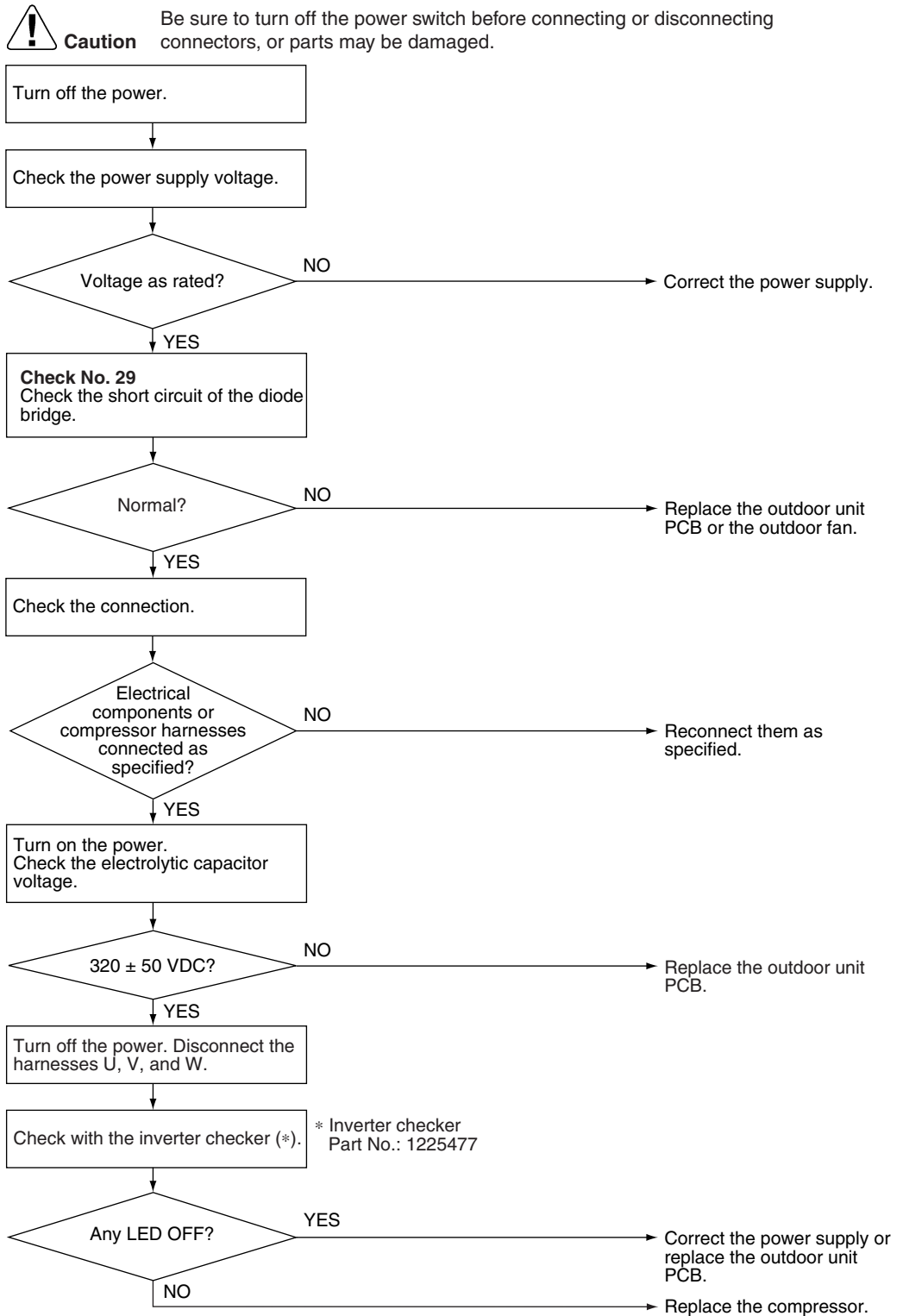

(R11380)

3.18 DC Voltage / Current Sensor Abnormality

Remote
Controller
Display



Method of
Malfunction
Detection

DC voltage or DC current sensor abnormality is identified based on the compressor running frequency and the input current.

Malfunction
Decision
Conditions

- The compressor running frequency is above 52 Hz.
- If the error repeats 4 times, the system is shut down.
- Reset condition: Continuous run for about 60 minutes without any other error

Supposed
Causes

- Defective outdoor unit PCB

Troubleshooting



Caution

Be sure to turn off the power switch before connecting or disconnecting connectors, or parts may be damaged.

Replace the outdoor unit PCB.

3.19 Thermistor or Related Abnormality (Outdoor Unit)

Remote
Controller
Display

H3, U3, U5, P4

Method of
Malfunction
Detection

This fault is identified based on the thermistor input voltage to the microcomputer.
A thermistor fault is identified based on the temperature sensed by each thermistor.

Malfunction
Decision
Conditions

- The thermistor input voltage is above 4.96 V or below 0.04 V with the power on.
- *U3* error is judged if the discharge pipe temperature is lower than the heat exchanger temperature.

Supposed
Causes

- Disconnection of the connector for the thermistor
- Defective thermistor
- Defective heat exchanger thermistor in the case of *U3* error (outdoor heat exchanger thermistor in cooling operation, or indoor heat exchanger thermistor in heating operation)
- Defective outdoor unit PCB
- Defective indoor unit PCB

Troubleshooting

Check No.06
 Refer to P.105

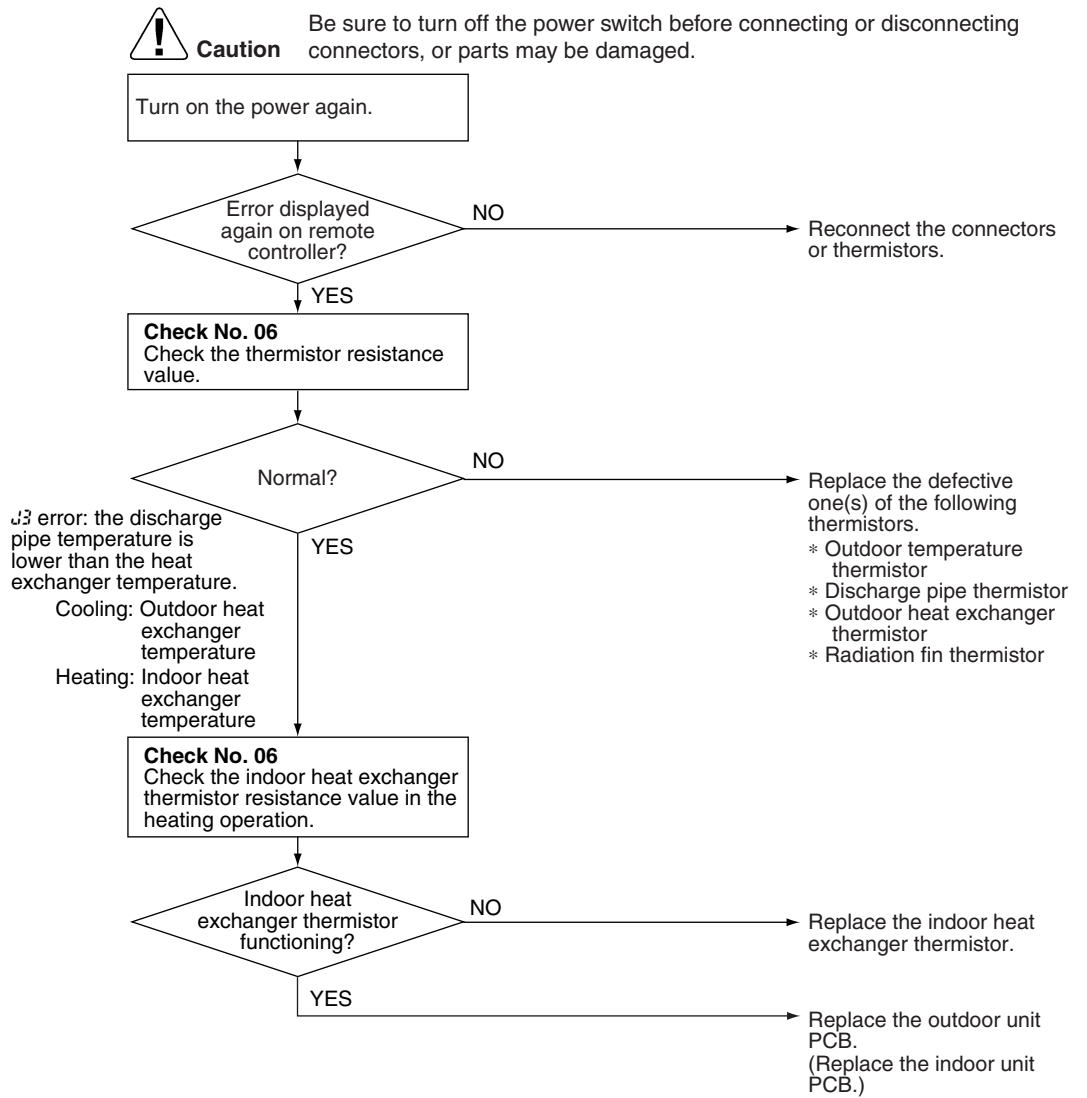

(R11926)

- W3 : Outdoor temperature thermistor
- J3 : Discharge pipe thermistor
- J5 : Outdoor heat exchanger thermistor
- P4 : Radiation fin thermistor



Note: In case of “P4” for RK(X)S25/35G2V1B, RK(X)S25/35G2V1B9 models



Caution Be sure to turn off the power switch before connecting or disconnecting connectors, or parts may be damaged.

Replace the outdoor unit PCB.

P4 : Radiation fin thermistor

3.20 Electrical Box Temperature Rise

Remote
Controller
Display



Method of
Malfunction
Detection

An electrical box temperature rise is detected by checking the radiation fin thermistor with the compressor off.

Malfunction
Decision
Conditions

- With the compressor off, the radiation fin temperature is above $A^{\circ}\text{C}$.
- The error is cleared when the radiation fin temperature drops below $B^{\circ}\text{C}$.
- To cool the electrical components, the outdoor fan starts when the radiation fin temperature rises above $C^{\circ}\text{C}$ and stops when it drops below $B^{\circ}\text{C}$.

	A ($^{\circ}\text{C}$)	B ($^{\circ}\text{C}$)	C ($^{\circ}\text{C}$)
RK(X)S25/35E2V1B, RK(X)S25/35G2V1B	80	70	80
RK(X)S25/35G2V1B9	98	75	83

Supposed
Causes

- Defective outdoor fan motor
- Short circuit
- Defective radiation fin thermistor
- Disconnection of connector
- Defective outdoor unit PCB

Troubleshooting

RK(X)S25/35E2V1B models

 **Check No.06**
Refer to P.105

 **Check No.07**
Refer to P.106

 **Check No.09**
Refer to P.107

 **Caution** Be sure to turn off the power switch before connecting or disconnecting connectors, or parts may be damaged.

Turn off the power and turn it on again.

 **WARNING**
To cool the electrical components, the outdoor fan starts when the radiation fin temperature rises above C °C and stops when it drops below B °C.

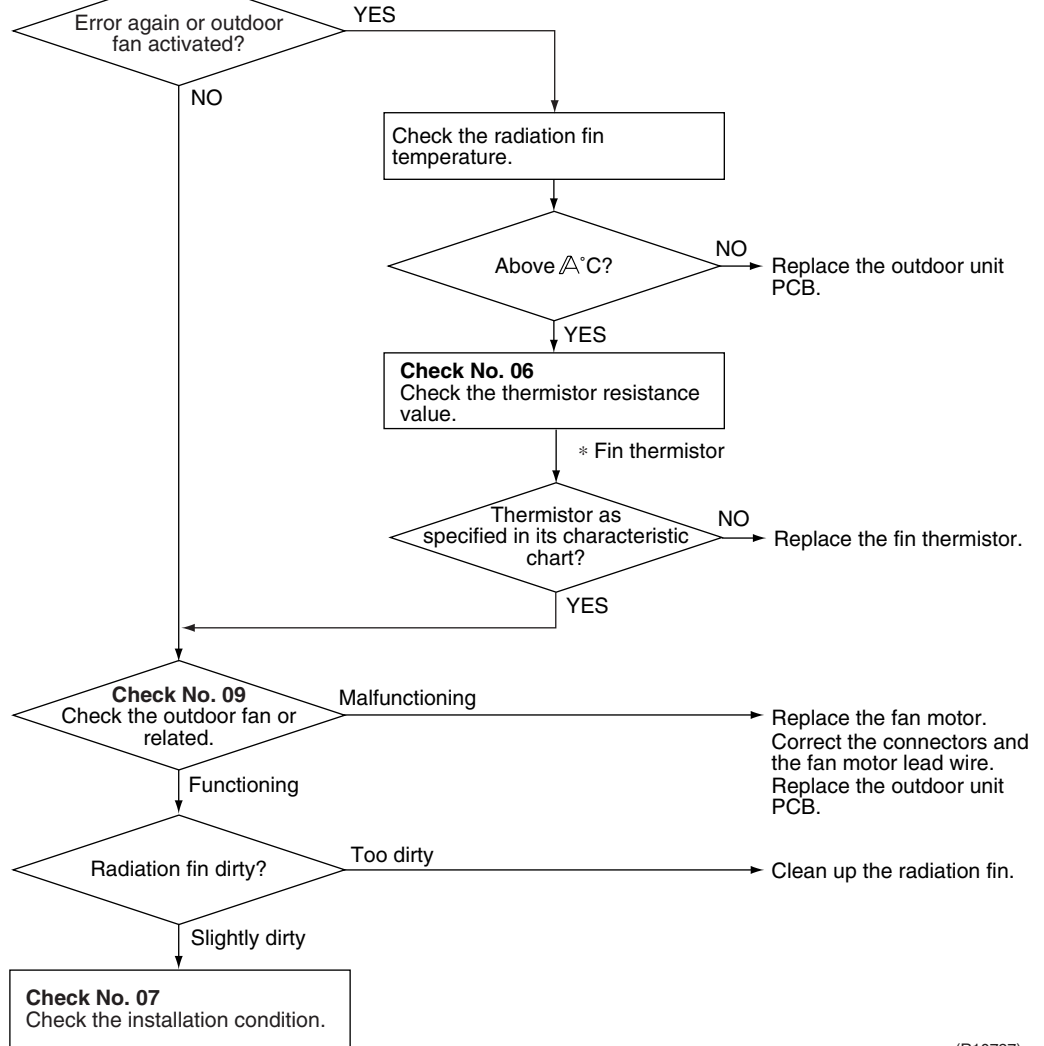

(R10727)

	A (°C)	B (°C)	C (°C)
RK(X)S25/35E2V1B	80	70	80

Troubleshooting

RK(X)S25/35G2V1B, RK(X)S25/35G2V1B9 models



Check No.07
 Refer to P.106



Check No.09
 Refer to P.107



Caution Be sure to turn off the power switch before connecting or disconnecting connectors, or parts may be damaged.

Turn off the power and turn it on again.

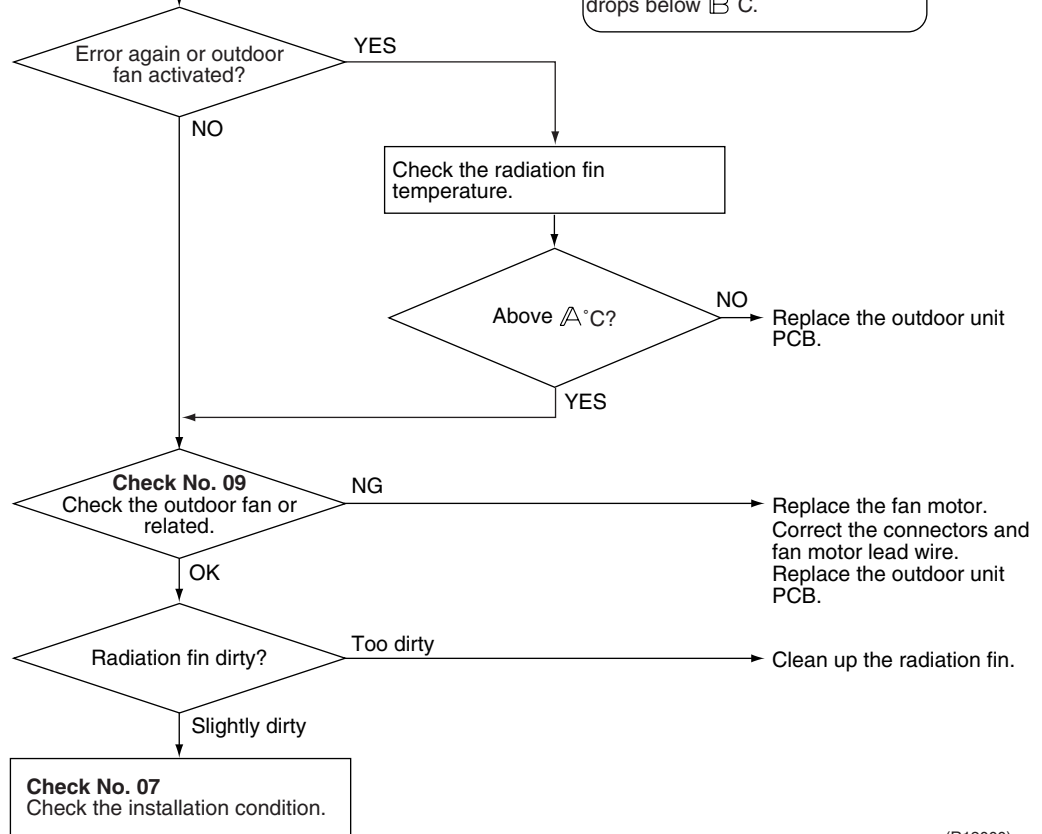
 **WARNING**
 To cool the electrical components, the outdoor fan starts when the radiation fin temperature rises above C °C and stops when it drops below B °C.



(R12000)

	A (°C)	B (°C)	C (°C)
RK(X)S25/35G2V1B	80	70	80
RK(X)S25/35G2V1B9	98	75	83

3.21 Radiation Fin Temperature Rise

Remote Controller Display **L4**

Method of Malfunction Detection A radiation fin temperature rise is detected by checking the radiation fin thermistor with the compressor on.

- Malfunction Decision Conditions**
- If the radiation fin temperature with the compressor on is above **A** °C.
 - The error is cleared when the radiation fin temperature drops below **B** °C.
 - If the error repeats, the system is shut down.
 - Reset condition: Continuous run for about 60 minutes without any other error

	A (°C)	B (°C)
RK(X)S25/35E2V1B, RK(X)S25/35G2V1B	90	85
RK(X)S25/35G2V1B9	98	78

- Supposed Causes**
- Defective outdoor fan motor
 - Short circuit
 - Defective radiation fin thermistor
 - Disconnection of connector
 - Defective outdoor unit PCB
 - Silicon grease is not applied properly on the radiation fin after replacing the outdoor unit PCB.

Troubleshooting

RK(X)S25/35E2V1B models

 **Check No.06**
Refer to P.105

 **Check No.07**
Refer to P.106

 **Check No.09**
Refer to P.107

 **Caution** Be sure to turn off the power switch before connecting or disconnecting connectors, or parts may be damaged.

Turn off the power and turn it on again to start the system.

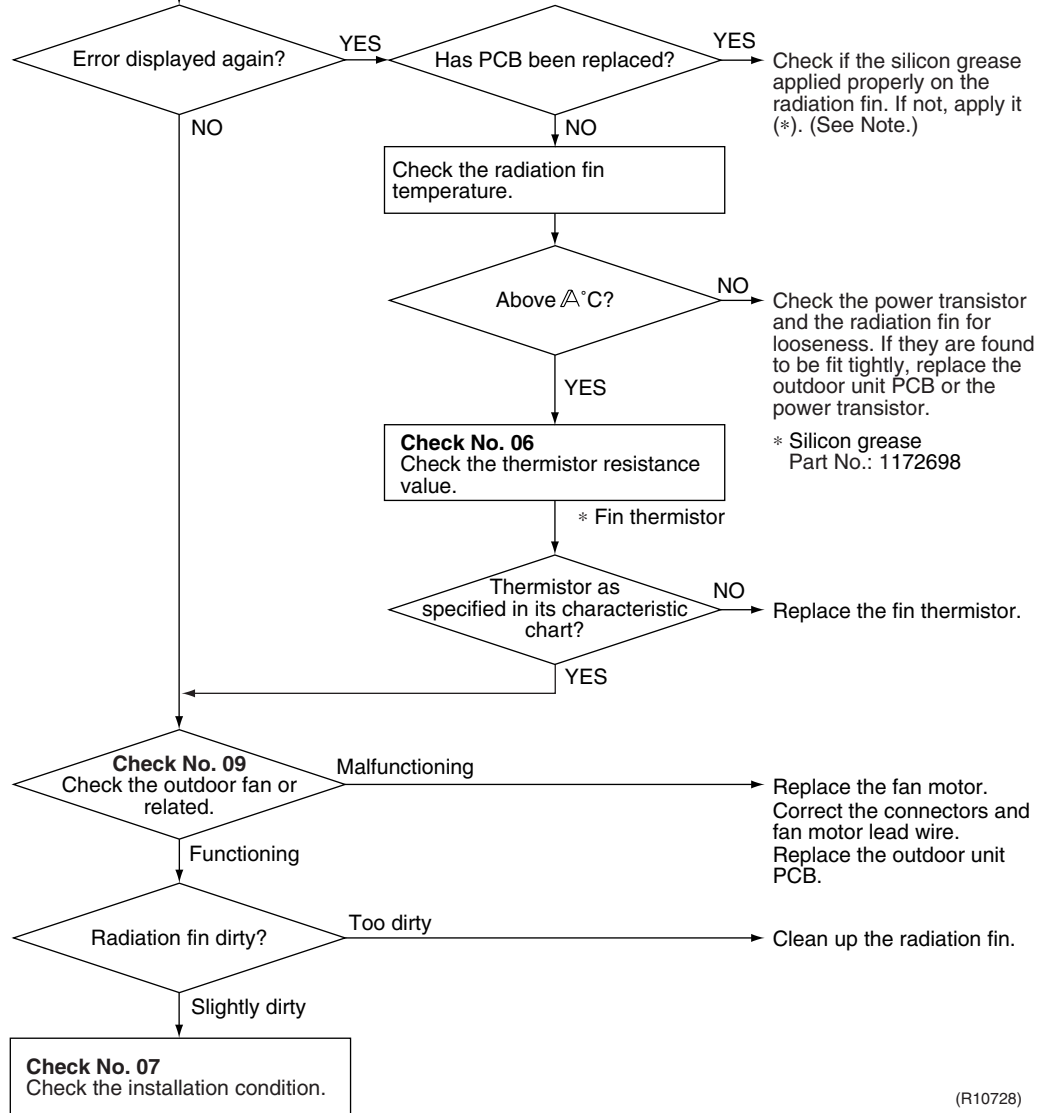

(R10728)

	Δ (°C)
RK(X)S25/35E2V1B	90

 **Note:** Refer to “Application of silicon grease to a power transistor and a diode bridge” on page 213 for detail.

Troubleshooting

 **Check No.07**
Refer to P.106

 **Check No.09**
Refer to P.107

RK(X)S25/35G2V1B, RK(X)S25/35G2V1B9 models

 **Caution** Be sure to turn off the power switch before connecting or disconnecting connectors, or parts may be damaged.

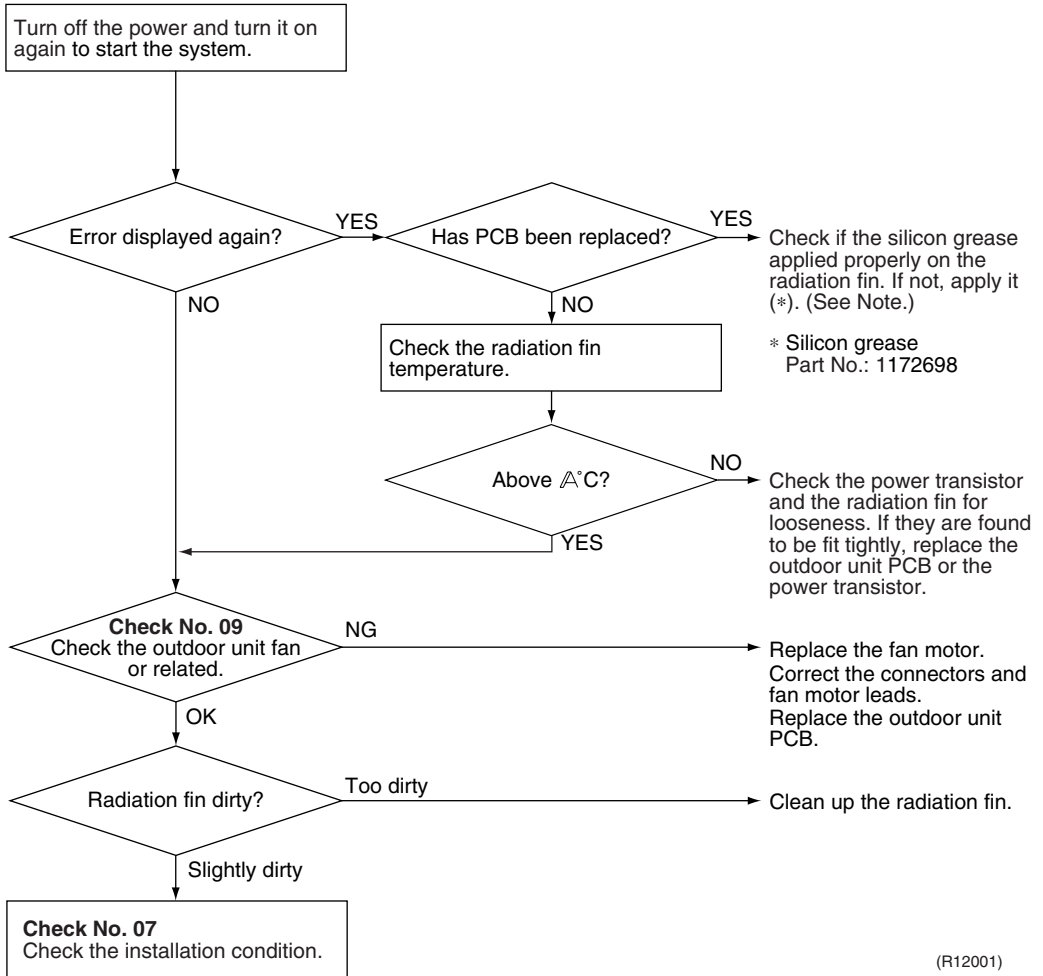

	Δ (°C)
RK(X)S25-35G2V1B	90
RK(X)S25-35G2V1B9	98

 **Note:** Refer to “Application of silicon grease to a power transistor and a diode bridge” on page 213 for detail.

3.22 Output Overcurrent Detection

Remote
Controller
Display

LS

Method of
Malfunction
Detection

An output overcurrent is detected by checking the current that flows in the inverter DC section.

Malfunction
Decision
Conditions

- A position signal error occurs while the compressor is running.
 - A speed error occurs while the compressor is running.
 - An output overcurrent signal is fed from the output overcurrent detection circuit to the microcomputer.
 - If the error repeats, the system is shut down.
 - Reset condition: Continuous run for about 11 minutes without any other error
-

Supposed
Causes

- Poor installation condition
- Closed stop valve
- Defective power module
- Wrong internal wiring
- Abnormal supply voltage
- Defective outdoor unit PCB
- Defective compressor

Troubleshooting



Check No.07
Refer to P.106



Check No.08
Refer to P.106



Check No.13
Refer to P.108



Caution Be sure to turn off the power switch before connecting or disconnecting connectors, or parts may be damaged.

* An output overcurrent signal may result from wrong internal wiring. If the wires have been disconnected and reconnected and the system is interrupted by an output overcurrent, take the following procedure.

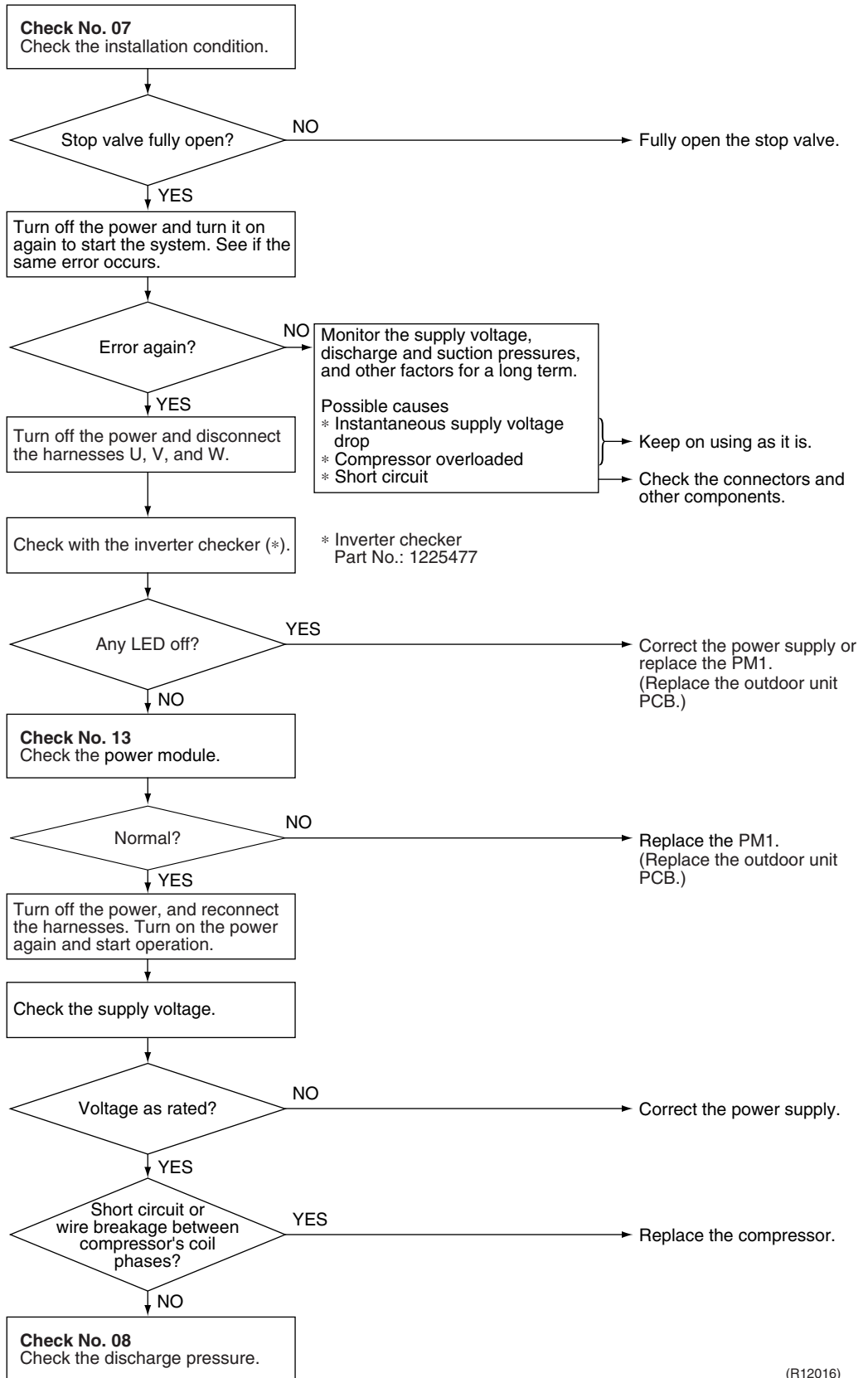

(R12016)

3.23 Refrigerant Shortage

Remote
Controller
Display



Method of
Malfunction
Detection

Refrigerant shortage detection I:

Refrigerant shortage is detected by checking the input current value and the compressor running frequency. If the refrigerant is short, the input current is smaller than the normal value.

Refrigerant shortage detection II:

Refrigerant shortage is detected by checking the discharge pipe temperature and the opening of the electronic expansion valve. If the refrigerant is short, the discharge pipe temperature tends to rise.

Refrigerant shortage detection III:

Refrigerant shortage is detected by checking the difference between suction and discharge temperature.

Malfunction
Decision
Conditions

Refrigerant shortage detection I:

The following conditions continue for 7 minutes.

- ◆ Input current × input voltage ≤ A × output frequency + B
- ◆ Output frequency > C

A (–)	B (W)	C (Hz)
640/256	0	55

Refrigerant shortage detection II:

The following conditions continue for 80 seconds.

- ◆ Opening of the electronic expansion valve ≥ E
- ◆ Discharge pipe temperature > H × target discharge pipe temperature + J

	E (pulse)	H (–)	J (°C)
RK(X)S25/35E2V1B	480	255/256	30
RK(X)S25/35G2V1B RK(X)S25/35G2V1B9	480	128/128	30

Refrigerant shortage detection III:

When the difference of the temperature is smaller than K °C, it is regarded as refrigerant shortage.

		K (°C)
Cooling	room thermistor temperature – indoor heat exchanger temperature	4.0
	outdoor heat exchanger temperature – outdoor temperature	4.0
Heating	indoor heat exchanger temperature – room thermistor temperature	3.0
	outdoor temperature – outdoor heat exchanger temperature	3.0

- If the error repeats 4 times, the system is shut down.
- Reset condition: Continuous run for about 60 minutes without any other error

Supposed
Causes

- Disconnection of the discharge pipe thermistor, indoor or outdoor heat exchanger thermistor, room or outdoor temperature thermistor
- Closed stop valve
- Refrigerant shortage (refrigerant leakage)
- Poor compression performance of compressor
- Defective electronic expansion valve

Troubleshooting



Check No.04
Refer to P.103



Check No.06
Refer to P.105



Caution Be sure to turn off the power switch before connecting or disconnecting connectors, or parts may be damaged.

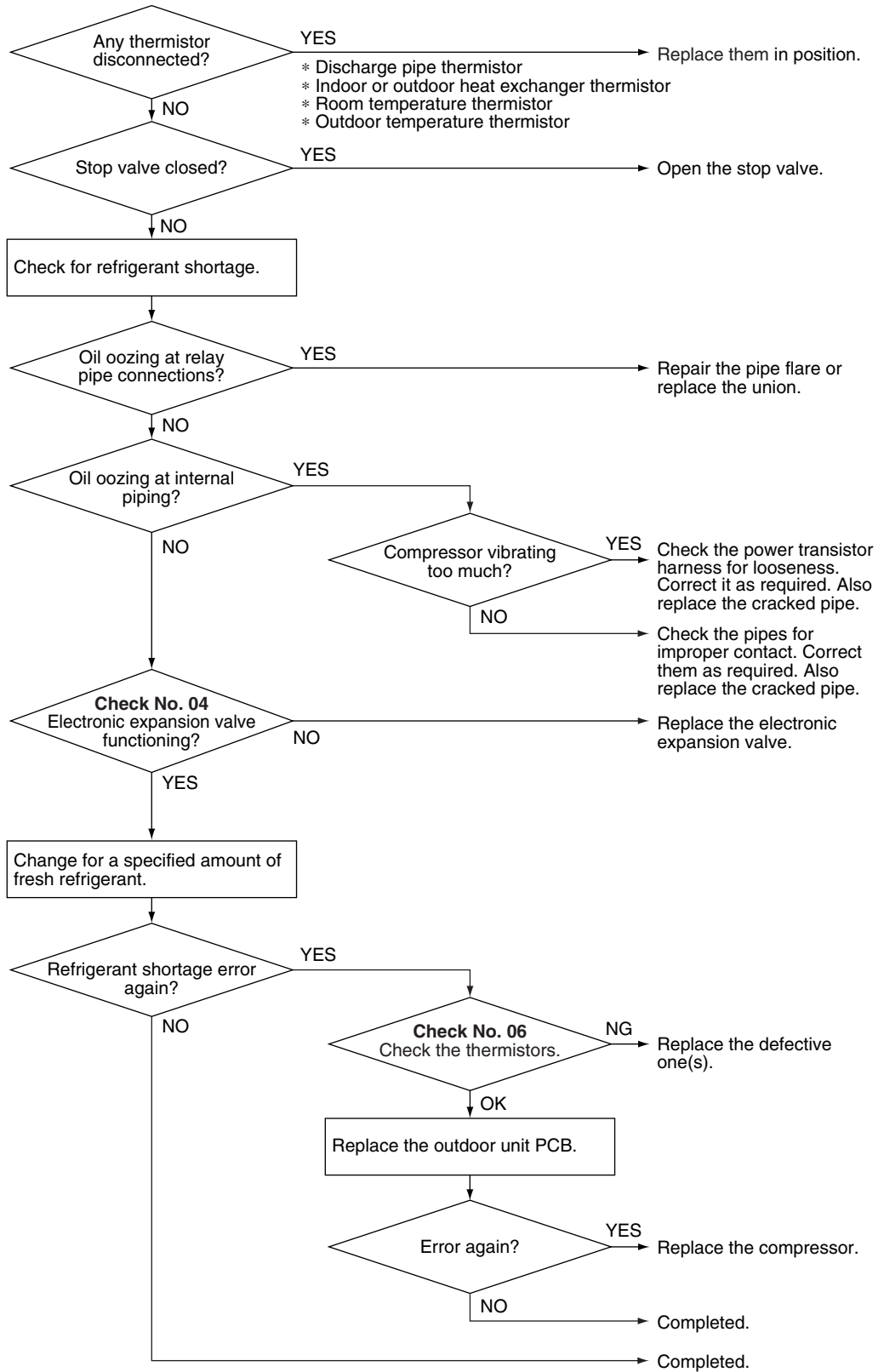

(R12015)

3.24 Low-voltage Detection or Over-voltage Detection

Remote Controller Display	
Method of Malfunction Detection	<p>Low-voltage detection: An abnormal voltage drop is detected by the DC voltage detection circuit.</p> <p>Over-voltage detection: An abnormal voltage rise is detected by the over-voltage detection circuit.</p>
Malfunction Decision Conditions	<p>Low-voltage detection:</p> <ul style="list-style-type: none"> ■ The voltage detected by the DC voltage detection circuit is below 150 ~ 180 V (depending on the model). <p>Over-voltage detection:</p> <ul style="list-style-type: none"> ■ An over-voltage signal is fed from the over-voltage detection circuit to the microcomputer. (The voltage is over 400 V.) ■ If the error repeats, the system is shut down. ■ Reset condition: Continuous run for about 11 minutes without any other error
Supposed Causes	<ul style="list-style-type: none"> ■ Supply voltage is not as specified. ■ Defective DC voltage detection circuit ■ Defective over-voltage detection circuit ■ Defective PAM control part ■ Layer short inside the fan motor winding

Troubleshooting

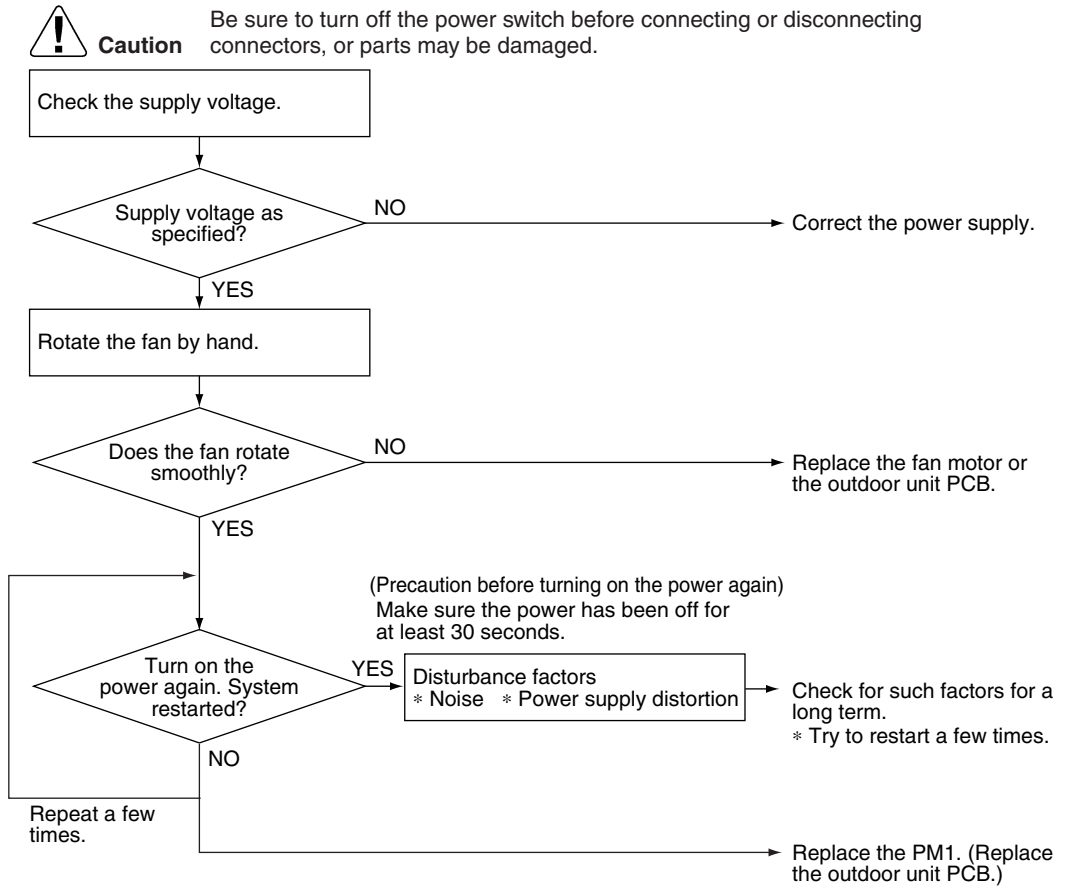

(R8402)

4. Check

4.1 How to Check

4.1.1 Electronic Expansion Valve Check

Check No.04

Conduct the followings to check the electronic expansion valve (EV).

1. Check to see if the EV connector is correctly connected to the PCB.
2. Turn the power off and on again, and check to see if the EV generate latching sound.
3. If the EV does not generate latching sound in the above step 2, disconnect the connector and check the continuity using a tester.
4. Check the continuity between the pins 1 - 6 and 3 - 6, and between the pins 2 - 5 and 4 - 5. If there is no continuity between the pins, the EV coil is faulty.

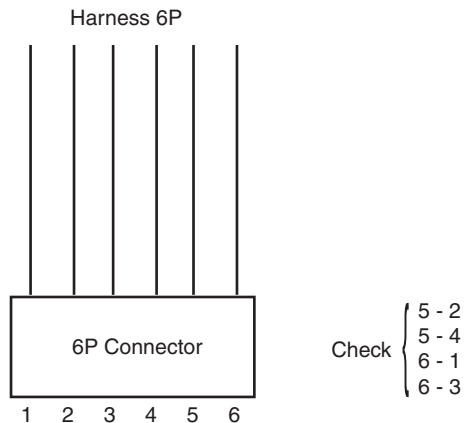

(R1082)

5. If the continuity is confirmed in the above step 3, the outdoor unit PCB is faulty.



Note: Please note that the latching sound varies depending on the valve type.

4.1.2 Four Way Valve Performance Check

Check No.05

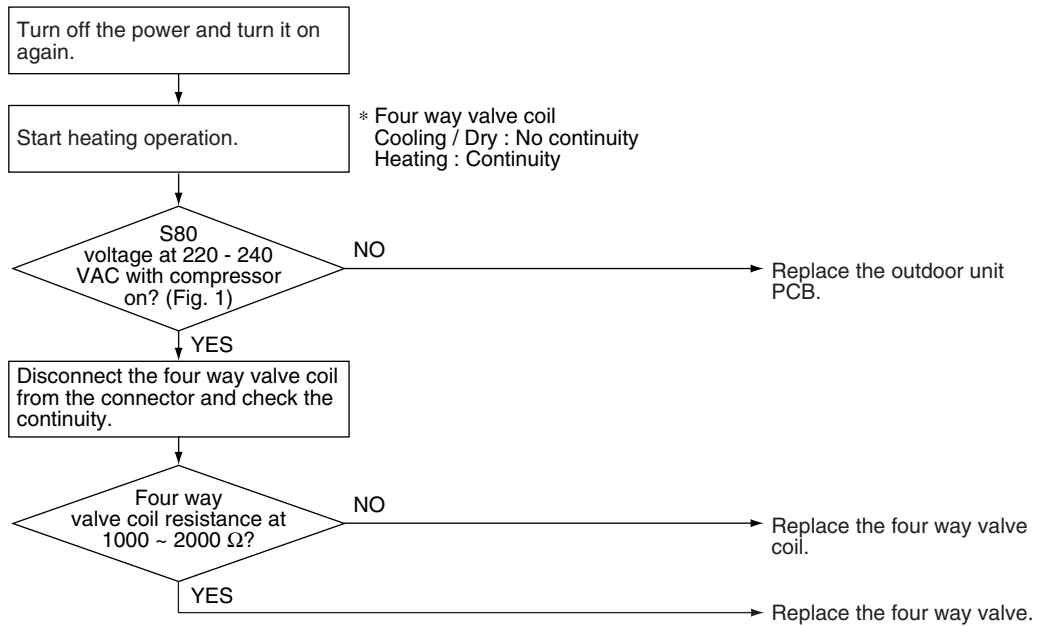

(R11903)

(Fig. 1)

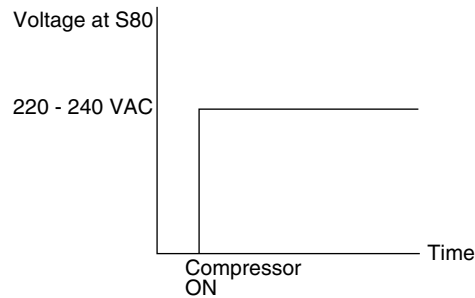

(R11904)

4.1.3 Thermistor Resistance Check

Check No.06

Disconnect the connectors of the thermistors from the PCB, and measure the resistance of each thermistor using tester.

The relationship between normal temperature and resistance is shown in the table and the graph below.

Thermistor temperature (°C)	Resistance (kΩ)
-20	211.0
-15	150.0
-10	116.5
-5	88.0
0	67.2
5	51.9
10	40.0
15	31.8
20	25.0
25	20.0
30	16.0
35	13.0
40	10.6
45	8.7
50	7.2

($R_{25^{\circ}\text{C}} = 20 \text{ k}\Omega$, $B = 3950 \text{ K}$)

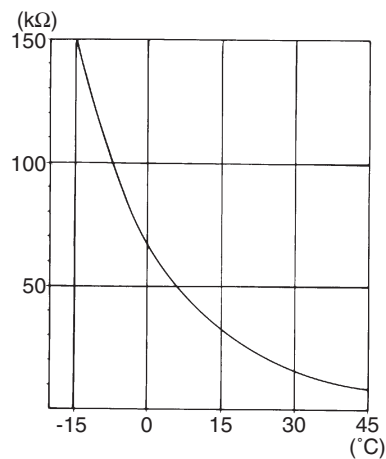

(R11905)

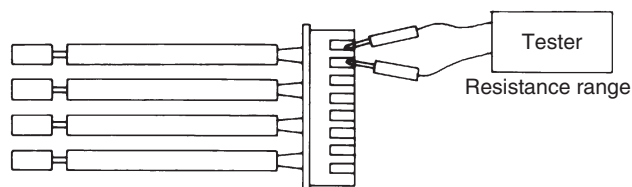

(R11906)

- For the models in which the thermistor is directly mounted on the PCB, disconnect the connector for the PCB and measure.

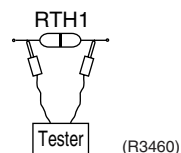

(R3460)

4.1.4 Installation Condition Check

Check No.07

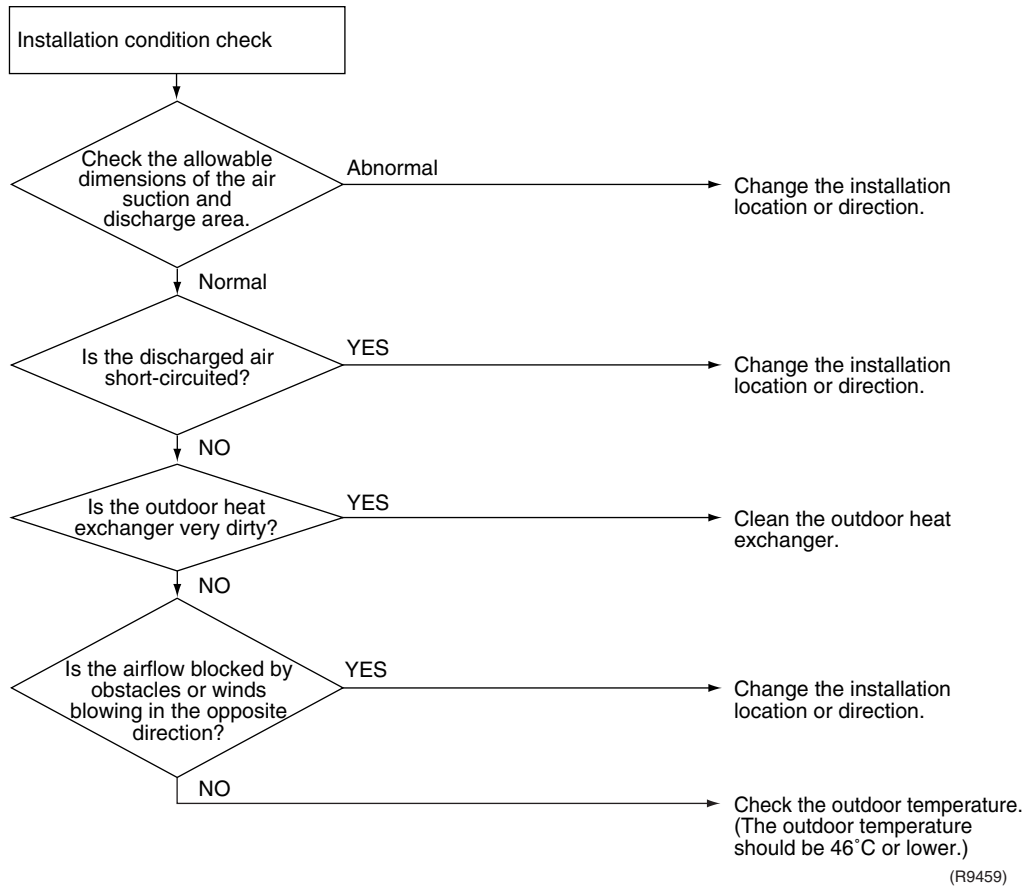

4.1.5 Discharge Pressure Check

Check No.08

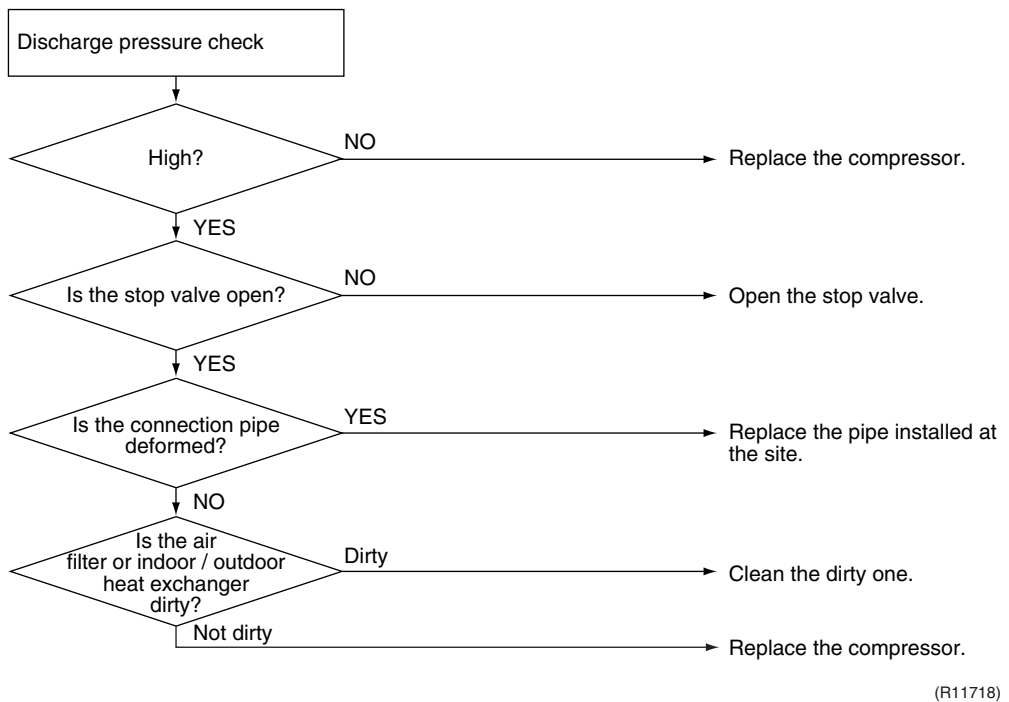

4.1.6 Outdoor Fan System Check

Check No.09

DC motor

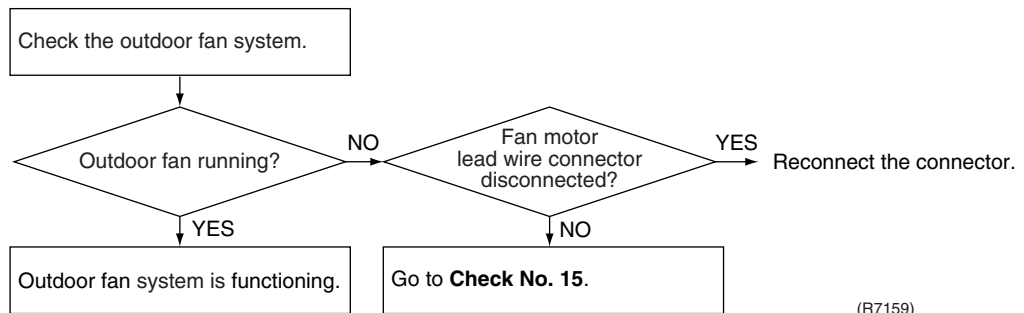

(R7159)

4.1.7 Power Supply Waveforms Check

Check No.10

Measure the power supply waveform between No. 1 and No. 2 on the terminal board, and check the waveform disturbance.

- Check to see if the power supply waveform is a sine wave. (Fig.1)
- Check to see if there is waveform disturbance near the zero cross. (sections circled in Fig.2)

Fig.1

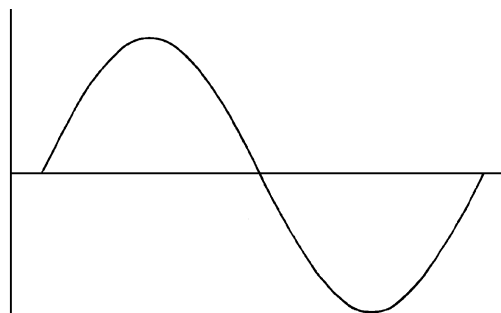

(R1736)

Fig.2

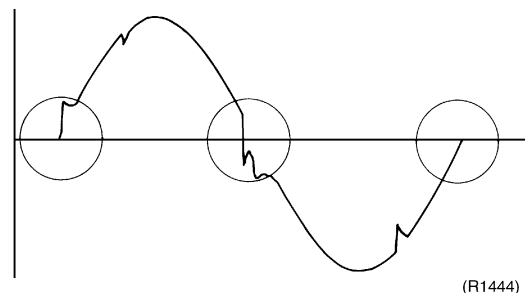

(R1444)

4.1.8 Inverter Units Refrigerant System Check

Check No.11

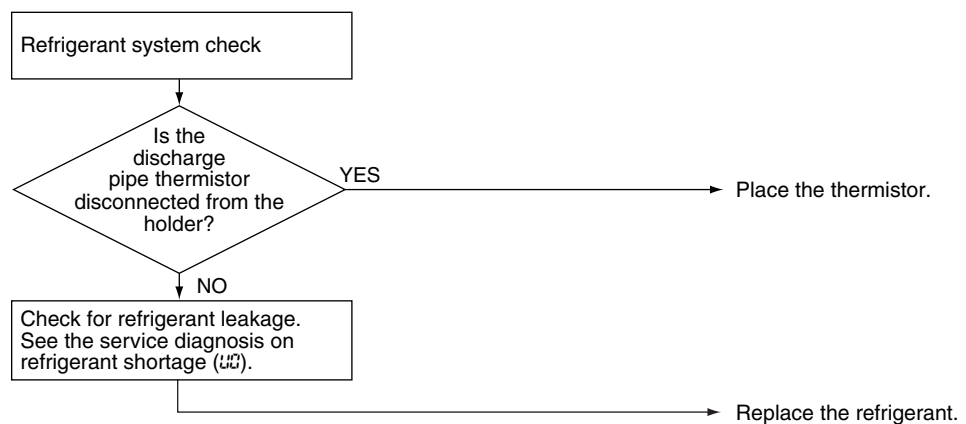

(R8259)

4.1.9 Power Module Check

Check No.13



Note: Check to make sure that the voltage between (+) and (-) of the diode bridge (DB1) is approx. 0 V before checking.

- Disconnect the compressor harness connector from the outdoor unit PCB. To disengage the connector, press the protrusion on the connector.
- Follow the procedure below to measure resistance between the terminals of the DB1 and the terminals of the compressor with a multi-tester. Evaluate the measurement results for a judgment.

Negative (-) terminal of tester (positive terminal (+) for digital tester)	DB1 (+)	UVW	DB1 (-)	UVW
Positive (+) terminal of tester (negative terminal (-) for digital tester)	UVW	DB1 (+)	UVW	DB1 (-)
Resistance in OK	several kΩ ~ several MΩ			
Resistance in NG	0 Ω or ∞			

4.1.10 Rotation Pulse Check on the Outdoor Unit PCB

Check No.15

RK(X)S25/35E2V1B, RK(X)S25/35G2V1B

Make sure that the voltage of 320 ± 30 V is applied.

1. Set operation off and power off. Disconnect the connector S70.
2. Check that the voltage between the pins 4 - 7 is 320 VDC.
3. Check that the control voltage between the pins 3 - 4 is 15 VDC.
4. Check that the rotation command voltage between the pins 2 - 4 is 0 ~ 15 VDC.
5. Keep operation off and power off. Connect the connector S70.
6. Check whether 2 pulses (0 ~ 15 VDC) are output at the pins 1 - 4 when the fan motor is rotated 1 turn by hand.

When the fuse is melted, check the outdoor fan motor for proper function.

If NG in step 2 → Defective PCB → Replace the outdoor unit PCB.

If NG in step 4 → Defective Hall IC → Replace the outdoor fan motor.

If OK in both steps 2 and 4 → Replace the outdoor unit PCB.

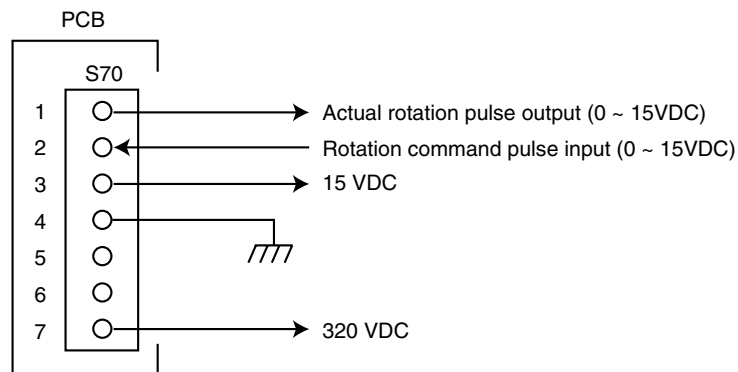

(R10811)

RK(X)S25/35G2V1B9

1. Check that the voltage between the pins 10 - 11 is 15 VDC.
2. Check if the Hall IC generates the rotation pulse (0 ~ 15 VDC) 4 times between the pins 10 - 12, 10 - 13, when the fan motor is manually rotated once.

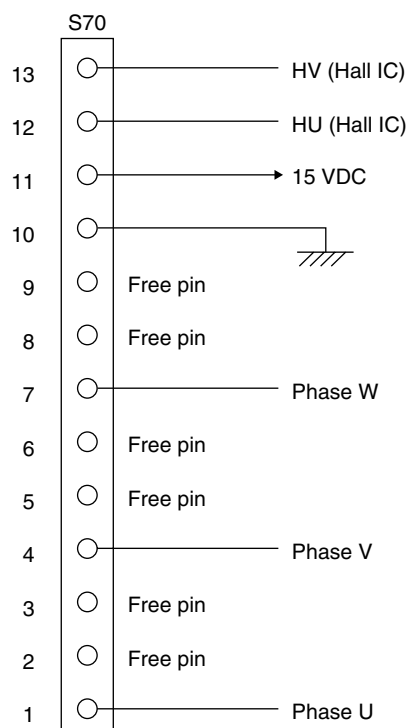

(R11907)

4.1.11 Hall IC Check

Check No.16

1. Check the connector connection.
2. With the power on, operation off, and the connector connected, check the following.
 - *Output voltage of about 5 V between pins 1 and 3.
 - *Generation of 3 pulses between pins 2 and 3 when the fan motor is operating.

If NG in step 1 → Defective PCB → Replace the PCB.
 If NG in step 2 → Defective Hall IC → Replace the fan motor.
 If OK in both steps 1 and 2 → Replace the PCB.

The connector has 3 pins.

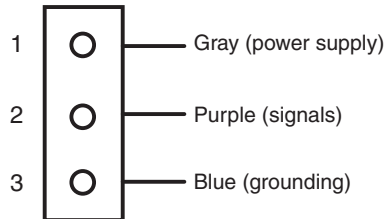

(R1990)

4.1.12 Main Circuit Short Check

Check No.29



Note: Check to make sure that the voltage between (+) and (-) of the diode bridge (DB1) is approx. 0 V before checking.

- Measure the resistance between the pins of the DB1 as below.
- If the resistance is ∞ or less than 1 kΩ, short circuit occurs on the main circuit.

(-) terminal of the tester (in case of digital, (+) terminal)	~ (2, 3)	+ (4)	~ (2, 3)	- (1)
(+) terminal of the tester (in case of digital, (-) terminal)	+ (4)	~ (2, 3)	- (1)	~ (2, 3)
Resistance in OK	several kΩ ~ several MΩ	∞	∞	several kΩ ~ several MΩ
Resistance in NG	0 Ω or ∞	0	0	0 Ω or ∞

RK(X)S25/35E2V1B models

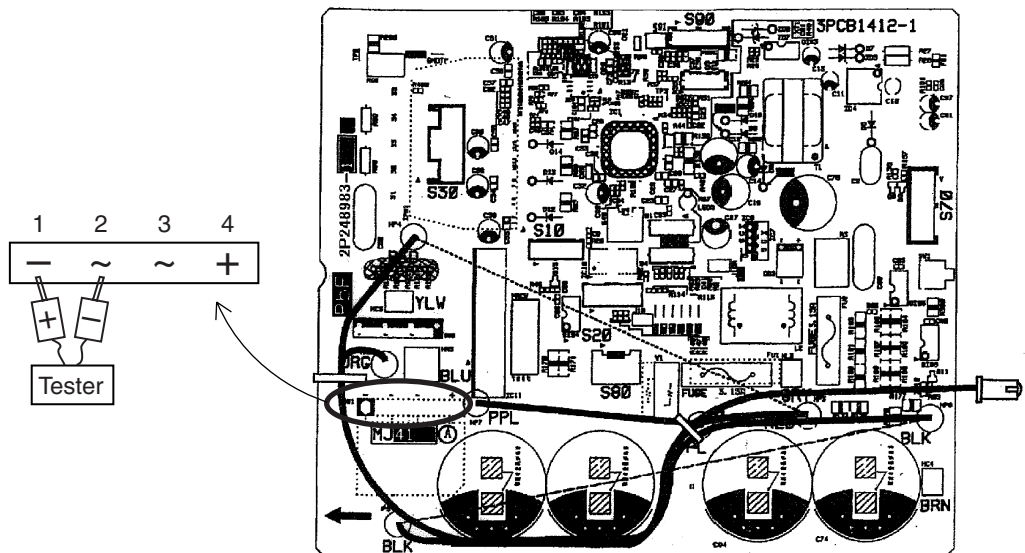

(R12412)

Part 7

Removal Procedure

1. Indoor Unit.....	113
1.1 Removal of Air Filter / Front Grille	113
1.2 Removal of Front Panel.....	116
1.3 Removal of Horizontal Blade	118
1.4 Removal of Signal Receiver Unit / Swing Motor.....	119
1.5 Removal of Discharge Grille.....	120
1.6 Removal of Drain Pan	121
1.7 Removal of Electrical Box / PCB	122
1.8 Removal of Fan Rotor / Fan Motor	125
1.9 Removal of Indoor Heat Exchanger	127
2. Outdoor Unit - RK(X)S25/35E2V1B	129
2.1 Removal of Outer Panels / Fan Motor	129
2.2 Removal of Electrical Box	137
2.3 Removal of PCB.....	141
2.4 Removal of Reactor / Partition Plate	143
2.5 Removal of Sound Blanket.....	145
2.6 Removal of Four Way Valve.....	147
2.7 Removal of Compressor.....	150
3. Outdoor Unit - RK(X)S25/35G2V1B.....	152
3.1 Removal of Outer Panels / Fan Motor	152
3.2 Removal of Electrical Box	161
3.3 Removal of Thermistors	165
3.4 Removal of PCB.....	167
3.5 Removal of Reactor / Partition Plate	170
3.6 Removal of Sound Blanket.....	172
3.7 Removal of Four Way Valve.....	173
3.8 Removal of Compressor.....	176
4. Outdoor Unit - RK(X)S25/35G2V1B9.....	178
4.1 Removal of Outer Panels / Fan Motor	178
4.2 Removal of Electrical Box	187
4.3 Removal of PCB.....	190
4.4 Removal of Reactor / Partition Plate	198
4.5 Removal of Sound Blanket.....	200
4.6 Removal of Four Way Valve.....	202
4.7 Removal of Compressor.....	205

1. Indoor Unit

1.1 Removal of Air Filter / Front Grille

Procedure

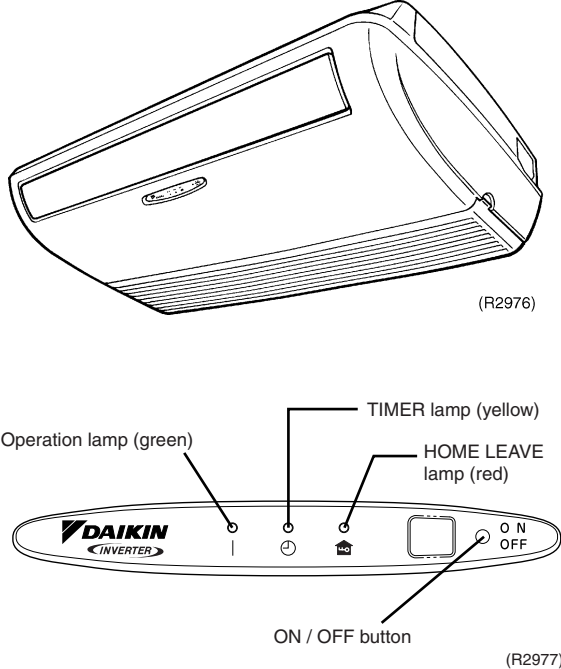
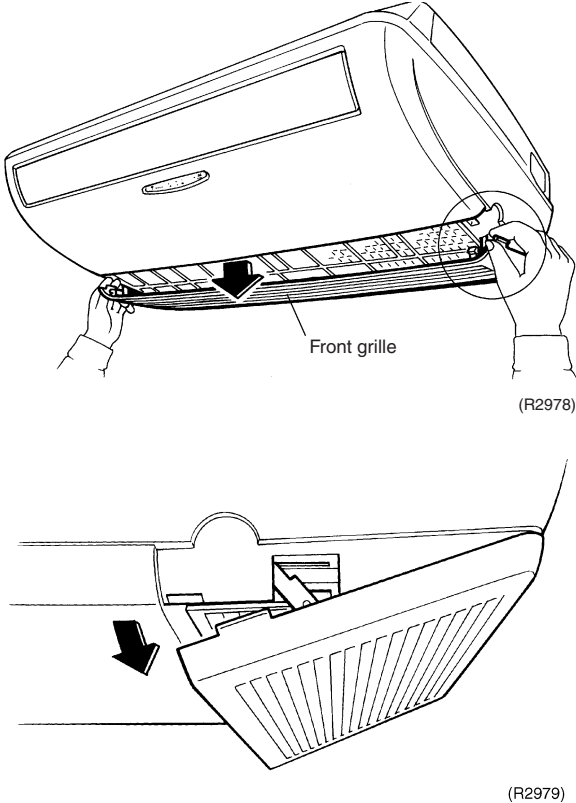

Warning Be sure to wait 10 minutes or more after turning off all power supplies before disassembling work.

Step	Procedure	Points
1. External appearance	<p data-bbox="199 817 464 913">■ The illustrations are given as the ceiling-suspended type.</p> 	<p data-bbox="1093 817 1428 947">Note: The removal procedure is the same for the floor-mounted type.</p>
2. Remove the air filters.	<p data-bbox="151 1238 456 1335">1 Pull the protrusions on the both sides of the front grille and open it.</p> 	

Step	Procedure	Points
2	Hold the tab at the center of the air filter frame and pull the air filter forward.	Air filter
3	Pull the air filter along the guide and remove it.	(R2980)
3. Remove the front grille.	1 Remove the 2 grille fixtures (right and left sides), using a flat screwdriver.	(R2981)
1	Remove the 2 grille fixtures (right and left sides), using a flat screwdriver.	Grille fixture
		(R2982)
		(R2983)
		■ Installing air filters can be done easily by sliding along the guide.

Step	Procedure	Points
2	To remove the front grille, unfasten the hooks at 3 locations.	
(R2984)		
4. Remove the side cover.		
1	<p>Remove the side cover.</p> <p>Note: If it is difficult to remove the side cover from outside with fingers, remove the front panel first, then push the side cover from inside to outside.</p>	
(R2985)		

1.2 Removal of Front Panel

Procedure



Warning Be sure to wait 10 minutes or more after turning off all power supplies before disassembling work.

Step	Procedure	Procedure	Points
1	Remove the 4 screws of the front panel.	<p>Front panel</p> <p>(R2986)</p>	<p>Note: For the ceiling-suspended type, remove drain hose before removing the screws.</p>
2	Remove the 3 screw covers at the front of the front panel.	<p>To open the screw cover</p> <p>(R2987)</p>	
3	Remove the 3 screws.	<p>(R2988)</p>	

Step	Procedure	Points
4	Unfasten the 3 hooks of the front panel.	 Caution For ceiling-suspended type, be careful that the front panel may fall when the hooks are disengaged. To prevent the front panel from falling down, this work should be done by 2 persons.
5	Press A-section slightly at the center of the front panel, and unfasten the hook.	
6	Remove the front panel.	

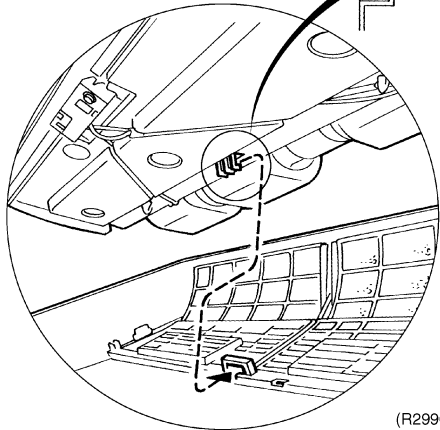
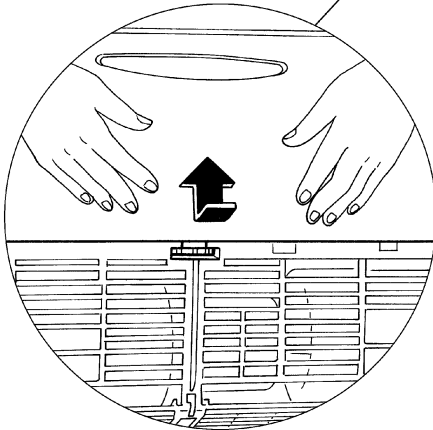
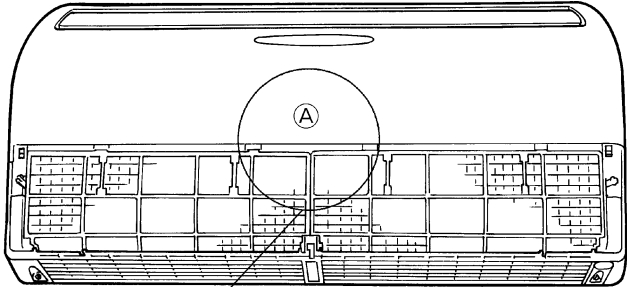
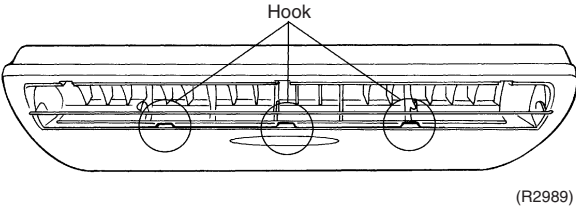

(R2990)

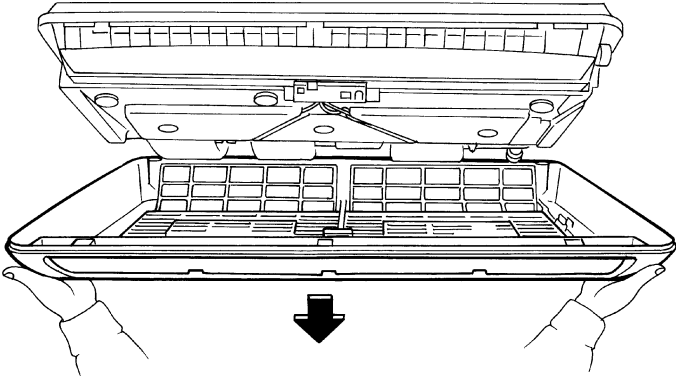

1.3 Removal of Horizontal Blade

Procedure



Warning Be sure to wait 10 minutes or more after turning off all power supplies before disassembling work.

Step	Procedure	Procedure	Points
1	Open the horizontal blade.	<p>(R2992)</p>	
2	Deflect the 3 center bearings to the left side slightly, and release the shafts of the horizontal blade.	<p>(R2993)</p>	
3	Bend the horizontal blade slightly to release the shafts from bearings at the both ends. (Release the left side shaft first.)	<p>(R2994)</p>	

1.4 Removal of Signal Receiver Unit / Swing Motor

Procedure

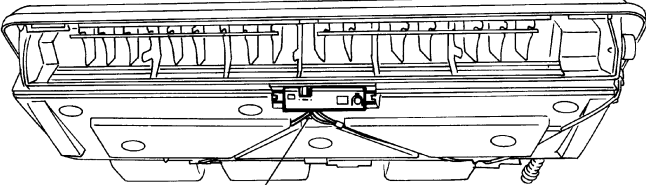
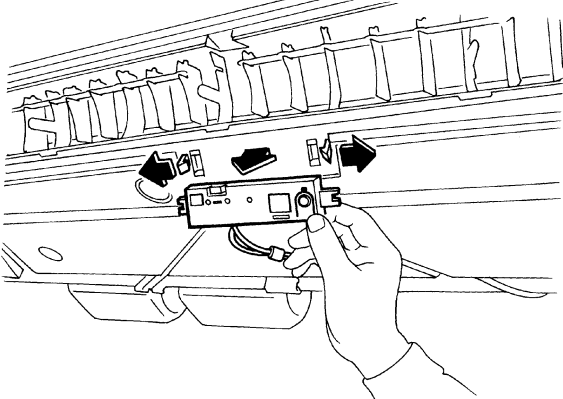
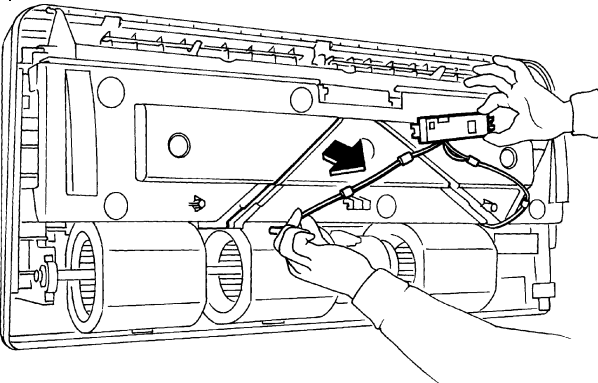
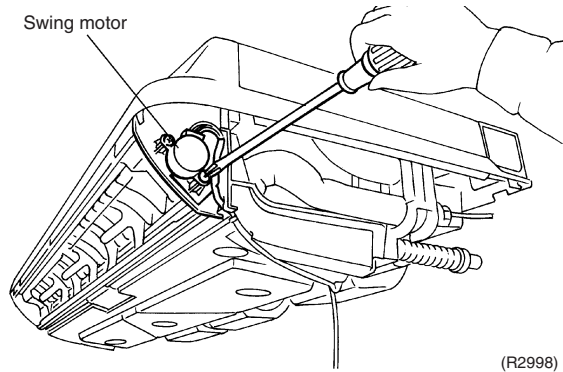

Warning Be sure to wait 10 minutes or more after turning off all power supplies before disassembling work.

Step	Procedure	Points
<p>1. Remove the signal receiver unit.</p> <p>1 Unfasten the 2 hooks (right and left sides) to remove the signal receiver unit.</p> <p>2 Remove the wire harness of the signal receiver unit from the groove.</p>	 <p style="text-align: center;">Signal receiver unit (R2995)</p>  <p style="text-align: right;">(R2996)</p>  <p style="text-align: right;">(R2997)</p>	<p>Note: Rearrange the wire harness in position as it was when reassembling signal receiver unit.</p>
<p>2. Remove the swing motor.</p> <p>1 Remove the 2 screws and remove the swing motor.</p>	 <p style="text-align: center;">Swing motor (R2998)</p>	

1.5 Removal of Discharge Grille

Procedure



Warning Be sure to wait 10 minutes or more after turning off all power supplies before disassembling work.

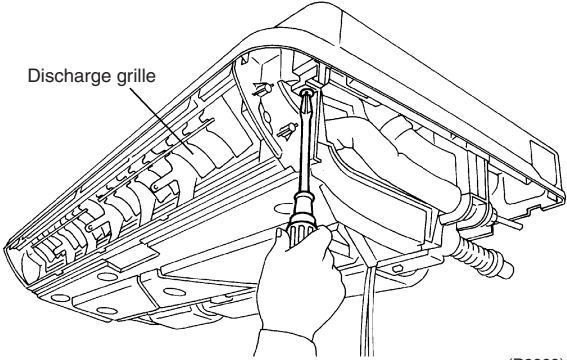
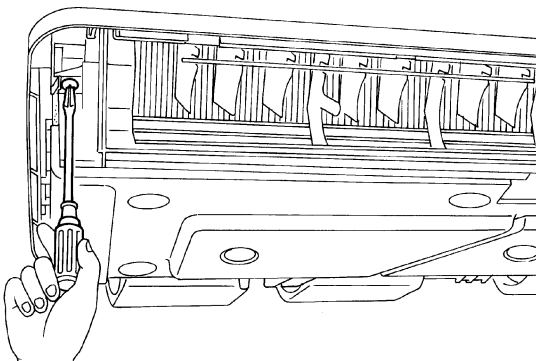
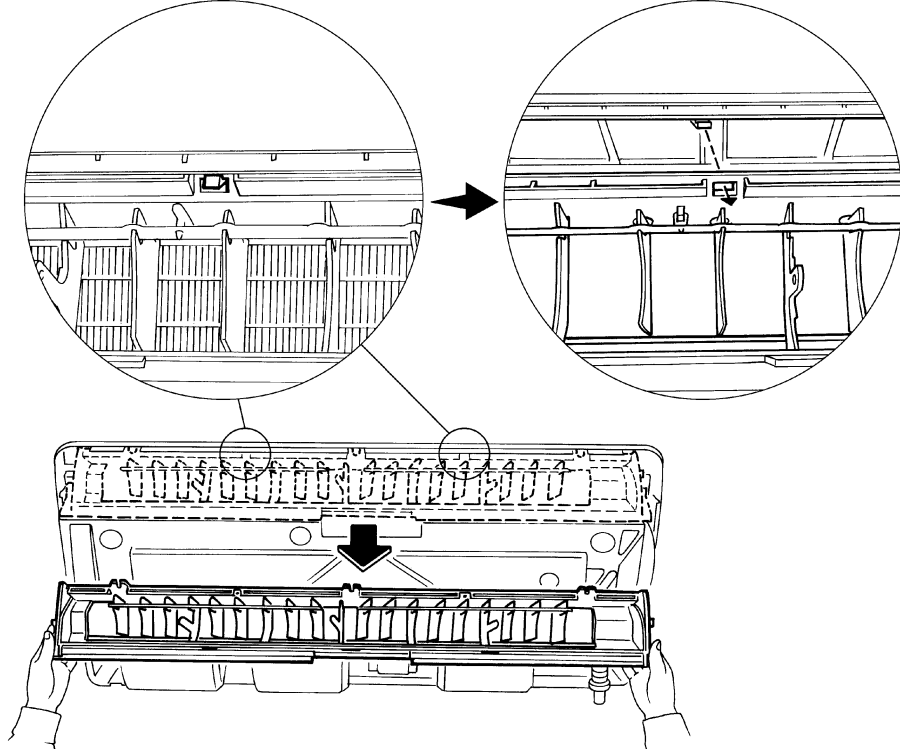

Step	Procedure	Procedure	Points
1	Remove the 2 screws.	 <p>(R2999)</p>  <p>(R3000)</p>	
2	Unfasten the 2 hooks (right and left sides) and remove the discharge grille by pulling it forward.	 <p>(R3001)</p>	

1.6 Removal of Drain Pan

Procedure

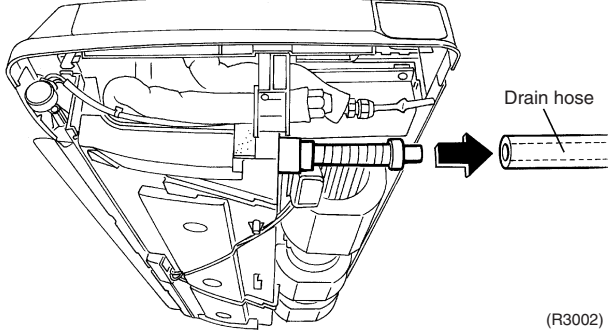

Warning Be sure to wait 10 minutes or more after turning off all power supplies before disassembling work.

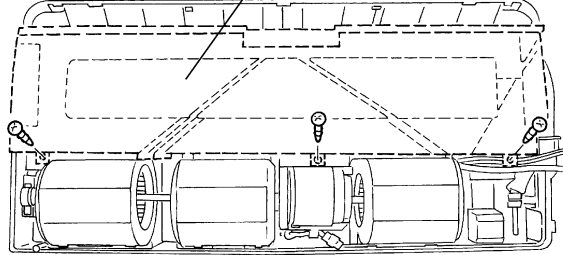
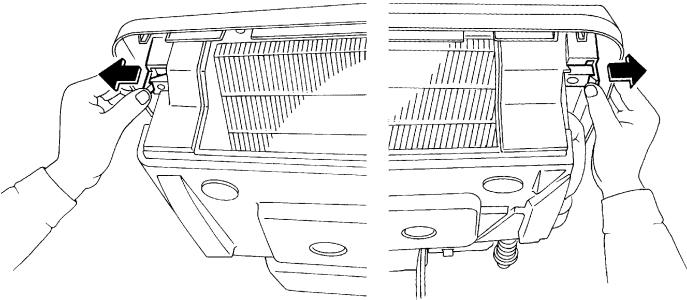
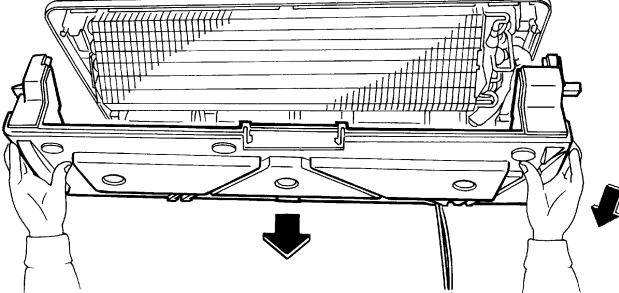
Step	Procedure	Procedure	Points
1	Disconnect the drain hose.	 <p style="text-align: right;">(R3002)</p>	 <p>Caution Be careful not to wet the floor with drain water.</p>
2	Remove the 3 screws securing the suction side of the drain pan.		
3	Unfasten the 2 hooks located at both sides.	 <p style="text-align: right;">(R3004)</p>	
4	Slide the drain pan toward the suction side and remove it.	 <p style="text-align: right;">(R3005)</p>	

1.7 Removal of Electrical Box / PCB

Procedure

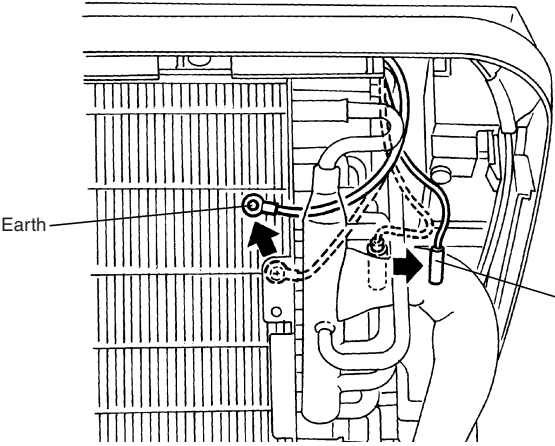
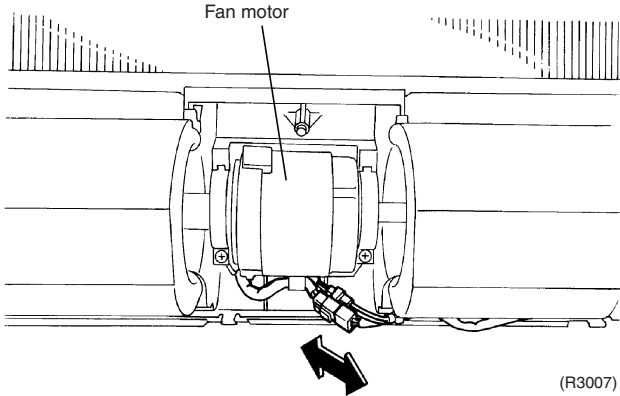
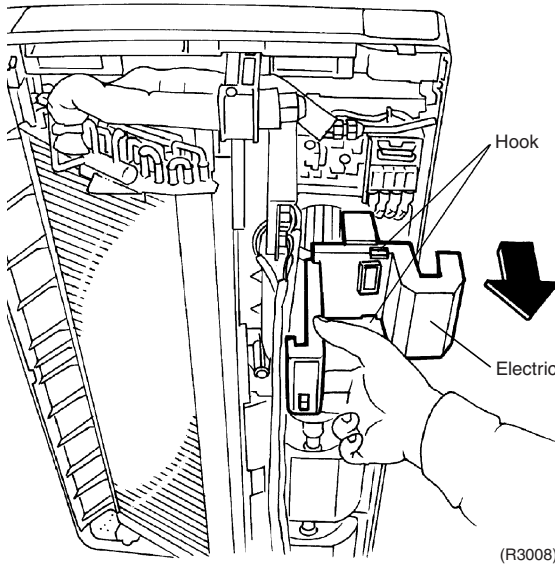

Warning Be sure to wait 10 minutes or more after turning off all power supplies before disassembling work.

Step	Procedure	Points
1. Remove the PCB.		
1	Disconnect the earth wire and pull out the indoor heat exchanger thermistor.	 <p>(R3006)</p>
2	Disconnect the 2 relay harnesses at the rear side of the fan motor.	 <p>(R3007)</p>
3	Remove the electrical box cover. (Unfasten the 2 hooks.)	 <p>(R3008)</p>

■ Clamp the harnesses and wires with clips as they were when reassembling. Negligence of above procedure may result in catching wire with the front panel and may cause malfunction.

Step	Procedure	Points
4	The illustration shows the control PCB.	<p>(R3009)</p> <p>■ Refer to page 14 for detail.</p>
5	Disconnect the terminals from the terminal board.	(R9072)

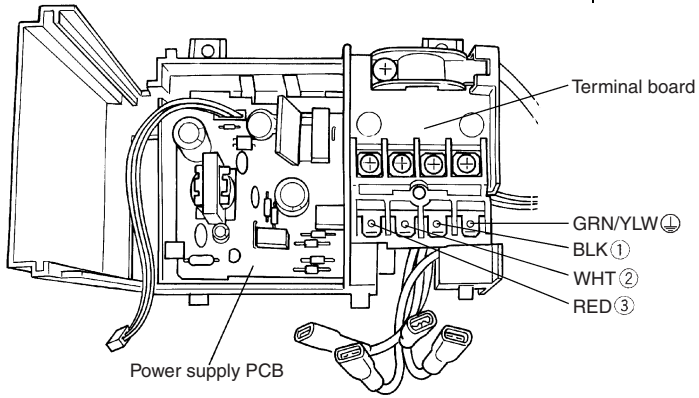
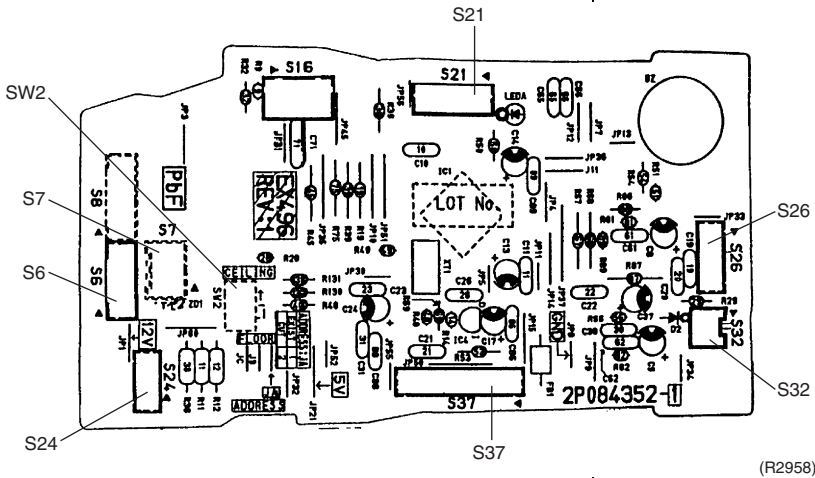
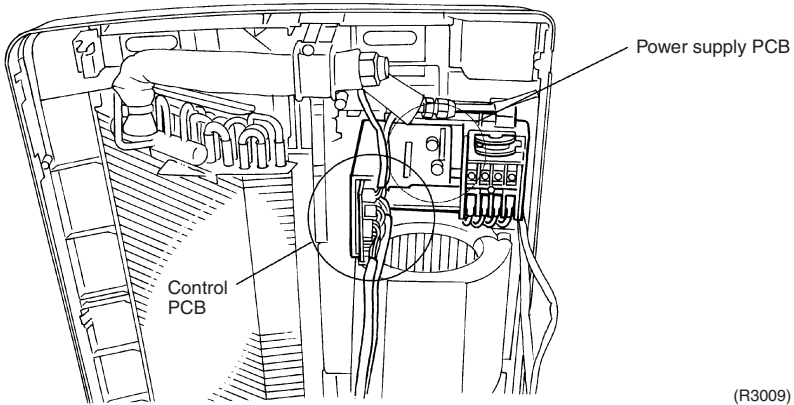

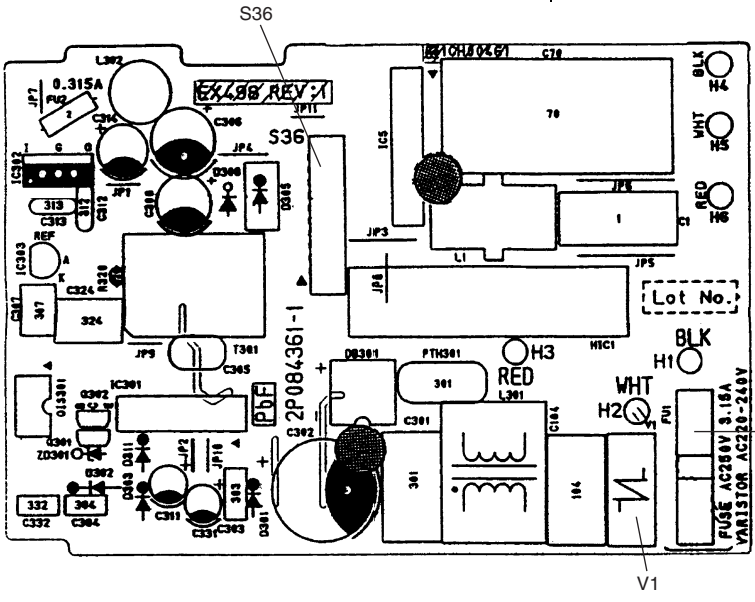
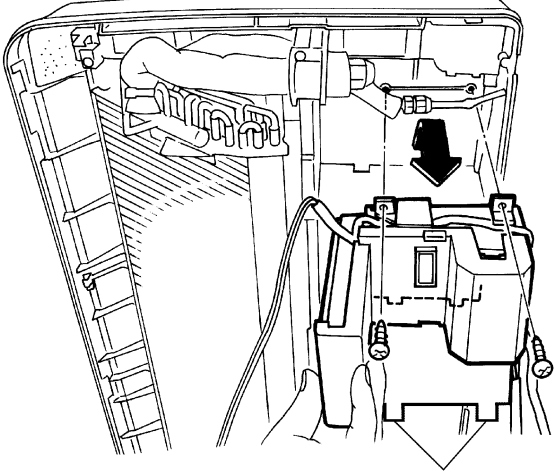
Step	Procedure	Points
<p>6</p>	<p>The illustration shows the power supply PCB.</p> 	<p>■ Refer to page 14 for detail.</p>
<p>2. Remove the electrical box.</p> <p>1</p>	<p>Remove the 2 screws. Remove the electrical box by sliding it to unfasten the hooks located at the opposite side of the electrical box.</p> 	<p>■ Slide the electrical box to the right side first to unfasten the hooks.</p>

1.8 Removal of Fan Rotor / Fan Motor

Procedure



Warning Be sure to wait 10 minutes or more after turning off all power supplies before disassembling work.

Step	Procedure	Procedure	Points
<p>1 Remove the 3 fan rotor covers. (Securing hooks are located at A and B-section.)</p> <p>■ The right illustration shows the opposite side.</p>		<p>A-section</p> <p>Fan rotor</p> <p>Fan rotor cover</p> <p>(R3014)</p> <p>B-section</p> <p>(R3015)</p>	<p>Hooks at A-section</p> <p>Hooks at B-section</p> <p>(R3016)</p>
<p>2 Disconnect the 2 relay harnesses at the rear side of the fan motor and unclamp the harness from the hook.</p>		<p>Fan motor</p> <p>(R3017)</p>	

Step	Procedure	Points
3	Remove the 2 screws to remove the fan motor fixtures.	
4	Remove the screw to remove the bearing fixture.	
5	Release the shaft supporting section using a hexagonal wrench (for M6) to remove the fan motor.	

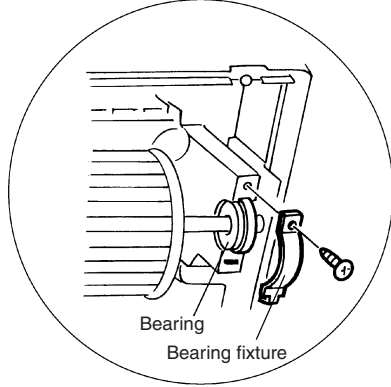
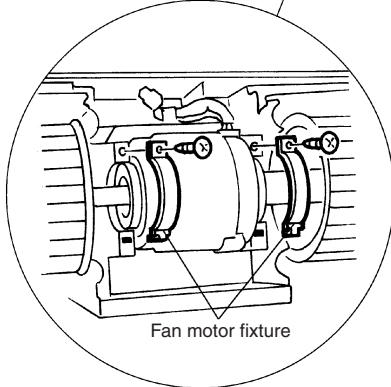
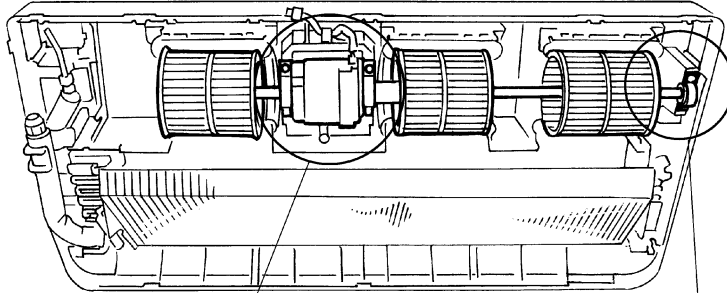

(R3018)

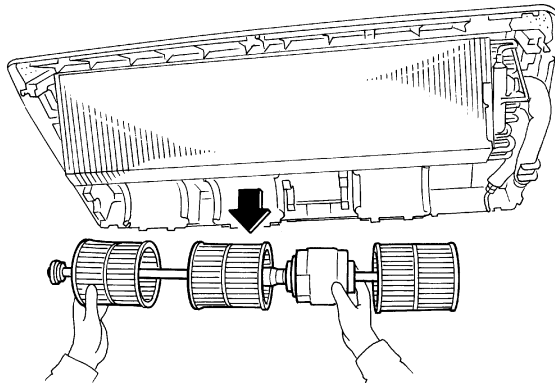

(R3019)

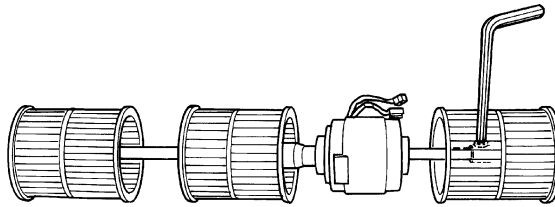

(R3020)

1.9 Removal of Indoor Heat Exchanger

Procedure

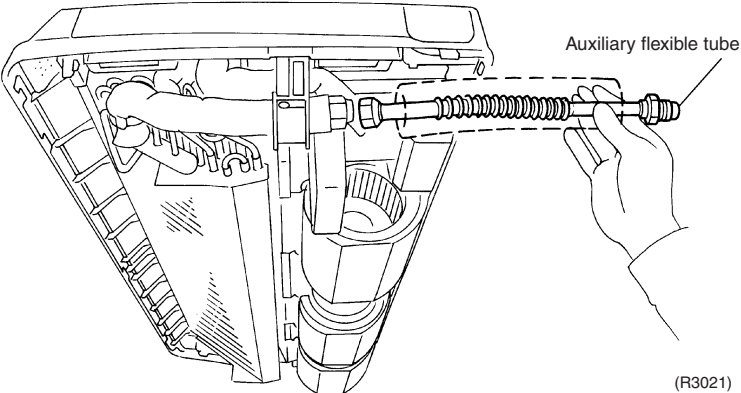
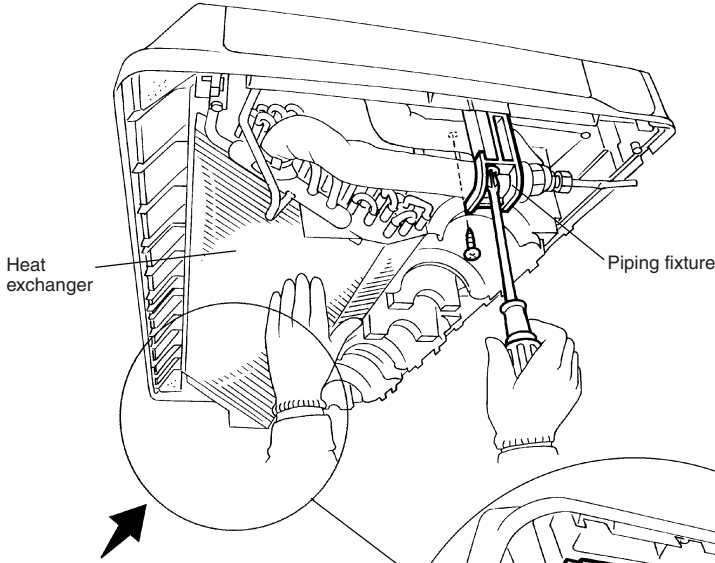
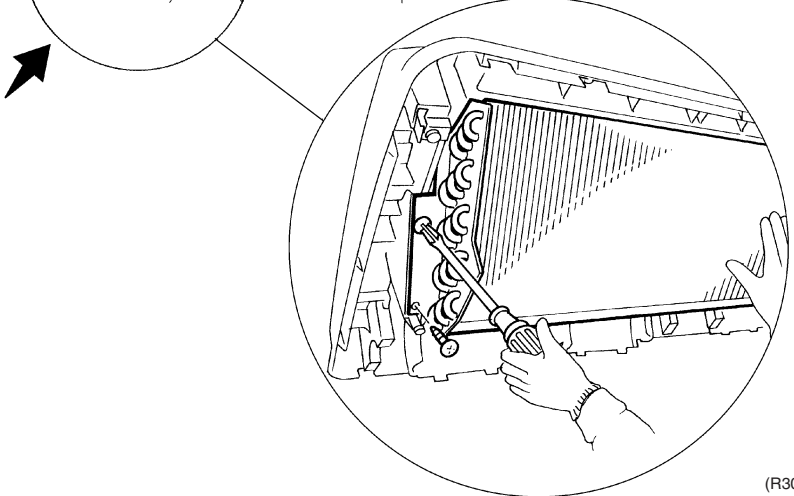

Warning Be sure to wait 10 minutes or more after turning off all power supplies before disassembling work.

Step	Procedure	Points
<p>■ Be sure to conduct pump down operation before disassembling the refrigerant pipe.</p>		
<p>1 Disconnect the auxiliary flexible tube.</p>		<p>(R3021)</p> <p>■ To prevent the indoor heat exchanger from falling down, the work should be done by 2 persons.</p>
<p>2 Remove the 2 screws of the piping fixture.</p>		
<p>3 Remove the 2 screws at the left side of the indoor heat exchanger.</p>		<p>(R3022)</p> <p>Caution When removing or reinstalling the indoor heat exchanger, be sure to wear protective gloves or wrap the indoor heat exchanger with cloths. (Fins can cut fingers.)</p>

Step	Procedure	Points
4	Hook is located on the right side behind the indoor heat exchanger.	<p>Warning Do not contaminate any gas (including air) other than the specified refrigerant (R-410A) into refrigerating cycle. (Contaminating of air or other gas causes abnormal temperature rise in refrigerating cycle, and this results in pipe breakage or personal injuries.)</p>
5	Slide the indoor heat exchanger to the right to release the hook.	<p>Warning If gas leaks, repair the spot of leaking, then collect all refrigerant from the unit. After conducting vacuum drying, charge proper amount of refrigerant.</p>
6	Remove the indoor heat exchanger.	

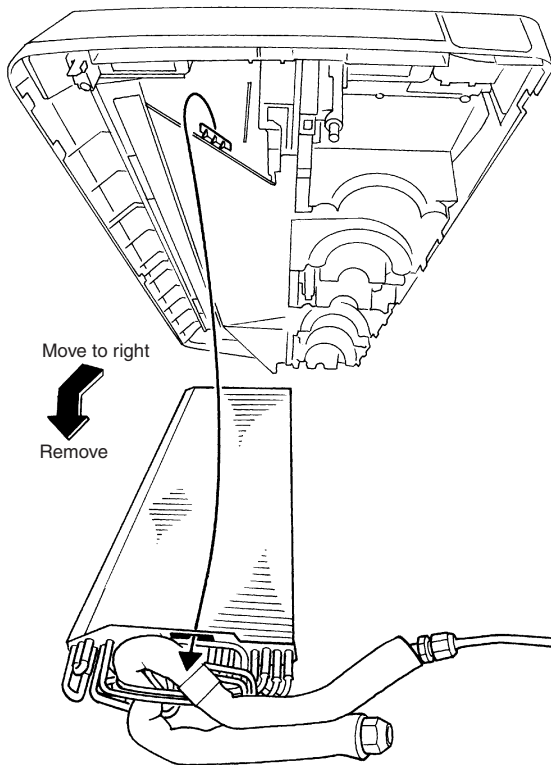

(R3023)

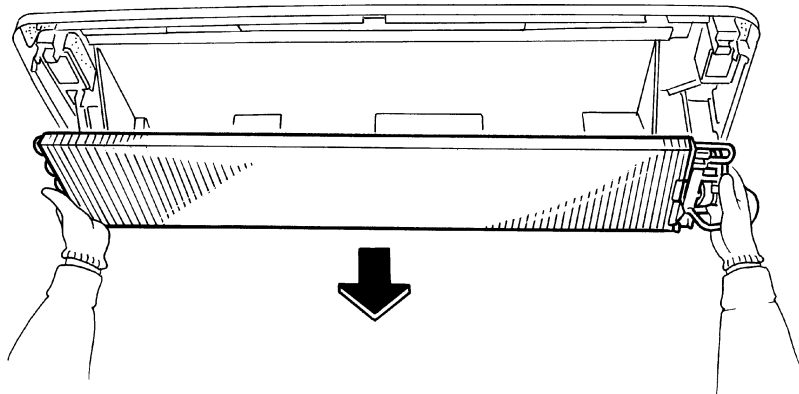

(R3024)

2. Outdoor Unit - RK(X)S25/35E2V1B

2.1 Removal of Outer Panels / Fan Motor

Procedure



Warning Be sure to wait 10 minutes or more after turning off all power supplies before disassembling work.

Step	Procedure	Points
1. Appearance features	<p>(R3235)</p> <p>(R11890)</p>	<ul style="list-style-type: none"> ■ Take care not to cut your finger by the fins of the outdoor heat exchanger.
2. Remove the panels.	<p>1 Remove the screw of the stop valve cover. Pull down the stop valve cover and remove it.</p> <p>Stop valve cover</p> <p>(R3237)</p> <p>Shield plate</p> <p>Hooks</p> <p>(R12421)</p>	<ul style="list-style-type: none"> ■ The stop valve cover is united with the shield plate. ■ When reassembling, make sure to fit the 5 hooks.

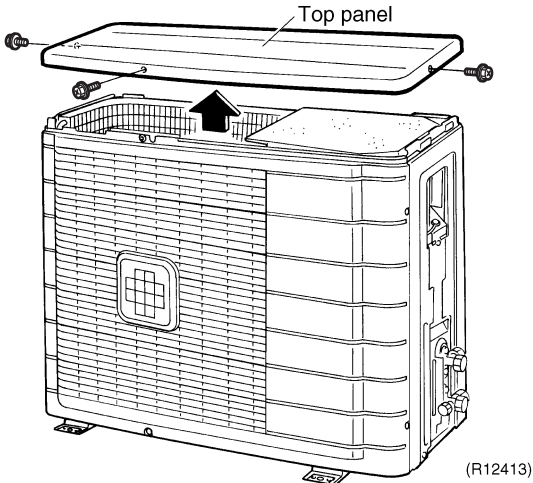
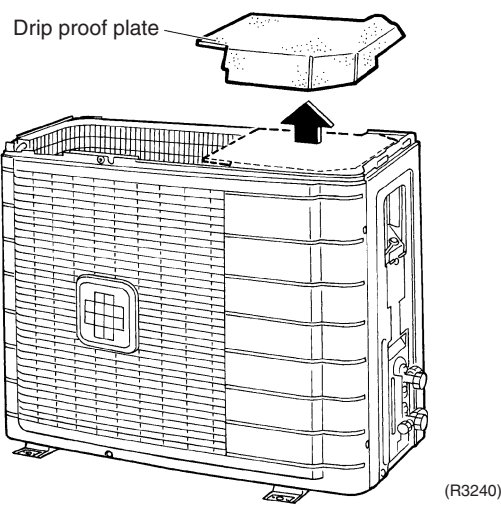
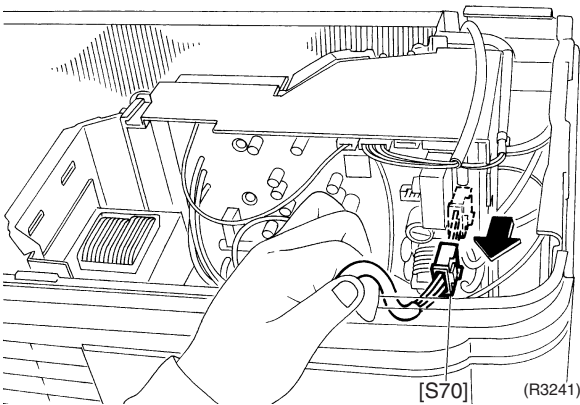
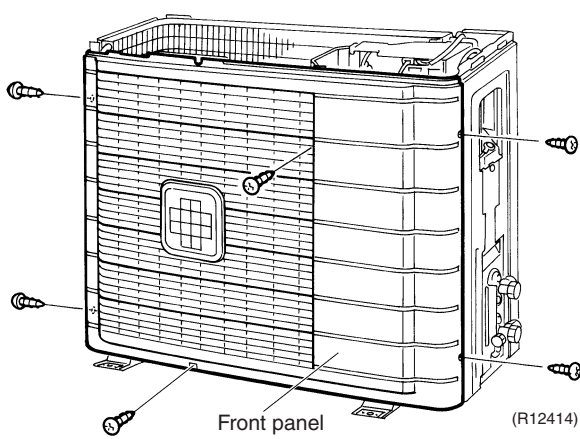
Step	Procedure	Points
2	<p>Remove the 3 screws and lift the top panel.</p> 	
3	<p>Remove the drip proof plate.</p> 	
4	<p>Disconnect the connector for the fan motor [S70].</p> 	<p>■ The fan motor is united with the front panel.</p>
5	<p>Remove the 6 screws of the front panel.</p> 	

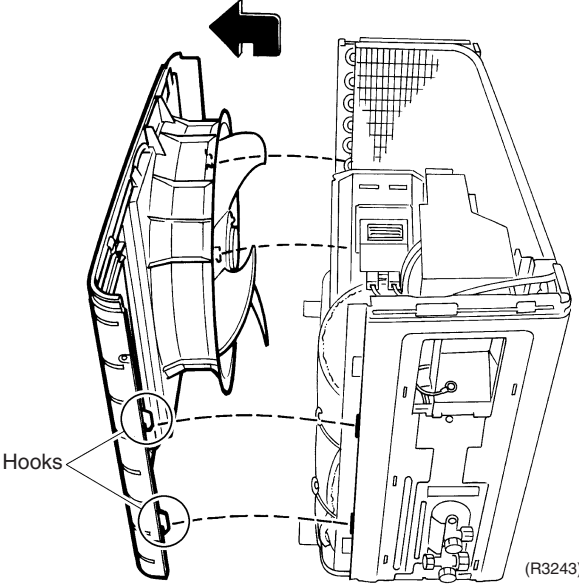
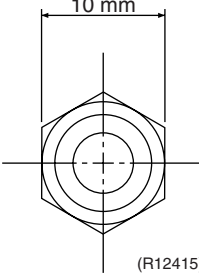
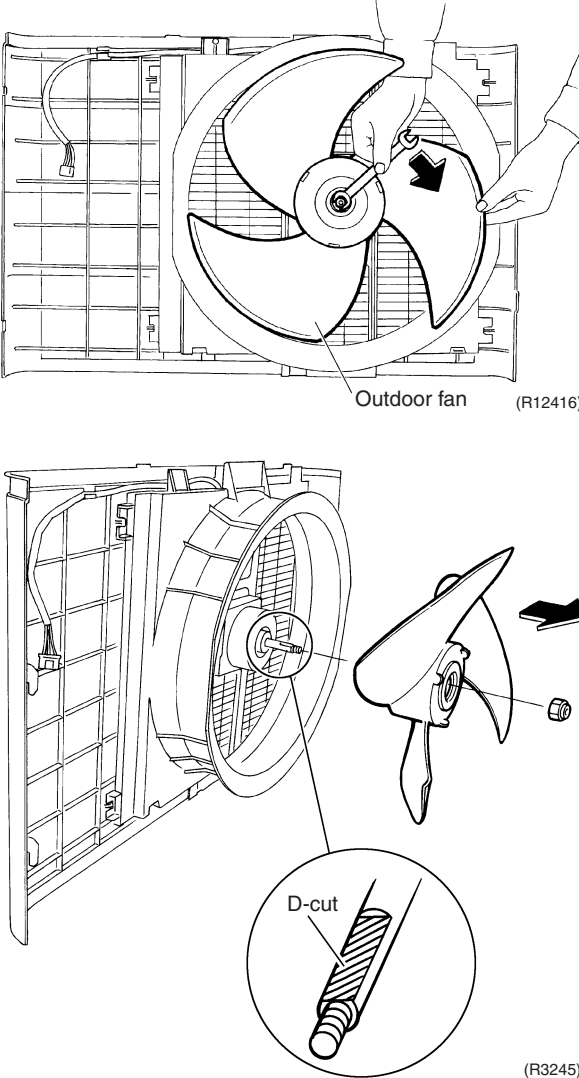
Step	Procedure	Points
6	<p>Unfasten the hooks. Pull and remove the front panel.</p>	<ul style="list-style-type: none"> ■ The front panel has 4 hooks.
<p>3. Remove the fan motor.</p>		<ul style="list-style-type: none"> ■ The screw has reverse winding. ■ Nut size: M6
1	<p>Unscrew the washer-fitted nut of the outdoor fan.</p>	
2	<p>Remove the outdoor fan.</p>	<ul style="list-style-type: none"> ■ When reassembling, align ▼ mark of the outdoor fan with D-cut section of the motor shaft.
		

Step	Procedure	Points
3	Remove the 2 screws and lift the bell mouth to unfasten the hooks.	
4	Remove the bell mouth.	
5	Open the hooks and release the fan motor lead wire.	<p>■ When reassembling, put the fan motor lead wire through the back of the fan motor (so as not to be entangled with the outdoor fan)</p>

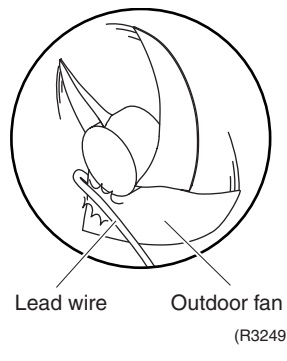
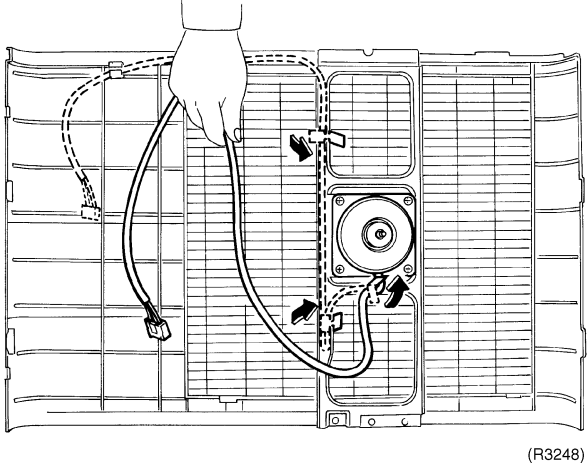
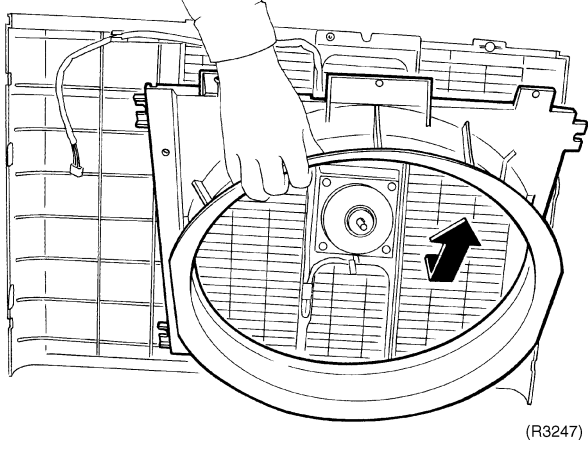
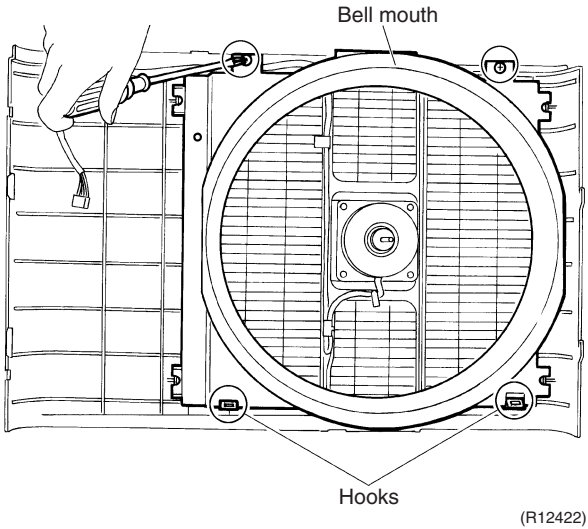

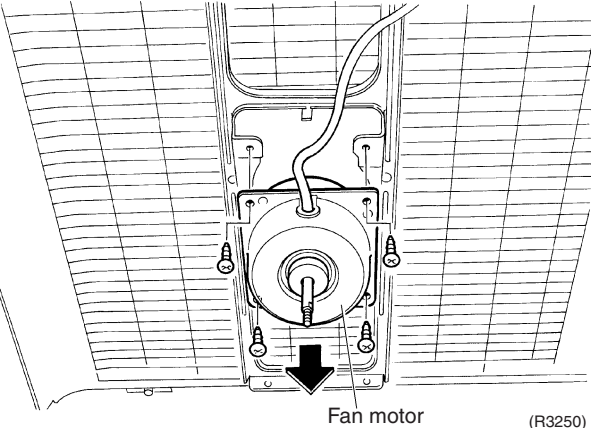
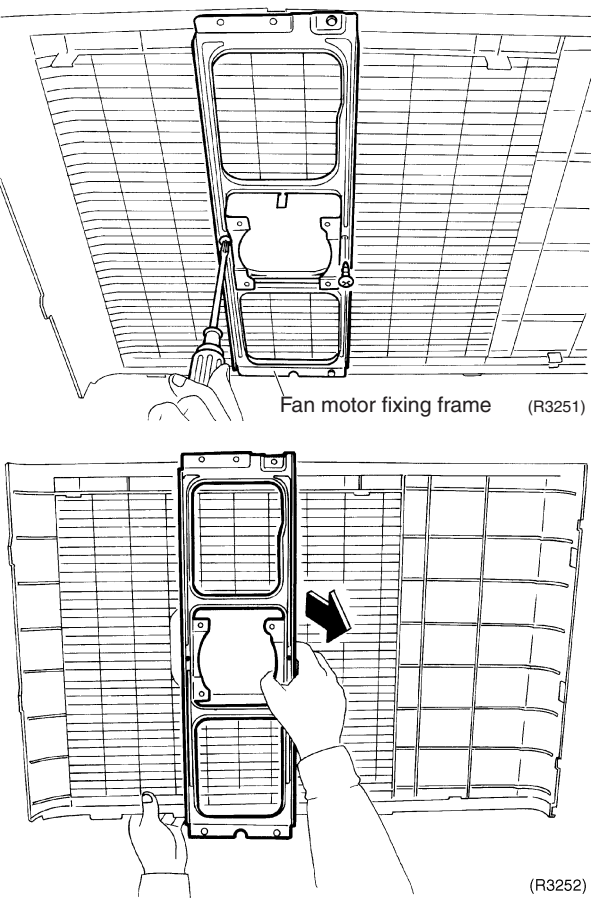
Step	Procedure	Points
6	<p>Remove the 4 screws and remove the fan motor.</p> 	<p>■ M4×16</p>
7	<p>Remove the 2 screws and remove the fan motor fixing frame.</p> 	

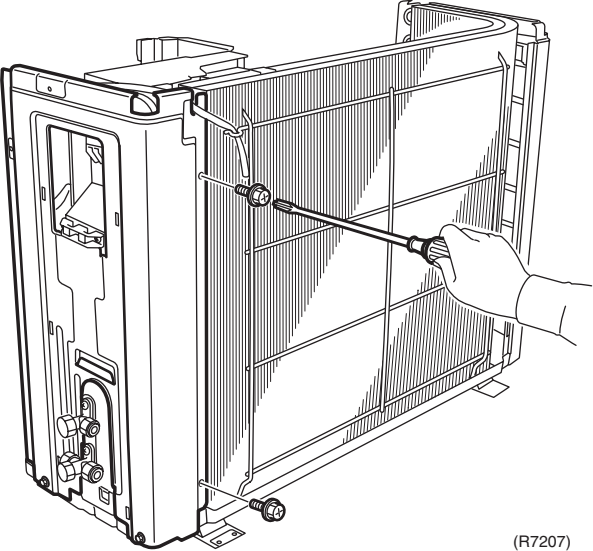
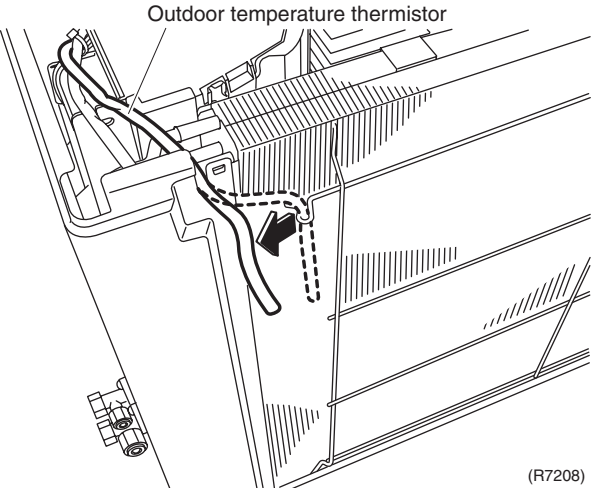
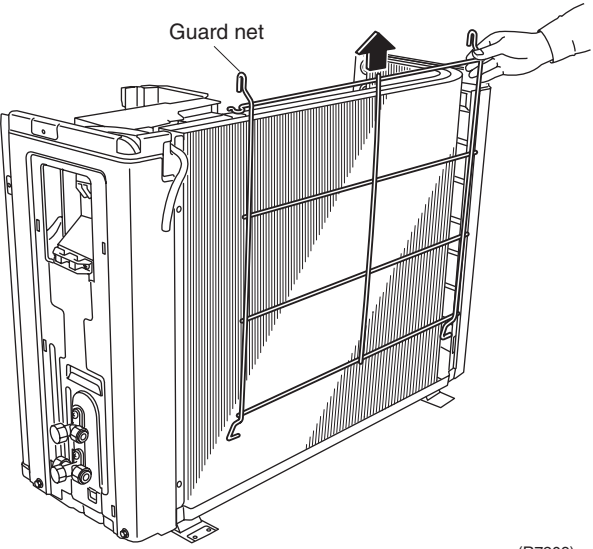
Step	Procedure	Points
4.	Remove the right side panel.	
1	<p>Remove the 2 screws on the rear side.</p>  <p>(R7207)</p>	
2	<p>Release the outdoor temperature thermistor.</p>  <p>Outdoor temperature thermistor</p> <p>(R7208)</p>	
3	<p>Lift up the guard net and remove it.</p>  <p>Guard net</p> <p>(R7209)</p>	

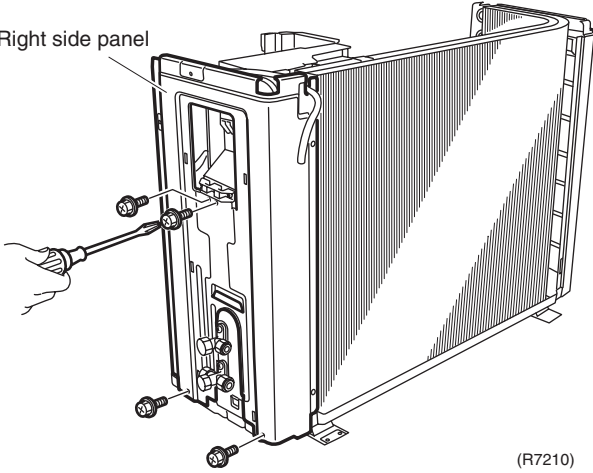
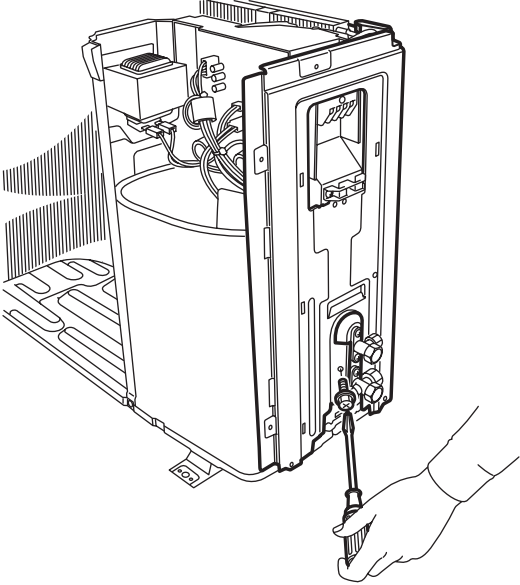
Step	Procedure	Points
4	<p data-bbox="199 217 459 277">Remove the 4 screws on the right side panel.</p>  <p data-bbox="1002 678 1066 701">(R7210)</p>	
5	<p data-bbox="199 721 467 784">Remove the screw near the stop valves.</p>  <p data-bbox="975 1323 1038 1346">(R7211)</p>	

Step	Procedure	Points
6	Unfasten the hook on the rear side.	<ul style="list-style-type: none"> ■ When reassembling, make sure to fit the hook.
7	Lift up the right side panel and remove it.	<ul style="list-style-type: none"> ■ When reassembling, make sure to fit the hook.

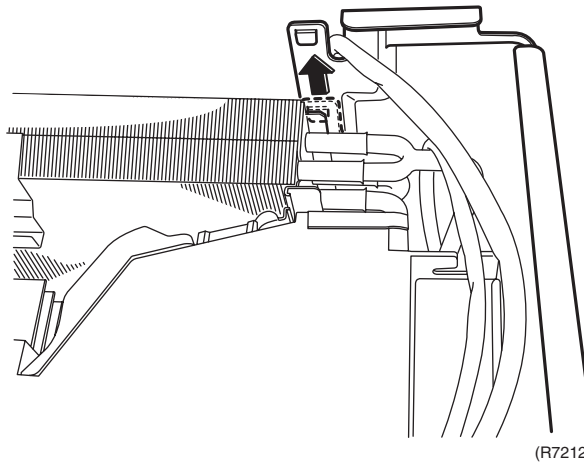

(R7212)

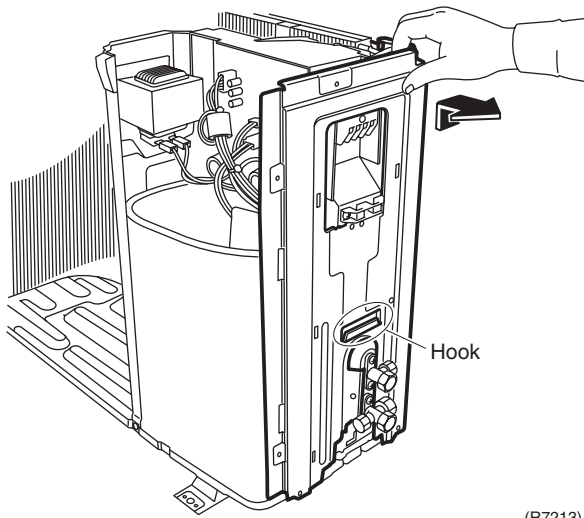

(R7213)

2.2 Removal of Electrical Box

Procedure

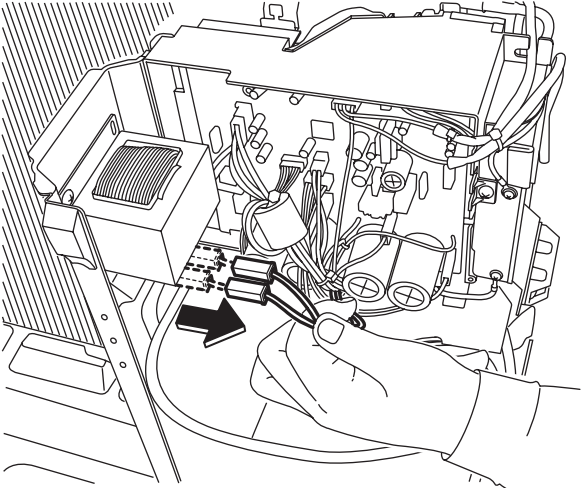
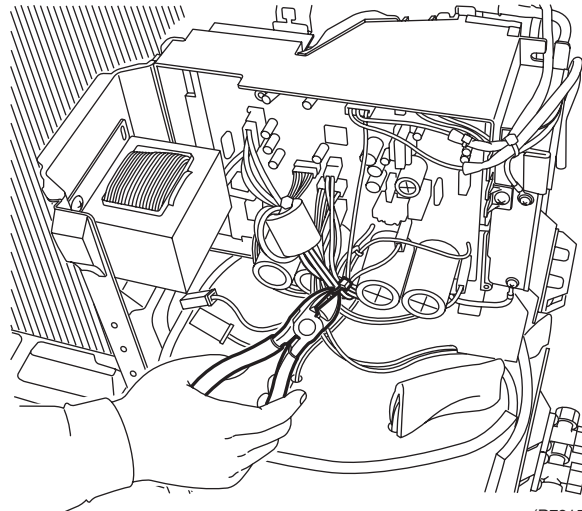
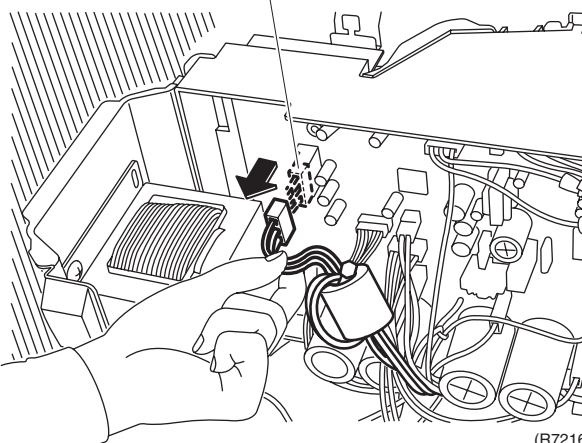

Warning Be sure to wait 10 minutes or more after turning off all power supplies before disassembling work.

Step	Procedure	Points
1. Remove the electrical box.		Preparation <ul style="list-style-type: none"> ■ Remove the panels and disconnect the connector for the fan motor according to "Removal of Outer Panels / Fan Motor".
1	Disconnect the 2 connectors for the reactor.  <p style="text-align: right;">(R7214)</p>	
2	Cut the clamp.  <p style="text-align: right;">(R7215)</p>	
3	Disconnect the connector for the compressor [S30].  <p style="text-align: right;">(R7216)</p>	<ul style="list-style-type: none"> ■ When reassembling, coil the excessive lead wire and hang the loop on the hook.

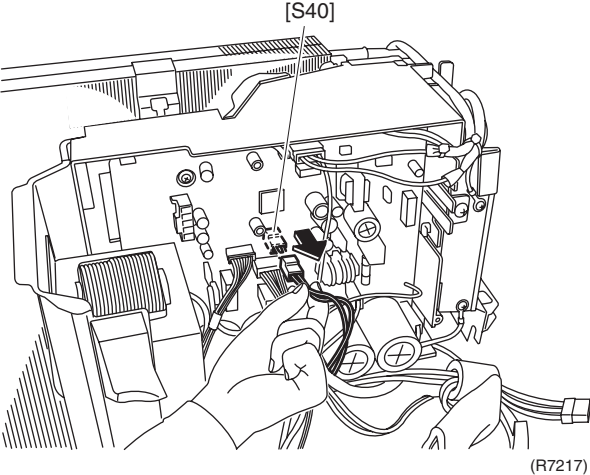
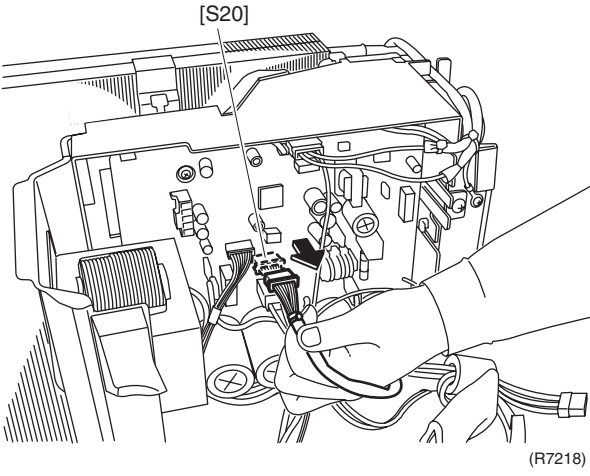
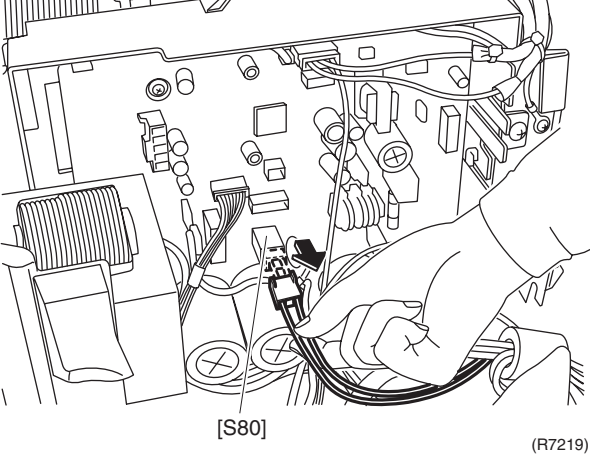
Step	Procedure	Points
4	<p>Disconnect the connector for the overload protector [S40].</p> 	
5	<p>Disconnect the connector for the electronic expansion valve coil [S20].</p> 	
6	<p>Disconnect the connector for the four way valve coil [S80].</p> 	

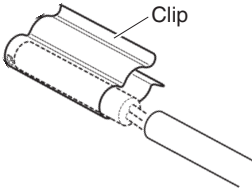
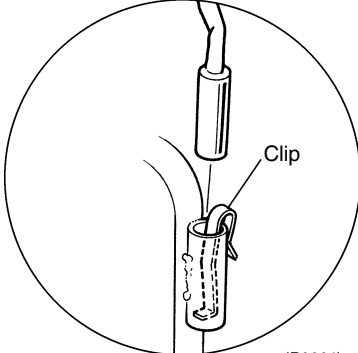
Step	Procedure	Points
7	Release the discharge pipe thermistor.	<p>■ Be careful not to lose the clip for the thermistor.</p>  <p>Clip</p> <p>(R12279)</p>
8	Cut the clamp.	
9	Pull out the outdoor heat exchanger thermistor.	<p>■ Be careful not to lose the clip for the thermistor.</p>  <p>Clip</p> <p>(R3264)</p>

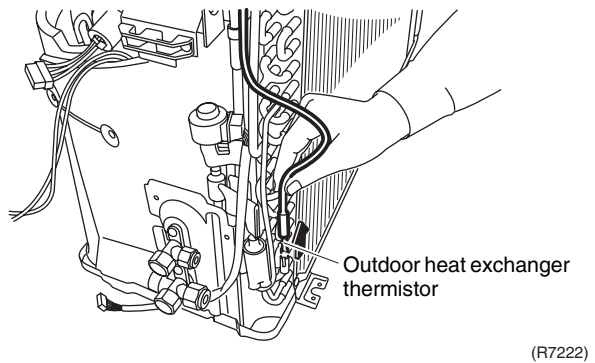
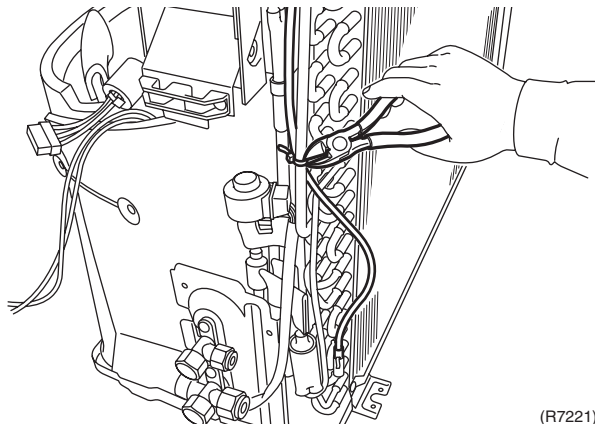
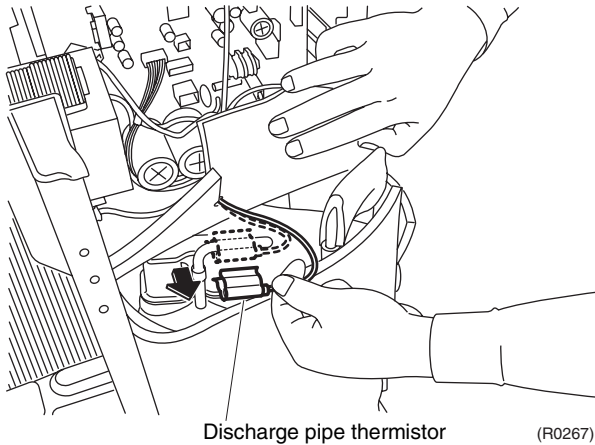

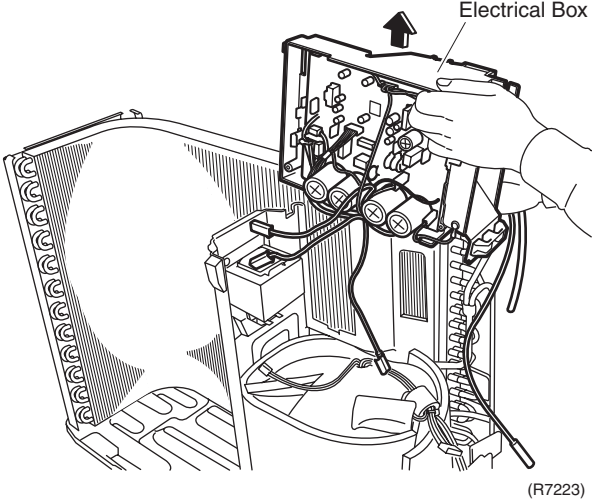
Step	Procedure	Points
<p>10</p>	<p>Lift and remove the electrical box.</p> 	

2.3 Removal of PCB

Procedure



Warning Be sure to wait 10 minutes or more after turning off all power supplies before disassembling work.

Step	Procedure	Procedure	Points
1	Feature of the main PCB	<p style="text-align: right;">(R7255)</p>	<ul style="list-style-type: none"> ■ You can remove the main PCB when you disconnect the lead wires on the terminal board without removing the electrical box.
2	Remove the screw on the terminal board.	<p style="text-align: right;">(R7256)</p>	
3	Release the 2 earth terminals.	<p style="text-align: right;">(R7257)</p>	

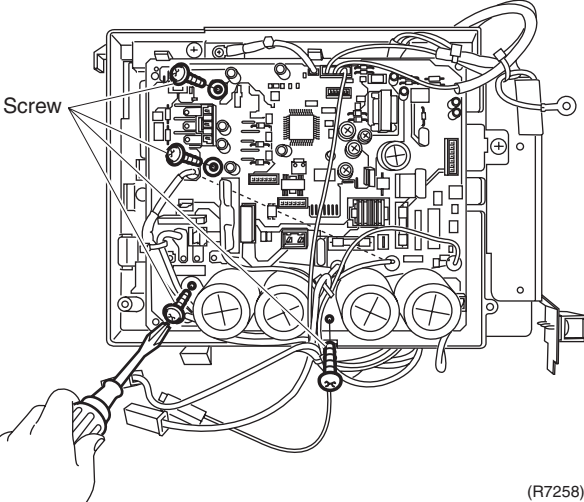
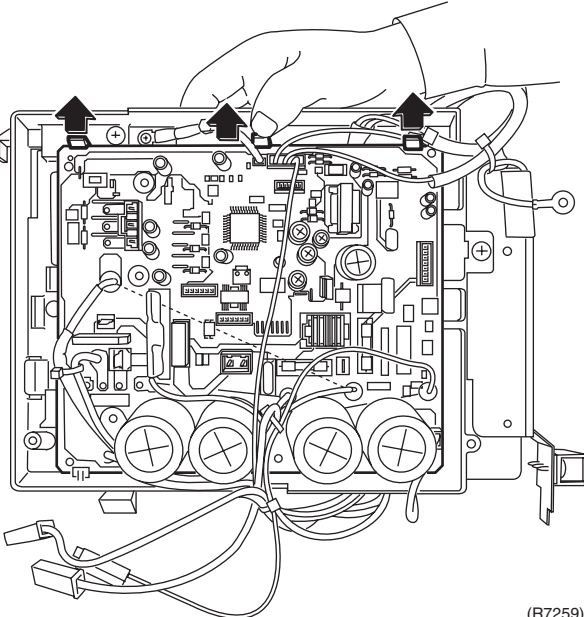
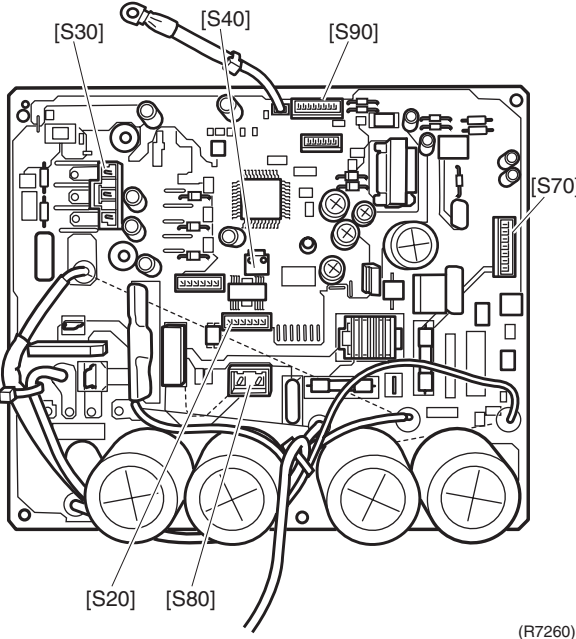
Step	Procedure	Points
4	<p>Remove the 4 screws.</p>  <p>(R7258)</p>	
5	<p>Unfasten the 3 hooks on the upper side.</p>  <p>(R7259)</p>	
6	<p>Lift and pull out the main PCB.</p>  <p>(R7260)</p>	<p>■ Refer to page 16 for detail.</p> <p>[S20]: electronic expansion valve coil [S30]: compressor [S40]: overload protector [S70]: fan motor [S80]: four way valve coil [S90]: thermistors</p>

2.4 Removal of Reactor / Partition Plate

Procedure

 **Warning** Be sure to wait 10 minutes or more after turning off all power supplies before disassembling work.

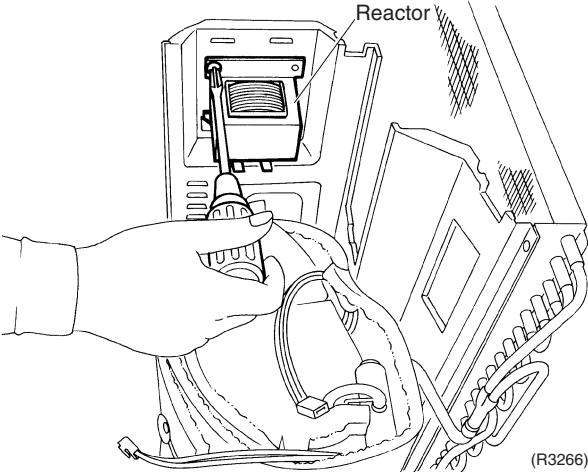
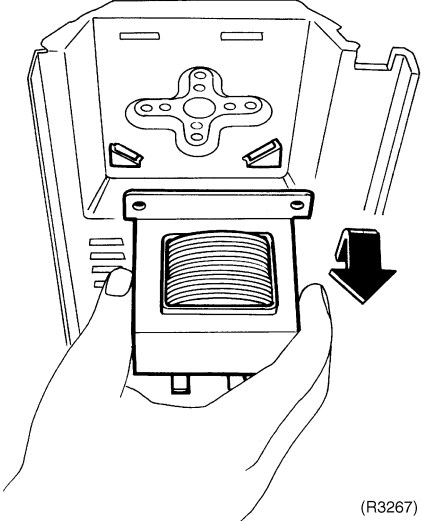
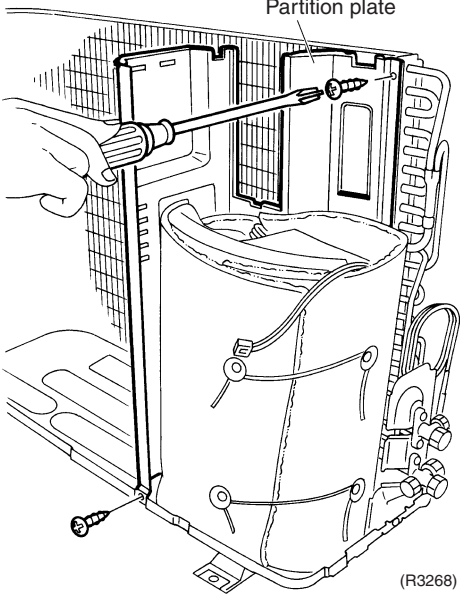
Step	Procedure	Points
<p>1. Remove the reactor.</p> <p>1 Remove the screw and remove the reactor.</p>	 <p>(R3266)</p>  <p>(R3267)</p>	<p>Preparation</p> <ul style="list-style-type: none"> ■ Remove the outer panels according to the "Removal of Outer Panels / Fan Motor". ■ Remove the electrical box according to the "Removal of Electrical Box".
<p>2. Remove the partition plate.</p> <p>1 Remove the 2 screws.</p>	 <p>(R3268)</p>	

Step	Procedure	Points
2	<p>The partition plate has a hook on the lower side. Lift and pull the partition plate to remove.</p>	<ul style="list-style-type: none"> ■ When reassembling, fit the lower hook into the bottom frame.

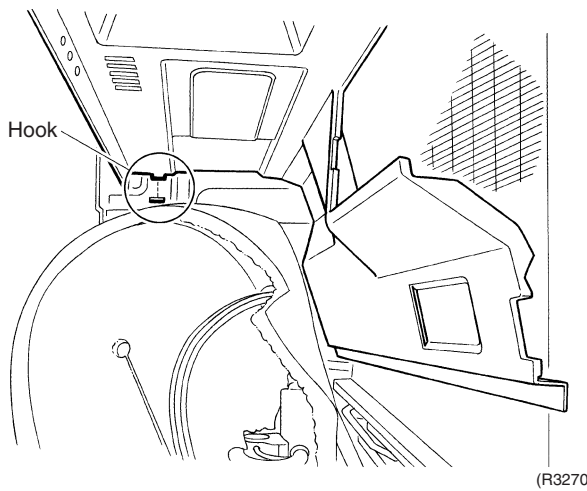
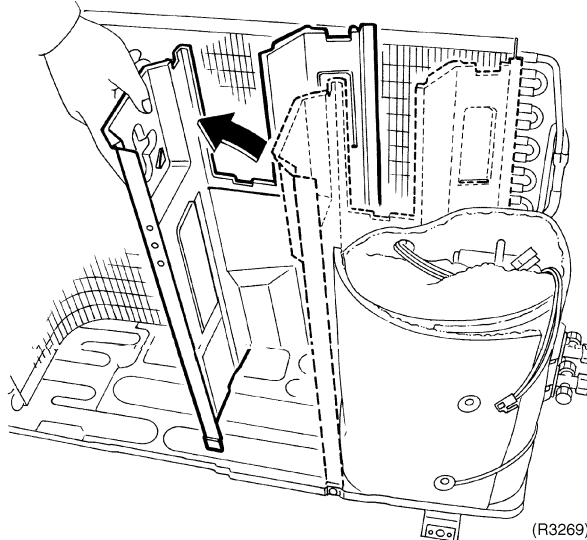

2.5 Removal of Sound Blanket

Procedure

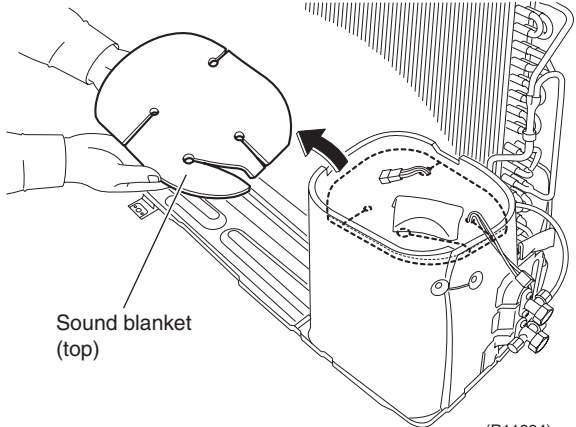
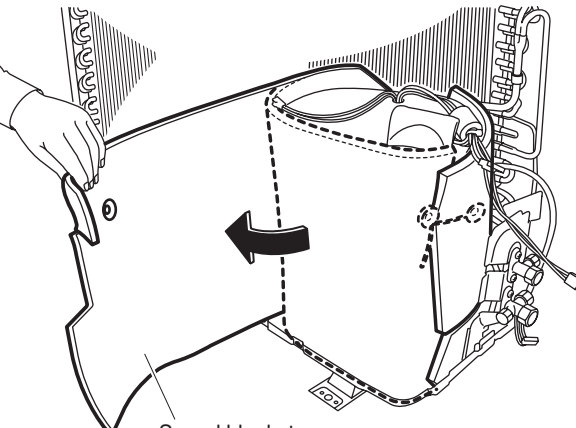
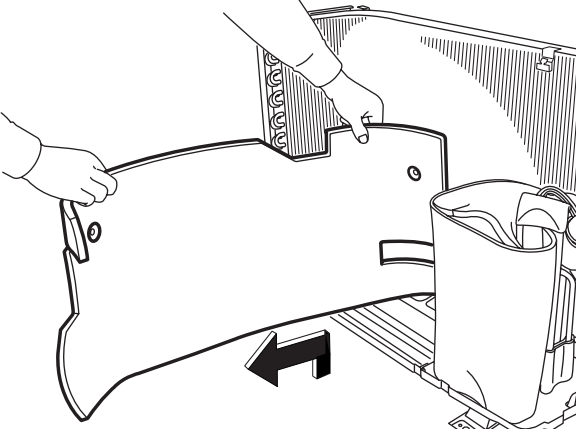

Warning Be sure to wait 10 minutes or more after turning off all power supplies before disassembling work.

Step	Procedure	Procedure	Points
1	Remove the sound blanket (top).	 <p>(R11884)</p>	<ul style="list-style-type: none"> Since the piping ports are torn easily, remove the sound blanket carefully.
2	Untie the string and open the sound blanket (outer).	 <p>(R7229)</p>	
3	Lift and remove the sound blanket (outer).	 <p>(R7230)</p>	

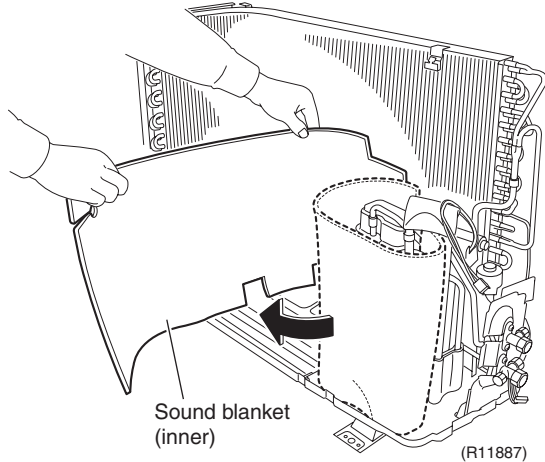
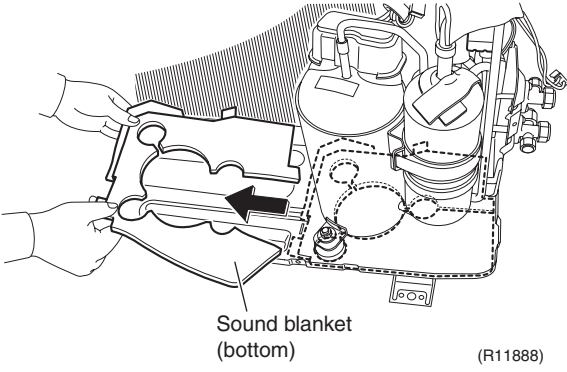
Step	Procedure	Points
4	<p>Pull the sound blanket (inner) out.</p> 	
5	<p>Pull the sound blanket (bottom) out.</p> 	

2.6 Removal of Four Way Valve

Procedure

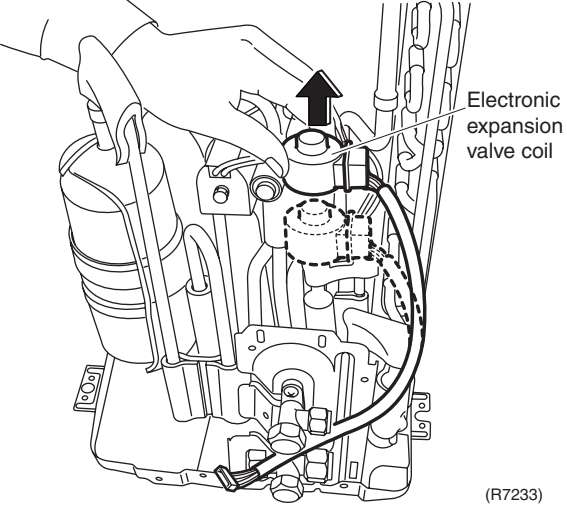
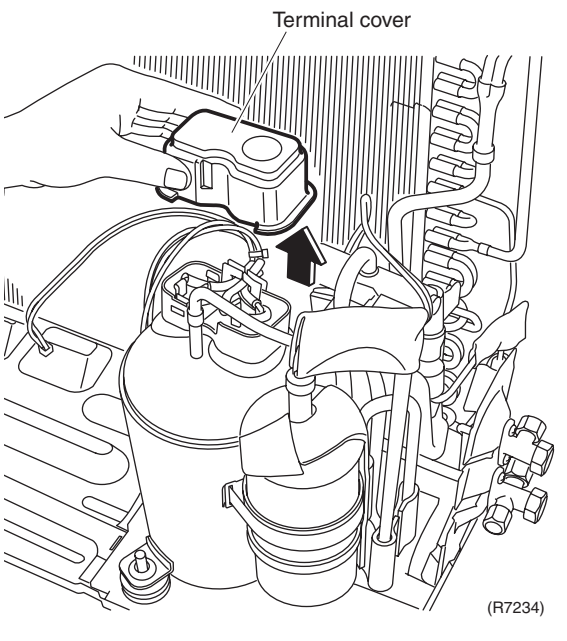
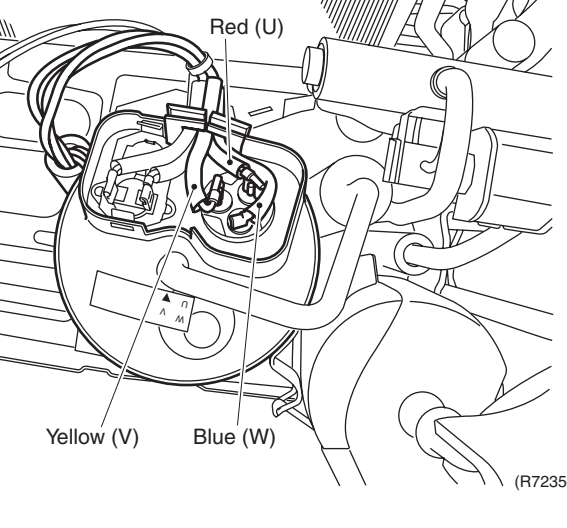

Warning Be sure to wait for 10 minutes or more after turning off all power supplies before disassembling work.

Step	Procedure	Procedure	Points
1	Pull out the electronic expansion valve coil.	 <p>(R7233)</p>	
2	Remove the terminal cover.	 <p>(R7234)</p>	
3	Disconnect the lead wires of the compressor.	 <p>(R7235)</p>	

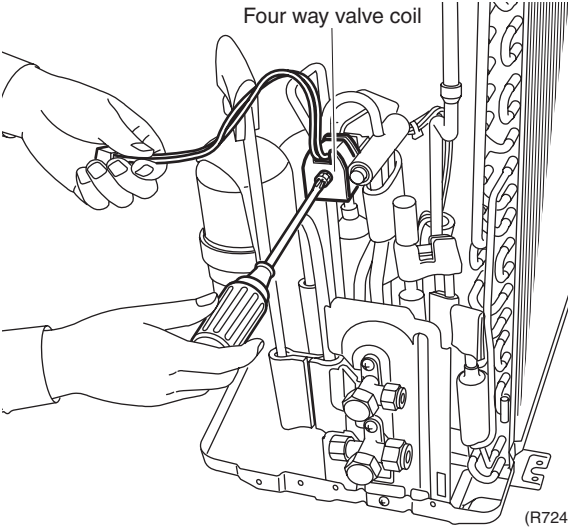
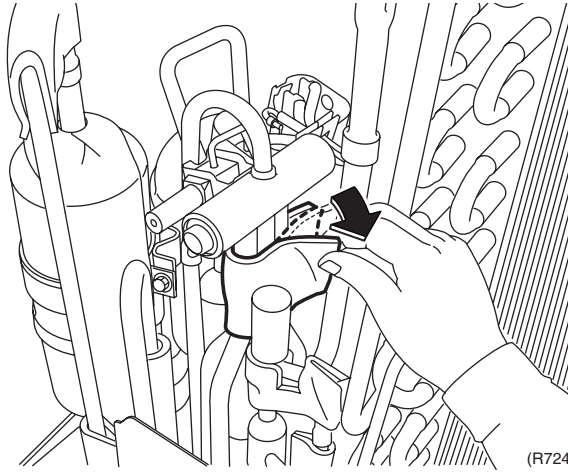
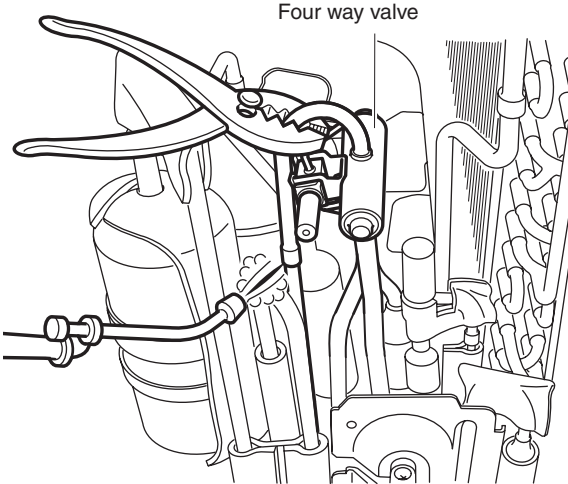
Step	Procedure	Points
<p>4 Remove the screw and remove the four way valve coil.</p>	 <p style="text-align: center;">Four way valve coil</p> <p style="text-align: right;">(R7247)</p>	<p>Warning Be careful not to get yourself burnt with the pipes and other parts that are heated by the gas brazing machine.</p> <p>Warning If the refrigerant gas leaks during work, ventilate the room. (If the refrigerant gas is exposed to flames, toxic gas may be generated.)</p> <p>Caution From the viewpoint of global environment protection, do not discharge the refrigerant gas in the atmosphere. Make sure to collect all the refrigerant gas.</p> <p>Cautions for restoration</p> <ol style="list-style-type: none"> 1. Restore the piping by non-oxidation brazing. 2. It is required to prevent the carbonization of the oil inside the four way valve and the deterioration of the gaskets affected by heat. (Keep below 120°C.) For the sake of this, wrap the four way valve with wet cloth and provide water so that the cloth does not dry.
<ul style="list-style-type: none"> ■ Before working, make sure that the refrigerant gas is empty in the circuit. ■ Be sure to apply nitrogen replacement when heating up the brazed part. 	 <p style="text-align: center;">Four way valve</p> <p style="text-align: right;">(R7248)</p>	<p>In case of difficulty with gas brazing machine</p> <ol style="list-style-type: none"> 1. Disconnect the brazed part where is easy to disconnect and restore. 2. Cut pipes on the main unit in order to make it easy to disconnect.
<p>6 Heat up the brazed part and withdraw the piping with pliers.</p>	 <p style="text-align: center;">Four way valve</p> <p style="text-align: right;">(R7249)</p>	

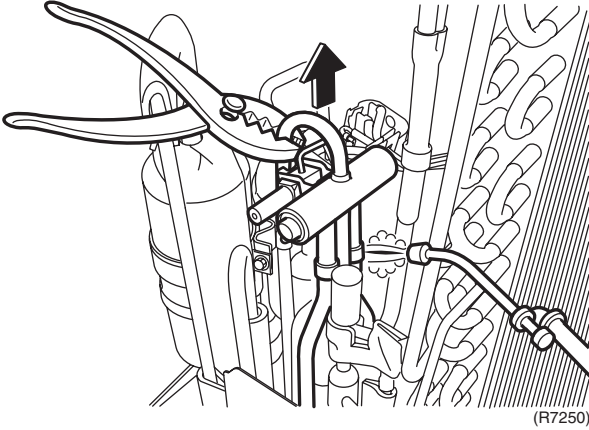
Step	Procedure	Points
	 <p>(R7250)</p>	<p>Note:</p> <ul style="list-style-type: none">■ Do not use a metal saw for cutting pipes by all means because the sawdust comes into the circuit.■ When withdrawing the pipes, be careful not to pinch them firmly with pliers. The pipes may get deformed.■ Provide a protective sheet or a steel plate so that the brazing flame cannot influence peripheries.

2.7 Removal of Compressor

Procedure

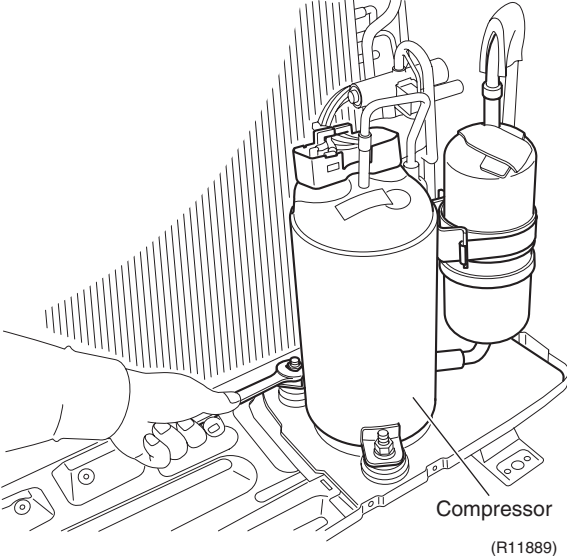
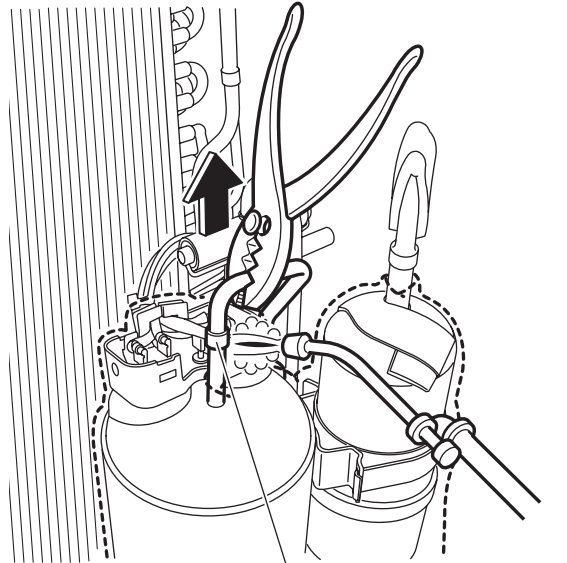

Warning Be sure to wait for 10 minutes or more after turning off all power supplies before disassembling work.

Step	Procedure	Points
1	<p>Remove the 2 nuts of the compressor.</p> 	<p>Warning Be careful not to get yourself burnt with the pipes and other parts that are heated by the gas brazing machine.</p> <p>Warning If the refrigerant gas leaks during work, ventilate the room. (If the refrigerant gas is exposed to flames, toxic gas may be generated.)</p> <p>Warning Since it may happen that the refrigerant oil in the compressor catches fire, prepare wet cloth so as to extinguish fire immediately.</p>
<ul style="list-style-type: none"> ■ Before working, make sure that the refrigerant is empty in the circuit. ■ Be sure to apply nitrogen replacement when heating up the brazed part. 		<p>Caution From the viewpoint of global environment protection, do not discharge the refrigerant gas in the atmosphere. Make sure to collect all the refrigerant gas.</p>
2	<p>Heat up the brazed part of the discharge side and disconnect.</p>	<p>Cautions for restoration</p> <ol style="list-style-type: none"> 1. Restore the piping by non-oxidation brazing. 2. It is required to prevent the carbonization of the oil inside the four way valve and the deterioration of the gaskets affected by heat. (Keep below 120°C.) For the sake of this, wrap the four way valve with wet cloth and provide water so that the cloth does not dry. <p>In case of difficulty with gas brazing machine</p> <ol style="list-style-type: none"> 1. Disconnect the brazed part where is easy to disconnect and restore. 2. Cut pipes on the main unit with a tube cutter in order to make it easy to disconnect.

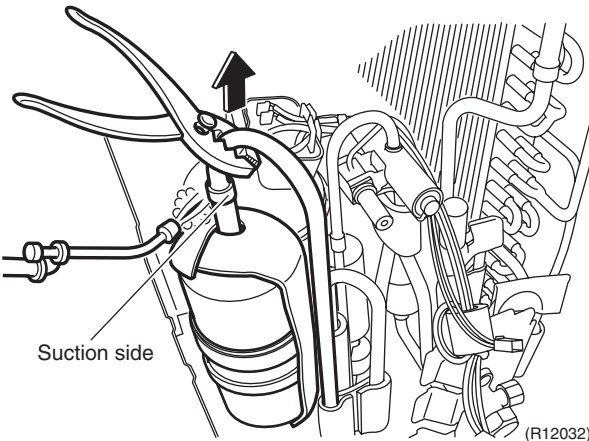
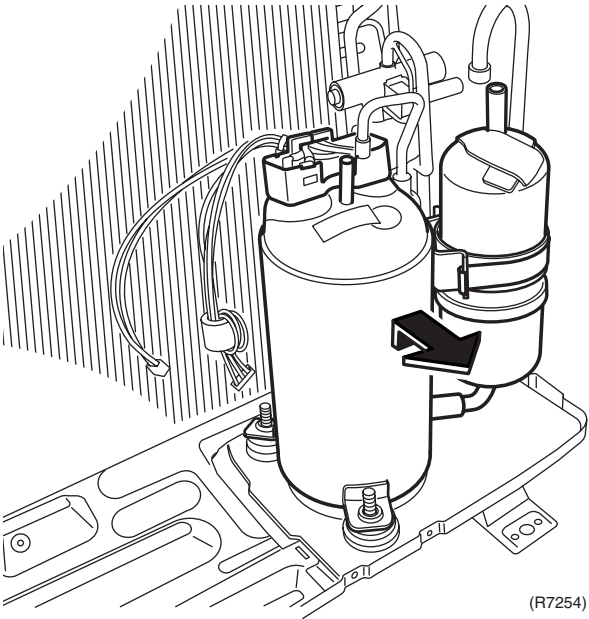
Step	Procedure	Points
3	Heat up the brazed part of the suction side and disconnect. 	Note: <ul style="list-style-type: none"> ■ Do not use a metal saw for cutting pipes by all means because the sawdust comes into the circuit. ■ When withdrawing the pipes, be careful not to pinch them firmly with pliers. The pipes may get deformed. ■ Provide a protective sheet or a steel plate so that the brazing flame cannot influence peripheries.
4	Lift the compressor up and remove it. 	<ul style="list-style-type: none"> ■ Be careful so as not to burn the compressor terminals, the name plate, the heat exchanger fin.

3. Outdoor Unit - RK(X)S25/35G2V1B

3.1 Removal of Outer Panels / Fan Motor

Procedure



Warning Be sure to wait for 10 minutes or more after turning off all power supplies before disassembling work.

Step	Procedure	Points
1. Appearance features	<p>(R7186)</p> <p>(R11890)</p>	<ul style="list-style-type: none"> Take care not to cut your finger by the fins of the outdoor heat exchanger.
2. Remove the panels.	<p>1 Remove the screw of the stop valve cover. Pull down the stop valve cover and remove it.</p> <p>(R7188)</p> <p>(R7189)</p>	<ul style="list-style-type: none"> The stop valve cover is united with the shield plate. When reassembling, make sure to fit the 5 hooks.

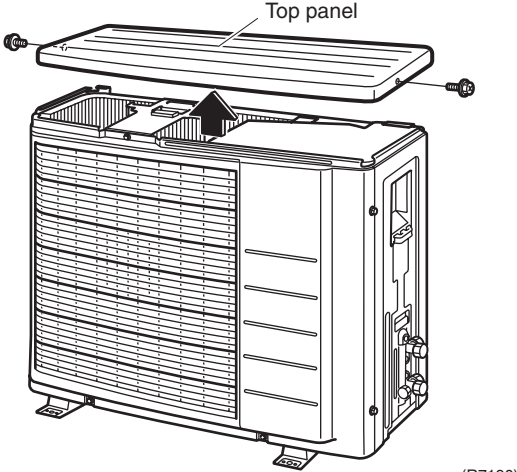
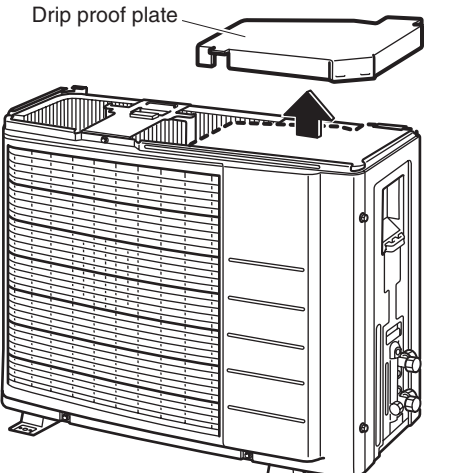
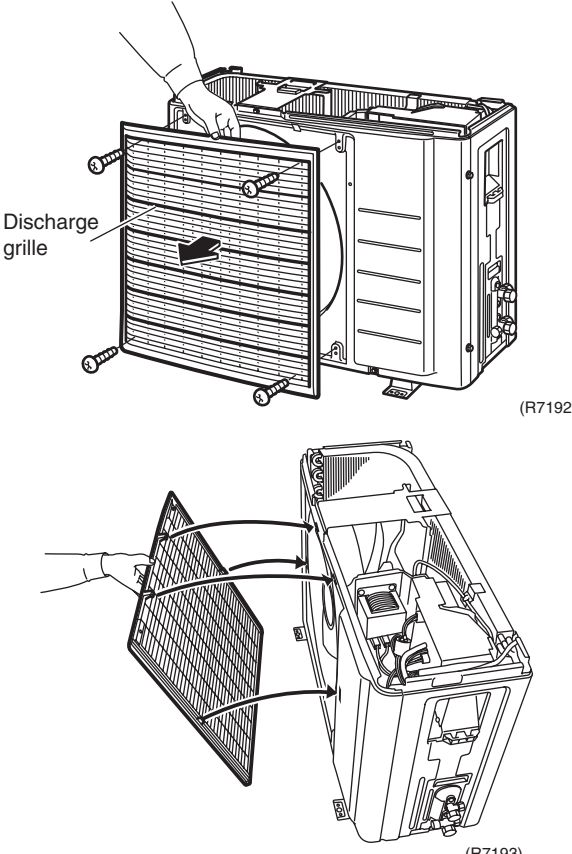
Step		Procedure	Points
2	Remove the 2 screws and lift the top panel.	 <p>Top panel</p> <p>(R7190)</p>	
3	Remove the drip proof plate.	 <p>Drip proof plate</p> <p>(R7191)</p>	
4	Remove the 4 screws and remove the discharge grille.	 <p>Discharge grille</p> <p>(R7192)</p> <p>(R7193)</p>	<p>■ The discharge grille has 4 hooks.</p>

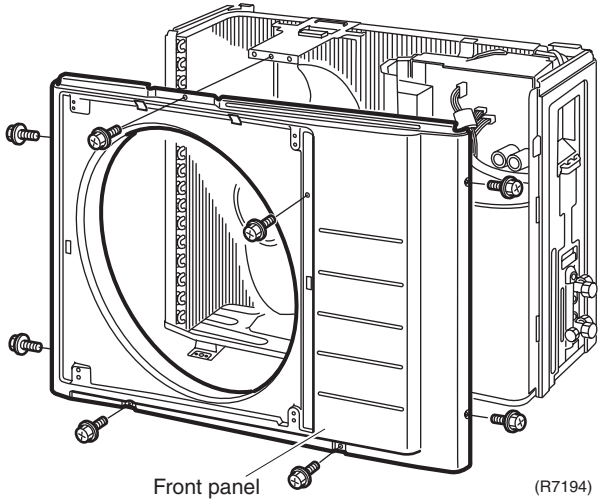
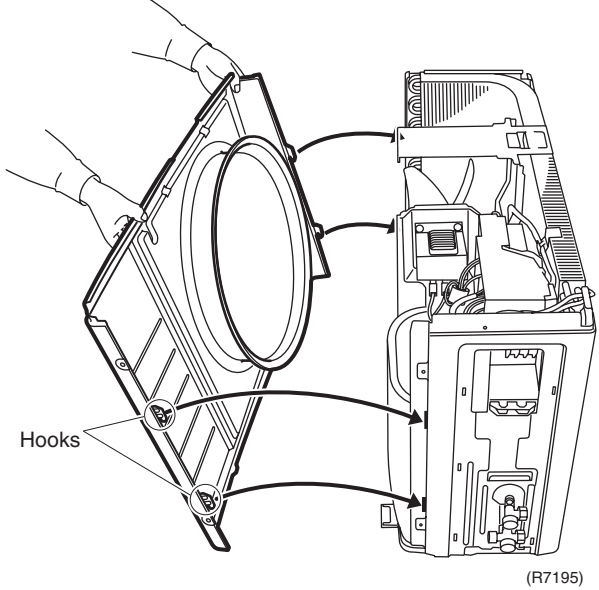
Step	Procedure	Points
5	Remove the 8 screws of the front panel.	
	 <p>Front panel (R7194)</p>	
6	Unfasten the hooks. Pull and remove the front panel.	<ul style="list-style-type: none"> ■ The front panel has 4 hooks.
	 <p>Hooks (R7195)</p>	

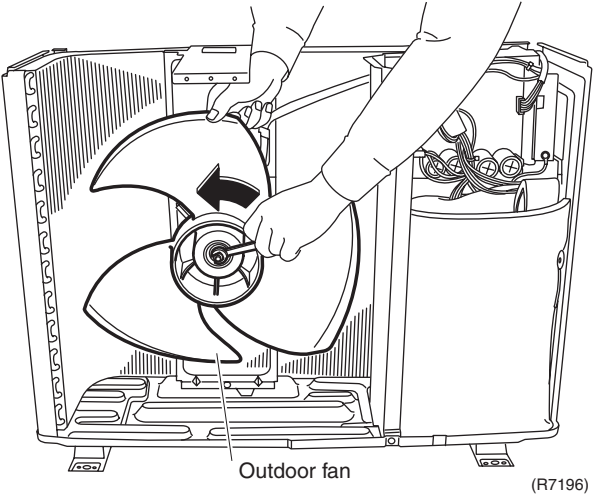
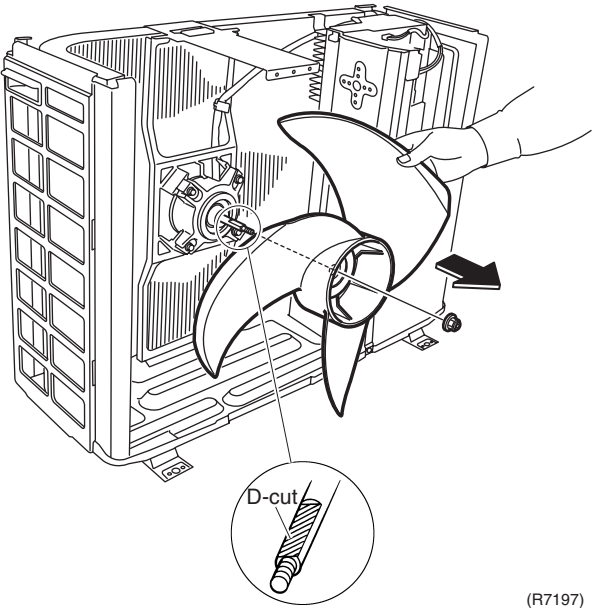
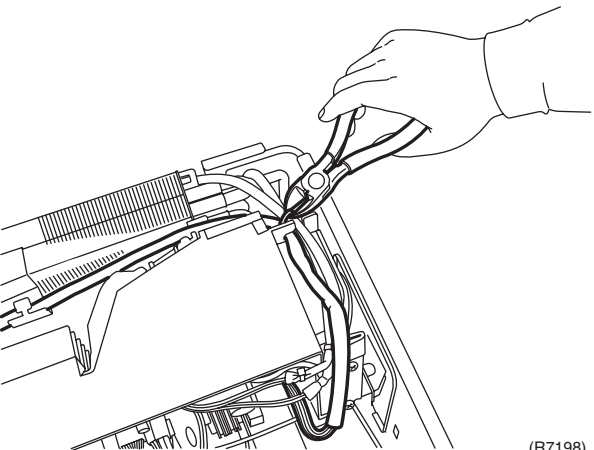
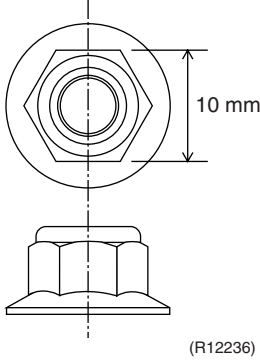
Step	Procedure	Points
<p>3. Remove the fan motor.</p>	<p>1 Remove the washer-fitted nut of the outdoor fan.</p>  <p>2 Remove the outdoor fan.</p>  <p>3 Cut the clamp.</p> 	<ul style="list-style-type: none"> ■ The screw has reverse winding. ■ Nut size: M6  <p>(R12236)</p> <ul style="list-style-type: none"> ■ When reassembling, align ▼ mark of the outdoor fan with D-cut section of the motor shaft.

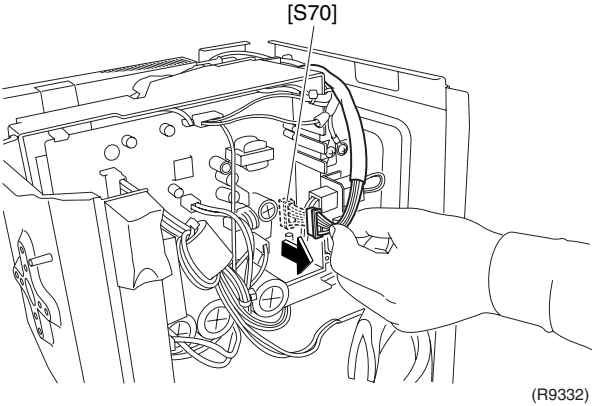
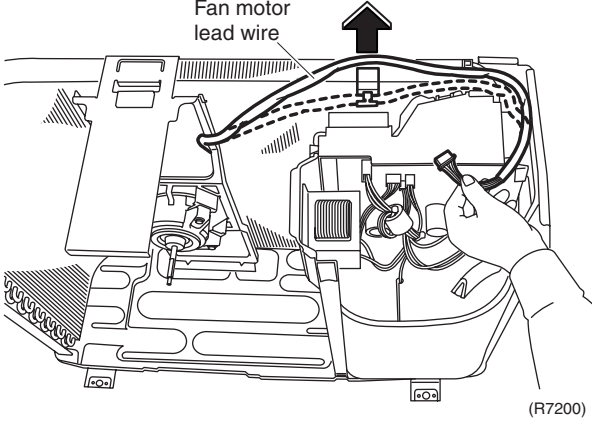
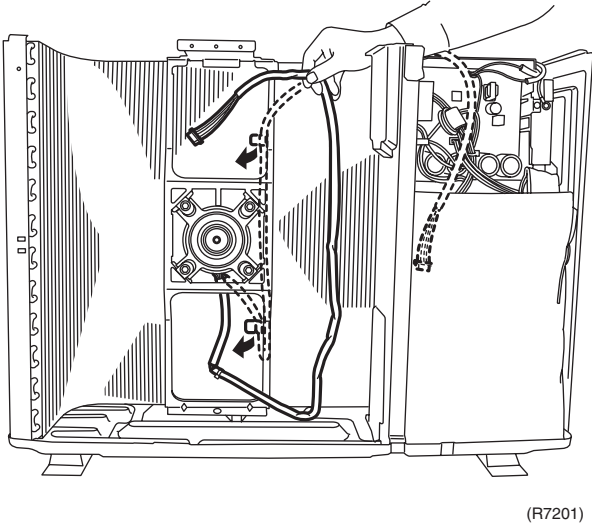
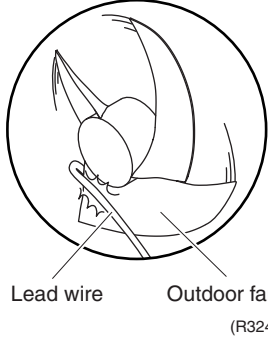
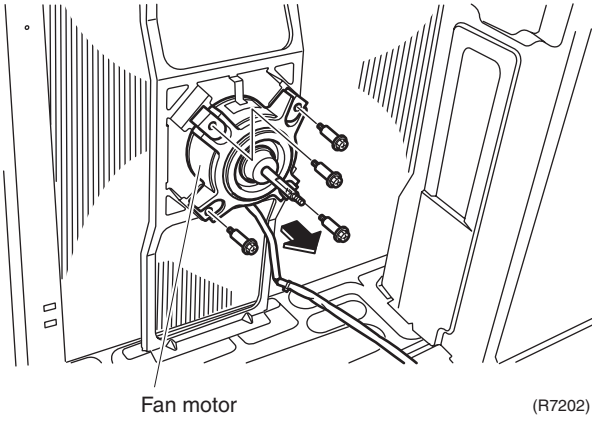
Step	Procedure	Points
4	Disconnect the connector for the fan motor [S70].	
	 <p>(R9332)</p>	
5	Release the fan motor lead wire from the hook.	
	 <p>(R7200)</p>	
6	Open the hooks and release the fan motor lead wire.	
	 <p>(R7201)</p>	<ul style="list-style-type: none"> When reassembling, put the fan motor lead wire through the back of the fan motor (so as not to be entangled with the outdoor fan).
		 <p>Lead wire Outdoor fan (R3249)</p>
7	Remove the 4 screws and remove the fan motor.	
	 <p>Fan motor (R7202)</p>	<ul style="list-style-type: none"> Be sure to remove the lower screws first. If the upper screws are removed first, the fan motor, the center of gravity of which is toward the front, may tilt down or fall, getting you injured.

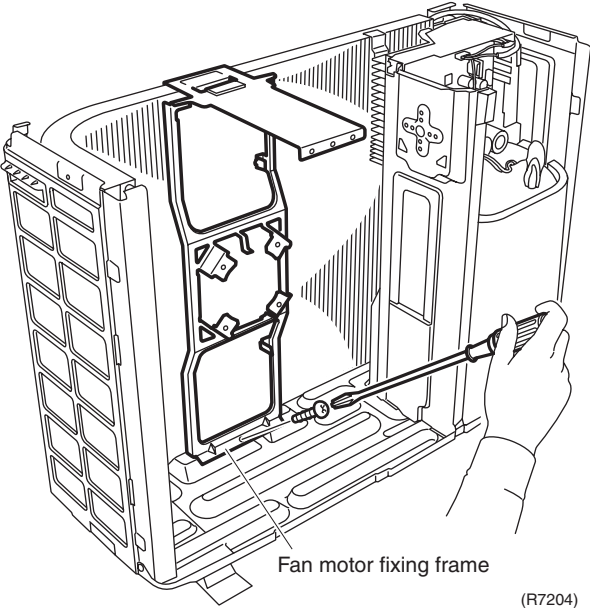
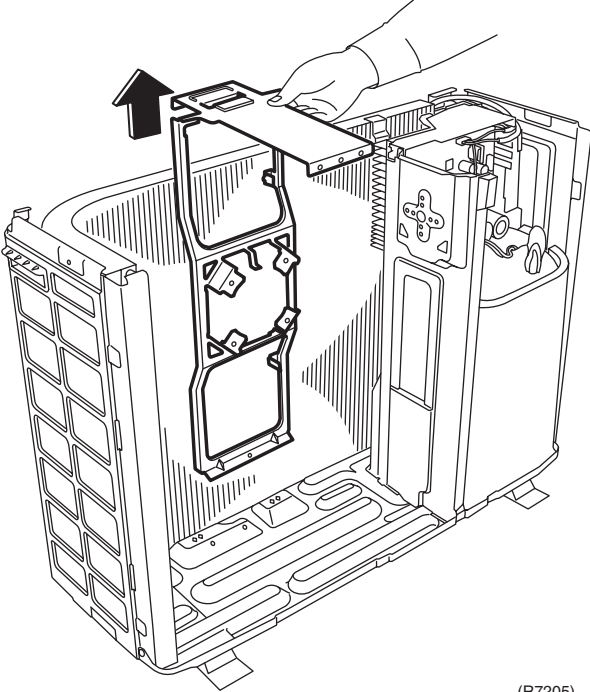
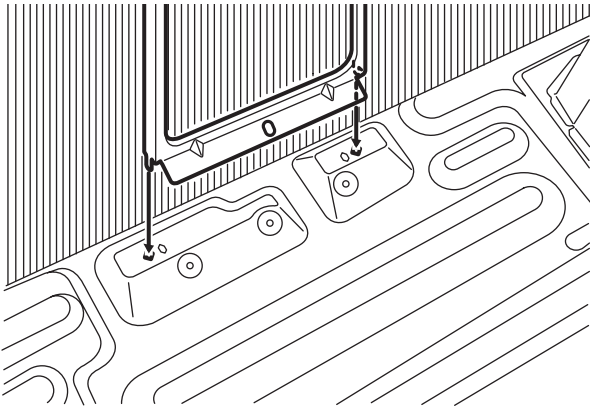
Step	Procedure	Points
8	<p data-bbox="197 219 464 309">Remove the screw and remove the fan motor fixing frame.</p>  <p data-bbox="762 775 975 801">Fan motor fixing frame</p> <p data-bbox="1007 813 1066 835">(R7204)</p>  <p data-bbox="1007 1536 1066 1559">(R7205)</p>  <p data-bbox="1015 2007 1074 2029">(R7206)</p>	<ul style="list-style-type: none"> <li data-bbox="1094 1576 1445 1666">■ When reassembling, fit the lower hooks into the bottom frame.

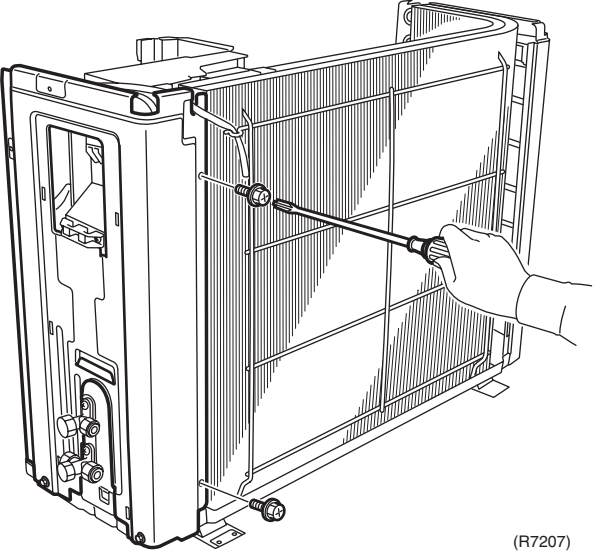
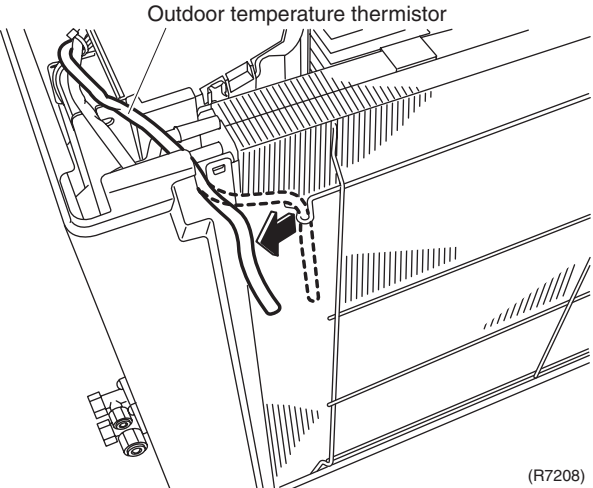
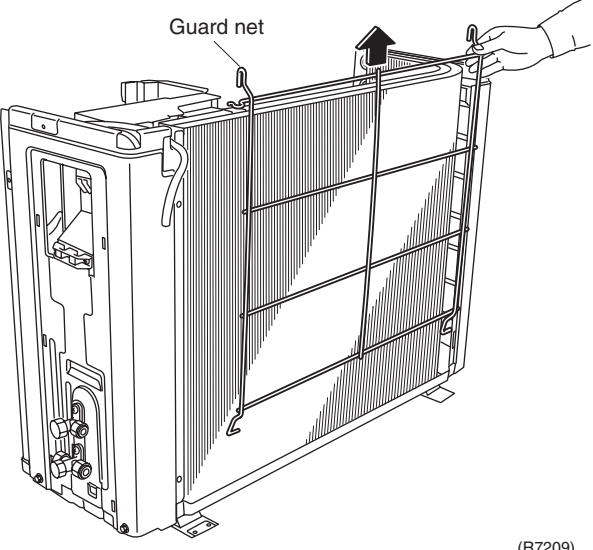
Step	Procedure	Points
4. Remove the right side panel.		
1 Remove the 2 screws on the rear side.	 <p>(R7207)</p>	
2 Release the outdoor temperature thermistor.	 <p>Outdoor temperature thermistor</p> <p>(R7208)</p>	
3 Lift up the guard net and remove it.	 <p>Guard net</p> <p>(R7209)</p>	

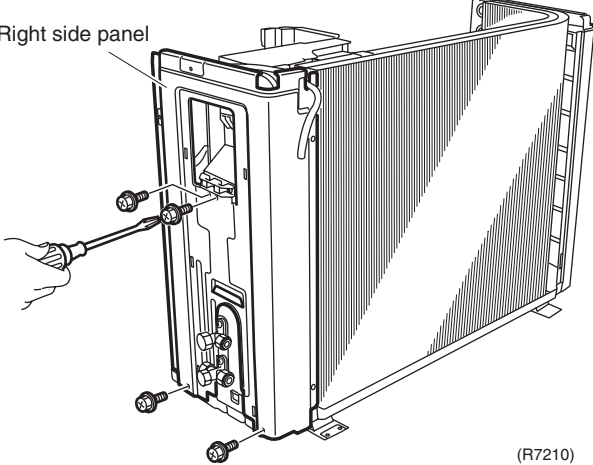
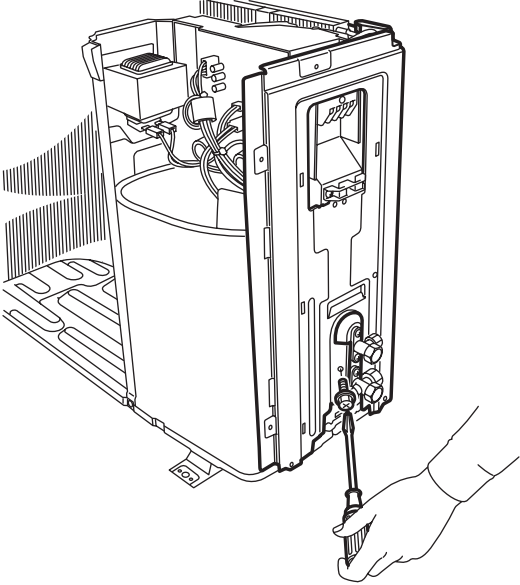
Step	Procedure	Points
4	<p data-bbox="199 219 459 277">Remove the 4 screws on the right side panel.</p>  <p data-bbox="1002 678 1062 698">(R7210)</p>	
5	<p data-bbox="199 721 467 779">Remove the screw near the stop valves.</p>  <p data-bbox="975 1323 1035 1344">(R7211)</p>	

Step	Procedure	Points
6	Unfasten the hook on the rear side.	<ul style="list-style-type: none"> ■ When reassembling, make sure to fit the hook.
7	Lift up the right side panel and remove it.	<ul style="list-style-type: none"> ■ When reassembling, make sure to fit the hook.

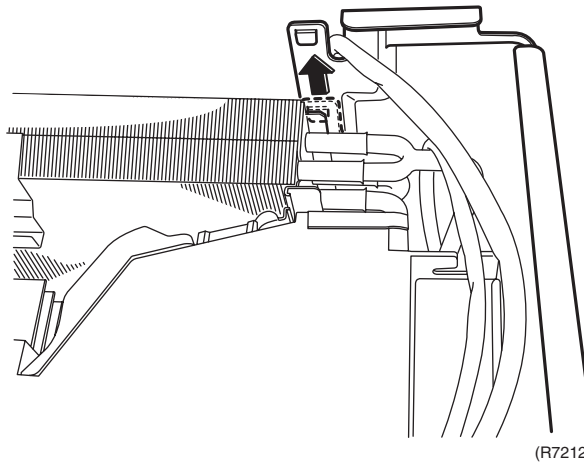

(R7212)

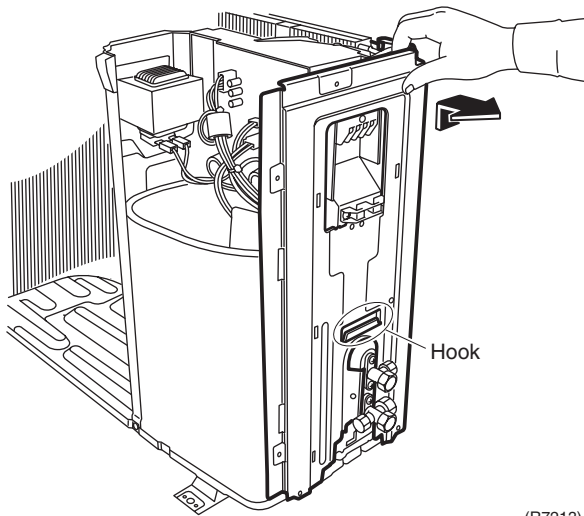

(R7213)

3.2 Removal of Electrical Box

Procedure

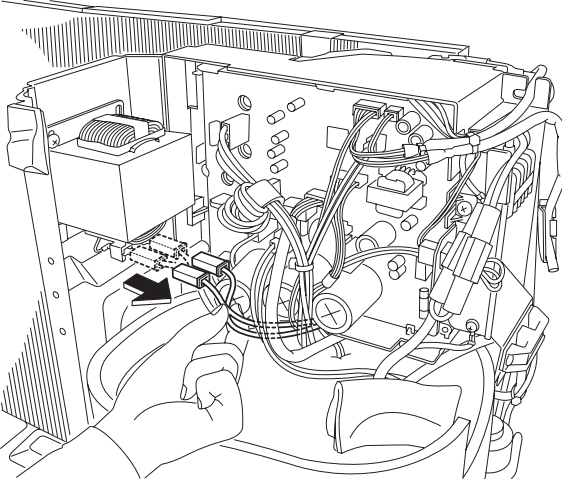
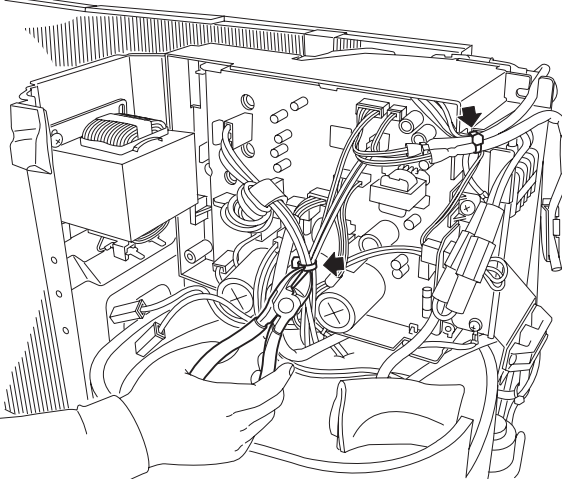
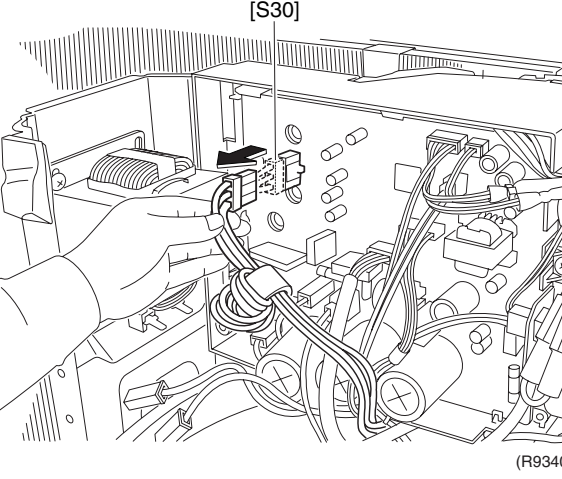

Warning Be sure to wait for 10 minutes or more after turning off all power supplies before disassembling work.

Step	Procedure	Procedure	Points
1	Disconnect the 2 connectors for the reactor.	 <p style="text-align: right;">(R9338)</p>	<p>Preparation</p> <ul style="list-style-type: none"> ■ Remove the panels and disconnect the connector for the fan motor according to the “Removal of Outer Panels / Fan Motor”.
2	Cut the clamps at 2 locations.	 <p style="text-align: right;">(R9339)</p>	
3	Disconnect the connector for the compressor [S30].	 <p style="text-align: right;">(R9340)</p>	<ul style="list-style-type: none"> ■ When reassembling, coil the excessive lead wire and hang the loop on the hook.

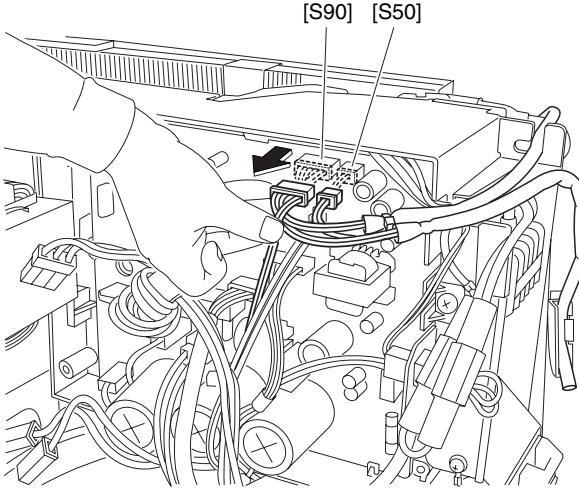
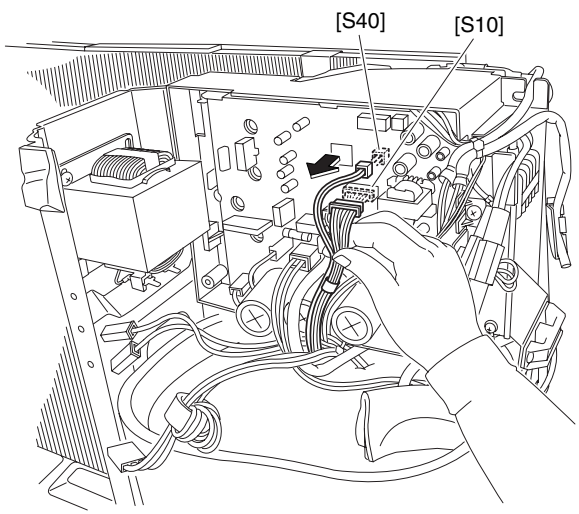
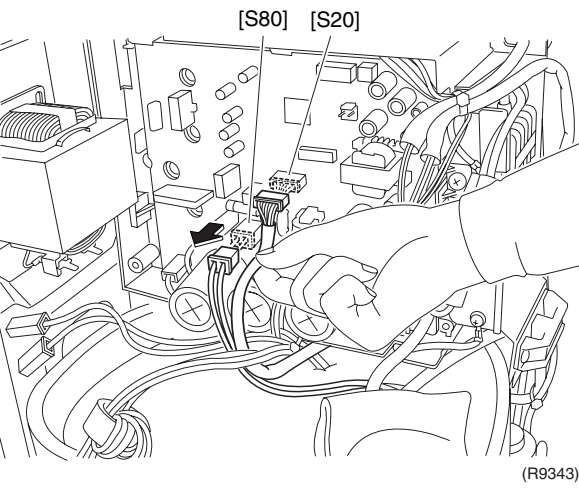
Step	Procedure	Points
4	<p>Disconnect the connectors for the magnetic relay [S50] and for the thermistors [S90].</p>  <p style="text-align: right;">(R9341)</p>	
5	<p>Disconnect the connectors for the filter PCB [S10] and for the overload protector [S40].</p>  <p style="text-align: right;">(R9342)</p>	
6	<p>Disconnect the connectors for the electronic expansion valve coil [S20] and for the four way valve coil [S80].</p>  <p style="text-align: right;">(R9343)</p>	

Step	Procedure	Points
7	Disconnect the connectors for the filter PCB [HL3] [HN3].	
8	Remove the wire harness for standby electricity saving.	
9	Cut the clamps at 2 locations.	

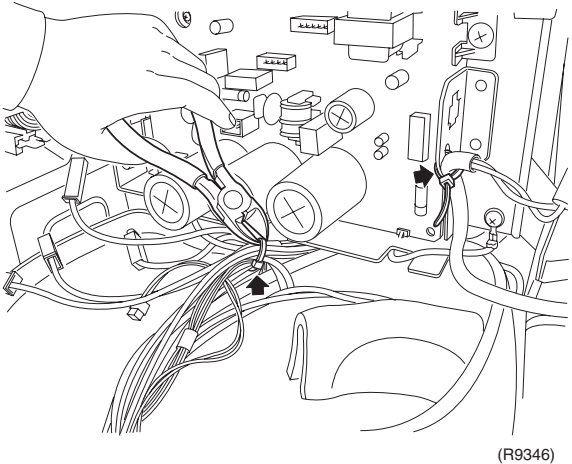
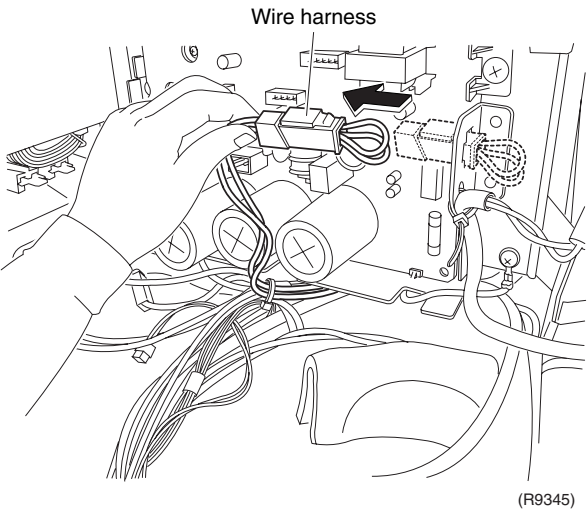
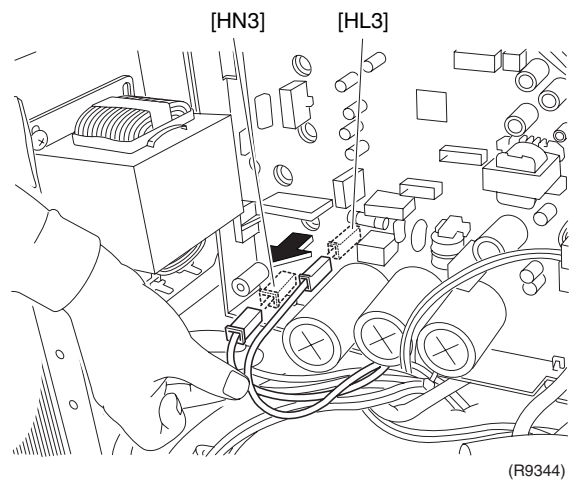

Step	Procedure	Points
10	Lift and remove the electrical box.	

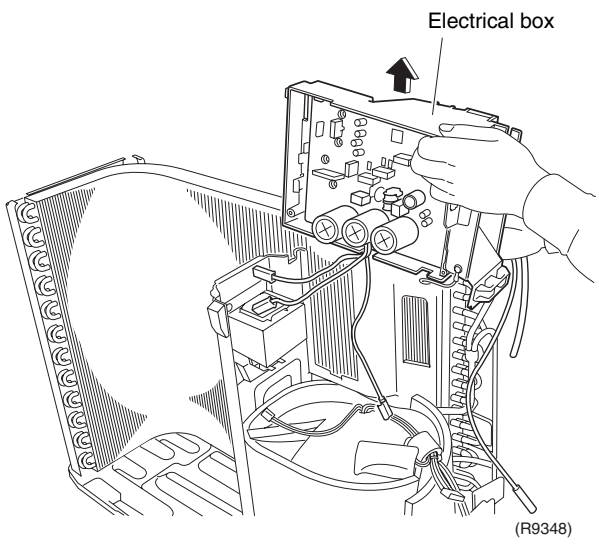

3.3 Removal of Thermistors

Procedure

Warning Be sure to wait 10 minutes or more after turning off all power supplies before disassembling work.

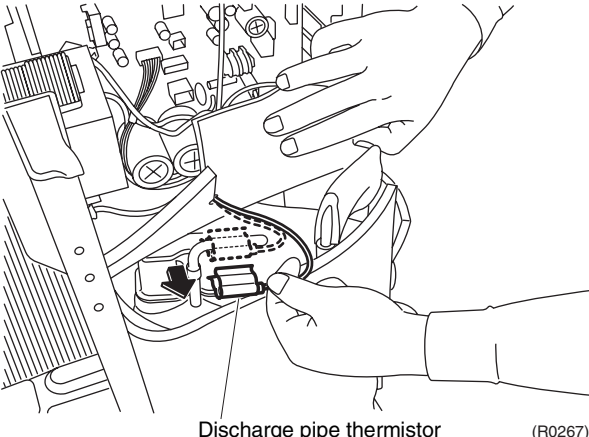
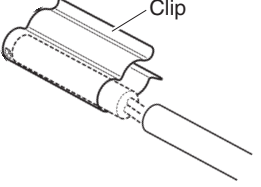
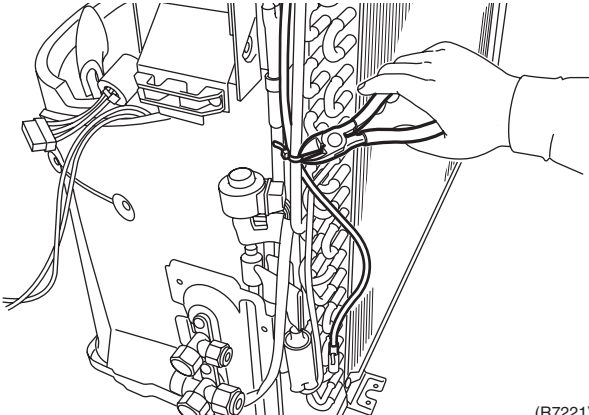
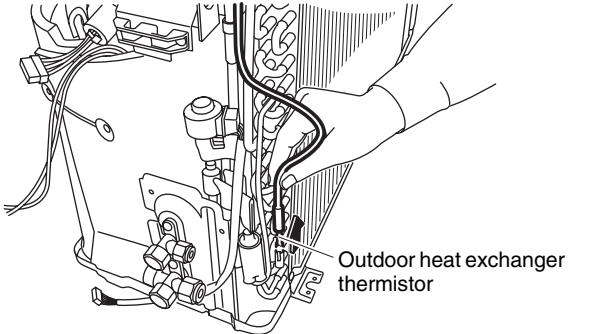
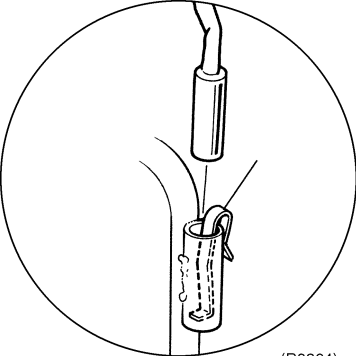
Step	Procedure	Procedure	Points
1	Release the discharge pipe thermistor.	 <p style="text-align: center;">Discharge pipe thermistor (R0267)</p>	<p>■ Be careful not to lose the clip for the thermistor.</p>  <p style="text-align: right;">(R12279)</p>
2	Cut the clamp.	 <p style="text-align: right;">(R7221)</p>	
3	Pull out the outdoor heat exchanger thermistor.	 <p style="text-align: center;">Outdoor heat exchanger thermistor (R7222)</p>	<p>■ Be careful not to lose the clip for the thermistor.</p>  <p style="text-align: right;">(R3264)</p>

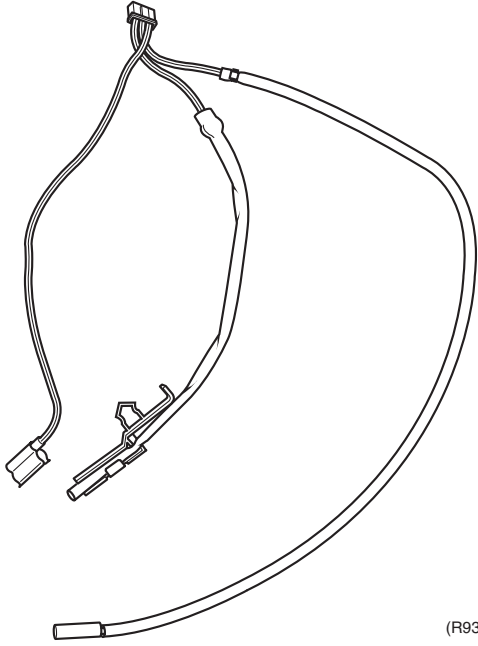
Step	Procedure	Points
4	<p data-bbox="199 215 363 275">Feature of the thermistors</p>  <p data-bbox="970 846 1034 869">(R9356)</p>	

3.4 Removal of PCB

Procedure

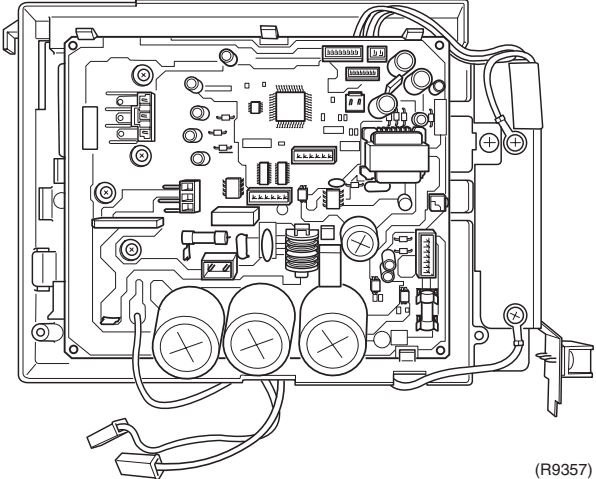
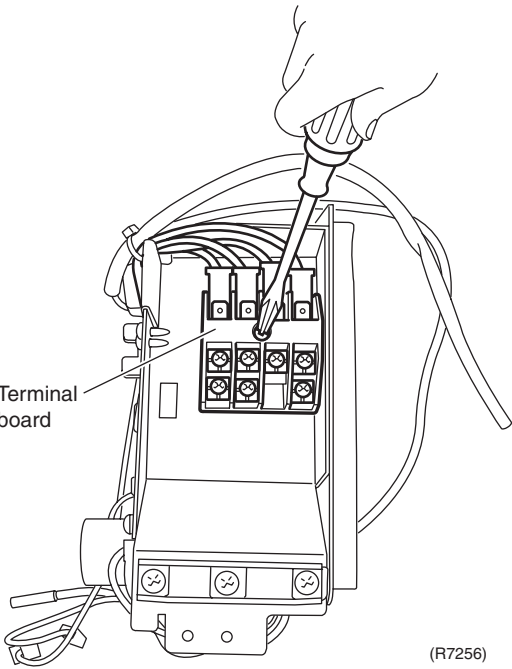
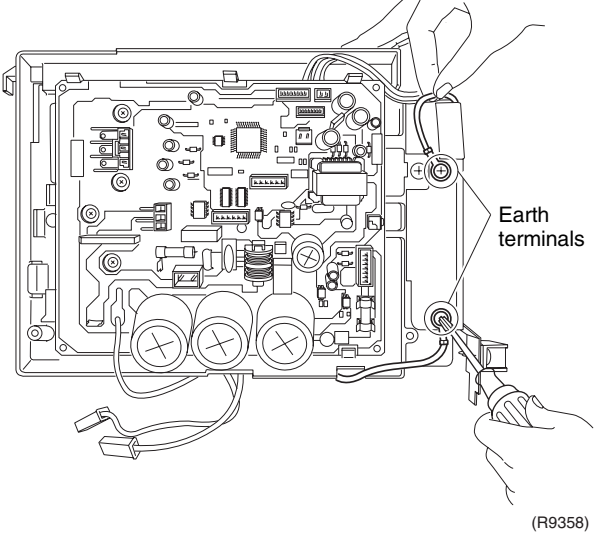

Warning Be sure to wait 10 minutes or more after turning off all power supplies before disassembling work.

Step	Procedure	Points
1. Remove the main PCB.	<p data-bbox="193 398 422 461">1 Feature of the main PCB</p>  <p data-bbox="1018 835 1082 853">(R9357)</p>	<ul style="list-style-type: none"> <li data-bbox="1086 360 1463 526">■ You can remove the main PCB when you disconnect the lead wires on the terminal board without removing the electrical box.
2. Remove the screw on the terminal board.	<p data-bbox="193 860 448 922">2 Remove the screw on the terminal board.</p>  <p data-bbox="520 1249 608 1301">Terminal board</p> <p data-bbox="959 1518 1018 1536">(R7256)</p>	
3. Release the 2 earth terminals.	<p data-bbox="193 1547 422 1610">3 Release the 2 earth terminals.</p>  <p data-bbox="983 1787 1070 1839">Earth terminals</p> <p data-bbox="1018 2096 1082 2114">(R9358)</p>	

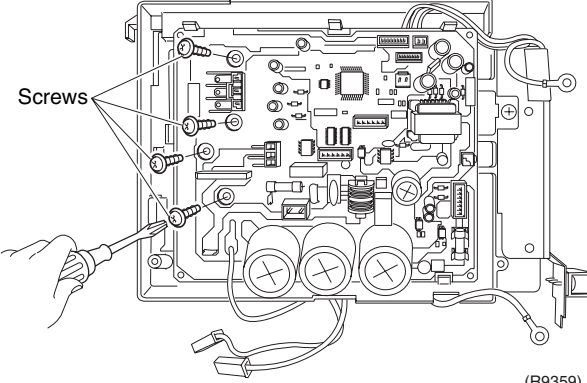
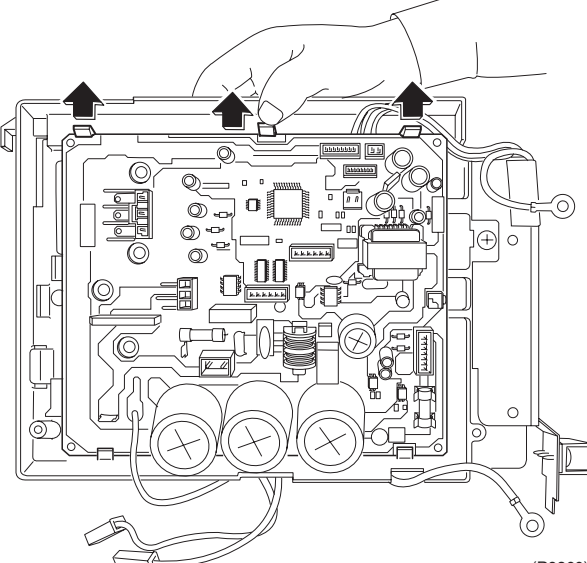
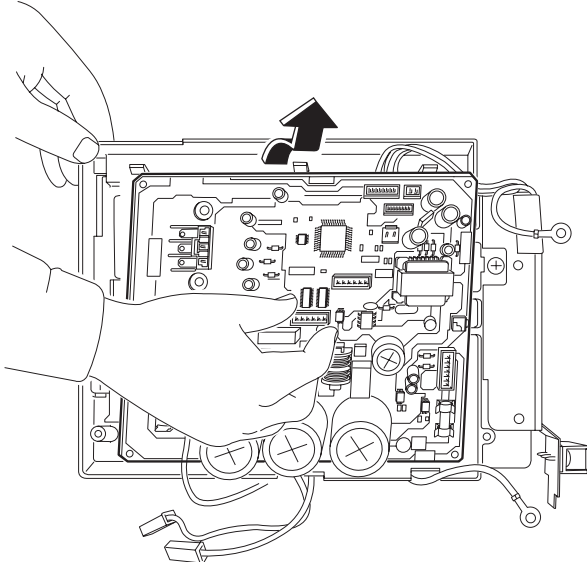
Step	Procedure	Points
4	<p>Remove the 4 screws.</p>  <p>(R9359)</p>	
5	<p>Unfasten the 3 hooks on the upper side.</p>  <p>(R9360)</p>	
6	<p>Lift and pull out the main PCB.</p>  <p>(R9361)</p>	

Step	Procedure	Points
7	<p data-bbox="196 212 422 275">Feature of the main PCB</p> <p data-bbox="986 801 1058 824">(R12189)</p>	<p data-bbox="1090 212 1433 241">■ Refer to page 18 for detail.</p> <p data-bbox="1090 275 1417 304">[S10] [HL3] [HN3]: filter PCB</p> <p data-bbox="1090 315 1401 371">[S20]: electronic expansion valve coil</p> <p data-bbox="1090 383 1302 412">[S30]: compressor</p> <p data-bbox="1090 423 1374 452">[S40]: overload protector</p> <p data-bbox="1090 463 1334 492">[S50]: magnetic relay</p> <p data-bbox="1090 504 1273 533">[S70]: fan motor</p> <p data-bbox="1090 544 1374 573">[S80]: four way valve coil</p> <p data-bbox="1090 584 1294 613">[S90]: thermistors</p>

3.5 Removal of Reactor / Partition Plate

Procedure

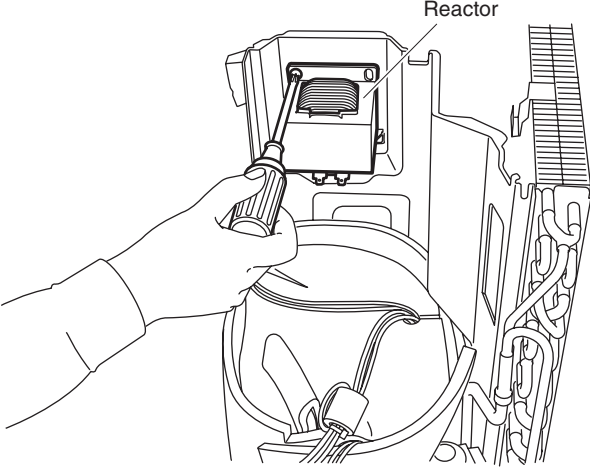
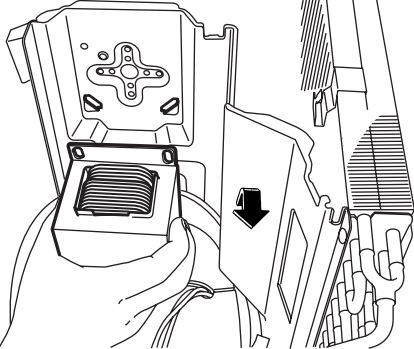
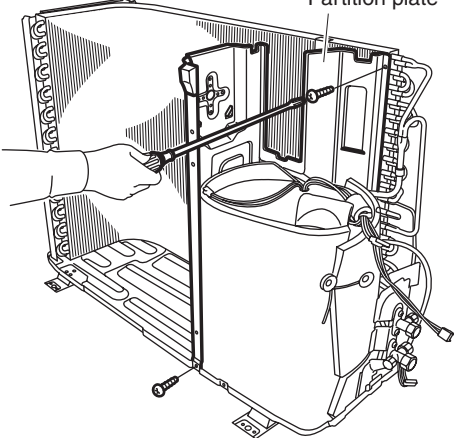

Warning Be sure to wait 10 minutes or more after turning off all power supplies before disassembling work.

Step	Procedure	Points
<p>1. Remove the reactor.</p> <p>1 Remove the screw and remove the reactor.</p>	 <p>(R7224)</p>  <p>(R7225)</p>	<p>Preparation</p> <ul style="list-style-type: none"> ■ Remove the outer panels according to the "Removal of Outer Panels / Fan Motor". ■ Remove the electrical box according to the "Removal of Electrical Box".
<p>2. Remove the partition plate.</p> <p>1 Remove the 2 screws.</p>	 <p>(R7226)</p>	

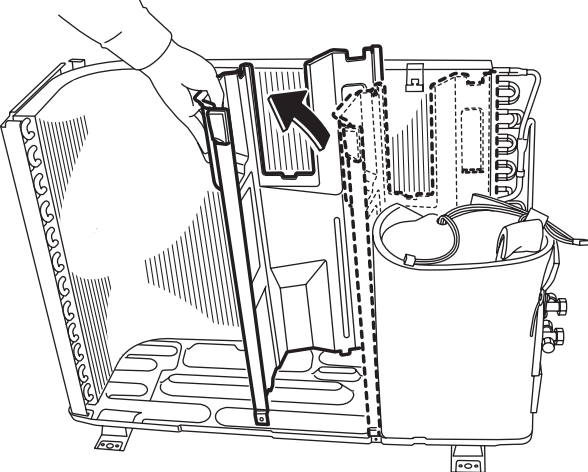
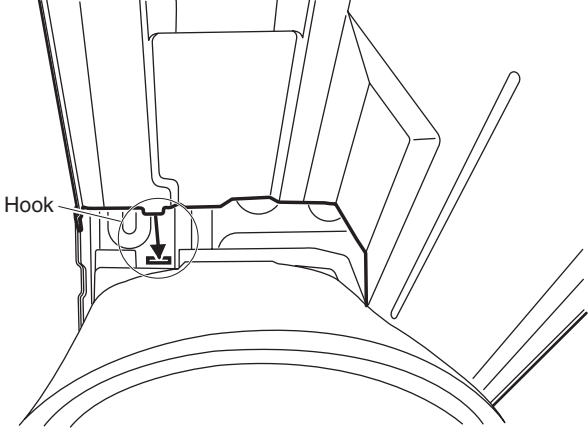
Step	Procedure	Points
2	<p data-bbox="199 219 454 376">The partition plate has a hook on the lower side. Lift and pull the partition plate to remove.</p>  <p data-bbox="1013 712 1077 739">(R7227)</p>  <p data-bbox="486 963 550 990">Hook</p> <p data-bbox="997 1220 1061 1247">(R7228)</p>	<ul data-bbox="1093 757 1444 851" style="list-style-type: none">■ When reassembling, fit the lower hook into the bottom frame.

3.6 Removal of Sound Blanket

Procedure



Warning Be sure to wait for 10 minutes or more after turning off all power supplies before disassembling work.

Step	Procedure	Procedure	Points
1	Remove the sound blanket (top).	<p style="text-align: right;">(R7231)</p>	<p>Preparation</p> <ul style="list-style-type: none"> ■ Remove the outer panels according to the "Removal of Outer Panels / Fan Motor". ■ Remove the electrical box according to the "Removal of Electrical Box". <ul style="list-style-type: none"> ■ Since the piping ports are torn easily, remove the sound blanket carefully.
2	Untie the string and open the sound blanket (outer).	<p style="text-align: right;">(R7229)</p>	
3	Lift and remove the sound blanket (outer).	<p style="text-align: right;">(R12212)</p>	
4	Pull the sound blanket (inner) out.	<p style="text-align: right;">(R11887)</p>	

3.7 Removal of Four Way Valve

Procedure

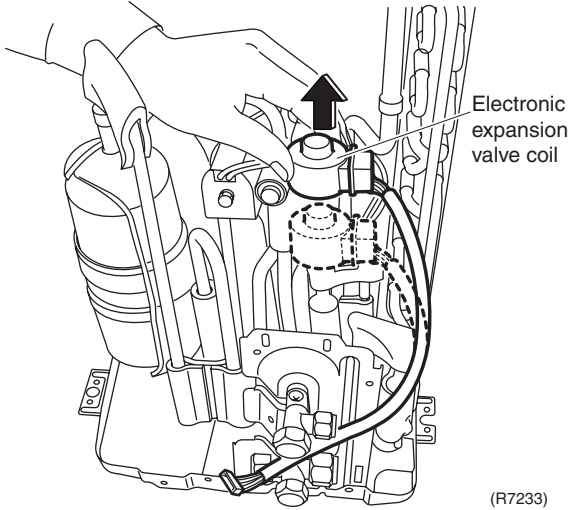
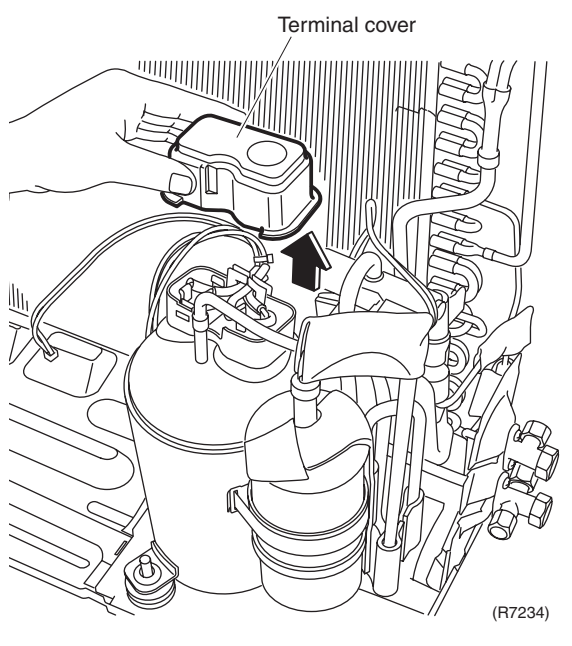
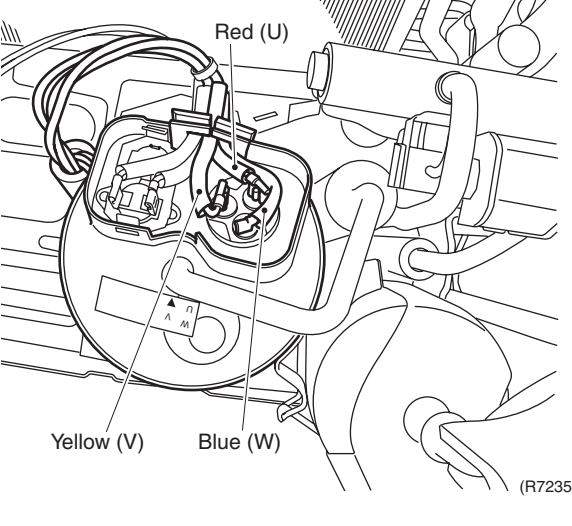

Warning Be sure to wait for 10 minutes or more after turning off all power supplies before disassembling work.

Step	Procedure	Procedure	Points
1	Pull out the electronic expansion valve coil.	 <p>(R7233)</p>	
2	Remove the terminal cover.	 <p>(R7234)</p>	
3	Disconnect the lead wires of the compressor.	 <p>(R7235)</p>	

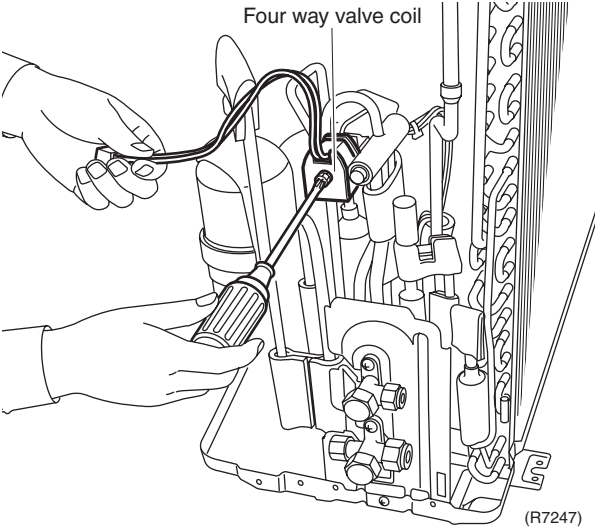
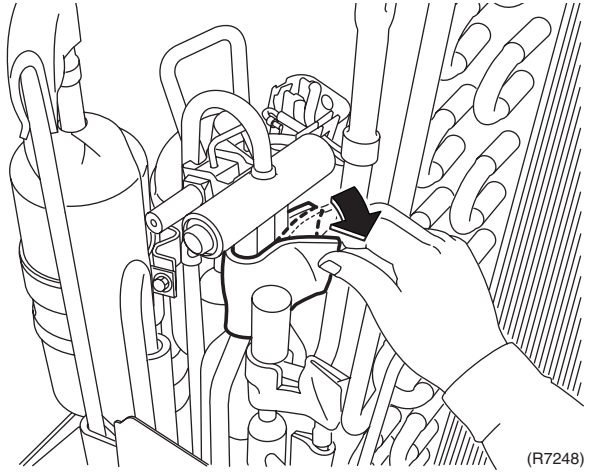
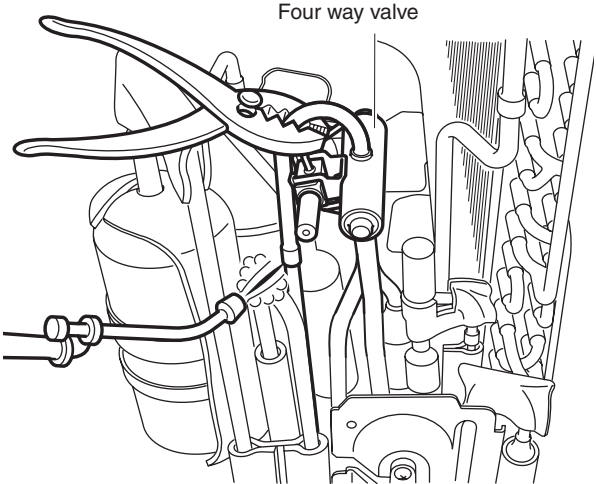
Step	Procedure	Points
4	<p>Remove the screw and remove the four way valve coil.</p>  <p style="text-align: right;">(R7247)</p>	<p>Warning Be careful not to get yourself burnt with the pipes and other parts that are heated by the gas brazing machine.</p> <p>Warning If the refrigerant gas leaks during work, ventilate the room. (If the refrigerant gas is exposed to flames, toxic gas may be generated.)</p> <p>Caution From the viewpoint of global environment protection, do not discharge the refrigerant gas in the atmosphere. Make sure to collect all the refrigerant gas.</p>
5	<p>Remove the sheets of putty.</p>  <p style="text-align: right;">(R7248)</p>	<p>Cautions for restoration</p> <ol style="list-style-type: none"> 1. Restore the piping by non-oxidation brazing. 2. It is required to prevent the carbonization of the oil inside the four way valve and the deterioration of the gaskets affected by heat. (Keep below 120°C.) For the sake of this, wrap the four way valve with wet cloth and provide water so that the cloth does not dry.
6	<p>Heat up the brazed part and withdraw the piping with pliers.</p>  <p style="text-align: right;">(R7249)</p>	<p>In case of difficulty with gas brazing machine</p> <ol style="list-style-type: none"> 1. Disconnect the brazed part where is easy to disconnect and restore. 2. Cut pipes on the main unit with a tube cutter in order to make it easy to disconnect.

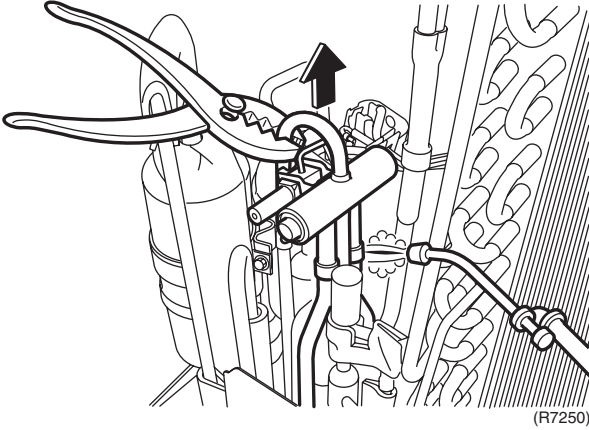
Step	Procedure	Points
	 <p>(R7250)</p>	<p>Note:</p> <ul style="list-style-type: none">■ Do not use a metal saw for cutting pipes by all means because the sawdust comes into the circuit.■ When withdrawing the pipes, be careful not to pinch them firmly with pliers. The pipes may get deformed.■ Provide a protective sheet or a steel plate so that the brazing flame cannot influence peripheries.

3.8 Removal of Compressor

Procedure

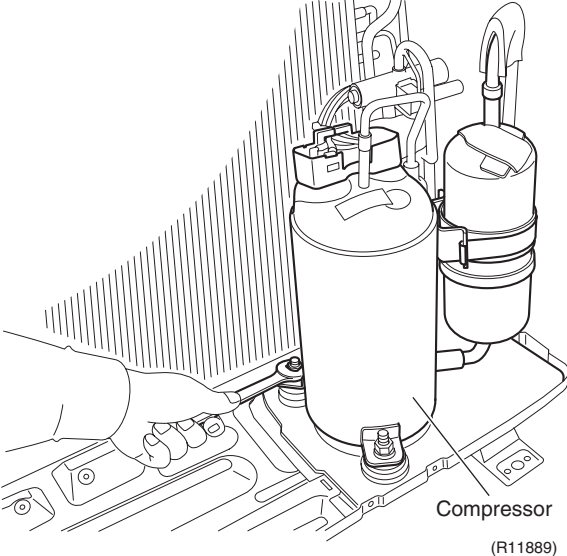
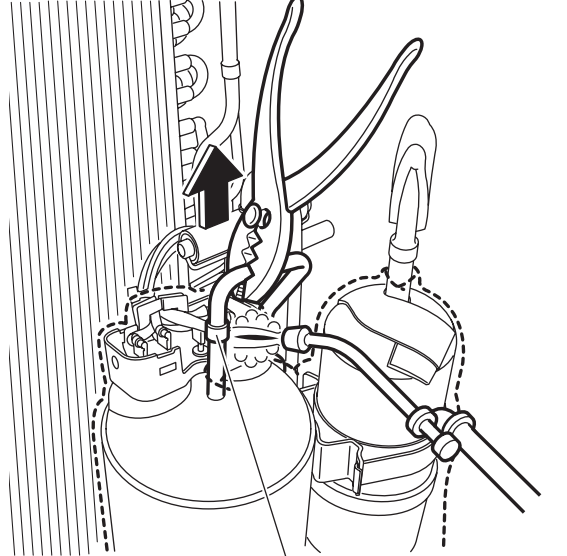

Warning Be sure to wait for 10 minutes or more after turning off all power supplies before disassembling work.

Step	Procedure	Points
1	<p>Remove the 2 nuts of the compressor.</p> 	<p>Warning Be careful not to get yourself burnt with the pipes and other parts that are heated by the gas brazing machine.</p> <p>Warning If the refrigerant gas leaks during work, ventilate the room. (If the refrigerant gas is exposed to flames, toxic gas may be generated.)</p> <p>Warning Since it may happen that the refrigerant oil in the compressor catches fire, prepare wet cloth so as to extinguish fire immediately.</p>
<ul style="list-style-type: none"> ■ Before working, make sure that the refrigerant is empty in the circuit. ■ Be sure to apply nitrogen replacement when heating up the brazed part. 		<p>Caution From the viewpoint of global environment protection, do not discharge the refrigerant gas in the atmosphere. Make sure to collect all the refrigerant gas.</p>
2	<p>Heat up the brazed part of the discharge side and disconnect.</p>	<p>Cautions for restoration</p> <ol style="list-style-type: none"> 1. Restore the piping by non-oxidation brazing. 2. It is required to prevent the carbonization of the oil inside the four way valve and the deterioration of the gaskets affected by heat. (Keep below 120°C.) For the sake of this, wrap the four way valve with wet cloth and provide water so that the cloth does not dry. <p>In case of difficulty with gas brazing machine</p> <ol style="list-style-type: none"> 1. Disconnect the brazed part where is easy to disconnect and restore. 2. Cut pipes on the main unit with a tube cutter in order to make it easy to disconnect.

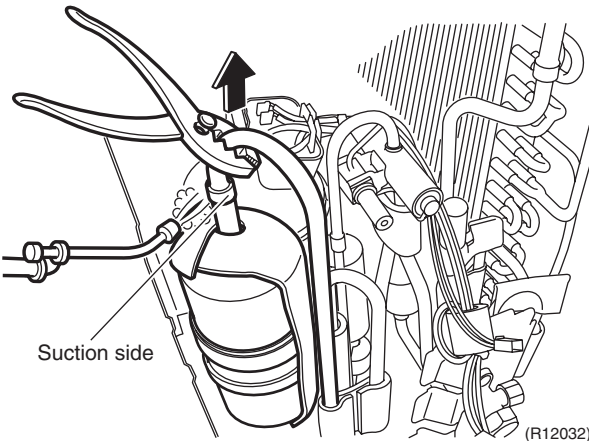
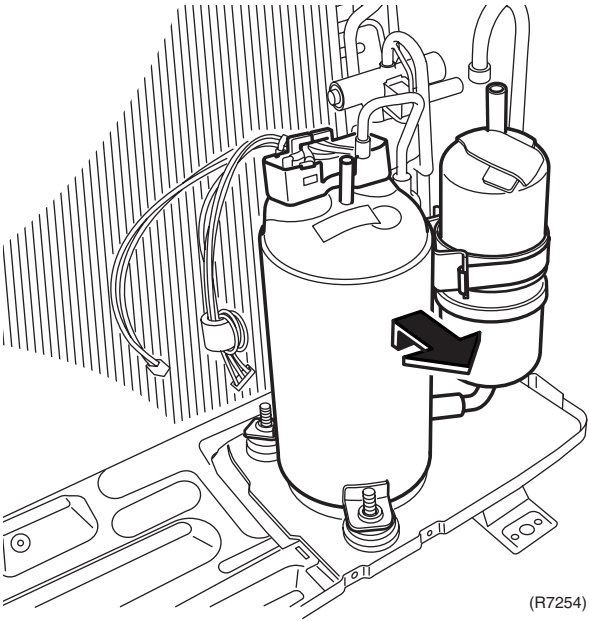
Step	Procedure	Points
3	Heat up the brazed part of the suction side and disconnect. 	Note: <ul style="list-style-type: none"> ■ Do not use a metal saw for cutting pipes by all means because the sawdust comes into the circuit. ■ When withdrawing the pipes, be careful not to pinch them firmly with pliers. The pipes may get deformed. ■ Provide a protective sheet or a steel plate so that the brazing flame cannot influence peripheries.
4	Lift the compressor up and remove it. 	<ul style="list-style-type: none"> ■ Be careful so as not to burn the compressor terminals, the name plate, the heat exchanger fin.

4. Outdoor Unit - RK(X)S25/35G2V1B9

4.1 Removal of Outer Panels / Fan Motor

Procedure



Warning Be sure to wait 10 minutes or more after turning off all power supplies before disassembling work.

Step	Procedure	Points
1. Appearance features	<p>(R7186)</p> <p>(R11890)</p>	<ul style="list-style-type: none"> Take care not to cut your finger by the fins of the outdoor heat exchanger.
2. Remove the panels.	<p>1 Remove the screw of the stop valve cover. Pull down the stop valve cover and remove it.</p> <p>Stop valve cover</p> <p>Shield plate</p> <p>Hooks</p> <p>(R7188)</p> <p>(R7189)</p>	<ul style="list-style-type: none"> The stop valve cover is united with the shield plate. When reassembling, make sure to fit the 5 hooks.

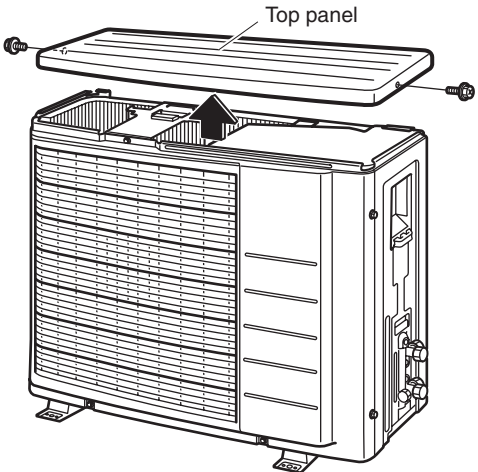
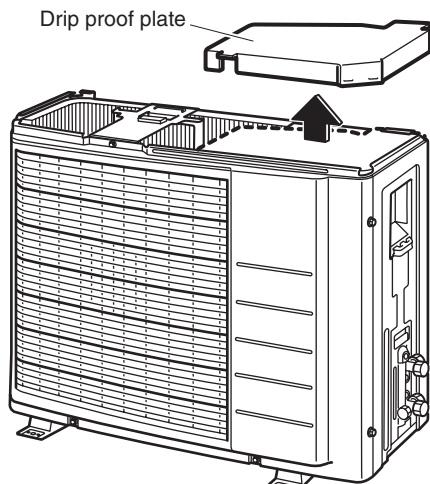
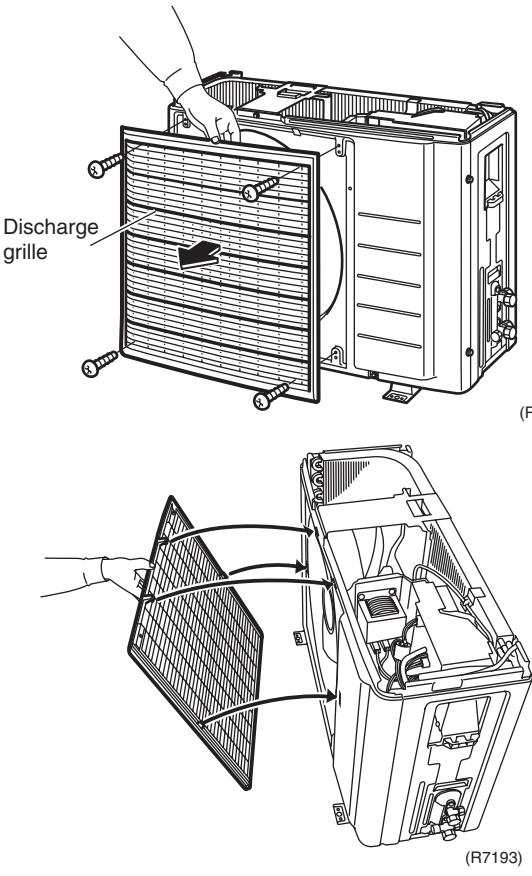

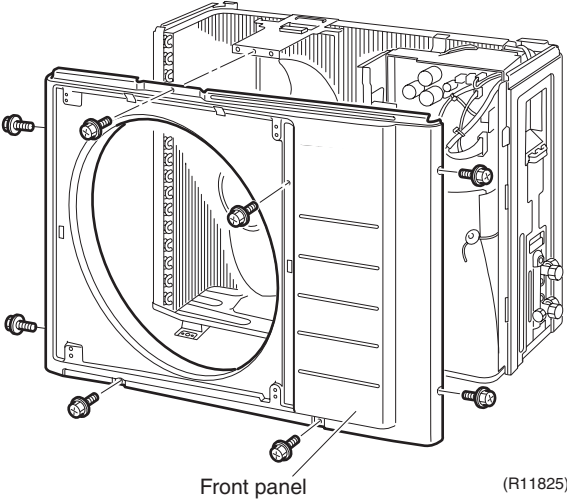
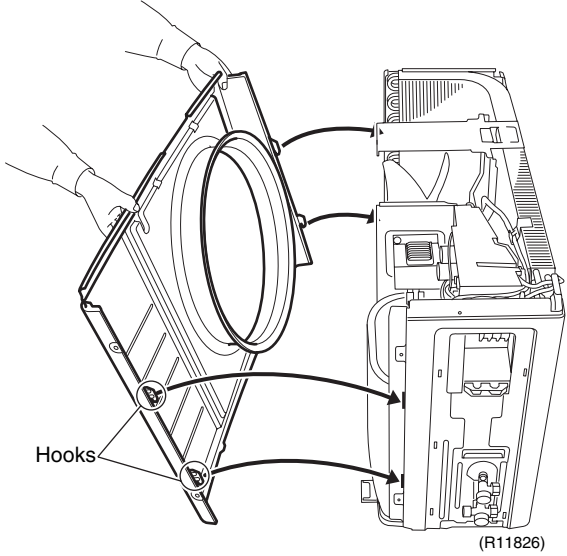
Step		Procedure	Points
2	Remove the 2 screws and lift the top panel.	 <p>Top panel</p> <p>(R7190)</p>	
3	Remove the drip proof plate.	 <p>Drip proof plate</p> <p>(R7191)</p>	
4	Remove the 4 screws and remove the discharge grille.	 <p>Discharge grille</p> <p>(R7192)</p> <p>(R7193)</p>	<p>■ The discharge grille has 4 hooks.</p>

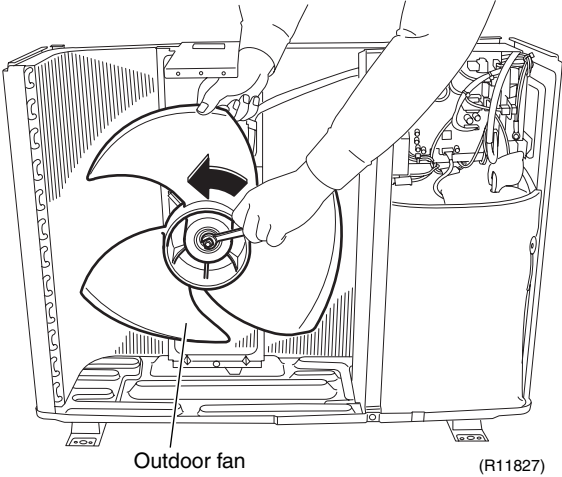
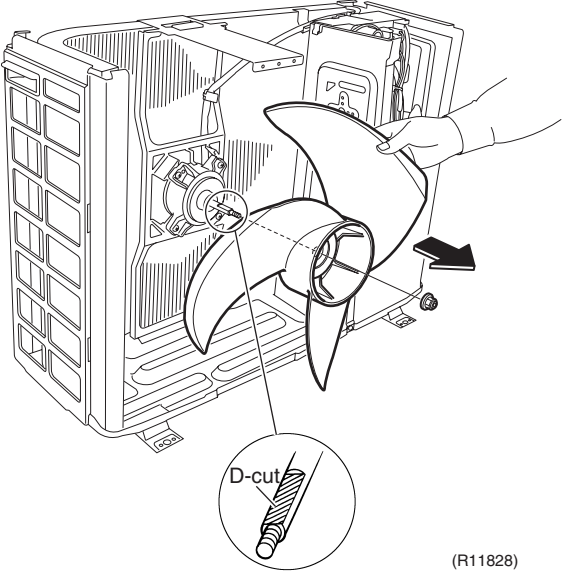
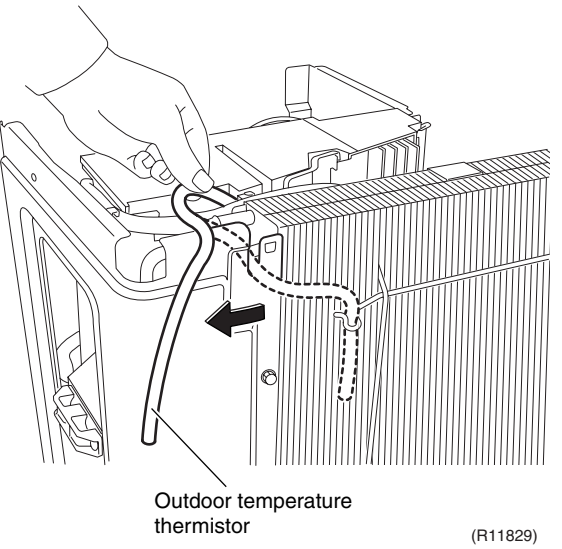
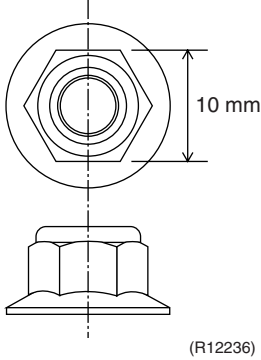
Step	Procedure	Points
5	<p>Remove the 8 screws of the front panel.</p>  <p style="text-align: center;">Front panel (R11825)</p>	
6	<p>Unfasten the hooks. Pull and remove the front panel.</p>  <p style="text-align: center;">Hooks (R11826)</p>	<p>■ The front panel has 4 hooks.</p>

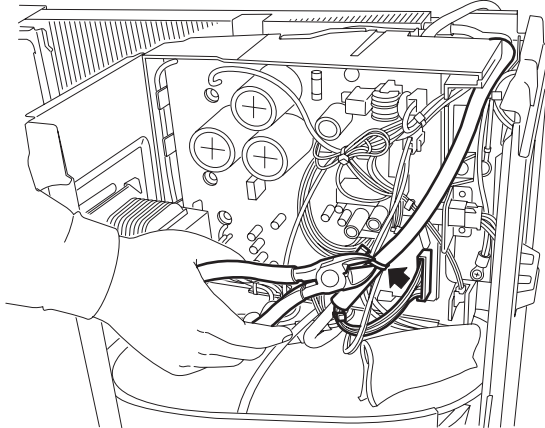
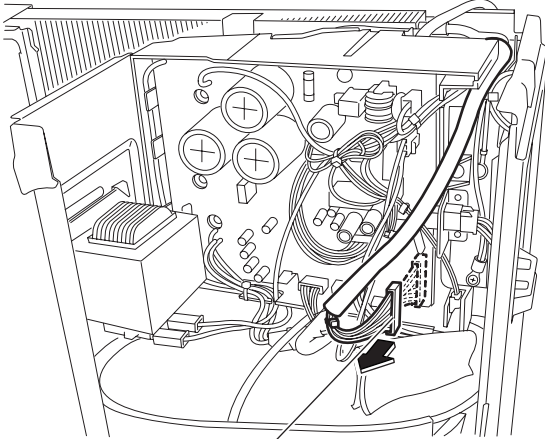
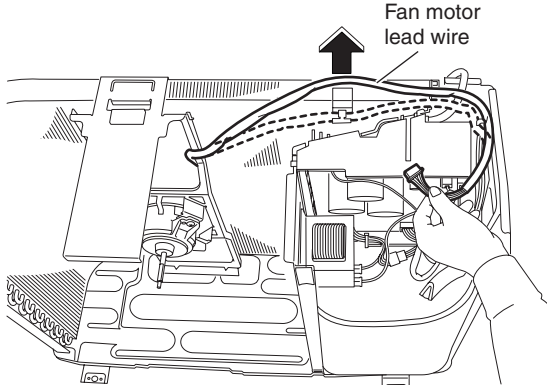
Step	Procedure	Points
<p>3. Remove the fan motor.</p>	<p>1 Remove the washer-fitted nut of the outdoor fan.</p>  <p>Outdoor fan (R11827)</p> <p>2 Remove the outdoor fan.</p>  <p>D-cut (R11828)</p> <p>3 Release the outdoor temperature thermistor.</p>  <p>Outdoor temperature thermistor (R11829)</p>	<ul style="list-style-type: none"> ■ The screw has reverse winding. ■ Nut size: M6  <p>10 mm (R12236)</p> <ul style="list-style-type: none"> ■ When reassembling, align ▼ mark of the outdoor fan with D-cut section of the motor shaft.

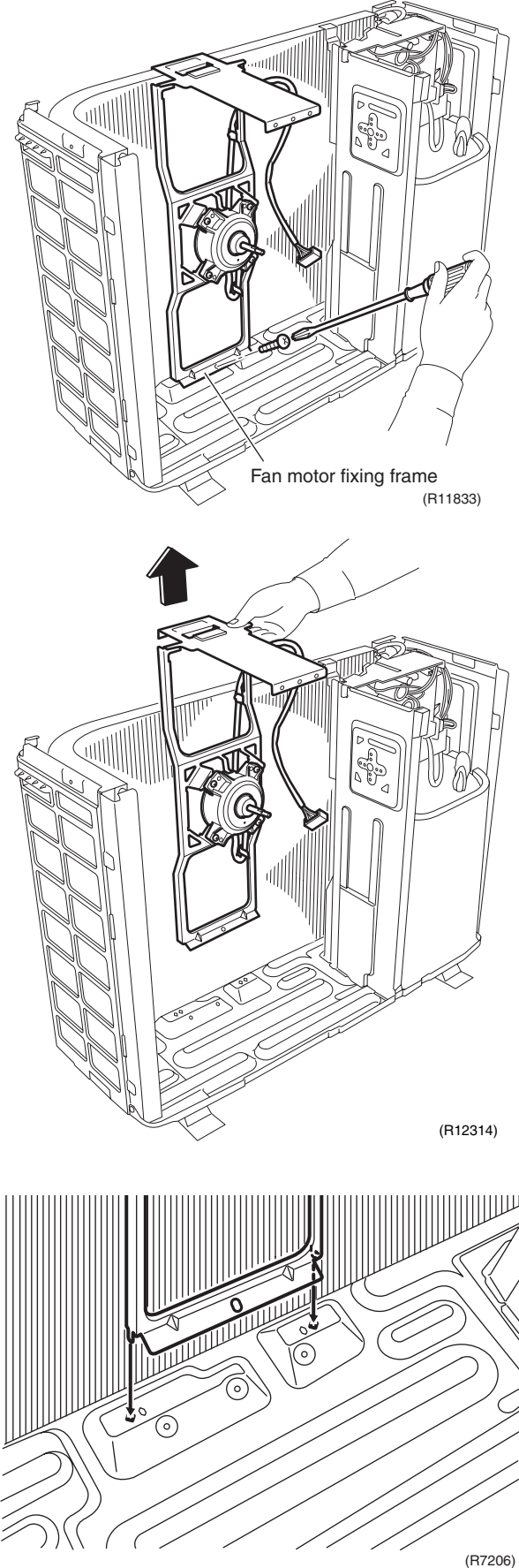
Step	Procedure	Points
4	Cut the clamp.	
	 <p style="text-align: right;">(R11830)</p>	
5	Disconnect the connector for the fan motor [S70].	
	 <p style="text-align: center;">[S70] (R11831)</p>	
6	Release the fan motor lead wire from the hook.	
	 <p style="text-align: right;">(R11832)</p>	

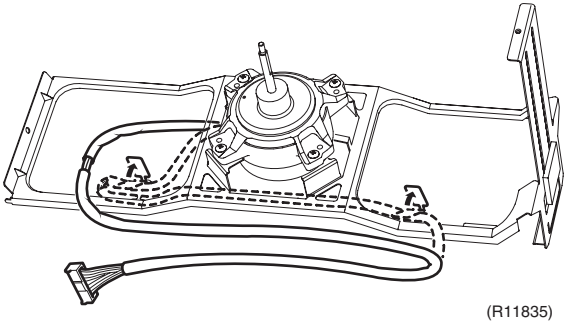
Step	Procedure	Points
7	<p data-bbox="199 219 464 309">Remove the screw and remove the fan motor fixing frame.</p>  <p data-bbox="767 763 1034 808">Fan motor fixing frame (R11833)</p> <p data-bbox="983 1503 1054 1525">(R12314)</p> <p data-bbox="1011 1984 1075 2007">(R7206)</p>	<ul style="list-style-type: none"> <li data-bbox="1093 1541 1449 1637">■ When reassembling, fit the lower hooks into the bottom frame.

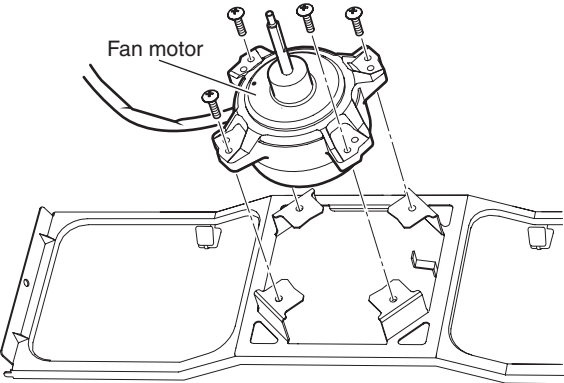
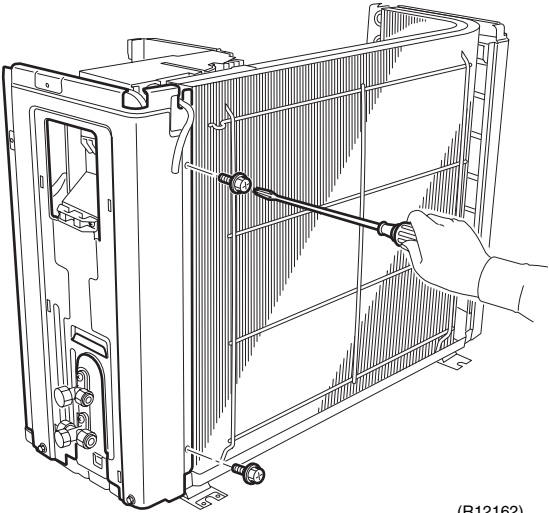
Step	Procedure	Procedure	Points
8	Open the hooks and release the fan motor lead wire.	 <p>(R11835)</p>	<p>■ When reassembling, put the fan motor lead wire through the back of the fan motor (so as not to be entangled with the outdoor fan).</p>  <p>Lead wire Outdoor fan (R3249)</p>
9	Remove the 4 screws and remove the fan motor.	 <p>Fan motor</p> <p>(R12311)</p>	
4.	Remove the right side panel.	 <p>(R12162)</p>	
1	Remove the 2 screws on the rear side.		

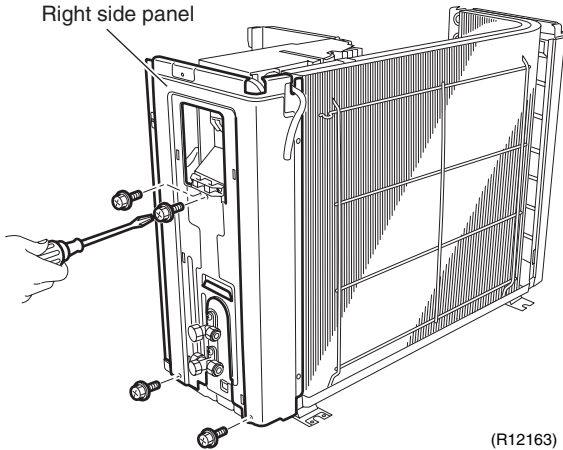
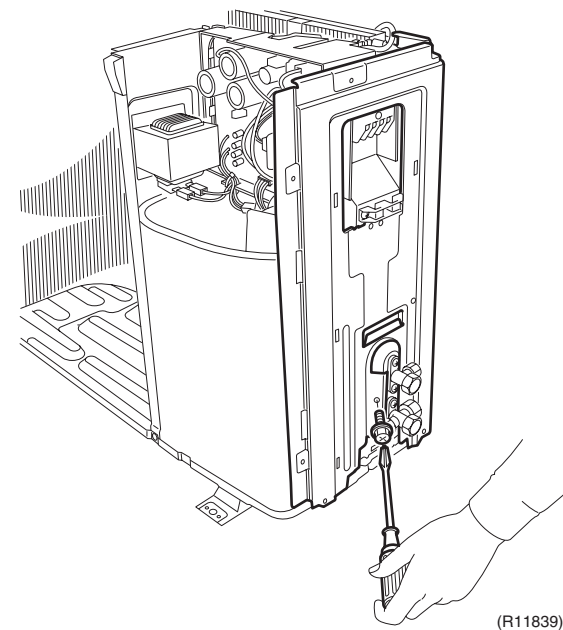
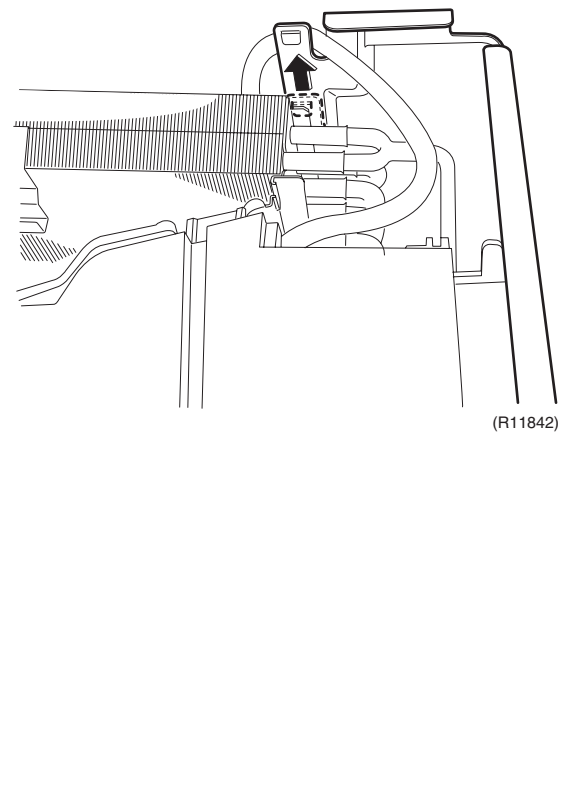
Step	Procedure	Points
2	<p>Remove the 4 screws on the right side panel.</p>  <p>Right side panel</p> <p>(R12163)</p>	
3	<p>Remove the screw near the stop valves.</p>  <p>(R11839)</p>	
4	<p>Unfasten the hook on the rear side.</p>  <p>(R11842)</p>	<p>■ When reassembling, make sure to fit the hook.</p>

Step	Procedure	Points
5	Lift up the right side panel and remove it.	<ul style="list-style-type: none"> ■ When reassembling, make sure to fit the hook.
6	Lift up the guard net and remove it.	

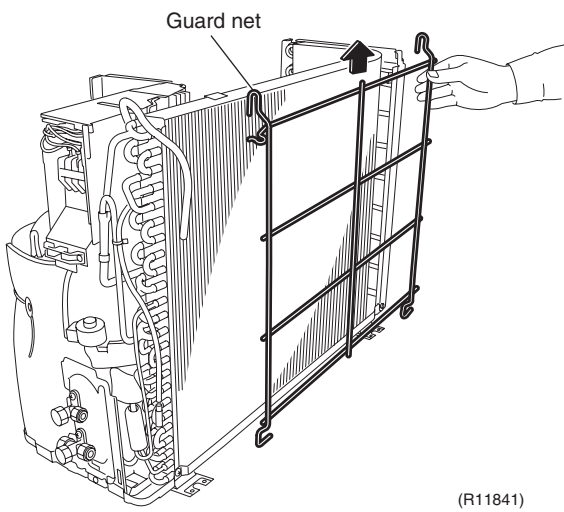
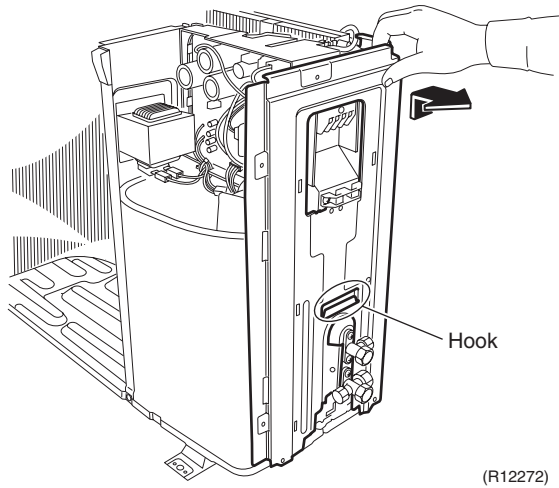

4.2 Removal of Electrical Box

Procedure



Warning Be sure to wait 10 minutes or more after turning off all power supplies before disassembling work.

Step	Procedure	Points
1	Disconnect the connector for the overload protector [S40].	Preparation ■ Remove the panels and disconnect the connector for the fan motor according to the “Removal of Outer Panels / Fan Motor”.
2	Disconnect the connector for the four way valve coil [S80].	
3	Disconnect the 2 connectors for the reactor.	

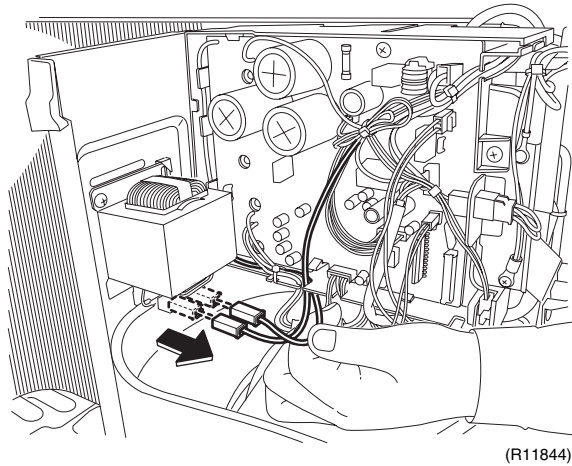
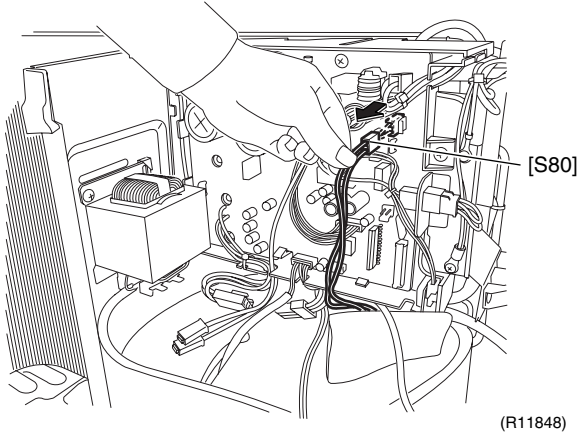
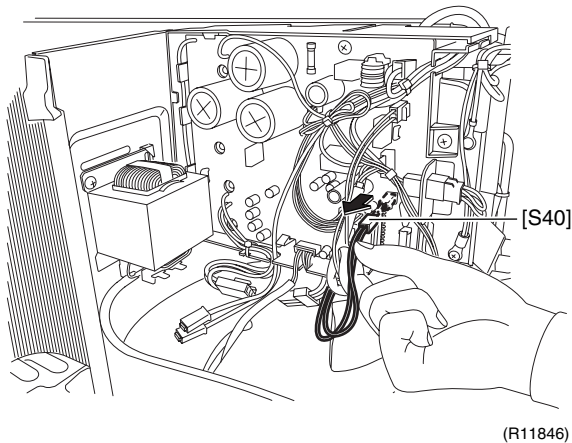

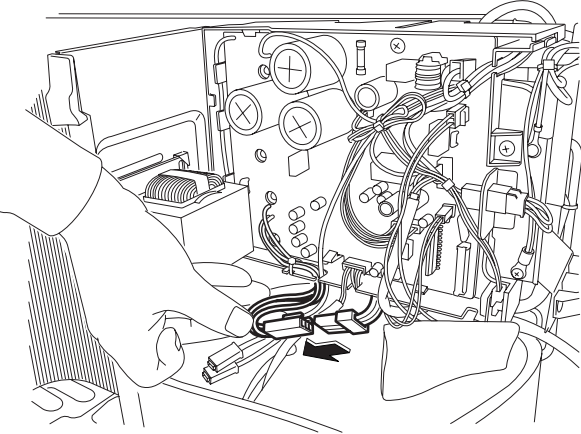
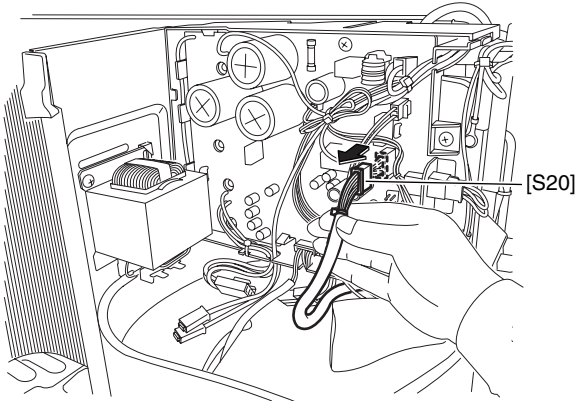
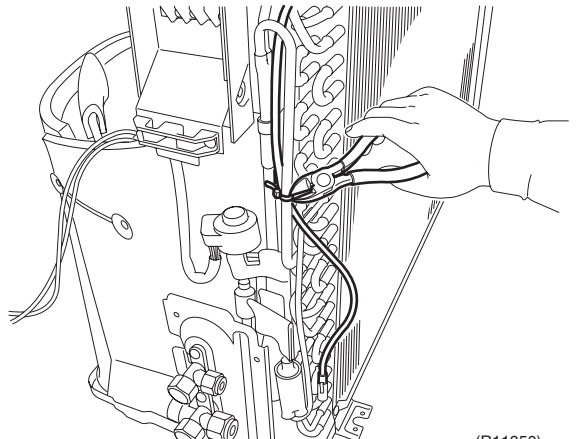
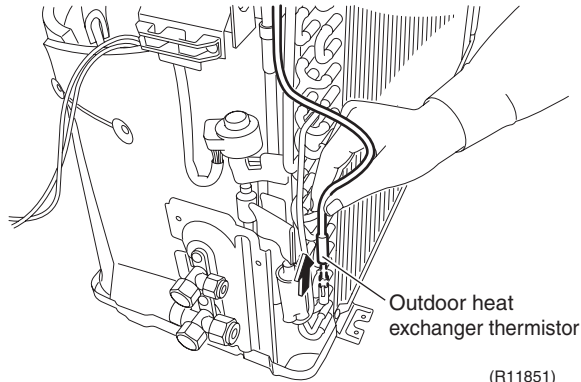
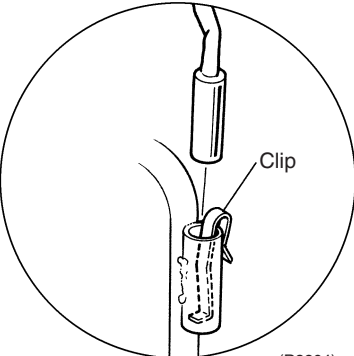
Step	Procedure	Points
4	<p>Disconnect the relay connector for the compressor.</p>  <p>(R11845)</p>	
5	<p>Disconnect the connector for the electronic expansion valve coil [S20].</p>  <p>(R11847)</p>	
6	<p>Cut the clamp.</p>  <p>(R11850)</p>	
7	<p>Pull out the outdoor heat exchanger thermistor.</p>  <p>Outdoor heat exchanger thermistor</p> <p>(R11851)</p>	<p>■ Be careful not to lose the clip for the thermistor.</p>  <p>(R3264)</p>

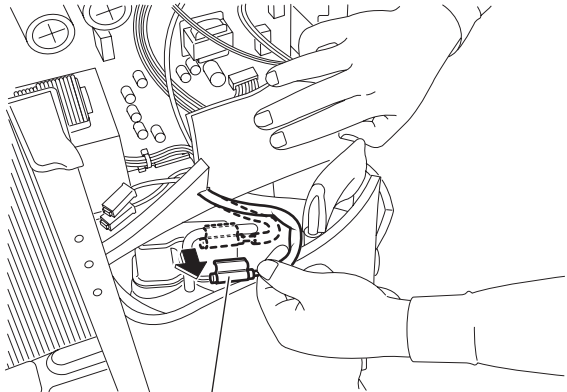
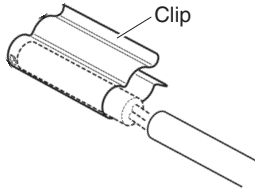
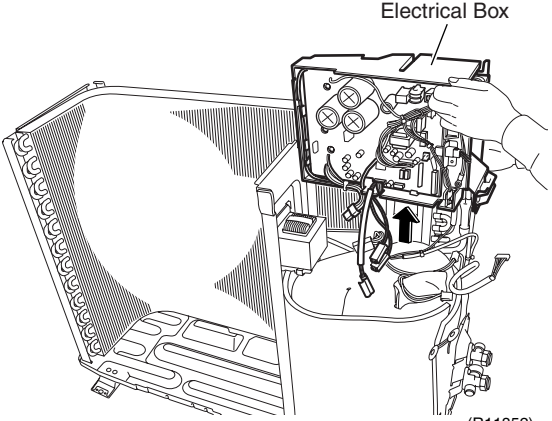
Step	Procedure	Points
8	<p>Release the discharge pipe thermistor.</p>  <p>Discharge pipe thermistor (R11849)</p>	<p>■ Be careful not to lose the clip for the thermistor.</p>  <p>Clip</p> <p>(R12279)</p>
9	<p>Lift and remove the electrical box.</p>  <p>Electrical Box</p> <p>(R11852)</p>	

4.3 Removal of PCB

Procedure

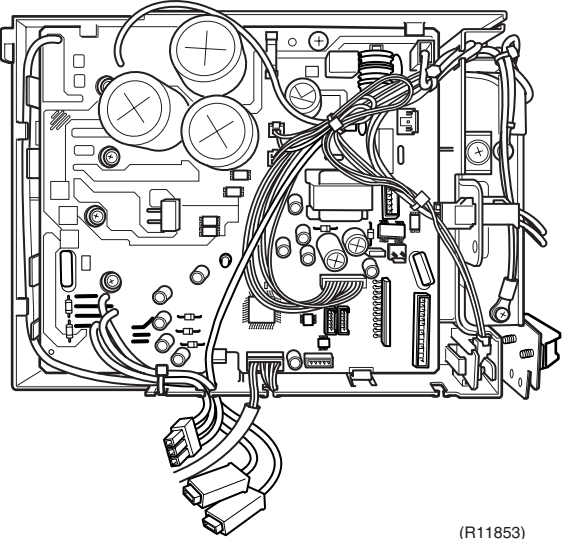
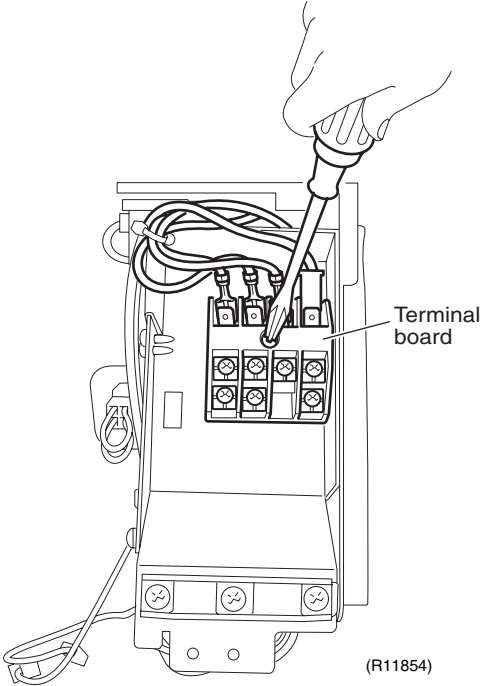
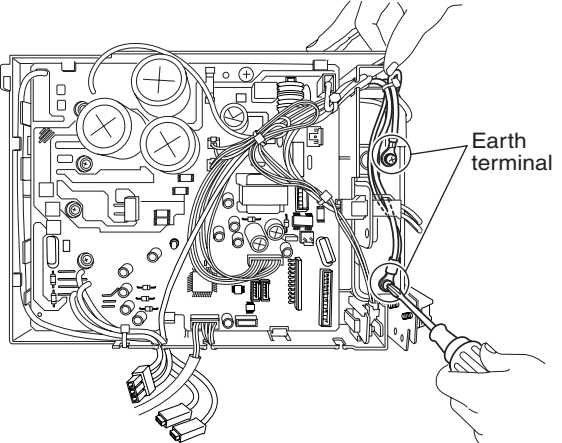

Warning Be sure to wait 10 minutes or more after turning off all power supplies before disassembling work.

Step	Procedure	Points
<p>1. Remove the main PCB.</p> <p>1 Feature of the main PCB</p> <p>2 Remove the screw on the terminal board.</p> <p>3 Release the 2 earth terminals.</p>	 <p>(R11853)</p>  <p>Terminal board</p> <p>(R11854)</p>  <p>Earth terminal</p> <p>(R11855)</p>	<ul style="list-style-type: none"> ■ You can remove the main PCB when you disconnect the lead wires on the terminal board without removing the electrical box.

Step	Procedure	Points
4	<p>Pull out the forced operation button PCB. Disconnect the connector [S110] to remove the forced operation PCB.</p>	<ul style="list-style-type: none"> ■ Be careful of a sharp protrusion at the back of the forced operation button PCB.
5	<p>Disconnect the relay connector.</p>	
6	<p>Cut the clamp.</p>	

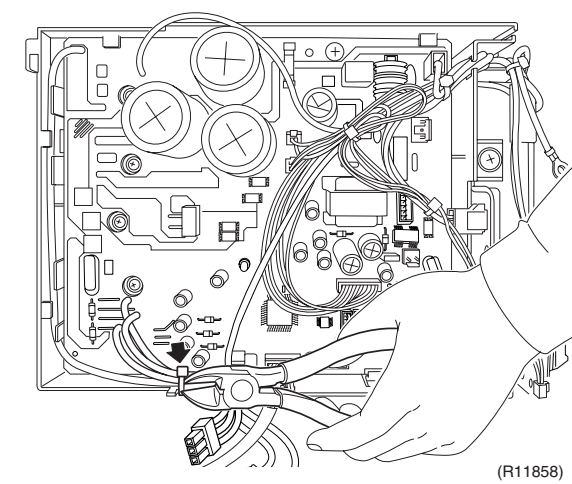
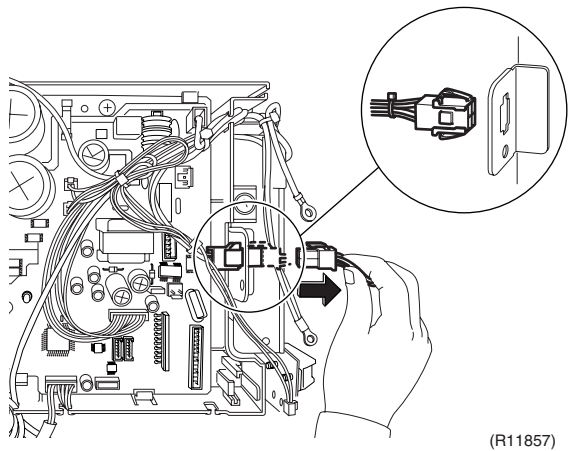
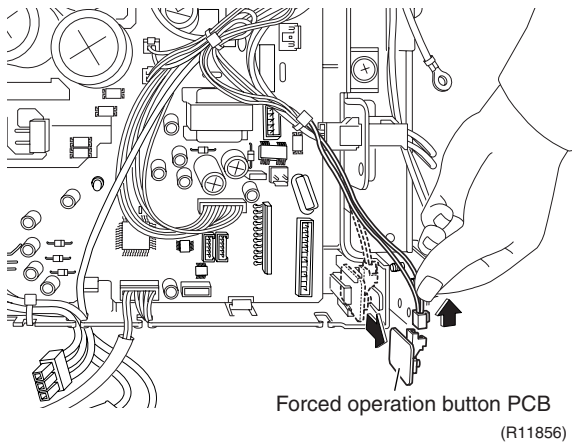

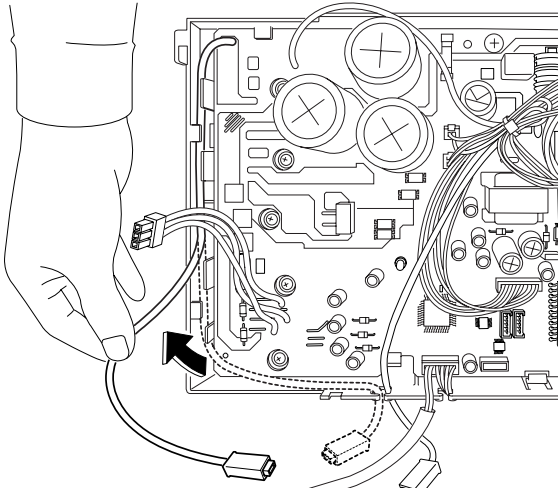
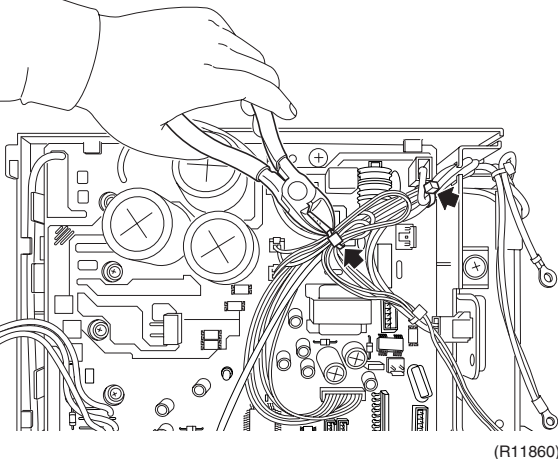
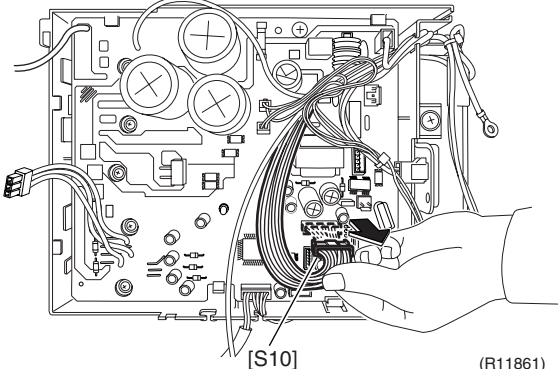
Step	Procedure	Points
7	Release the harness.	
	 <p>(R11859)</p>	
8	Cut the clamps at the 2 locations.	
	 <p>(R11860)</p>	
9	Disconnect the connector for the filter PCB [S10].	
	 <p>[S10] (R11861)</p>	

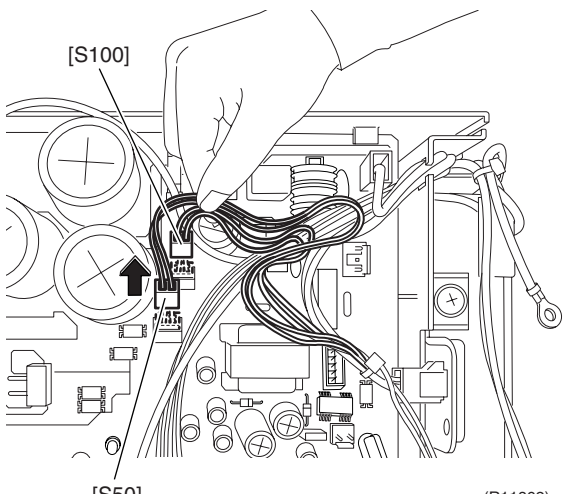
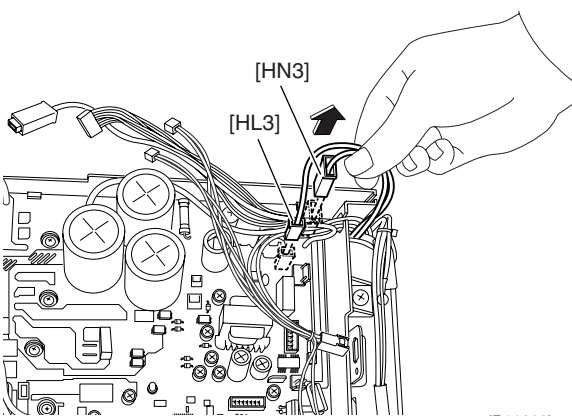
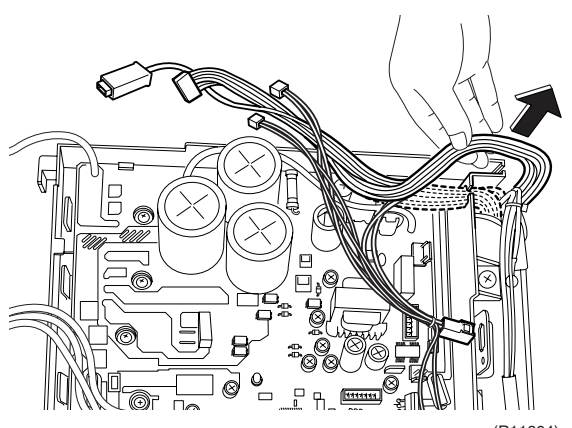
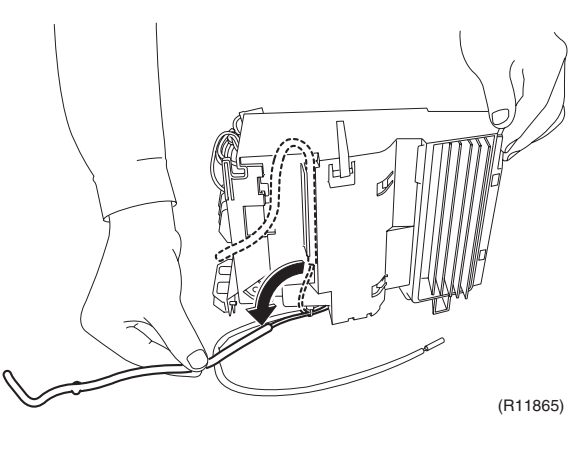
Step	Procedure	Procedure	Points
10	Disconnect the connectors for the magnetic relay [S50] and for the forced operation button PCB [S100].		
11	Disconnect the connector for the filter PCB [HL3] [HN3].		
12	Release the harnesses from the hook.		
13	Release the harness for the outdoor temperature thermistor.		

Step	Procedure	Points
14	Remove the 6 screws.	
15	Unfasten the 4 hooks and remove the main PCB.	<p>■ Refer to page 20 for detail.</p> <p>[S10] [HL3] [HN3]: filter PCB [S20]: electronic expansion valve coil [S40]: overload protector [S50]: magnetic relay [S70]: fan motor [S80]: four way valve coil [S90]: thermistors [S100]: forced operation button PCB</p>

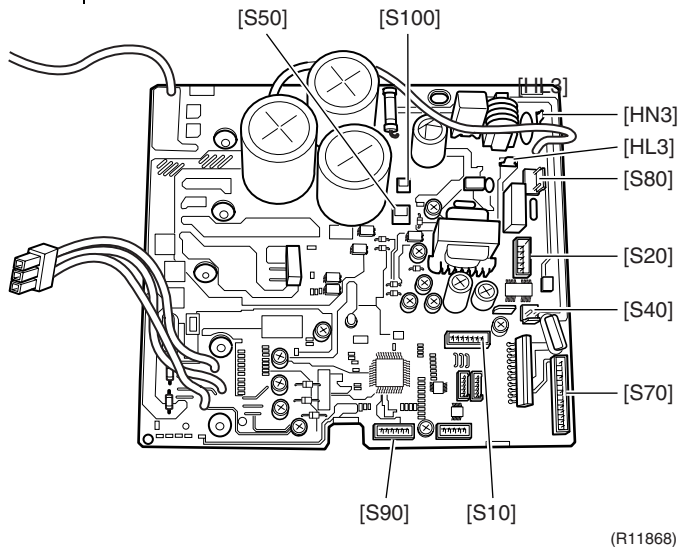
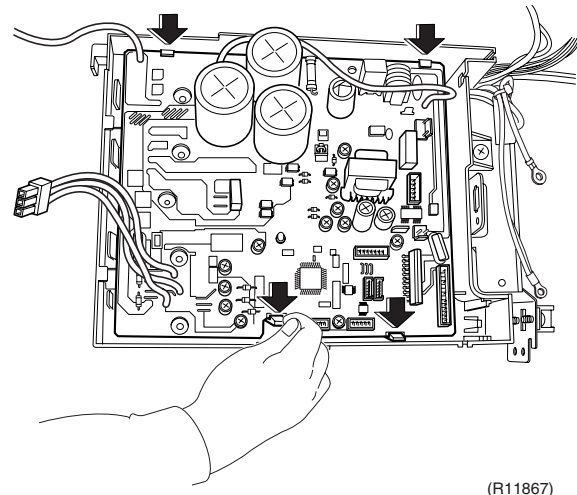
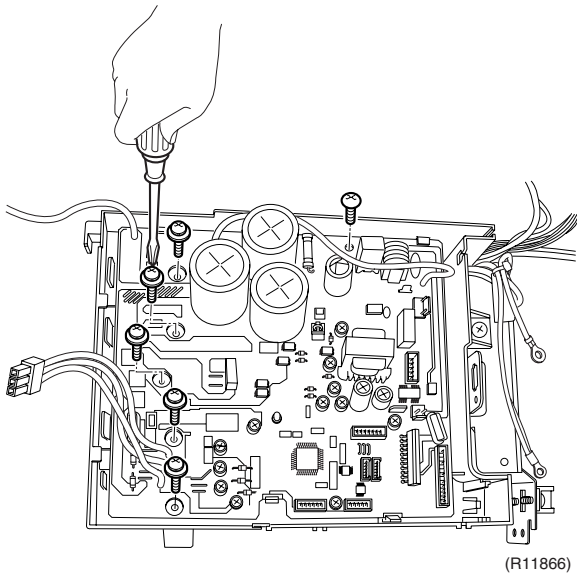

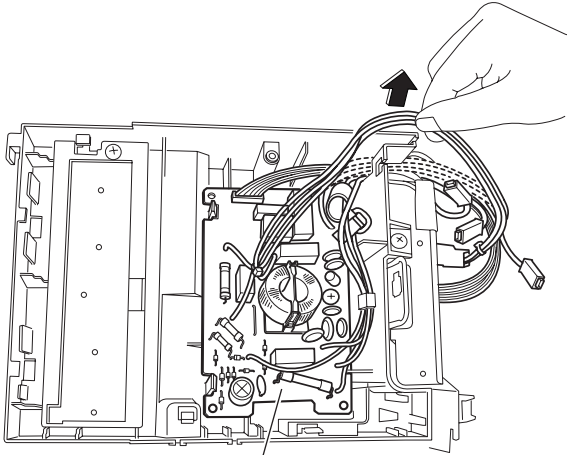
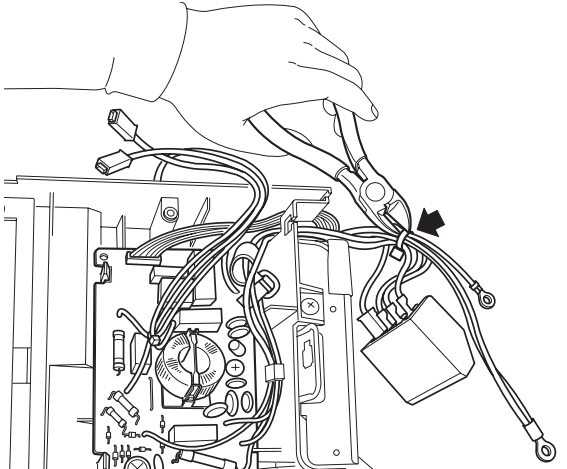
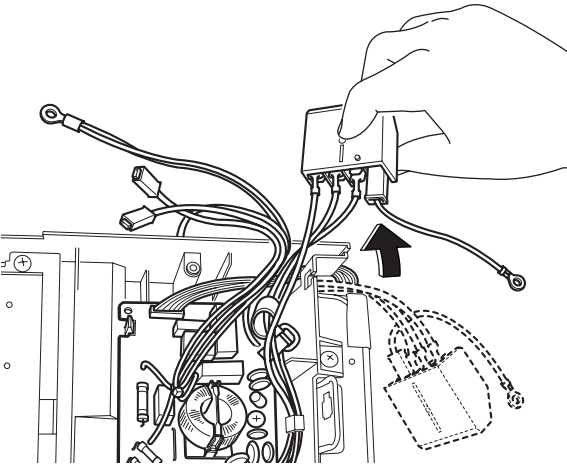
Step	Procedure	Points
2.	Remove the filter PCB.	
1	Release the harnesses from the hook.  <p style="text-align: center;">Filter PCB (R11869)</p>	
2	Cut the clamp.  <p style="text-align: center;">(R11871)</p>	
3	Release the harnesses from the hook.  <p style="text-align: center;">(R11872)</p>	

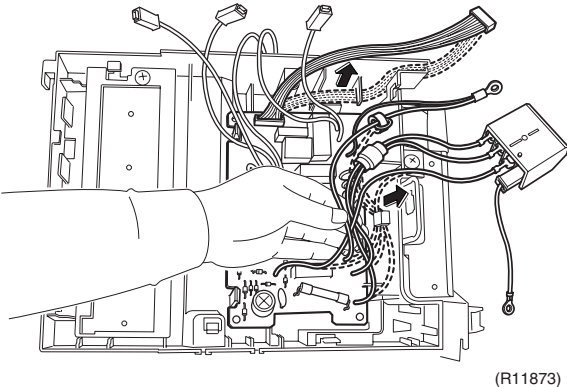
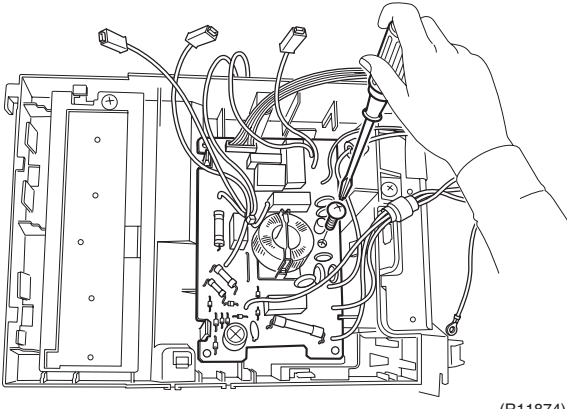
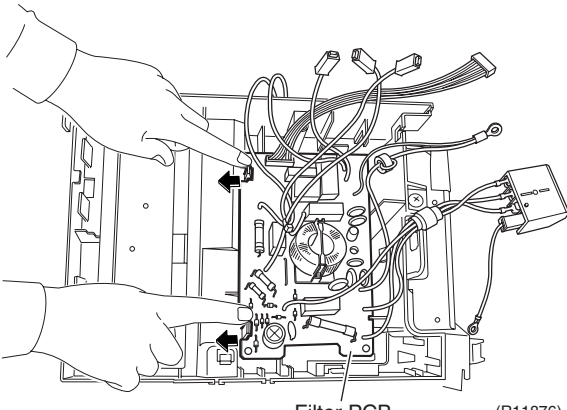
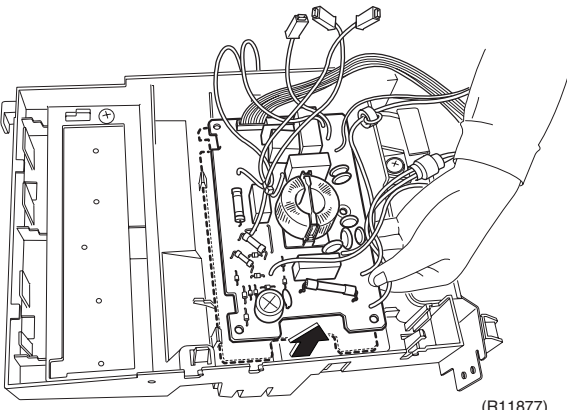
Step	Procedure	Points
4	Release the harnesses from the hooks.	
	 <p>(R11873)</p>	
5	Remove the screw.	
	 <p>(R11874)</p>	
6	Unfasten the 2 hooks.	
	 <p>Filter PCB (R11876)</p>	
7	Lift and pull out the filter PCB.	
	 <p>(R11877)</p>	

Step	Procedure	Points
8	Feature of the filter PCB	■ Refer to page 20 for detail.

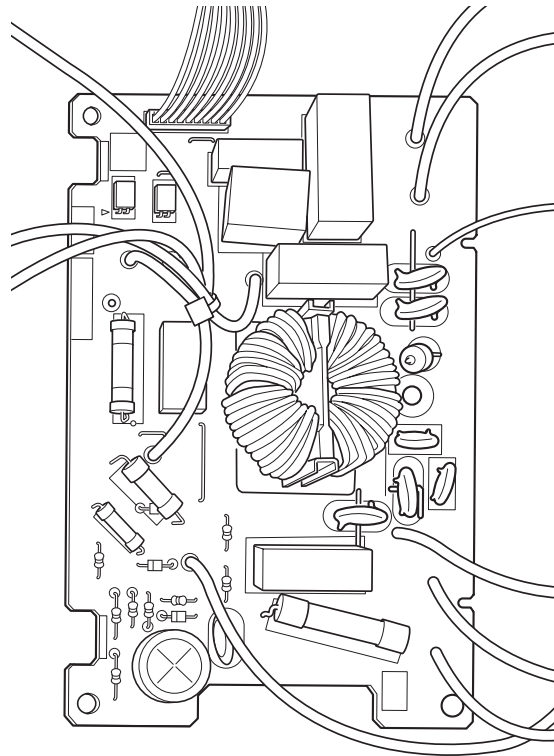

(R11878)

4.4 Removal of Reactor / Partition Plate

Procedure

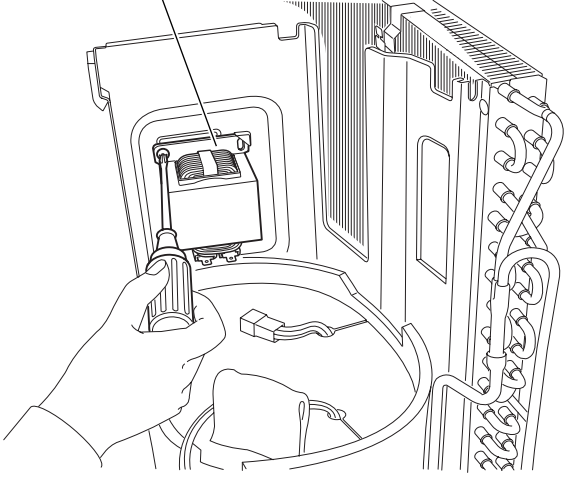
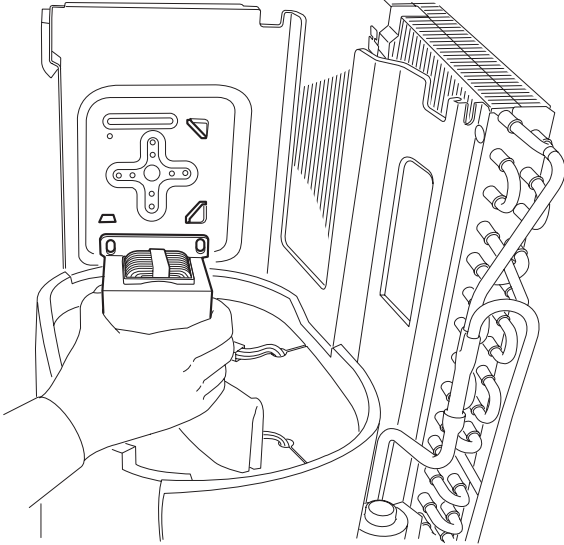
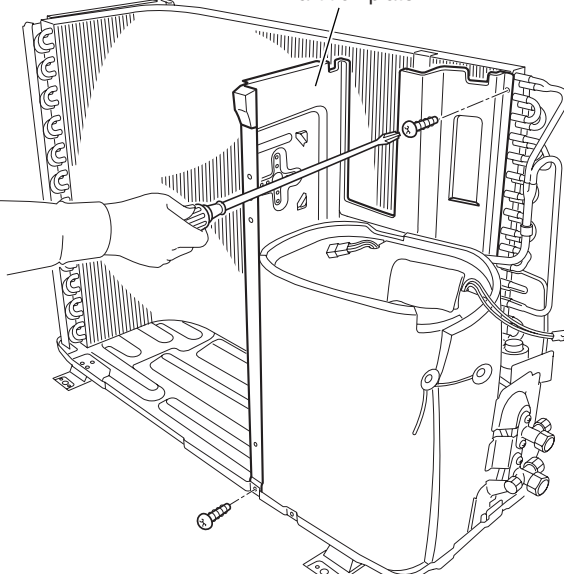

Warning Be sure to wait 10 minutes or more after turning off all power supplies before disassembling work.

Step	Procedure	Points
<p>1. Remove the reactor.</p> <p>1 Remove the screw and remove the reactor.</p>	<p style="text-align: center;">Reactor</p>  <p style="text-align: right;">(R11879)</p>  <p style="text-align: right;">(R11880)</p>	<p>Preparation</p> <ul style="list-style-type: none"> ■ Remove the outer panels according to the “Removal of Outer Panels / Fan Motor”. ■ Remove the electrical box according to the “Removal of Electrical Box”.
<p>2. Remove the partition plate.</p> <p>1 Remove the 2 screws.</p>	<p style="text-align: center;">Partition plate</p>  <p style="text-align: right;">(R12273)</p>	

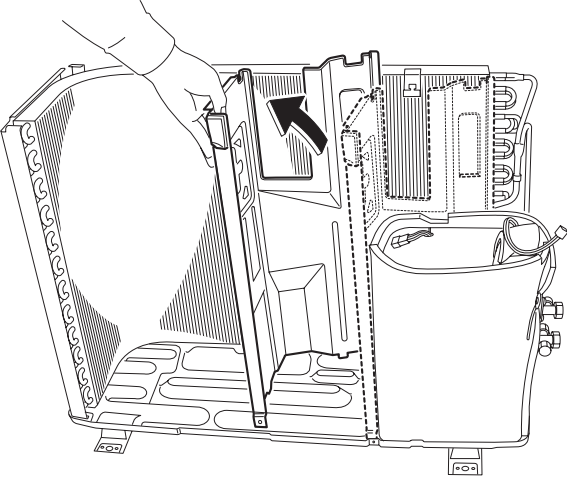
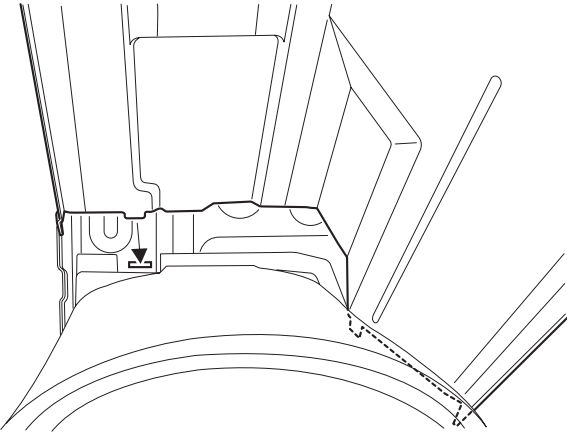
Step	Procedure	Points
2	<p data-bbox="199 219 454 376">The partition plate has a hook on the lower side. Lift and pull the partition plate to remove.</p>  <p data-bbox="979 712 1050 734">(R12280)</p>  <p data-bbox="995 1196 1066 1218">(R11883)</p>	<ul style="list-style-type: none"> <li data-bbox="1093 741 1437 831">■ When reassembling, fit the lower hook into the bottom frame.

4.5 Removal of Sound Blanket

Procedure

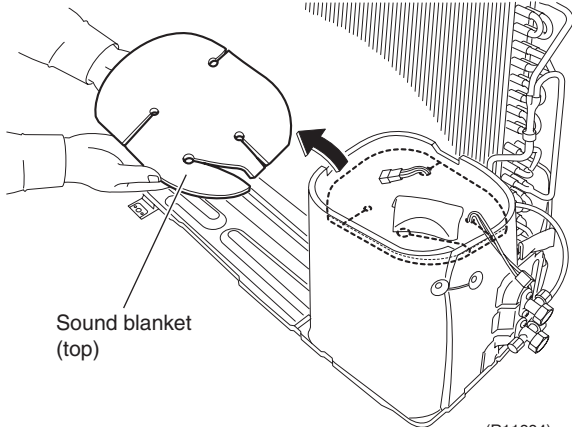
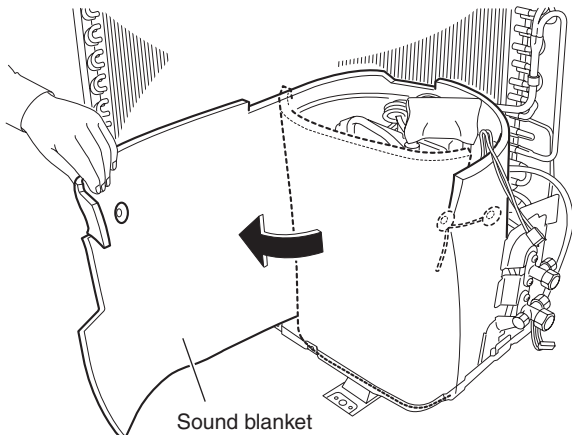
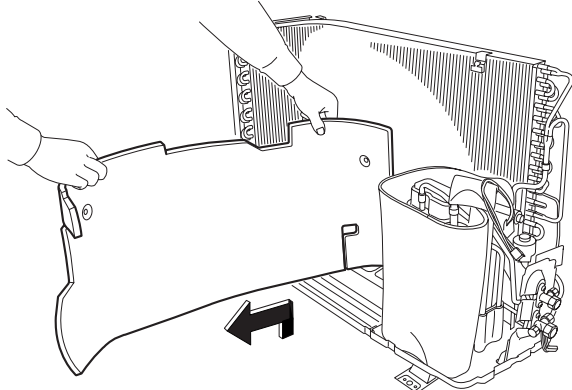

Warning Be sure to wait 10 minutes or more after turning off all power supplies before disassembling work.

Step	Procedure	Procedure	Points
1	Remove the sound blanket (top).	 <p style="text-align: right;">(R11884)</p>	<ul style="list-style-type: none"> ■ Since the piping ports are torn easily, remove the sound blanket carefully.
2	Untie the string and open the sound blanket (outer).	 <p style="text-align: right;">(R11885)</p>	
3	Lift and remove the sound blanket (outer).	 <p style="text-align: right;">(R11886)</p>	

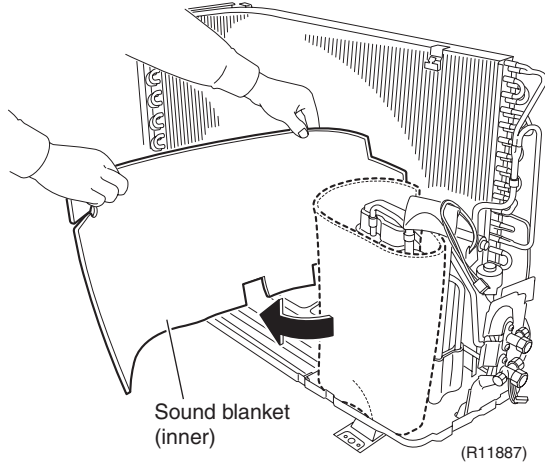
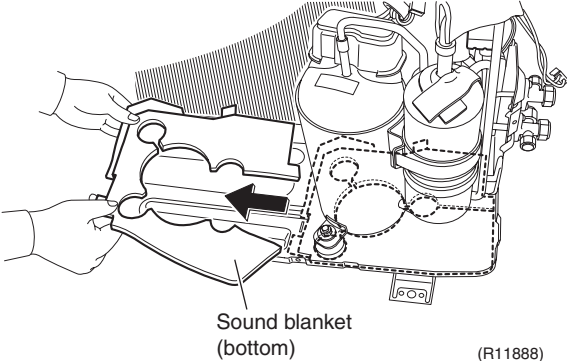
Step	Procedure	Points
4	<p>Pull the sound blanket (inner) out.</p> 	
5	<p>Pull the sound blanket (bottom) out.</p> 	

4.6 Removal of Four Way Valve

Procedure

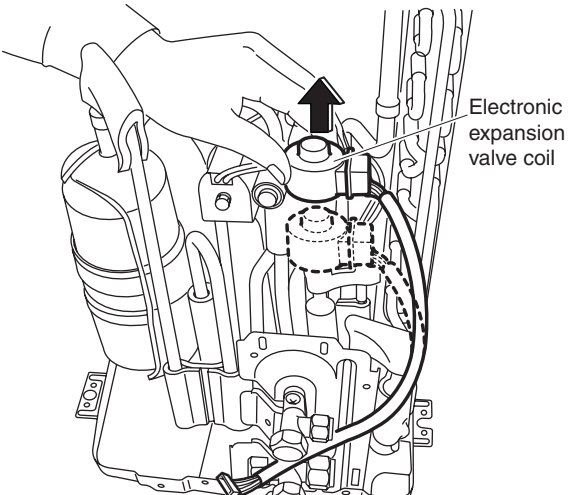
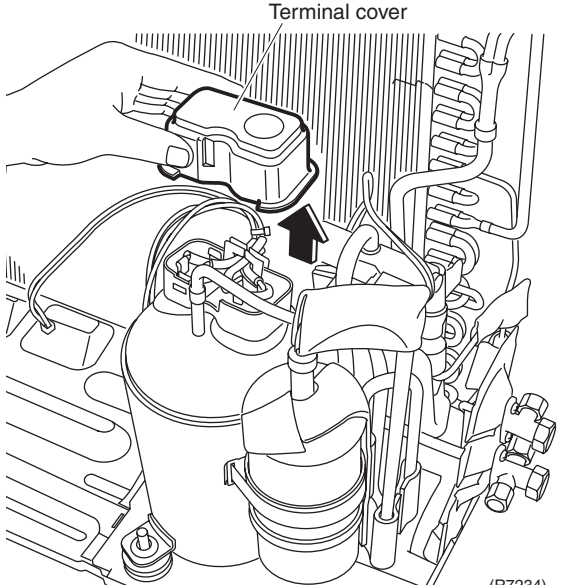
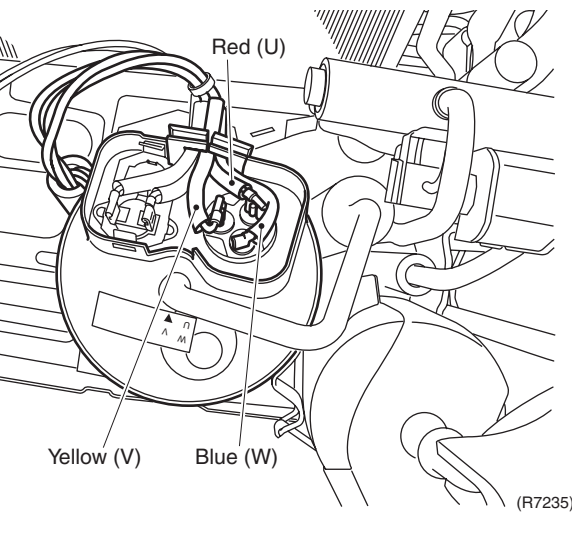

Warning Be sure to wait 10 minutes or more after turning off all power supplies before disassembling work.

Step	Procedure	Procedure	Points
1	Pull out the electronic expansion valve coil.	 <p>(R7233)</p>	
2	Remove the terminal cover.	 <p>(R7234)</p>	
3	Disconnect the lead wires of the compressor.	 <p>(R7235)</p>	

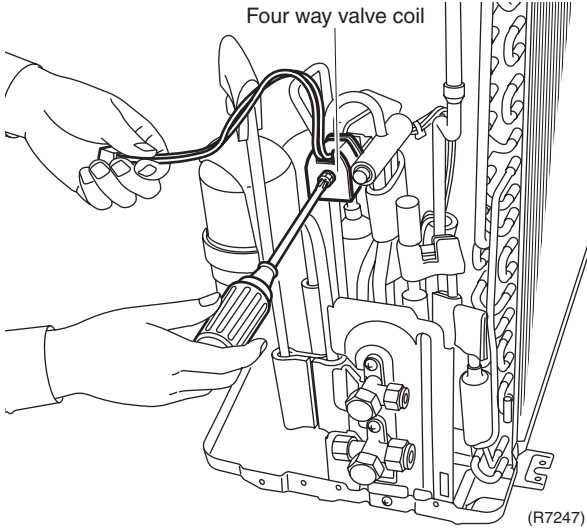
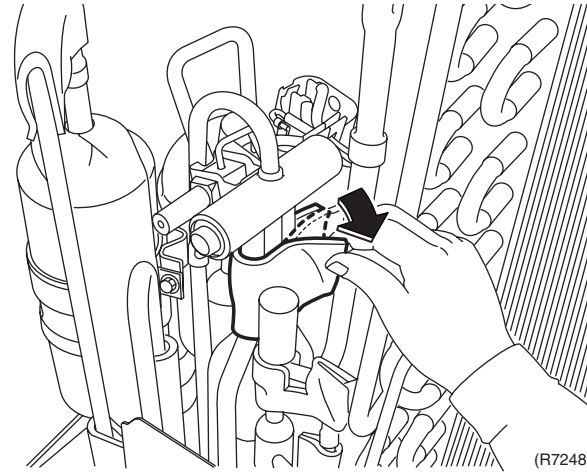
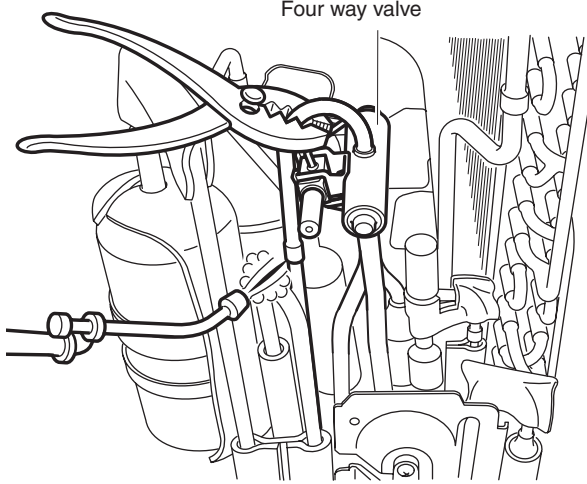
Step	Procedure	Points
4	<p>Remove the screw and remove the four way valve coil.</p> 	<p>Warning Be careful not to get yourself burnt with the pipes and other parts that are heated by the gas brazing machine.</p> <p>Warning If the refrigerant gas leaks during work, ventilate the room. (If the refrigerant gas is exposed to flames, toxic gas may be generated.)</p> <p>Caution From the viewpoint of global environment protection, do not discharge the refrigerant gas in the atmosphere. Make sure to collect all the refrigerant gas.</p>
5	<p>Remove the sheets of putty.</p> 	<p>Cautions for restoration</p> <ol style="list-style-type: none"> 1. Restore the piping by non-oxidation brazing. 2. It is required to prevent the carbonization of the oil inside the four way valve and the deterioration of the gaskets affected by heat. (Keep below 120°C.) For the sake of this, wrap the four way valve with wet cloth and provide water so that the cloth does not dry.
6	<p>Heat up the brazed part and withdraw the piping with pliers.</p> 	<p>In case of difficulty with gas brazing machine</p> <ol style="list-style-type: none"> 1. Disconnect the brazed part where is easy to disconnect and restore. 2. Cut pipes on the main unit with a tube cutter in order to make it easy to disconnect.

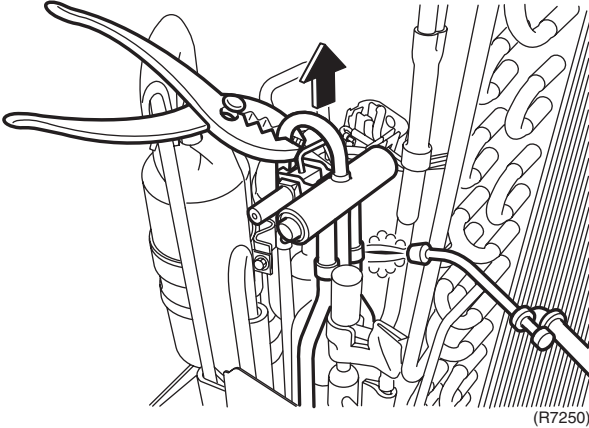
Step	Procedure	Points
	 <p>(R7250)</p>	<p>Note:</p> <ul style="list-style-type: none">■ Do not use a metal saw for cutting pipes by all means because the sawdust comes into the circuit.■ When withdrawing the pipes, be careful not to pinch them firmly with pliers. The pipes may get deformed.■ Provide a protective sheet or a steel plate so that the brazing flame cannot influence peripheries.

4.7 Removal of Compressor

Procedure

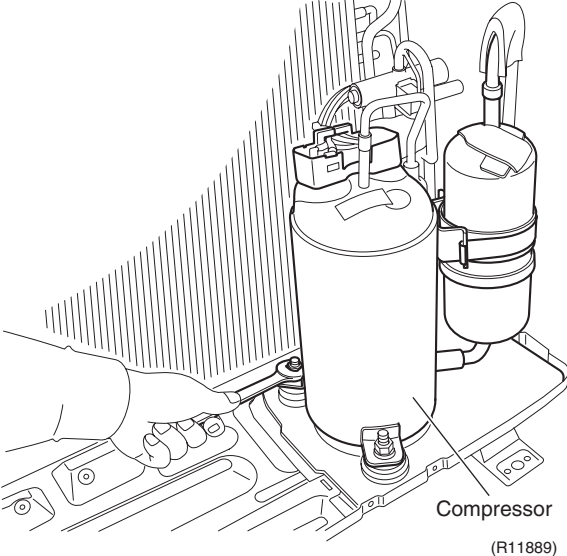
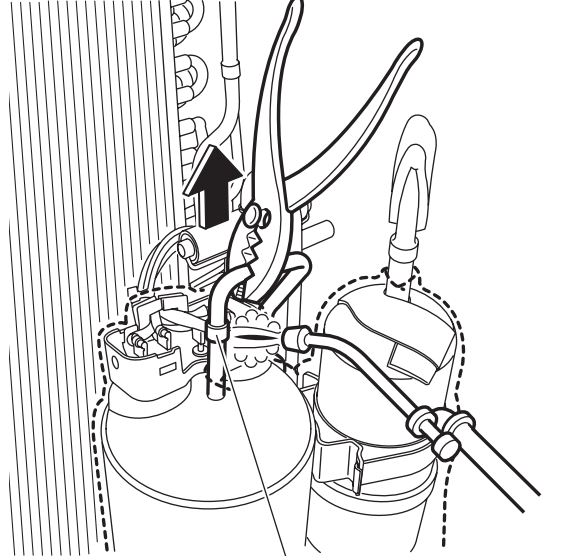
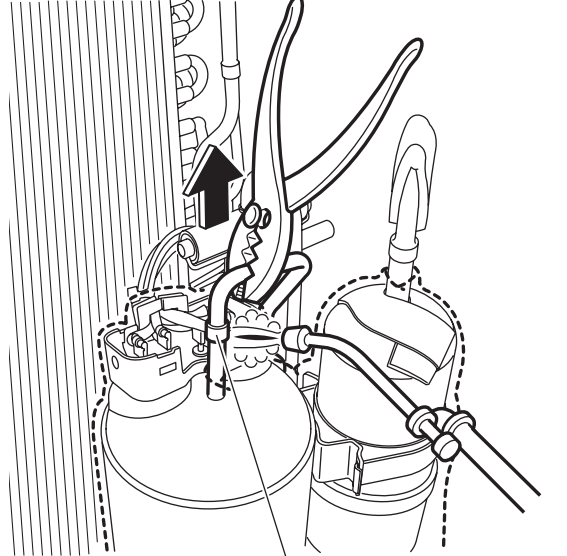

Warning Be sure to wait 10 minutes or more after turning off all power supplies before disassembling work.

Step	Procedure	Points
1	Remove the 2 nuts of the compressor. 	<p>Warning Be careful not to get yourself burnt with pipes and other parts that are heated by the gas brazing machine.</p> <p>Warning If the refrigerant gas leaks during work, ventilate the room. (If the refrigerant gas is exposed to flames, toxic gas may be generated.)</p> <p>Warning Since it may happen that the refrigerant oil in the compressor catches fire, prepare wet cloth so as to extinguish fire immediately.</p>
<ul style="list-style-type: none"> ■ Before working, make sure that the refrigerant is empty in the circuit. ■ Be sure to apply nitrogen replacement when heating up the brazed part. 		<p>Caution From the viewpoint of global environment protection, do not discharge the refrigerant gas in the atmosphere. Make sure to collect all the refrigerant gas.</p>
2	Heat up the brazed part of the discharge side and disconnect. 	<p>Cautions for restoration</p> <ol style="list-style-type: none"> 1. Restore the piping by non-oxidation brazing. 2. It is required to prevent the carbonization of the oil inside the four way valve and the deterioration of the gaskets affected by heat. (Keep below 120°C.) For the sake of this, wrap the four way valve with wet cloth and provide water so that the cloth does not dry. <p>In case of difficulty with gas brazing machine</p> <ol style="list-style-type: none"> 1. Disconnect the brazed part where is easy to disconnect and restore. 2. Cut pipes on the main unit with a tube cutter in order to make it easy to disconnect.

Step	Procedure	Points
3	Heat up the brazed part of the suction side and disconnect.	<p>Note:</p> <ul style="list-style-type: none"> ■ Do not use a metal saw for cutting pipes by all means because the sawdust comes into the circuit. ■ When withdrawing the pipes, be careful not to pinch them firmly with pliers. The pipes may get deformed. ■ Provide a protective sheet or a steel plate so that the brazing flame cannot influence peripheries.
4	Lift the compressor up and remove it.	<ul style="list-style-type: none"> ■ Be careful so as not to burn the compressor terminals, the name plate, the heat exchanger fin.

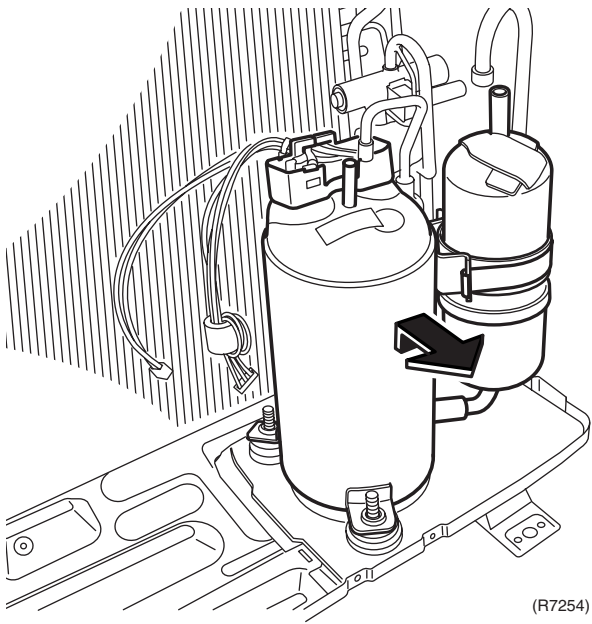
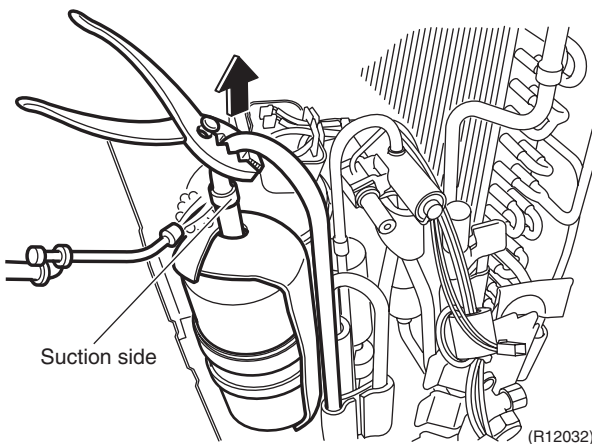

Part 8

Trial Operation and Field Settings

1. Trial Operation	208
2. Field Settings	209
2.1 When 2 Units are Installed in 1 Room.....	209
2.2 Standby Electricity Saving.....	210
2.3 Facility Setting Jumper (cooling at low outdoor temperature)	211
2.4 Jumper and Switch Settings.....	212
3. Application of Silicon Grease to a Power Transistor and a Diode Bridge	213

1. Trial Operation

Outline

1. Measure the supply voltage and make sure that it falls in the specified range.
2. Trial operation should be carried out in either cooling or heating mode.
3. Carry out the trial operation in accordance with the operation manual to ensure that all functions and parts, such as louver movement, are working properly.
 - The air conditioner requires a small amount of power in its standby mode. If the system is not to be used for some time after installation, shut off the circuit breaker to eliminate unnecessary power consumption.
 - If the circuit breaker trips to shut off the power to the air conditioner, the system backs up the operation mode. The system then restarts operation with the previous mode when the circuit breaker is restored.

In cooling mode, select the lowest programmable temperature; in heating mode, select the highest programmable temperature.

- Trial operation may be disabled in either mode depending on the room temperature.
- After trial operation is complete, set the temperature to a normal level.
(26°C to 28°C in cooling mode, 20°C to 24°C in heating mode)
- For protection, the system does not start for 3 minutes after it is turned off.

Detail

ARC433 Series

- (1) Press the ON/OFF button to turn on the system.
- (2) Press the center of the TEMP button and the MODE button at the same time.
- (3) Press the MODE button twice.
(“?” appears on the display to indicate that trial operation is selected.)
- (4) Press the MODE button and select operation mode.
- (5) Trial operation terminates in approx. 30 minutes and switches into normal mode. To quit a trial operation, press the ON/OFF button.

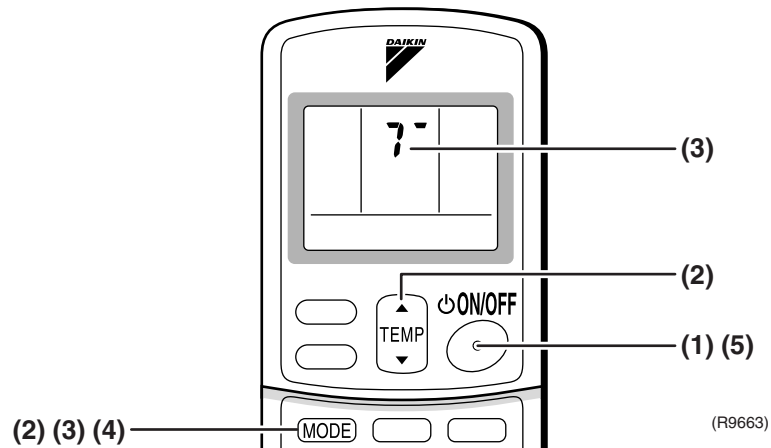

2. Field Settings

2.1 When 2 Units are Installed in 1 Room

When 2 indoor units are installed in 1 room, 1 of the 2 pairs of indoor unit and wireless remote controller can be set for different address.

Both the indoor unit PCB and the wireless remote controller need alteration.

Indoor Unit PCB

- Cut the address setting jumper JA on the control PCB.

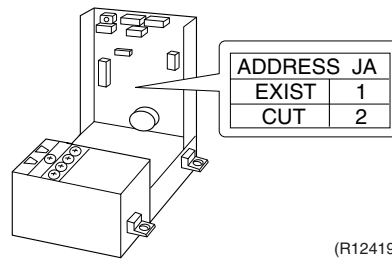

Wireless Remote Controller

- Cut the address setting jumper J4.

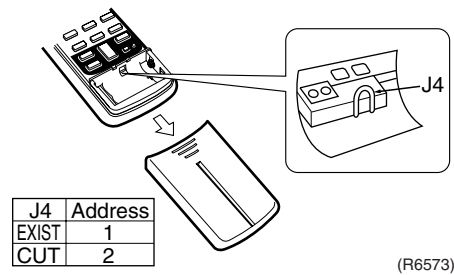

2.2 Standby Electricity Saving

Outline

RK(X)S25/35G2V1B, RK(X)S25/35G2V1B9 Models Only

This function turns power supply OFF to the outdoor unit and sets the indoor unit into energy-saving mode, thus reducing the power consumption of the air conditioner.

Detail

Following procedure is required for turning ON the function.

1. Check that the main power supply is turned OFF. Turn OFF if it has not been turned OFF.
2. Remove the stop valve cover.
3. Disconnect the selective connector for standby electricity saving.
4. Turn ON the main power supply.

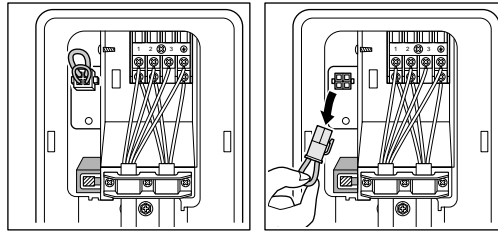

Function OFF

Function ON

The standby electricity saving function is turned OFF before shipping.



Caution

Before connecting or disconnecting the selective connector for standby electricity saving, make sure that the main power supply is turned OFF.

(R11820)

2.3 Facility Setting Jumper (cooling at low outdoor temperature)

Outline

For Cooling Only Model

This function is limited only for facilities (the target of air conditioning is equipment (such as computer)). Never use it in a residence or office (the space where there is a human).

Detail

You can expand the operation range to -15°C by cutting jumper on the outdoor unit PCB. If the outdoor temperature falls to -20°C or lower, the operation stops. If the outdoor temperature rises, the operation starts again.

■ RKS25/35E2V1B

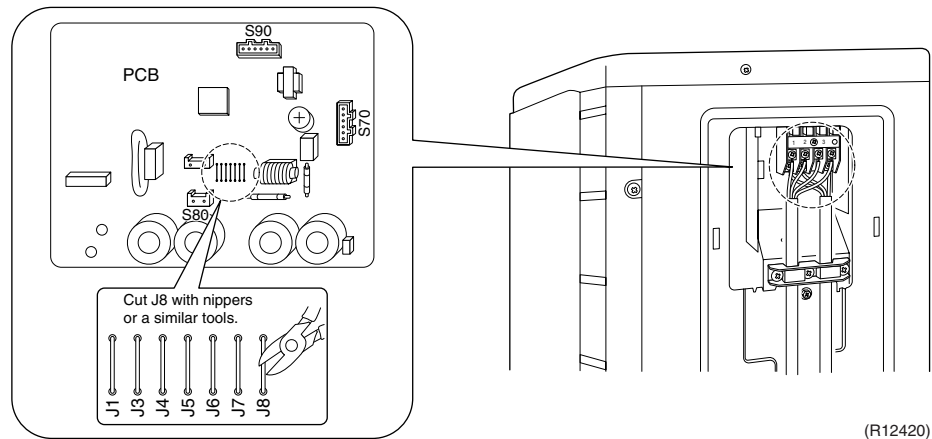

■ RKS25/35G2V1B

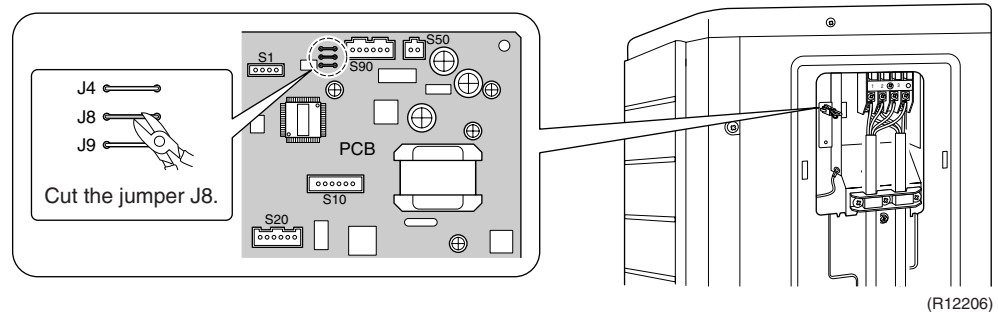

■ RKS25/35G2V1B9

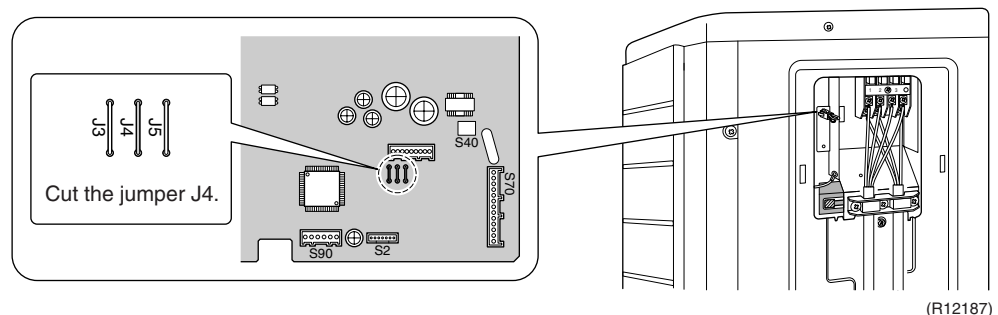

Caution

1. If the outdoor unit is installed where the outdoor heat exchanger of the unit is exposed to direct wind, provide a windbreak wall.
2. Intermittent noises may be produced by the indoor unit due to the outdoor fan turning on and off when using facility settings.
3. Do not place humidifiers or other items which might raise the humidity in rooms where facility settings are being used.

- A humidifier might cause dew jumping from the indoor unit outlet vent.
4. Cutting jumper sets the indoor fan tap to the highest position.

2.4 Jumper and Switch Settings

Jumper	Function	When connected (factory set)	When cut
JB (on indoor unit PCB)	Fan speed setting when compressor stops for thermostat OFF. (effective only at cooling operation)	Fan speed setting; Remote controller setting	Fan rpm is set to "0" <Fan stop>
JC (on indoor unit PCB)	Power failure recovery function	Auto-restart	The unit does not resume operation after recovering from a power failure. Timer ON/OFF settings are cleared.
J5 (on outdoor unit PCB)	Improvement of defrost performance	Standard control	Reinforced control (ex. The frequency increases, the duration time of defrost lengthens.)

<Floor / Ceiling Suspended Dual Type>

Switch	Function	FLOOR (factory set)	CEILING
SW2 (on indoor unit PCB)	Installation style changeover	When installed as the floor mounted type	When installed as the ceiling suspended type



For the location of the jumper and the switch, refer to the following pages.

Indoor unit; page 14

Outdoor unit; page 16, 18, 20

3. Application of Silicon Grease to a Power Transistor and a Diode Bridge

Applicable Models

All outdoor units using inverter type compressor for room air conditioner.

When the printed circuit board (PCB) of an outdoor unit is replaced, it is required that silicon grease (*1) is certainly applied to the heat radiation part (the contact point to the radiation fin) of the power transistor and diode bridge.

*1: Parts number of the silicon grease – 1172698 (Drawing number 3FB03758-1)

Details

The silicon grease is an essential article for encouraging the heat radiation of the power transistor and the diode bridge. Applying the paste should be implemented in accordance with the following instruction.

Remark: There is the possibility of failure with smoke in case of bad heat radiation.

- Wipe off the old silicon grease completely on a radiation fin.
- Apply the silicon grease evenly to the whole.
- Do not leave any foreign object such as solder or paper waste between the power transistor and the radiation fin, and also the diode bridge, and the radiation fin.
- Tighten the screws of the power transistor and the diode bridge, and contact to the radiation fin without any gap.

<Example>

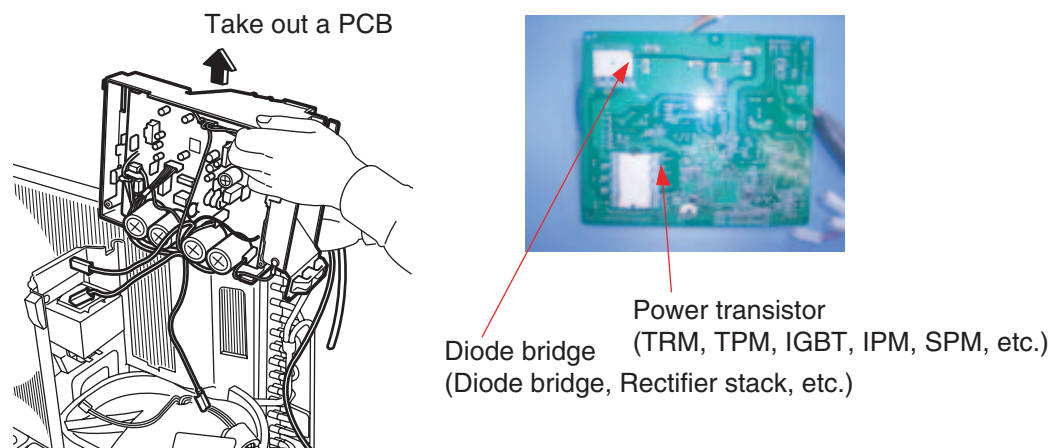

OK : Evenly applied silicon grease.



NG : Not evenly applied

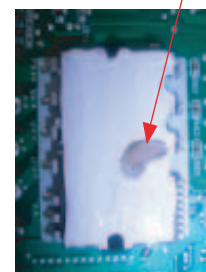

NG : Foreign object

(R9056)

Part 9

Appendix

1. Piping Diagrams.....	215
1.1 Indoor Unit.....	215
1.2 Outdoor Unit.....	216
2. Wiring Diagrams.....	218
2.1 Indoor Unit.....	218
2.2 Outdoor Unit.....	218

1. Piping Diagrams

1.1 Indoor Unit

FLKS25/35BAVMB

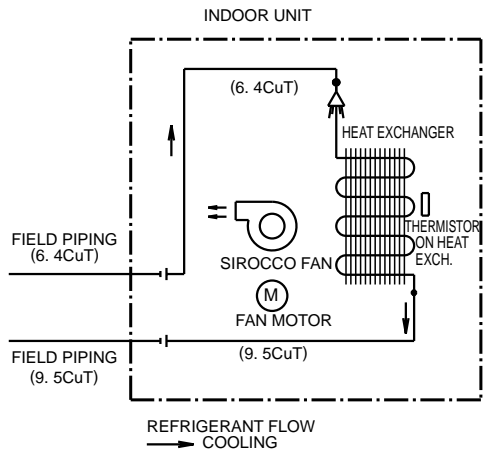

4D034012E

FLXS25/35BAVMB

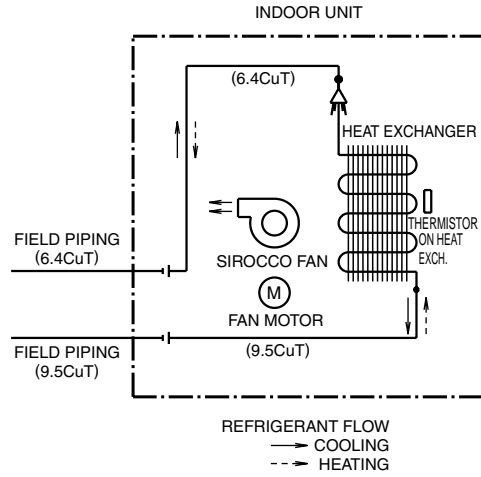

4D048722B

1.2 Outdoor Unit

1.2.1 Cooling Only

RKS25/35E2V1B

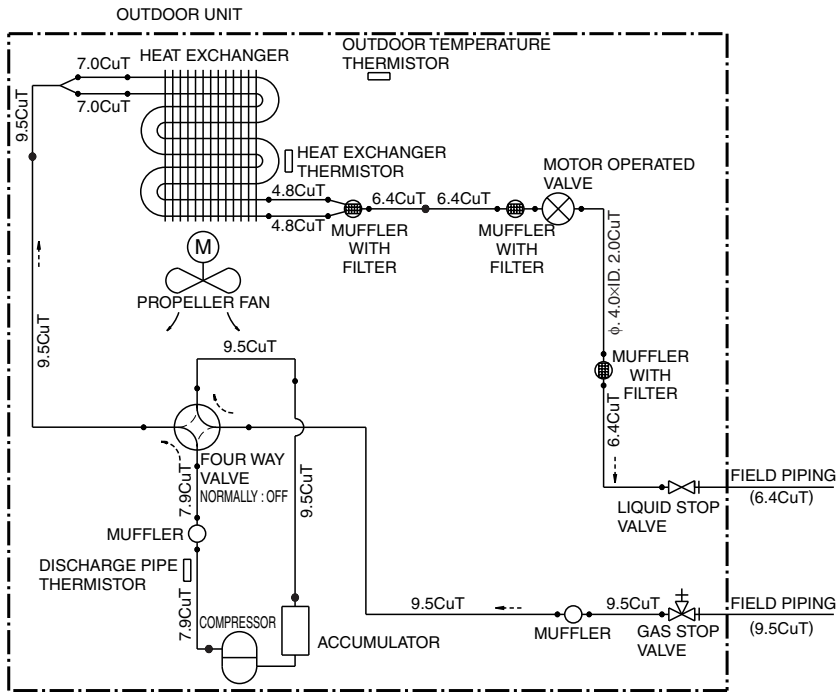

3D047318G

RKS25/35G2V1B, RKS25/35G2V1B9

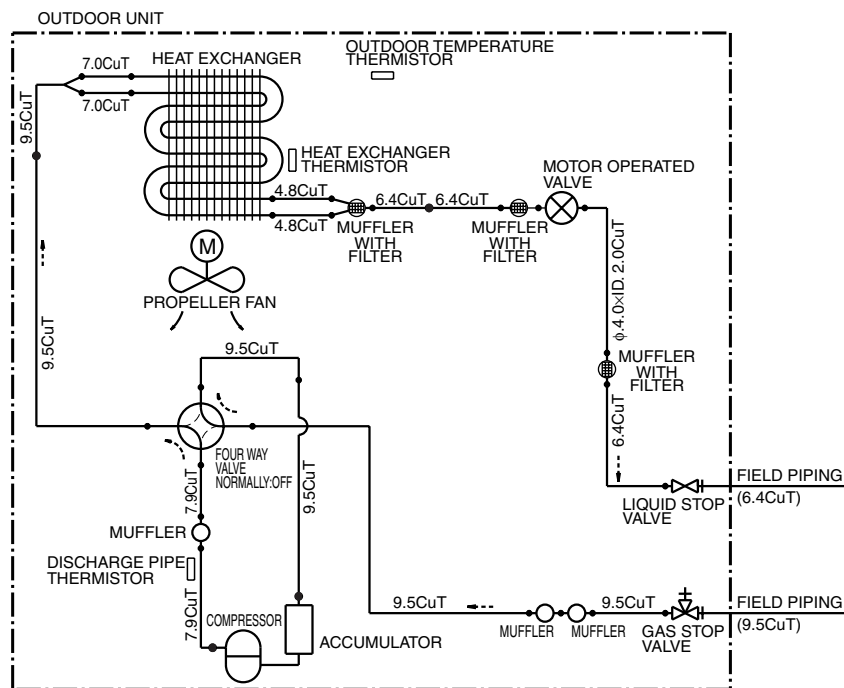

3D059589B

1.2.2 Heat Pump

RXS25/35E2V1B

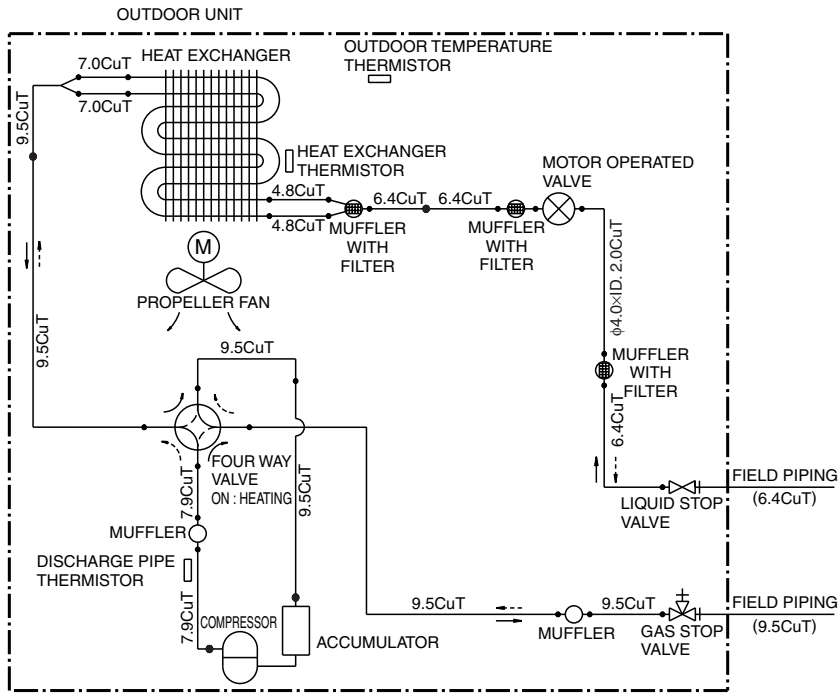

3D047316Q

RXS25/35G2V1B, RXS25/35G2V1B9

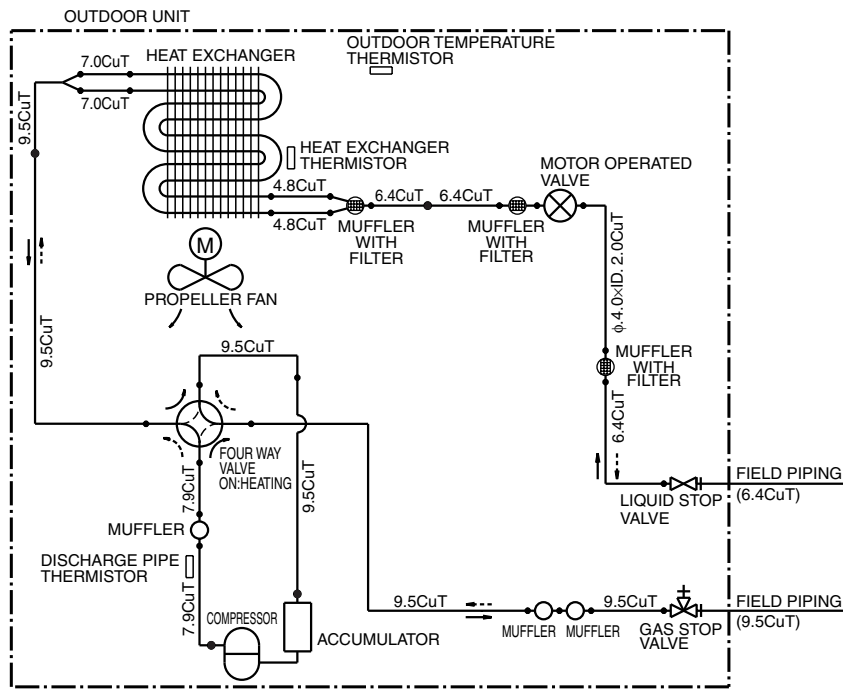

3D059586E

2. Wiring Diagrams

2.1 Indoor Unit

FLK(X)S25/35BAVMB

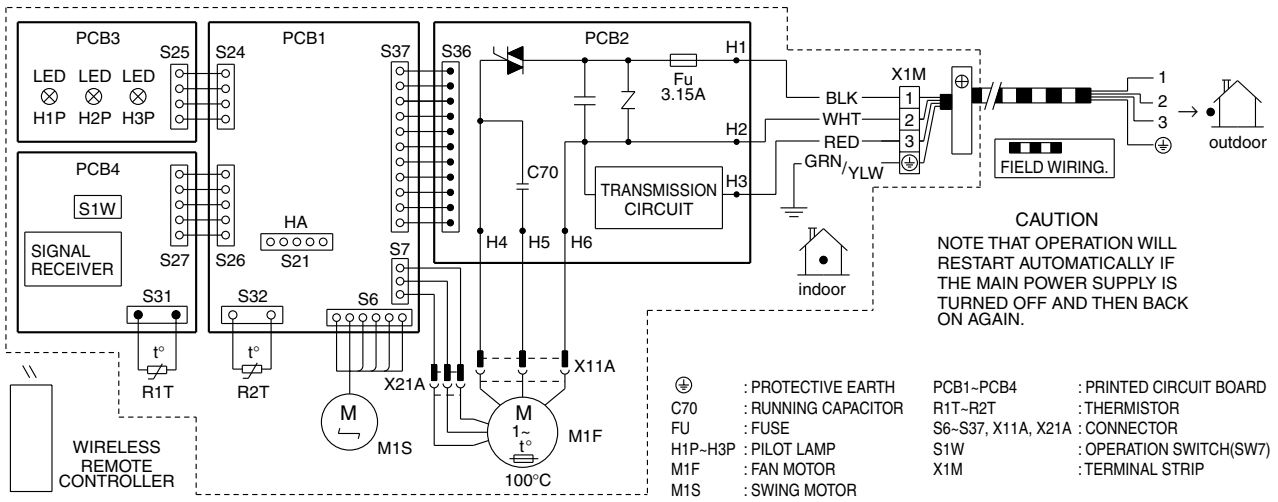

3D033909F

2.2 Outdoor Unit

RK(X)S25/35E2V1B

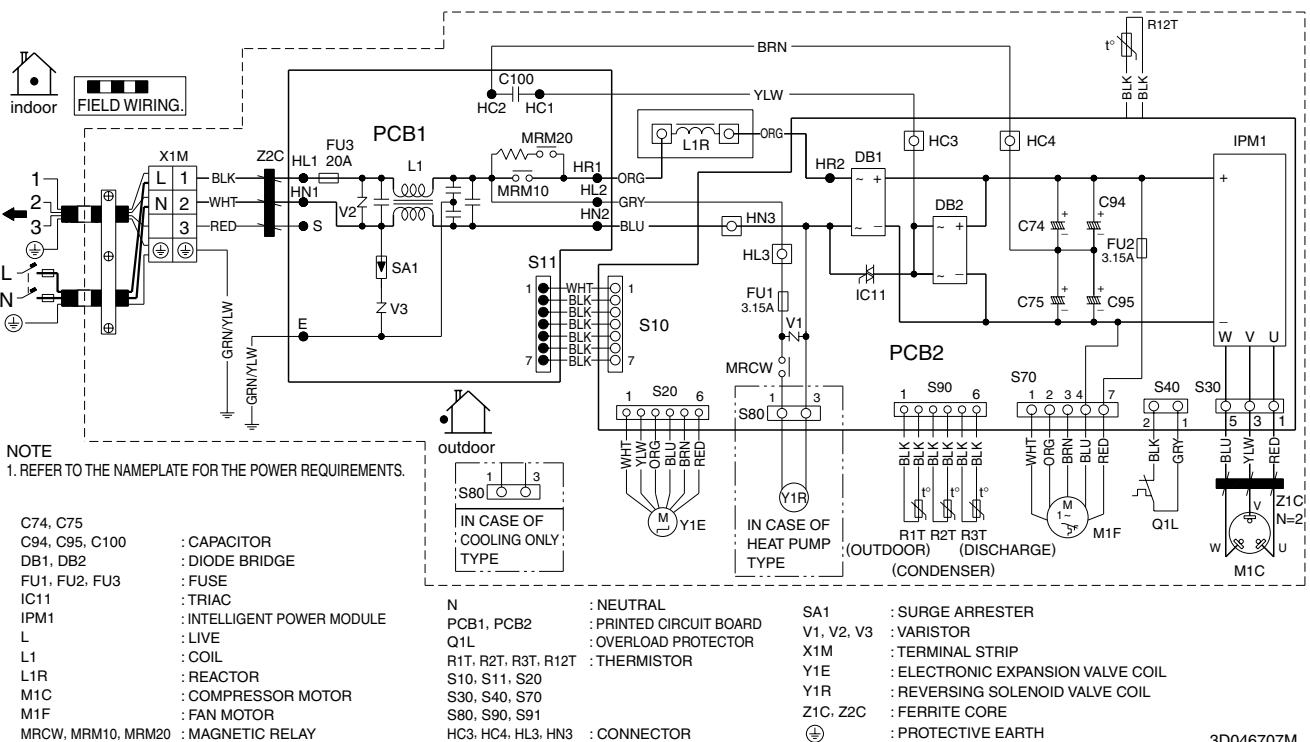

3D046707M

RK(X)S25/35G2V1B

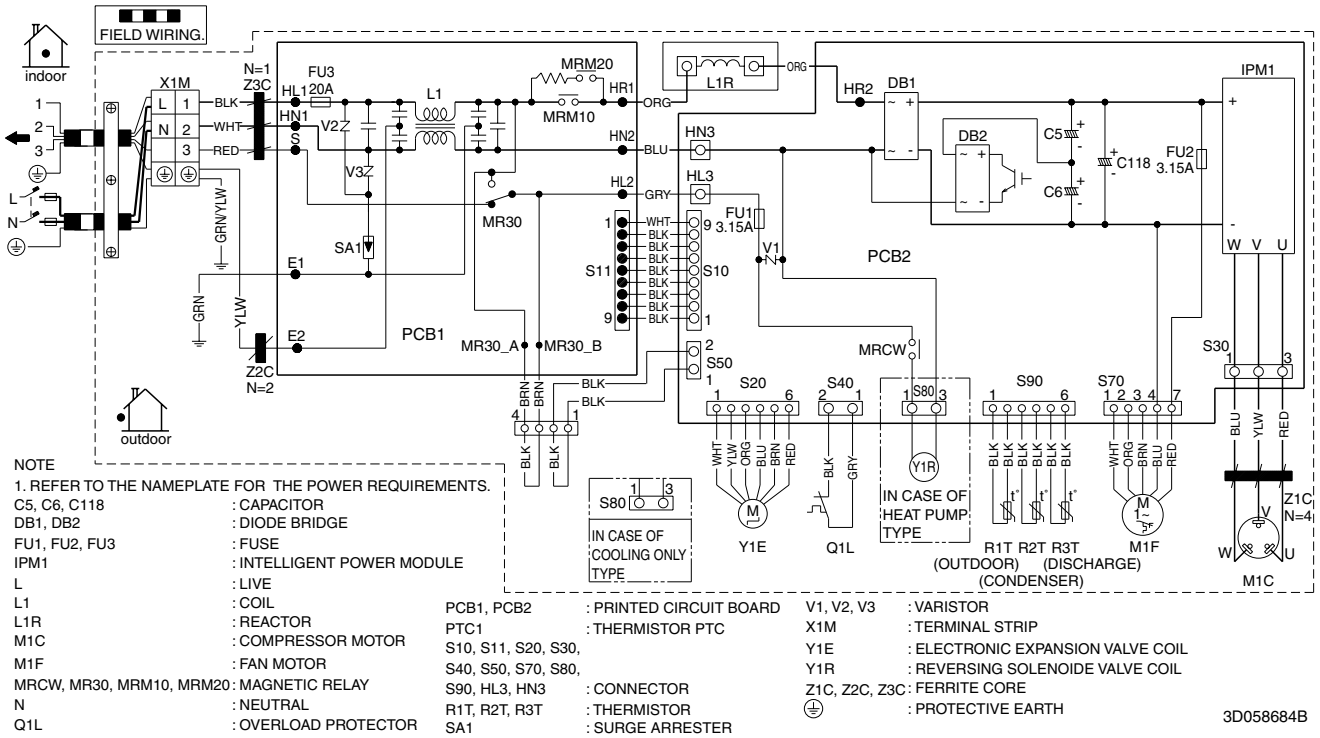

RK(X)S25/35G2V1B9

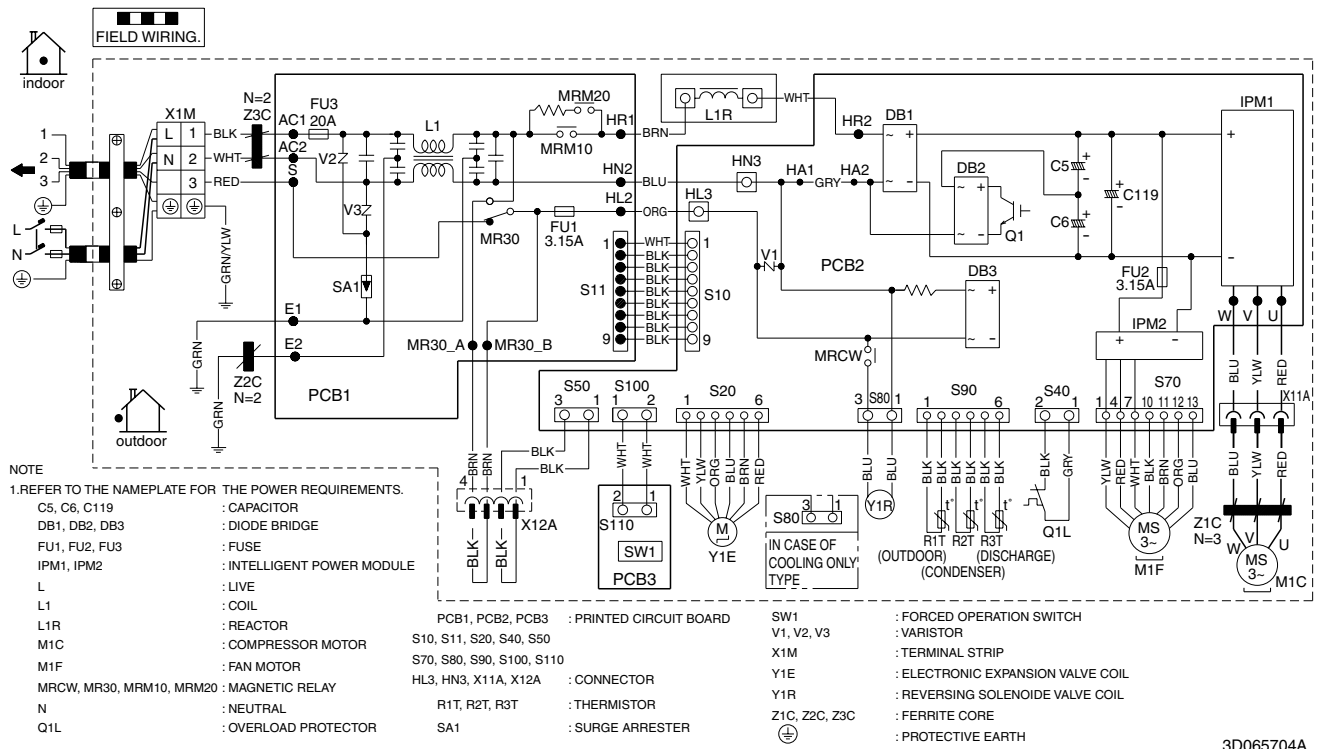

Warning



- Daikin Industries, Ltd.'s products are manufactured for export to numerous countries throughout the world. Daikin Industries, Ltd. does not have control over which products are exported to and used in a particular country. Prior to purchase, please therefore confirm with your local authorised importer, distributor and/or retailer whether this product conforms to the applicable standards, and is suitable for use, in the region where the product will be used. This statement does not purport to exclude, restrict or modify the application of any local legislation.
- Ask a qualified installer or contractor to install this product. Do not try to install the product yourself. Improper installation can result in water or refrigerant leakage, electrical shock, fire or explosion.
- Use only those parts and accessories supplied or specified by Daikin. Ask a qualified installer or contractor to install those parts and accessories. Use of unauthorised parts and accessories or improper installation of parts and accessories can result in water or refrigerant leakage, electrical shock, fire or explosion.
- Read the User's Manual carefully before using this product. The User's Manual provides important safety instructions and warnings. Be sure to follow these instructions and warnings.

If you have any enquiries, please contact your local importer, distributor and/or retailer.

Cautions on product corrosion

1. Air conditioners should not be installed in areas where corrosive gases, such as acid gas or alkaline gas, are produced.
2. If the outdoor unit is to be installed close to the sea shore, direct exposure to the sea breeze should be avoided. If you need to install the outdoor unit close to the sea shore, contact your local distributor.



JMI-0107

Organization:
DAIKIN INDUSTRIES, LTD.
AIR CONDITIONING MANUFACTURING DIVISION

Scope of Registration:
THE DESIGN/DEVELOPMENT AND MANUFACTURE OF
COMMERCIAL AIR CONDITIONING, HEATING, COOLING,
REFRIGERATING EQUIPMENT, COMMERCIAL HEATING
EQUIPMENT, RESIDENTIAL AIR CONDITIONING
EQUIPMENT, HEAT RECLAIM VENTILATION, AIR
CLEANING EQUIPMENT, MARINE TYPE CONTAINER
REFRIGERATION UNITS, COMPRESSORS AND VALVES.



JQA-1452

Organization:
DAIKIN INDUSTRIES
(THAILAND) LTD.

Scope of Registration:
THE DESIGN/DEVELOPMENT
AND MANUFACTURE OF AIR
CONDITIONERS AND THE
COMPONENTS INCLUDING
COMPRESSORS USED FOR THEM



EC99J2044

All of the Daikin Group's business facilities and subsidiaries in Japan are certified under the ISO 14001 international standard for environment management.

Dealer

DAIKIN INDUSTRIES, LTD.

Head Office:
Umeda Center Bldg., 2-4-12, Nakazaki-Nishi,
Kita-ku, Osaka, 530-8323 Japan

Tokyo Office:
JR Shinagawa East Bldg., 2-18-1, Konan,
Minato-ku, Tokyo, 108-0075 Japan

http://www.daikin.com/global_ac/

©All rights reserved