

AIR COOLED WATER CHILLERS (COOLING ONLY AND HEAT PUMP)



Service Manual



RCUE40AG2-400AG2
Cooling capacity 112 kW - 1030 kW

RHUE40AG2-240AG2
Cooling capacity 106 kW - 585 kW
Heating capacity 110 kW - 556 kW

HITACHI

Inspire the Next

Specifications in this manual are subject to change without notice in order that HITACHI may bring the latest innovations to their customers.

Whilst every effort is made to ensure that all specifications are correct, printing errors are beyond Hitachi's control; Hitachi cannot be held responsible for these errors.

0. Contents

Product range and specifications	1
Test run	2
Electrical wiring diagrams	3
Control system	4
Troubleshooting	5
Maintenance	6

Content

1.	Product range and specifications	11
1.1.	General data for RCUE40~400AG2	12
1.2.	General data for RHUE40~240AG2	16
2.	Test run.....	19
2.1.	Check before test run	20
2.2.	Test run method and check	22
2.3.	Restart of Test Run.....	25
2.4.	Instruction at delivery.....	27
2.5.	Warning & Cautions.....	28
3	Electrical Wiring Diagram.....	31
3.1.	Power Wiring Diagram.....	32
3.2.	Power Wiring Diagram (FAN)	37
3.3.	Control PCB (PCBc).....	38
3.4.	Input / Output PCB (PCBd).....	40
3.5.	Power Wiring Diagram (MCB Option).....	43
3.6.	Diagram abbreviations descriptions	48
4.	Control system	49
4.1.	List of Main Control Function.....	50
4.2.	Water control	52
4.3.	Compressor control	53
4.4.	Current limit control	54
4.5.	Reverse protection control.....	55
4.6.	Restart control after power failure	56
4.7.	Operation error/wrong setting prevention control [40 – 40]	57
4.8.	Forced capacity control	57
4.9.	Second water temperature setting.....	58
4.10.	Heat storage operation by external order.....	64
4.11.	Operation by DC24V input (Remote Control).....	65
4.12.	Installation of switch for snow measure (Fan manual operation)	68
4.13.	Switch for confirmation of high pressure cut.....	69
4.14.	Antifreeze control in winter	69
4.15.	Saving energy priority mode, silence priority mode (night shift), only cooling	70
4.16.	Defrost (only air-cooled heat pump type)	72
4.17.	Thermo off selection function	75

Content (Cont.)

5. Troubleshooting.....	83
5.1. Initial check.....	84
5.2. Troubleshooting.....	108
5.3. Analysis and countermeasure of abnormal running.....	141
5.4. Thermistor characteristics.....	145
6. Maintenance.....	149
6.1. Maintenance criteria.....	150
6.2. Maintenance criteria of Screw Compressor.....	152
6.3. Maintenance of Water Quality.....	153
6.4. Cleaning of water side heat exchanger.....	157
6.5. Check items in daily operation.....	160
6.6. Caution on handling of R407C.....	160
6.7. Manual at compressor overall check and parts check.....	162
6.8. Refrigerant cycle diagrams.....	166
6.9. Overhaul work.....	170
6.10. Vacuuming Procedure.....	170
6.11. Additional refrigerant insertion.....	172

◆ Units Code List

i NOTE:

**MODELS
CODIFICATION**

Please check, according to the model name, which is your air conditioner type and how it is abbreviated and referred to in this service manual.

AIR COOLED WATER CHILLERS -SCREW TYPE							
Model	Indication code	Model	Indication code	Model	Indication code	Model	Indication code
RCUE40AG2	8E041072	RCUE100AG2	8E101072	RCUE180AG2	8E181072	RCUE280AG2	8E281072
RCUE50AG2	8E051072	RCUE120AG2	8E121072	RCUE210AG2	8E211072	RCUE320AG2	8E321072
RCUE60AG2	8E061072	RCUE140AG2	8E141072	RCUE240AG2	8E241072	RCUE350AG2	8E351072
RCUE70AG2	8E071072	RCUE160AG2	8E161072			RCUE400AG2	8E401072
RCUE80AG2	8E081072						





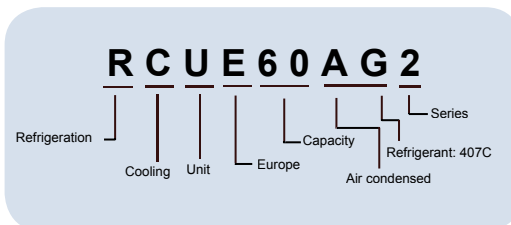





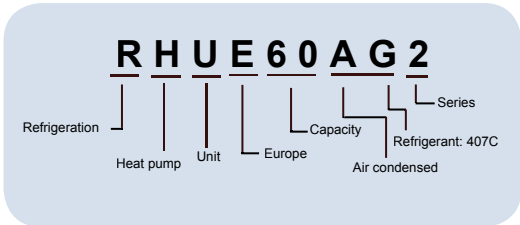

AIR TO WATER HEAT PUMP CHILLERS -SCREW TYPE

Model	Indication code	Model	Indication code	Model	Indication code
RHUE40AG2	9E041072	RHUE100AG2	9E101072	RHUE180AG2	9E181072
RHUE50AG2	9E051072	RHUE120AG2	9E121072	RHUE210AG2	9E211072
RHUE60AG2	9E061072	RHUE140AG2	9E141072	RHUE240AG2	9E241072
RHUE70AG2	9E071072	RHUE160AG2	9E161072		
RHUE80AG2	9E081072				



REMOTE CONTROL DEVICES LIST			
Name	Description	Indication Code	Figure
CSC-5S	Central Station	60291050	
PSC-5T	Seven Day Timer	60291052	

REMOTE CONTROL DEVICES ACCESSORIES LIST			
Name	Description	Indication Code	Figure
PSC-5HR	H-Link Relay	60291105	

CENTRALISED CONTROLS LIST (Interfaces)			
Name	Description	Indication Code	Figure
HARC70-CE1	Lonwork BMX Interface	60559055	
HARC70-CE1 OP		60559056	
CSNET WEB	CSNET WEB	7E891924	

CENTRALISED CONTROLS (Interfaces) ACCESSORIES LIST			
Name	Description	Indication Code	Figure
PM001-CT200	Current Transformer Accessory (Power Meter Option Accessory for CSNET WEB)	7E891930 NEW	
PM001-CT400		7E891931 NEW	
PM001-CT1000	Current Transformer Accessory 1000A (Power Meter Option Accessory for CSNET WEB)	7E891932 NEW	
PM001-GW	Communication Set (Power Meter Option Accessory for CSNET WEB)	7E891933 NEW	
PM001	Power Meter Option (For CSNET WEB)	7E891934 NEW	
TS001	Touch Screen Option (For CSNET WEB)	7E891935 NEW	
TS001-WS	Wall Support for Touch Screen (Touch Screen Option Accessory for CSNET WEB)	7E891936 NEW	
TS001-TS	Table Support for Touch Screen (Touch Screen Option Accessory for CSNET WEB)	7E891937 NEW	

1. Product range and specifications

This chapter provides you with a fast review of the most important general data of the Air cooled water chillers and Air to water heat pump chillers of HITACHI.

1

Content

1. Product range and specifications	11
1.1. General data for RCUE40~400AG2	12
1.2. General data for RHUE40~240AG2	16

1.1. General data for RCUE40~400AG2

MODEL		RCUE40AG2	RCUE50AG2	RCUE60AG2	RCUE70AG2
Cooling Capacity	kW	112	130	156	178
Total Power input	kW	36.4	42.7	52.3	59.8
COP	-	3.08	3.04	2.98	2.98
Outer Dimension	Height	mm	2.430	2.430	2.430
	Width	mm	1.900	1.900	1.900
	Depth	mm	2.150	2.150	2.750
Cabinet colour	-	Natural Grey			
Net weight	Kg	1.430	1.470	1.560	1.760
Compressor type	-	Semi-hermetic screw type			
Models	-	40ASC-Z	40ASC-Z	50ASC-Z	60ASC-Z
Quantity	-	1	1	1	1
Oil heater	W	150	150	150	150
Capacity control	-	Continuous Capacity Control			
	%	15~100			
Water cooler type	-	Brazing Plate Type			
Condenser type	-	Multi-Pass cross finned tube			
Fan Motor (pole)	kW	0.38 (8)			
Quantity	-	4	4	4	6
Refrigerant type	-	R407C (Factory charged)			
Flow control	-	Electronic expansion valve			
Number of independent circuits	-	1	1	1	1
Quantity of refrigerant (kg)	-	39	46	41	48
Oil type	-	JAPAN ENERGY FREOL UX300 (Ester)			
Water pipe connection	Inch	3" Victaulic (1xInlet/1xOutlet)			
Control system	-	Micro-processor control			
Chilled water outlet temperature	°C	-10 (Option) 5~15			
Condenser air inlet temperature	°C	-15~46			
Permissible water pressure max.	MPa	1.0			
Safety and protection devices	-	Reverse Phase Protection, Fuse and Thermal Relay for Compressor, Internal Thermostat for Compressor, Compressor Oil Heater, Fuse and Internal Thermostat for Fan Motor, Control Circuit Fuse, High Pressure Switch, Low Pressure Control, High Pressure Relief Valve, Discharge Gas Temperature Control, Suction Gas Temperature Control, Freeze Protection Control and Compressor Operation Hour Meter			
Power supply	-	3~, N/380-415V/50Hz			

NOTE:

The nominal cooling capacities are based on the European Standard EN12055.

- Chilled Water Inlet / Outlet Temperature : 12/7 °C
- Condenser Inlet Air Temperature : 35 °C

MODEL		RCUE80AG2	RCUE100AG2	RCUE120AG2	RCUE140AG2
Cooling Capacity	kW	206	260	312	356
Total Power input	kW	69.6	85.4	104.5	119.6
COP	-	2.96	3.04	2.99	2.98
Outer Dimension	Height	mm	2.430	2.430	2.430
	Width	mm	1.900	1.900	1.900
	Depth	mm	2.750	4.050	4.050
Cabinet colour	-	Natural Grey			
Net weight	Kg	1.820	2.830	3.000	3.420
Compressor type	-	Semi-Hermetic screw type			
Models	-	60ASC-Z	40ASC-Z	50ASC-Z	60ASC-Z
Quantity	-	1	2	2	2
Oil heater	W	150	150x2	150x2	150x2
Capacity control	-	Continuous Capacity Control			
	%	15~100			
Water cooler type	-	Brazing Plate Type			
Condenser type	-	Multi-Pass cross finned tube			
Fan Motor (pole)	kW	0.38 (8)			
Quantity	-	6	8	8	12
Refrigerant type	-	R407C (Factory charged)			
Flow control	-	Electronic expansion valve			
Number of independent circuits	-	1	2	2	2
Quantity of refrigerant	-	64	92	82	96
Oil type	-	JAPAN ENERGY FREOL UX300 (Ester)			
Water pipe connection	Inch	3" Victaulic (1xInlet/ 1xOutlet)	3" Victaulic (2xInlet/2xOutlet)		
Control system	-	Micro-processor control			
Chilled water outlet temperature	°C	-10 (Option) 5~15			
Condenser air inlet temperature	°C	-15~46			
Permissible water pressure max.	MPa	1.0			
Safety and protection devices	-	Reverse Phase Protection, Fuse and Thermal Relay for Compressor, Internal Thermostat for Compressor, Compressor Oil Heater, Fuse and Internal Thermostat for Fan Motor, Control Circuit Fuse, High Pressure Switch, Low Pressure Control, High Pressure Relief Valve, Discharge Gas Temperature Control, Suction Gas Temperature Control, Freeze Protection Control and Compressor Operation Hour Meter			
Power supply	-	3~, N/380-415V/50Hz			



NOTE:

The nominal cooling capacities are based on the European Standard EN12055.

- Chilled Water Inlet / Outlet Temperature : 12/7 °C
- Condenser Inlet Air Temperature : 35 °C

MODEL		RCUE160AG2	RCUE180AG2	RCUE210AG2	RCUE240AG2
Cooling Capacity	kW	412	468	534	618
Total Power input	kW	139.1	156.8	179.4	208.7
COP	-	2.96	2.98	2.98	2.96
Outer Dimension	Height	mm	2.430	2.430	2.430
	Width	mm	1.900	1.900	1.900
	Depth	mm	5.250	5.950	7.750
Cabinet colour	-	Natural Grey			
Net weight	Kg	3.550	4.450	5.070	5.250
Compressor type	-	Semi-Hermetic screw type			
Models	-	60ASC-Z	50ASC-Z	60ASC-Z	60ASC-Z
Quantity	-	2	3	3	3
Oil heater	W	150x2	150x3	150x3	150x3
Capacity control	-	Continuous Capacity Control			
	%	15~100			
Water cooler type	-	Brazeing Plate Type			
Condenser type	-	Multi-Pass cross finned tube			
Fan Motor (pole)	kW	0.38 (8)			
Quantity	-	12	12	18	18
Refrigerant type	-	R407C (Factory charged)			
Flow control	-	Electronic expansion valve			
Number of independent circuits	-	2	3	3	3
Quantity of refrigerant	-	128	123	144	192
Oil type	-	JAPAN ENERGY FREOL UX300 (Ester)			
Water pipe connection	Inch	3" Victaulic (2xInlet/ 2xOutlet)	3" Victaulic (3xInlet/3xOutlet)		
Control system	-	Micro-processor control			
Chilled water outlet temperature	°C	-10 (Option) 5~15			
Condenser air inlet temperature	°C	-15~46			
Permissible water pressure max.	MPa	1.0			
Safety and protection devices	-	Reverse Phase Protection, Fuse and Thermal Relay for Compressor, Internal Thermostat for Compressor, Compressor Oil Heater, Fuse and Internal Thermostat for Fan Motor, Control Circuit Fuse, High Pressure Switch, Low Pressure Control, High Pressure Relief Valve, Discharge Gas Temperature Control, Suction Gas Temperature Control, Freeze Protection Control and Compressor Operation Hour Meter			
Power supply	-	3~, N/380-415V/50Hz			

**NOTE:**

The nominal cooling capacities are based on the European Standard EN12055.

- Chilled Water Inlet / Outlet Temperature : 12/7 °C
- Condenser Inlet Air Temperature : 35 °C

MODEL		RCUE280AG2	RCUE320AG2	RCUE350AG2	RCUE400AG2	
Cooling Capacity	kW	712	824	890	1030	
Total Power input	kW	239.2	278.2	299.0	347.8	
COP	-	3.0	3.0	3.0	3.0	
Outer Dimension	Height	mm	2.430	2.430	2.430	2.430
	Width	mm	1.900	1.900	1.900	1.900
	Depth	mm	10.250	10.250	12.750	12.750
Cabinet colour	-	Natural Grey				
Net weight	Kg	6.750	7.000	8.450	8.750	
Compressor type	-	Semi-Hermetic screw type				
Models	-	60ASC-Z	50ASC-Z	60ASC-Z	60ASC-Z	
Quantity	-	4	4	5	5	
Oil heater	W	150x4	150x4	150x5	150x5	
Capacity control	-	Continuous Capacity Control				
	%	15~100				
Water cooler type	-	Brazeing Plate Type				
Condenser type	-	Multi-Pass cross finned tube				
Fan Motor (pole)	kW	0.38 (8)				
Quantity	-	24	24	30	30	
Refrigerant type	-	R407C (Factory charged)				
Flow control	-	Electronic expansion valve				
Number of independent circuits	-	4	4	5	5	
Quantity of refrigerant	-	192	256	240	320	
Oil type	-	JAPAN ENERGY FREOL UX300 (Ester)				
Water pipe connection	Inch	3" Victaulic (4xInlet/4xOutlet)		3" Victaulic (5xInlet/5xOutlet)		
Control system	-	Micro-processor control				
Chilled water outlet temperature	°C	-10 (Option) 5~15				
Condenser air inlet temperature	°C	-15~46				
Permissible water pressure max.	MPa	1.0				
Safety and protection devices	-	Reverse Phase Protection, Fuse and Thermal Relay for Compressor, Internal Thermostat for Compressor, Compressor Oil Heater, Fuse and Internal Thermostat for Fan Motor, Control Circuit Fuse, High Pressure Switch, Low Pressure Control, High Pressure Relief Valve, Discharge Gas Temperature Control, Suction Gas Temperature Control, Freeze Protection Control and Compressor Operation Hour Meter				
Power supply	-	3~, N/380-415V/50Hz				

NOTE:

The nominal cooling capacities are based on the European Standard EN12055.

- Chilled Water Inlet / Outlet Temperature : 12/7 °C
- Condenser Inlet Air Temperature : 35 °C

1.2. General data for RHUE40~240AG2

MODEL		RHUE40AG2	RHUE50AG2	RHUE60AG2	RHUE70AG2
Cooling Capacity	kW	106	123	148	169
Heating Capacity	kW	110	127	152	185
Total Power input in cooling	kW	36.4	42.7	52.3	59.8
Total Power input in heating	kW	40.7	44.5	54.3	67.7
Outer Dimension	Height	mm	2.430	2.430	2.430
	Width	mm	1.900	1.900	1.900
	Depth	mm	1.900	1.900	2.500
Cabinet colour	-	Natural Grey			
Net weight	Kg	1.550	1.600	1.670	1.880
Compressor type	-	Semi-Hermetic screw type			
Models	-	40ASC-Z	40ASC-Z	50ASC-Z	60ASC-Z
Quantity	-	1	1	1	1
Oil heater	W	150			
Capacity control	-	Continuous Capacity Control			
	%	15~100			
Water side heat exchanger	-	Brazing plate type			
Air side heat exchanger	-	Multi-Pass cross finned tube			
Fan Motor (pole)	kW	0.38 (8)			
Quantity	-	4	4	4	6
Refrigerant type	-	R407C (Factory charged)			
Flow control	-	Electronic expansion valve			
Number of independent circuits	-	1	1	1	1
Quantity of refrigerant	-	39	46	41	48
Oil type	-	JAPAN ENERGY FREOL UX300 (Ester)			
Water pipe connection	Inch	3" Victaulic (1xInlet/1xOutlet)			
Control system	-	Micro-processor control			
Chilled water outlet temperature	°C	-10 (Option) 5~15			
Heated water outlet temperature	°C	35~55			
Condenser air inlet temperature	°C	-15~46 for cooling operation			
Evaporator air inlet temperature	°C	DB: -9.5~21/ WB:-10~15.5 for heating operation			
Permissible water pressure max.	MPa	1.0			
Safety and protection devices	-	Reverse Phase Protection, Fuse and Thermal Relay for Compressor, Internal Thermostat for Compressor, Compressor Oil Heater, Fuse and Internal Thermostat for Fan Motor, Control Circuit Fuse, High Pressure Switch, Low Pressure Control, High Pressure Relief Valve, Discharge Gas Temperature Control, Suction Gas Temperature Control, Freeze Protection Control and Compressor Operation Hour Meter			
Power supply	-	3~, N/380-415V/50Hz			



NOTES:

(1) The nominal cooling capacities are based on the European Standard EN12055.

- Chilled Water Inlet / Outlet Temperature : 12/7 °C
- Condenser Inlet Air Temperature : 35 °C

(2) The nominal heating capacities are based on the European Standard EN12055.

- Heated Water Inlet / Outlet Temperature : 40/45 °C
- Evaporator Inlet Air Temperature : 6 °C (WB)

MODEL		RHUE80AG2	RHUE100AG2	RHUE120AG2	RHUE140AG2
Cooling Capacity	kW	195	246	296	338
Heating Capacity	kW	185	254	305	371
Total Power input in cooling	kW	69.6	85.4	104.5	119.6
Total Power input in heating	kW	67.7	89.0	108.6	135.5
Outer Dimension	Height	mm	2.430	2.430	2.430
	Width	mm	1.900	1.900	1.900
	Depth	mm	2.500	3.800	3.800
Cabinet colour	-	Natural Grey			
Net weight	Kg	1.950	3.050	3.250	3.670
Compressor type	-	Semi-Hermetic screw type			
Models	-	60ASC-Z	40ASC-Z	50ASC-Z	60ASC-Z
Quantity	-	1	2	2	2
Oil heater	W	150	150x2		
Capacity control	-	Continuous Capacity Control			
	%	15~100			
Water side heat exchanger	-	Brazing plate type			
Air side heat exchanger	-	Multi-Pass cross finned tube			
Fan Motor (pole)	kW	0.38 (8)			
Quantity	-	6	8	8	12
Refrigerant type	-	R407C (Factory charged)			
Flow control	-	Electronic expansion valve			
Number of independent circuits	-	1	2	2	2
Quantity of refrigerant	-	64	92	82	96
Oil type	-	JAPAN ENERGY FREOL UX300 (Ester)			
Water pipe connection	Inch	3" Victaulic (1xInlet/ 1xOutlet)	3" Victaulic (2xInlet/2xOutlet)		
Control system	-	Micro-processor control			
Chilled water outlet temperature	°C	-10 (Option) 5~15			
Heated water outlet temperature	°C	35~55			
Condenser air inlet temperature	°C	-15~46 for cooling operation			
Evaporator air inlet temperature	°C	DB: -9.5~21/ WB:-10~15.5 for heating operation			
Permissible water pressure max.	MPa	1.0			
Safety and protection devices	-	Reverse Phase Protection, Fuse and Thermal Relay for Compressor, Internal Thermostat for Compressor, Compressor Oil Heater, Fuse and Internal Thermostat for Fan Motor, Control Circuit Fuse, High Pressure Switch, Low Pressure Control, High Pressure Relief Valve, Discharge Gas Temperature Control, Suction Gas Temperature Control, Freeze Protection Control and Compressor Operation Hour Meter			
Power supply	-	3~, N/380-415V/50Hz			

NOTES:

(1) The nominal cooling capacities are based on the European Standard EN12055.

- Chilled Water Inlet / Outlet Temperature : 12/7 °C
- Condenser Inlet Air Temperature : 35 °C

(2) The nominal heating capacities are based on the European Standard EN12055.

- Heated Water Inlet / Outlet Temperature : 40/45 °C
- Evaporator Inlet Air Temperature : 6 °C (WB)

MODEL		RHUE160AG2	RHUE180AG2	RHUE210AG2	RHUE240AG2
Cooling Capacity	kW	390	444	507	585
Heating Capacity	kW	371	457	556	556
Total Power input in cooling	kW	139.1	156.8	179.4	208.7
Total Power input in heating	kW	135.5	162.9	203.2	203.2
Outer Dimension	Height	mm	2.430	2.430	2.430
	Width	mm	1.900	1.900	1.900
	Depth	mm	5.000	5.700	7.500
Cabinet colour	-	Natural Grey			
Net weight	Kg	3.780	4.780	5.440	5.650
Compressor type	-	Semi-Hermetic screw type			
Models	-	60ASC-Z	50ASC-Z	60ASC-Z	60ASC-Z
Quantity	-	2	3	3	3
Oil heater	W	150x2	150x3		
Capacity control	-	Continuous Capacity Control			
	%	15~100			
Water side heat exchanger	-	Brazing plate type			
Air side heat exchanger	-	Multi-Pass cross finned tube			
Fan Motor (pole)	kW	0.38 (8)			
Quantity	-	12	12	18	18
Refrigerant type	-	R407C (Factory charged)			
Flow control	-	Electronic expansion valve			
Number of independent circuits	-	2	3	3	3
Quantity of refrigerant	-	128	123	144	192
Oil type	-	JAPAN ENERGY FREOL UX300 (Ester)			
Water pipe connection	Inch	3" Victaulic (2xInlet/ 2xOutlet)	3" Victaulic (3xInlet/3xOutlet)		
Control system	-	Micro-processor control			
Chilled water outlet temperature	°C	-10 (Option) 5~15			
Heated water outlet temperature	°C	35~55			
Condenser air inlet temperature	°C	-15~46 for cooling operation			
Evaporator air inlet temperature	°C	DB: -9.5~21/ WB:-10~15.5 for heating operation			
Permissible water pressure max.	MPa	1.0			
Safety and protection devices	-	Reverse Phase Protection, Fuse and Thermal Relay for Compressor, Internal Thermostat for Compressor, Compressor Oil Heater, Fuse and Internal Thermostat for Fan Motor, Control Circuit Fuse, High Pressure Switch, Low Pressure Control, High Pressure Relief Valve, Discharge Gas Temperature Control, Suction Gas Temperature Control, Freeze Protection Control and Compressor Operation Hour Meter			
Power supply	-	3~, N/380-415V/50Hz			

NOTES:

- (1) The nominal cooling capacities are based on the European Standard EN12055.
- Chilled Water Inlet / Outlet Temperature : 12/7 °C
 - Condenser Inlet Air Temperature : 35 °C
- (2) The nominal heating capacities are based on the European Standard EN12055.
- Heated Water Inlet / Outlet Temperature : 40/45 °C
 - Evaporator Inlet Air Temperature : 6 °C (WB)

2. Test run

This chapter describes the procedure of test run of the Air cooled water chillers and the Air to water heat pump chillers.

Content

2. Test run.....	19
2.1. Check before test run	20
2.1.1. Cabinet.....	20
2.1.2. Refrigerant System	20
2.1.3. Electrical System.....	21
2.1.4. Water System.....	22
2.2. Test run method and check	22
2.2.1. Check before Test Run.....	22
2.2.2. Cooling operation (low pressure, high pressure)	23
2.2.3. Heating operation (low pressure, high pressure)	23
2.2.4. Electrical consumption percentage	24
2.3. Restart of Test Run.....	25
2.3.1. Check of high pressure switch (cooling operation)	26
2.3.2. Check of low pressure cut control	26
2.3.3. Temperature controller	26
2.3.4. Check of refrigerant leakage	26
2.4. Instruction at delivery.....	27
2.5.Warning & Cautions.....	28
2.5.1. During product and electrical installation	28
2.5.2. During operation.....	28
2.5.3. During repair and relocation.....	29
2.5.4. Other cautions.....	29

2.1. Check before test run

Confirm there is no problem regarding chiller installation space and requirements. See technical catalogue for more details.

Check the following items at the beginning of the season and before first test run.

2.1.1. Cabinet

◆ Exterior and interior	<ul style="list-style-type: none"> - Confirm there is no damage in exterior and interior caused during transportation or at installation. - Remove foreign matters and dust and clean it. - Confirm individually if screw and washer are fixed well using screw driver or wrench. - Confirm visually if heat insulation, tape and label plates are fixed well.
◆ Drain pan	<ul style="list-style-type: none"> - Confirm visually if there is no clogging nor rust in drain. In case of the rust, arrange it painting.
◆ Air side heat exchanger	<ul style="list-style-type: none"> - Check visually if there is no dust between fins. In case of dust, wash the part with fin cleaner.
◆ Fan part	<ul style="list-style-type: none"> - Confirm there is no deformation nor any trouble in fan or fan protection net. - Confirm if fan spins smoothly. - Confirm if screws are not loosed. (especially check if shaft and runner are fixed) - Confirm if there is no strange noise during the revolution.



CAUTION:

Do not use domestic detergent as a forming agent at refrigerant leakage check. The followings are recommended:

- Snove (Nupro, USA),
- Gupflex (Yokogawa, Japan)

Gas leakage detection device is not compatible with one for R22. The sensibility of the device for R22 is little, therefore, do not divert it.

2.1.2. Refrigerant System

◆ System in general	<ul style="list-style-type: none"> - Confirm individually if screws are fixed well using screwdriver or wrench. - Confirm if there is no gas leakage using foaming agent or leak tester especially in flanges, screws, and flare parts.
◆ Compressor	<ul style="list-style-type: none"> - Confirm visually if there is no oil leakage from suction and discharge flange.
◆ Fuse plug	<ul style="list-style-type: none"> - Confirm visually if fuse plug is not inflated abnormally.
◆ Stop valve for liquid refrigerant	<ul style="list-style-type: none"> - Confirm if the stop valve for refrigerant in outlet of air side heat exchanger is fully opened.

2.1.3. Electrical System

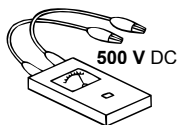

Fig.1

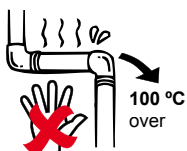

Fig.2

◆ Fuse	<ul style="list-style-type: none"> - Confirm visually if fuse is suitable. See technical catalogue for detail regulation of fuse.
◆ Electrical device	<ul style="list-style-type: none"> - Confirm individually if screws in installation part and wire connection part are not loosed using driver. Check it carefully since devices might be damaged if screws in wire connection part are not tightened well. - Confirm if the insulation resistance is more than 1MΩ in 500V DC. In case of below 1MΩ, do not operate the unit since insulation of electrical device has failure.
◆ Compressor	<ul style="list-style-type: none"> - Check if insulation works well. Do not operate the unit in case of below 3MΩ in 500V DC (fig.1)
◆ Fan motor	<ul style="list-style-type: none"> - Check if insulation works well. Do not operate the unit in case of below 3MΩ in 500V DC. (fig.1)
◆ Wire in the unit	<ul style="list-style-type: none"> - Confirm touching directly with hands if the wiring is not removed or loosed. - Confirm the covered insulation part. Pay attention not to touch it by wet hand or to touch directly the edge of metal plate or high temperature part of electrical devices. (fig.2)
◆ Local wiring	<ul style="list-style-type: none"> - Confirm if earth wire is installed correctly and not broken. - Confirm if R, S, and T phase are connected correctly. - Confirm the local wiring size. If the volume is not sufficient, it may cause extreme heating or fire.
◆ Electrical expansion valve	<ul style="list-style-type: none"> - Confirm if convex part of electrical expansion valve coil is well fixed to concave part of electrical expansion valve body.

2.1.4. Water System

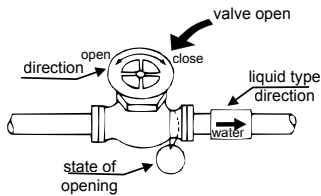

Fig.3

<p>◆ Quality control</p>	<p>– Confirm if the water quality follows the guideline detailed in the technical catalogue.</p>
<p>◆ Diameter of water pipe</p>	<p>– Strange noise or abnormal vibration can occur if water pump is not installed well or water pipe is too long. Confirm the piping in the following sample method (fig.3)</p> <ul style="list-style-type: none"> – Open the inlet/outlet valve of water and pass the water inside the water heat exchanger and pipes. – While operating the water pump, remove the air inside the water pipe from the plug or automatic air-removing valve. – Continue operating the pump and confirm if there is no water leakage, strange noise nor abnormal vibration. <p>– Remove the air from the pump and pass the water inside all the system.</p> <p>– Check if water is not leaked in all the system.</p> <p>– Confirm if the valve is open.</p> <p>– Confirm if strainer (correspondent to 20 mesh) prepared in local is installed in water inlet pipe near the unit. When checking at the beginning of the season, check also if there is any dust or foreign materials in strainer.</p>
<p>◆ Water temperature</p>	<p>– In case of short periods, there is no problem if water temperature goes outside of service limits. However, chiller unit may be damaged working for more than 30 minutes out of standard specifications. Service limit of water temperature is as follows.</p> <ul style="list-style-type: none"> – Chilled water temperature (outlet): -10(option)~5~15°C – Warm water temperature (outlet): 35~55°C

2.2. Test run method and check

2.2.1. Check before Test Run

1. Need to apply electricity to oil heater. **Power ON 12 hours before the first start up.**
2. Screw compressor start-up. Confirm if there is no strange noise or abnormal vibration in 1~2 minutes after compressor operation.
3. Confirmation of standard operating pressures. Stop the operation once and re-start the unit after more than 3 minutes. Confirm if pressure is correct after 15 minutes of compressor operation referring for "Fig.6 Standard operation pressure" and "Fig.6 Water side heat exchanger washing area".
4. Positive revolution of fan. Confirm if fan is spinning in counter clockwise rotation observing the fan from the above.
5. Check of gas leakage. Confirm if gas is not leaked after stopping the operation.

Cooling operation:

Fig.4

2.2.2. Cooling operation (low pressure, high pressure)

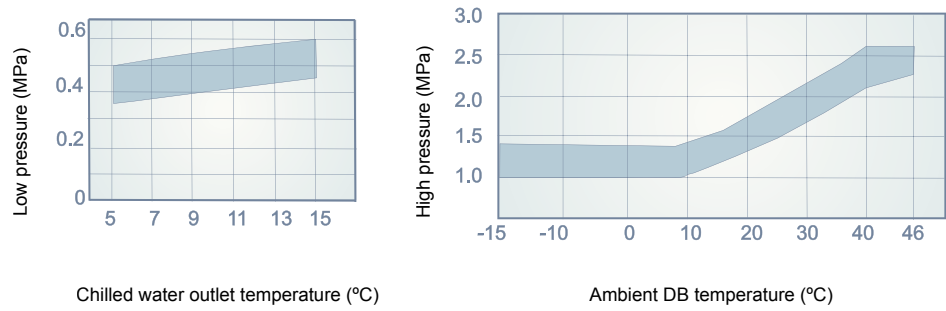

Heating operation:

Fig.5

2.2.3. Heating operation (low pressure, high pressure)

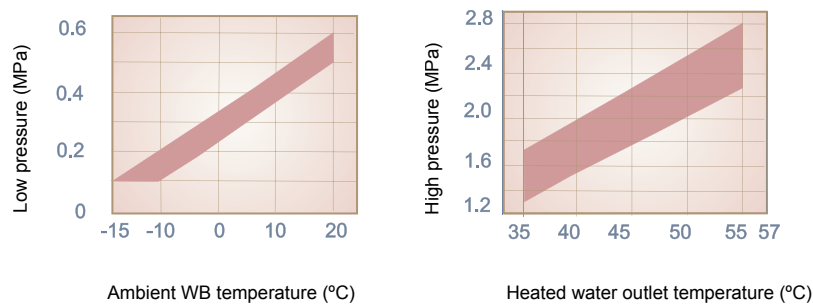

Low pressure and high pressure, corresponding to outlet temperature and ambient DB temperature, are within the below area (at 100% operation) normally.

Fig. Standard operation pressure (at 100% operation)

Fig.6

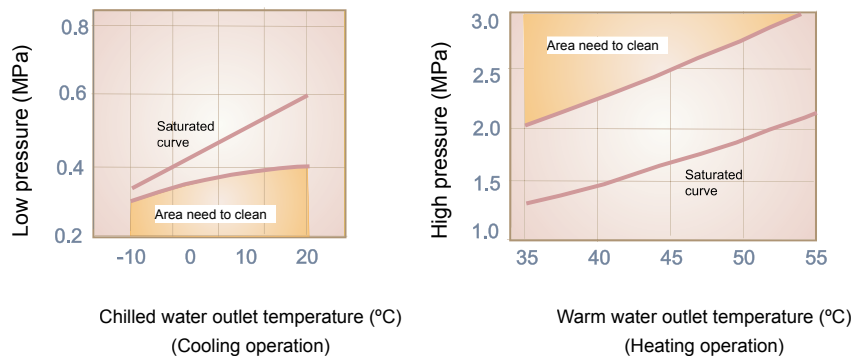

CAUTION:

For installation and test run under low ambient temperature, like at the beginning of summer, it is possible to decrease low pressure abnormally.

In such case, heating operation should be run firstly and then cooling operation. (In case of air-cooled heat pump)

NOTE:

Fig.6 area need to be cleaned water side heat exchanger

2.2.4. Electrical consumption percentage

Electrical consumption percentage is 100% in the following standard conditions at cooling and heating operation:

👉 Cooling operation:

Air side heat exchanger inlet ambient DB 35°C,
Chilled water inlet temperature 12°C,
Chilled water outlet temperature 7°C.

👉 Fig.7

50 Hz electrical consumption percentage (cooling)

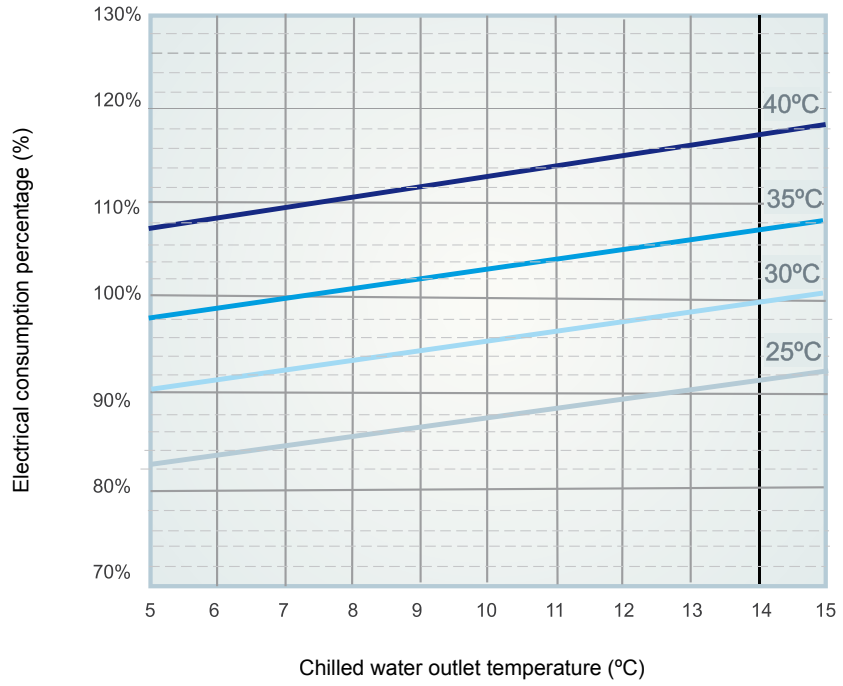

👉 Heating operation:

Air side heat exchanger inlet ambient DB 7°C, WB temperature 6°C,
Warm water inlet temperature 40°C,
Warm water outlet temperature 45°C

👉 Fig.8

50 Hz electrical consumption percentage (heating)

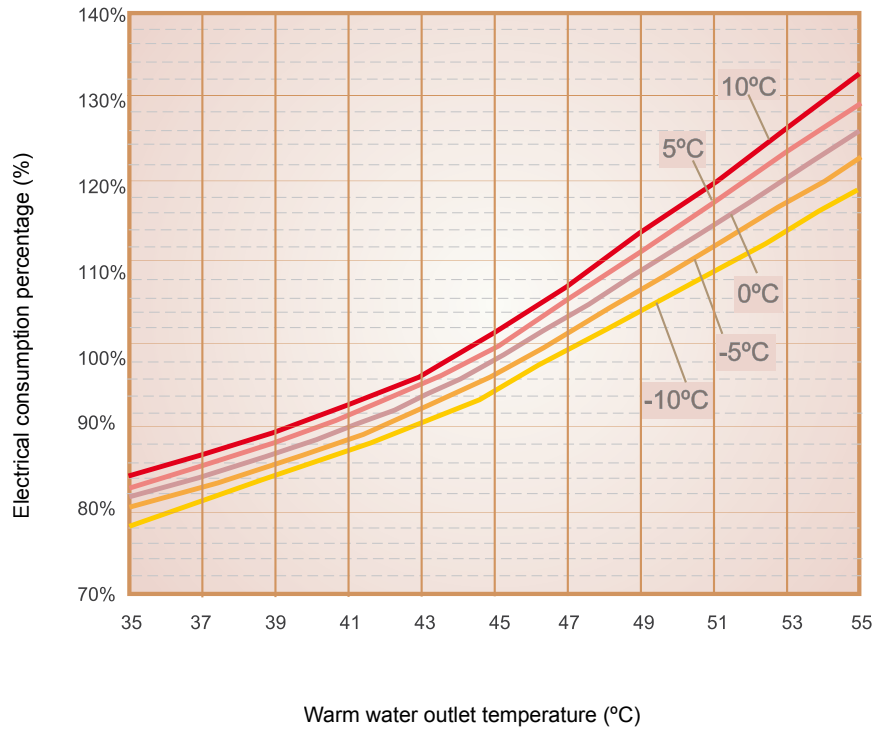

2.3. Restart of Test Run

After a series of items are confirmed from the beginning to the end of test run, restart the unit and check also the following items.

Items	Check point	Criteria and method	Remarks
Operation: operation register	Voltage	<ul style="list-style-type: none"> - Momentary voltage at compressor start-up is over rated voltage $\pm 15\%$ - Operation voltage is within rated voltage: $\pm 10\%$ - Unbalance between voltage: within 2%, in any case, within 3%. 	Unbalance of voltage makes current value change significantly.
	High pressure Low pressure	<ul style="list-style-type: none"> - See the diagrams in sub-chapter 2.2.2 and 2.2.3. 	
	Ambient temperature DB, WB Chilled water inlet temperature Chilled water outlet temperature	<ul style="list-style-type: none"> - See figures 4 and 5. 	
	Activation temperature of chilled water temperature controller Activation temperature of warm water temperature controller (air-cooled type)	<ul style="list-style-type: none"> - Confirm the activation temperature changing the setting temperature 	
	Frequency of compressor start-up and stop	<ul style="list-style-type: none"> - Below 6 times in a hour and non stop operation time is over 5 minutes. 	
Refrigerant system: cycle in general compressor	Is there no abnormal vibration and contact in pipe or capillary?	<ul style="list-style-type: none"> - Confirm 	
	Frost in compressor	<ul style="list-style-type: none"> - Confirm if there is too much frost. 	Caution in mid-term
Electrical system: electrical device	Is electrical device (relay etc) activated normally? Is activation time of timer normal?	<ul style="list-style-type: none"> - Confirm if there is no strange activation like noise, spark or chattering. 	
Water system: Pump	Is there no trouble in discharge water pressure nor in operation noise?		If it needs to adjust it with water volume, adjust it in the discharge side of pump.
	Is there any clogging in strainer?	<ul style="list-style-type: none"> - Re-check if there is no dust nor foreign matters in strainer. 	

2.3.1. Check of high pressure switch (cooling operation)

Cooling operation:

1. Operate the unit in local operation mode.
2. When “High pressure cut confirmation test” switch on PCB is pressed during local operation, fan is stopped forcedly and high pressure is increased. Then, high pressure switch turns ON. (Alarm stop) This confirmation switch is set in every cycle (see fig.9) (to restart the compressor, high pressure switch must be rearmed manually next to each compressor)

NOTE:

See “High pressure confirmation” in chapter 4 “Control functions” for the details.

Fig.9

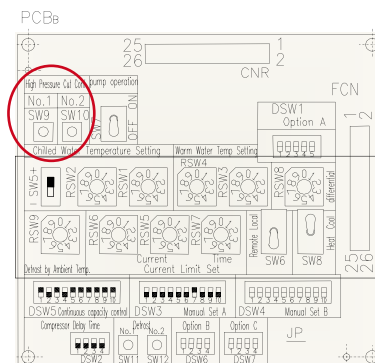

CAUTION:

It is recommended that this confirmation test be performed at load-up state, operation for a few minutes after start-up.

3. After confirmation, alarm should be released by unit stop operation. When alarm is released, high pressure cut confirmation test is also released.

2.3.2. Check of low pressure cut control

Low pressure is decreased by closing the stop valve. Then, low pressure cut device is activated (Alarm stop).

<Activation conditions for low pressure cut control>

Activated in 3 seconds at low pressure sensor detection pressure of below 0.049MPa

2.3.3. Temperature controller

It is difficult to check the temperature controller accurately in an installation place, however, the following method helps to grasp the setting state roughly.

1. Temperature controller is set in high temperature side for chilled water, and in low temperature side for warm water.
2. Measure the set temperature at compressor stop, and compare it with actual inlet water temperature.

2.3.4. Check of refrigerant leakage

It is possible for screws to be loosened at delivery. Take 10~15 seconds at least in one position to check the leakage.

2.4. Instruction at delivery

When delivering the unit after test run, give an appropriate explanation to customers about operation method and periodical maintenance method etc as well as the following items.

1. Apply the electricity to oil heater

Do not turn off the power source of unit during normal use in order that electricity is applied to oil heater. In case of re-starting the unit after a long time, turn on the power 12 hours before operation start. Oil heater avoids the damage of shaft and rotor, preventing the foaming of lubrication oil in compressor at start-up. (Heats oil to approx. 40°C)

2. If chiller unit is not used for a long time, drain the water out of pipes using water-drawing or air-drawing plug.

3. Anti-freeze in winter

- To avoid freezing, which might damage devices or pipes, it is needed to be installed some insulation in pump and water pipes.
- This chiller has a function to operate chilled (warm) water circulation pump automatically in case of decreasing outside temperature during unit stop, therefore, do not turn off the power source during season. In case of turning off, draw the water out of chiller unit.

4. In case of fire,

Turn all power OFF

5. The unit will not display failure in spite of the following cases.

- During operation and after unit stop, if there is water flowing noise. However, this is a refrigerant flowing noise, and it is not a failure.
 - Compressor is not operated (fuses are out) although operation switch is ON while temperature controller is being activated. This is not a failure, but operation is started when temperature control (Thermostat) turns ON.
 - In screw type chiller unit, there is a noise in the compressor rotors when it is stopped. Refrigerant is flowed back temporally, and this is not a failure.
6. The refrigerant used in this unit is incombustible, non-toxic and odourless safe. However, toxic gas is produced when leaked refrigerant is exposed to fire and oxygen will be lacked due to that refrigerants gravity is higher than air. Therefore, in case that refrigerant is leaked or eye or throat are irritated, stop the use of fire, and ventilate well, then contact a distributor.

7. About operation method

Standard method of use is described in the operation manual attached with the product. Operation method would be changed if special modification were realized by request of the customers. Give a clear explanation to the customers that it is necessary to contact a distributor or Customer Service Centre of manufactures in case that operation, not described in the manual, must be performed.

8. For customers' continued safety

For customers' safety, give plain and sufficient explanation and instruction to them about the contents of "Please observe safety precautions fully" described in Installation Manual and "For safety use" described the Operation Manual, and tell them to read them very carefully.

Cautions are divided into "Alarm" and "Caution":

"Alarm" includes cases where it is possible to lead to a dangerous result like death or severe injury.

Cases described in "Caution" may also lead a grave result depending on the situations. Therefore, please read them carefully and follow the instruction.

Operation Manual should be kept where any user can reach.

2.5.Warning & Cautions



WARNING

2.5.1. During product and electrical installation

- Installation must be performed by distributors or specialists. Inadequate installation may cause water leakage, electrical shock or fire.
- Electrical work must be performed by person with qualification. Inadequate electrical work may cause electrical shock.
- Confirm if earth wire is connected. Earth wire is determined according to the technical criteria of electrical installation.
- Do not use wire or copper wire in stead of a fuse inside the unit or in the switch for power source. It may cause heat or fire in case of abnormal current.
- Confirm if fuse is correct and adequate. In case of setting inadequate fuse, like high volume fuse, fuse would not melt in spite of abnormal current, and cause fire. See installation check manual attached with the unit for correct fuse volume.
- Confirm the open/close state of valves according to label or operation manual. Especially, confirm if inlet valve is open in those products that have inlet valve of condenser. Operation with the valve close may cause explosion due to the abnormal increase of high pressure.
- Use only specified refrigerant. Nitrogen gas should be used in air tight test. The use of combustible gas like oxygen and acetylene may cause fire or explosion.



WARNING

Fig.10



Fig.11



Fig.12

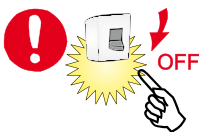

Fig.13



Fig.14



2.5.2. During operation

- Do not touch the switch with wet hand. It may cause electrical shock (fig.10).
- Do not use any sprays such as insecticide, lacquer, hair spray or other flammable gases near the unit. It may cause fire. (fig.11)
- Do not operate with cover of electrical box open. To touch the electrical part may cause electrical shock.
- Turn OFF all power source immediately in case that unit is not stopped in spite of the stop operation or that refrigerant is leaked or chilled water is discharged. It may cause electrical shock, fire and explosion. Contact a distributor of Customer Service Centre of manufacturer in such case. (fig.12)
- Do not press repeatedly the operation switch. It avoids a normal activation of protection device and may result in failure, electrical shock and fire.
- Turn OFF main power in case of safety devise is activated frequently or operation switch is not activated steadily. There is a possibility of ground leakage or overcurrent and may result in electrical shock or fire. Contact a distributor of Customer Service Centre of manufacturer in such case. (fig.12)
- Safe refrigerant (Fluorocarbon), incombustible, non-toxic and odourless, is used. In case that Fluorocarbon is leaked and touched with fire, it would be a cause of toxic gas production and of lack of oxygen. Contact a distributor of Customer Service Centre of manufacturer in such case. (fig.13)
- Do not put fingers or sticks etc into the air inlet and outlet. These units have high speed rotating fans and it is dangerous that any object touches them.
- Do not remove the protection net air inlet and outlet. These units have high speed rotating fans and it is dangerous that any object touches them.
- Do not touch hot temperature parts. It may cause burn. (fig.14)

WARNING
 Fig.12

2.5.3. During repair and relocation

- Turn OFF all powers when checking electrical parts, otherwise, it may result in electrical shock.
- Do not touch protection device. It may result in failure, electrical shock, fire and explosion if these devices are touched, the setting value can be changed or short-circuited.
- In case of troubles (smell something burning etc), stop the operation and turn OFF main power immediately. Operation with abnormal state may cause failure, electrical shock and fire. Contact a distributor of Customer Service Centre of manufacturer in such case (fig.12)
- Consult to a distributor of Customer Service Centre of manufacturer in case of repair and relocation. Inadequate installation may cause electrical shock

2.5.4. Other cautions

CAUTION:

- Do not pour water inside the unit.
- Do not modify the units. Modification or the use of unspecified parts may cause failure, electrical shock and fire.
- Maintain the units on firm ground.
- In case of fire turn OFF the main power. Use oil or distinguish for electrical fire in fire control.
- Do not touch hot temperature parts. It may cause burn.
- Consult with a distributor or qualified service person in case of disposal of unit since refrigerant should be pull out correctly. The law prohibits indecent discharge of refrigerant in air.

3. Electrical Wiring Diagrams

3

This chapter shows the electrical wiring diagrams for Chiller AG2 of Hitachi.

Content

3	Electrical Wiring Diagram	31
3.1.	Power Wiring Diagram.....	32
3.1.1.	Model: R(C/H)UE 40~80AG2.....	32
3.1.2.	Model: R(C/H)UE 100~160AG2.....	33
3.1.3.	Model: R(C/H)UE 180~240AG2.....	34
3.1.4.	Model: R(C/H)UE 280~320AG2.....	35
3.1.5.	Model: R(C/H)UE 350~400AG2.....	36
3.2.	Power Wiring Diagram (FAN).....	37
3.2.1.	Model: R(C/H)UE 40~400AG2.....	37
3.3.	Control PCB (PCBc).....	38
3.3.1.	Model: R(C/H)UE 40~400AG2.....	38
3.3.2.	Model: R(C/H)UE 280~400AG2 (Secondary PCBc).....	39
3.4.	Input / Output PCB (PCBd).....	40
3.4.1.	Model: RCUE 40~240AG2.....	40
3.4.2.	Model: RCUE 280~400AG2.....	41
3.4.3.	Model: RHUE 40~240AG2.....	42
3.5.	Power Wiring Diagram (MCB Option).....	43
3.5.1.	Model: R(C/H)UE 40~80AG2.....	43
3.5.2.	Model: R(C/H)UE 100~160AG2.....	44
3.5.3.	Model: R(C/H)UE 180~240AG2.....	45
3.5.4.	Model: R(C/H)UE 280~320AG2.....	46
3.5.5.	Model: R(C/H)UE 350~400AG2.....	47
3.6.	Diagram abbreviations descriptions	48

3.1. Power Wiring Diagram

3.1.1. Model: R(C/H)UE 40~80AG2

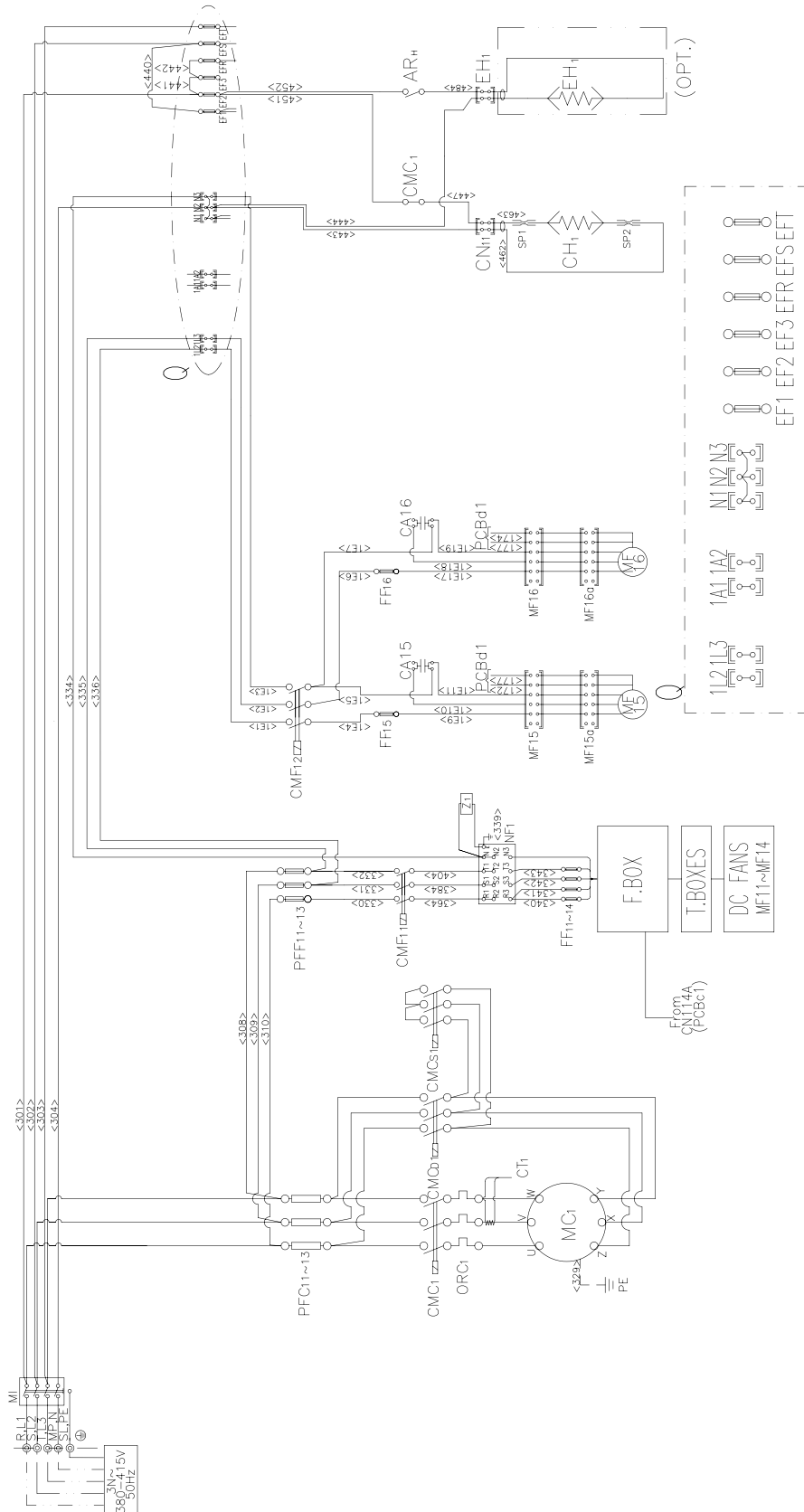

Drawing Code:
XEKS1037_r1



NOTE:

All the field wiring equipment must comply with local codes.
For more information about DWS configuration, please refer to chapter 4 of this catalogue.
See the diagram abbreviations description at the end of this chapter.

3.1.2. Model: R(C/H)UE 100~160AG2

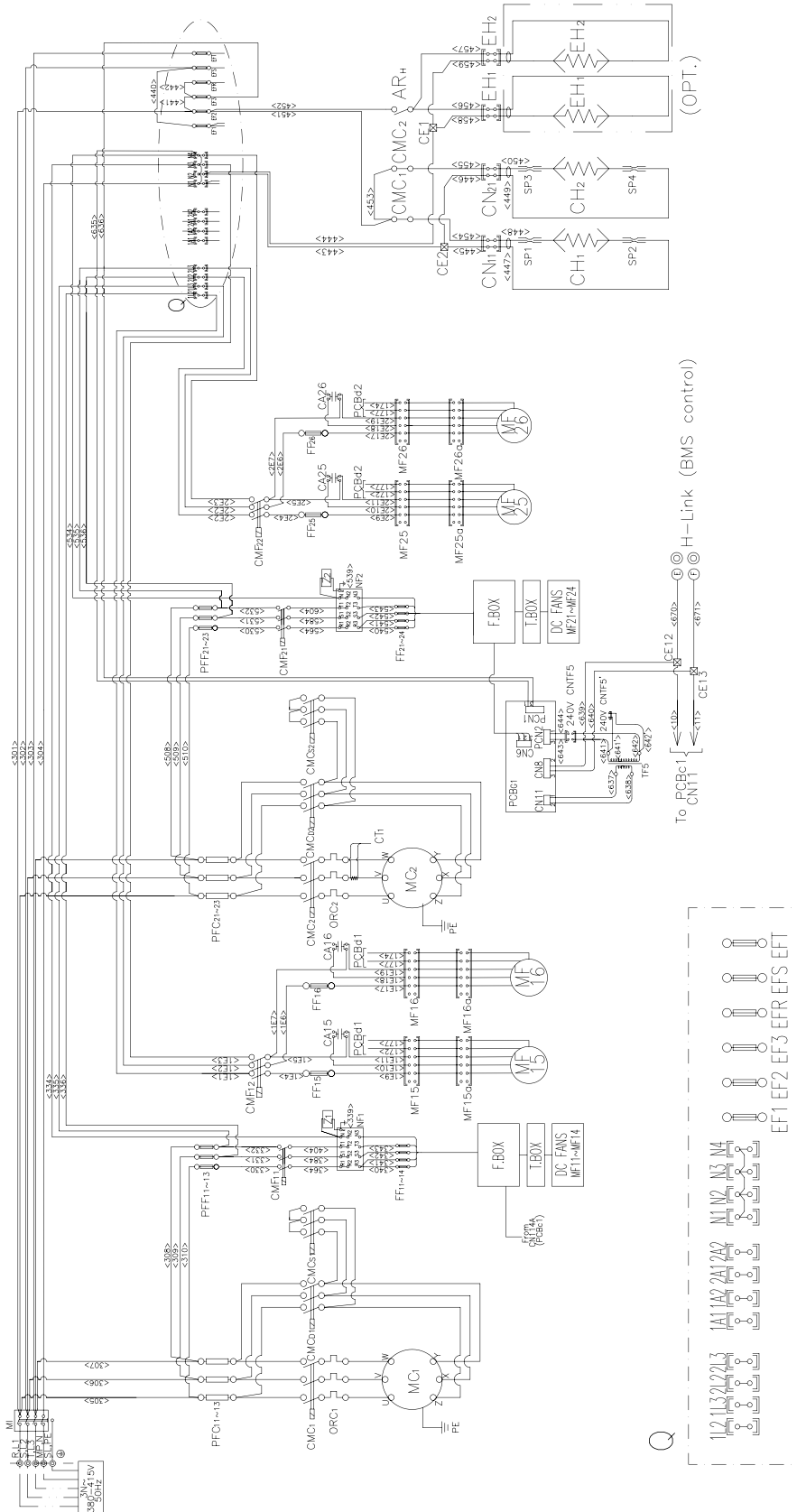

3

Drawing Code:
XEKS1038_r1



NOTE:
All the field wiring equipment must comply with local codes.
For more information about DWS configuration, please refer to chapter 4 of this catalogue.
See the diagram abbreviations description at the end of this chapter.

3.1.3. Model: R(C/H)UE 180~240AG2

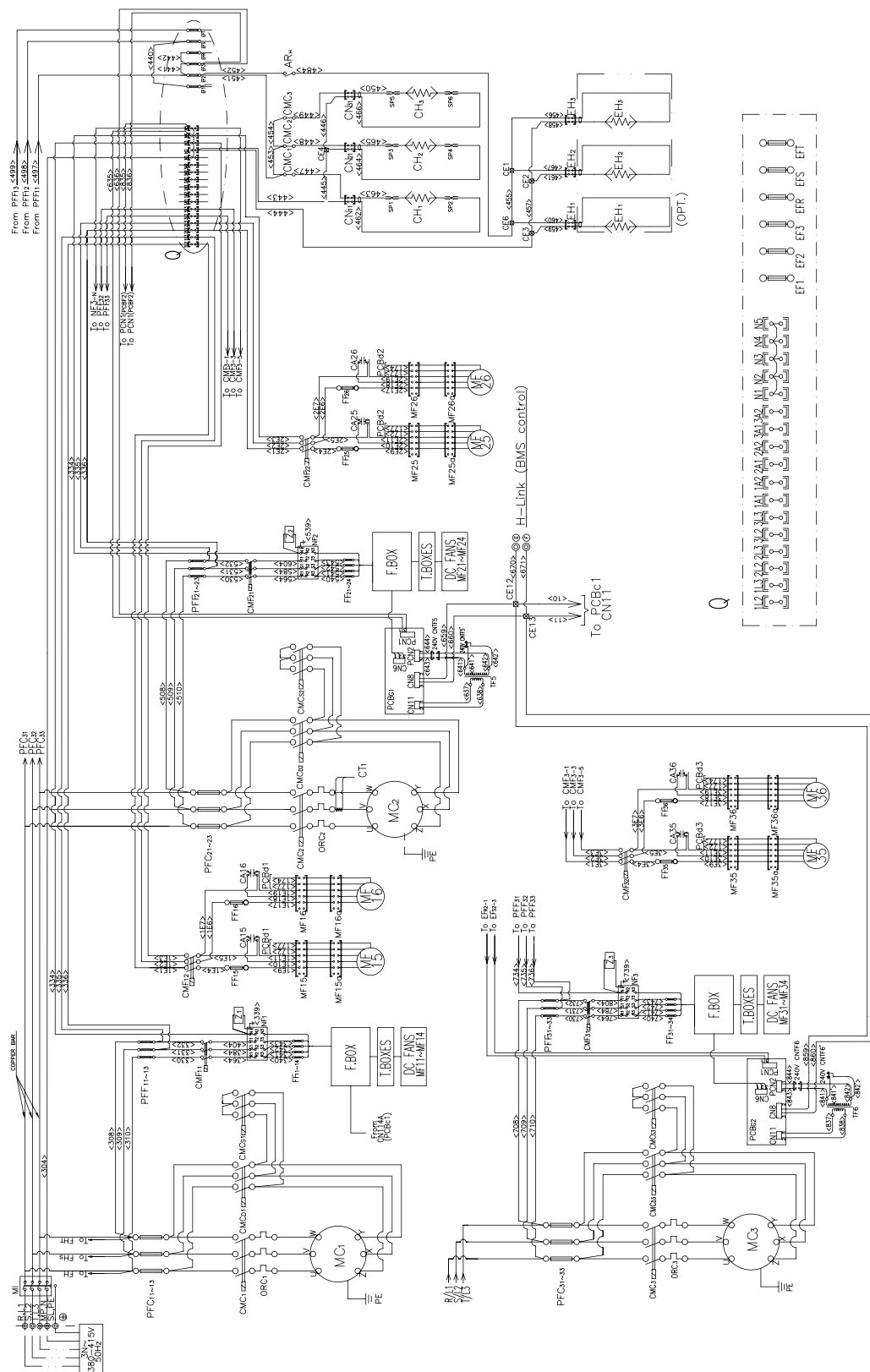

Drawing Code:
XEKS1036_r1



NOTE:

All the field wiring equipment must comply with local codes.
For more information about DWS configuration, please refer to chapter 4 of this catalogue.
See the diagram abbreviations description at the end of this chapter.

3.1.4. Model: R(C/H)UE 280~320AG2

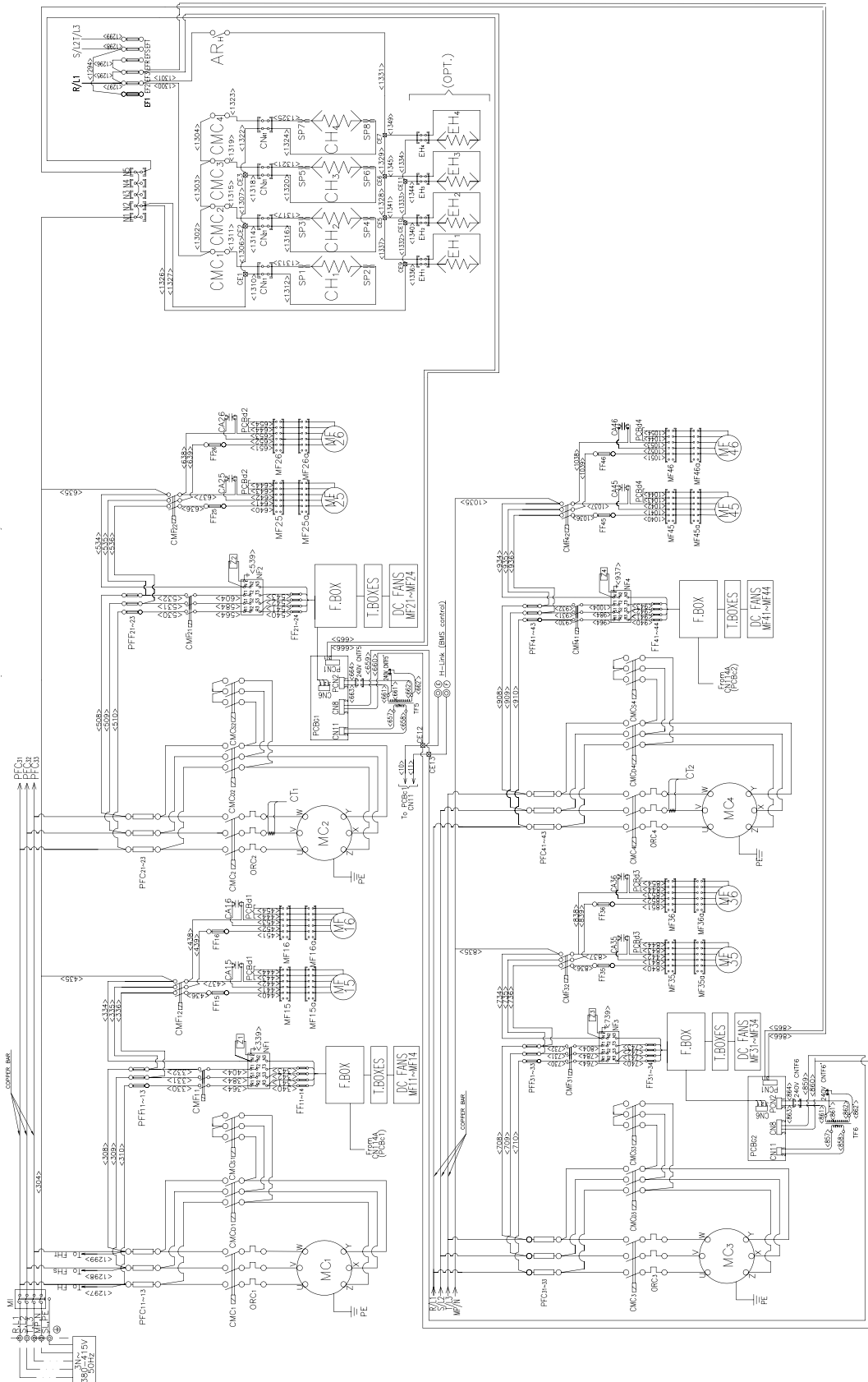

3

Drawing Code:
XEKS1040_r1



NOTE:

All the field wiring equipment must comply with local codes.
For more information about DWS configuration, please refer to chapter 4 of this catalogue.
See the diagram abbreviations description at the end of this chapter.

3.1.5. Model: R(C/H)UE 350~400AG2

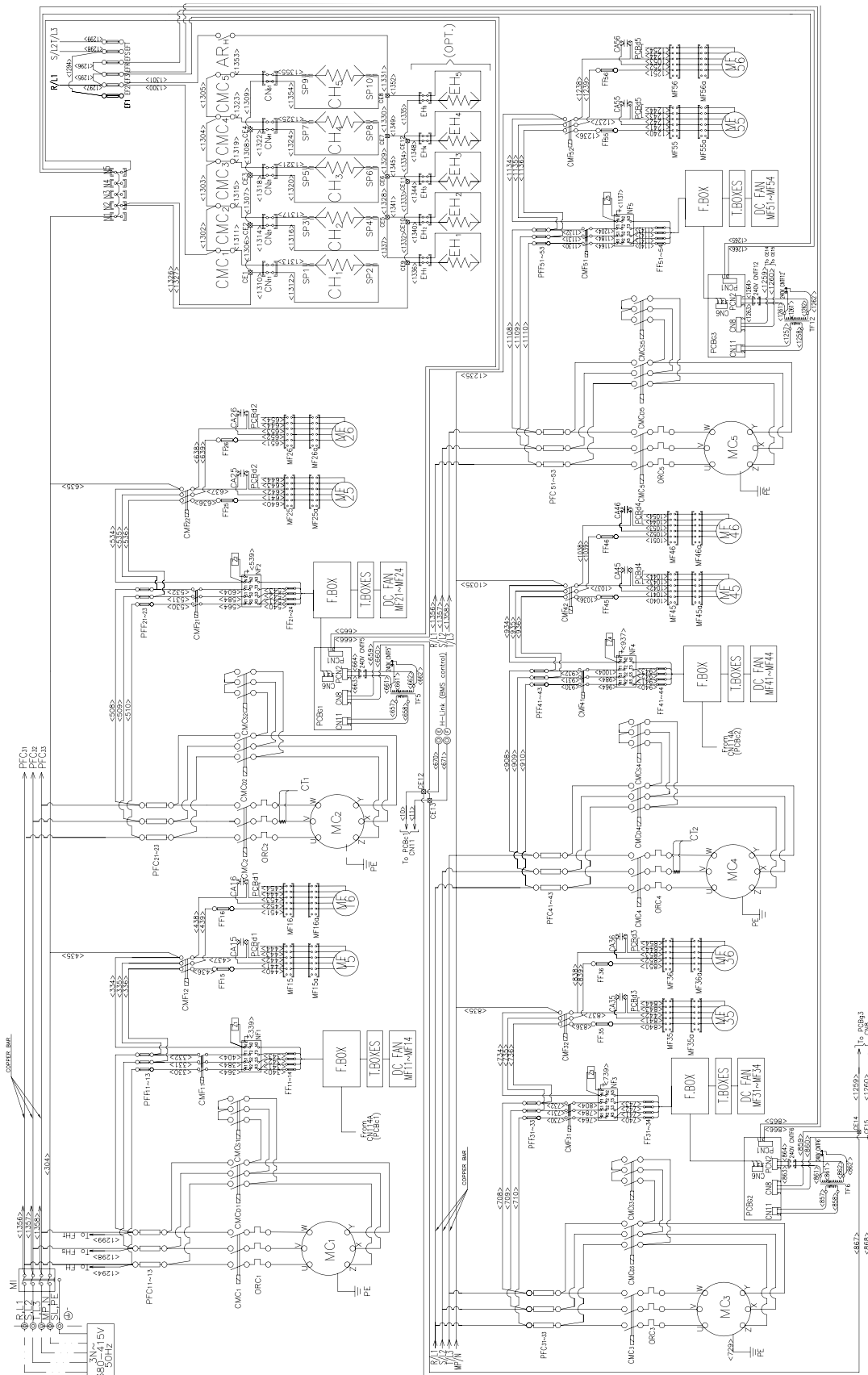

Drawing Code:
XEKS1041_11



NOTE:

All the field wiring equipment must comply with local codes.
For more information about DWS configuration, please refer to chapter 4 of this catalogue.
See the diagram abbreviations description at the end of this chapter.

3.2. Power Wiring Diagram (FAN)

3.2.1. Model: R(C/H)UE 40~400AG2

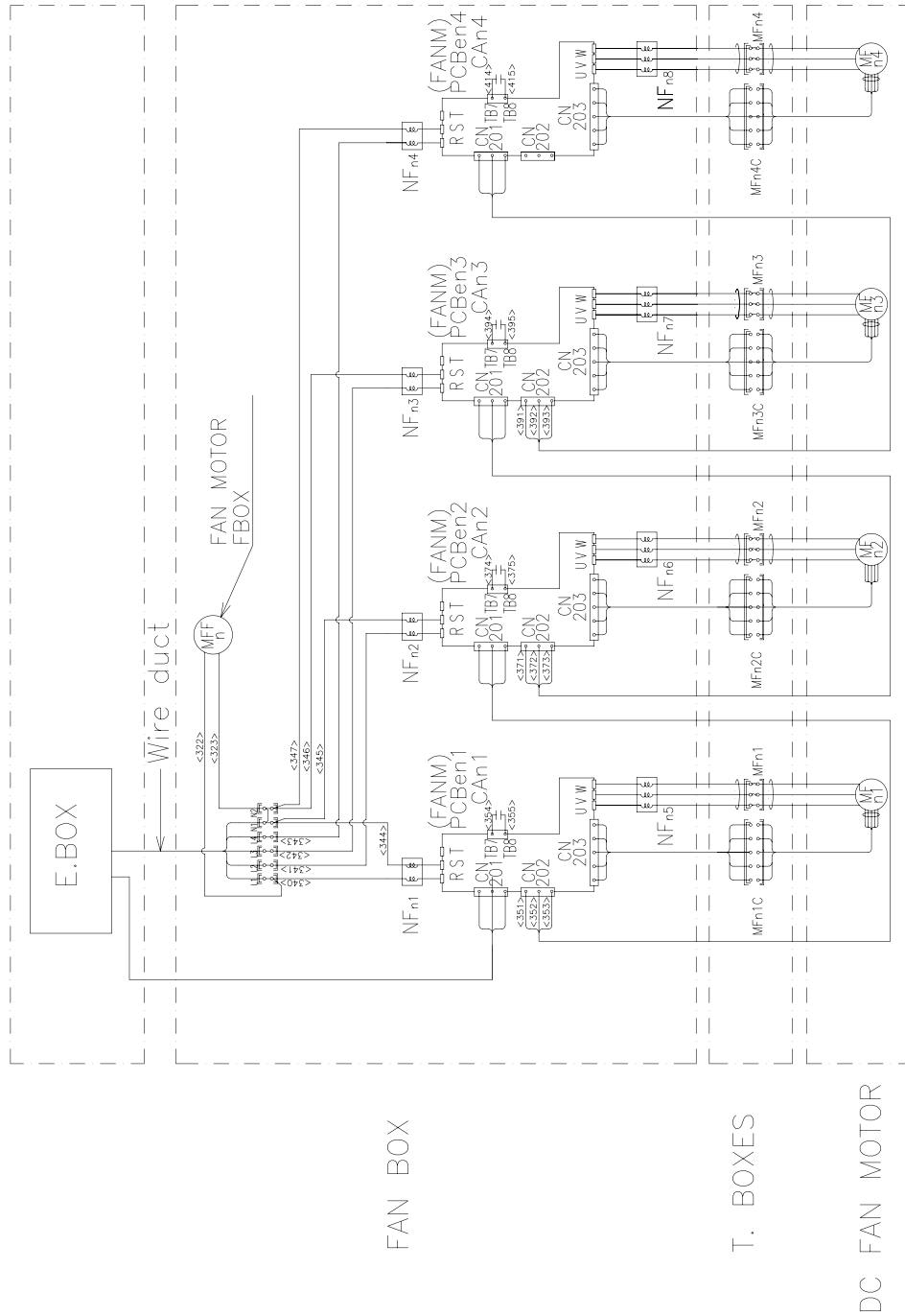

NOTE:

All the field wiring equipment must comply with local codes.
For more information about DWS configuration, please refer to chapter 4 of this catalogue.
See the diagram abbreviations description at the end of this chapter.

3.3. Control PCB (PCBc)

3.3.1. Model: R(C/H)UE 40~400AG2

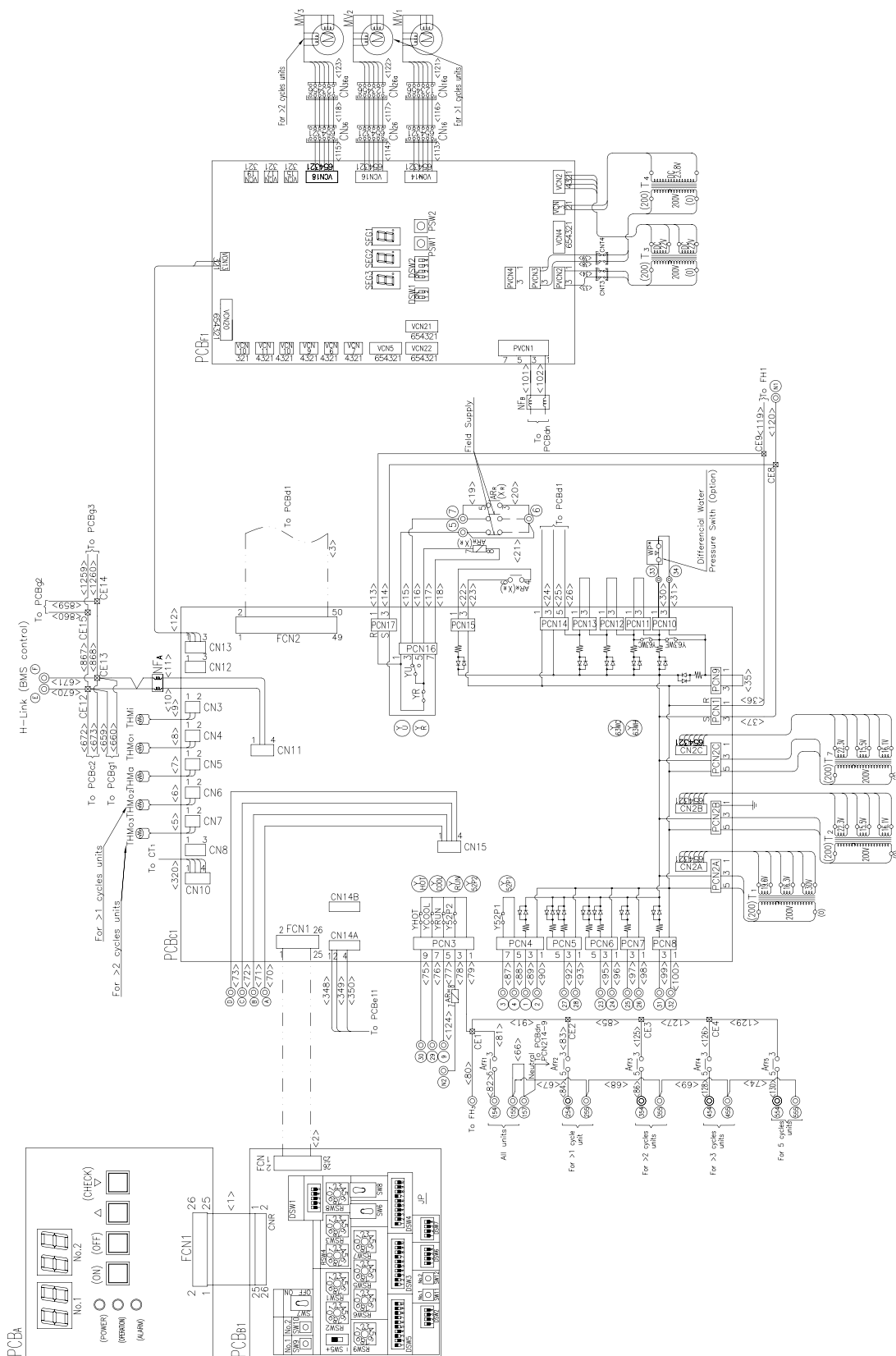

Drawing Code:
XEKS1043_r1



NOTE:

All the field wiring equipment must comply with local codes.
For more information about DWS configuration, please refer to chapter 4 of this catalogue.
See the diagram abbreviations description at the end of this chapter.

3.3.2. Model: R(C/H)UE 280~400AG2 (Secondary PCBc)

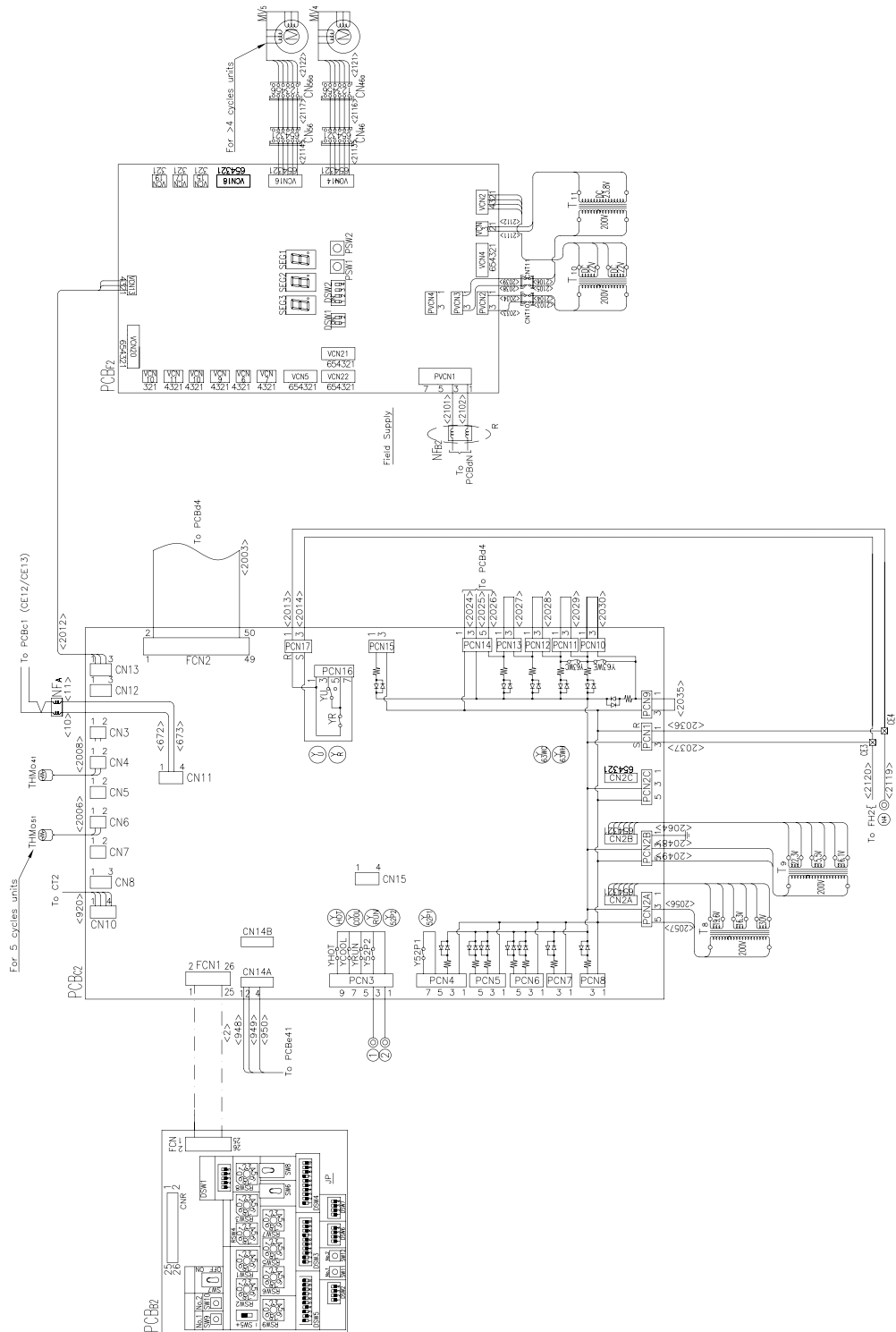

3

Drawing Code:
XEKS1045_r1



NOTE:

All the field wiring equipment must comply with local codes.
For more information about DWS configuration, please refer to chapter 4 of this catalogue.
See the diagram abbreviations description at the end of this chapter.

3.4. Input / Output PCB (PCBd)

3.4.1. Model: RCUE 40~240AG2

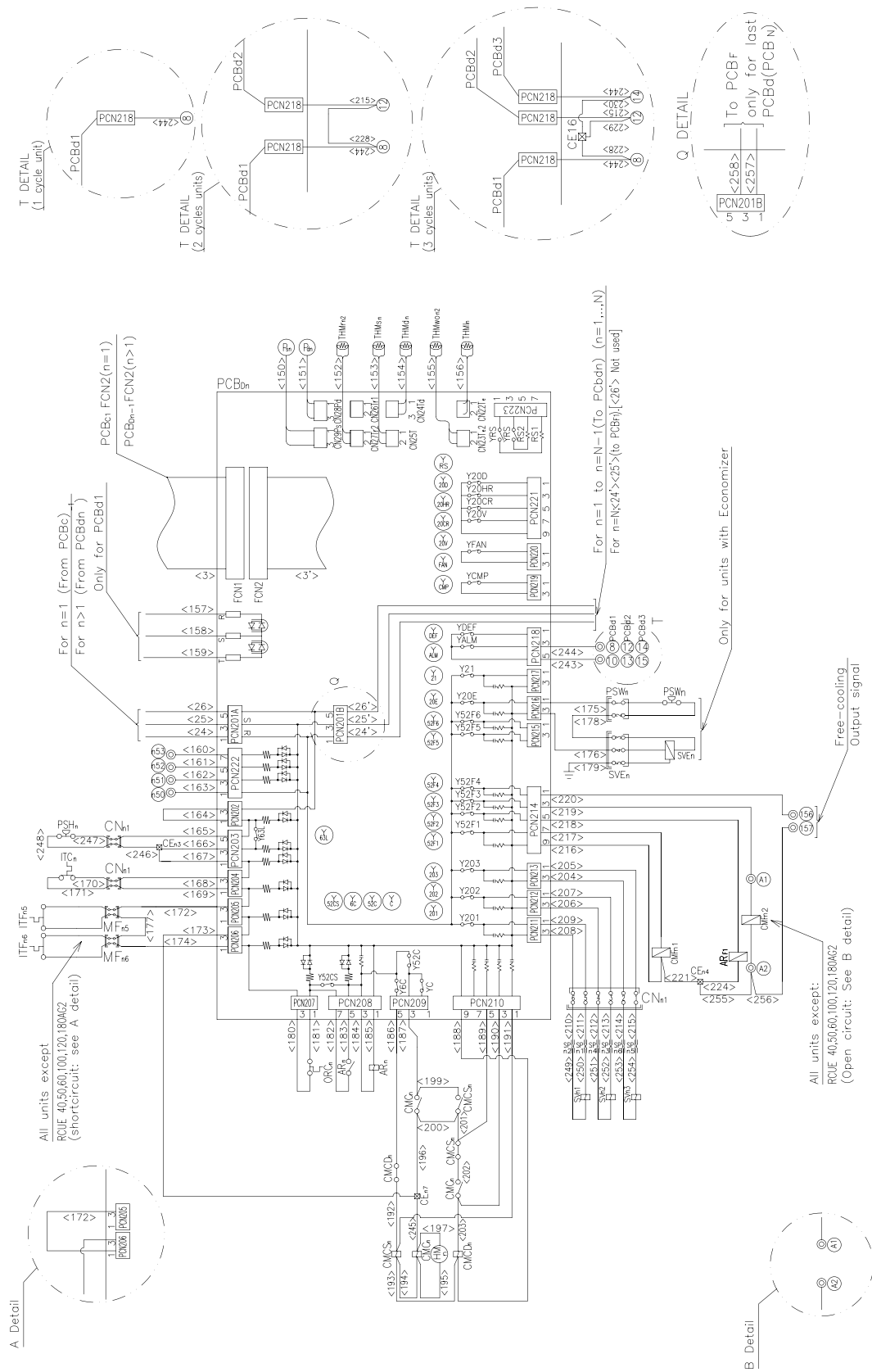

Drawing Code:
XEKS1044_r1



NOTE:
All the field wiring equipment must comply with local codes.
For more information about DWS configuration, please refer to chapter 4 of this catalogue.
See the diagram abbreviations description at the end of this chapter.

3.4.2. Model: RCUE 280~400AG2

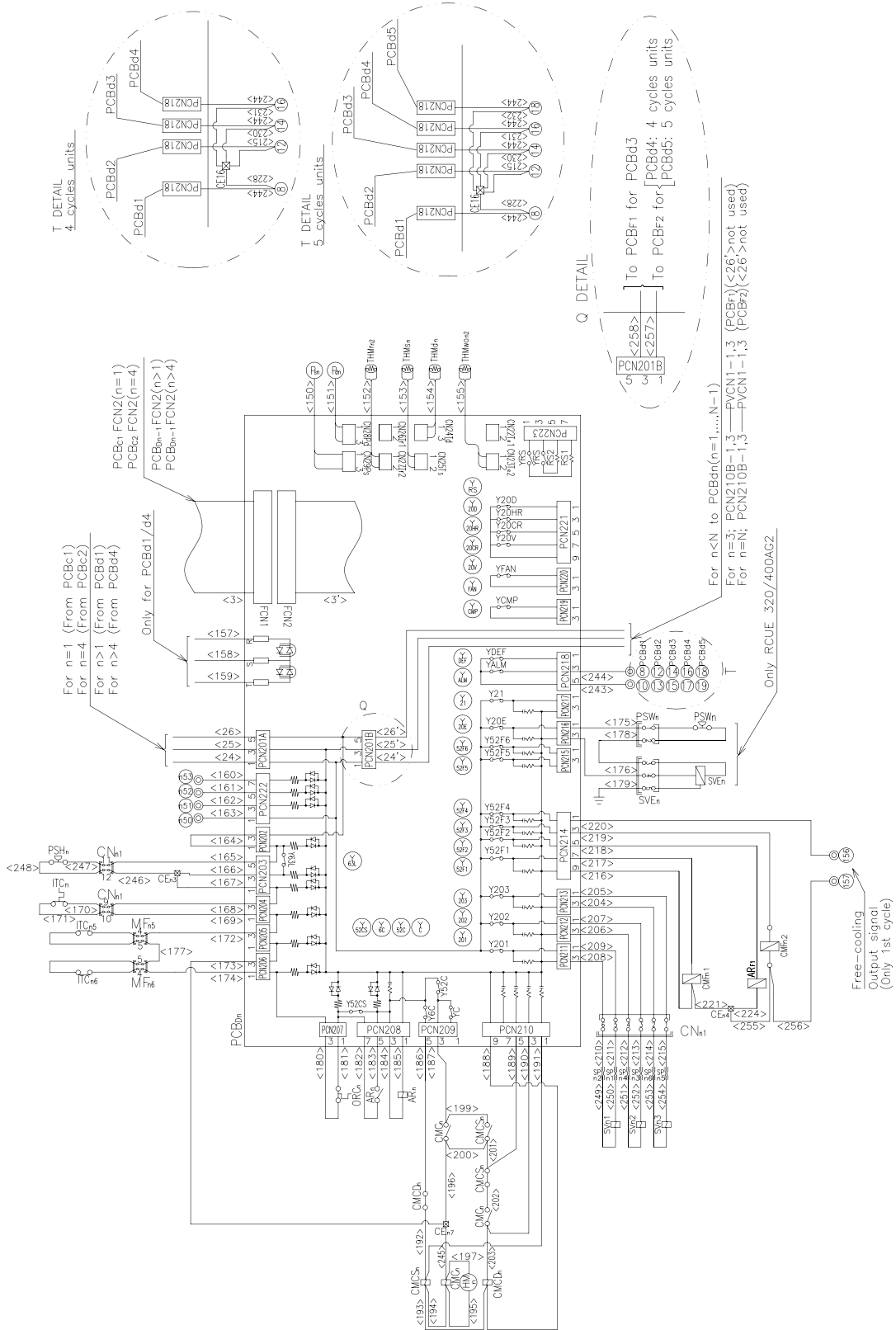

Drawing Code:
XEKS1046_r1



NOTE:

All the field wiring equipment must comply with local codes.
For more information about DWS configuration, please refer to chapter 4 of this catalogue.
See the diagram abbreviations description at the end of this chapter.

3.4.3. Model: RHUE 40~240AG2

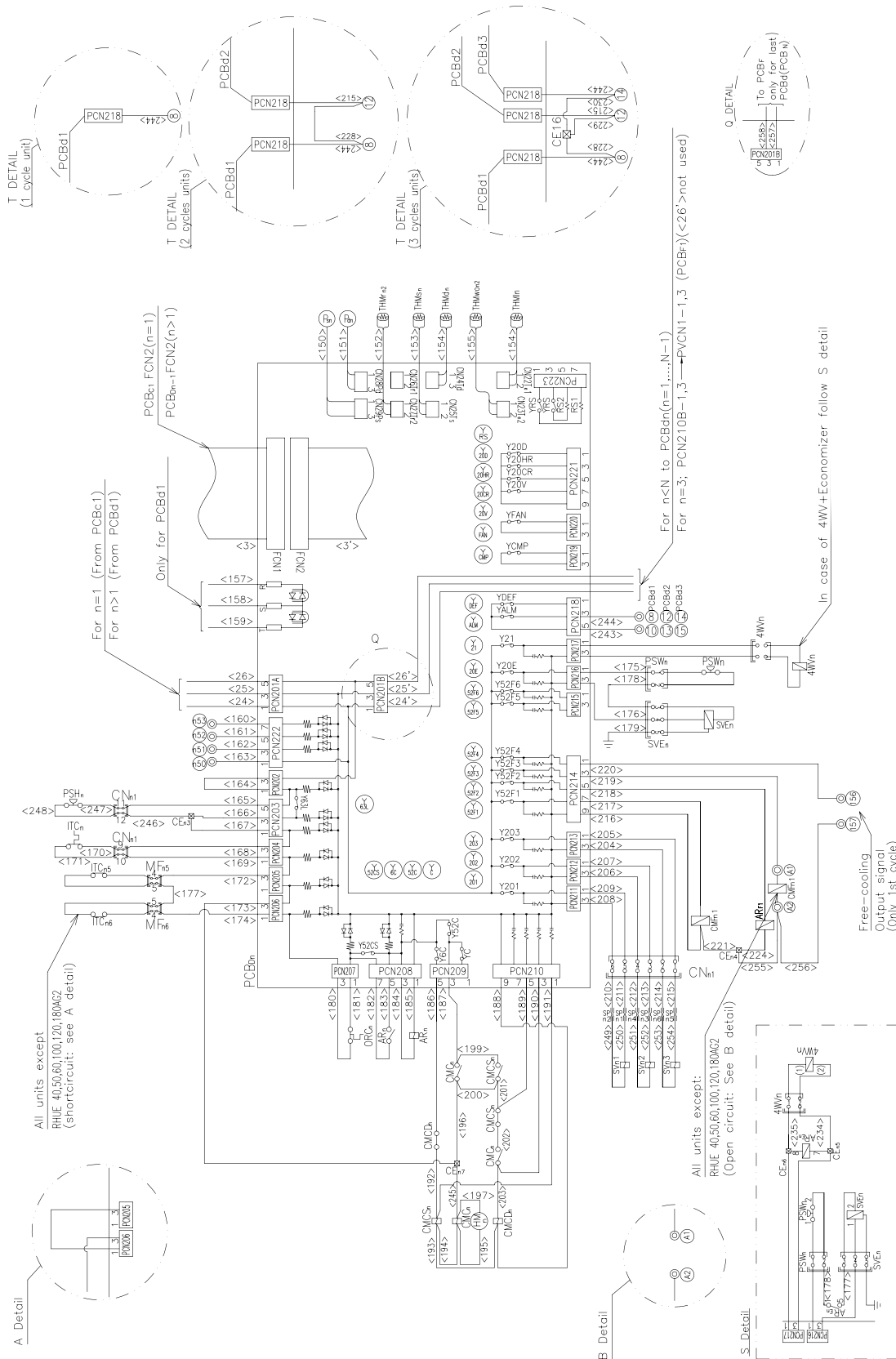

Drawing Code:
XEKS1047_1



NOTE:

All the field wiring equipment must comply with local codes.
For more information about DWS configuration, please refer to chapter 4 of this catalogue.
See the diagram abbreviations description at the end of this chapter.

3.5.2. Model: R(C/H)UE 100~160AG2

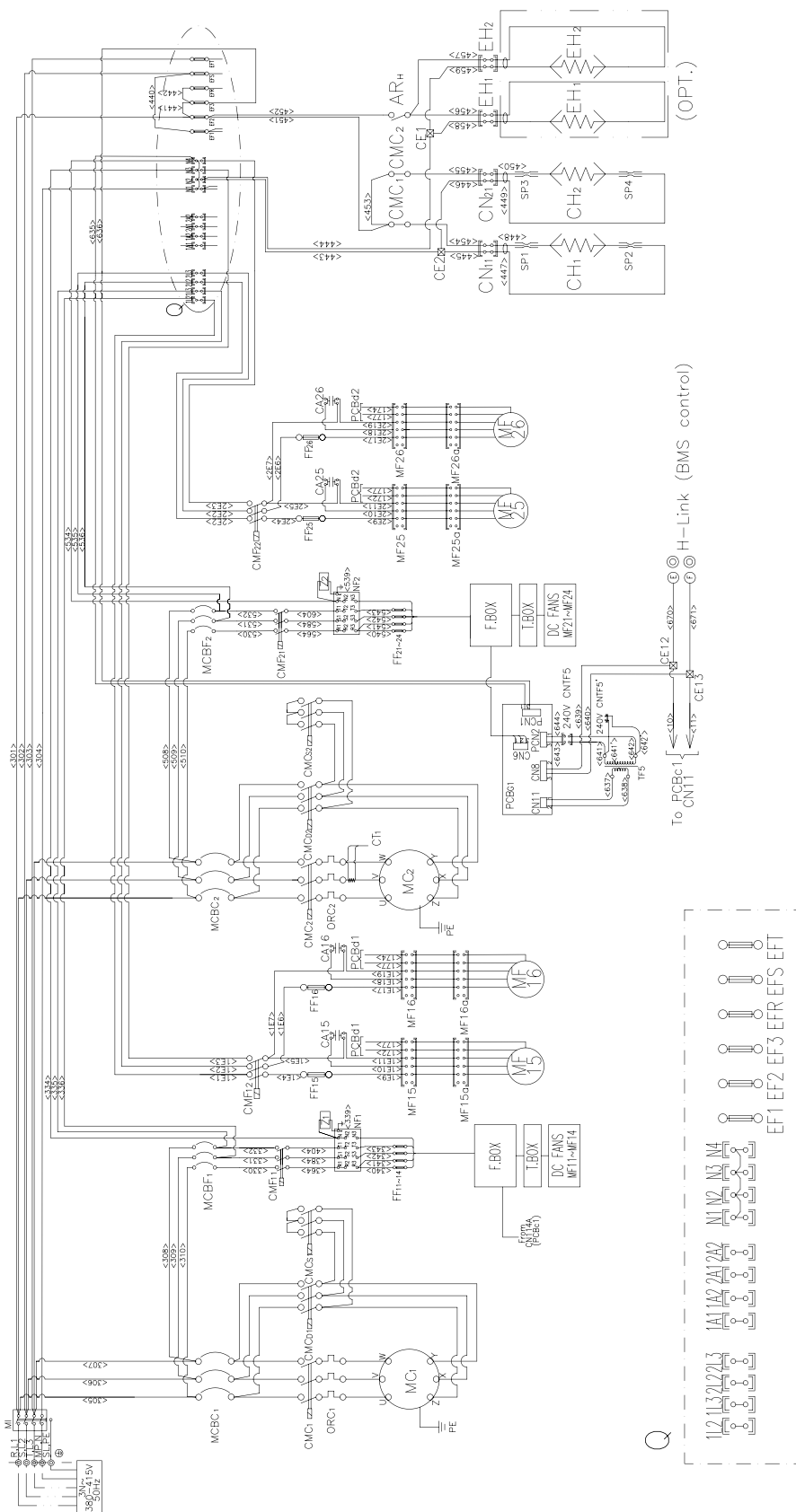

Drawing Code:
XEKS1046_r1



NOTE:

All the field wiring equipment must comply with local codes.
For more information about DWS configuration, please refer to chapter 4 of this catalogue.
See the diagram abbreviations description at the end of this chapter.

3.5.3. Model: R(C/H)UE 180~240AG2

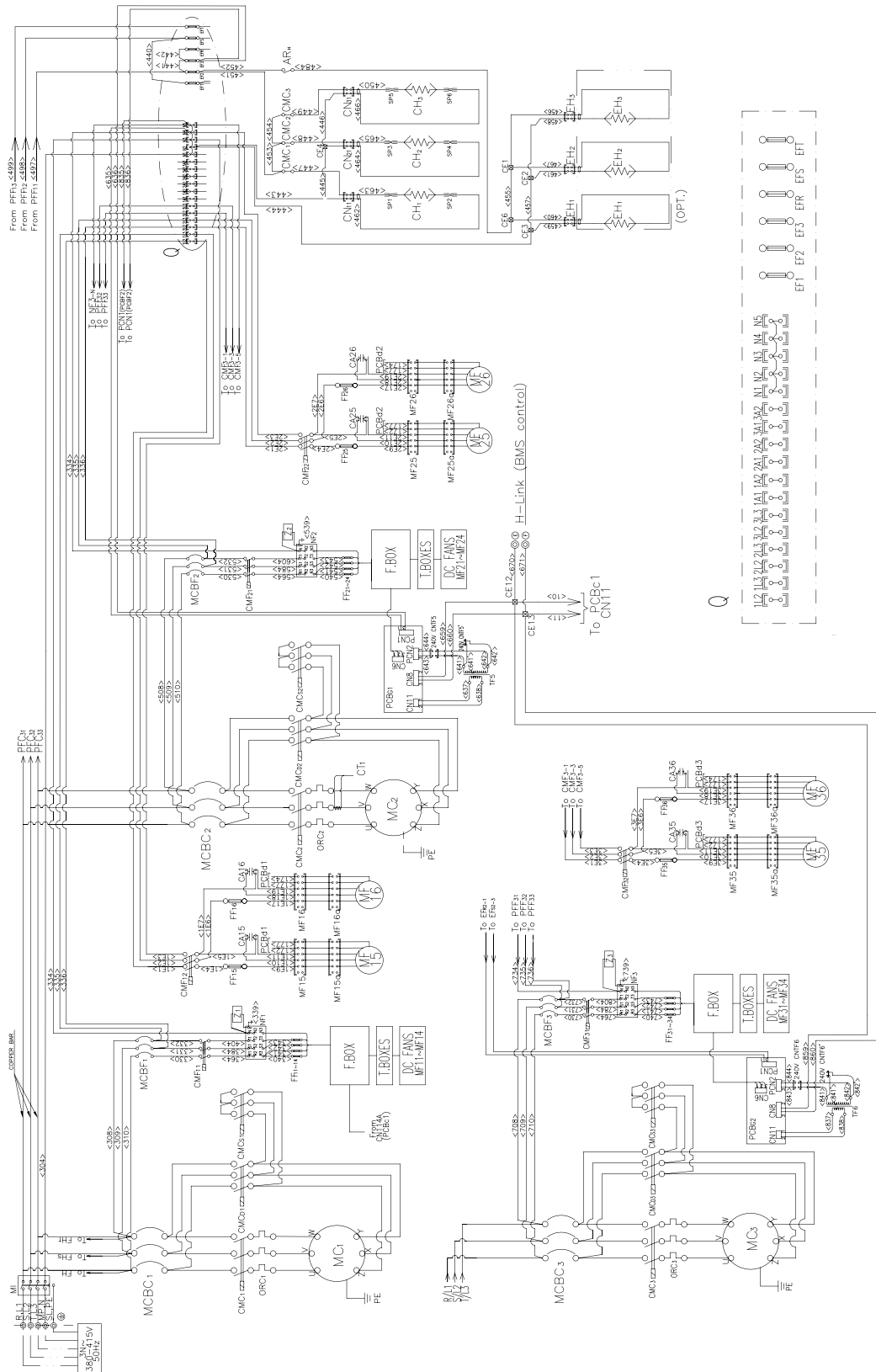

3

Drawing Code:
XEKS1050_r1



NOTE:

All the field wiring equipment must comply with local codes.
For more information about DWS configuration, please refer to chapter 4 of this catalogue.
See the diagram abbreviations description at the end of this chapter.

3.5.4. Model: R(C/H)UE 280~320AG2

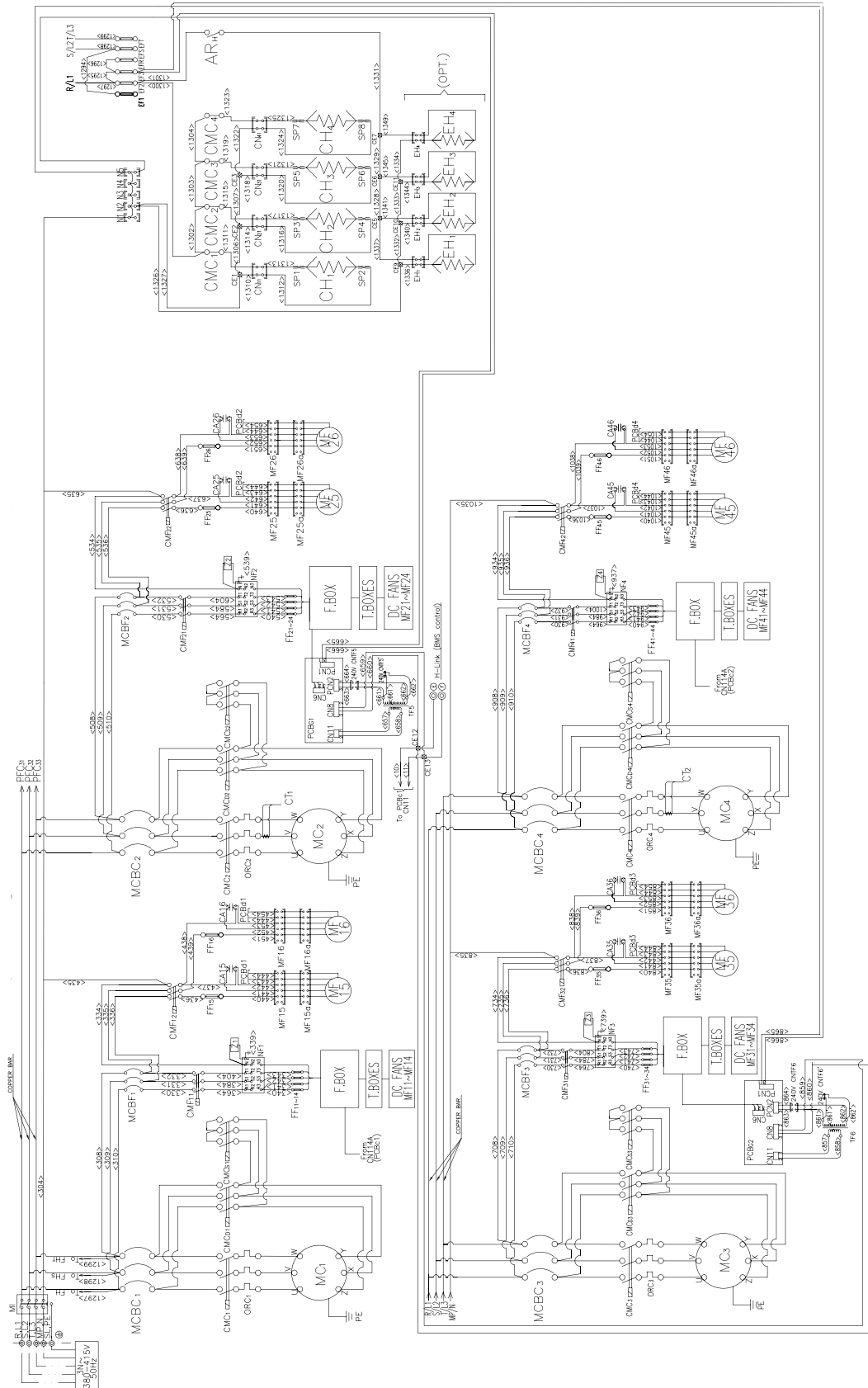

Drawing Code:
XEKS1051_r1



NOTE:

All the field wiring equipment must comply with local codes.
For more information about DWS configuration, please refer to chapter 4 of this catalogue.
See the diagram abbreviations description at the end of this chapter.

3.5.5. Model: R(C/H)UE 350~400AG2

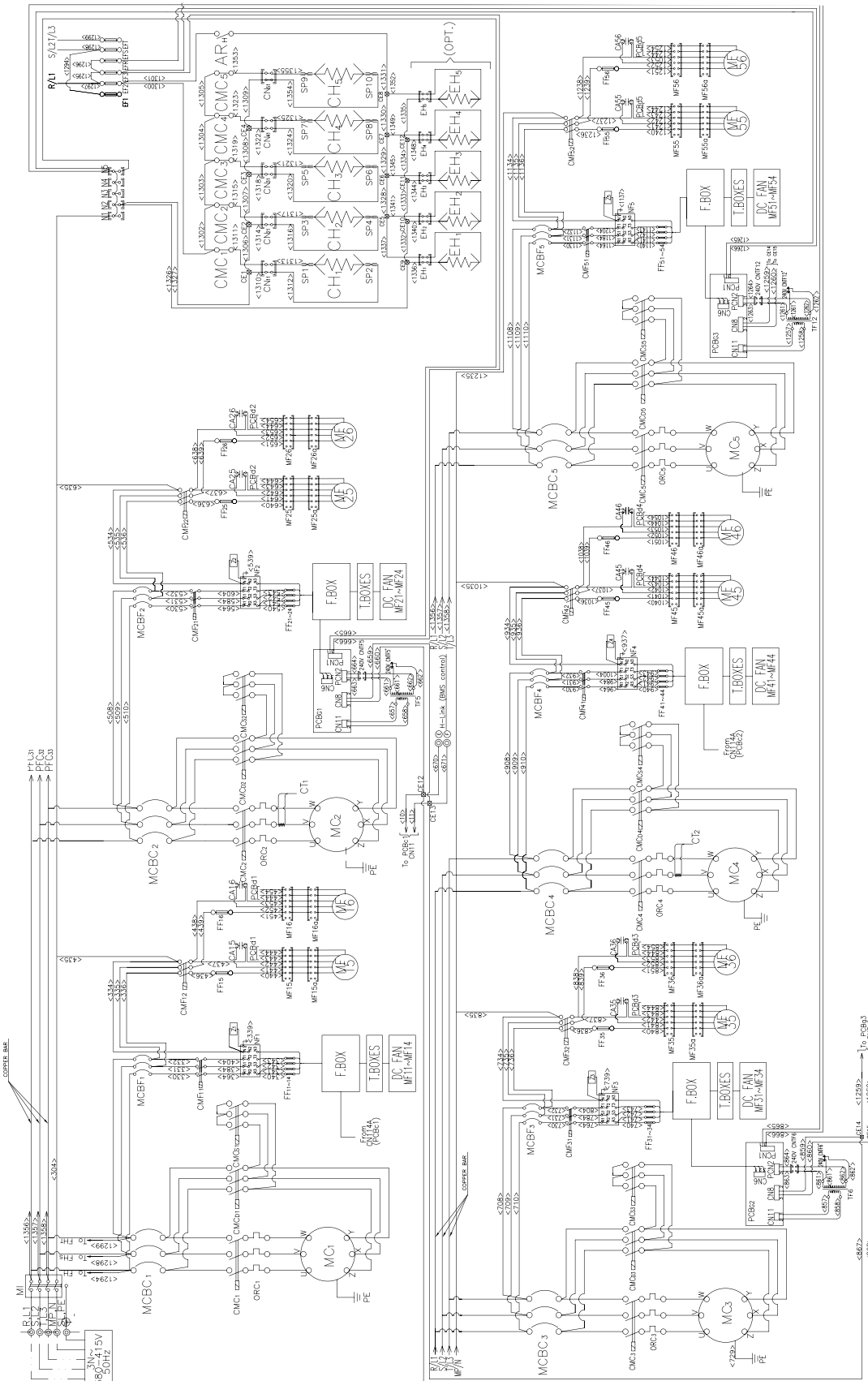

3

Drawing Code:
XEKS1037_r1



NOTE:
All the field wiring equipment must comply with local codes.
For more information about DWS configuration, please refer to chapter 4 of this catalogue.
See the diagram abbreviations description at the end of this chapter.

3.6. Diagram abbreviations descriptions

Mark	Name	Remark	Mark	Name	Remark
MCn	Compressor Motor		PCBB1,B2	Printed Circuit Board for Operation	
MF11-N6	Condenser Fan Motor		PCBC1,C2	Printed Circuit Board for CPU	
MI	Main Isolator		PCBD1	Printed Circuit Board for Relay	
CMC1	Contactora for Compressor Motor		PCBE11~	Printed Circuit Board for Fan Control	
CMCsn	Contactora for Compressor Motor (Start Operation)		PCBF1,F2	PCB for Electronic Expansion Valve	
CMCDn	Contactora for Compressor Motor (Delta Operation)		PCBG1,G2,G3	PCB for DC Fan control	
CMF11-N2	Contactora for Condenser Fan Motor		WP	Water Pressure Switch, Water Flow Switch	Option
EFCn	Fuse for Compressor Motor	or optional Circuit Breaker	SVE n	Solenoid Valve for Economizer	
ORCn	Overcurrent Relay for Compressor Motor		PSWn	Pressure Switch for Economizer	
EFF11-N4	Fuse for Condenser Fan Motor	or optional Circuit Breaker	EHn	Cooler Heater	
ITC1-n	Internal Thermostat for Compressor		TF1,2,3,4,5,6,7	Transformers	
ITFn5,n6	Internal Thermostat for Fan Motor		4WNn	4-way valve	
CHn	Crankcase Heater		SW2~8	External Switch	
ARn,H,R	Auxiliary Relay		CL	Pilot Lamp for caution signal (from Fans)	Field Supplied
PSHn	High Pressure Switch	OFF: 2.74Mpa ON: Manual Reset	PBSR1	Push Button Switch for Starting (REMOTE)	
Pdn	High Pressure Sensor		PBSR2	Push Button Switch for Stoppage (REMOTE)	
Psn	Low Pressure Sensor		RLn	Pilot Lamp for Remote Indication (Unit Operation)	
THMi	Inlet Water Temperature Thermistor		OLn	Pilot Lamp for Remote Indication (Alarm)	
THMW01n	Outlet Water Temperature Thermistor		CMP	Contactora for Pump	
THMr2 n	Cooler Inlet Refrigerant Thermistor		TRP	Thermal Relay for Pump	
THMn	Suction Gas Temperature Thermistor		N:1~n		
THMlwon2	Water Temperature cooler backside				
THMd n	Discharge Gas Thermistor				
PFCn	Fuse holder for Compressor Motor	Or optional Circuit Breaker			
PFFn	Fuse holder for Compressor Fan Motor	Or optional Circuit Breaker			
THMa	Ambient Temperature Thermistor				
NFn	Noise Filter (PCB)				
NFA,B,11~9N	Noise Filter (PCB)				
MVn	Electronic Expansion Valve (Exp.v)				
CT1,2	Current sensor				
FF11~N4	Fan five protection	12A			
MFFn	Fan motor inside Electrical Box				
CA11~N6	Capacitors for Fan				
EF1~3, R,S,T	Fuse	6A			
SV11-N1	Solenoid Valve for Starting				
SV12-N2	Solenoid Valve for Load-down				
SV13-N3	Solenoid Valve for Load-up				
TMn	Hour Meter				
PCBA	Printed Circuit Board for Display				

Symbol	Description
	Terminals
	Closed-end Connector
	Field-supplied
	Field Wiring
	Earth Wiring
	Factory wiring

N	Model
1	R(C/H)UE 40, 50, 60, 70, 80AG2
2	RC(H)UE 100, 120,140, 160AG2
3	R(C/H)UE 180, 210, 240AG2
4	RCUE 280, 320AG2
5	RCUE 350,400AG2

4. Control system

4

Content

4. Control system	49
4.1. List of Main Control Function.....	50
4.2. Water control	52
4.2.1. Automatic temperature adjustment	52
4.3. Compressor control	53
4.3.1. Starting control	53
4.3.2. Rotation control	53
4.4. Current limit control	54
4.4.1. Actuation of current limiter	54
4.4.2. Standard setting value of unload time.....	54
4.5. Reverse protection control.....	55
4.6. Restart control after power failure	56
4.6.1. Restart control after momentary power failure (<2 sec).....	56
4.6.2. Restart function after power failure <Option> (>2 sec).....	56
4.7. Operation error/wrong setting prevention control [40 – 40].....	57
4.8. Forced capacity control	57
4.9. Second water temperature setting.....	58
4.10. Heat storage operation by external order.....	64
4.11. Operation by DC24V input (Remote Control).....	65
4.12. Installation of switch for snow measure (Fan manual operation)	68
4.13. Switch for confirmation of high pressure cut.....	69
4.14. Antifreeze control in winter	69
4.15. Saving energy priority mode, silence priority mode (night shift), only cooling.....	70
4.16. Defrost (only air-cooled heat pump type)	72
4.17. Thermo off selection function	75
4.17.1 Fan Control	76
4.17.2 Electronic expansion valve.....	78
4.17.3. Protection Controls.....	81

4.1. List of Main Control Function

Item		Contents
Water temp. control	Automatic water temperature control	<ul style="list-style-type: none"> – Outlet water temperature of water side heat exchanger is detected by thermistor and the position of compressor slide valve is controlled continuously. – The range of capacity control: 100~15%, Stop (all models)
Compressor	1. Starting control	– Δ control (5 seconds), Starting unload control (30 sec before capacity control).
	2. Time Guard	– Prevention of excessive compressor re-starts (3 minutes)
	3. Sequential starting control	– Prevention of compressors' simultaneous start (1 minute delay) (Unit with more than 1 cycle)
	4. Rotation control	– Balance of each compressor running hours (more than 1 cycle)
Current limit control		– When unit current reaches to the setting value, power supply capacity load is reduced. Therefore, unload operation is performed forcibly for some minutes.
Reverse protection control		– 3 phase status is detected to avoid the operation in reverse phase or open phase (before starting and during running of unit).
Restart function from momentary power failure		– In case of momentary power failure (13ms seconds \leq time \leq 2 seconds, and under -20% of power voltage), unit is stopped, and then is restarted when the voltage is back.
Automatic restart function from power failure <option>		<ul style="list-style-type: none"> – In case of power failure of over 2 seconds, the units are restarted after power supply is back. – In case of long-term power failure, the units are restarted when oil heater has electricity for a certain period after the power supply is back. – The units are not started automatically if power failure happens during stop. – It is an optional setting by Dip Switch (DSW1 pin2).
Operation error/ wrong setting prevention control		<ul style="list-style-type: none"> – Alarm is output for such operation errors that changeover from remote to local or from cooling to heating and wrong setting. – In case that operation order is input by remote controller when local operation is selected, alarm is output as safety.
Forced load control		<ul style="list-style-type: none"> – Forced capacity operation (forced Thermo OFF, forced capacity control) is performed by external signal attending to special needs of load. – Control is performed externally by a no-voltage contact for each compressor.
Second water temperature setting		<ul style="list-style-type: none"> – It is possible to adjust 2 setting temperatures. – 1st temperature is set by rotary switch, and 2nd temperature is set by key operation on the 7 segment. – According to the usage state of loading side, setting temperature can be switched by external signal (no-voltage contact input).

Item	Contents
Ice/Heat storage operation by external order	<ul style="list-style-type: none"> - Full load operation is performed by external order (no-voltage contact input). - Chiller unit stops when the water temperature reaches the setting value (no capacity control). - Dip Switch setting is necessary.
Fan forced operation function	<ul style="list-style-type: none"> - It is possible to operate only fans by an external order as a countermeasure against snow while units are stopped. - Run or Stop operation is performed by a no-voltage contact .
High pressure cut confirmation test (only cooling)	<ul style="list-style-type: none"> - While the actuation of high pressure interrupt device is confirmed, unit is operated with fan forcedly stopped. - Push button is set on PCB for every cycle number.
Pump automatic operation function in winter	<ul style="list-style-type: none"> - Operation order to pump is output automatically by chiller in order to avoid freezing due to the decrease of chilled water temperature during unit stop in winter.
"Saving energy" priority mode <option> (only cooling)	<ul style="list-style-type: none"> - It is to keep high pressure at low values when ambient temperature below 30 °C. - Since fan speed is increased, it is a saving energy operation more than a silence operation. - It is an optional setting by Dip Switch.
"Silence priority" mode <option> (only cooling)	<ul style="list-style-type: none"> - It is focused on a silent operation of the unit reducing the fan speed. - Since the revolution number is reduced during night or mid-term period, efficiency is changed hardly in all around the year. - Silence is given priority over saving energy. - It is an optional setting by Dip Switch. It is possible to switch from the remote controller by the external signal (no-voltage contact).
Night shift mode <option> (only cooling)	<ul style="list-style-type: none"> - When fan full speed operation is not needed, fan revolution number is reduced, and low noise operation is performed. - Ambient temperature target: function is valid under 30 °C (noise value 1--2dB) (changeover by no-voltage a contact input)
Thermo OFF selection function	<ul style="list-style-type: none"> - There are two methods to judge Thermo OFF, possible to select. <ol style="list-style-type: none"> 1. Immediate Thermo OFF by Thermo OFF temperature 2. No immediate Thermo OFF if Thermo OFF temperature continues for 3 minutes. (however, if outlet water temperature is out of the range, it will be immediate Thermo OFF)

4.2. Water control

4.2.1. Automatic temperature adjustment

- Outlet water temperature of Chiller Unit is detected by Thermistor, and based on this value, compressor ON/OFF and the most suitable capacity is determined.
- Possible range of water temperature setting (°C):
Cooling -10(option)~15, Heating: 35~55 (outlet water temperature control)
- Capacity control : 100~15%, stop
- The minimum range of temperature adjustment (°C): 0,5
- Restarting of unit after thermo-OFF is done depending on inlet water temperature.

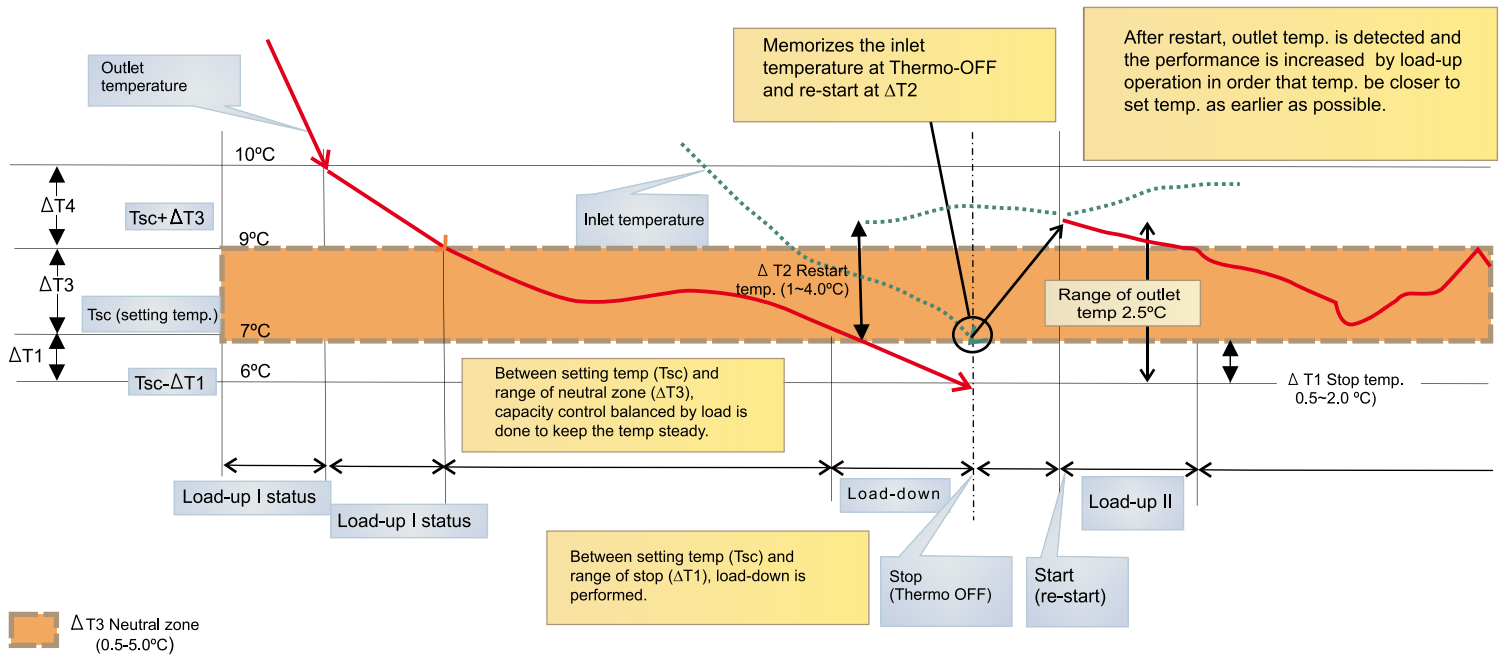

Method of outlet temp detection

In case of standard setting: outlet setting temp 7°C, neutral zone ($\Delta T3$) 2°C (change of outlet water temp 7~9°C). Range of stop temp ($\Delta T1$) 1°C (stop temp 6°C), range of restart temp 2°C.

1. Load-up I control at over 10°C (The capacity is changed a lot in order to approximate the target temp. quickly)
2. Load-up II control at 9~10 °C (The capacity is changed moderately)
3. In neutral zone (9~7°C), load is balanced and performance is not changed.
4. Under neutral zone (below 7°C) load-down control is performed and performance is decreased.
5. Stop temp: Compressor is stopped at 6 °C. The inlet temp of that time is saved.
6. When inlet temp becomes 2°C higher than that of at stop, re-start signal is output and unit is re-started after at least 3 min guard.
7. Control mode after re-start is the same as listed before.

4.3. Compressor control

Compressor Control:

1. Starting control
2. Time Guard
3. Sequential starting control
4. Rotation control

Compressor control

4.3.1. Starting control

Starting control, Time Guard and Sequential starting control.

These three controls are performed in the control circuit on PCB.

- Δ starting control of screw compressor (operation lasts 5 seconds), at minimum load. (for 30 seconds)
- Time guard function which limits the frequency of Run/Stop when cooling/heating load is small (at minimum 3 minutes of stop time to avoid more than 6 ON/OFF in one hour)
- Sequential starting control which reduces the starting current of the unit. (Cycles start sequentially with a 1 minute delay between each one. Finally all work together for 30 seconds before capacity control starts.)

4.3.2. Rotation control

Run/Stop order of compressor is modified in each Run/Stop in order to balance the compressors operation time and unit life is prolonged.

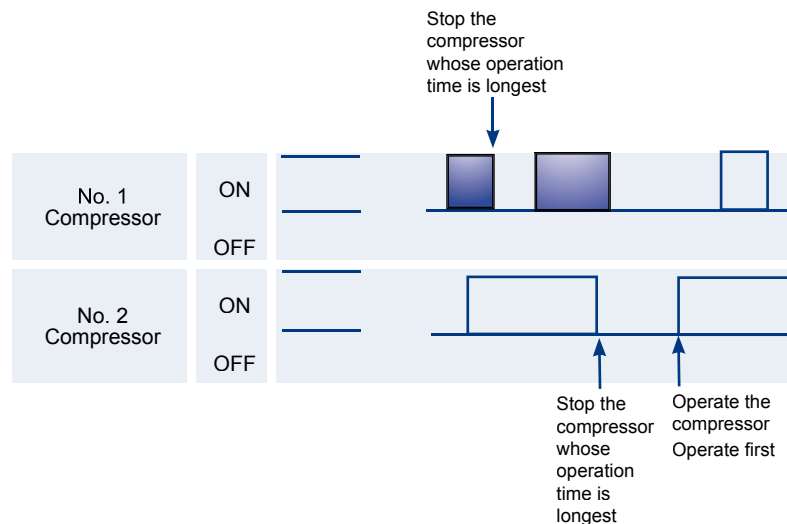

4.4. Current limit control

Unit has a function to perform automatically forced unload when the power consumption is over a certain set point.

4.4.1. Actuation of current limiter

When unit current detected by CT reaches to the setting value, forced unload operation is performed for some minutes to reduce the power capacity load. (See the figure below)

Load is down until actual current value is 95% of setting value, and then load down signal is output for 12 seconds to keep the load.

Current value and forced unload operation time are set on PCBa (current limit setting).

Current limit setting

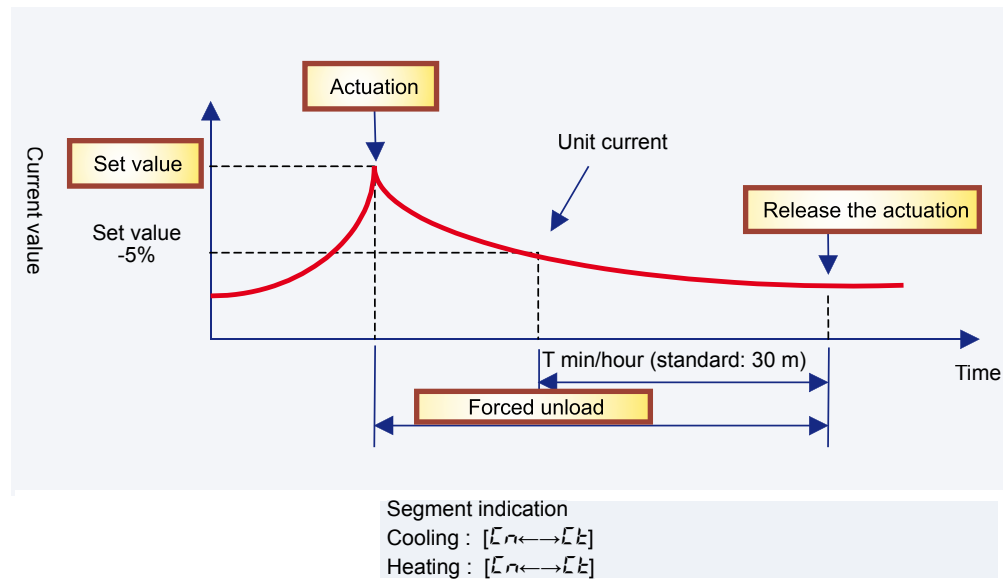

4.4.2. Standard setting value of unload time

- Current standard setting value of each model is shown in the below figure:

Current limit control

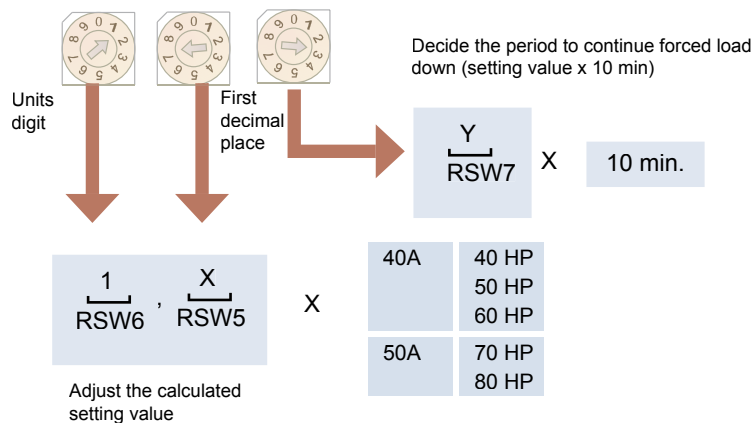
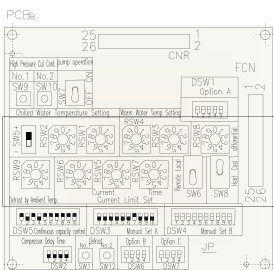

Ejemplo RCUE80AG2

$$\frac{1}{RSW6} \cdot \frac{6}{RSW5} \times 50 = 80 \text{ A}$$

Ejemplo RCUE40AG2

$$\frac{1}{RSW6} \cdot \frac{2}{RSW5} \times 40 = 48 \text{ A}$$

 Reverse protection control:

4.5. Reverse protection control

Screw compressor compresses the refrigerant to a determined pressure by decreasing the space formed by male/female rotor and slide valve. If the rotor revolution direction is reversed, the suction side and discharge side are reversed and the functioning of the compressor will not be correct.

Therefore, 3 phase input status is detected and operation is not performed in case of reverse phase or open phase.

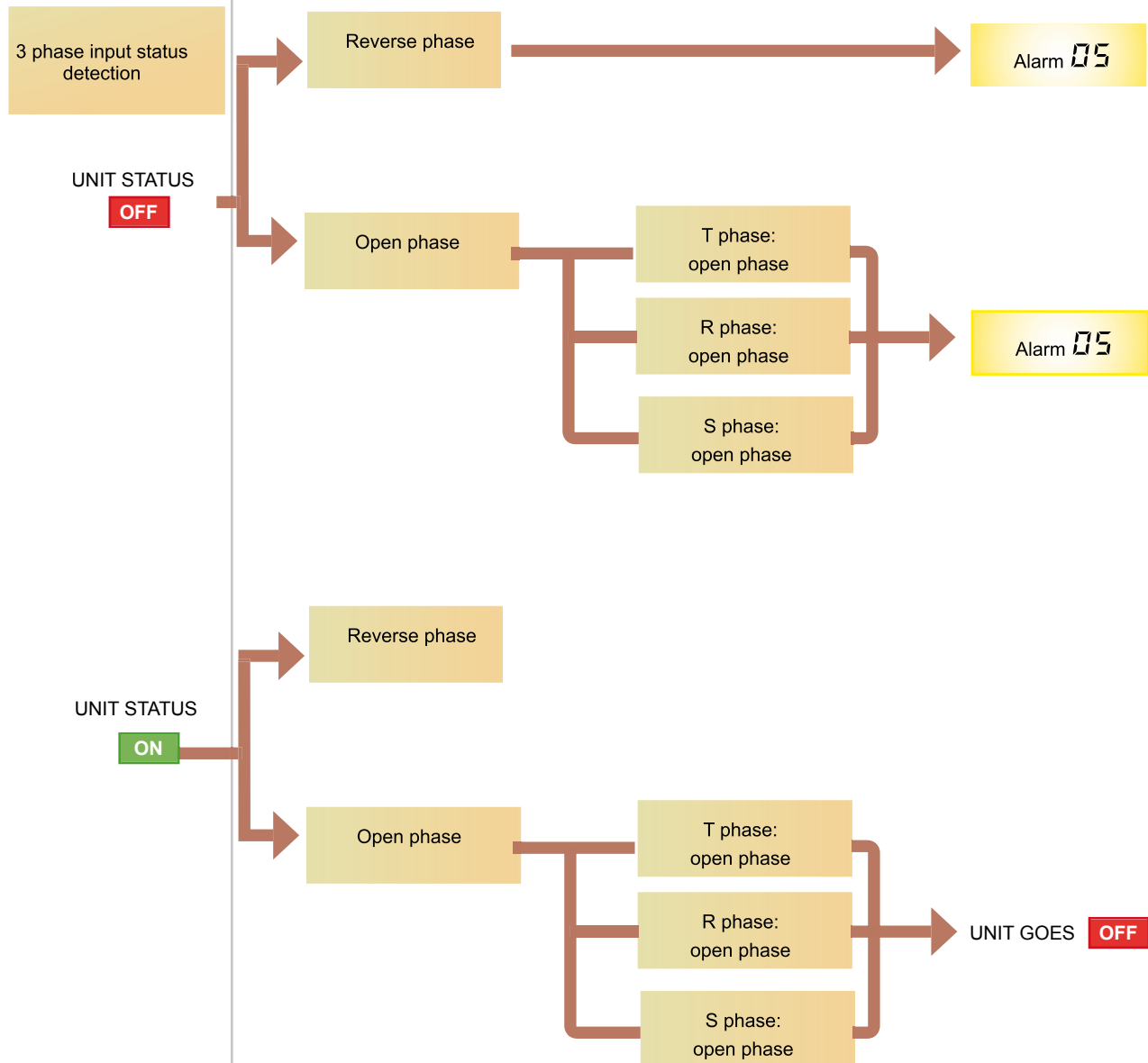

4

Restart control after power failure:

i NOTE:

Momentary power failure: Power failure of 13m seconds~2 seconds, below 160V.

In case of a power failure of over 2 seconds, it is possible to re-start the unit by optional function. If restart function after power failure is not selected, the units are not re-started in spite of ending the power failure. In that case, the units should be started according to the operation start process.

4.6. Restart control after power failure

4.6.1. Restart control after momentary power failure (<2 sec)

In momentary power failure, all settings are saved, so after 3 minutes time guard, unit is run automatically with the same operation mode as before the power failure.

4.6.2. Restart function after power failure <Option> (>2 sec)

When this function is valid, even in spite of over 2 seconds power failure, units are run automatically with the same operation mode as before the power failure (after delay time guard).

To be valid this function, DSW1- pin 2 on PCBb shall be ON.

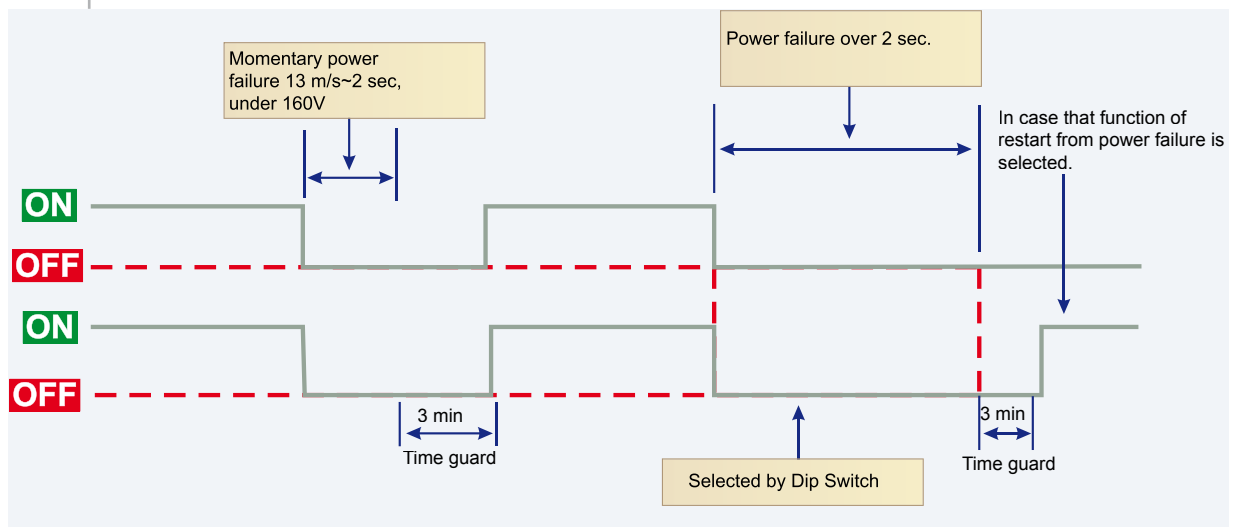
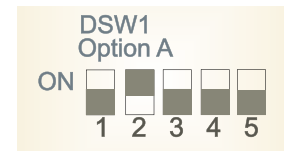

i NOTE:

In case that power failure occurs during unit stop, the units shall be stopped when power supply returns.

4.7. Operation error/wrong setting prevention control [40 – 40]

Operation error/wrong setting prevention control [40-40]:

Alarm is output in the following cases.

1. Operation error
 - While the unit is stopped, there is a input (including external Thermo signal) from the remote controller in spite of local operation mode.
 - However, alarm is not indicated if there is a local input (operation switch of unit body) while the unit is stopped in remote operation mode.
2. Local /Remote operation error
 - To switch local → remote or remote → local while the unit is running, unit is stopped and alarm is output. [40-40]
3. Cooling/Heating operation error
 - To operate heating during cooling or to operation in cooling during heating, unit is stopped and alarm is output. [40-40]
4. Wrong setting of Dip Switch
 - Dip Switch is set wrongly, alarm is indicated at power ON.

Forced capacity control:

4.8. Forced capacity control

This is a control to do Thermo OFF forcedly or to be shifted to the desired capacity by a external control.

Since it is possible to change the operation capacity forcedly according to the load, it is very useful if it is needed to control the temperature by a external signal.

1. Forced Thermo OFF function

a) Contents

In case that it is required to stop a compressor temporarily, the order can be given forcedly through the customer wiring terminals. After receiving this signal, compressor shall be Thermo OFF forcedly. When this order is released, normal operation is performed.

i NOTE:

This control is individual for each compressor.

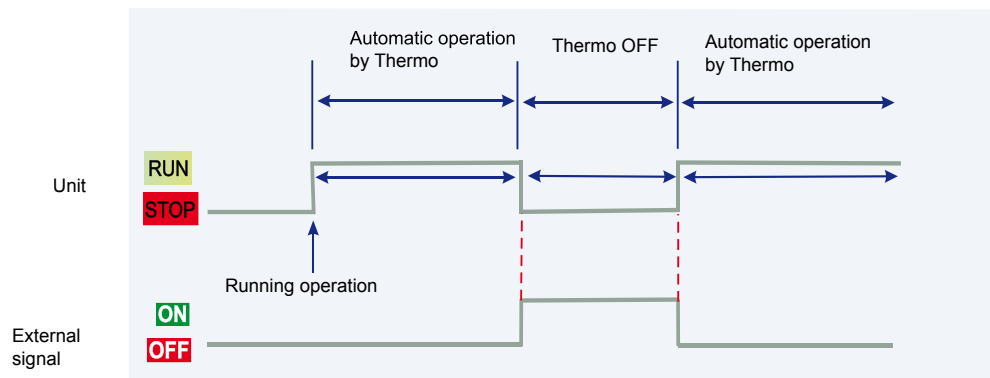

b) Wiring method (customer wiring terminal)

Wire as follows (n: n° of compressor).

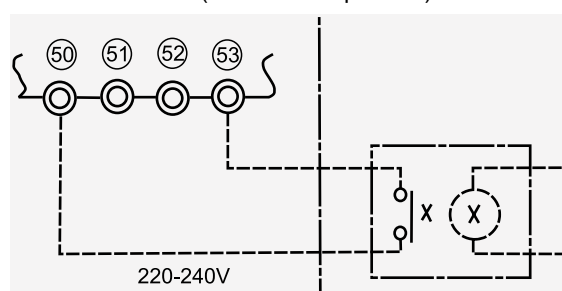

2. Forced capacity control

a) Contents

Compressor operation capacity is set forcibly through customer wiring terminals. Order signal pattern and compressor operation capacity are shown as below.

	Compressor forced operation capacity			Normal operation
	HOLD	LOAD DOWN	LOAD UP	
Xa	ON	ON	OFF	OFF
Xb	ON	OFF	ON	OFF

b) Wiring method (customer wiring terminal)

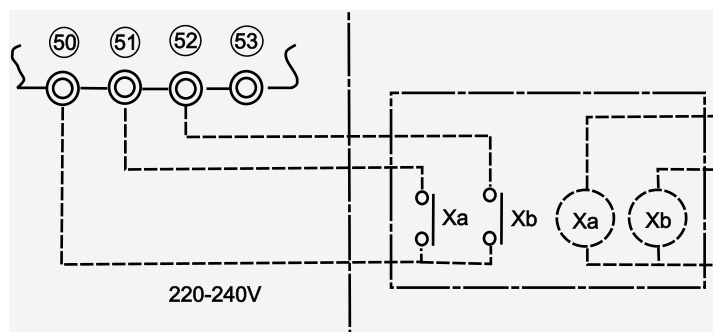

----- : Customer wiring

☛ Second water temperature setting:

4.9. Second water temperature setting

According to the day run / night run or classification of load application, temperature setting can be changed remotely.

Thanks to the two setting temperatures and the two control procedures for water temperature (capacity control and full load or energy storage) these can be combined to have the following possibilities.

- 1) Air-conditioning (capacity control) + Air-conditioning (capacity control)
- 2) Air-conditioning (capacity control) + Heat storage operation (100-0%)
- 3) Heat storage operation (100-0%) + Heat storage operation (100-0%)

Air-conditioning temperature is set by rotary switch on operation PCB and heat storage temperature is set by using “▲ or ▼” switch on indication PCB (7 segment).

◆ Operation mode and setting

	Operation mode	Water temp control	Dip Switch setting	Switch: Air-conditioning/heat storage	Setting water temp	Operation signal
1)	Air-conditioning	Capacity control	-	Air-conditioning/heat storage	Rotary Switch Segment	Local / remote
	Air-conditioning	Capacity control	-			
2)	Air-conditioning	Capacity control	External Thermo	Air-conditioning/heat storage	Rotary Switch Segment	Local / remote
	Heat storage	100-0%	External Thermo			
3)	Heat storage	100-0%	External Thermo	Air-conditioning/heat storage	Rotary Switch Segment	External Thermo
	Heat storage	100-0%	External Thermo			

1. Air-conditioning operation 1 (capacity control) + Air-conditioning operation 2 (capacity control)

The below example: chilled water outlet temperature 7°C and chilled water outlet temperature 10°C in cooling.

◆ Running operation:

- Run/Stop signal is received from local or remote.

a) Dip Switch Setting

It is not necessary. Set it as factory default.

b) Setting of air-conditioning temperature 1

Set chilled water outlet temperature as 7°C.

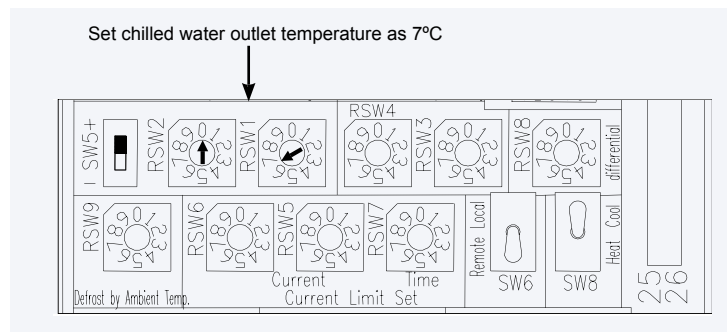

c) Setting of air-conditioning temperature 2

Set chilled water outlet temperature as 10°C using “▲ or ▼” switch on indication PCB. (see item (4) for the setting method)

d) Wiring for switch

Wire as the below figure. Terminal No.23-24 wiring makes 2nd setting temperature valid.

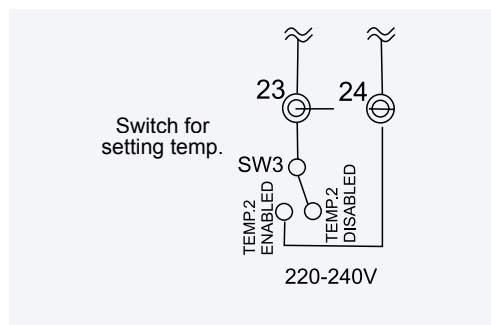

2. Air-conditioning operation (capacity control) + heat storage operation (100-0%)

The below example: chilled water outlet temperature 7°C (capacity control) in cooling and chilled water outlet temperature 10°C in heat storage.

◆ Running operation:

- Run/Stop signal: Local or remote (cooling), external Thermo (heat storage)
- Water temperature is set by air-conditioning / heat storage switch. Air-conditioning / heat storage = Air-conditioning setting water temperature / heat storage setting water temperature.

- In case that operation signal is input in local at heat storage operation, capacity control operation is performed.

a) Dip Switch Setting

In option A, 3 and 4 are ON.

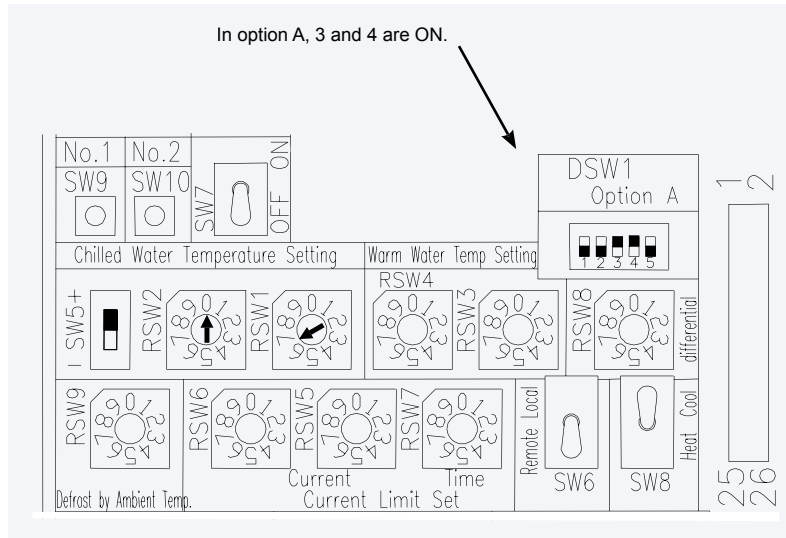

b) Setting of operation PCB of unit body (setting of air-conditioning temperature)

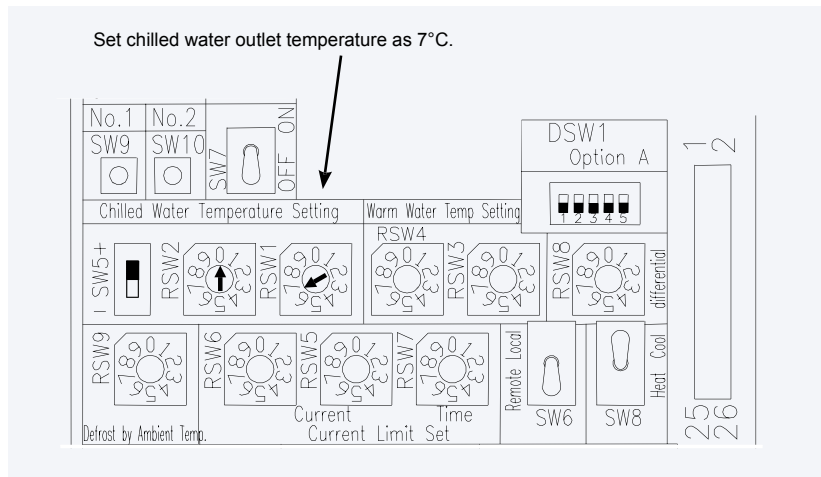

c) Temperature setting by indication PCB

Set chilled water outlet temperature as 10°C using “▲ or ▼” switch on indication PCB.

d) Wiring for the switch and external Thermo contact input

Wire as follows.

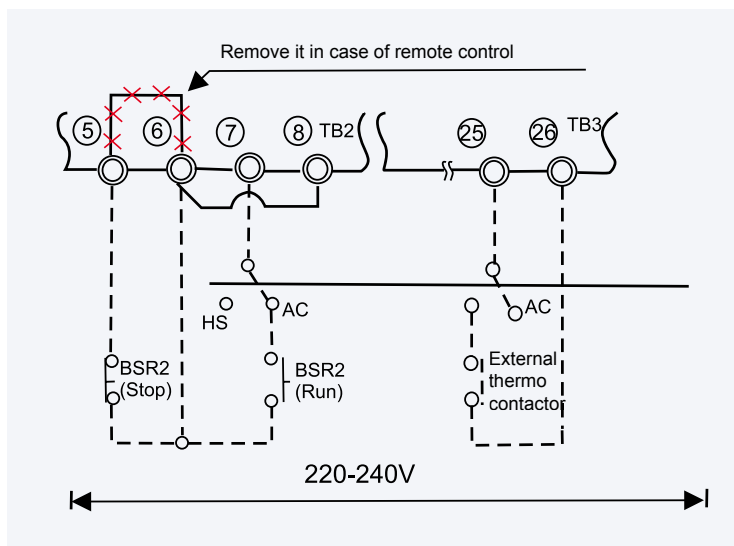

i NOTE:

AC: Air-conditioning
HS: Heat Storage

3. Heat storage operation 1 (100-0%)+ heat storage operation 2 (100-0%)

The below example: chilled water outlet temperature 7°C and chilled water outlet temperature 10°C in cooling.

◆ Running operation

- Run/Stop signal is received from external Thermo contact.
- Water temperature is set by the switch to set the temperature.
- If operation signal is input in local, capacity control operation is performed. Do not connect the wiring for remote operation.

a) Dip Switch Setting

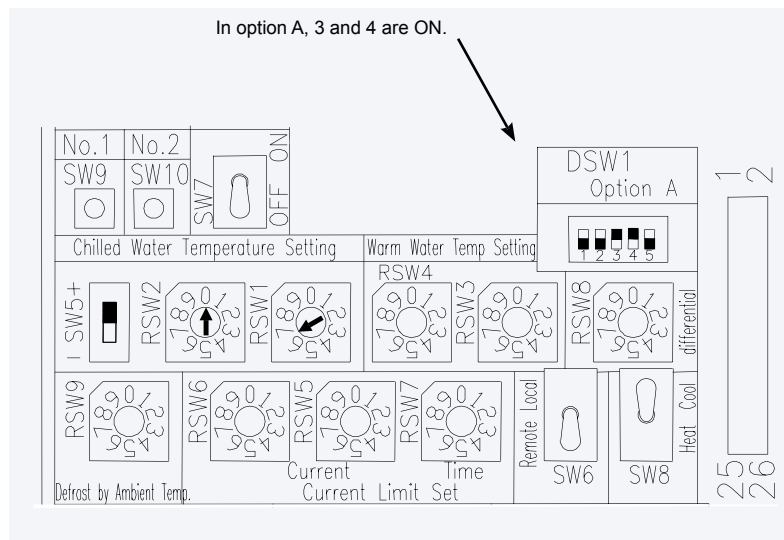

b) Setting of operation PCB of unit body (setting of air-conditioning temperature)

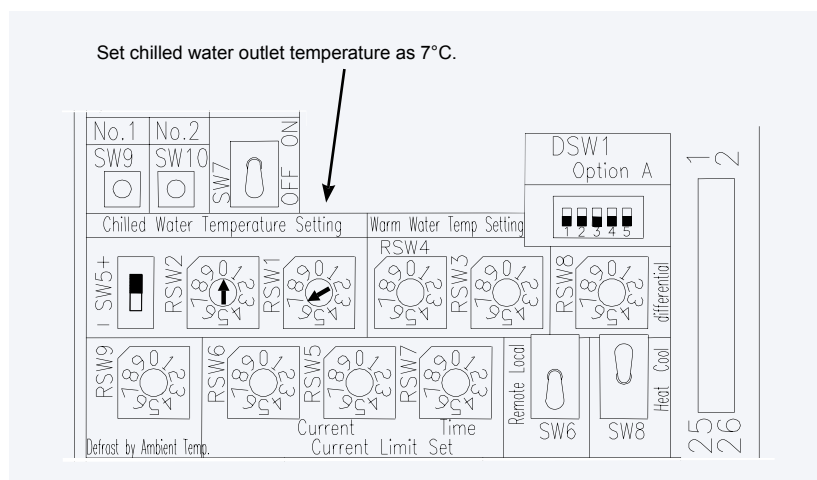

c) Temperature setting by indication PCB

Set chilled water outlet temperature as 10°C using “▲ or ▼” switch on indication PCB.

d) Wiring for the switch and external Thermo contact input

Wire as follows.

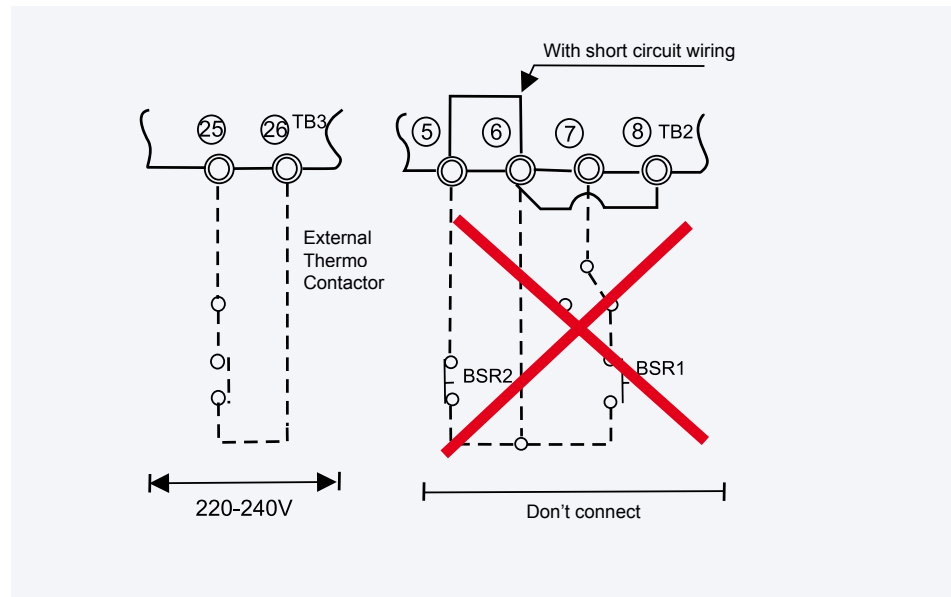
NOTE:

 AC: Air-conditioning
 HS: Heat Storage

4. Setting method of second temperature

Second temperature setting mode is set by pressing “▼” switch for more than 3 sec. on indication PCB with Unit power ON. By pressing “▲ or ▼” switch during this mode, each second temperature of chilled water temperature and warm water temperature is set.

◆ Second temperature set mode

- Press “▼” switch on normal display on 7 segment more than 3 seconds with Unit power ON. Indication of the segment is changed to “tS-Cd” and it is indicated alternatively with actual chilled water second temperature setting value.
- With this status, by pressing “▲ or ▼” switch, indication of the segment is changed to “tS-Hd” and it is indicated alternatively with actual warm water second temperature setting value (heat pump units).
- And, by pressing “▼” switch on indication PCB more than 3 seconds, we return to normal indication display.

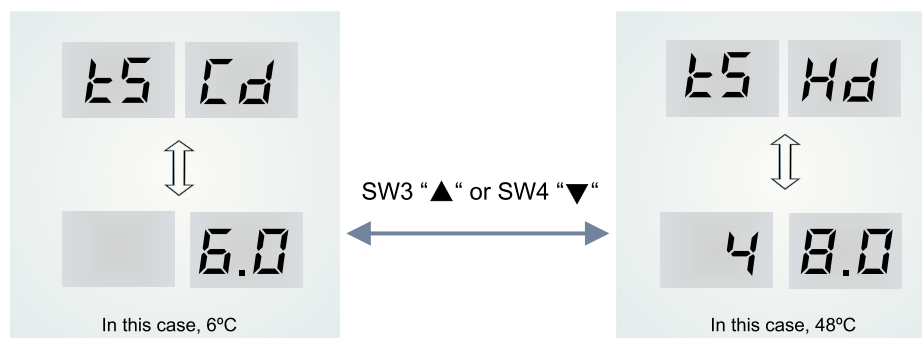

◆ Temperature setting method

The following operation is performed from the status of chilled water second temperature setting value or warm water second temperature setting value. Here, the example of chilled water second temperature setting is shown.

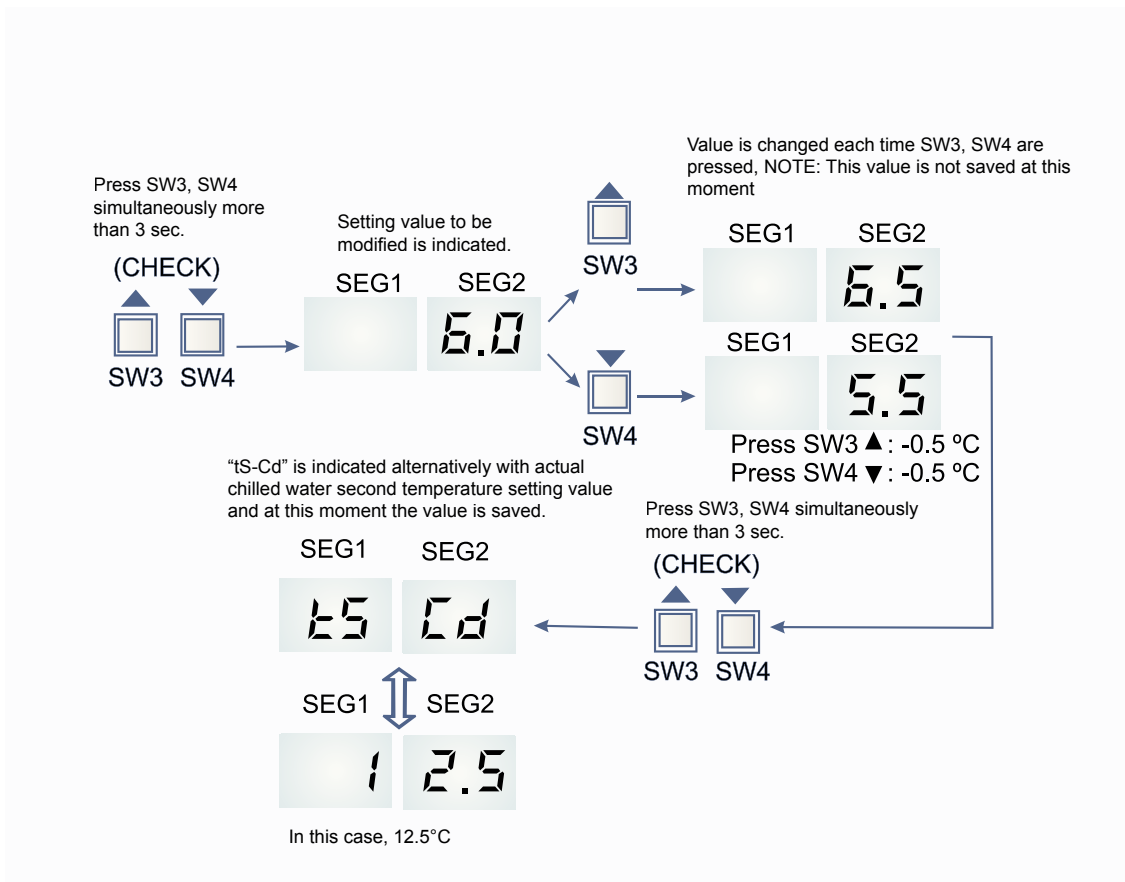

4

4.10. Heat storage operation by external order

Heat storage operation by external order:

1. Operation control

It is a control that runs unit by External Thermostat order. It forces unit to work at full load with no capacity control. (It is valid only at remote setting)

2. Setting method

a) Dip Switch (DSW1) on the PCB_B is set as follows before power ON.

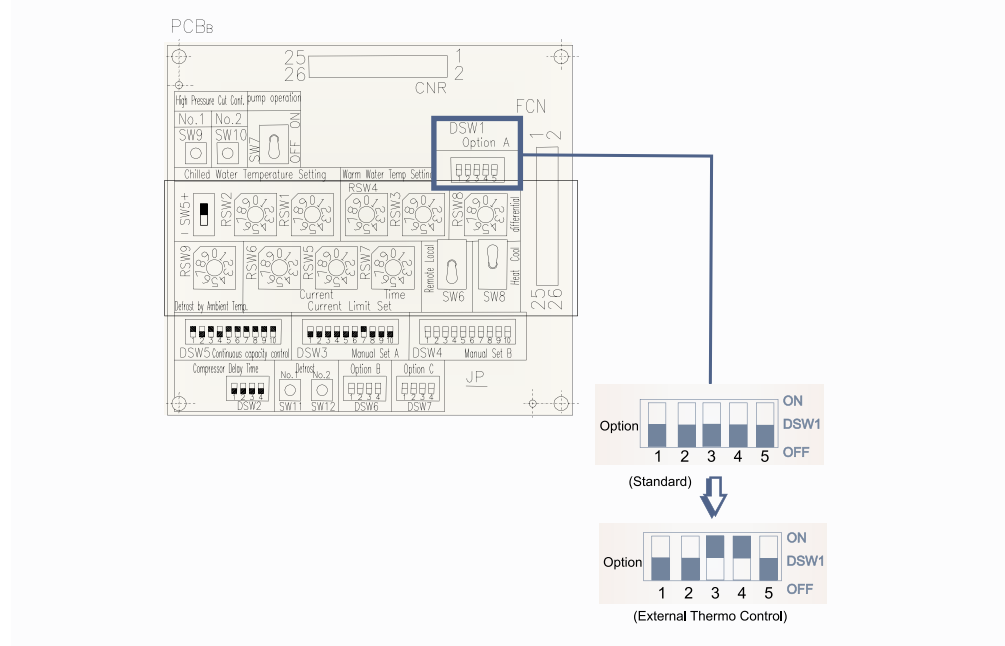

b) Connection to external Thermo

- Connection to Chiller unit is as follows.
- Connect with terminal No. 40, 41 of TB3 within the electrical box.

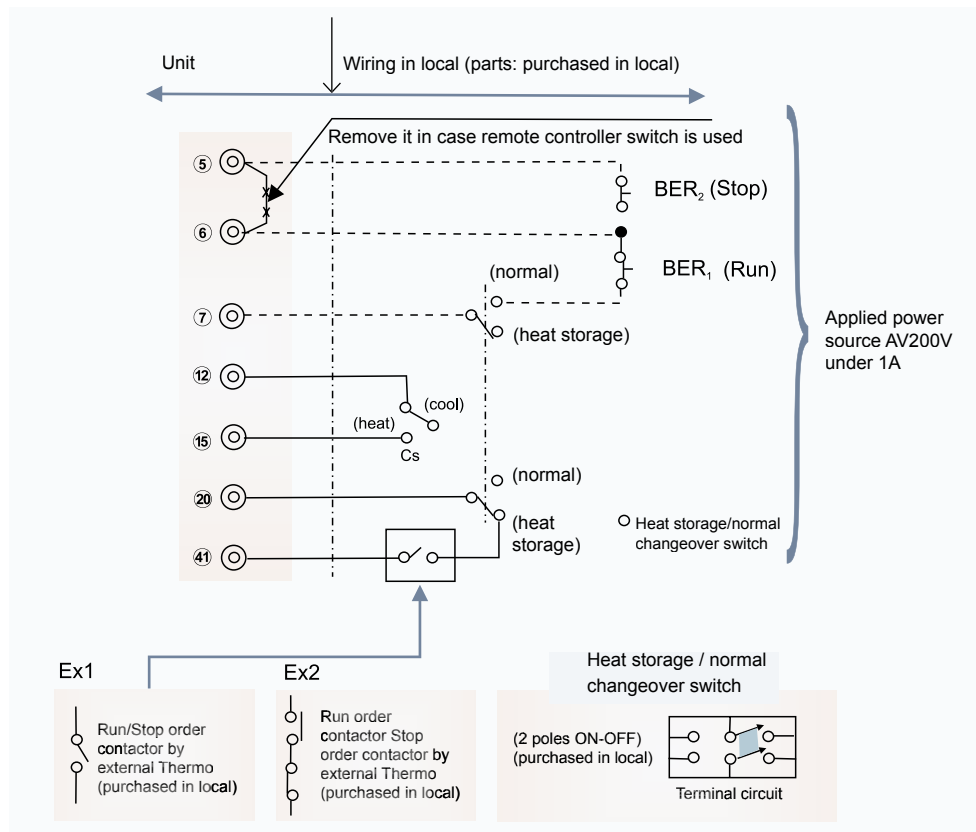

(*) In case of only heat storage operation, wiring of (---) part is not necessary

 **ATTENTION:**

- Dip Switch for this control should be set before power ON.
- Local external Thermo does not run/stop by pulse signal order.
- Normal operation order and heat storage operation order shall be input to Chiller unit separately.
- Local external Thermo order shall have at minimum 5 minutes interval of continuous operation order (5 min in case of stop).
- Additional wiring shall be put into a metal pipe independently, or shield line shall be used.
- During control by external Thermo, Chiller unit stops when water temperature reaches to the setting value of Chiller unit, and automatically starts again. Therefore, set the temperature in external Thermo higher than that of chiller unit.
- If Thermo setting value of body side is set "higher" at cooling and "lower" at heating, unit is stopped earlier than the stop order from external Thermo.
- Switch normal / heat storage operation during unit stop.

4

4.11. Operation by DC24V input (Remote Control)

1. Outline

Operation control by DC24V is explained here.

- Operation signal pattern: 1. Level input, 2. 1 pulse input, 3. 2 pulse input.
- Set as follows and perform additional wiring in each 3 cases.
- This control is not compatible with other remote Run/Stop order.

2. Level input

a) Signal and basic sequence

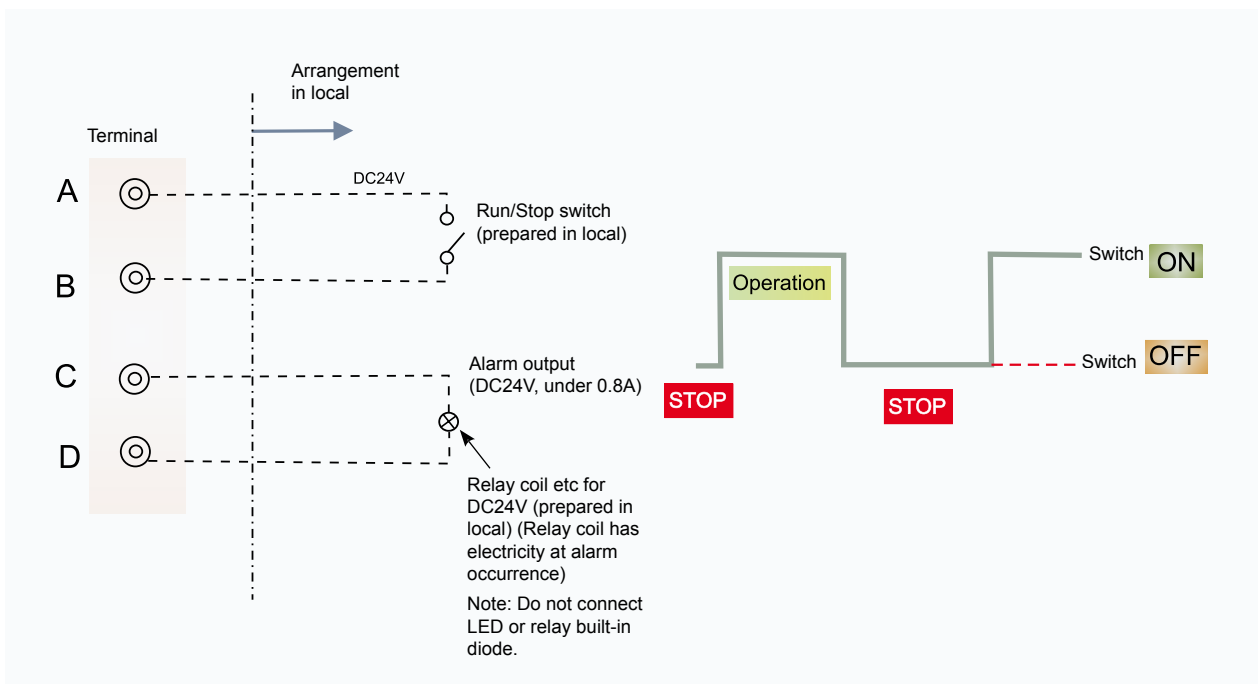

b) Setting method

Dip Switch for optional function setting on PCB_b is set as follows before power ON.

! ATTENTION:

- Additional wiring should not be connected to other operation circuit, especially wiring for 220-240V.
- Additional wiring shall be put into a metal pipe independently or shield line shall be used.

3. Pulse input (I)

a) Signal and basic sequence

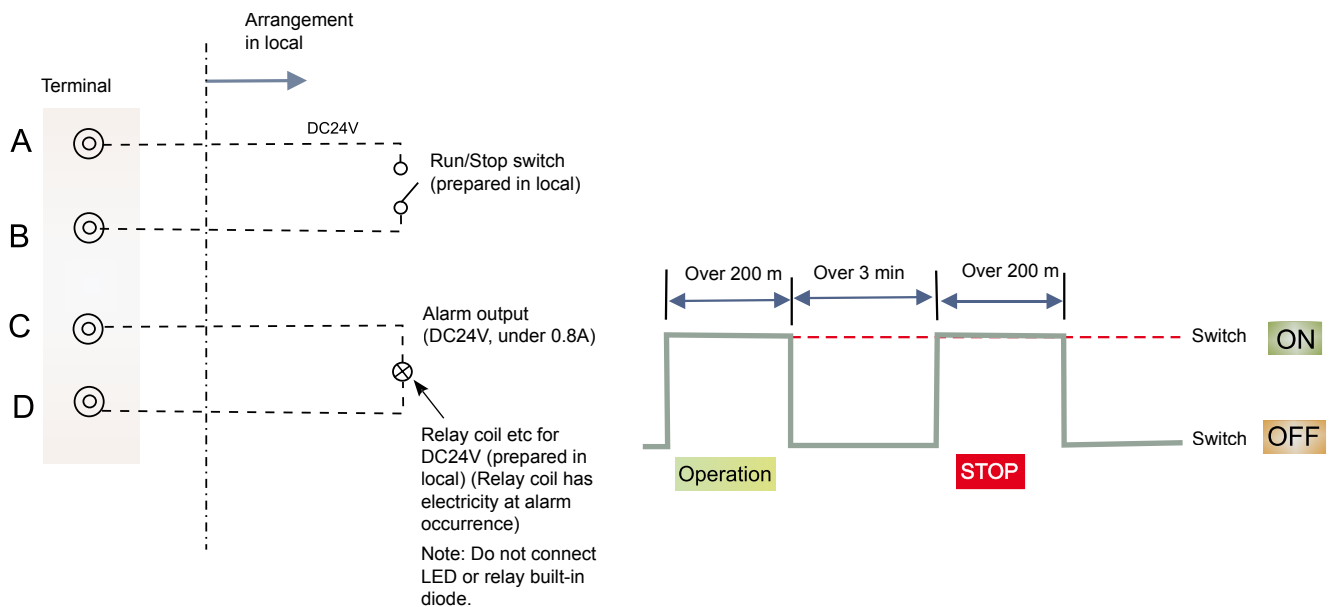

b) Setting method

Dip Switch for optional function setting on PCB_B is set as follows before power ON.

! ATTENTION:

- Additional wiring should not be connected to other operation circuit, especially wiring for 220-240V.
- Additional wiring shall be put into a metal pipe independently or shield line shall be used.

4. Pulse input (II)

a) Signal and basic sequence

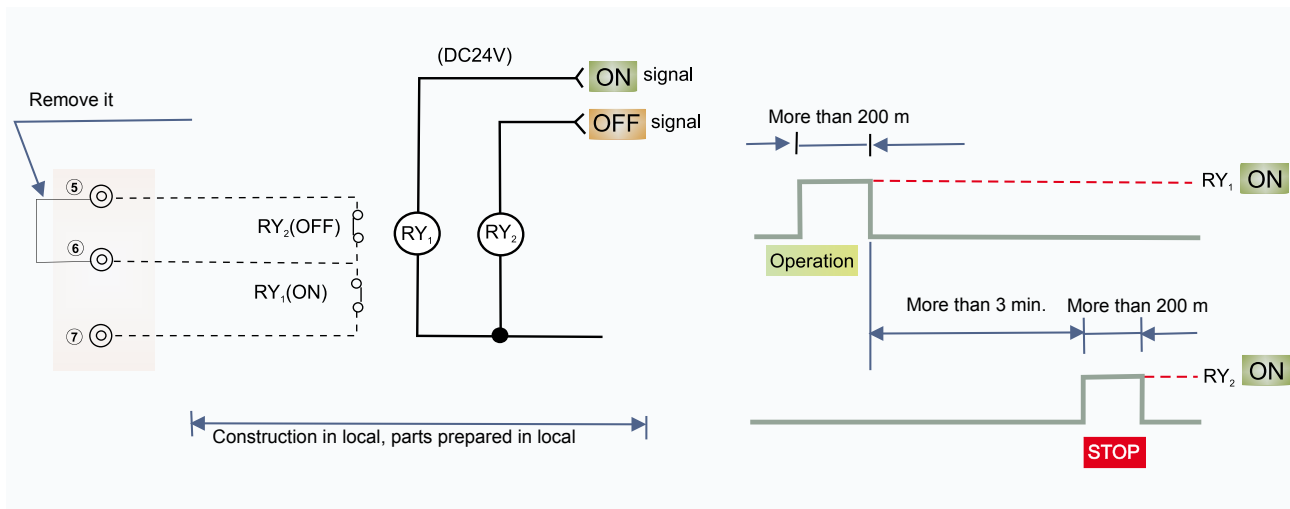

b) Setting method

It is an application of remote control and it is unnecessary to modify the setting of PCB.

! ATTENTION:

- Additional wiring should not be connected to other operation circuit, especially wiring for 220-240V.
- Additional wiring shall be put into a metal pipe independently or shield line shall be used.

4.12. Installation of switch for snow measure (Fan manual operation)

Installation of switch for snow measureHeat storage operation by external order:

If a switch for snow measure is installed, it is connected to terminal #31 and #32 in customer wiring terminals. When the switch is ON, fan is operated during unit stop or Thermo OFF.

However, the fan is not operated in the following cases:

- When local is set
- During alarm occurrence
- When the switch has been ON before power ON (including power failure)
- Fan manual operation is stopped by the stop switch of unit body

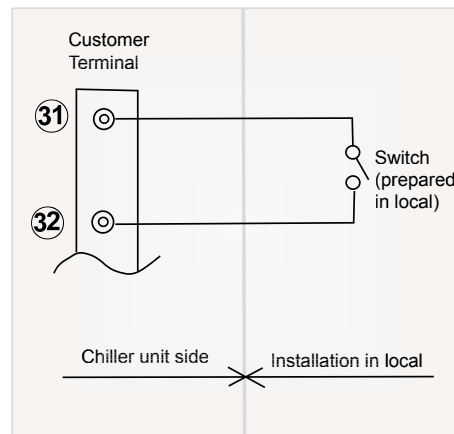

ATTENTION:

- It is possible to insert a automatic contactor like a snow relay in this switch part.
- This switch can be used only at remote control. Pay attention to it at Unit check.
- Once the fan is started-up by this switch, fan continues running at least for 10 minutes if it is not stopped by the switch during this period. (In case of emergency, stop the fan by the stop switch of unit)
- This switch is locally purchased.

4.13. Switch for confirmation of high pressure cut

 Switch for confirmation of high pressure cut



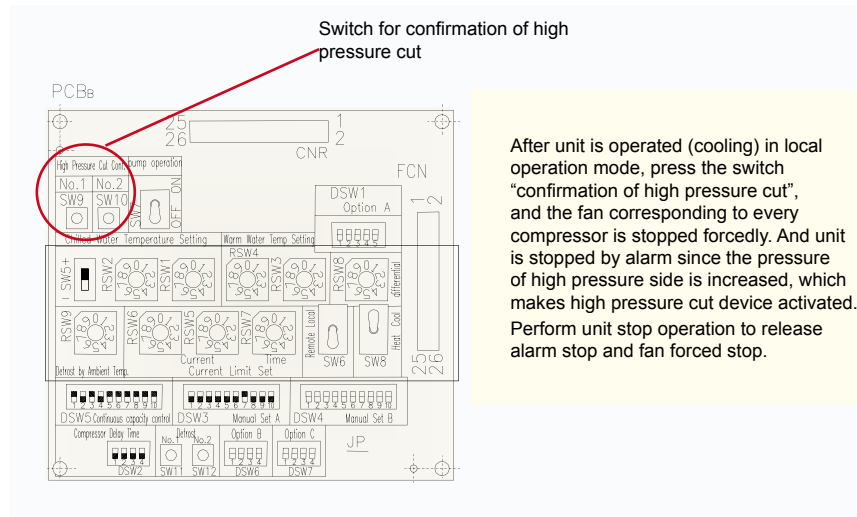

Switching to this test mode makes easy to confirm if the device for cutting high pressure is activated.

◆ Operation method





– To Stop/Start all fans of each cycle follow the below table:

 PCBa1

PCBa1	SW9	SW10
Cycle 1		
Cycle 2		
Cycle 3		

 PCBa2

PCBa2	SW9	SW10
Cycle 4		
Cycle 5		

4.14 Antifreeze control in winter

It happens sometimes that chilled water temperature is decreased so much that heat exchanger of water side or piping system are frozen during operation stop in winter. This control prevents Chiller unit from freezing by operating chilled and warm water circulation pump automatically after detecting ambient and chilled water temperature.

1. Ambient temperature is below 2°C

When ambient temperature is below 2°C, operation order is sent to pump and continuous operation of chilled water circulation pump is started automatically. When chilled water is over 15°C, intermittent operation (5 min of operation and 55 min of stop) is performed.

2. Automatic release of antifreeze control

This operation is released only when ambient temperature is over 4°C.

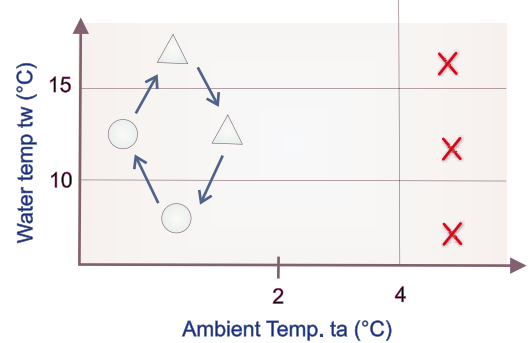
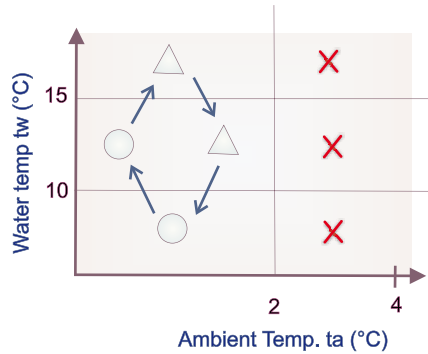
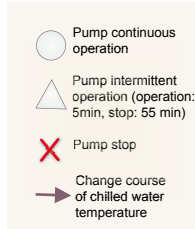

! ATTENTION:

In case that ambient temperature of chilled/warm water circulation system is lower than that of the Unit installation place, Thermostat for ambient temperature shall be introduced in the place with the lowest temperature and shall be connected to pump operation order circuit in parallel.

4.15. Saving energy priority mode, silence priority mode (night shift), only cooling

☞ Saving energy priority mode, silence priority mode (night shift), only cooling.

It is possible to select 3 types of fan control depending on the installation place or use applications

PCBb

DSW2

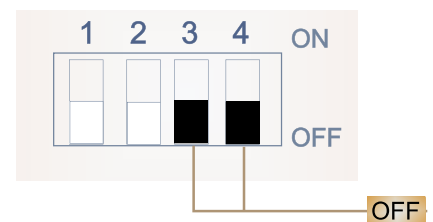

1. Standard mode

- Fan control (revolution number control) suitable to ambient temperature.
- Good balance from the view of saving energy and silence.

2. Saving energy priority mode

- Fan control (revolution number control) tries to keep discharge pressure as low as possible at night or during midterm period.
- Saving energy has the priority to silence.

DSW2

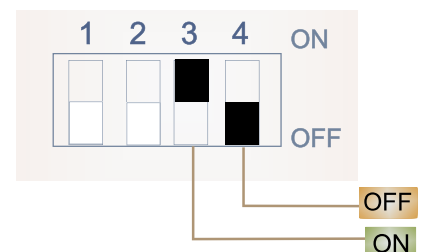

3. Silence priority mode (night shift)

- Smaller revolution number for silence purpose at night or during midterm period.
- Little fan noise mode.

DSW2

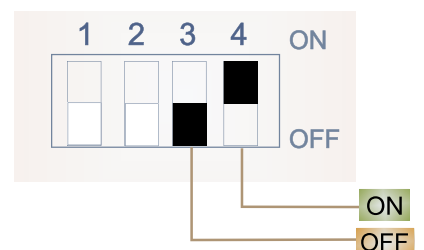

Silence priority mode is valid by a no-voltage contactor input in Dip Switch setting of Standard mode or Saving energy priority mode, therefore, such changeover as saving energy mode in daytime and silence priority mode at night can be performed from remote controller.

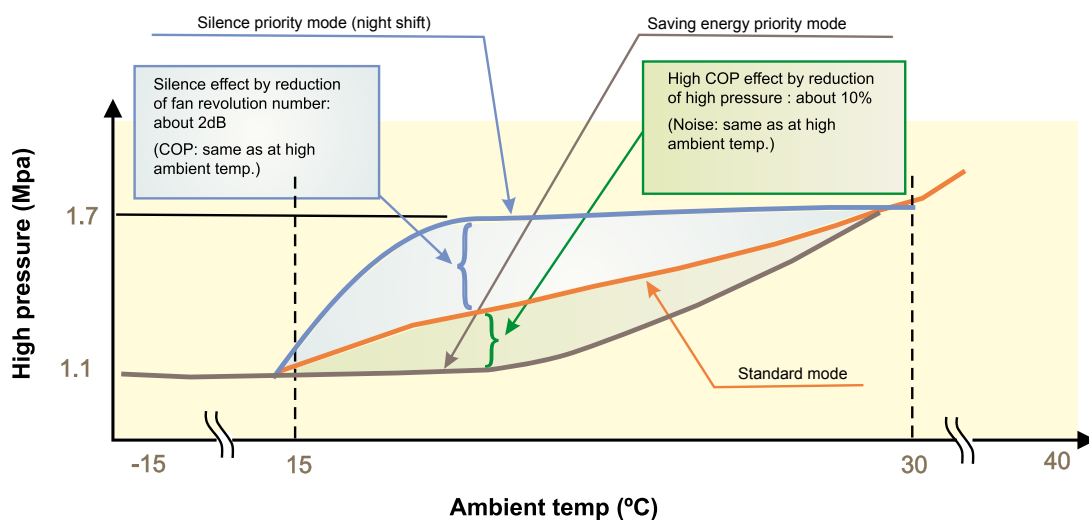
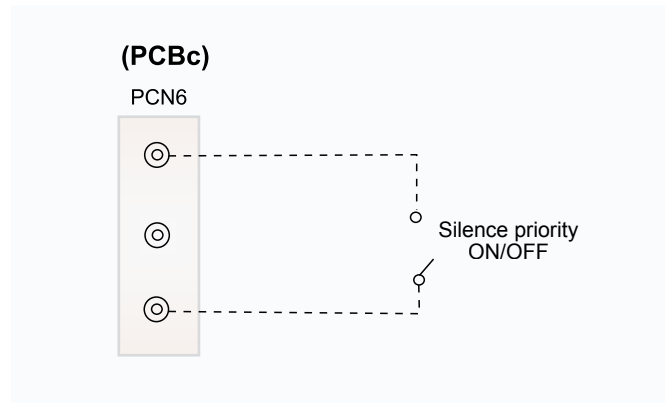

i NOTE:

The above figure is an image, and the real effect differs from temperature condition.

☛ Defrost (only air-cooled heat pump type)

4.16. Defrost (only air-cooled heat pump type)

Ambient temperature, evaporating temperature and evaporating pressure are detected during heat operation to detect the frost volume. By the changeover of 4 way valve, reverse-cycle defrosting is performed.

◆ Defrosting start conditions

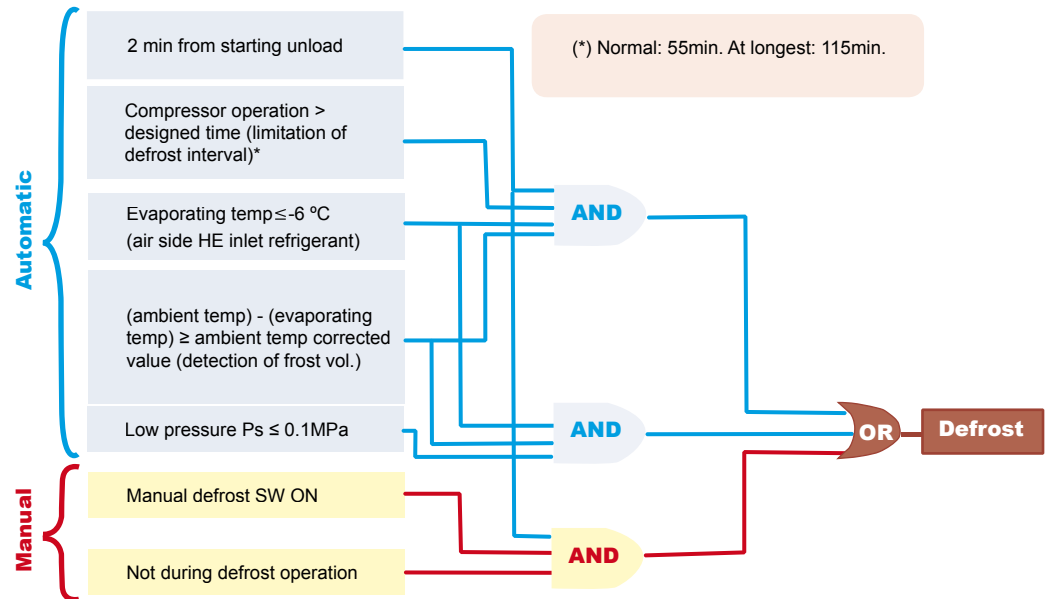

- Defrosting is performed for 6 minutes at longest. (automatic stop when all frost is taken out).
- In case that all frost is taken out very quickly, the period till next frost is extended automatically in order to avoid too much defrost.
- Warm water outlet temperature is lower than inlet temperature due to the reverse cycle defrost.

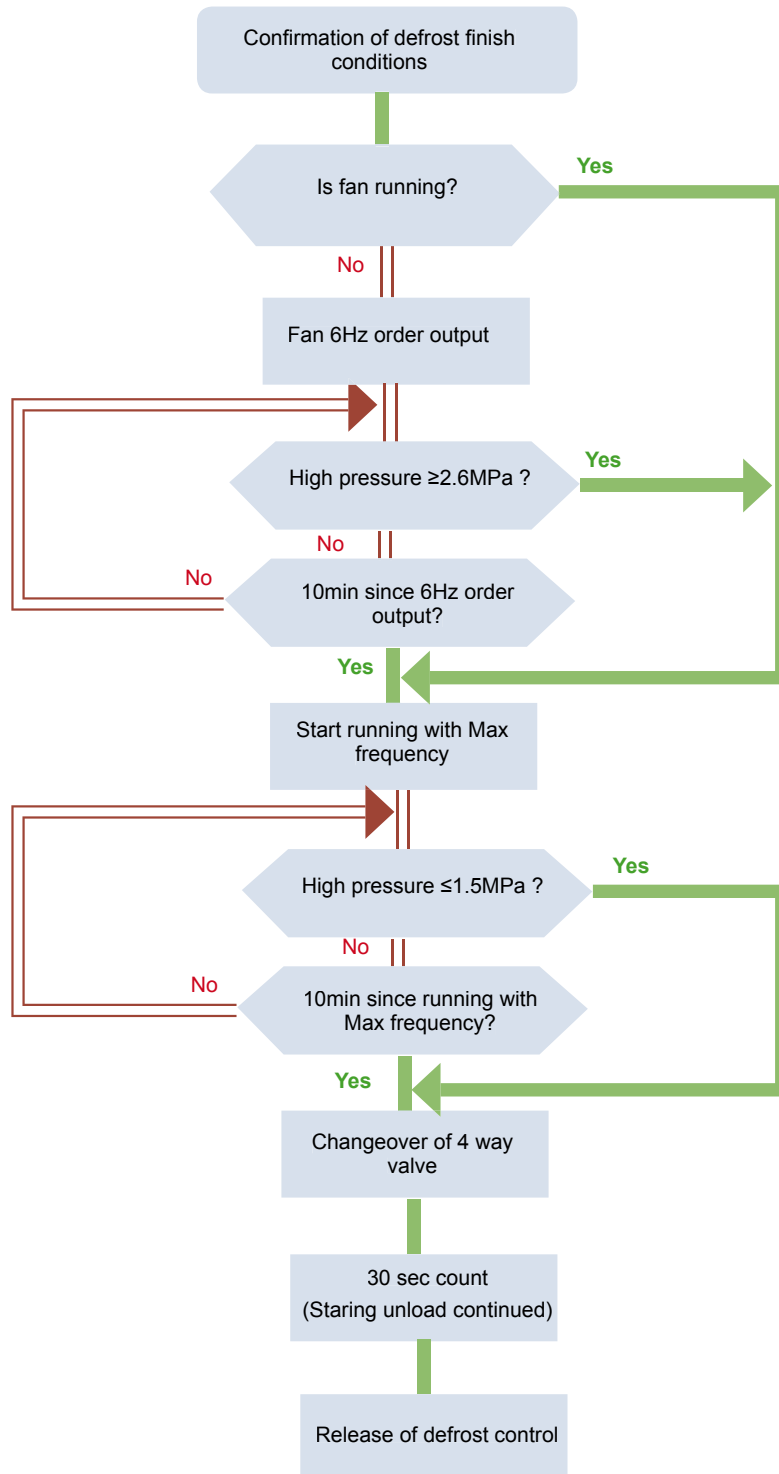

Thermo off selection function

4.17. Thermo off selection function

It is a function to prevent the Chiller unit from going Thermo OFF due to a sudden change of temperature or flow volume (inverter water pumps). It is possible to select it by DSW7-pin 3 on operation PCB. Standard is set at delivery.

1. Standard setting

PCBc

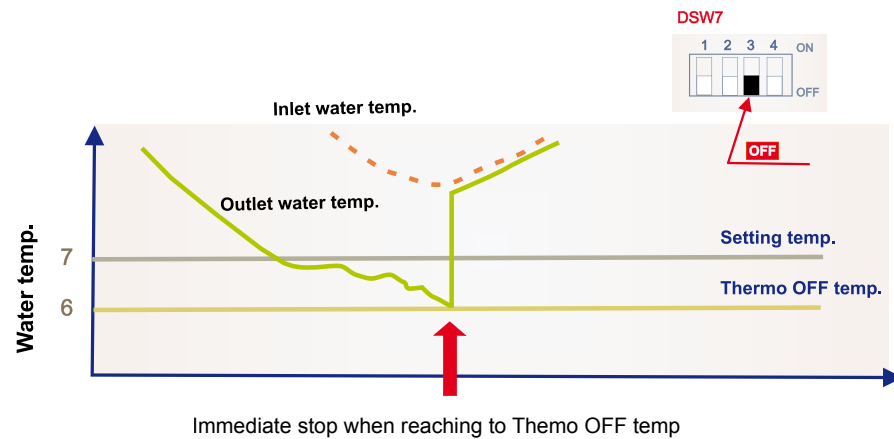

Standard setting

2. Setting to continue Thermo OFF temperature for a certain period

Setting to continue Thermo OFF temperature

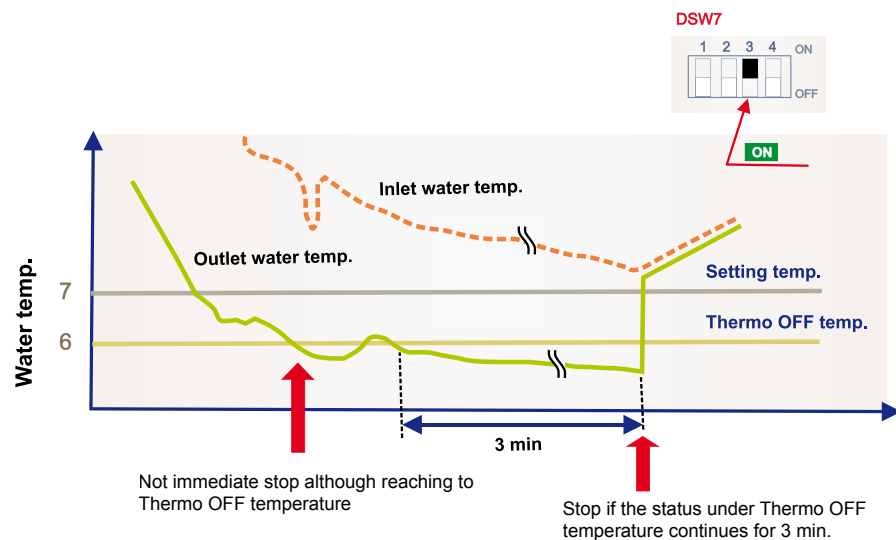

i NOTE:

However, it becomes Thermo OFF immediately once outlet water temperature is decreased until protection values

4.17.1 Fan Control

1. Cooling operation

In this series, fan speed is controlled by inverters and adjusts depending on discharge pressure. Target high pressure is set based on the ambient temperature, and revolution number is increased / decreased by PID control. The unit number is not changed.

Inverter output Max Frequency

Max Frequency: 66

Min Frequency: 10

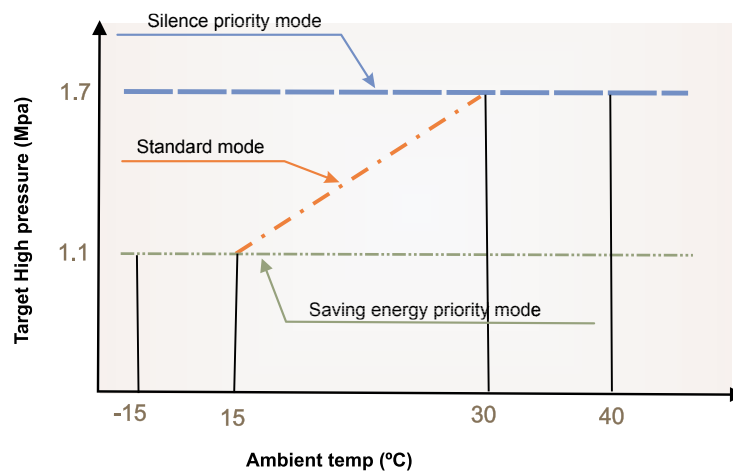

Fan control imaged figure

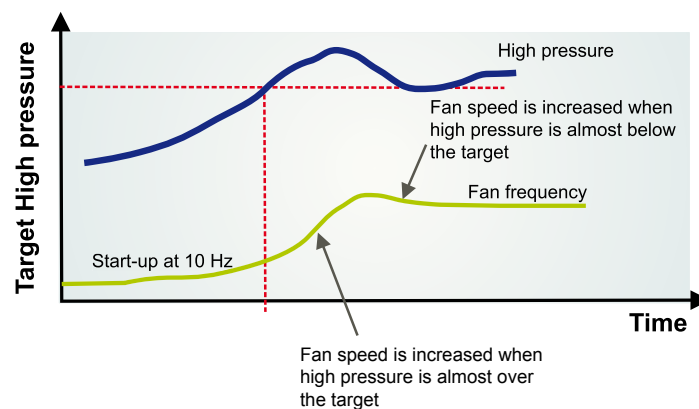

- Recalculation of fan speed is done every 10 sec.
- Calculation is not performed when high pressure target value is within ± 0.1 MPa.
- The following control is performed in case of sudden change.

Prevention of high pressure excess increase

- Discharge pressure $\geq 2.2\text{MPa}$ → out put +10Hz
- Discharge pressure $\geq 2.5\text{MPa}$ → out put max. frequency

Prevention of high pressure excess decrease

- Discharge pressure $\leq 0.9\text{MPa}$ → out put -10Hz
- Discharge pressure $\leq 0.8\text{MPa}$ → out put min. frequency

2. Heating operation

Basically unit is operated with Max frequency, but under the following conditions revolution number control is performed.

Prevention of low pressure excess increase

Fan speed control is activated if "suction pressure $\geq 0.6\text{MPa}$ " and "ambient temperature $\geq 25^\circ\text{C}$ "
*Released at ambient temperature $\leq 20^\circ\text{C}$

4.17.2 Electronic expansion valve

Model of expansion valve

Model: MKV-1610D-Q5

Refrigerant: R407C

Parts No.: C4340

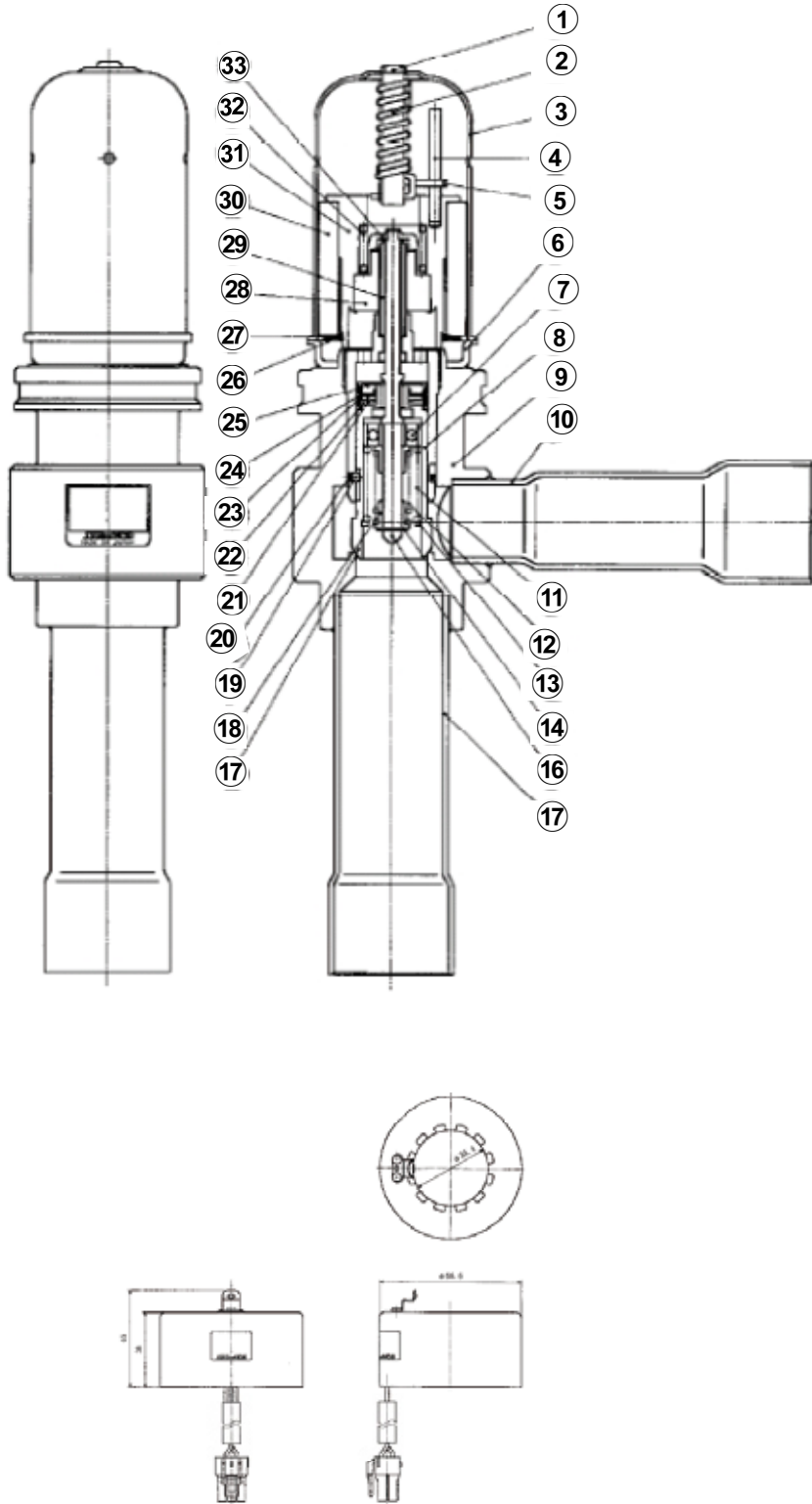

N°	Name	Qty.	Material
①	Stem	1	SUS303
②	Guide	1	SUS304
③	Case	1	SUS305
④	Spring Pin	1	SUS420
⑤	Slider	1	SUS304
⑥	Under cover	1	SUS304
⑦	Bear ring	1	SUS440C
⑧	Guide	1	C3771
⑨	Body	1	C3771
⑩	Copper union (side)	1	C1220
⑪	Coil spring A	1	SUS304
⑫	Coil spring B	1	SUS304
⑬	Snap ring B	1	S65CM
⑭	Snap Ring C	1	SUS304
⑮	Connection lot	1	SUS303
⑯	Copper union (under)	1	C1220
⑰	Needle	1	SUS303
⑱	Collar	2	C3604
⑲	Ball	1	SUS440C
⑳	Ring spring	1	SUS304
㉑	Disk spring	1	SUS304
㉒	Leaf spring tray	1	C3604
㉓	Leaf spring	2	SUS304
㉔	Piston	2	PTFE
㉕	Piston cylinder	1	SUS303
㉖	Snap Ring A	1	SK-5M
㉗	Wave spring washer	2	S65M
㉘	Female	1	Cu alloy
㉙	Male	1	SUS303
㉚	Magnet	1	Ferrite
㉛	Connection fitting	1	A6D61
㉜	Coil spring C	1	SUS304
㉝	Fixing bracket	1	SUS303

In this series, electronic expansion valve is used. Electronic expansion valve is consisted in the body (figure), Coil, and PCB for expansion valve running (PCB_G (VD PCB)).

1. The range of opening of expansion valve

The opening of expansion valve is managed by pulse number. The range is 116~656 pulse. During stop, it is stand-by with 10 pulse.

2. PCB for expansion valve running

PCB_G (VD PCB) is used. The pulse number of the opening of expansion valve is indicated in the segment on VD PCB.

3. Zero point adjustment

Zero point is adjusted by initialization at power ON. The order of opening of expansion valve is closed fully (less than 0 pulse) and both control pulse number recognized in micro computer and real pulse number are adjusted to zero. During this adjustment, "Cn-Eo" is indicated in the segment. (n= Unit No.)

Zero point adjustment is also performed " at the first compressor stop after 24 hours since the last zero point adjustment"., to modify the error between control pulse number and real pulse number. If compressor has not stopped for over 200 hours, compressor is to be stopped forcedly (forced Thermo OFF) and zero point is adjusted. Then, unit is re-started after 3 minutes guards. It is possible to cancel this forced zero point adjustment by Dip Switch selection on expansion valve PCB.

4. During normal operation

Temperature of compressor suction gas superheat is calculated from the temperature detected by Thermistor of compressor suction refrigerant gas and the pressure detected by the sensor for suction pressure, and the opening is determined by calculation value to reach target superheat. (Control cycle: 28 seconds)

5. Prevention control for discharge refrigerant gas overheat

When discharge gas refrigerant temperature is over 100°C, expansion valve is opened forcedly and excess increase of discharge gas refrigerant temperature is prevented. (Td control).

6. Prevention control for freezing

If it is detected that refrigerant inlet temperature of water side heat exchanger is decreased, expansion valve shall be open so that decrease of refrigerant temperature is prevented, which leads to anti-freeze in the water side heat exchanger.

a) Normal Control

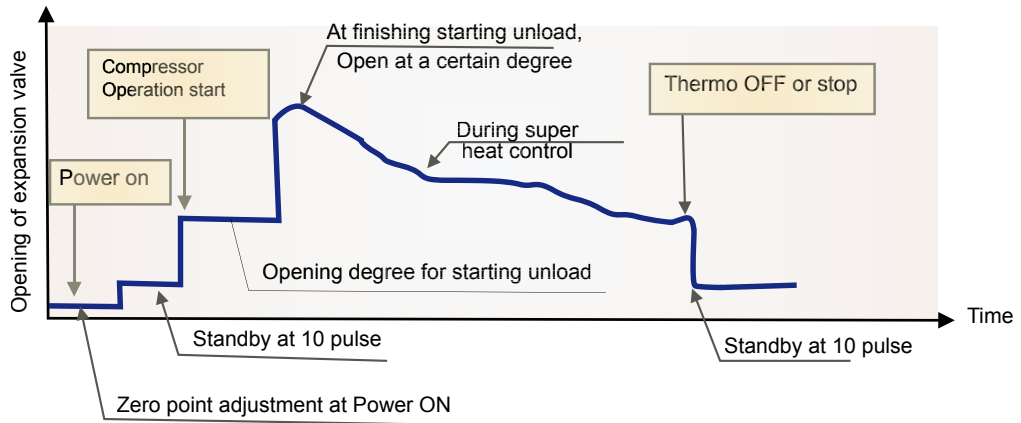

b) Zero Point Adjustment (imaged figure)

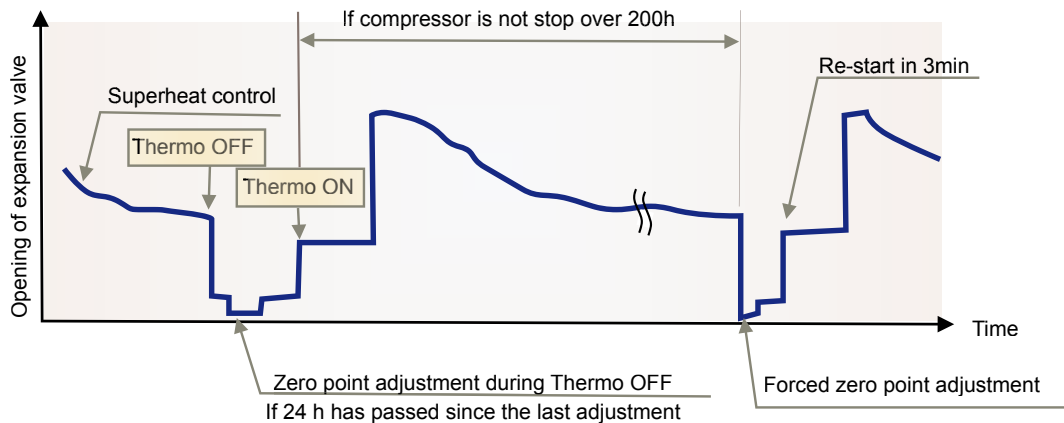

c) Prevention Control for Discharge Refrigerant Gas Overheat (imaged figure)

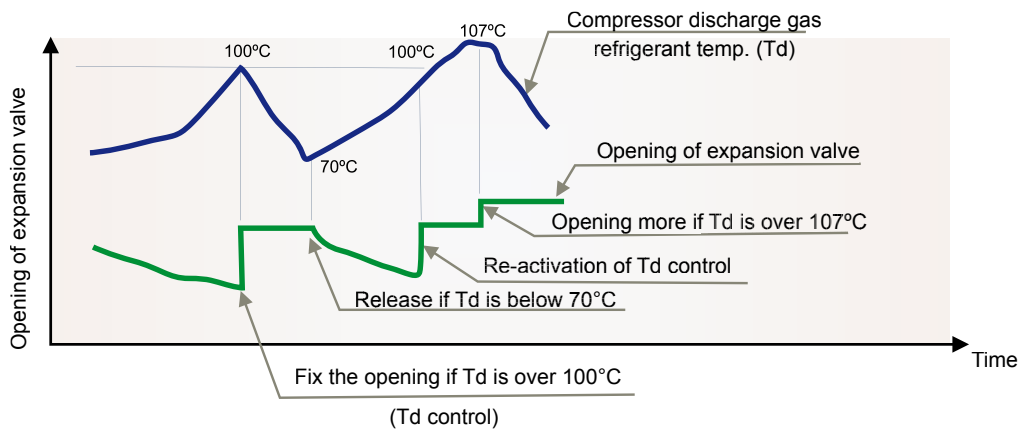

4.17.3. Protection Controls

This series has a protection control to resolve abnormal status before reaching to the alarm status, occurrence.

Control Name	Conditions	Contents	Release conditions
High pressure protection	High pressure $\geq 2.6\text{MPa}$	Hold after load-down 10 second output	30 min and High pressure $< 2.5\text{MPa}$
Low pressure protection (1) <COOLING>	Cooling only: Low pressure $\leq 0.333\text{MPa}$ Heating: Low pressure $\leq 0.314\text{MPa}$	When it is continued for 1 min, hold after load-down 10 second output	10 min and --Cooling only: Low pressure $\geq 0.363\text{MPa}$
Low pressure protection (2) <COOLING>	Cooling only: Low pressure $\leq 0.333\text{MPa}$ Heating: Low pressure $\leq 0.314\text{MPa}$ 90 sec	-Compressor stop: retry code [Cn-P6] -Re-start in 3 min (alarm: 3 times in 30min)	-
Protection of overheat of discharge gas temperature	Discharge gas refrigerant temp $\geq 130^{\circ}\text{C}$ 1min	-Compressor stop: retry code [Cn-P5] -Re-start in 3 min (alarm: 3 times in 90min)	-
Prevention of overheat of compressor	Actuation of internal Thermo of motor for compressor	-Compressor stop: retry code [Cn-P5] -Re-start at internal Thermo restart (alarm: 3 times in 60min)	-
Prevention of decrease of evaporating temperature (1) <COOLING>	Inlet refrigerant temperature of water side heat exchanger $\leq -4.5^{\circ}\text{C}$ 3 sec	-output of fan inverter frequency 6Hz -Fan inverter frequency is 20Hz at high pressure $\geq 1.8\text{MPa}$	30 min or high pressure $\geq 2.0\text{MPa}$ during fan is fixed at 20Hz
Prevention of decrease of evaporating temperature (2) <COOLING>	Inlet refrigerant temperature of water side heat exchanger $\leq -5.5^{\circ}\text{C}$ 10 sec	Hold after output of load-up 10 second	30 min
Prevention of decrease of evaporating temperature (3) <COOLING>	Inlet refrigerant temperature of water side heat exchanger $\leq -6.5^{\circ}\text{C}$ 3 sec	-Compressor stop: retry code [Cn-P6] -Re-start in 3 min (alarm: 3 times in 30min)	
Anti-freezing (1) <COOLING>	Suction refrigerant gas temperature $\leq -2^{\circ}\text{C}$ 10 sec	-Compressor stop: retry code [Cn-P6] -Re-start in 3 min (alarm: 3 times in 30min)	-
Anti-freezing (2) <COOLING>	Chilled water outlet temperature $\leq 2.5^{\circ}\text{C}$	Hold after output of load-down 10 second	30 min
Protection of pressure difference	High pressure – low pressure $\leq 0.3\text{MPa}$	Hold after output of load-up 12 second	High pressure – low pressure $> 0.3\text{MPa}$ 1min
Prevention of excess increase of warm water temperature <Compressor Stop>	Warm water temperature $\geq 65^{\circ}\text{C}$	-Pump stop -Alarm output -[PU-PU] is flickering in the segment	Warm water temperature $< 60^{\circ}\text{C}$ (Automatic release of alarm)

5. Troubleshooting

Content

5.	Troubleshooting.....	83
5.1.	Initial check.....	84
5.1.1.	Check of power supply and connection	84
5.1.2.	Check on PCB.....	85
5.1.3.	Confirmation of activation value of protection device an Automatic operation device	96
5.1.4.	Individual indication for activation of protection device	97
5.1.5.	Modification of PCB _C configuration.....	100
5.1.6.	Check function	104
5.2.	Troubleshooting.....	108
5.2.1.	Outline of failure diagnosis.....	108
5.2.2.	Alarm indication.....	109
5.2.3.	Failure diagnosis method.....	111
5.3.	Analysis and countermeasure of abnormal running	141
5.4.	Thermistor characteristics	145
5.4.1.	Thermistor temperature characteristics (All temperature except discharge gas).....	145
5.4.2.	Thermistor temperature characteristics (Ambient).....	146
5.4.3.	Thermistor temperature characteristics (Discharge gas temperature).....	147

5.1. Initial check

5.1.1. Check of power supply and connection

In case of abnormality in Chiller unit, check the following items firstly.

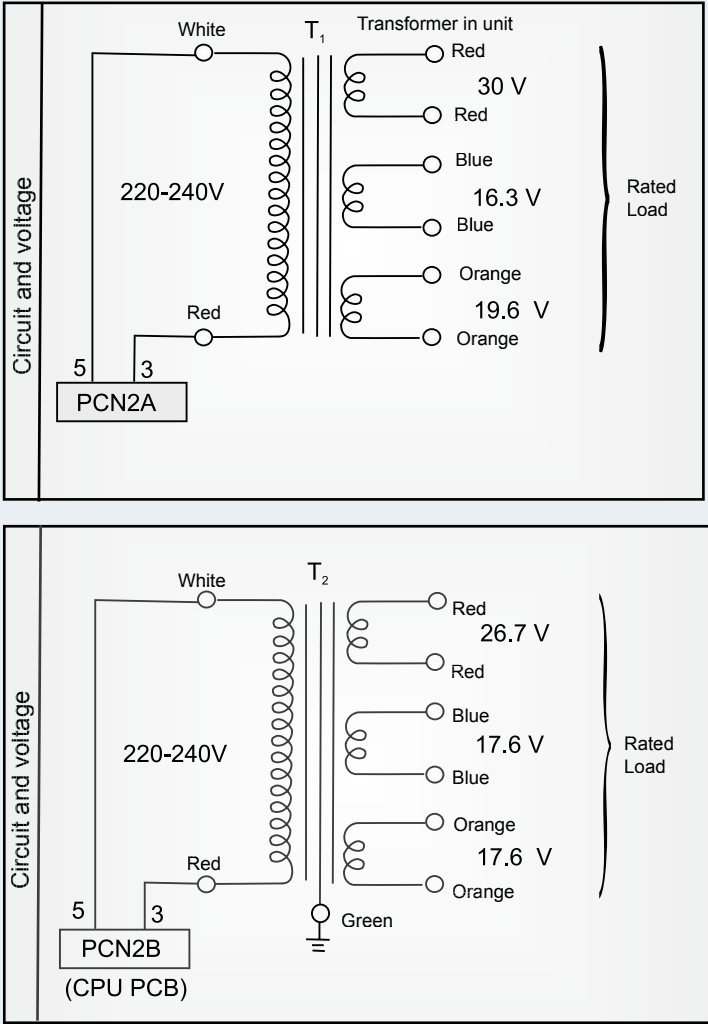
N°	Check Item	Check Method
1	Is power supply or fuse broken?	Measure secondary voltage of breaker and current carrying of fuse by tester.
2	Does secondary power of transformer supply correctly?	<p>Pull out the connection of secondary side in Transformer and measure the voltage by tester. Confirm if the voltage corresponds to the indication in Transformer.</p> 
3	Wiring loose? Wrong wiring?	<p>Confirm if wiring is not loose nor wiring is wrong referring to the electricity circuit.</p> <ul style="list-style-type: none"> - Insertion of connector of Thermistor or Compressor Sensor - Insertion of connector of Flat Cable - Insertion of connector of Transformer Connector - Insertion of each connector in 200V circuit.

5.1.2. Check on PCB

Configuration for standard version. Standard values are the ones shown on PCB drawing and table below.

◆ **PCB_{B1} (RHUE40~400 AG2)**

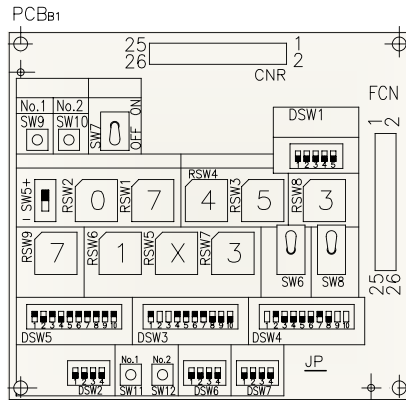

MODEL	DSW3	DSW4	RSW5
RHUE40AG2			RSW5 2
RHUE50AG2			RSW5 3
RHUE60AG2			RSW5 5
RHUE70AG2			RSW5 6
RHUE80AG2			RSW5 7
RHUE100AG2			RSW5 3
RHUE120AG2			RSW5 5
RHUE140AG2			RSW5 6
RHUE160AG2			RSW5 7
RHUE180AG2			RSW5 5
RHUE210AG2			RSW5 6
RHUE240AG2			RSW5 7

◆ PCB_{B1} (RCUE40~400 AG2)

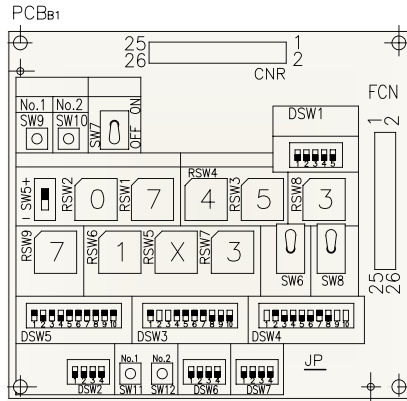

MODEL	DSW3	DSW4	RSW5
RCUE40AG2			RSW5 2
RCUE50AG2			RSW5 3
RCUE60AG2			RSW5 5
RCUE70AG2			RSW5 6
RCUE80AG2			RSW5 7
RCUE100AG2			RSW5 3
RCUE120AG2			RSW5 5
RCUE140AG2			RSW5 6
RCUE160AG2			RSW5 7
RCUE180AG2			RSW5 5
RCUE210AG2			RSW5 6
RCUE240AG2			RSW5 7
RCUE280AG2			RSW5 6
RCUE320AG2			RSW5 7
RCUE350AG2			RSW5 6
RCUE400AG2			RSW5 7

◆ PCB_{B2} (RCUE280~400 AG2)

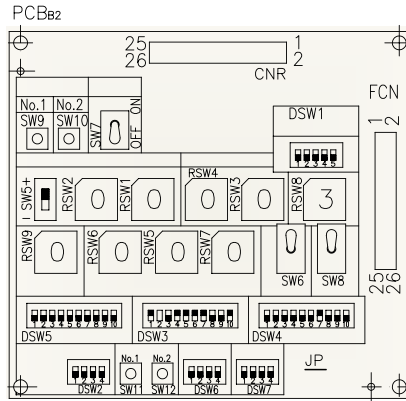

MODEL	DSW3	DSW4	RSW5
RCUE40AG2			RSW5 2
RCUE50AG2			RSW5 3
RCUE60AG2			RSW5 5
RCUE70AG2			RSW5 6
RCUE80AG2			RSW5 7
RCUE100AG2			RSW5 3
RCUE120AG2			RSW5 5
RCUE140AG2			RSW5 6
RCUE160AG2			RSW5 7
RCUE180AG2			RSW5 5
RCUE210AG2			RSW5 6
RCUE240AG2			RSW5 7
RCUE280AG2			RSW5 6
RCUE320AG2			RSW5 7
RCUE350AG2			RSW5 6
RCUE400AG2			RSW5 7

◆ DESCRIPTION:

- **PCB_{B1} DSW1: Setting of Low Voltage for Remote Control**
(PCB_{B2} DSW1: No function)

MODE	Dip Switch Setting (DSW1 of Main PCB)
NORMAL MODE (Now low voltage control)	
MODE 1 (Hi/Lo)	
MODE 2 (Pulse)	

- **PCB_{B1} DSW2: Starting Delay**
(PCB_{B2} DSW2: No function)
DSW2-1,2: Setting for Starting Delay of Compressor [min]

Figure	1	2	1	2	1	2		
Location	ON	ON	ON	OFF	OFF	ON	OFF	OFF
Time (minute)	0.5		6		10		3	

DSW2-3: ON; Low noise and night shift Opt.
DSW2-4: ON: High Efficiency Opt.

- **PCB_{B1,B2} DSW3: Mode Switch A**

DSW3-1,2,3: Enable of compressor No.1,2,3 (PCB_{B1})
DSW3-1,2: Enable of compressor No.4,5 (PCB_{B2})
DSW3-4,5,6,7: Enable of DC Fan Motor No.11,12,13,14 – Cycle N°1 (PCB_{B1})
DSW3-4,5,6,7: Enable of DC Fan Motor No.41,42,43,44 – Cycle N°4 (PCB_{B2})
DSW3-8,9,10: H-LINK ADDRESS [000 by default on PCB_{B1}];
Use same address in PCB_{G1,G2} (DSW4-1,2,3)
DSW3-8,9,10: H-LINK ADDRESS [001 by default PCB_{B2}];
Use same address in PCB_{G3} (DSW4-1,2,3)

- PCB_{B1} DSW4: **Optional Function A**
(PCB_{B2} DSW4: **No function except DSW4-7 in ON: HAPE CHILLER**)

DSW4-1: OFF for RCUEXXXAG2 models
ON for RHUEXXXAG2 models

DSW4-2,7: ON / DSW4-3,4,5,6,8: OFF ; Configuration for HAPE Chillers

DSW4-3: ON: Not Available Option

DSW4-4: ON; Enable of Brine Option

DSW4-9,10: Compressor Model

Figure	9	10	9	10	9	10	9	10
Location	OFF	ON	ON	OFF	ON	ON	OFF	OFF
Compressor	40 HP		40 HP		50 HP		60 HP	
Time (minute)	40 HP		50 HP		60 HP		70,80 HP	

- PCB_{B1} DSW5: Continuous Capacity Control
(PCB_{B2}: **No function**)

DSW5-1,2: Temperature band for Thermo OFF

Figure	1	2	1	2	1	2	1	2
Location	ON	ON	ON	OFF	OFF	ON	OFF	OFF
Band (degree)	0.5		1.0		1.5		2.0	

DSW5-3,4: Temperature band for Compressor re-start

Figure	3	4	3	4	3	4	3	4
Location	ON	ON	ON	OFF	OFF	ON	OFF	OFF
Band (degree)	1.0		2.0		3.0		4.0	

DSW5-5: Temperature band for LOAD UP2

Figure	5	5
Location	ON	OFF
Band (degree)	1.0	3.0

This chart is based on a Temp. Setting of 7°C

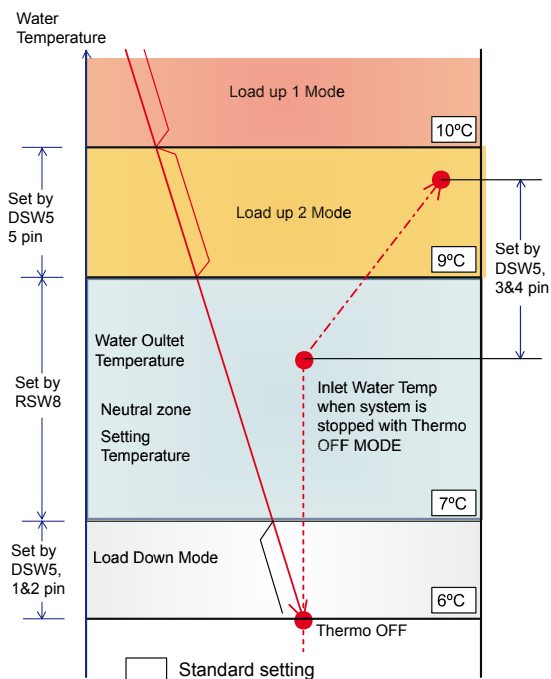

- **DSW5-6: Pulse width in Seconds for Load Up Slide Valve in compressor in LOAD UP1 Mode.**
(SVn-UP: Coil energizing)

Figure	6	6
Location	ON	OFF
Time (minute)	12	24

- **DSW5-7,8: Pulse width in Seconds for Load Up Slide Valve in compressor in LOAD UP2 Mode.**
(SVn-UP: Coil energizing)

Figure	7	8	7	8	7	8	7	8
Location	ON	ON	ON	OFF	OFF	ON	OFF	OFF
Time (minute)	2		4		6		8	

- **DSW5-9,10: Frequency of Load Up Slide Valve in compressor.**
(SVn-UP: Coil energizing)

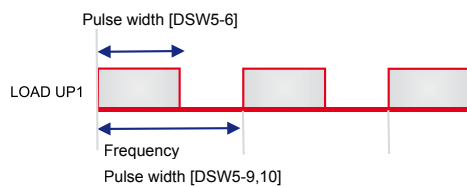

- **PCB_{B1} DSW6: Optional Function B**
(PCB_{B2} DSW6: No function. Keep DSW6-4 in OFF)
DSW6-2: ON: Pump freeze protection activated ($T_{ambient} = 2^{\circ}C$)
OFF: Pump freeze protection disabled
[DSW6-1,3,4: OFF; Not available]

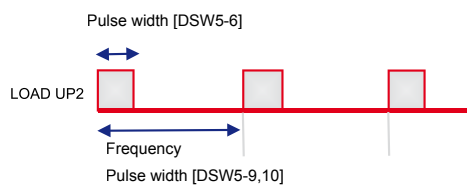

- **PCB_{B1} DSW7: Optional Function C**
(PCB_{B2} DSW7: No function)
DSW7-1,2: Temperature Range for Brine Opt.
[DSW7-1,2: Both in ON; this function is not available]

Figure	1	2	1	2	1	2
Location	OFF	OFF	ON	OFF	OFF	ON
Time Range	Standard		-5~5 °C		-10~6 °C	

DSW7-3: ON; Thermo OFF is delayed after Outlet Temperature is below Thermo OFF setting for 3 min.
DSW7-4: ON: Used only in case of remote control through H-LINK (e.g.:CSC-5S, HARC)

- **PCB_{B1} RSW1,2 (SW5): Setting Temperature in Cooling Mode with to digits and the sign indicated in SW5**

(PCB_{B2} RSW1,2 & SW5: No function)

In case of Brine 2 Option can be set negative temperatures.



- **PCB_{B1} RSW3,4: Setting Temperature in Heating Mode with to digits (Only available in Heat Pump Models- RHUEXXXAG2)**

(PCB_{B2} RSW3,4: No function)

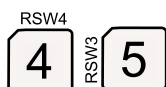

- **PCB_{B1} RSW5,6,7: CT Sensor function (Supplied as standard)**



(PCB_{B2} RSW5,6,7: No function)

Num. "X"	Model (HP)
2	40
3	50/100
5	60/120/180
6	70/140/210/280/350
7	80/160/240/320/400

1 RSW6	X RSW5	X	40A	40 HP 50 HP 60 HP
			50A	70 HP 80 HP

Y RSW7	X	10 min.
-----------	---	---------

Compressor load is kept for period when CT sensor measures set current

e.g.:

RCUE40AG2: Compressor load is "down" and "hold" for 30min (Y=3; 3*10min) when compressor current is higher than 48 A (X=2; 1.2*40A).

- **PCB_{B1} RSW8: Temperature band for Neutral Zone (See also DSW5)**



(PCB_{B2} RSW8: No function)

Figure	0	1	2	3	4	5	6	7	8	9
Band (degree)	0.5	1.0	1.5	2.0	2.5	3.0	3.5	4.0	4.5	5.0

- **PCB_{B1} RSW9: Temperature setting for one Defrost condition [Evaporator. Temp.- Ambient Temp.: 2~20°C]**



(PCB_{B2} RSW9: No function)

1 → 2x1=2°C

2 → 2x2=4°C

...

9 → 9x2=18°C

0 → 10x2=20°C]

- **PCB_{B1} SW5:** See explanation for PCB_{B1} RSW1,2
(PCB_{B2} SW5: No function)
- **PCB_{B1} SW6: Remote unit control. Standard is**
(PCB_{B2} SW6: No function)

PCB_{B1} SW7: Pump operation
(PCB_{B2} SW7: No function)

- **PCB_{B1} SW8:** Operation Mode.
(PCB_{B2} SW8: No function)

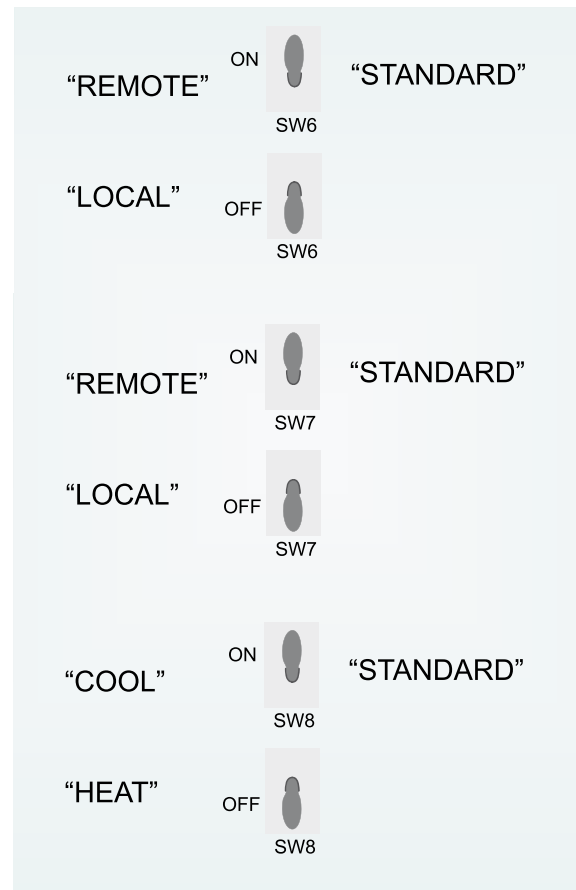

- PCB_{B1,B2} SW9, SW10: High Cut check (Fan Stop for Check)
 SW9 (PCB_{B1}): ON → Checking Cycle 1
 SW10 (PCB_{B1}): ON → Checking Cycle 2
 SW9 + SW10 (PCB_{B1}): ON → Checking Cycle 3
 SW9 (PCB_{B2}): ON → Checking Cycle 4
 SW10 (PCB_{B2}): ON → Checking Cycle 5



- PCB_{B1} SW11, SW12: Manual Defrost (Only Heat Pump models)
 (PCB_{B2}: Not available function)
 SW11 (PCB_{B1}): ON → Checking Cycle 1
 SW12 (PCB_{B1}): ON → Checking Cycle 2
 SW11 + SW12 (PCB_{B1}): ON → Checking Cycle 3



◆ **DIP SWITCH SETTING PCBC1,C2 (MAIN CONTROL PCB; Master & Subsidiary)**

DSW-1: H-LINK end resistance (ON only PCB C1)

DSW-2: Fuse protection

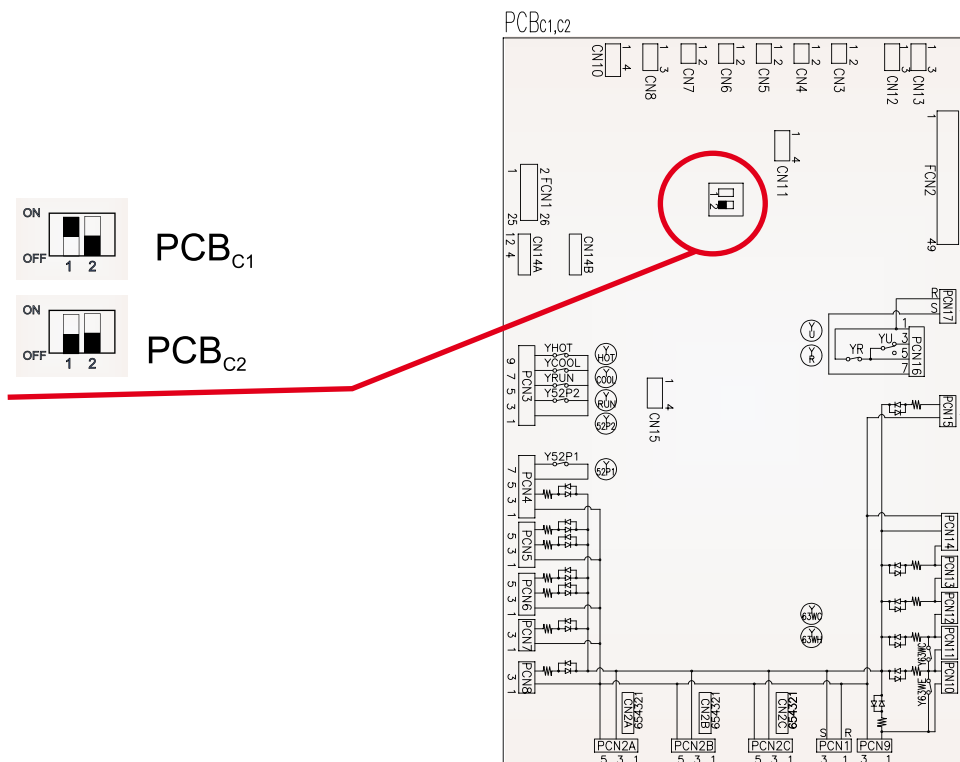

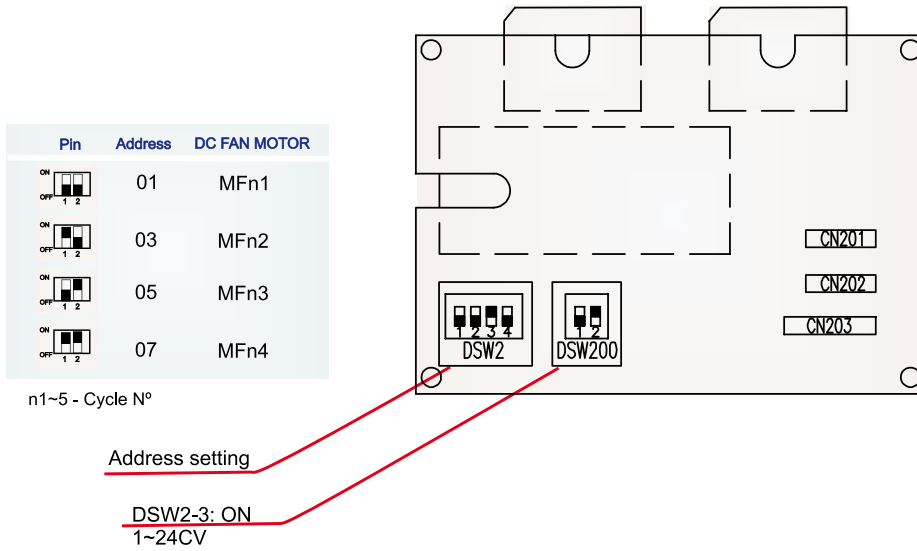

◆ DIP SWITCH SETTING PCB_{e1-e5} (FAN MODULE FOR DC FAN MOTORS)

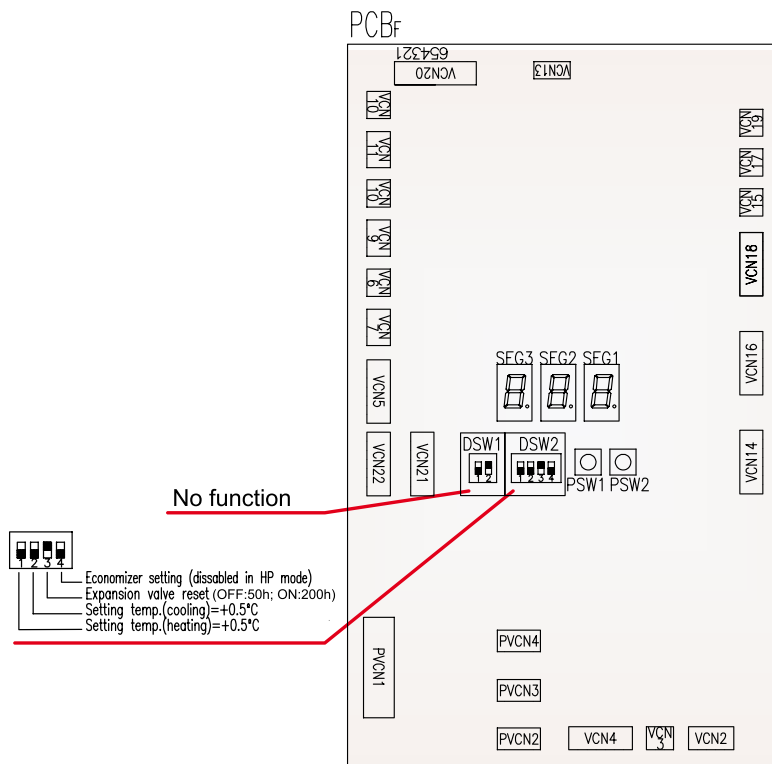

◆ DIP SWITCH SETTING PCB_{F1-F2*} (EXP. VALVE CONTROL PCB)



◆ **DIP SWITCH SETTING PCB_{G1,G2,G3} (FAN CONTROL PCB)**
Standard Setting

Setting PCB DSW4	H LINK DSW4 1 2 3	PCB N° DSW4 4
 PCB _{G1}	000	0
 PCB _{G2}	000	1
 PCB _{G3}	001	0

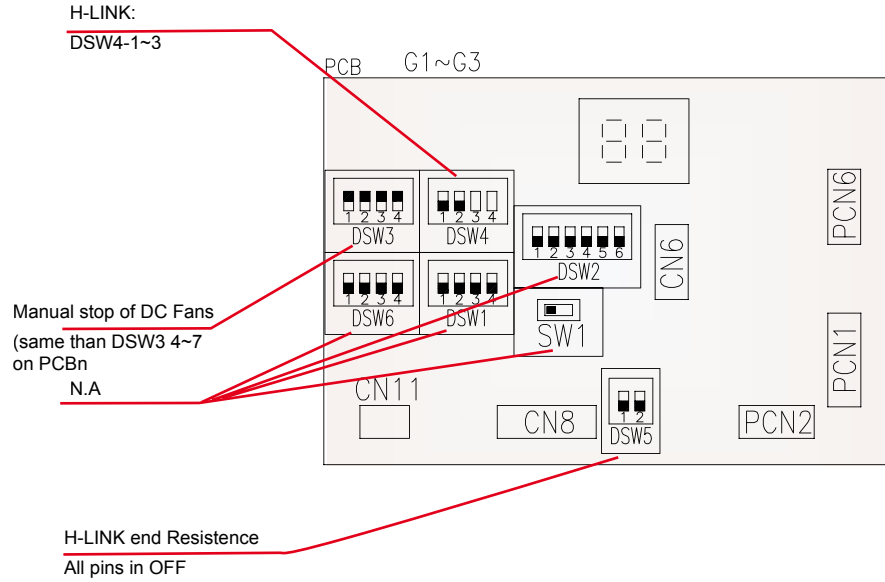

5.1.3. Confirmation of activation value of protection device an Automatic operation device

◆ **Protection device**

Activation value of protection device is as follows:

	Name	Activation value
Cooling	High pressure block device	2.74 MPa (re-start manually)
	Prevention control for low pressure decrease	0.314 MPa (Electron control)
	Low pressure block device	0.049 MPa (Electron control)
Heating	High pressure block device	2.74 MPa (re-start manually)
	Prevention control for low pressure decrease	0.049 MPa (Electron control)
Excess current in relay for compressor	40 HP	55 A
	50 HP	60 A
	60 HP	70 A
	70 HP	85 A
	80 HP	90 A
	Prevention control for freezing	2°C (Electron control)
	Prevention control for suction gas decrease	-2°C
	Internal Thermostat for Compressor	115°C
	Prevention control for overheating of discharge gas	140°C
	Fusible plug	72°C
	Safety valve	3.0 MPa
	Fuse for operation circuit	10, 5, 3A

 **NOTE:**

Safety valve is installed in all models

◆ **Automatic operation device**

The value of automatic operation device is set as follows:

Item (unit)			Setting value	Remarks
Relay for only starting control	Time guard	Min	Variable: 30 sec ~ 10 min (standard value: 3 min) (Note 1)	Electron control
	-Δ switch	Sec	5	
	Starting unload	Sec	30	
	Sequential starting (Note 2)	Min	1	

i NOTES:

1. It should be normally over 3 min.
2. In all chiller units there is a timer which prevents compressors starting at the same time.

5.1.4. Individual indication for activation of protection device

◆ **Indication in the segment**

Status of unit and activation of the different protection devices are indicated on the display. This indication helps to make a diagnosis about the unit, indicating if it is running well, and it can help to solve different inconvenients on the system.

Indication on the segment at normal operation (standard menu display) is as follows:

Segment indication abnormal code	Contents
	Power ON
	Wait for pump feed back
	Procedure of ex. valve zero reset
	After pump feed back
	At cooling operation
	At heating operation
	At activation of current limit
At Alarm	
	At thermo OFF
	At stop operation

The diagram shows a control panel with two digital displays labeled 'No.1' and 'No.2'. 'No.1' is labeled 'No. of cycle' and 'No.2' is labeled 'State'. Below the displays are several buttons: 'POWER' (a circle), 'OPERATION' (a circle), 'ALARM' (a circle), 'RUN (ON)' (a square), 'RUN (OFF)' (a square), and 'CHECK' (two triangles, one up and one down).

i NOTES:

- C1~C5 means No of cycle. (C1: Cycle 1)
- Number of cycle whose manual set switch is ON is indicated alternately.
- It is a state from the output of pump operation signal to the confirmation of pump interlock. In case that pump interlock is confirmed immediately, it is possible that the indication is not checked visually since the indication time is too short.

◆ **Abnormal code of segment indication part**

In this section “abnormal code” is explained. See subchapter 5.2.3 “Method of failure diagnosis” for the concrete treatment.

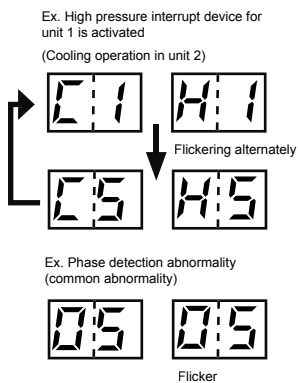

	Segment Indication abnormal code		Contents
Individual Alarm (stop only the corresponding cycle)	C1-C5	H1-H5	Activation of High Pressure Block Device(63H)
	C1-C5	L1-L5	Activation of Suction Pressure Block Device
	C1-C5	L1-L5	Activation of Prevention Control for Suction Pressure Block Decrease
	C1-C5	51-55	Activation of Thermal Relay for Compressor (51C)
	C1-C5	61-65	Activation of Discharge Gas Thermistor (Td)
	C1-C5	71-75	Activation of Compressor Thermostat (49C)
	C1-C5	91-95	Activation of Evaporating Temperature Thermistor (Tr)
	C1-C5	t1-t5	Activation of Suction Gas Thermistor (Ts)
	C1-C5	05	Phase Abnormality (Reverse Phase / Phase Failure) [Individual power source spec: Option]
	C1-C5	12	Outlet Chilled Water Thermistor Abnormality in some cycles
	C1-C5	13	Activation of Freeze Protection Control Abnormality in some cycles
	C1-C5	14	Activation of Water Overheating Protection Control Abnormality in some cycles
	C1-C5	21	Evaporating Temperature Thermistor Abnormality
	C1-C5	23	Abnormality of discharge gas temperature Thermistor
	C1-C5	24	Liquid Temperature Thermistor Abnormality
	C1-C5	25	Abnormality of Outlet Water Temperature Thermistor for Protection
	C1-C5	26	Suction Gas Temperature Thermistor Abnormality
	C1-C5	27	Discharge Pressure Sensor Abnormality
	C1-C5	28	Suction Pressure Sensor Abnormality
	C1-C5	F0	Abnormality of Setting Fan Number
Common Alarm (Stops unit)	05	05	Phase Abnormality (Reverse Phase / Phase Failure)
	11	11	Inlet Chilled Water Thermistor Abnormality
	12	12	Outlet Chilled Water Thermistor Abnormality in 1 cycle
	13	13	Activation of Freeze Protection Control Abnormality in 1 cycle
	14	14	Activation of Water Overheating Protection Control Abnormality in 1 cycle
	22	22	Ambient Temperature Thermistor Abnormality
	5P	5P	52P Pump Interlock Signal Abnormality
	40	40	Operation Error / Setting Error
	EU	EU	Error Communication between Ctrl. PCB and Ex. Valve PCB
	FC	FC	Error Communication between Ctrl. PCB and Fan Speed control PCB
	F1-F5	11-14	Inverter Speed Control Abnormality
	F1-F5	21-24	Inverter Excess Current Protection Abnormality
	F1-F5	31-34	Inverter Position Detection Abnormality
	F1-F5	41-44	Transmission Abnormality between Inverter and CPU PCB or between Fan Speed Control PCB
	F1-F5	51-54	Voltage Shortage or Excess Voltage in Inverter
	PU	PU	During Activation of Pump Stop Control by Excess Increase of Water Temperature
(flicker)			
6E	6E	Water Shortage Protection Switch Activation (at 63W use; Option)	
03	03	System Controller Connection Abnormality (at CSC-5S connection; Option)	

◆ **Indication of inverter (fan module) for control of fan revolution number**

Fan module has protection control and indicates abnormal code on the segment.

– List of inverter abnormal code

Segment Indication abnormal code		Contents
F 1-F5	11-14	Inverter Speed Control Abnormality
F 1-F5	21-24	Inverter Excess Current Protection Abnormality
F 1-F5	31-34	Inverter Position Detection Abnormality
F 1-F5	41-44	Transmission Abnormality between Inverter and CPU PCB or between Fan Speed Control PCB
F 1-F5	51-54	Voltage Shortage or Excess Voltage in Inverter

– List of state at inverter retry

Segment Indication abnormal code		Contents
F 1-F5	P7	During retry control at simultaneous abnormal in some (majority) fans (Fan single retry)
F 1-F5	P8	Abnormal code during retry control in Fn-4m, Fn-5m

 **NOTES:**

“n”: Cycle N° (n=1-5)

“m”: Fan N° (m=1-4)

In case of fan abnormal operation, retry is performed in every case and in case that the same abnormal operation occurs in specified times within specified period, unit is stopped by alarm.

Retry:

1. Retry in fan by itself (compressor keeps operating. Re-start in 10 seconds)
2. Retry in cycle by itself (compressor also stops. Re-start in 3 minutes).

In case of retry in cycle by itself, retry is indicated like above “list of state at inverter retry”. In case of retry in fan by itself, it is possible to confirm which fan is being retried in check mode.

5.1.5. Modification of PCB_C configuration

Every Chiller is delivered with the correct priority configuration (Master PCB and slave PCB). In case of a Control PCB delivered as a spare part, it will be necessary to set the correct priority configuration because it is not known where it will be applied (Chiller model).

In case that this priority configuration is not correct, the Chiller cannot operate. See next point.

◆ **Problem detection**

When the priority configuration is not correct, on the 7 segment it is displayed:



7 segments on PCB_A shows the above message and no alarm message is shown.

◆ **Configuration**

To establish the right priority configuration in each PCB_C it is necessary to connect an operation PCB (PCB_A and PCB_B) to the corresponding Control PCB_C. It means that in case of a CHILLER Electric Box with 5 cycles, it is necessary to connect an additional operation PCB (PCB_A and PCB_B) to establish the right priority configuration in this subsidiary control PCB (PCB_{C2})

Next drawings shows the controls required for this procedure.

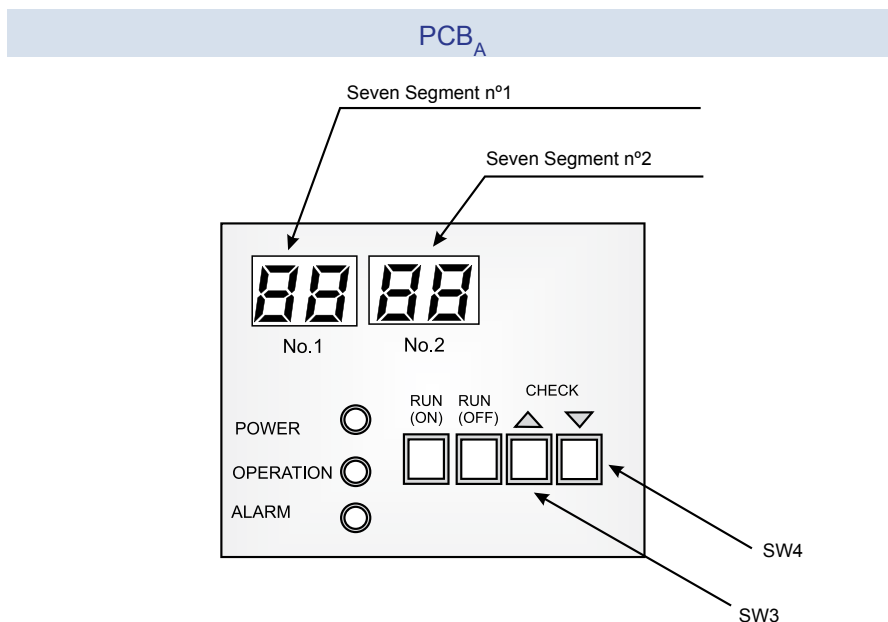

7. The right priority configuration follows the next table criteria.

7 segments	
	Setting for main control PCB (PCB _C) in all CHILLERS up to 240 HP
	Setting for main control PCB (PCB _{C1}) in Cooling Only CHILLERS with 4 or 5 cycles.
	Setting for subsidiary control PCB (PCB _{C2}) in Cooling Only CHILLERS with 4 or 5 cycles

◆ **Modification of priority configuration**

Check previous table for the correct configuration

1. Modification of the priority number: "00", "01", "02"

7 segments	
	"X" is the priority number of the PCB (0, 1 or 2), according to the above table

2. Priority number is changeable only in "U2" position, it means that first it is necessary to set U2 in 7 segments pushing the SW3 and SW4 at the same time in Operation PCB (PCB_A) during 3 seconds.

7 segments	
	"X" is the priority number (0, 1 or 2) that you can select following the next point.

3. For modifying "X" value is necessary to push during 1 second SW3 or SW4 of Operation PCB (PCB_A) depending if you want to increase (DSW3) or decrease (DSW4) the priority number
4. Push at the same time DSW3 and DSW4 for 3 seconds for fixing at "U1" the corresponding priority number established before in "U2".
5. Switch OFF the power supply in the Electrical Box (M.I. switch OFF)
6. Switch ON the power supply in the Electrical Box (M.I. switch ON)
7. See on the Operation PCB, in the 7 segments, the right configuration number according to the table on point 7. On the contrary repeat again all steps and select the right configuration number.
8. Restore the initial setting: DWS1, RSW8-3

Confirm the initial setting for these switches with the Technical Catalogue considering the options included in the model. The standard setting values are the next:

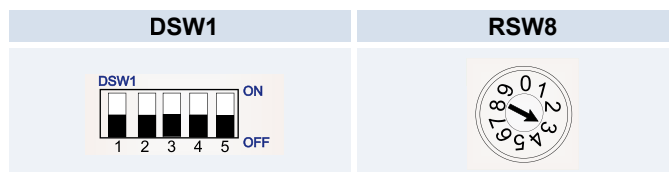

i **NOTE:**

In case of additional option DSW1 and RSW8 can be different

– Flowchart at abnormal occurrence

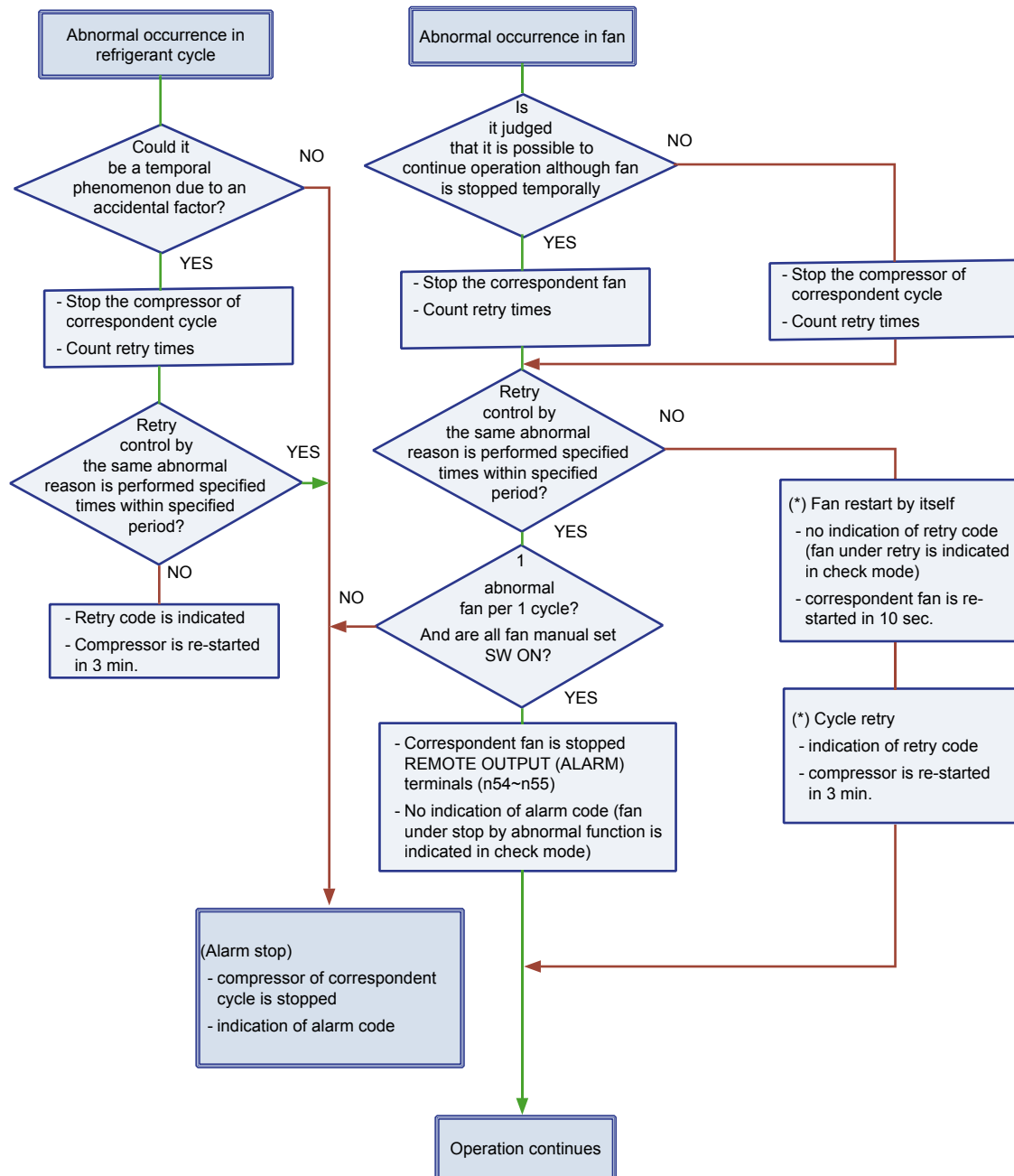

5

◆ Abnormal indication of Option / Remote Controller Switch

Indication lamp of remote controller side distinguishes “Run”, “Alarm”, and “Stop”:

- “Run”: Red light indication lamp on.
- “Alarm”: Light red indication lamp on. Light orange indication lamp on: in case of option switch use
- “Stop”: Light red indication lamp off.

5.1.6. Check function

◆ **Check mode**

By pressing [▲] (SW3) on PCB more than 3 seconds, control state of chilled water temperature, each refrigerant cycle pressure/ temperature etc are indicated. (it is possible both during stopping and during running), (*mode shall not be shifted in case of alarm).

Pressing again [▲] (SW3) on PCB more than 3 seconds enables you to see the different values but with decimals

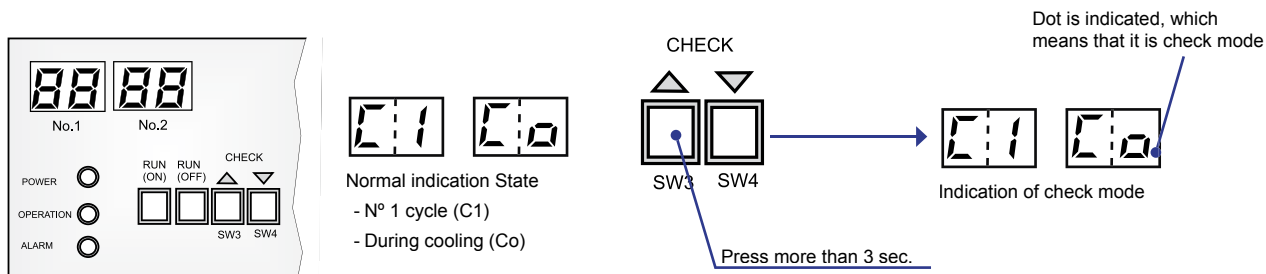

By pressing [▲][▼], indication is changed. The followings are the contents.

Item	Example of code indication (alternately flicker)	Contents
Latest protection device state (alarm code)	C1H1	In case of latest alarm = activation of No. 1 high pressure block device (if alarm code is not saved, it is "00-00".
Refrigerant cycle state	C1Pd ↔ 1.42	1. Pd (high pressure) indication [MPa] -Example of Pd of No.1 = 1.42MPa -Example of Pd of No. 2 = 1.43MPa Indication of unit of 2 cycles (Indication of only the unit whose manual set SW is ON)
	C2Pd ↔ 1.43	
	C1Ps ↔ 0.41	2. Ps (low pressure) indication [MPa] -in case of Ps of No. 1 = 0.41MPa -In case of unit of 2 cycles, [C2-PS].
	C1td ↔ 81	3. Td (discharge gas temp) indication [°C] -in case of Td of No. 1 = 81°C -In case of unit of 2 cycles, [C2-td].
	C1ts ↔ -2	4. Ts (suction gas temp) indication [°C] -in case of Ts of No. 1 = -2°C -In case of unit of 2 cycles, [C2-ts].
	C1tr ↔ 5	5. Tr (Plate heat exchanger inlet refrigerant temp) indication [°C] -in case of Td of No. 1 = 5°C -In case of unit of 2 cycles, [C2-tr].
	C1te ↔ 35	6. Te (Refrigerant liquid temp) indication [°C] -in case of Te of No. 1 = 35°C -In case of unit of 2 cycles, [C2-te].
	CEL ↔ 12	7. Inlet water temperature indication [°C] -in case of inlet water temperature = 12°C
	CaL ↔ 7	8-1. Outlet water temperature indication [°C] -in case of outlet water temperature = 7°C (For units with more than one cycle, this is the average value)
	CaL1 ↔ 7	8-2. Individual outlet water temperature indication [°C] In 2 cycles, chilled water outlet temp every cycle is indicated. (no indication in case of 1 cycle) -in case of outlet water temp of No.1 = 7°C -in case of outlet water temp of No.2 = 7°C *Unit whose manual set SW is OFF is indicated.
CaL2 ↔ 7		

Item	Example of code indication (alternately flicker)	Contents
Setting state indication SW3 SW4		1. Chilled water setting temperature indication [°C] -in case of setting temperature = 12°C -integer round up is indicated in case of +0.5°C setting
		2. Warm water setting temperature indication [°C] (only heat pump type) -in case of setting temperature = 40°C -integer round up is indicated in case of +0.5°C setting
		3. Chilled water second temperature setting indication [°C] -in case of setting temperature = 5°C *only at alarm selection
		4. Warm water second temperature setting indication [°C] (only heat pump type) -in case of setting temperature = 45°C *It is indicated only if heat storage is selected.
Ambient temperature indication SW3 SW4		5. Neutral zone range indication [°C]
		Ambient temperature indication [°C] -In case of 35°C
Capacity control state indication SW3 SW4		Capacity control state in every cycle Continuous control spec: *Load-up [UP] / Neutral Zone [nU] / Load down [dO] Thermo OFF [- -]. *In case of 2 cycles, [C2-Ld]
Protection control state indication SW3 SW4		Protection control state is indicated in every cycle. *Protection control is assigned in 7 segment. Control under activation is lighted. (example in the left side: No. 1 cooling operation and Td control under activation)
Fan control state indication SW3 SW4		In case of 2 cycles, [C2-FC]
		Fan control state and order frequency are indicated in every cycle. (example in the left side: Fan No. 2 and No. 4 of No. 1 cycle are under retry, Fan No. 1 is under stop by abnormality, other fans are under operation with 44 Hz) Fan control state *①~④: Fan number Light the position correspondent to the fan In case of 2 cycles, [C2-FC]
Control software ROM N° indication SW3 SW4		Indication of ROM NO. (ex: 239)

5

The following operation makes change from check mode back to normal mode.

1. Press [▲] (SW3) more than 3 sec.
2. In case that un-input state continues 1 hour.

◆ Alarm occurrence data

Alarm occurrence data is indicated by pressing [▲] (SW3) [▼] (SW4) on PCB. (It is possible to do during stop / operation). (*Mode should not be shifted during alarm occurrence)

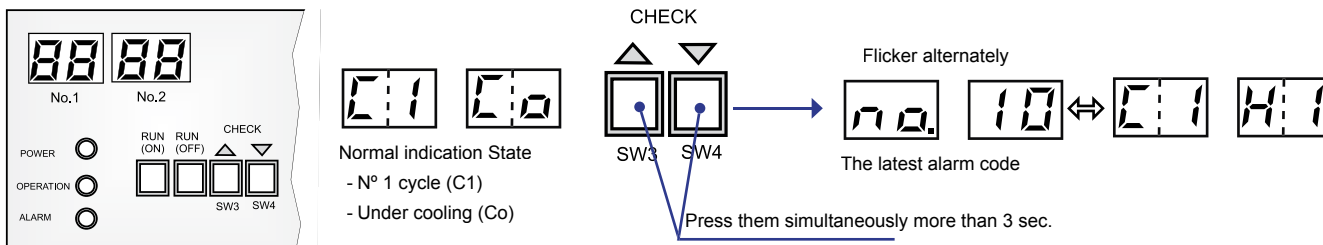

[Way to clear alarm occurrence data]
(valid only during stop (Power ON))





Press while pressing at the same time

By pressing [▲][▼], indication is changed. The followings are the contents.

Item	Example of code indication (alternately flicker)	Contents
Latest activation of protection device (alarm code) 	 : :	The latest alarm is indicated firstly. (Max 10). In case of 5 alarm is saved, no.5 is indicated firstly. In case of the latest alarm = No.1 high pressure block device activation If there is no saved alarm code, [00-00]
5th oldest Activation of protection device (alarm code) 	 : :	The 5th oldest alarm [pump interlock abnormality].
	 : :	The 10th alarm [Error operation]

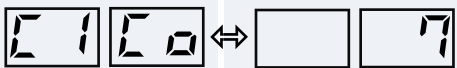
The following operation makes change from alarm occurrence indication mode back to normal mode.

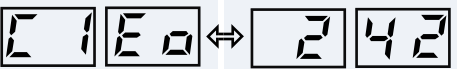
1. Press [▲] (SW3) [▼] (SW4) more than 3 sec.
2. In case that un-input state continues 30 seconds.
- 3 Alarm Data Indication Function (The Last Saved Data before Alarm Occurrence)
 - Regarding the latest alarm, the last sensor data before stop can be indicated, while alarm occurrence is indicated. (Data is indicated by the following operation during the latest alarm occurrence indication)
 - Alarm data of the latest alarm occurrence is only saved.
 - Alarm data is cleared by Power OFF
 - In case that data is not saved, alarm occurrence data mode after flickering [- -] twice.
- 4 To switch indication items, Press [▲] (SW3) [▼] (SW4).
- 5 Indication data is the same as the one of check mode. However, the next items are indicated as an additional.

Item	Example of code indication (alternately flicker)	Contents
⋮ Refrigerant liquid ⋮ Outlet water temp (backside of heat exchanger of water side)	⋮  	Outlet water temp (backside of heat exchanger of water side) [°C] -In case of No. 1 outlet water temp is 7°C -In case of No. 2 outlet water temp is 7°C
⋮ Fan control state	⋮  	Indication of electron expansion valve opening -In case of No. 1 opening is 242 pulse. -In case of No. 2 opening is 240 pulse.

The following operation makes change from alarm data indication mode to normal mode.

1. Press [▲] (SW3) [▼] (SW4) more than 3 sec.
2. In case that un-input state continues 30 seconds.

The following operation makes change from alarm data indication mode to alarm occurrence data mode.

1. Press [▼] (SW4) more than 3 sec.

◆ **Electron expansion valve opening indication**

By pressing [O] (PSW1) on PCB for electron expansion valve more than 3 seconds, actual expansion valve order opening (pulse) is indicated on the segment. (it is possible during stop / operation)

Once pulses are displayed, pushing again PSW1 enables you to check each cycles expansion valve position.

PWB_G (VD PCB)

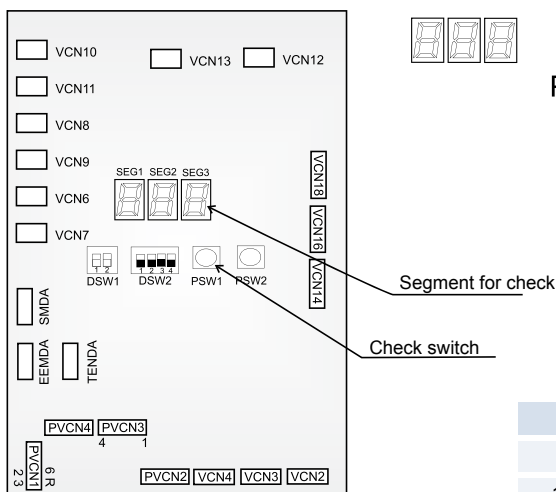

* Light off by pressing [O] more than 3 seconds.

PULSES	OPENING %
10 (Thermo OFF)	1,5 %
112 (Min. running value)	17%
656 (Max. running value)	100%

5.2. Troubleshooting

5.2.1. Outline of failure diagnosis

In the case of abnormality, alarm LED on the control panel of unit and of remote control is ON and segment indication on the control panel is flickering. To stop the unit, put it into stop operation without power OFF(Main switch).

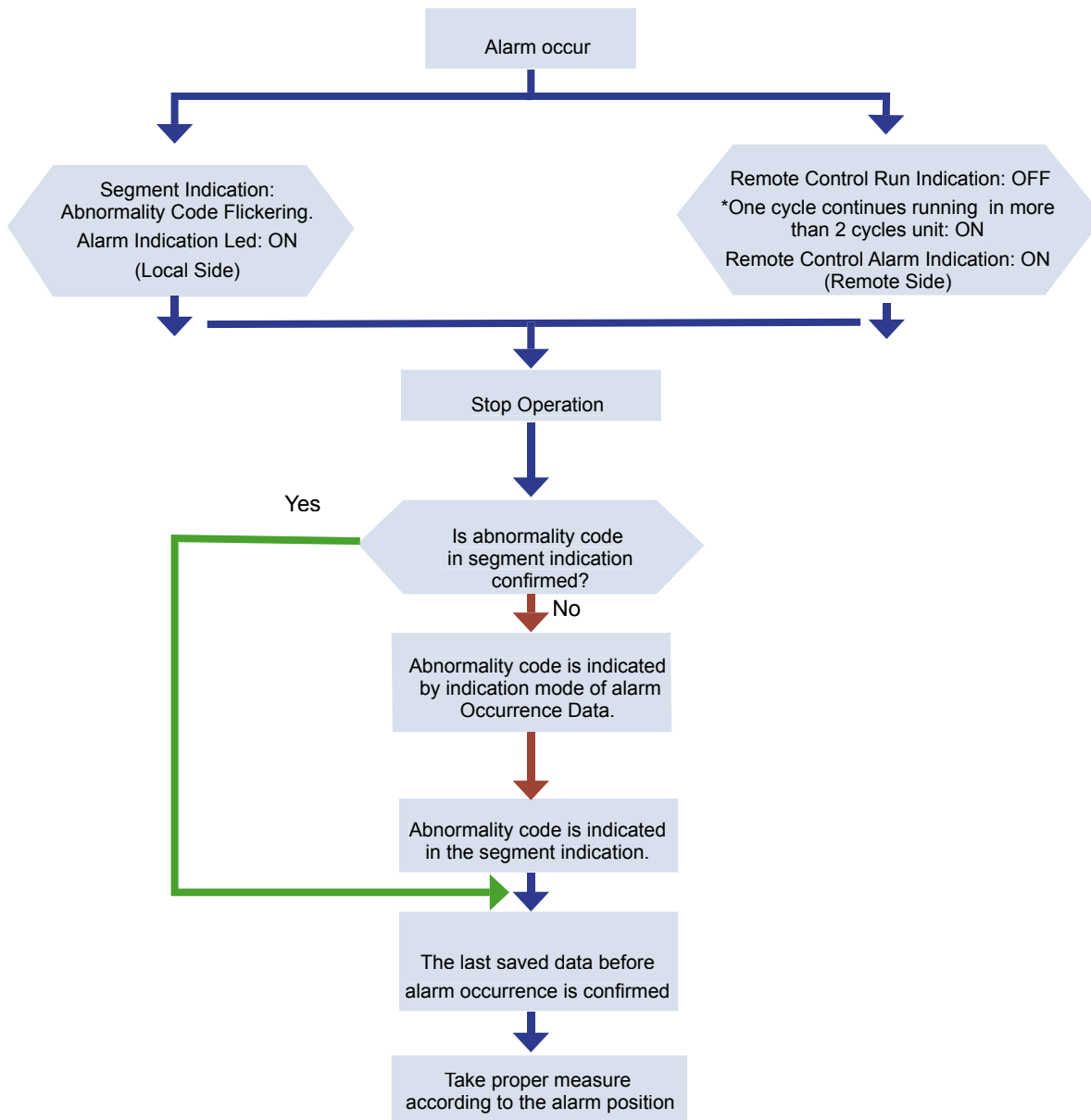

i NOTES:

- After the stop operation, alarm indication is turned off and initial status 88 is displayed. Abnormality code, which was activated before can be seen by entering "Indication Mode of Alarm Occurrence Data".
- When the power turns off and turns on, the indication on the display is initial status. Abnormal code, which was activated before can be seen by entering "Indication Mode of Alarm Occurrence Data"
- When the power turns off (Main switch), "The Last Saved Data before Alarm Occurrence" is cleared.
- "The Last Saved Data before Alarm Occurrence" has only the last data before last alarm. In case of before that, only alarm code is saved.

5.2.2. Alarm indication

7-Segment indication shows the following abnormalities:

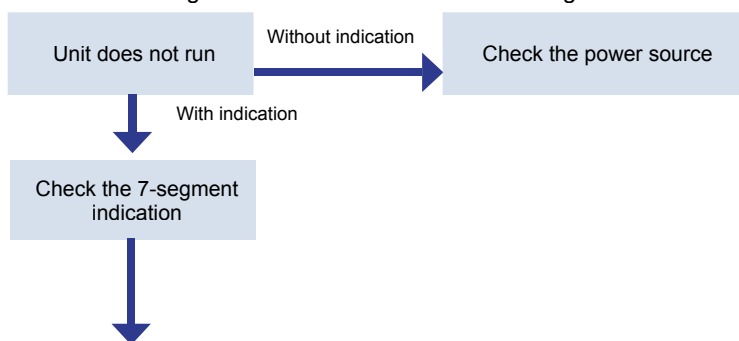

Alarm Code	Description of abnormality
No.1~6 cycles	
[C 1-H i]~[C5-H5]	Activation of High Pressure Switch
[C 1-L i]~[C5-L5]	Excessively Low Pressure
[C 1-L i]~[C5-L5]	Activation of Low Pressure Protection Control
[C 1-Y i]~[C5-Y5]	Activation of Fan Motor Internal Thermostat (Only for 70,80,140,160,210,240,280,320,350 and 400HP)
[C 1-S i]~[C5-S5]	Activation of Thermal Relay for Compressor or Chattering alarm or Malfunction of Auxiliary Relay Arm
[C 1-B i]~[C5-B5]	Activation of Discharge Gas Thermostat
[C 1-T i]~[C5-T5]	Activation of Compressor Internal Thermostat
[C 1-Q i]~[C5-Q5]	Excess Low Temperature of Cooler Inlet Refrigerant
[C 1-E i]~[C5-E5]	Low Pressure Protection by Suction Gas Thermistor
[C 1-05]~[C5-05]	Phase Abnormally (Only for 4 and 5 cycle unit)
[C 1-12]~[C5-12]	Failure of Water Outlet Thermistor (Only for 2 – 5 cycle unit)
[C 1-13]~[C5-13]	Activation of Freeze Protection Control (Only for 2 – 5 cycle unit)
[C 1-14]~[C5-14]	Activation of Water Overheating Protection Control
[C 1-2 i]~[C5-2 i]	Failure of Cooler Inlet Refrigerant Thermistor (Open/Short)
[C 1-23]~[C5-23]	Failure of Discharge Gas Thermistor (Open/Short)
[C 1-24]~[C5-24]	Failure of Thermistor set before Expansion Valve (Open / Short)
[C 1-25]~[C5-25]	Failure of Water Outlet Thermistor at Rear Side of Water Cooler (Open / Short)
[C 1-26]~[C5-26]	Failure of Suction Gas Thermistor (Open / Short)
[C 1-27]~[C5-27]	Failure of Discharge Gas Pressure Sensor (Open / Short)
[C 1-28]~[C5-28]	Failure of Suction Gas Pressure Sensor (Open / Short)
[C 1-F0]~[C5-F0]	Incorrect Setting of Fan Number
[C 1-5P]~[C5-5P]	No Feedback Signal from Water Pump
[F 1-1 i]~[F5-14]	Fan Inverter Rotation Abnormality *1
[F 1-2 i]~[F5-24]	Activation of Fan Inverter Over Current Protection Control *1
[F 1-3 i]~[F5-34]	Fan Inverter Phase Abnormality *1
[F 1-4 i]~[F5-44]	Error Communication between Inverter PCB and Control or Fan Control PCB *1
[F 1-5 i]~[F5-54]	Inverter Power Supply Abnormality *1
[05-05]	Phase Abnormality (Only for 1 – 3 cycle unit)
[11-11]	Failure of Water Inlet Thermistor (Open / Short)
[12-12]	Failure of Water Outlet Thermistor (Open / Short) (Only for 1 cycle unit)
[13-13]	Activation of Freezing Protection Control (Only for 1 cycle unit)
[14-14]	Activation of Water Overheating Protection Control
[22-22]	Failure of Ambient Temperature Thermistor (Open / Short)
[5P-5P]	Pump interlock Signal abnormality

*1 : [2 i] Right side Segment shows Fan No.

Alarm Code	Description of abnormality
No.1~5 cycles	
[40-40]	Incorrect Operation
[CP-CP]	Error communication between Ctrl. PCB (PCB _{C1} , PCB _{C2})
[EU-EU]	Error communication between Expansion Valve PCB and Control PCB
[Fc-Fc]	Error communication between Fan Control PCB and Control PCB
“ [PU-PU] ”	Alarm of Excessively High Water -Temperature
[EE-EE]	Alarm of Water Failure (Differential Water Pressure Switch Option)
[RP-RP]	Activation of Additional Protection Device (Option)
[03-03]	Error communication between Chiller and Remote Controller (If CSC-5S is connected.)
[F 1-P7]~[F5-P7]	Retry Operation (More Than 3 Fans Retry at The Same Time)
[F 1-P8]~[F5-P8]	Retry Operation (by Alarm Fx-41 or Fx-51, x: Cycle No.)
[C 1-P5]~[C5-P5]	Retry Operation (by Alarm Cx-6x or Cx-7X, x: Cycle No.)
[C 1-P6]~[C5-P6]	Retry Operation (by Alarm Cx-9x or Cx-LX, x: Cycle No.)

“ - ” : Flickering

5.2.3. Failure diagnosis method

◆ **General check of failure diagnosis.**

In the case of no segment indication, unit can not operate.

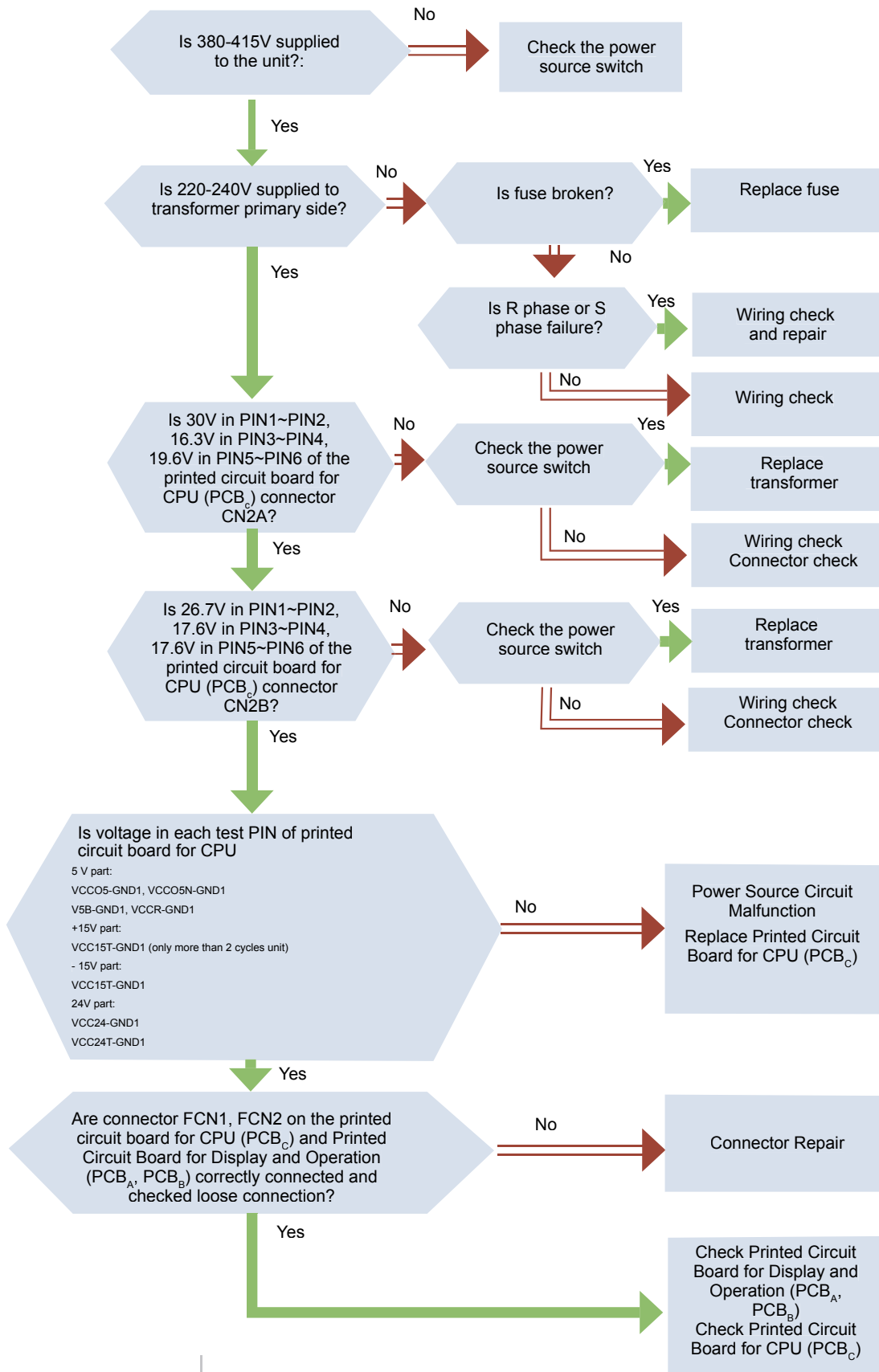

5

Alarm code *E1-H1* *E5-H5* **Activation of High Pressure Switch (63H)**

[Alarm Stop Reason]

High pressure (Pd) is increased to more than 2.74MPa, and high pressure switch (63H) is activated.

[PCB Monitoring Position]

- No. 1 Cycle: PCB_{D1} (I/O PCB)PCN203
- No. 2 Cycle: PCB_{D2} (I/O PCB)PCN203
- No. 3 Cycle: PCB_{D3} (I/O PCB)PCN203
- No. 4 Cycle: PCB_{D4} (I/O PCB)PCN203
- No. 5 Cycle: PCB_{D5} (I/O PCB)PCN203

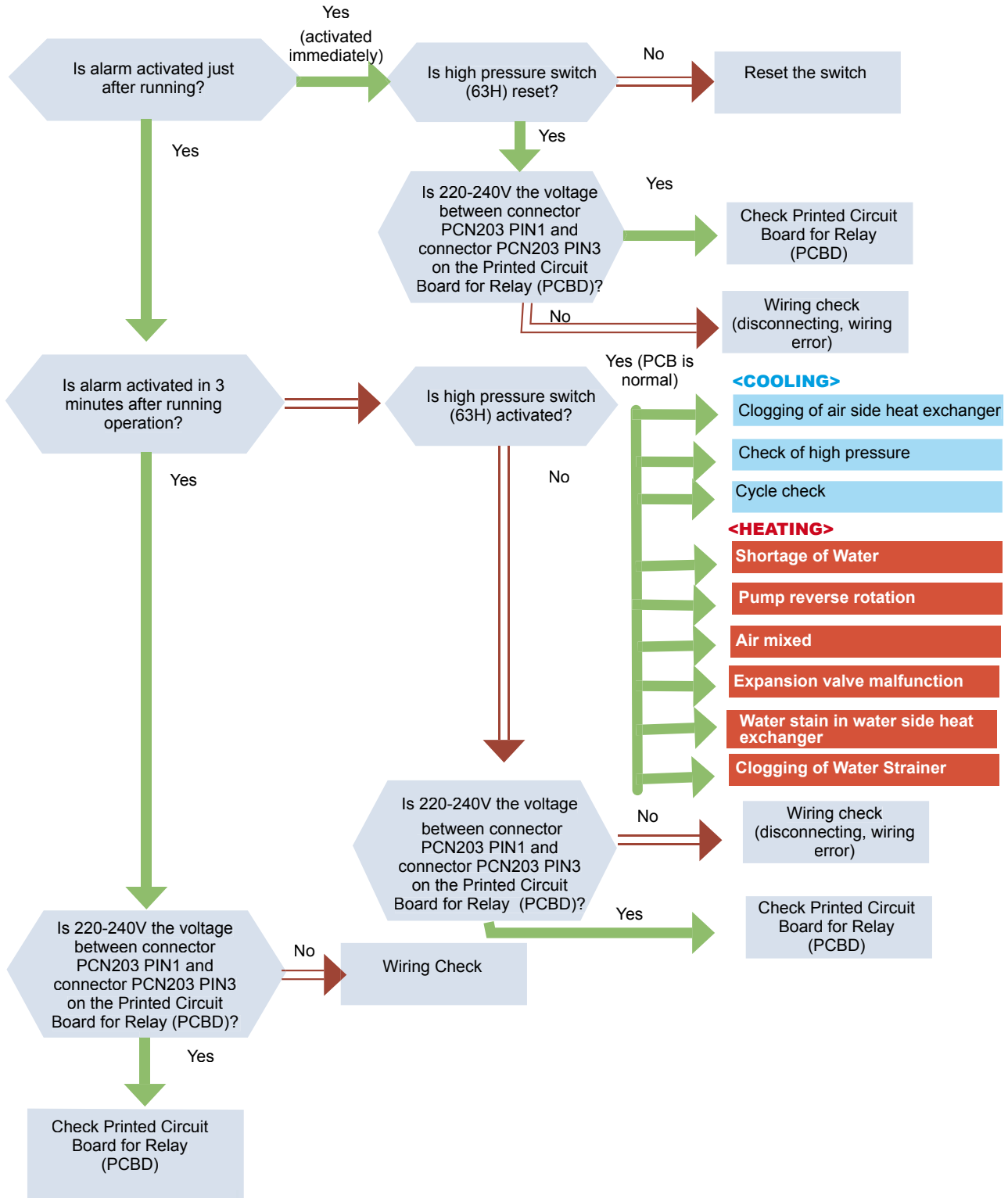

Alarm code E1-L1
E5-L5 **Excessively low suction pressure**

[Alarm Stop Reason]

Suction pressure (Ps) is less than 0.049MPa during 3 seconds. (electron control, cooling and heating)

[PCB Monitoring Position]

- No. 1 Cycle: PCB_{D1} (I/O PCB) CN29Ps
- No. 2 Cycle: PCB_{D2} (I/O PCB) CN29Ps
- No. 3 Cycle: PCB_{D3} (I/O PCB) CN29Ps
- No. 4 Cycle: PCB_{D4} (I/O PCB) CN29Ps
- No. 5 Cycle: PCB_{D5} (I/O PCB) CN29Ps

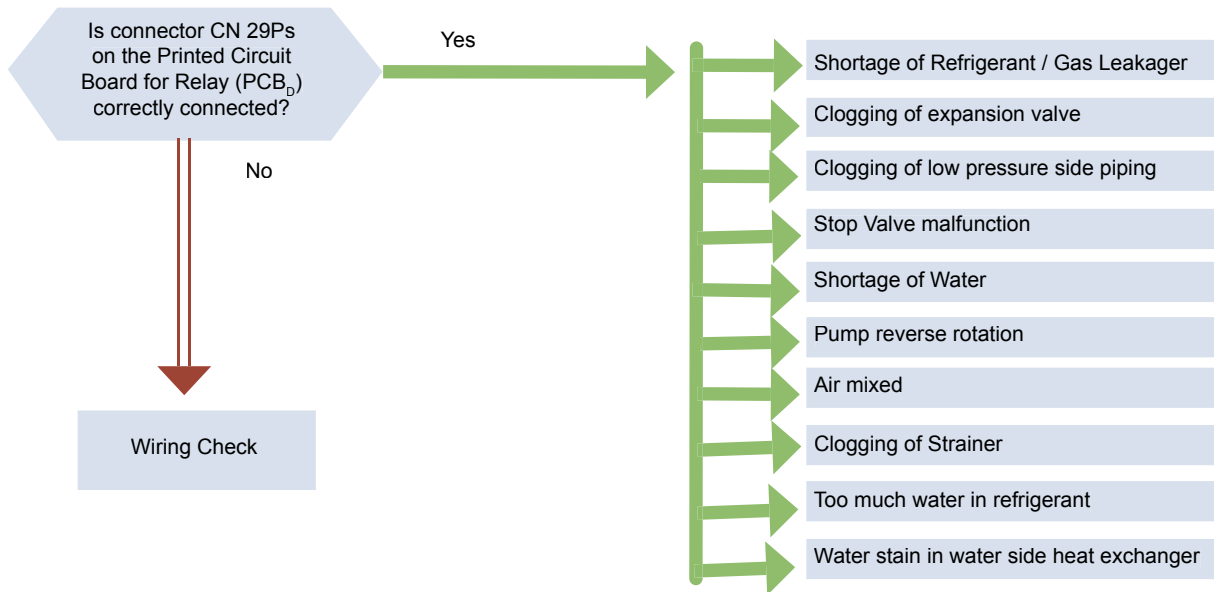

5

Alarm code

C1-L1
C2-L5

Activation of suction pressure protection control

[Alarm Stop Reason]

- Suction pressure (Ps) is less than 0.333MPa during 90 seconds. (Electronic control, air-cooled type)
- Suction pressure (Ps) is less than 0.314MPa during 90 seconds. (Electronic control, air-cooled heat pump type (only cooling operation))
- *Alarm stop: 3 retries during 30 minutes. (Compressor stop, automatic restart in 3 minutes)

[PCB Monitoring Position]

- No. 1 Cycle: PCB_{D1} (I/O PCB) CN29Ps
- No. 2 Cycle: PCB_{D2} (I/O PCB) CN29Ps
- No. 3 Cycle: PCB_{D3} (I/O PCB) CN29Ps
- No. 4 Cycle: PCB_{D4} (I/O PCB) CN29Ps
- No. 5 Cycle: PCB_{D5} (I/O PCB) CN29Ps

[Retry Code]

- No. 1 Cycle: C1-P6
- No. 2 Cycle: C2-P6
- No. 3 Cycle: C3-P6
- No. 4 Cycle: C4-P6
- No. 5 Cycle: C5-P6

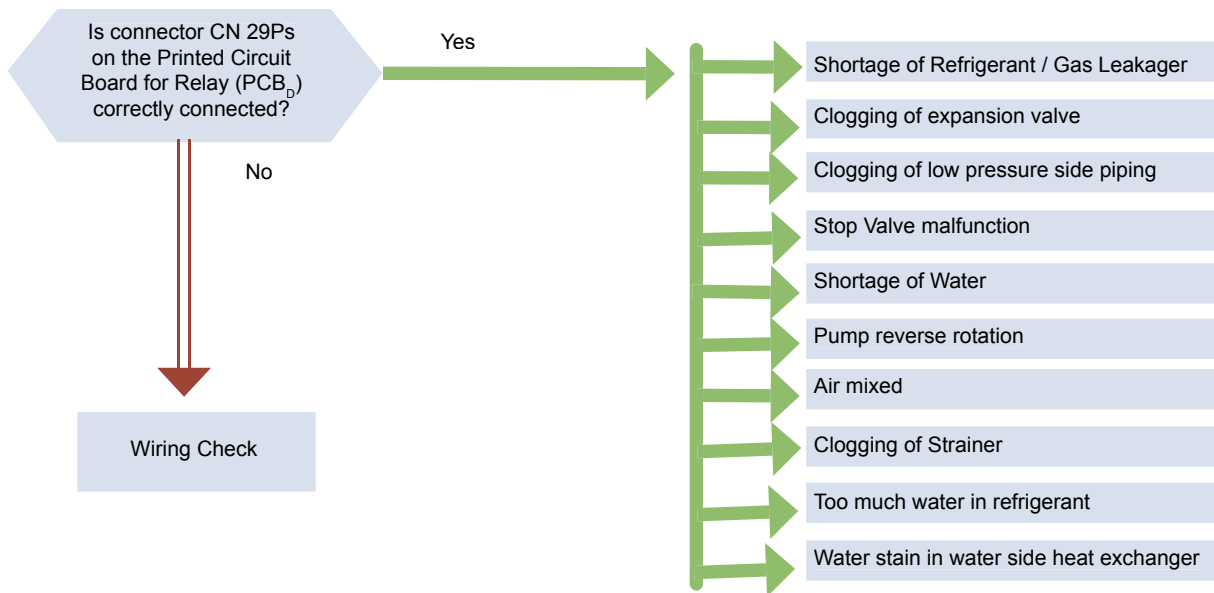

Alarm code E1-51 E5-55 **Activation of Thermal Relay for Compressor (51C)**

[Alarm Stop Reason]

- Operation current for any compressor is increased too much and activates the Thermal Relay.
- Chattering of external protection device connected to the chiller (eg: flow switch)

[PCB Monitoring Position]

- No. 1 Cycle: PCB_{D1} (I/O PCB) PCN207
- No. 2 Cycle: PCB_{D2} (I/O PCB) PCN207
- No. 3 Cycle: PCB_{D3} (I/O PCB) PCN207
- No. 4 Cycle: PCB_{D4} (I/O PCB) PCN207
- No. 5 Cycle: PCB_{D5} (I/O PCB) PCN207

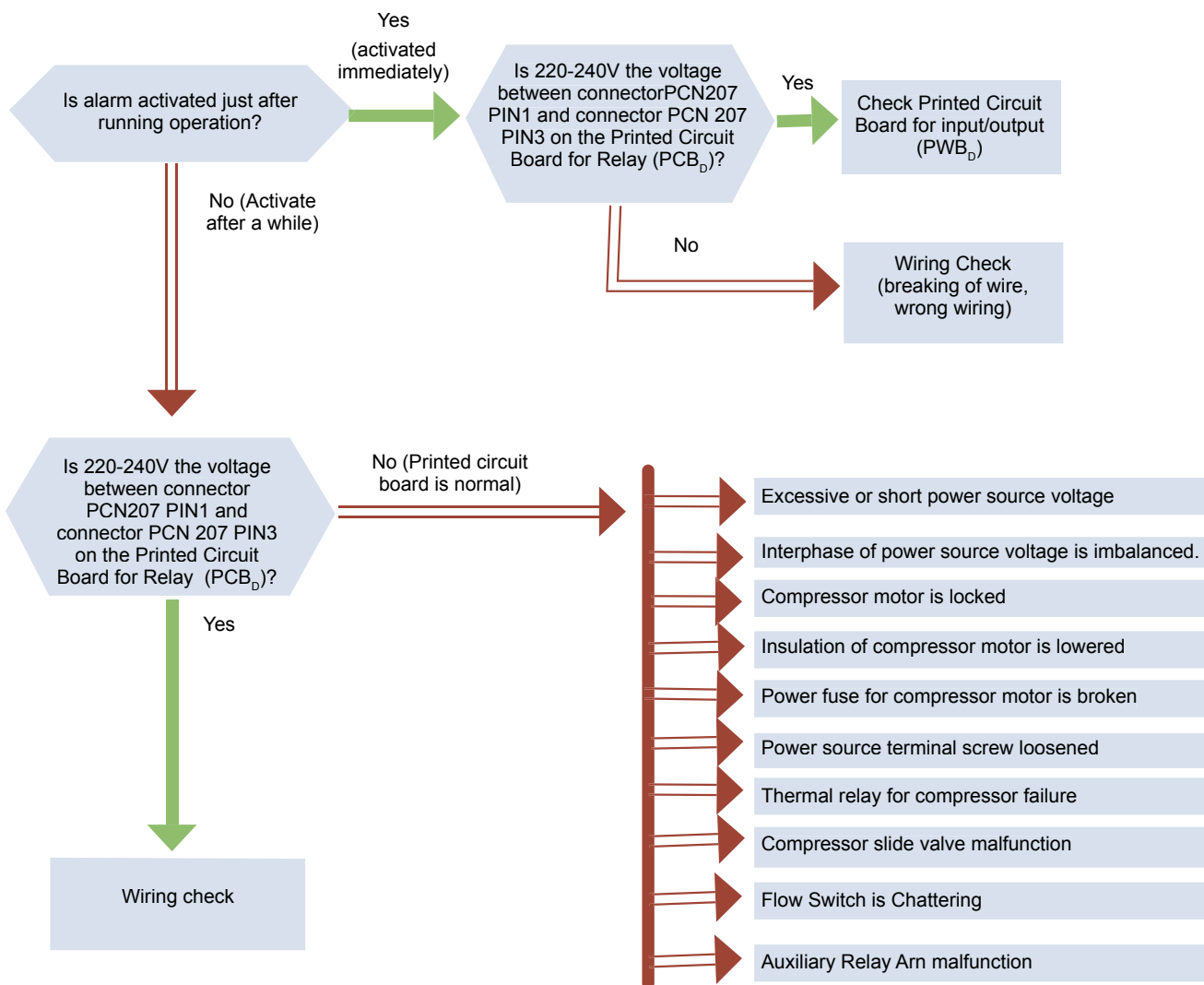

5

Alarm code C1-E1
C5-E5

Activation of Discharge Gas Thermistor (Td)

[Alarm Stop Reason]

- 1.- Discharge gas temperature from the compressor is increased to 130°C and continues for 1 minute.
- 2.- During the time counting in 1 minute, temperature is increased over 140°C during more than 3 seconds.
- *In case of n° 2, alarm stop: 3 retries during 90 minutes. (Compressor stop, automatic restart in 3 minutes)

[PCB Monitoring Position]

- No. 1 Cycle: PCB_{D1} (I/O PCB) CN24Td
- No. 2 Cycle: PCB_{D2} (I/O PCB) CN24Td
- No. 3 Cycle: PCB_{D3} (I/O PCB) CN24Td
- No. 4 Cycle: PCB_{D4} (I/O PCB) CN24Td
- No. 5 Cycle: PCB_{D5} (I/O PCB) CN24Td

[Retry Code]

- No. 1 Cycle: C1-P5
- No. 2 Cycle: C2-P5
- No. 3 Cycle: C3-P5
- No. 4 Cycle: C4-P5
- No. 5 Cycle: C5-P5

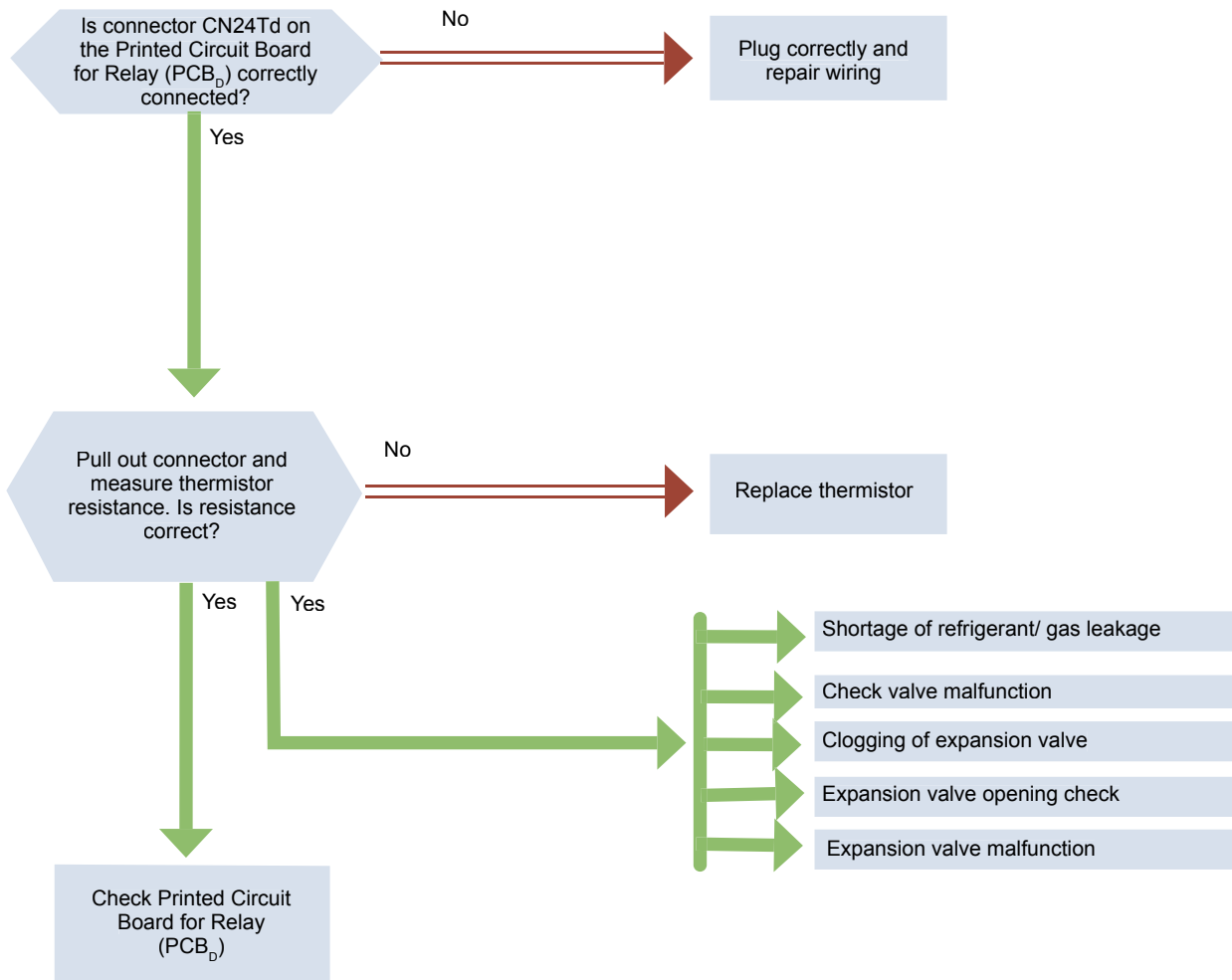

Alarm code **C1-71**
C5-75

Activation of Internal Thermostat for Compressor

[Alarm Stop Reason]

The electrical motor of the compressor is overheated and internal Thermostat is activated.

*Alarm stop: 3 retries during 60 minutes. (Automatic restart after compressor stop and Thermostat recover)

[PCB Monitoring Position]

- No. 1 Cycle: PCB_{D1} (I/O PCB) PCN204
- No. 2 Cycle: PCB_{D2} (I/O PCB) PCN204
- No. 3 Cycle: PCB_{D3} (I/O PCB) PCN204
- No. 4 Cycle: PCB_{D4} (I/O PCB) PCN204
- No. 5 Cycle: PCB_{D5} (I/O PCB) PCN204

[Retry Code]

- No. 1 Cycle: C1-P5
- No. 2 Cycle: C2-P5
- No. 3 Cycle: C3-P5
- No. 4 Cycle: C4-P5
- No. 5 Cycle: C5-P5

5

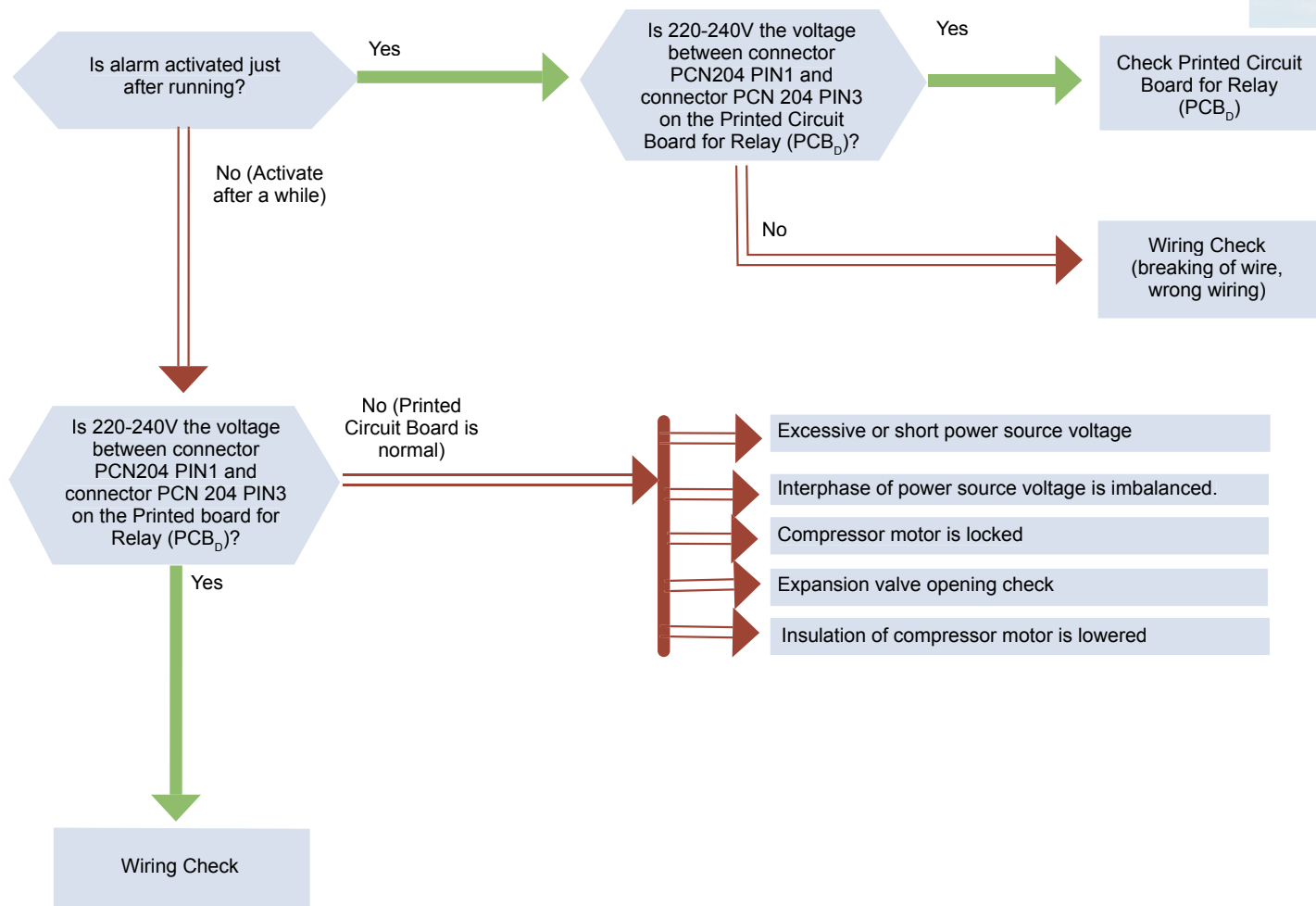

Alarm code C1-91
C5-95 **Excess Low Temperature of Cooler Inlet Refrigerant (Tr)**

[Alarm Stop Reason]

- Refrigerant temperature in water side heat exchanger inlet (Tr) is less than -6.5°C during 3 seconds. (only for cooling operation)
- *Alarm stop: 3 retries during 30 minutes. (Compressor stop, automatic restart in 3 minutes)
- Refrigerant temperature in water side heat exchanger inlet (Tr) is less than -35°C during 10 seconds. (only for defrosting operation)
- If the time between the end of a defrost, and the confirmation of the conditions to start again a defrost in the same cycle is less then 13 minutes.
- *No retry during defrosting operation. Alarm stop immediately.

[PCB Monitoring Position]

- No. 1 Cycle: PCB_{D1} (I/O PCB) CN27Tr2
- No. 2 Cycle: PCB_{D2} (I/O PCB) CN27Tr2
- No. 3 Cycle: PCB_{D3} (I/O PCB) CN27Tr2
- No. 4 Cycle: PCB_{D4} (I/O PCB) CN27Tr2
- No. 5 Cycle: PCB_{D5} (I/O PCB) CN27Tr2

[Retry Code]

- No. 1 Cycle: C1-P6
- No. 2 Cycle: C2-P6
- No. 3 Cycle: C3-P6
- No. 4 Cycle: C4-P6
- No. 5 Cycle: C5-P6

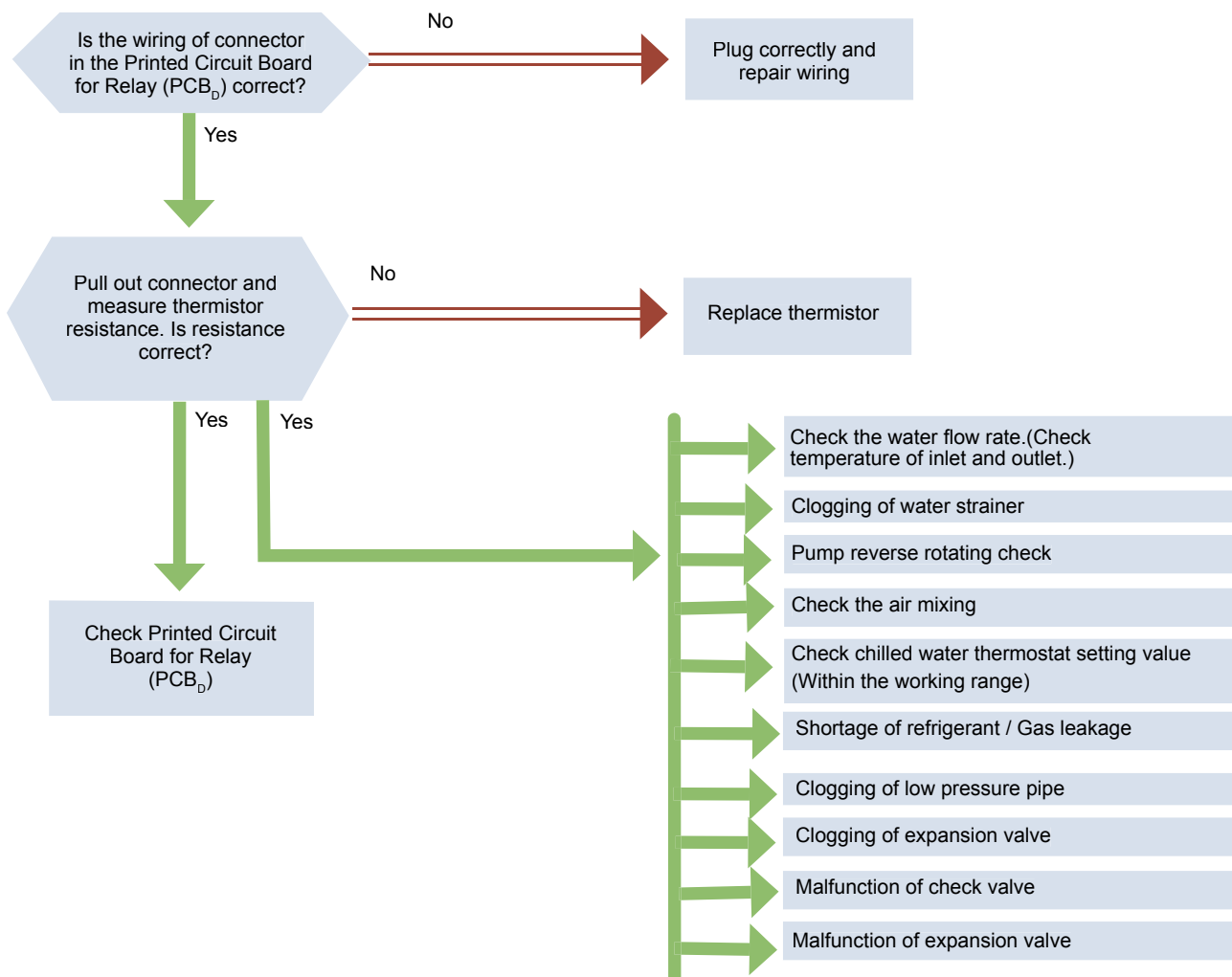

Alarm code C1-E1
C5-E5 **Low Pressure Protection by Suction Gas Thermistor (Ts)**

[Alarm Stop Reason]

- Suction Gas Temperature (Ts) is lower than -2°C during 10 seconds. (only cooling operation)
*Alarm stop: 3 retries during 30 minutes.
(Compressor stop, automatic restart in 3 minutes)

[PCB Monitoring Position]

No. 1 Cycle: PCB_{D1} (I/O PCB) CN25Ts
No. 2 Cycle: PCB_{D2} (I/O PCB) CN25Ts
No. 3 Cycle: PCB_{D3} (I/O PCB) CN25Ts
No. 4 Cycle: PCB_{D4} (I/O PCB) CN25Ts
No. 5 Cycle: PCB_{D5} (I/O PCB) CN25Ts

[Retry Code]

No. 1 Cycle: C1-P6
No. 2 Cycle: C2-P6
No. 3 Cycle: C3-P6
No. 4 Cycle: C4-P6
No. 5 Cycle: C5-P6

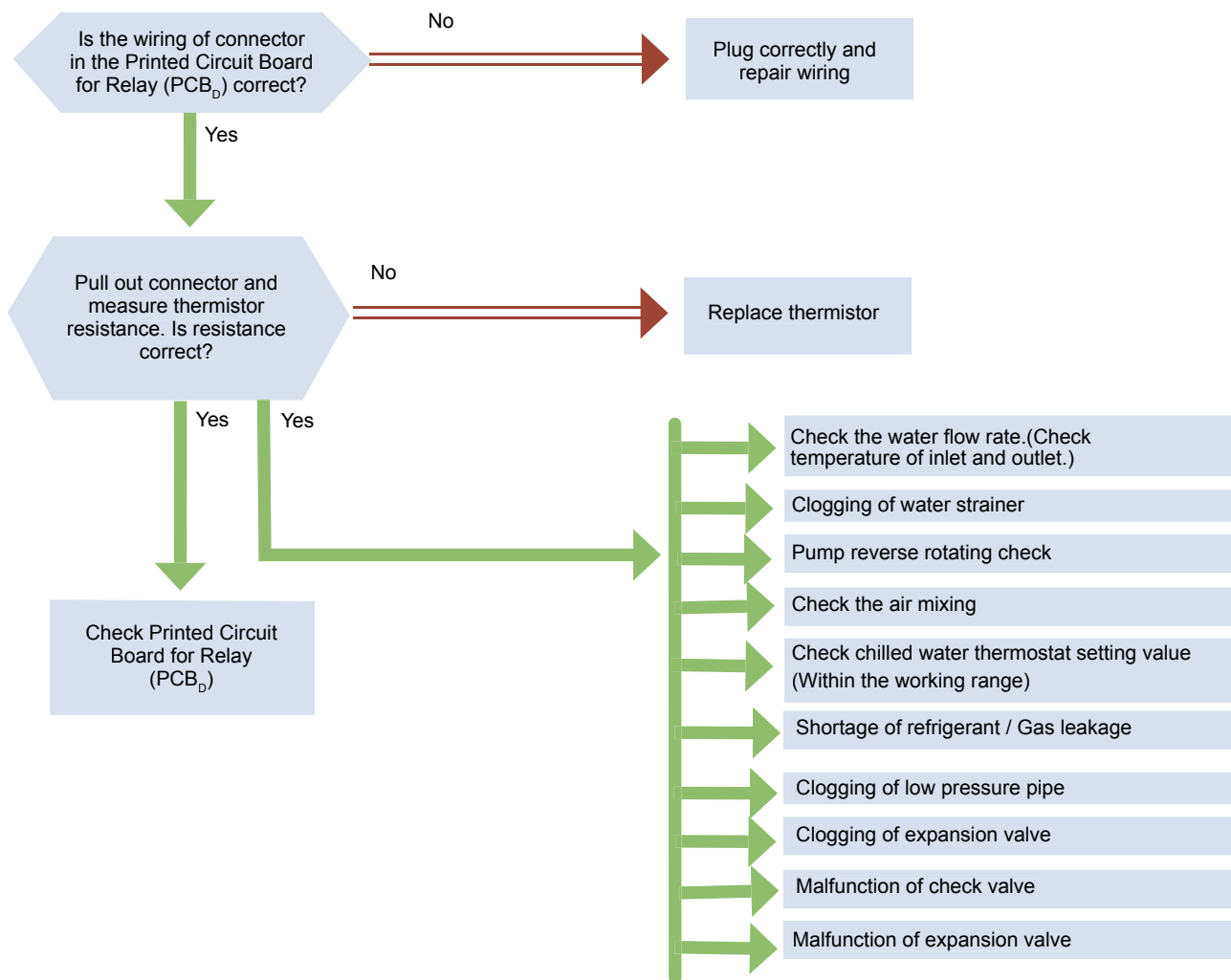

Alarm code *SP-SP*

No Feedback Signal from Water Pump

[Alarm Stop Reason]

Pump operation feedback signal (terminals 1-2) is OFF during pump Interlock (CMP) ON (terminals 3-4)

*It is available once feedback signal confirmed.

[PCB Monitoring Position]

PCB_c (CPU PCB) PCN24

⚠ ATTENTION:

During pump operation (during unit stop), Alarm is reset by

1. Feedback signal reconfirm
2. Pump stop
3. Unit operation

It is not reset by stop operation.

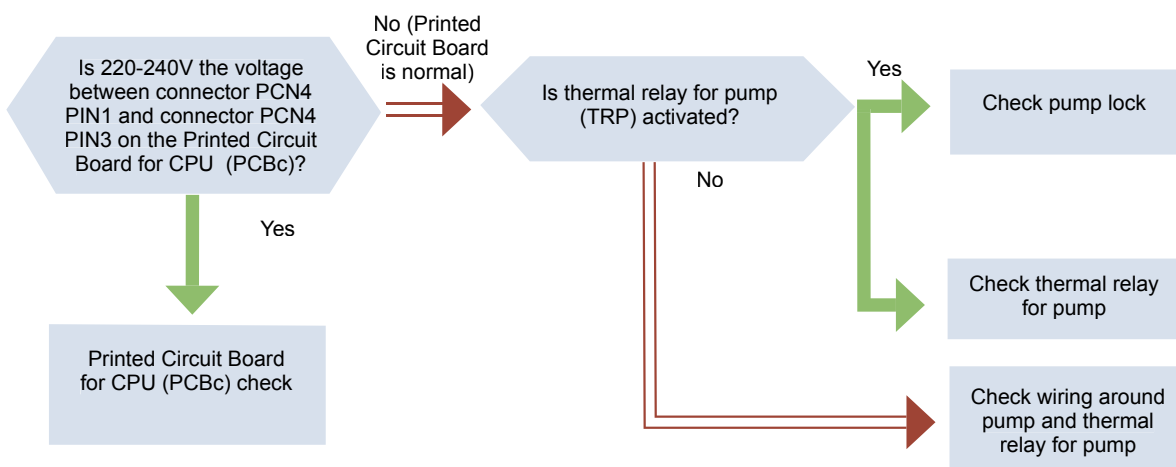

Alarm code **05-05**
C1-05
C5-05 **Phase Abnormality (Reverse Phase / Phase Failure)**

[Alarm Stop Reason]

Power source connected to unit is reversed phase or open phase.

*In case of 1~3 cycle unit, "05-05"

In case 4, 5 cycle unit, "C1-05 ~ C5-05".

[PCB Monitoring Position]

No. 1 ~ No. 3 Cycle: PCB_{D1} (I/O PCB) R, S, T

No. 4 and No. 5 Cycle: PCB_{D4} (I/O PCB) R, S, T

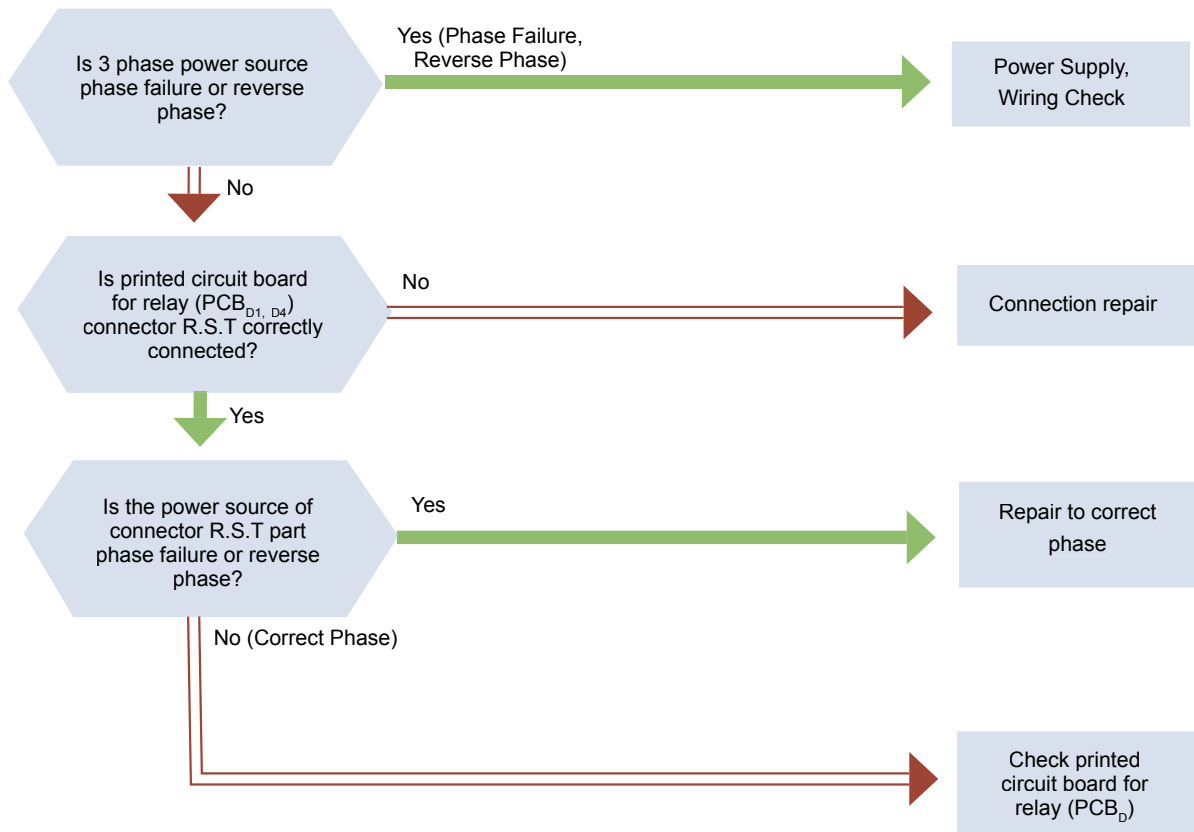

5

Alarm code 13-13
C1-13
C5-13

Activation of Freeze Protection Control

[Alarm Stop Reason]

- Chilled water temperature is lower than 2°C.(standard unit) (only cooling operation)
- PCB_C PCN13 wiring is broken.
- *"13-13" : for 1 cycle unit or if alarm is detected in inlet water temperature Thermistor or PCN13 wiring is broken.
- "C1-13 ~ C5-13": It is detected in outlet water temperature in more than 2 cycle units.

[PCB Monitoring Position]

- PCB_C (CPU PCB) CN3 (for inlet), CN4 (for No. 1 cycle outlet), CN6 (for No. 2 cycle outlet), CN7 (for No. 3 cycle outlet)
- PCB_{D1} (I/O PCB) CN23Te2 (for No. 1 cycle protection)
- PCB_{D2} (I/O PCB) CN23Te2 (for No. 2 cycle protection)
- PCB_{D3} (I/O PCB) CN23Te2 (for No. 3 cycle protection)
- PCB_C (CPU PCB) PCN13

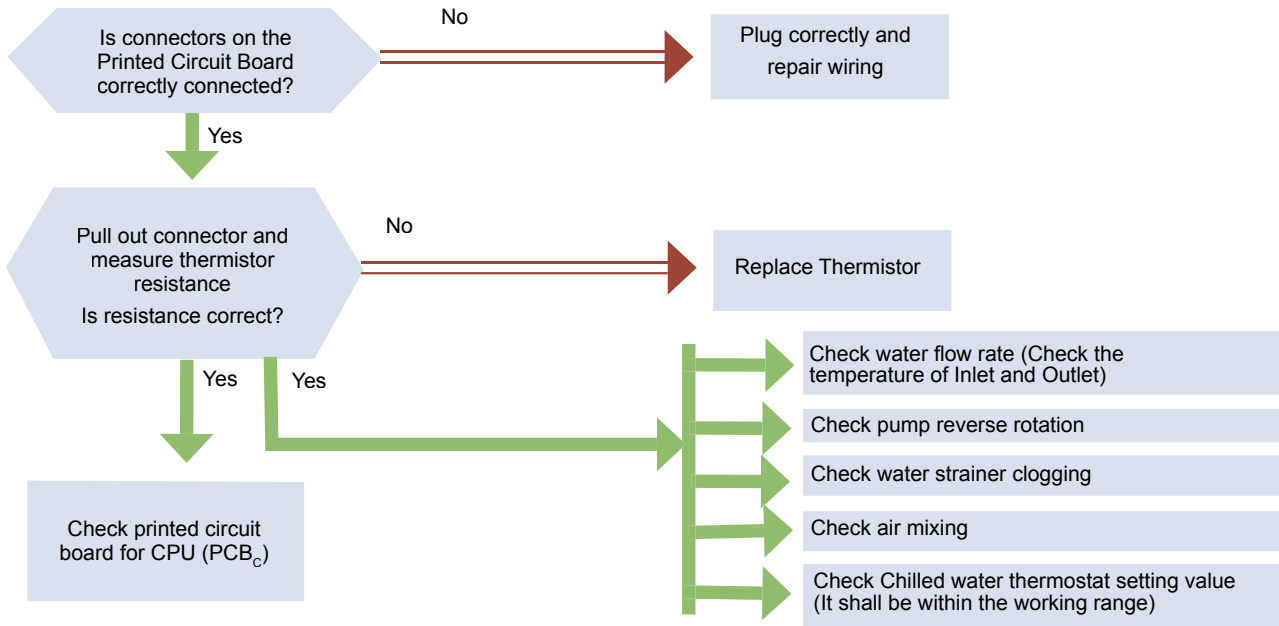

i NOTE:

- One inlet temperature Themistor is installed in each unit.
- Two outlet temperature Thermistors are installed in every heat exchanger in water side.
- The below table shows the relation between Thermistor and alarm indication as well as connecting Printed Circuit Board (PCB).

Product Model	Abnormal Code	Thermistor	PCB	Connector
RCUE 40 ~ 80 AG2 RHUE 40 ~ 80AG2	13-13	Chilled water outlet temperature Thermistor 1	PCB _C	CN4
		Chilled water outlet temperature Thermistor 2 (backside cooler)	PCB _{D1}	CN23
RCUE 80 ~ 400 AG2 RHUE 80 ~ 240 AG2	E1-13	Chilled water outlet temperature Thermistor 1	PCB _{C1}	CN4
		Chilled water outlet temperature Thermistor 2 (backside cooler)	PCB _{D1}	CN23
	E2-13	Chilled water outlet temperature Thermistor 1	PCB _{C1}	CN6
		Chilled water outlet temperature Thermistor 2 (backside cooler)	PCB _{D2}	CN23
	E3-13	Chilled water outlet temperature Thermistor 1	PCB _{C1}	CN7
		Chilled water outlet temperature Thermistor 2 (backside cooler)	PCB _{D3}	CN23
	E4-13	Chilled water outlet temperature Thermistor 1	PCB _{C2}	CN4
		Chilled water outlet temperature Thermistor 2 (backside cooler)	PCB _{D4}	CN23
	E5-13	Chilled water outlet temperature Thermistor 1	PCB _{C2}	CN6
		Chilled water outlet temperature Thermistor 2 (backside cooler)	PCB _{D5}	CN23
RCUE 40 ~ 400 AG2 RHUE 40 ~ 240 AG2	13-13	Chilled water inlet temperature Thermistor	PCB _C	CN3

5

Alarm code **14-14**
C1-14
C5-14

Activation of Water Overheating Protection Control

[Alarm Stop Reason]

- Water outlet temperature is above 59°C during compressor operation. (only heating operation)
- PCB_CPCN12 wiring is broken.
- **"14-14" : 1 cycle unit
- "C1-14 ~ C5-14 " : more than 2 cycle units

[PCB Monitoring Position]

- PCB_C (CPU PCB):
 - CN4 (for No.1 cycle outlet control)
 - CN6 (for No. 2cycle outlet control)
- PCB_C (CPU PCB) PCN12

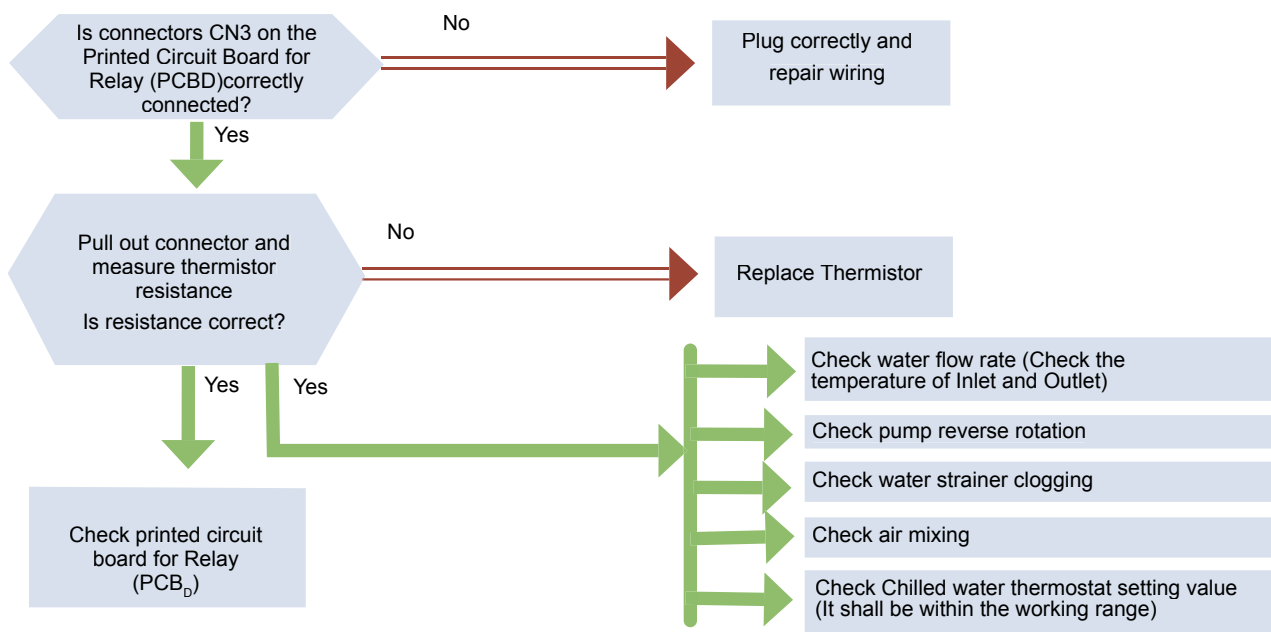

i NOTE:

The below table shows the relation between Thermistor and alarm indication as well as connecting Printed Circuit Board (PCB).

Product Model	Abnormal Code	Thermistor	PCB	Connector
RCUE 40 ~ 80 AG2 RHUE 40 ~ 80AG2	14-14	Outlet water outlet temperature Thermistor 1	PCB _{C1}	CN4
RCUE 80 ~ 400 AG2 RHUE 80 ~ 240 AG2	C1-14	Outlet water outlet temperature Thermistor 1	PCB _{C1}	CN4
	C2-14	Outlet water outlet temperature Thermistor 1	PCB _{C1}	CN6
	C3-14	Outlet water outlet temperature Thermistor 1	PCB _{C1}	CN7
	C4-14	Outlet water outlet temperature Thermistor 1	PCB _{C2}	CN4
	C5-14	Outlet water outlet temperature Thermistor 1	PCB _{C2}	CN6

Alarm code 40-40 **Operation Error / Setting Error**

[Alarm Stop Reason]

Wrong setting is performed in Dip Switch on Printed Circuit Board, or prohibited operation is performed.

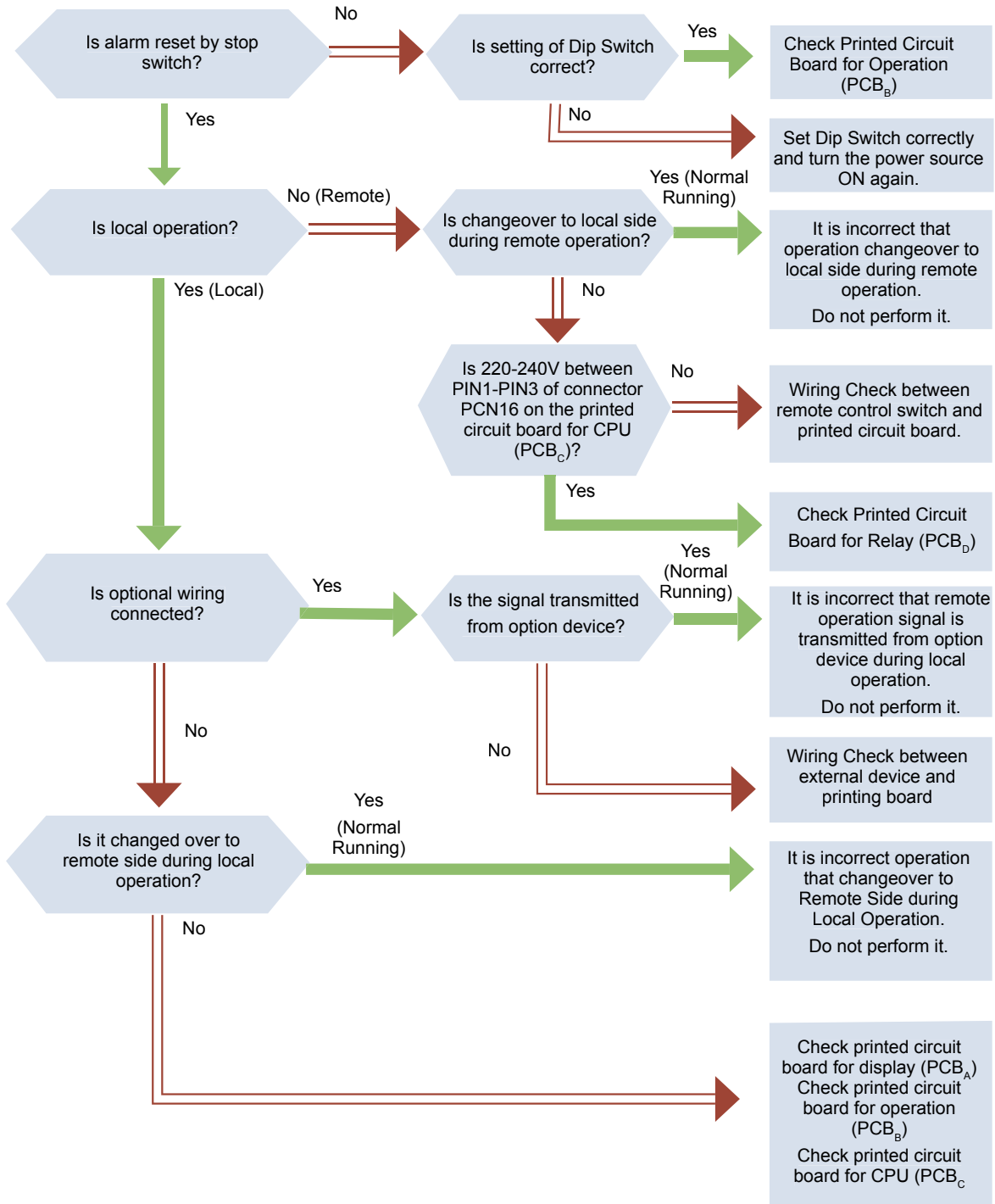

5

Alarm code *11-11* **Inlet Chilled Water Thermistor Abnormality**

[Alarm Stop Reason]

Thermistor for inlet water temperature indicates abnormal value.

[PCB Monitoring Position]

PCB_{C1} (CPU PCB) CN3

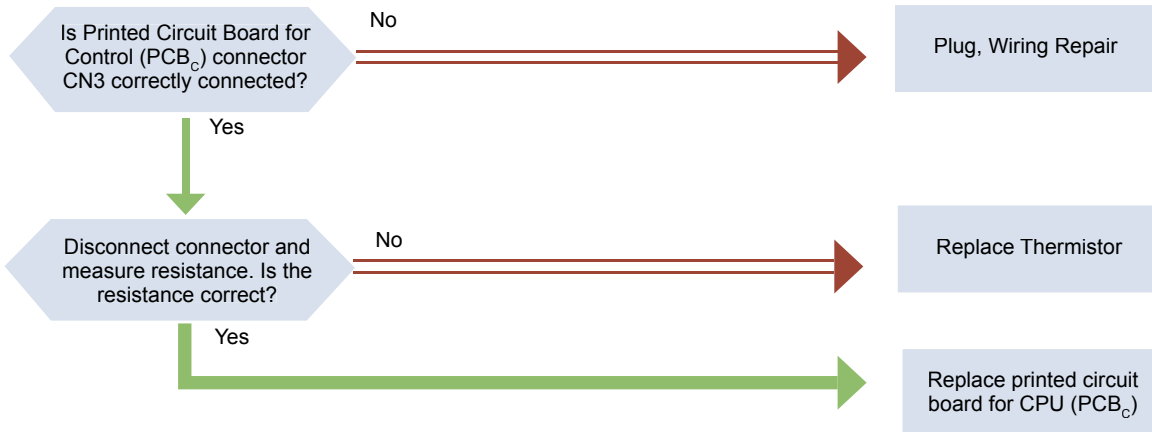

Alarm code *12-12*
C1-12
C5-12 **Outlet Chilled Water Thermistor Abnormality**

[Alarm Stop Reason]

Thermistor for outlet water temperature indicates abnormal value.

*"12-12": 1 cycle, "C1-12 ~ C5-12": more than 2 cycle units

[PCB Monitoring Position]

PCB_C (CPU PCB) CN4 (for inlet), CN6(for No. 2 cycle)

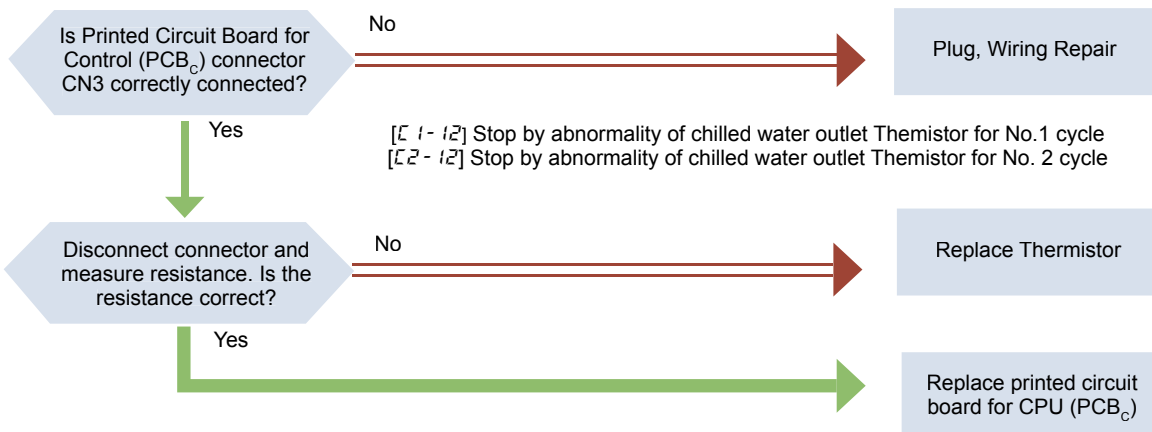

NOTE:

The connector position differs from product model.

Product Model	Abnormal Code	Thermistor	PCB	Connector
RCUE 40 ~ 80 AG2 RHUE 40 ~ 80AG2	12 - 12	Outlet water temperature Thermistor 1	PCB _{C1}	CN4
RCUE 80 ~ 400 AG2 RHUE 80 ~ 240 AG2	11 - 12	Outlet water temperature Thermistor 1	PCB _{C1}	CN4
	12 - 12	Outlet water temperature Thermistor 1	PCB _{C1}	CN6
	13 - 12	Outlet water temperature Thermistor 1	PCB _{C1}	CN7
	14 - 12	Outlet water temperature Thermistor 1	PCB _{C2}	CN4
	15 - 12	Outlet water temperature Thermistor 1	PCB _{C2}	CN6

Alarm code 11-21
 15-21 **Evaporating Temperature Thermistor Abnormality**

[Alarm Stop Reason]

Thermistor for inlet refrigerant temperature at water side heat exchanger indicates abnormal value.

[PCB Monitoring Position]

- No. 1 Cycle: PCB_{D1} (I/O PCB) CN27Tr2
- No. 2 Cycle: PCB_{D2} (I/O PCB) CN27Tr2
- No. 3 Cycle: PCB_{D3} (I/O PCB) CN27Tr2
- No. 4 Cycle: PCB_{D4} (I/O PCB) CN27Tr2
- No. 5 Cycle: PCB_{D5} (I/O PCB) CN27Tr2

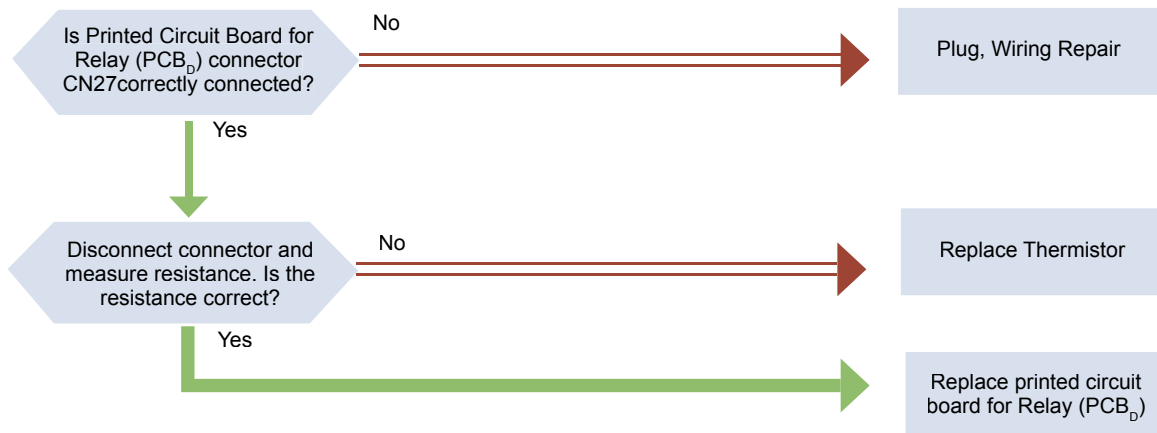

Alarm code C1-23
C5-23 **Discharge Gas Temperature Thermistor Abnormality**

[Alarm Stop Reason]

Thermistor for discharge gas temperature indicates abnormal value.

[PCB Monitoring Position]

- No. 1 Cycle: PCB_{D1} (I/O PCB) CN24Td
- No. 2 Cycle: PCB_{D2} (I/O PCB) CN24Td
- No. 3 Cycle: PCB_{D3} (I/O PCB) CN24Td
- No. 4 Cycle: PCB_{D4} (I/O PCB) CN24Td
- No. 5 Cycle: PCB_{D5} (I/O PCB) CN24Td

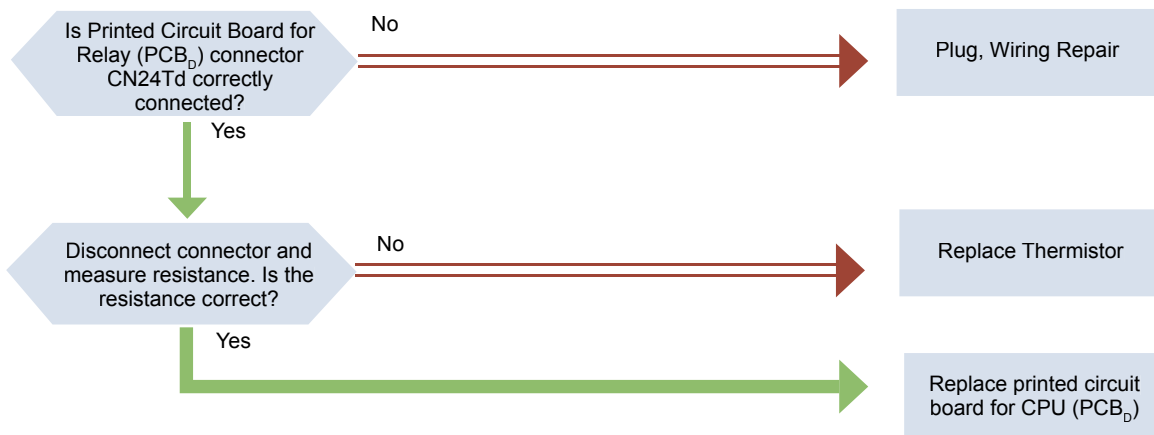

Alarm code C1-24
C5-24 **Liquid Temperature Thermistor Abnormality**

[Alarm Stop Reason]

Thermistor for detection of air side heat exchanger outlet (subcooled liquid) temperature indicates abnormal value.

[PCB Monitoring Position]

- No. 1 Cycle: PCB_{D1} (I/O PCB) CN22Te1
- No. 2 Cycle: PCB_{D2} (I/O PCB) CN22Te1
- No. 3 Cycle: PCB_{D3} (I/O PCB) CN22Te1
- No. 4 Cycle: PCB_{D4} (I/O PCB) CN22Te1
- No. 5 Cycle: PCB_{D5} (I/O PCB) CN22Te1

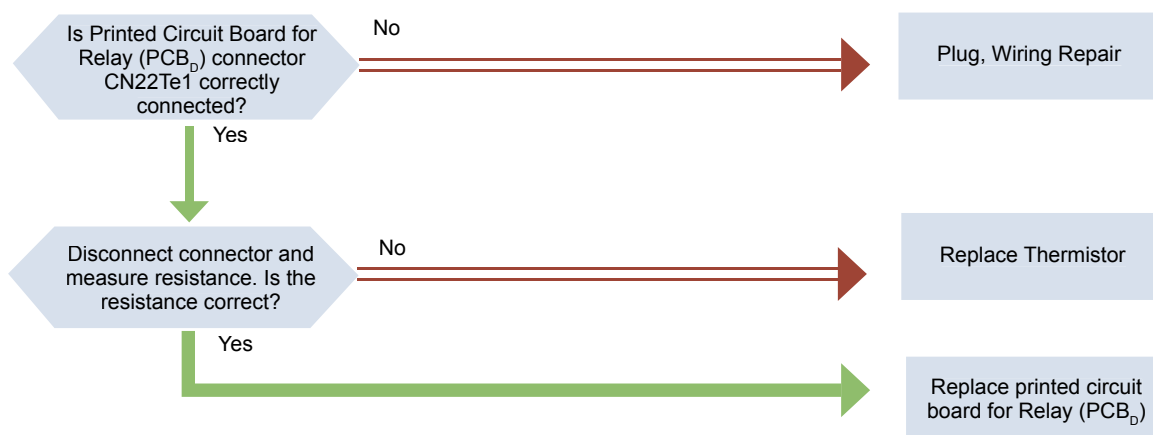

Alarm code *E1-25*
E5-25 **Abnormality of Outlet Water Temperature Thermistor for Protection**

[Alarm Stop Reason]

Thermistor for detection of water side heat exchanger outlet (backside=inside of heat exchanger) temperature indicates abnormal value.

[PCB Monitoring Position]

- No. 1 Cycle: PCBD1 (I/O PCB) CN23Te2
- No. 2 Cycle: PCBD2 (I/O PCB) CN23Te2
- No. 3 Cycle: PCBD3 (I/O PCB) CN23Te2
- No. 4 Cycle: PCBD4 (I/O PCB) CN23Te2
- No. 5 Cycle: PCBD5 (I/O PCB) CN23Te2

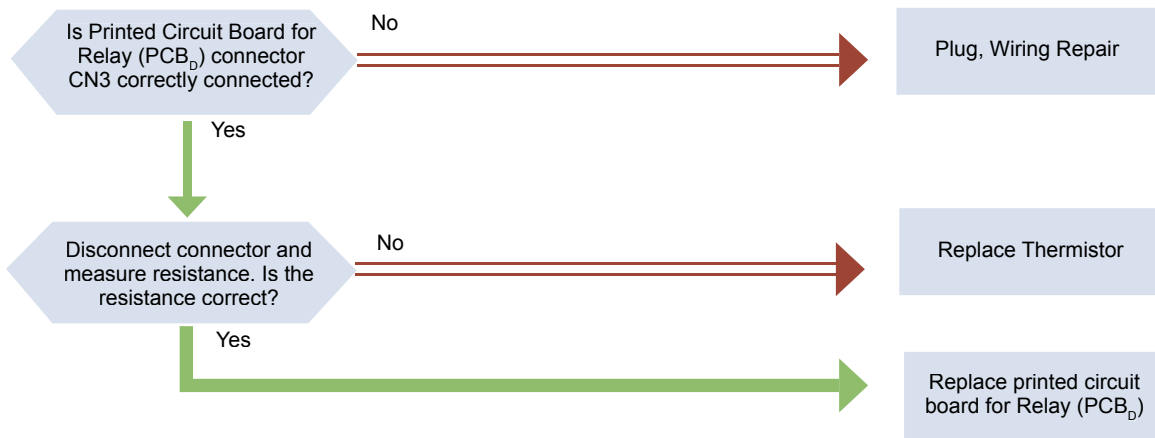

i **NOTE:**
The connector position differs from product model.

Product Model	Abnormal Code	Thermistor	PCB	Connector
RCUE 40 ~ 80 AG2 RHUE 40 ~ 80AG2	<i>E5-25</i>	Outlet water temperature Thermistor (backside of cooler)	PCB _{D1}	CN23
RCUE 80 ~ 400 AG2 RHUE 80 ~ 240 AG2	<i>E1-25</i>	Outlet water temperature Thermistor (backside of cooler)	PCB _{D1}	
	<i>E2-25</i>	Outlet water temperature Thermistor (backside of cooler)	PCB _{D2}	
	<i>E3-25</i>	Outlet water temperature Thermistor (backside of cooler)	PCB _{D3}	
	<i>E4-25</i>	Outlet water temperature Thermistor (backside of cooler)	PCB _{D4}	
	<i>E5-25</i>	Outlet water temperature Thermistor (backside of cooler)	PCB _{D5}	

Alarm code *C1-26*
C5-26

Suction Gas Temperature Thermistor Abnormality

[Alarm Stop Reason]

Thermistor for detection of compressor suction gas refrigerant temperature indicates abnormal value.

[PCB Monitoring Position]

- No. 1 Cycle: PCB_{D1} (I/O PCB) CN25Ts
- No. 2 Cycle: PCB_{D2} (I/O PCB) CN25Ts
- No. 3 Cycle: PCB_{D3} (I/O PCB) CN25Ts
- No. 4 Cycle: PCB_{D4} (I/O PCB) CN25Ts
- No. 5 Cycle: PCB_{D5} (I/O PCB) CN25Ts

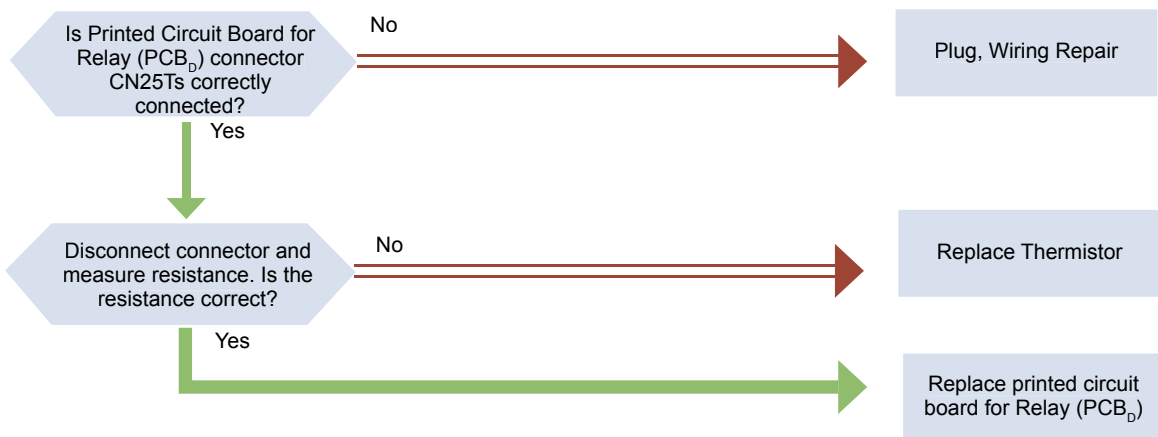

Alarm code **C1-27**
C5-27

Discharge Pressure Sensor Abnormality

[Alarm Stop Reason]

Discharge pressure sensor of compressor indicates abnormal value.

[PCB Monitoring Position]

- No. 1 Cycle: PCB_{D1} (I/O PCB) CN28Pd
- No. 2 Cycle: PCB_{D2} (I/O PCB) CN28Pd
- No. 3 Cycle: PCB_{D3} (I/O PCB) CN28Pd
- No. 4 Cycle: PCB_{D4} (I/O PCB) CN28Pd
- No. 5 Cycle: PCB_{D5} (I/O PCB) CN28Pd

5

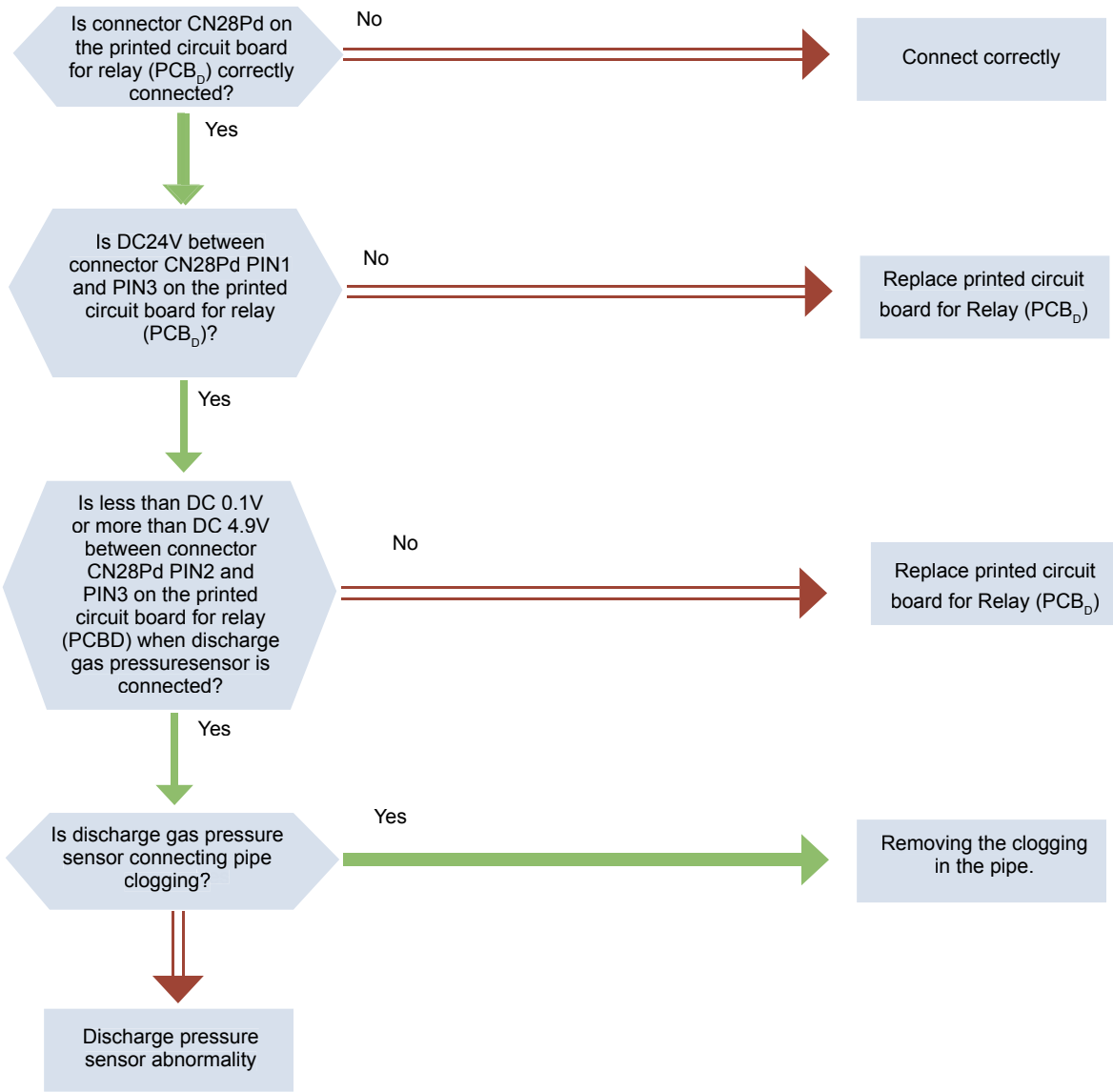

Alarm code **C1-28**
C5-28

Suction Pressure Sensor Abnormality

[Alarm Stop Reason]

Suction pressure sensor of compressor indicates abnormal value..

[PCB Monitoring Position]

- No. 1 Cycle: PCBD1 (I/O PCB) CN29Ps
- No. 2 Cycle: PCBD2 (I/O PCB) CN29Ps
- No. 3 Cycle: PCBD3 (I/O PCB) CN29Ps
- No. 4 Cycle: PCBD4 (I/O PCB) CN29Ps
- No. 5 Cycle: PCBD5 (I/O PCB) CN29Ps

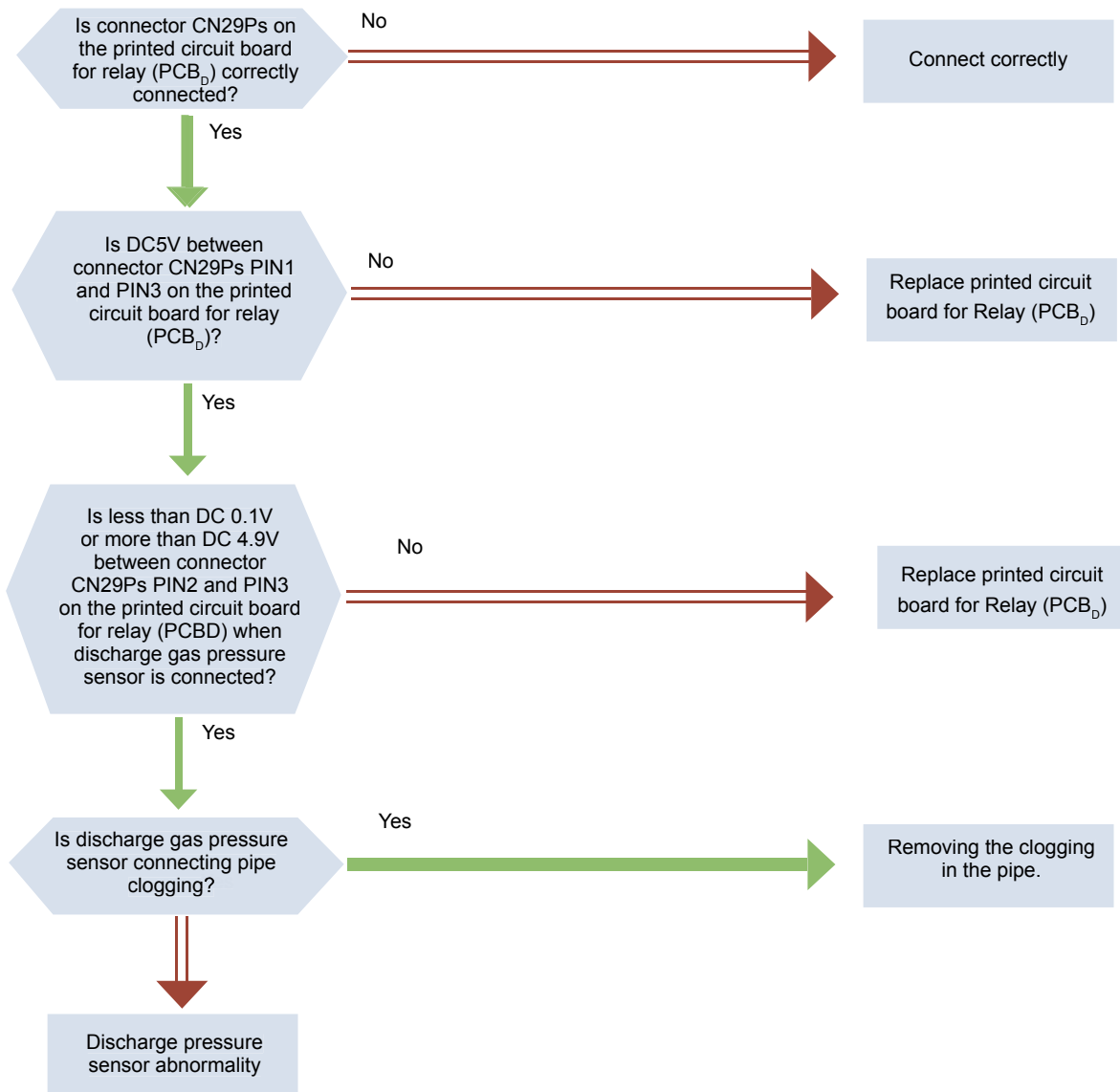

Alarm code **22-22**

**Ambient Temperature Thermistor
Abnormality**

[Alarm Stop Reason]

Thermistor for ambient temperature indicates abnormal value.

[PCB Monitoring Position]

PCB_C (CPU PCB) CN5

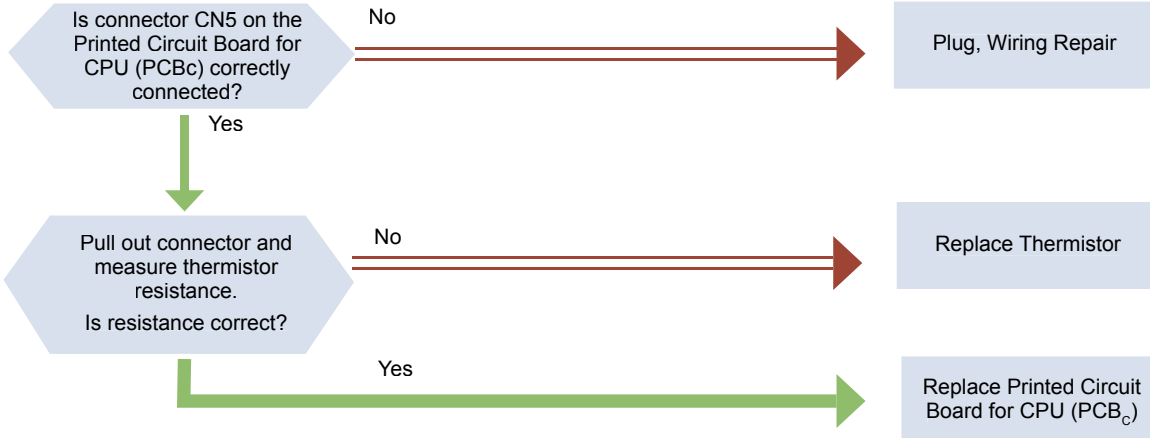

5

Alarm code **EU-EU**

Error Communication between Ctrl. PCB and Ex. Valve PCB

[Alarm Stop Reason]

Communication between Ctrl PCB and Ex.Valve PCB is not performed correctly during 30 seconds.

[PCB Monitoring Position]

PCB_C (CPU PCB) ~PCB_C (VD board) VCN13

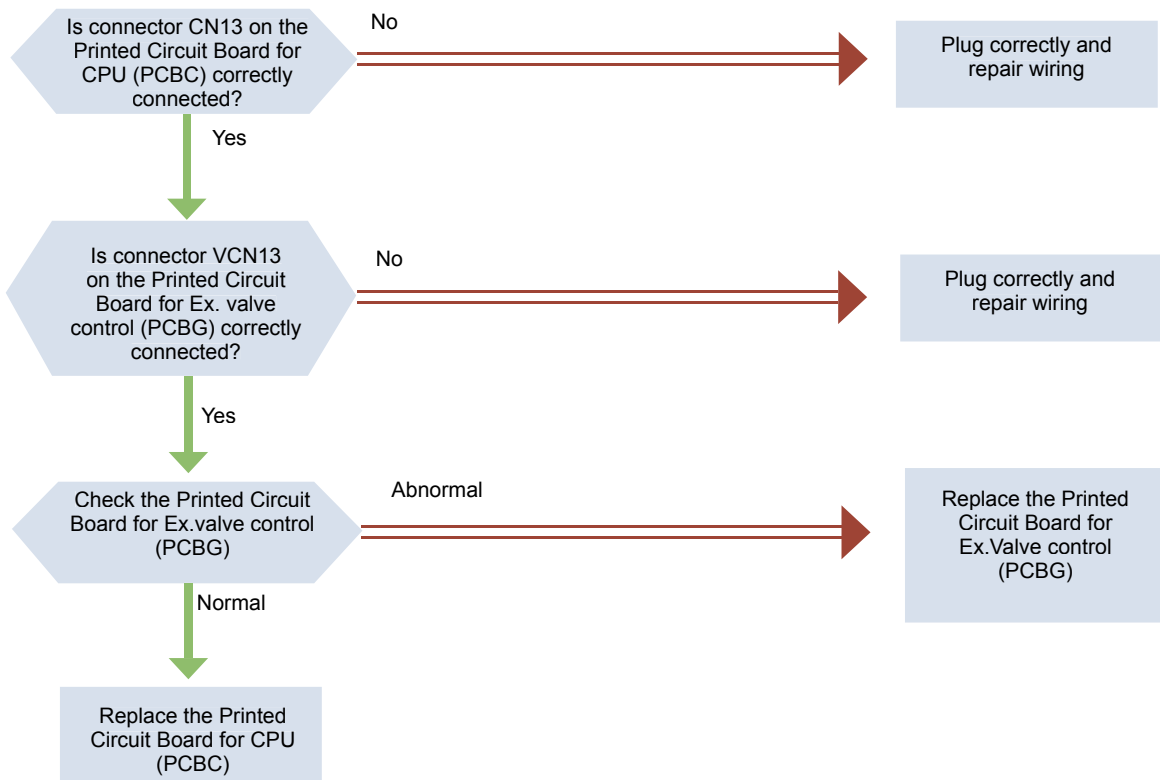

Alarm code *PU-FU*
(Flicker) **During Activation of Pump Stop Control by Excess Increase of Water Temperature**

[Alarm Stop Reason]

Water temperature is increased to 65°C by heat generation in pump during only pump running (during compressor stop: during heat operation Thermo OFF or during pump automatic operation in winter).

*If water temperature is decreased under 65°C due to pump stop, it becomes normal status automatically.

Since this is not an abnormality of chiller unit, it is not saved in alarm occurrence data.

[PCB Monitoring Position]

PCB_C (CPU PCB) CN3(for inlet), CN4(for outlet control in Unit 1), CN6 (for outlet control in Unit 2)
PCB_D (I/O PCB) CN23Te2 (for protection of Unit 1)
PCB_E (I/O PCB) CN23Te2 (for protection of Unit 2)

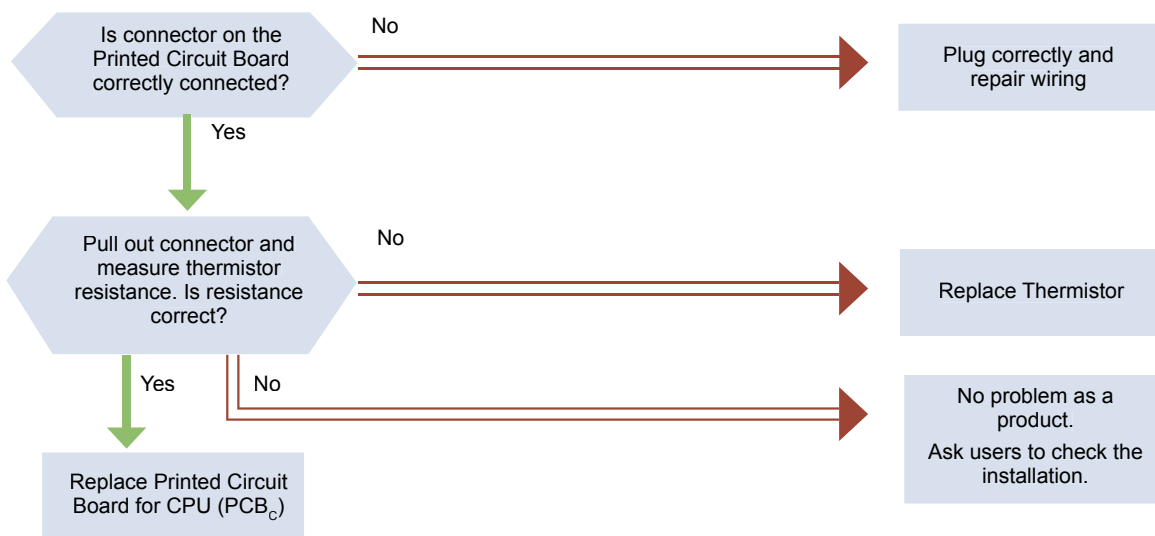

5

Alarm code *C1-F0*
C5-F0 **Abnormality of Fan Number Setting**

[Alarm Stop Reason]

Thermistor for detection of compressor suction gas refrigerant temperature indicates abnormal value.

[PCB Monitoring Position]

No. 1 Cycle: PCB_{D1} (I/O PCB) CN25Ts
No. 2 Cycle: PCB_{D2} (I/O PCB) CN25Ts
No. 3 Cycle: PCB_{D3} (I/O PCB) CN25Ts
No. 4 Cycle: PCB_{D4} (I/O PCB) CN25Ts
No. 5 Cycle: PCB_{D5} (I/O PCB) CN25Ts

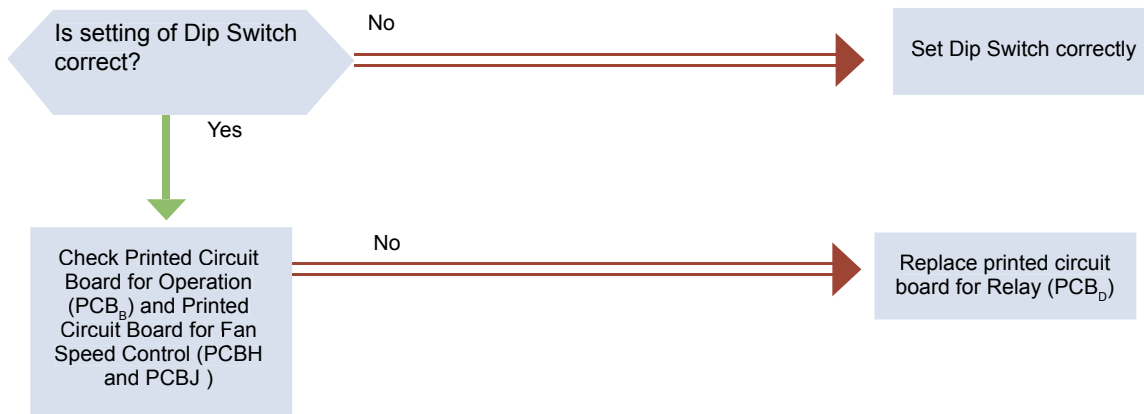

Alarm code *EE-EE* **Water flow Protection Switch Activation (at 63W use; Option)**

[Alarm Stop Reason]

Water flow protection switch is activated

[PCB Monitoring Position]

PCB_C (CPU PCB) PCN10

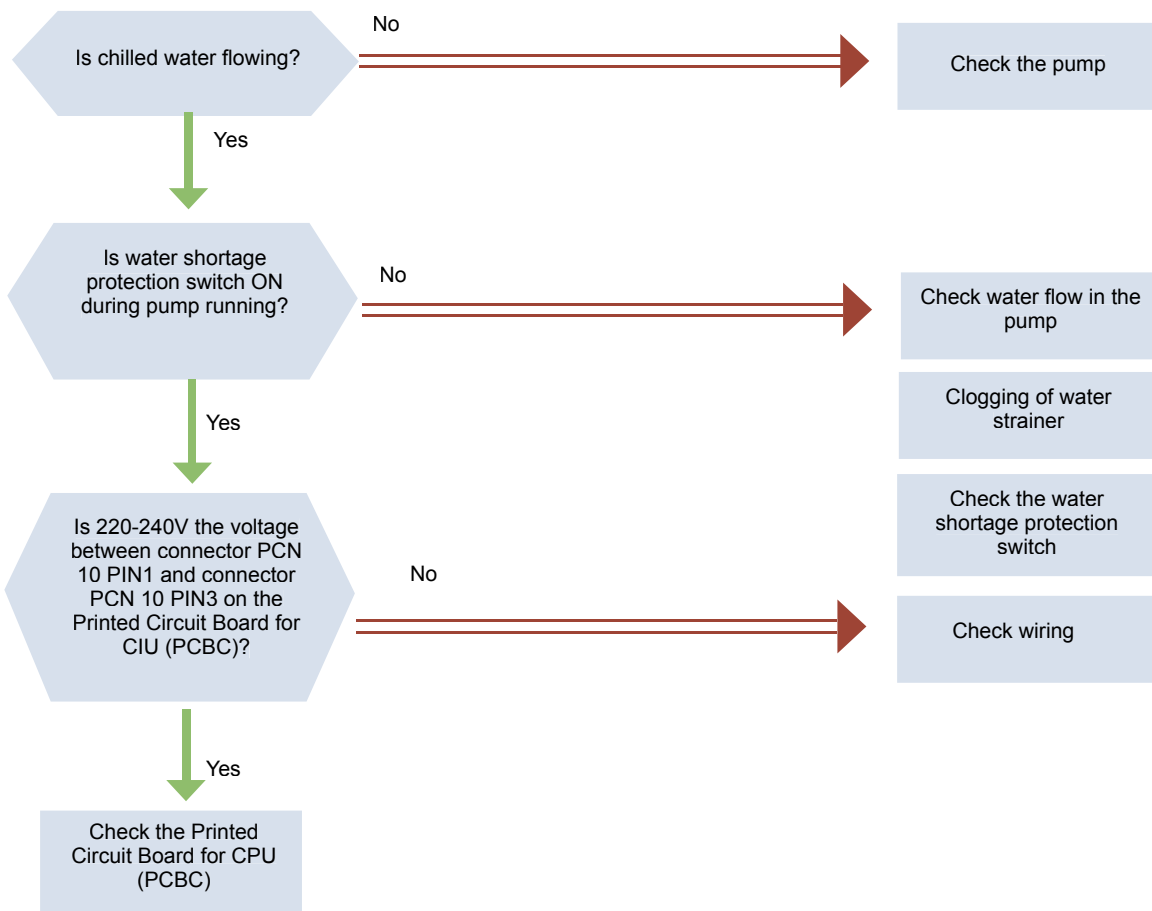

Alarm code *03-03* **System Controller Connection Abnormality (at CSC-5S connection:**

[Alarm Stop Reason]

At remote setting by remote controller, transmission is not performed for 3 minutes once it is started.

[PCB Monitoring Position]

PCB_C (CPU PCB) CN11



Alarm code *F1- 11-14* **Inverter Speed Control Abnormality**
F5- 1m: m=Fan No.

[Alarm Stop Reason]

The actual frequency is over the admissible value of inverter order frequency.

*Alarm stop: 5 retries during 30 minutes.(only corresponding fan is stopped, automatic restart in 10 seconds)

[PCB Monitoring Position]

FANM (Fan Module)

[Retry Code]

No code indication (indicated within the check mode)



NOTE:

See "Inverter position detection abnormality" in the next page for flowchart

5

Alarm code *F1- 21-24* **Inverter Excess Current Protection Abnormality**
F5- 1m: m=Fan No.

[Alarm Stop Reason]

1. DC electricity value of inverter is over the admissible value.
2. Inverter temperature is increased over the limit.
3. Error signal is detected.

*Alarm stop: 5 retries during 30 minutes. (only corresponding fan is stopped, automatic restart in 10 seconds)

[PCB Monitoring Position]

FANM (Fan Module)

[Retry Code]

No code indication (indicated within the check mode)



NOTE:

See "Inverter position detection abnormality" in the next page for flowchart

Alarm code *F1- 31-34*
F5- 1m: m=Fan No. **Inverter Position Detection Abnormality**

[Alarm Stop Reason]

The actual cycle is over the admissible value calculated by inverter order frequency.
*Alarm stop: 5 retries during 30 minutes.(only corresponding fan is stopped, automatic restart in 10 seconds)

[PCB Monitoring Position]

FANM (Fan Module)

[Retry Code]

No code indication (indicated within the check mode)

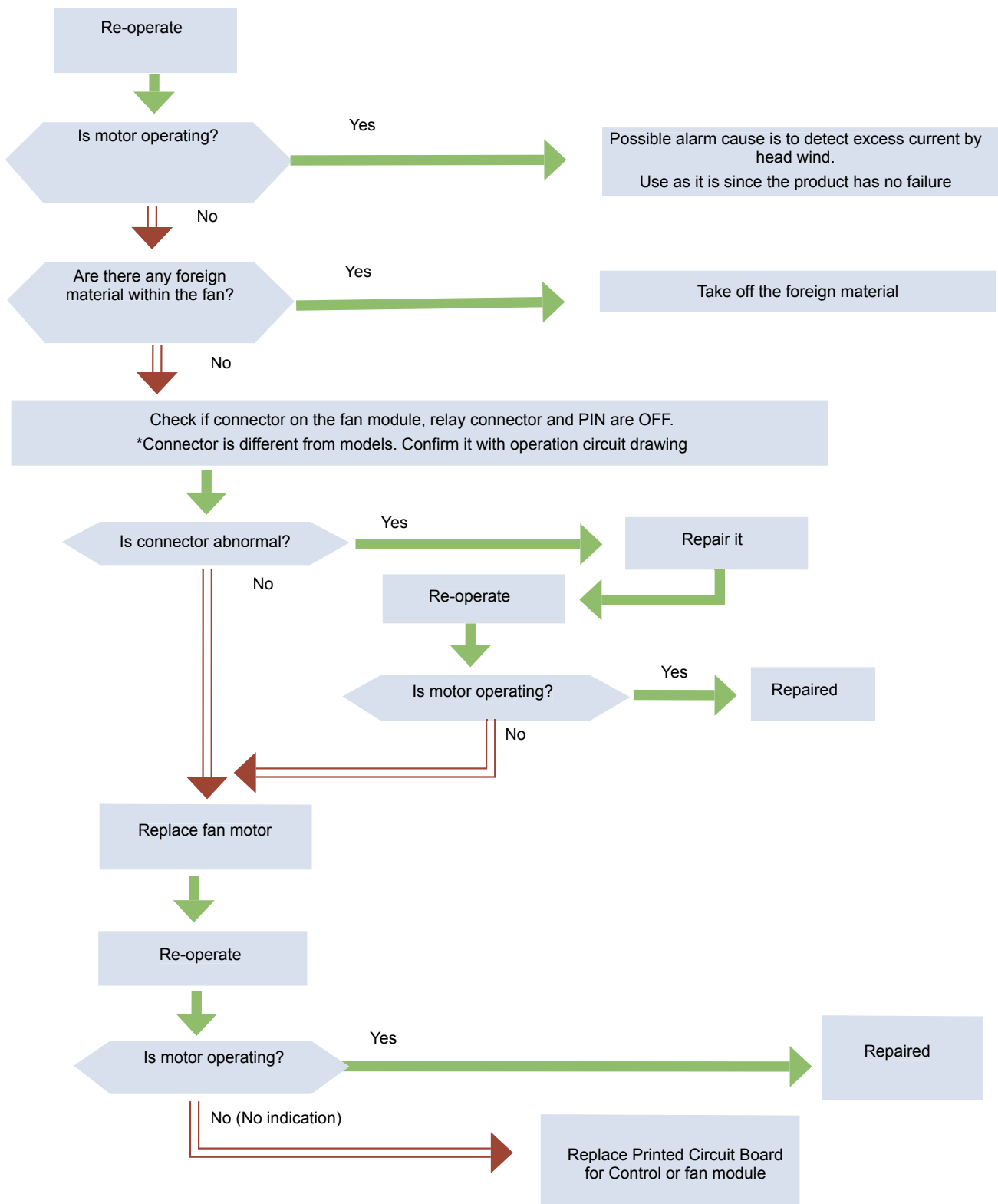

Alarm code *F1- 41-44* **Transmission Abnormality between Inverter and CPU PCB or between Fan Speed Control PCB**
F5- 1m: m=Fan No.

[Alarm Stop Reason]

Communication is not performed during a certain period.

*Alarm stop: 3 retries during 30 minutes.
(compressor stop, automatic restart in 3minutes)

[PCB Monitoring Position]

FANM (Fan Module)

[Retry Code]

- No. 1 Cycle : F1-P8
- No. 2 Cycle : F2-P8
- No. 3 Cycle : F3-P8
- No. 4 Cycle : F4-P8
- No. 5 Cycle : F5-P8

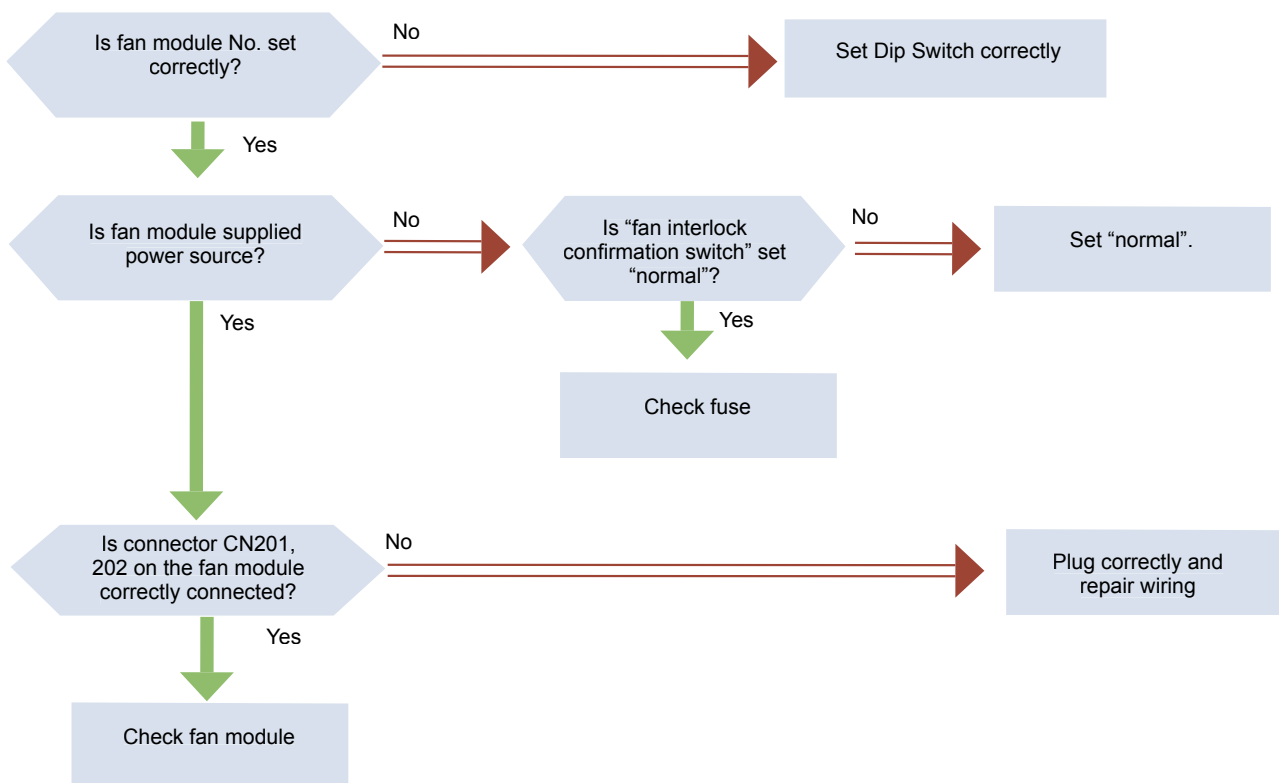

5

Alarm code *F1- 51-54* **Voltage Shortage or Excess Voltage in Inverter**
F5- 1m: m=Fan No.

[Alarm Stop Reason]

Inverter DC voltage is under or over the setting voltage level.
*Alarm stop: 3 retries during 30 minutes.(compressor stop, automatic restart in 3minutes)

[PCB Monitoring Position]

FANM (Fan Module)

[Retry Code]

- No. 1 Cycle: F1-P8
- No. 2 Cycle: F2-P8
- No. 3 Cycle: F3-P8
- No. 4 Cycle: F4-P8
- No. 5 Cycle: F5-P8

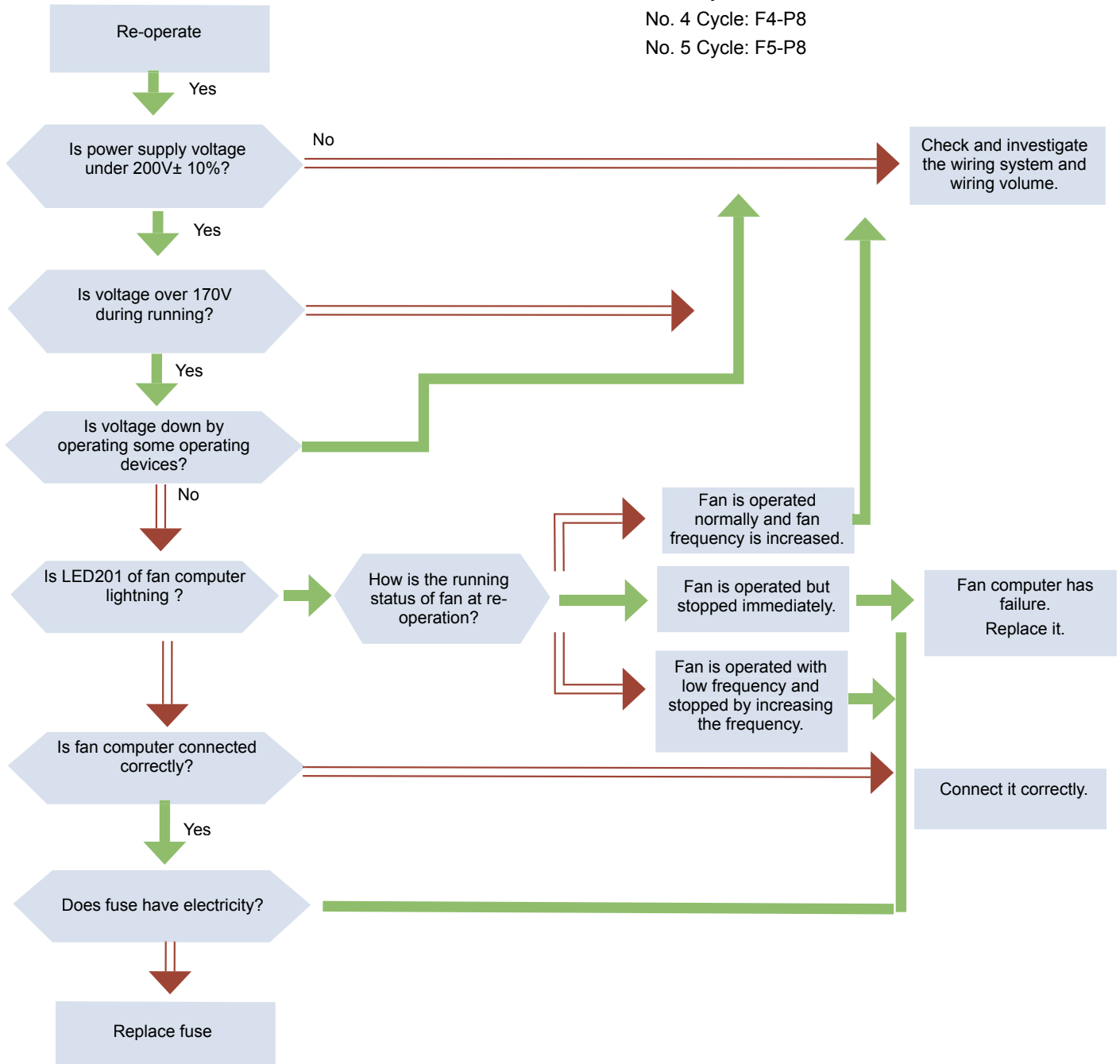

5.3. Analysis and countermeasure of abnormal running

Chiller unit has various kinds of protection devices. When the operation status is not correct due to the activation of some protection device, refer to the table below and find out the main reason to apply a countermeasure.

One failure can affect other different conditions. Thus, do not check only 1 point but analyze it from overall viewpoint in detail.

Phenomenon	Cause	Check Point	Countermeasure	
It does not run when operate	Power Failure	Measure voltage by tester.	Wait the recovery of power source	
	Power is OFF	Check power switch.	Power Switch ON	
	Fuse for power source is melted	Wiring Short Circuit	Check falling of wiring coating.	Eliminate short-circuit and replace fuse.
		Wiring Earth Fault	Measure insulation resistance.	Eliminate the earth fault and replace fuse.
		Compressor Motor Failure	Measure the interphase resistance, insulation resistance.	Replace compressor and fuse.
		Fan Motor Failure		Replace fan motor and fuse
	Fuse for operation circuit is melted	Wiring Short-circuit	Check falling of wiring device.	Eliminate short-circuit and replace fuse..
		Earth Fault in Operation Circuit	Measure insulation resistance.	Eliminate earth fault and replace fuse
		Magnetic Contactor for Compressor Motor Failure	Measure the coil resistance.	Replace magnetic contactor and fuse.
		Magnetic Contactor for Fan Motor Failure		
		Magnetic Contactor for pump motor Failure		
		Auxiliary Relay Coil Failure	Replace auxiliary relay and fuse.	
		Solenoid Valve Coil Failure	Replace solenoid coil and fuse.	
		Printed Circuit Board Short-Circuit	Conductive Foreign Particle.	Remove the particle and replace fuse
	Crankcase Heater Failure	Measure resistance.	Replace oil heater and fuse.	
	Trans Coil Failure	Measure the transformer secondary voltage.	Replace transformer.	
	Remote Control Wiring Incorrect	Wiring	Change wiring.	
	R, S, T phase of power source is phase failure or reverse phase. (05 alarm)	Check the connection of R, S, and T phase	Change to the correct phase.	
	Remote Control Switch Failure. Change-over switch of Printed Circuit Board is "Local" (40 alarm)	Check changeover switch.	Replace remote control switch. Turn changeover switch on "Remote"	
	Printed Circuit Board Failure	Wiring Connection Failure	Check the current by tester.	Repair the wiring connection
		Printed Circuit Board Failure		Replace the Printed Circuit Board
	Pump Magnetic Contactor for Pump Failure (52P)	Breaking of Coil	Measure the voltage of contact point of magnetic contactor	Replace magnetic contactor for pump
		Loose Connection		
Pump stops before compressor running	Pump locked	Check water freeze, clogging of foreign particle.	Remove it.	
	Pump Over-current relay RC Value Wrong	Check the RC value and pump running current.	Change the RC value or replace magnetic contactor.	
	Pump over-current relay failure	Push reset button and check running current.	Replace magnetic contactor.	

5

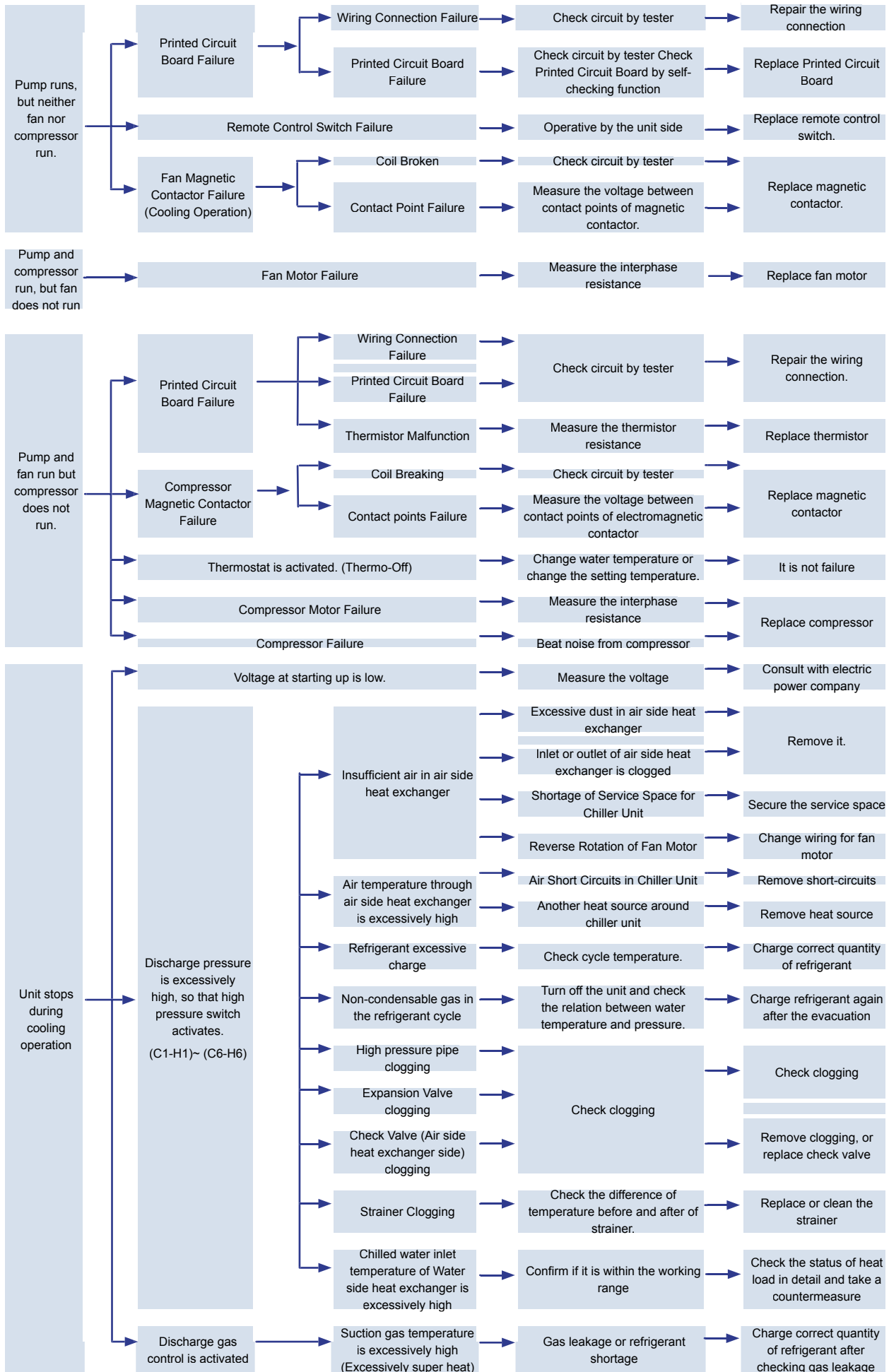

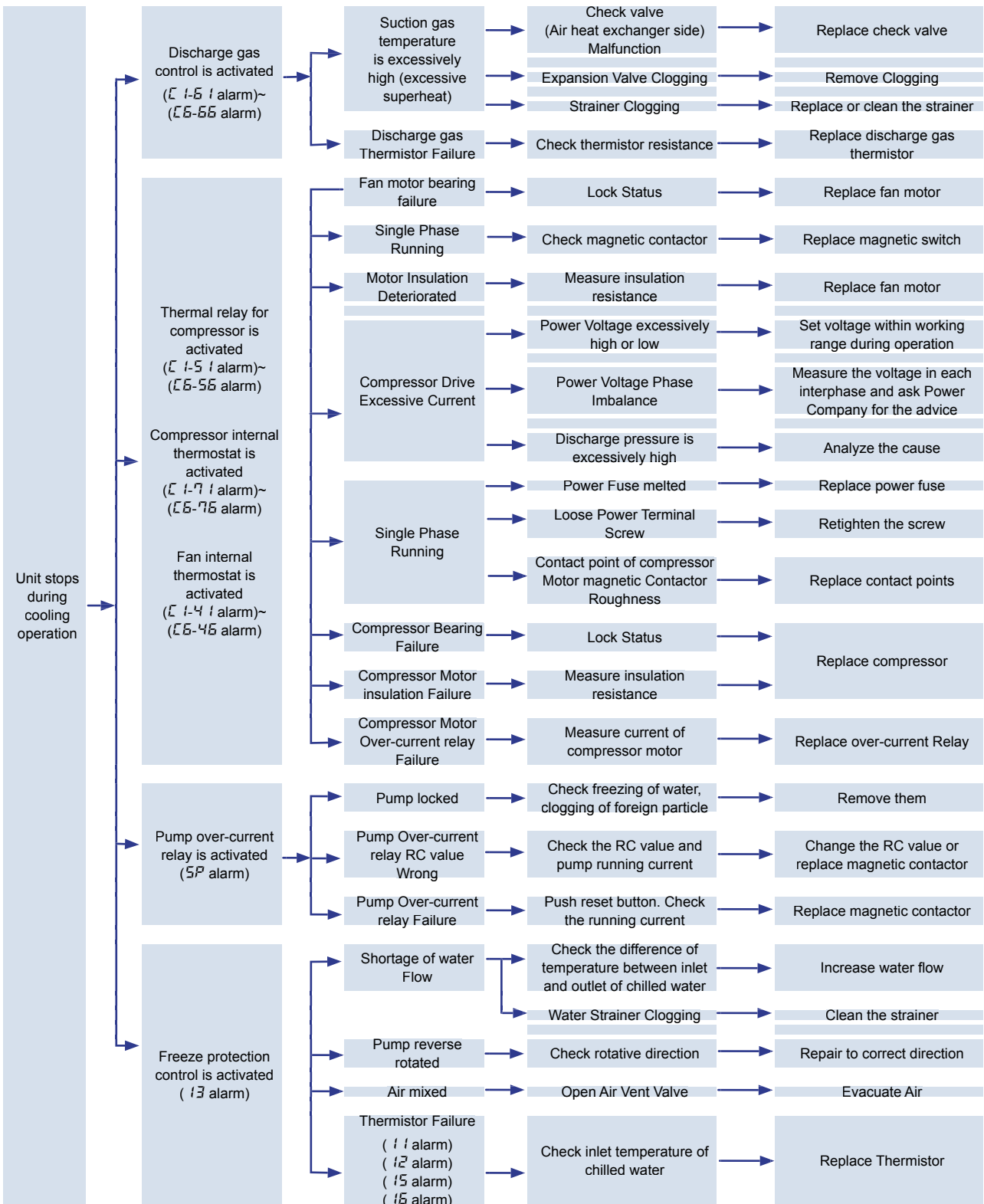

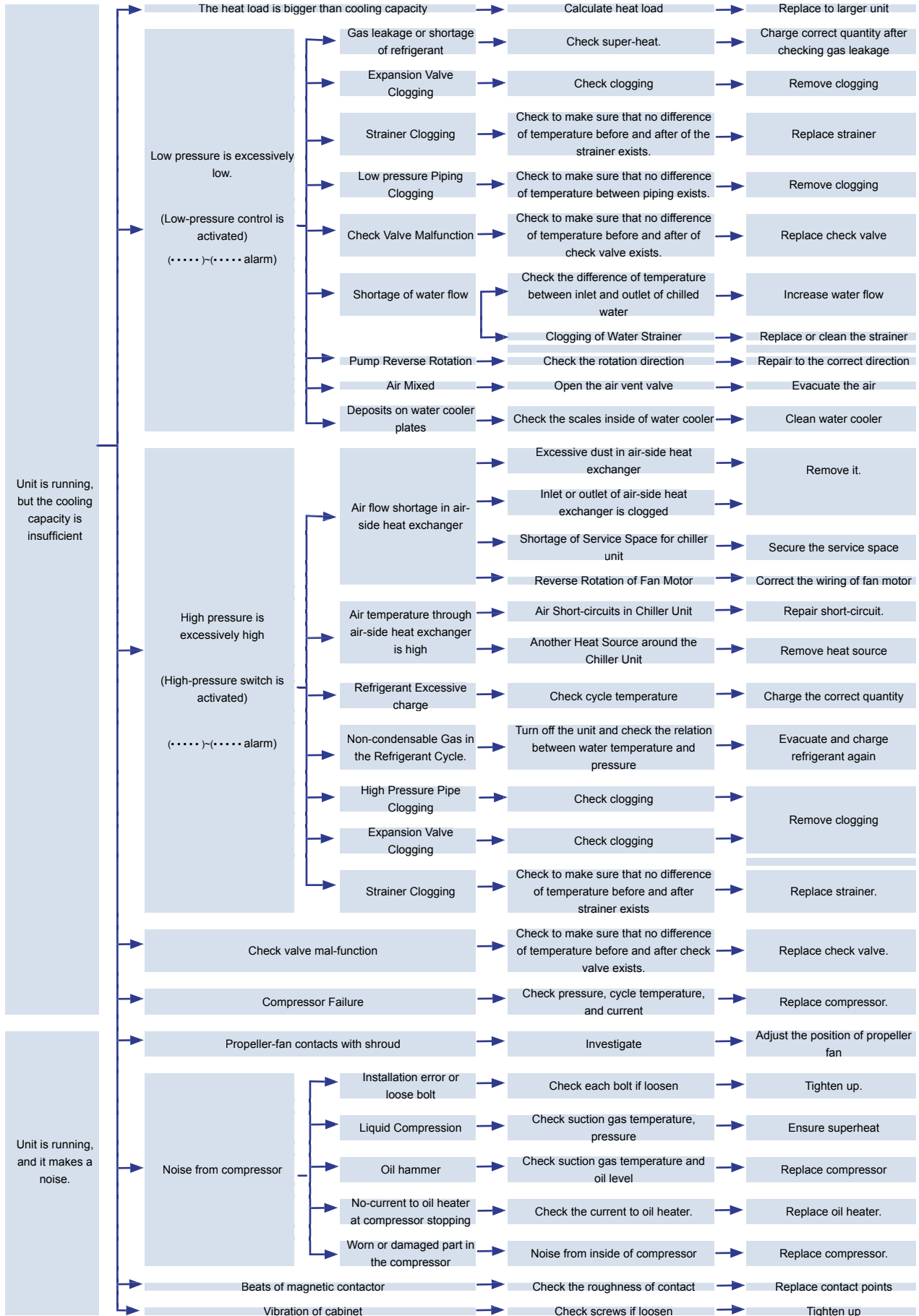

5.4. Thermistor characteristics

The thermistor is installed in this product to detect the cycle temperature such as water temperature (inlet-outlet of water side heat exchanger). Ambient temperature and outlet liquid refrigerant temperature air side heat exchanger. The temperature characteristics are shown in the below figures:

5.4.1. Thermistor temperature characteristics (All temperature except discharge gas)

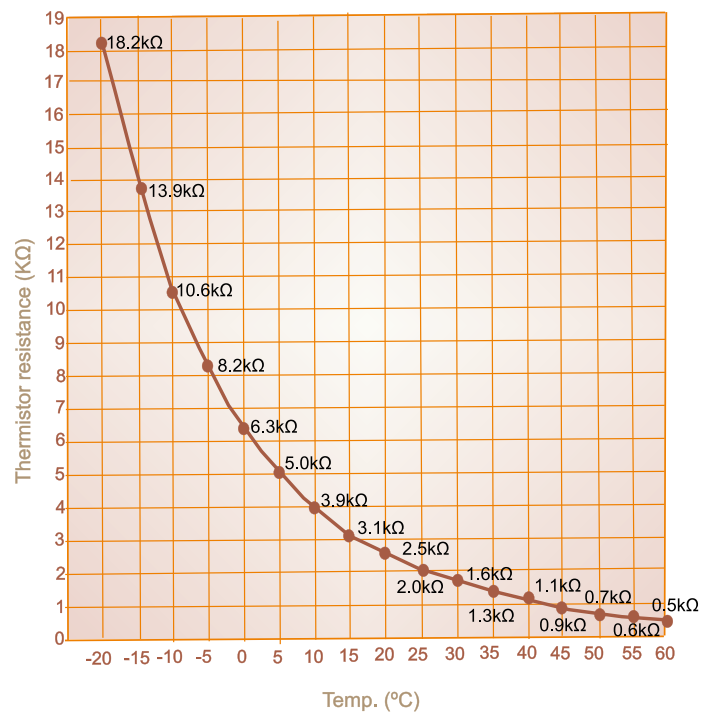

5.4.2. Thermistor temperature characteristics (Ambient)

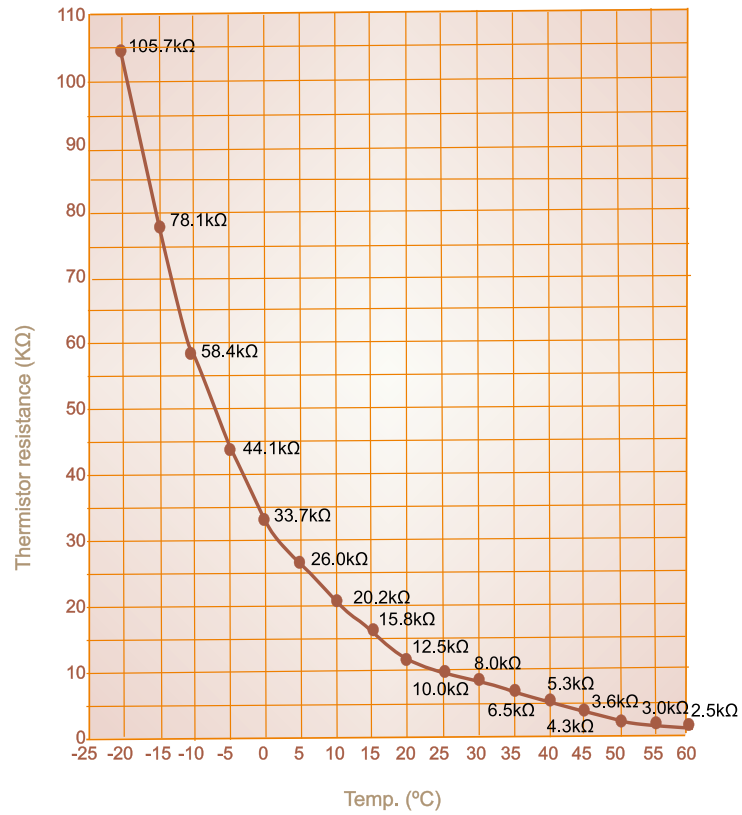

5.4.3. Thermistor temperature characteristics (Discharge gas temperature)

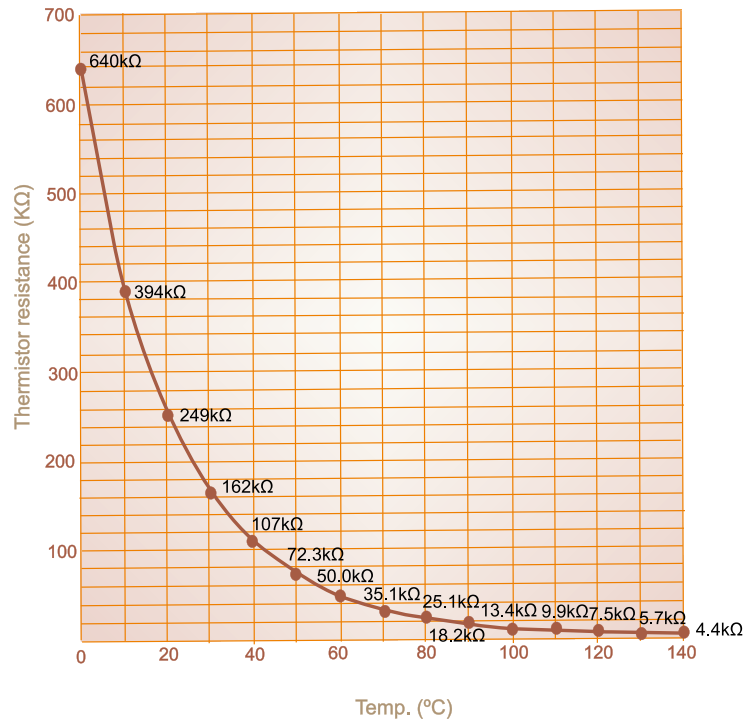

6.Maintenance

This chapter describe the procedure of the maintenance of the Air cooled water chillers.

Content

6.	Maintenance	149
6.1.	Maintenance criteria	150
6.2.	Maintenance criteria of Screw Compressor.....	152
6.3.	Maintenance of Water Quality	153
6.3.1.	Water to be used	153
6.3.2.	Criteria of Water	153
6.3.3.	Maintenance method of Water Quality	155
6.4.	Cleaning of water side heat exchanger	157
6.4.1.	Cleaning method>	158
6.5.	Check items in daily operation.....	160
6.6.	Caution on handling of R407C	160
6.6.1.	Refrigerant	160
6.6.2.	Refrigerant oil.....	161
6.6.3.	Refrigeration cycle complete parts	162
6.6.4.	Reference materials.....	162
6.7.	Manual at compressor overall check and parts check.....	162
6.7.1.	Collection of refrigerant.....	162
6.7.2.	Structure and Start-up method of Compressor	163
6.8.	Refrigerant cycle diagrams.....	166
6.8.1.	Refrigerant cycle diagram of Hitachi Air-Cooled Water Chiller (RCUE 40, 50, 60, 70, 100, 120, 140, 180, 210, 280, 350 AG2)	166
6.8.2.	Refrigerant Cycle Diagram of Hitachi Air-Cooled Water Chiller (RCUE 80, 160, 240, 320, 400 AG2) with economizer.....	167
6.8.3.	Refrigerant Cycle diagram of Hitachi Air-to-water Heat Pump Chiller (RHUE 40, 50, 60, 70, 100, 120, 140, 180, 210AG2)	168
6.8.4.	Refrigerant Cycle diagram of Hitachi Air-to-water Heat Pump Chiller (RHUE 80, 160, 240 AG2) With economizer.).....	169
6.9.	Overhaul work	170
6.10.	Vacuuming Procedure	170
6.10.1.	Vacuuming	170
6.10.2.	Leave	171
6.11.	Additional refrigerant insertion.....	172
6.11.1.	Confirmation of tank.....	172
6.11.2.	Measurement device used for refrigerant insertion.....	173
6.11.3.	Procedure for refrigerant insertion	173
6.11.4.	Check of leakage position	174
6.11.5.	Caution at Replacement of Expansion Valve	175

6.1. Maintenance criteria

Check Item	Check Frequency	Criteria (procedure)	Remarks	
1. General				
Noise	A/N	Confirm if there is no abnormal noise.	Judge from aprox. 1m from the control panel surface.	
Vibration	A/N	Confirm visually if there is no abnormal vibration		
2. Cabinet				
Outside board and inner	Dirt	A/N	Clean with cloths	
	Rust	A/N	Perform repair painting with Anticorrosion paint	
	Vibration	A/N	Re-tighten screws	
3. Refrigerant Circuit				
General	Refrigerant leakage	once/ season	Confirm if there is no refrigerant leakage by using detecting device in each component and pipe connection parts. As for checking for leakage in water cooler and condenser, confirm it with the air discharged to water inlet and outlet, and in this, case water should be drained.	
	Capillary pipes	once/ season	Perform visual check if there is no contact or resonance.	
Compressor	Noise	A/N	Confirm if there is no abnormal noise at starting, operating and stop.	
	Oil leakage bleed	A/N	Confirm if there is no oil leakage or bleed from the compressor.	
	Oil level	A/N	Perform visual check by sight glass.	
	Insulation Resistance	once/ season	More than 3MΩ at 500V DC	
	Oil Heater	once/ season	Apply current during compressor stop.	
	Ageing of Vibration Insulation rubber	once/ season	Touch and confirm if they have rubber elasticity.	
	Intermediate check (1)	once/ 3,000 hr	Pay special attention to noise, vibration and oil leakage etc.	See following "maintenance criteria of Screw compressor" for details
	Intermediate check (2)	once/ 6,000 hr	Confirm if safety device and protection device function well.	
Overhauling	once/ 24,000 hr (water-cooled) 40,000 hr (Air-cooled)	Overhaul the compressor and check it according to the specialist' advice.		
Condenser (air-cooled)	Fin clogging	once / season	Clean it spraying warm water (less than 40°C).	
Condenser (water-cooled)	Water flow, water temp.	A/N	Confirm if they are within the criteria	See technical catalogue for details.
	Water quality	once/ month	Confirm if it is within the criteria.	See technical catalogue for details.
	Cleaning	A/N	Confirm if high pressure is within the criteria. Perform the predetermined cleaning.	Frequency of cleaning differs depending on result of water quality or operation time.
	Drain water	once/ season	If condenser is not used for intermediate or long period, drain water. At this time, open also plug for draining water and for removing air.	

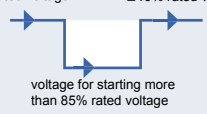
Check Item		Check Frequency	Criteria (procedure)	Remarks
3. Refrigerant Circuit (Cont.)				
Water Cooler	Cleaning	once/ season	Perform the predetermined cleaning.	Frequency of cleaning differs depending on result of water quality or operation time.
	Water flow, water temp.	A/N	Adjust them so that standard operation pressure is kept.	See technical catalogue for details.
	Drain water	once/ season	If the water cooler is not used for intermediate or long period, drain water in the heat exchanger of water side.	Drain also water in pipes.
	Water quality	once/ month	Confirm if it is within the criteria.	See technical catalogue for details.
4 way valve	Operation	once/ season	Confirm if switching cooling/heating is performed smoothly.	Only for air-cooled heat pump type
Expansion valve (Mechanical)	Operation	once/ month	Confirm if low-pressure changes smoothly by turning adjustable screw.	See technical catalogue for details.
Expansion valve (Electronic)	Operation	once/ season	Touch it to confirm if it functions correctly when zero reset is performed automatically just after power ON.	
Strainer	Clogging	once/ month	Confirm if there is no pressure difference inlet and outlet of strainer	
Solenoid valve	Operation	once/ month	Confirm if valve opens or closes smoothly.	
Stop valve	Operation	once/ month	Confirm if valve functions smoothly.	
High pressure switch	Operation	Once / month	Confirm if it is activated correctly with the value of safety and control device setting in technical catalogue.	Pay attention to fluttering of contact parts at operation.
4. Electrical system				
Electricity in general	Supply voltage	A/N	Supply voltage is as follows: $\pm 10\%$ rated voltage $\pm 10\%$ rated voltage 	
	Insulation resistance	once/ season	More than 1MΩ at 500 V Mega in every electrical devices.	
	Connection of electrical wire	once/ season	Confirm if the terminal does not loose or coat of wire is not removed.	
	Earth wire	once/ season	Confirm if they are installed correctly.	
	Fuse	once/ season	Confirm if the capacity of fuses is correct.	
Electrical component	Magnetic contactor	once/ season	Confirm if there is no abnormal noise or sparks by switching ON→ OFF. Confirm if it is correct apparently.	The interval of switching ON↔OFF is more than 3min.
	Auxiliary relay	once/ season	Confirm if they are operated smoothly.	
	PCB	once/ season	Confirm if they are operated correctly.	
	Operation SW	once/ season	Confirm if they are operated smoothly.	
	Transformer	once/ season	Confirm if there is no abnormality apparently.	

6.2. Maintenance criteria of Screw Compressor

Classification	Time and year	Model	Performance items
Daily check	Every day		<ul style="list-style-type: none"> - Save of operation situation - (pressure, temperature, voltage, current value, remarks etc.)
Periodically check	Every 6,000 hrs		- Operation check of safety device, protection device
	Every one year		
	24,000 hrs	air-cooled	- Overhaul check of compressor and parts check
	Every 5 years		- Lubricant oil
	40,000 hrs	water-cooled	
	Every 5 years		
Remarks	Take the shorter period		- According to purpose or conditions of use, work items shall be added individually.

Item	Time	Year/month to change or check (min)					Remark
		1 month	6 month	1 year	5 year (3 year)	40,000 hr (24,000 hr)	
							() is for air-cooled.
Operation test of safety device and protection device							
1	High pressure switch					○	
Check of lubricant oil and change it							
2	Refrigerant oil					●	
3	Suction gas strainer, oil strainer.					○	
Decomposition of compressor							
4	Bearing					●	
5	Rotor					○	
6	thrust liner					●	
7	Set of tooth lock washer (tighten the nuts)					●	Change them at the same time as bearing
8	Set of P.K.O ring					●	
9	Set of Teflon ring					●	



NOTE:

- ● : part change ○ : part change if abnormality is detected in the check
- This table is applied in case that operation condition is good and operation record is fully equipped.
- Perform compressor check according to the compressor service manual and technical notice.

6.3. Maintenance of Water Quality

This air-conditioning device uses water as a heat source (for cooling) or as a media (chilled water, heat water) for use of heat. Therefore, it is necessary to select suitable water and control it to maintain the quality and performance and avoid possible problems.

Serious failure of plate heat exchanger may stop the units function and cause high expenses for its repair. Therefore, it is indispensable to promote the maintenance and selection of water for the chiller installation.

Read the below criteria of water quality very carefully to avoid any troubles.

In case of using some chemical products for water treatment, it is recommended to consult with manufacturers specialised in water treatment, since characteristics of chemical agents may differ with product specifications.

6.3.1. Water to be used

Water to be supplied to the chiller should be running water (clean water), industrial water or groundwater. Other special water like pure water cannot be used in the standard product.

6.3.2. Criteria of Water

The later table shows the guideline of water quality regulated by JRAIA. Each criteria is set for water for cooling and for heating. The compliance of this criteria is premised on the product guarantee.

◆ Explanation of Main Items in Water Quality Maintenance>

- pH (hydrogen-ion concentration)

pH is used as a measure to judge acidity, neutral and alkalinity of water. It is a big factor in taste, corrosion, purification effect in water treatment, disinfection effect in chloride treatment, water stain formation, and other fields like analytic chemistry, biochemistry etc. The below figure shows an example of relation between pH value and corrosion.

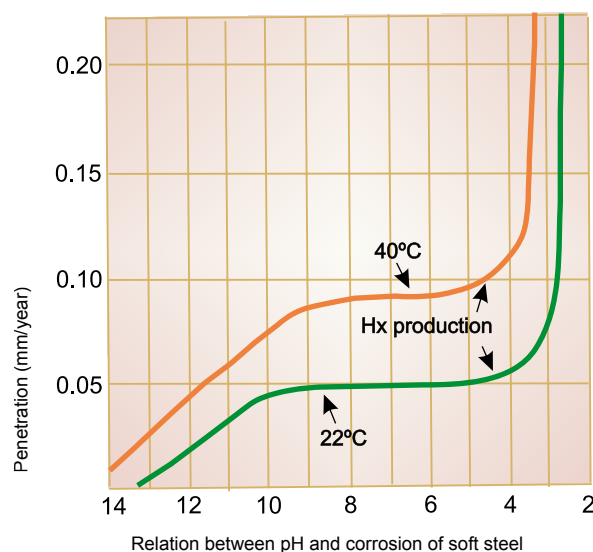

- Electrical conductivity

To know the outline of water quality, it is effective to measure electrical conductivity. This value is determined by quality and quantity of dissolved chlorine, and generally water with a greater value of electrical conductivity is not suitable since it has a lot of substance causing corrosion and lime.

- Chloride ion

Chloride ion has an important property regarding corrosion and corrosion is higher in water with a big amount of chloride ion although pH value is free of corrosion. Chloride ion does not have oxidising property, however precious metal is penetrated if chloride ion combines with oxidant or dissolved oxygen.

- Sulfate ion

Sulfate ion is a cause of corrosion, but it gives an indication for line formation. If running water has a great amount of sulfate ion, it will become rusty water.

- Acid consumption (pH4.8) = M alkali level
It shows the volume of hydroxide, carbonate and bicarbonate in water. It is a base of saturation index calculation or prevention of corrosion, rusty water and line formation.
- All hardness, calcium hardness
The volume of calcium ion and magnesium ion in water is indicated with mg/l corresponding to the calcium carbonate. Hardness by calcium ion is called calcium hardness. This is a cause of line trouble related with temperature, pH, and electrical conductivity.
- Ionic silica
When metallic corrosion products (FE, Zn etc) increase in water, silica produces compound products reacting with metallic corrosion products, which helps that line is found easily.
- Iron
Iron exists in water as a bicarbonate, a chloride, a hydrosulfate, a hydroxide, iron bacterium and an organoiron salt, and is a cause of rusty water or line trouble.
- Copper
Copper is often melt from copper pipes. Copper is a promoting factor of corrosion against iron pipes or galvanized steel pipe.
- Sulfide ion
It is a sulfide dissolved in water. When pH is decreased, sulfide is dissolved to produce H₂S, which causes a heavy corrosion on many metal materials.
- Ammonium ion
When ammonium exist in water, copper and ammonium react together to produce complex salt, which leads to copper evolution and finally to the corrosion. The volume of ammonium, producing copper and complex salt, is equivalent in $\text{NH}_3 + \text{H}_2\text{O} \leftrightarrow \text{NH}_4^+ + \text{OH}^-$. When water pH value increases, the volume of ammonium also increases, and the danger to corrosive becomes higher.
- Chlorine residual
It is chlorine remained in the water which has been chlorinated, and is a cause of corrosion of copper etc.
- Free carbon dioxide
It is carbon dioxide gas dissolved in water, and is a cause of iron corrosion or action on concrete.
- Ryzner Stability Index (RSI))
It is a measure of the grade of water corrosion and line production. It is calculated by the following formula.

$$\text{RSI} = (9.3 + \text{A} + \text{B} - \text{C} - \text{D}) \times 2 - \text{E}$$

A: Dissolved matter index = 0.1 (electrical conductivity \approx 5~50mS/m), 0.2 (electrical conductivity \approx 50~150mS/m)
 B: Temperature index <Chilled water>=2.4, <Warm water>=1.6
 C: Calcium hardness index = log (calcium hardness) – 0.4
 D: Oxygen consumption (pH4.8) index = log[Oxygen consumption (pH4.8)]
 E: pH value

RSI < 6: Possibility of line production
 $6 \leq \text{RSI} < 7$: Stable area
 RSI ≥ 7 : Possibility of corrosion

CAUTION

In the beside data, only chilled circulation water is defined, however, stable index of 6~7 should be kept in other cases.

– Dissolved oxygen

It is an oxygen gas dissolved in water and is a great factor to promote the corrosion. Regarding copper corrosion, possibility of corrosion is increased in dissolved oxygen volume of 5~15 (ml/l), and is decreased in greater or less value than that.

Remarks: Oxygen consumption, all hardness and calcium hardness

If these values are greater, line is likely to be produced, and if they are fewer, corrosion is likely to be caused. In the guideline presented in the table, only the upper value is limited, which is based on an idea of prevention of line trouble and of that the corrosion can be judged by other method. Therefore, if there is no worry about line trouble, it is better to keep these values high to prevent the possibility of corrosion.

Concretely, in chilled and warm water, if RSI is 6~7.5 (there is no worry about line problem), it is convenient to maintain the below value to prevent the corrosion.

- Oxygen consumption (pH4.8) (mgCaCO₃/l) =50~100
- All hardness (mgCaCO₃/l) =50~200
- Calcium hardness (mgCaCO₃/l) =below 150

6.3.3. Maintenance method of Water Quality

◆ Quality inspection of circulation water

1. Before test run, all criteria items in the table should be checked.
2. The first week after test run pH and electrical conductivity should be measured. In case of any trouble, all items should be checked.
3. One month after test run, all items should be checked.
4. After that, water quality tendency should be captured in these 3 tests and afterward schedule should be decided by these results. Even in the case of no trouble, pH and electrical conductivity should be checked every month and all criteria items of water quality should be checked every half year.

◆ Action in case of water quality trouble

When the result of periodical inspection recognises some troubles in water quality, those actions as similar to the following should be taken according to the situation.

1. Replace old water to new one or perform forced blow. (once a week ~ once a month)
2. Water should be treated with anti-corrosion agent or line inhibitor.

◆ Other maintenance item

To maintain good water quality, it is necessary to consider the installation place. See the below for your reference.

– Before installation

Maintenance item	Measures
1. Installation place a). Study if installation place is suitable. (*).Abnormal wastewater from boiler or refrigerating machine is not mixed with the chilled water.	<ul style="list-style-type: none"> – Analysis of water quality should be asked to a specialised company in water treatment. If it is a negative result, water source should be changed or treatment system should be changed after consulting with the company.
2. System a). Study if materials of heat exchanger, pipe, tank, valve etc are suitable. b). Prohibition of open the pipe connected with tank to ambient air. c). Study of temperature, flow, pressure and minimum holding water volume of chilled and heating water.	<ul style="list-style-type: none"> – Corrosion may concentrate to only one part due to the difference of material in chilled and heating water system. – Open the pipe to ambient air may promote the corrosion. Pipe should be put inside the water. – Control that these values be within the usage range.
3. Water for use a). Study of specification in case of brine. b). Study of specification in case of special water like pure water.	<ul style="list-style-type: none"> – Suitable brine for Hitachi's product should be selected. Its specification is accorded with Hitachi technical handbook "caution in use of brine". – There is a case that special water like pure water may not use in standard Chiller unit. Especially, in case of pure water, material should be made in SUS or certain water treatment should be performed.

– After working

Maintenance item	Measures
1. Confirm if there is no leakage in pump, valve, pipe etc.	<ul style="list-style-type: none"> – Suitable measurement should be taken in case of the leakage
2. Study of temperature, flow, pressure and minimum holding water volume of chilled and heating water	<ul style="list-style-type: none"> – Control that these values be within the usage range. (once a day)

6.4. Cleaning of water side heat exchanger

Plate heat exchanger is used in water side heat exchanger in this series .

Water passes through the clearance between plates in the plate heat exchanger, therefore, dust or foreign materials should not exist there. (See the below structure figure for your reference)

Strainer (correspondent to 20 mesh) should be installed in the inlet pipe of chilled water (Strainer should be prepared in each case).

Line is produced based on the water quality, and it is possible to decrease the performance or to break the plate due to the partial freezing caused by local clogging, which leads to the refrigerant leakage. Cleaning of strainer as well as water side heat exchanger should be performed periodically.

See the below cautions and normal cleaning method for your reference. Contact the below detergent companies to the details.

Showa HQ (Gifu): +81-58-232-1131

Tokyo branch: +81-3-3580-6121

Osaka sales office: +81-6-6391-2051

Futuro +81-3-92-434-4143

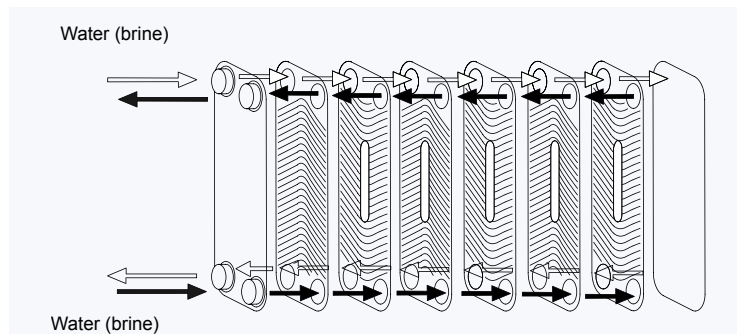

CAUTION

1. Suitable cleaning agent for line should be selected. (According to the dirty, cleaning agent differs)
2. Plate heat exchanger is made by stainless. (Copper material is used in the connection of plate). Therefore, do not use a cleaning agent with "chlorine and fluoride". If it were used, heat exchanger should be damaged, which may cause the refrigerant leakage.
3. After water discharge, wash the inside with water and then water treatment should be performed in order to prevent the corrosion, rusty water or re-production of line.
4. Density of cleaning agent, cleaning time or temperature should be adjusted according to the line.
5. After oxygen cleaning, neutralization treatment should be performed. Disposal of waste water in neutralization treatment should be asked to the specialised company.
6. Cleaning agent or neutralization agent is corrosive or irritating to the body (skin, eye etc). Therefore, when cleaning, put the protection materials (protection glasses, protection grove, protection boots etc) on.

6.4.1. Cleaning method>

Cleaning whole system using the existing pump and cleaning only water circuit of chiller unit (single body cleaning) are the popular cleaning methods. Here, it is explained how to do concretely in simple body cleaning.

N°	Name
①	Chiller unit
②	Water inlet
③	acid-proof pump
④	hose
⑤	Cleaning solution
⑥	Water outlet
⑦	Circulation tank (tank for cleaning)
⑧	Tank for waste water collection

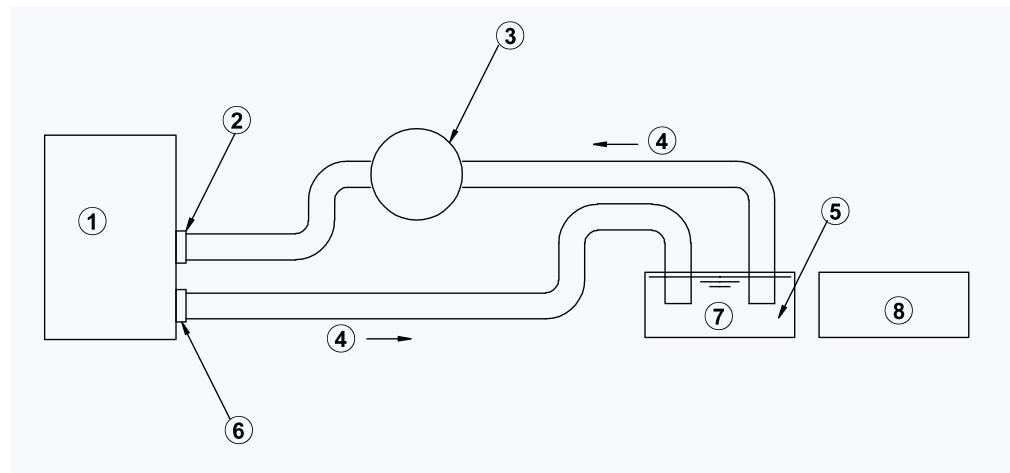

👉 Step 1:

Cleaning circuit installation

- Chiller unit operation is stopped.
- Circulation pump operation is stopped.
- Water inlet/outlet connection is removed from the water circuit of unit, and another circulation circuit used the acid-proof pump is installed separately from the water circuit.

👉 Step 2:

Confirmation of circulation circuit

An acid-proof pump is run while water is put in the tank for cleaning, and confirm

- if water is not leaked from the cleaning circuit.
- If cleaning hose is fixed.
- if devices installed around the unit is not contaminated by cleaning liquid, possible to overflow from the tank
- if air is not clogged.
- if there is no strange noise.

👉 Step 3:

Cleaning

- Drain off the water in cleaning circuit.
- Adequate quantity of cleaning agent is put in the tank for cleaning and while diluting it, operate the acid-proof pump so that the diluted cleaning liquid circulates in the circuit.
- Perform the circulation cleaning during prescribed time (it is determined in each cleaning agent, although it differs from liquid type or density). It is necessary to change the cleaning time according to the dirtiness.

Step 4:

Wastewater treatment

- Acid-proof pump operation is stopped.
- Wastewater is put to the tank for wastewater collection.
- Water is put in the tank for cleaning and the tank is washed with pump.
- Water used before is also put to the tank for wastewater collection.
- While confirming with pH test paper, neutralization agent is added gradually to neutralise the tank.
- Neutralised wastewater should be treated by industrial waste disposal contractor. In case that wastewater is diluted by much abundant of water and drained to public sewer, consult with a cleaning agent company in advance.

Step 5:

Neutrization treatment

- Water is put in the tank for cleaning.
- Acid-proof pump is operated while air is pulled out.
- While confirming with pH test paper, neutralization agent is added gradually so that pH value be 7~9.
- After pump is operated for prescribed time, neutrization treatment is finished.
- After finishing neutrization treatment, neutrization liquid is drained to public sewer.
- Circulation pump is operated and circulation system is washed sufficiently until dirty liquid is totally out.

Step 6:

Re-start operation

- Water pipe is installed as before the cleaning.
- After cleaning, water treatment is performed to prevent the corrosion occurred at operation start.

6.5. Check items in daily operation

Check items		Check contents	Result (write the value or X)
1	Check of around of chiller unit	Remove the obstacle	Good / NG
2	Pressure, quantity and quality of chilled (heating) water	Check them while pouring water	Good / NG
3	Pipe of chilled (heating) water		Good / NG
4	Check of screws and bolts etc		Tightened / No tightened
5	Re-tightening of electrical wiring terminal	Re-tighten all by driver	Tightened / No tightened
6	Leakage of water pipe	Confirm it while pouring water	Yes / No
7	Dirtiness of air side heat exchanger	Clean it by pouring hot (40°C) water.	Done / No done
8	Clogging of drain pump	Confirm it while pouring water	Yes / No
9	Cleaning of inside/outside of machine room		Done / No done
10	Compressor	Check valves, flare parts, welding parts etc.	Good / NG
11	Air side heat exchanger		Good / NG
12	Water side heat exchanger		Good / NG
13	Expansion valve		Good / NG
14	4 way valve (only cooled heat pump)		Good / NG
15	Solenoid valve		Good / NG
16	Stop valve		Good / NG
17	Strainer		Good / NG
18	Pipe, capillary tube		Good / NG
19	High pressure block switch		Good / NG
20	Cleaning of inside/outside of unit		Done / no done
21	Interphase voltage of compressor	More than 180V	Good / NG
22	Vibration and noise	Check compressor, fan, pipe etc.	Abnormal / Normal
23	Operation adjustment and automatic operation mechanism	Check the activation of ON, OFF, temperature adjustment	Good / NG
24	High pressure block switch	Check the activation value and setting value.	Good / NG
25	Indication light		Good / NG
26	4 way valve (only cooled heat pump)	Check the state of switch from cooling to heating and vice versa.	Good / NG
27	Solenoid valve		Good / NG
28	Instruction on operation method		Done / No done
29	Inlet temperature of chilled (heating) water		°C
30	Outlet temperature of chilled (heating) water		°C
31	Inlet DB(WB) temperature of air side heat exchanger		°C (°C)
32	Water flow of water side heat exchanger		m ³ /h
33	High pressure		MPa
34	Low pressure		MPa
35	Operation voltage		V
36	Operation current		A

6.6. Caution on handling of R407C

6.6.1. Refrigerant

The refrigerant is HFC type refrigerant whose ozone destruction coefficient is ZERO. If other refrigerant is mixed, the property of refrigerant is changed and may cause a problem. The following points should be taken into account on its handling.

- Refrigerant should be added in liquid state not in gas state. R407C is nonazeotropic refrigerant mixture, and compositions of boiling point are different. Therefore, if it is added in gas state, refrigerant, easy to evaporate, is added and refrigerant, hard to evaporate, remains in a refrigerant tank.
- Confirm if the tanks specialised for R407C.
- The tank should be set so that refrigerant can be added in gas state.
- The valves or hose for charge should be specialised for R407C.

6.6.2. Refrigerant oil

Freol UX300 of Japan Energy is used as a refrigerant oil due to its high compatibility with R407C. Other refrigerant oil cannot be used, therefore, pay attention not to be mixed with others at maintenance. The hygroscopicity is the same as a conventional Icematic SW220HT of Castrol, therefore, moisture maintenance is not changed. (Icematic SW220HT as well as Ferreol UX300 are ester series refrigerant oil, therefore, open to the ambient air as short as possible)

Type	Ester series synthetic oil
Name	Ferreol UX300 of Japan Energy
Fluid point	Below -20°C
kinematic viscosity (40 °C)	250~310mm ² /s
water saturation	Aprox. 1600 ppm

Model	Reference	Refrig. Qty. (kg)
RCUE40AG2	8E041072	39
RCUE50AG2	8E051072	46
RCUE60AG2	8E061072	41
RCUE70AG2	8E071072	48
RCUE80AG2	8E081072	64
RCUE100AG2	8E101072	92
RCUE120AG2	8E121072	82
RCUE140AG2	8E141072	96
RCUE160AG2	8E161072	128
RCUE180AG2	8E181072	123
RCUE210AG2	8E211072	144
RCUE240AG2	8E241072	192
RCUE280AG2	8E281072	192
RCUE320AG2	8E321072	256
RCUE350AG2	8E351072	240
RCUE400AG2	8E401072	320
RHUE40AG2	9E041072	39
RHUE50AG2	9E051072	46
RHUE60AG2	9E061072	41
RHUE70AG2	9E071072	48
RHUE80AG2	9E081072	64
RHUE100AG2	9E101072	92
RHUE120AG2	9E121072	82
RHUE140AG2	9E141072	96
RHUE160AG2	9E161072	128
RHUE180AG2	9E181072	123
RHUE210AG2	9E211072	144
RHUE240AG2	9E241072	192

6.6.3. Refrigeration cycle complete parts

Organic materials (rubber, teflon) used in compressor and control device use compatible parts with Freol UX300 and R407C.

The pressure of R407C is higher than that of R22, and pressure strength of devices is increased. Therefore, devices for R407C are not compatible with that for R22. Use specified devices when replacing the compressor and refrigeration cycle parts at maintenance.

Do not put R407C to the units for R22 .

6.6.4. Reference materials

The following materials are published as a reference for R407C handling. Please see for them.

- Implementation, service and maintenance of Package Air conditionings with R407C. (material No.: HR-325)
- Implantation and service technique of devices used HFC series (JRAIA)

6.7. Manual at compressor overall check and parts check

The refrigerant (R407C) used in this unit is HFC refrigerant and does not cause the destruction of ozone layer in contrast with CFC or HCFC refrigerant.

However, its global heating coefficient is the same level as HCFC refrigerant, therefore it is important to control the discharge. Also, it is necessary to collect refrigerant at disposal of device or at arrangement of devices.

Collection of refrigerant, vacuuming and additional insertion of refrigerant at compressor overall check and parts check are shown in the following.

Handling of R407C alternative refrigerant is described in "Implantation / Service Technical of Devices used HFC Refrigerant".

6.7.1. Collection of refrigerant

Refrigerant at airside heat exchanger should be collected in case of compressor overall check and parts check. However, at replacement or arrangement of airside heat exchanger itself, valve and fusible plug of airside heat exchanger, refrigerant of airside heat exchanger and other high pressure parts cannot be collected, and refrigerant inside the refrigeration cycle is needed to be collected using refrigerant collection device.

1. Liquid outlet valve (A) of airside heat exchanger is fully closed.
2. Chiller unit is operated with chilled water fully flowing. (In case of air-cooled heat pump type it is operated in cooling mode)
3. Chiller unit is stopped when pressure of low pressure side is decreased to aprox. 0.05MPa. Do NOT operate Chiller unit under 0.05MPa. Such operation may cause a compressor failure.
4. After a few minutes later when pressure of low pressure side is increased to 0.45~0.5MPa, chiller unit is re-operated and (2) and (3) are repeated 4~5 times.
5. This above operation enables the major part of refrigeration cycle to be collected in airside heat exchanger and high pressure pipe (between (B) and (A)).
6. Refrigerant, remained in low pressure side pipe and water cooling device, should be collected from stop valve (D) using refrigerant collection device.

6.7.2. Structure and Start-up method of Compressor

◆ Structure of Compressor

The structure of compressor used in this series is shown below figures:

1. A screw of half-sealed compressor is composed with male rotors and female rotors which have 5~6 dies.
2. Capacity is controlled by bypassing the refrigerant moving the slide valve(#7), a part of casing, to a shaft direction by a hydraulic piston(#9).

The standard specification of motor(#4), built-in the casing, is 200W ∇ \triangle and start-up.

☛ Structure drawing of 40ASP-H, 40ASP-Z:

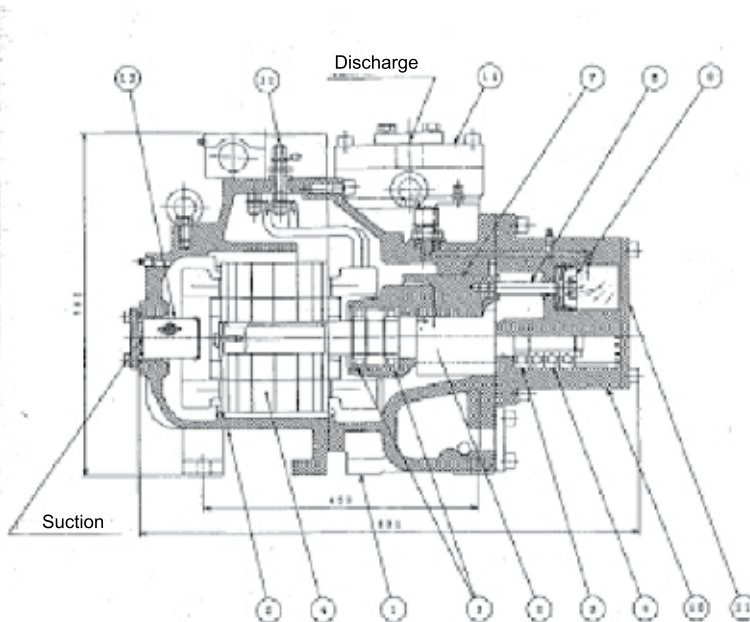

N°	Name	Material
①	Main casing	FC250
②	Screw rotor	
③	Roller bearing	
④	Motor	
⑤	Motor casing	FC250
⑥	Ball bearing	
⑦	Slide valve	
⑧	Rod	
⑨	Piston	
⑩	D casing	FC250
⑪	E cover	SM400B
⑫	Terminal	
⑬	Gas strainer	
⑭	C cover	SM400B

**Structure drawing of
50ASP-H, 50ASP-Z:**

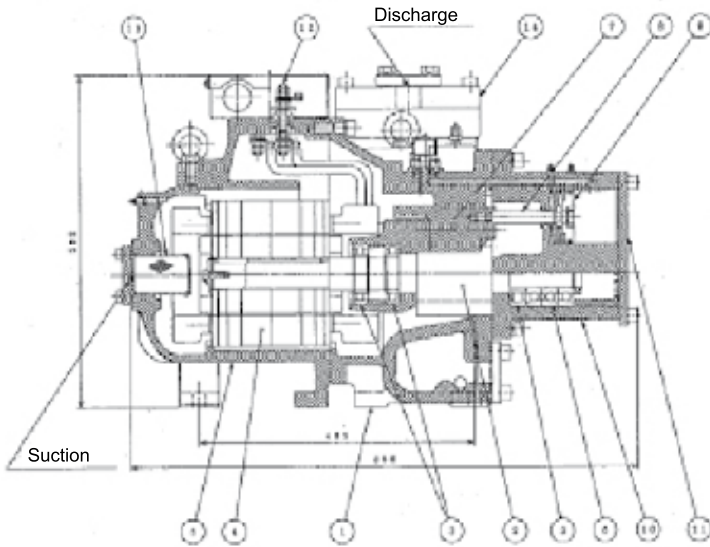

N°	Name	Material
①	Main casing	FC250
②	Screw rotor	
③	Roller bearing	
④	Motor	
⑤	Motor casing	FC250
⑥	Ball bearing	
⑦	Slide valve	
⑧	Rod	
⑨	Piston	
⑩	D casing	FC250
⑪	E cover	SM400B
⑫	Terminal	
⑬	Gas strainer	
⑭	C cover	SM400B

**Structure drawing of
60ASP-H, 60ASP-Z:**

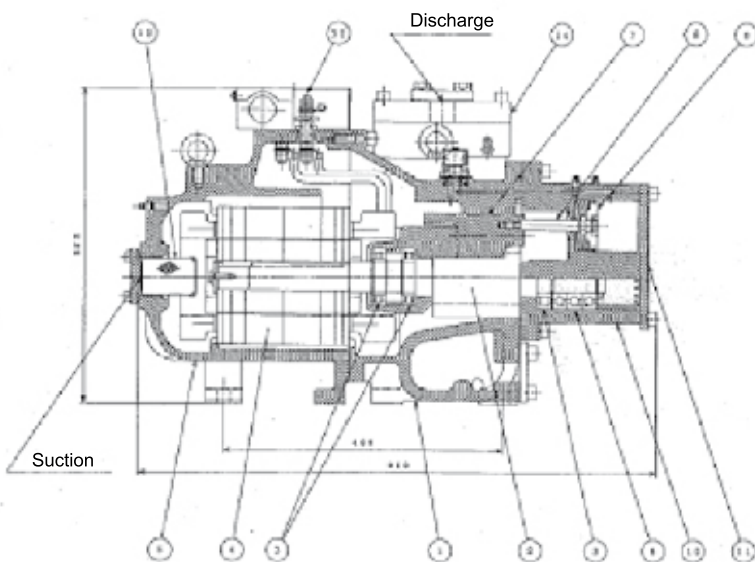

N°	Name	Material
①	Main casing	FC250
②	Screw rotor	
③	Roller bearing	
④	Motor	
⑤	Motor casing	FC250
⑥	Ball bearing	
⑦	Slide valve	
⑧	Rod	
⑨	Piston	
⑩	D casing	FC250
⑪	E cover	SM400B
⑫	Terminal	
⑬	Gas strainer	
⑭	C cover	SM400B

◆ Start-up method

Normally more than 22kW compressor has Υ Δ start-up, partly waiting start-up as well as normal start-up due to its high start-up current.

All Hitachi self-sealed screw compressors of rated output more than 22kW adapt Υ Δ start-up system due to its high performance from the view of start-up current.

Like shown in the figure 9/18, at start-up, coil of the stator is connected as a star (Υ), and $1/\sqrt{3}$ of power voltage is added to each phase. When motor is accelerated and compressor starts to run normally, the connection is changed to a delta (Δ) to add the power voltage to all phase fully.

☛ Start-up method:

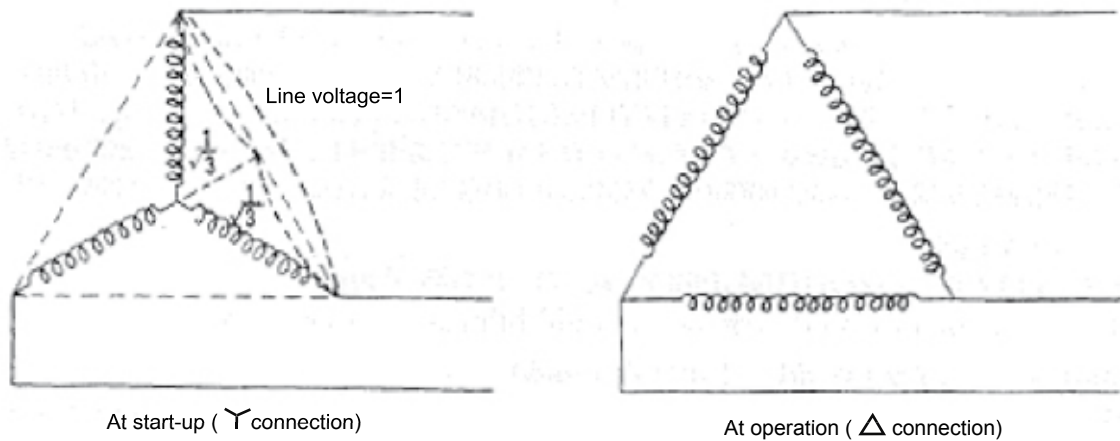

The real wiring is shown in the below figure

1. The connection of U~X, V~Y and W~Z is a motor, which is inside of screw compressor.
2. At start (Υ) connection 52C, 6C:ON 42C:OFF
3. At operation (Δ) connection 52C, 42C:ON 6C:OFF

☛ Real Wiring:

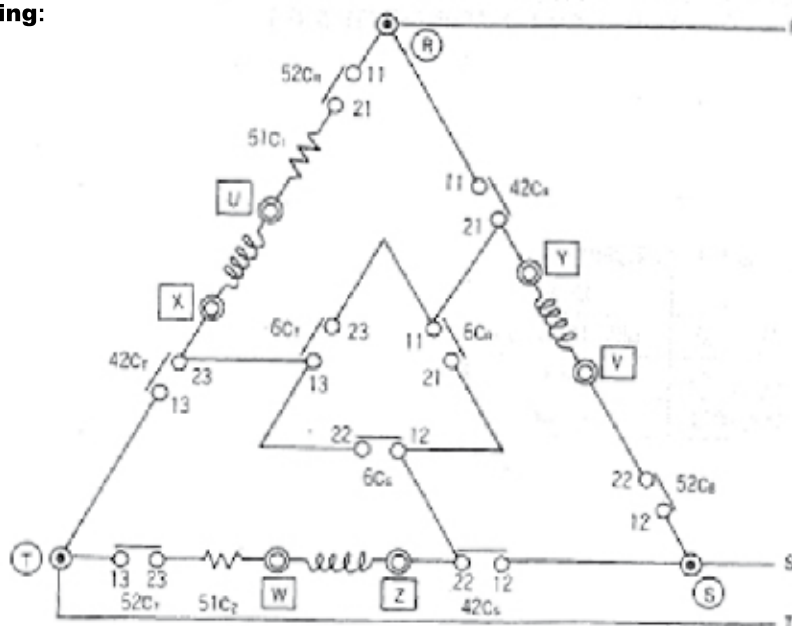

6.8. Refrigerant cycle diagrams

6.8.1. Refrigerant cycle diagram of Hitachi Air-Cooled Water Chiller (RCUE 40, 50, 60, 70, 100, 120, 140, 180, 210, 280, 350 AG2)

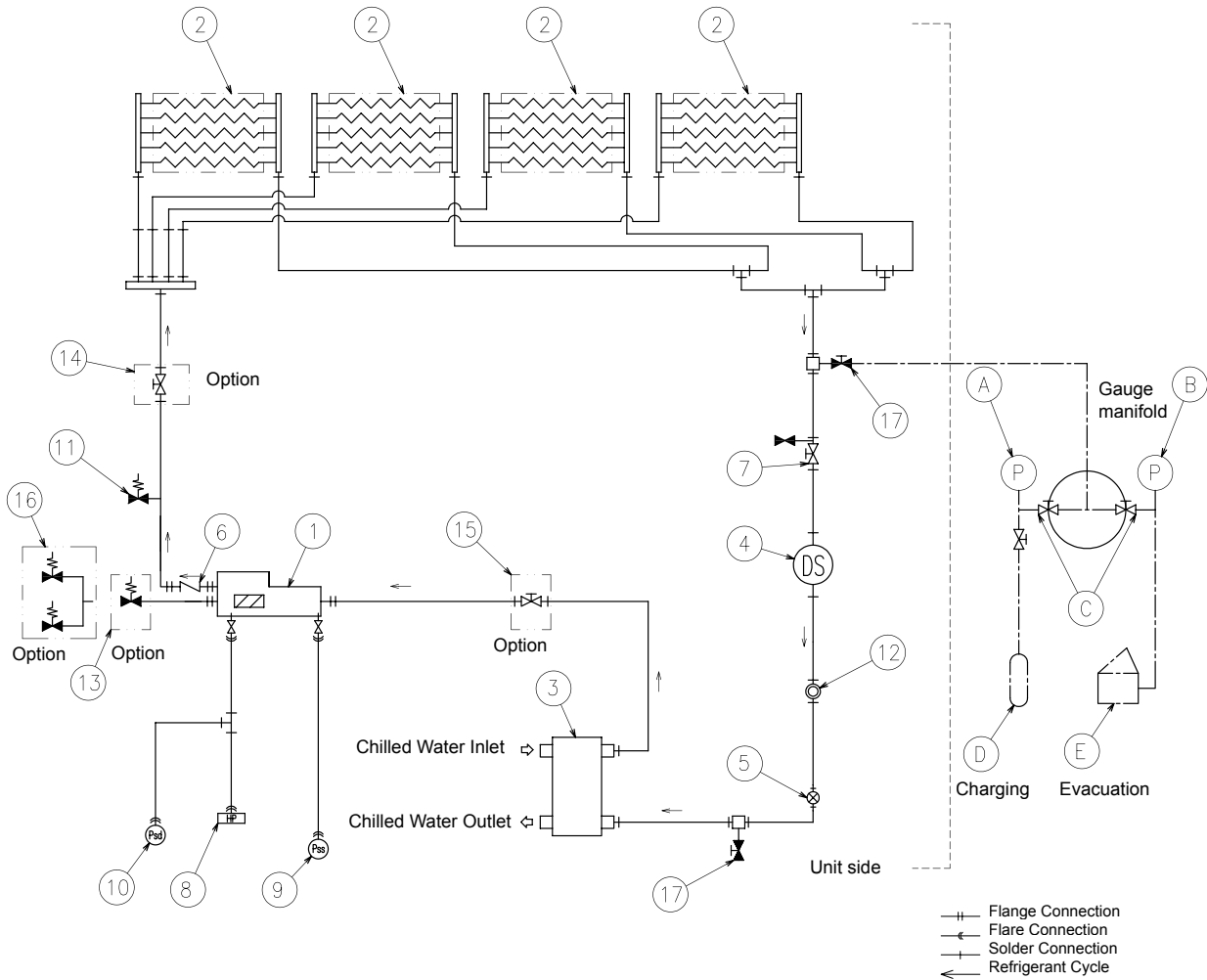

No.	Name	No.	Name
1	Compressor	12	Sight Glass
2	Air-Cooled Condenser	13	Compressor Safety Valve (Option)
3	Water Cooler	14	Stop Valve (Option)
4	Filter Drier	15	Stop Valve (Option)
5	Electronic Expansion Valve	16	Compressor Dual Safety Valve (Option)
6	Check Valve	17	Stop Valve
7	Stop Valve (with check Joint)	A	High Pressure Gauge
8	High Pressure Switch	B	Low Pressure Gauge
9	Pressure Sensor (Low)	C	Stop Valve
10	Pressure Sensor (High)	D	Charging Cylinder
11	Pressure Relief Valve	E	Vacuum Pump

i NOTE:

R407C shall be charged by LIQUID.

6.8.2. Refrigerant Cycle Diagram of Hitachi Air-Cooled Water Chiller (RCUE 80, 160, 240, 320, 400 AG2) with economizer.

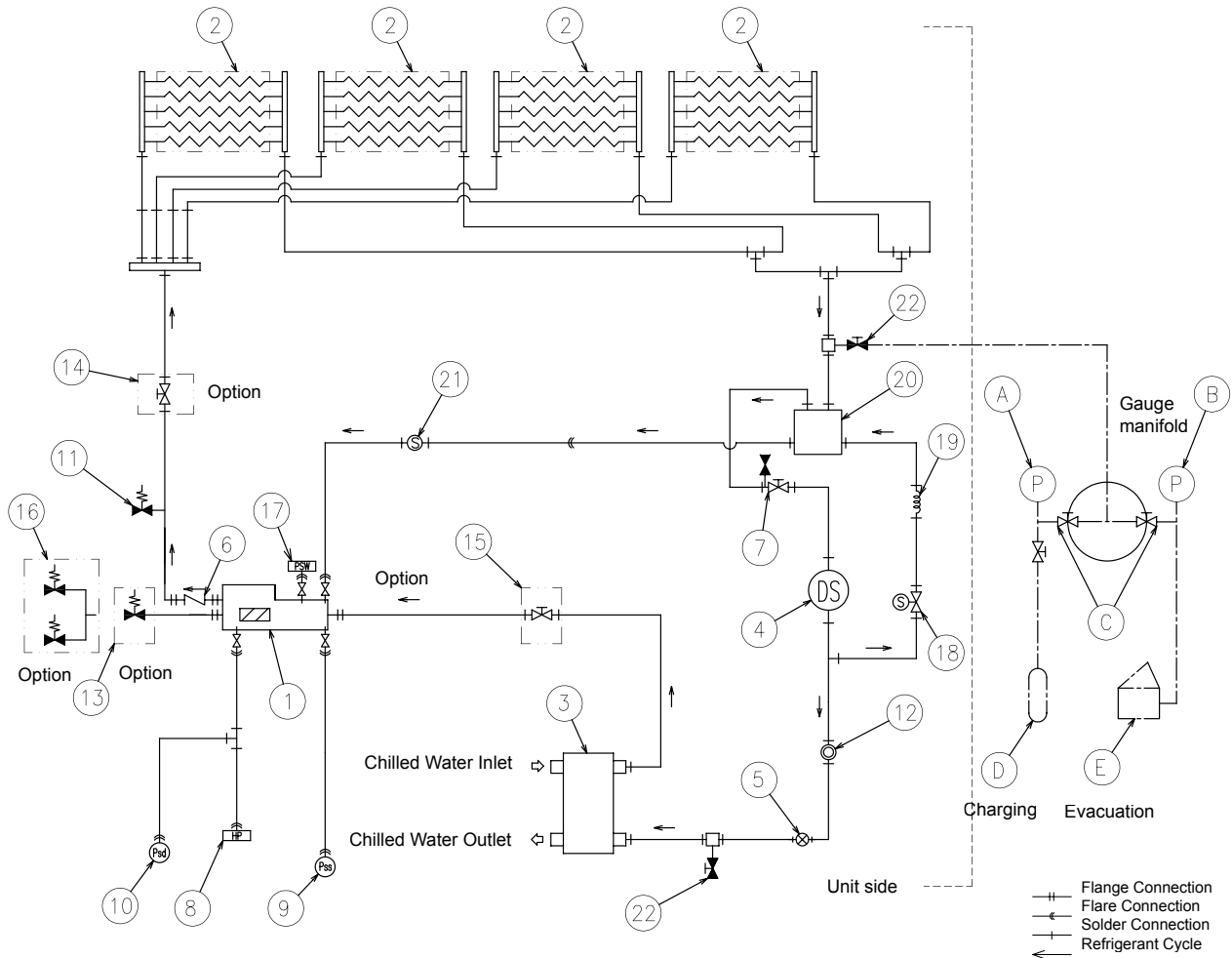

6

No.	Name	No.	Name
1	Compressor	15	Stop Valve (Option)
2	Air Cooled Condenser	16	Compressor Dual Safety Valve (Option)
3	Water Cooler	17	Pressure Switch
4	Filter Drier	18	Solenoid Valve
5	Electronic Expansion Valve	19	Capillary Tube
6	Check Valve	20	Economizer
7	Stop Valve (with check Joint)	21	Strainer
8	High Pressure Switch	22	Stop Valve
9	Pressure Sensor (Low)	A	High Pressure Gauge
10	Pressure Sensor (High)	B	Low Pressure Gauge
11	Pressure Relief Valve	C	Stop Valve
12	Sight Glass	D	Charging Cylinder
13	Compressor Safety Valve (Option)	E	Vacuum Pump
14	Stop Valve (Option)		

i NOTE:

R407C shall be charged by LIQUID.

6.8.3. Refrigerant Cycle diagram of Hitachi Air-to-water Heat Pump Chiller (RHUE 40, 50, 60, 70, 100, 120, 140, 180, 210AG2)

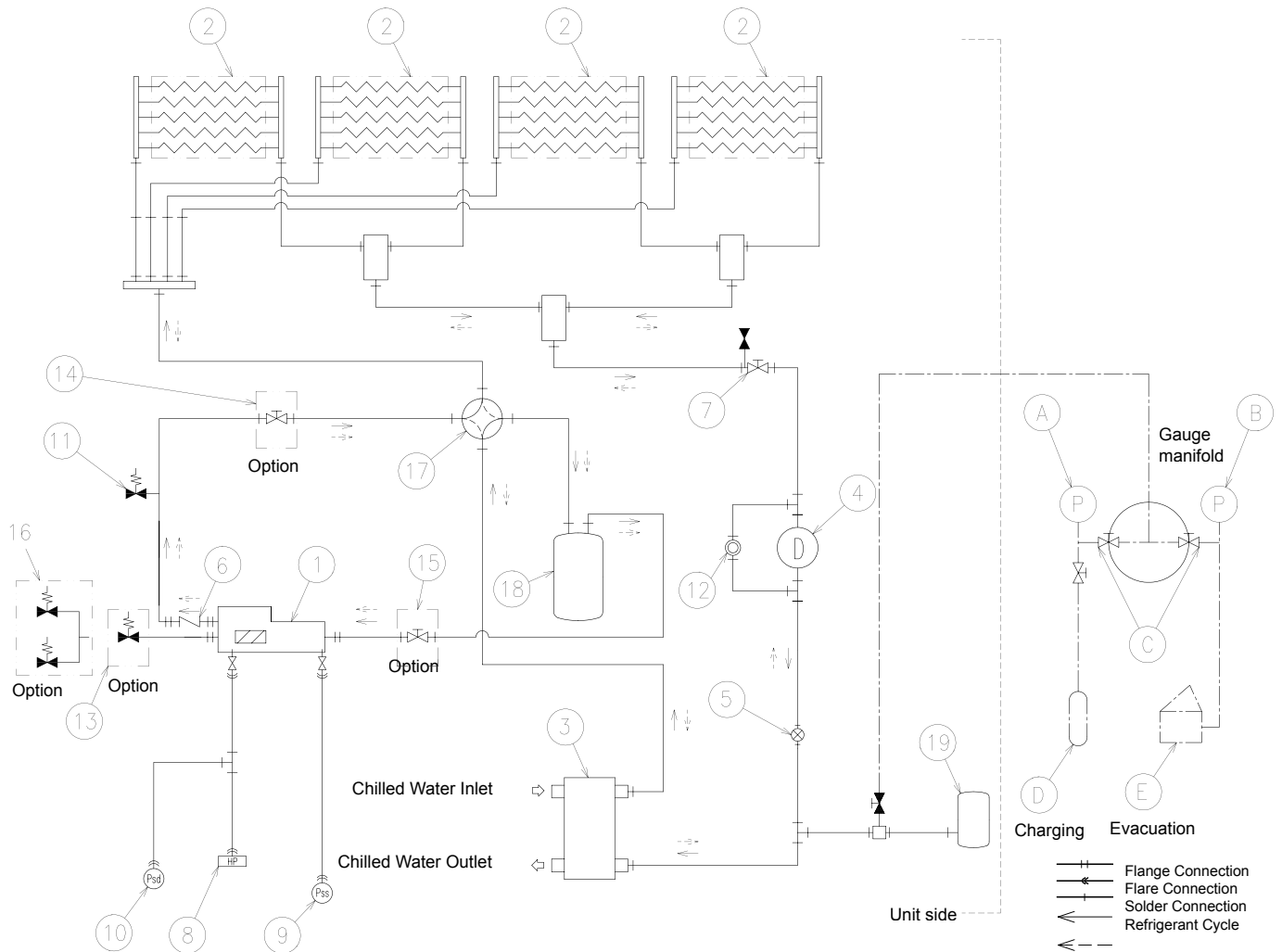

No.	Name	No.	Name
1	Compressor	12	Sight Glass
2	Air-Side Heat Exchanger	13	Compressor Safety Valve (Option)
3	Water Side Heat Exchanger	14	Stop Valve (Option)
4	Biflow drier	15	Stop Valve (Option)
5	Electronic Expansion Valve	16	Compressor Dual Safety Valve (Option)
6	Check Valve	17	Stop Valve
7	Stop Valve (with check Joint)	A	High Pressure Gauge
8	High Pressure Switch	B	Low Pressure Gauge
9	Pressure Sensor (Low)	C	Stop Valve
10	Pressure Sensor (High)	D	Charging Cylinder
11	Pressure Relief Valve	E	Vacuum Pump

i NOTE:

R407C shall be charged by LIQUID

6.8.4. Refrigerant Cycle diagram of Hitachi Air-to-water Heat Pump Chiller (RHUE 80, 160, 240 AG2) With economizer.)

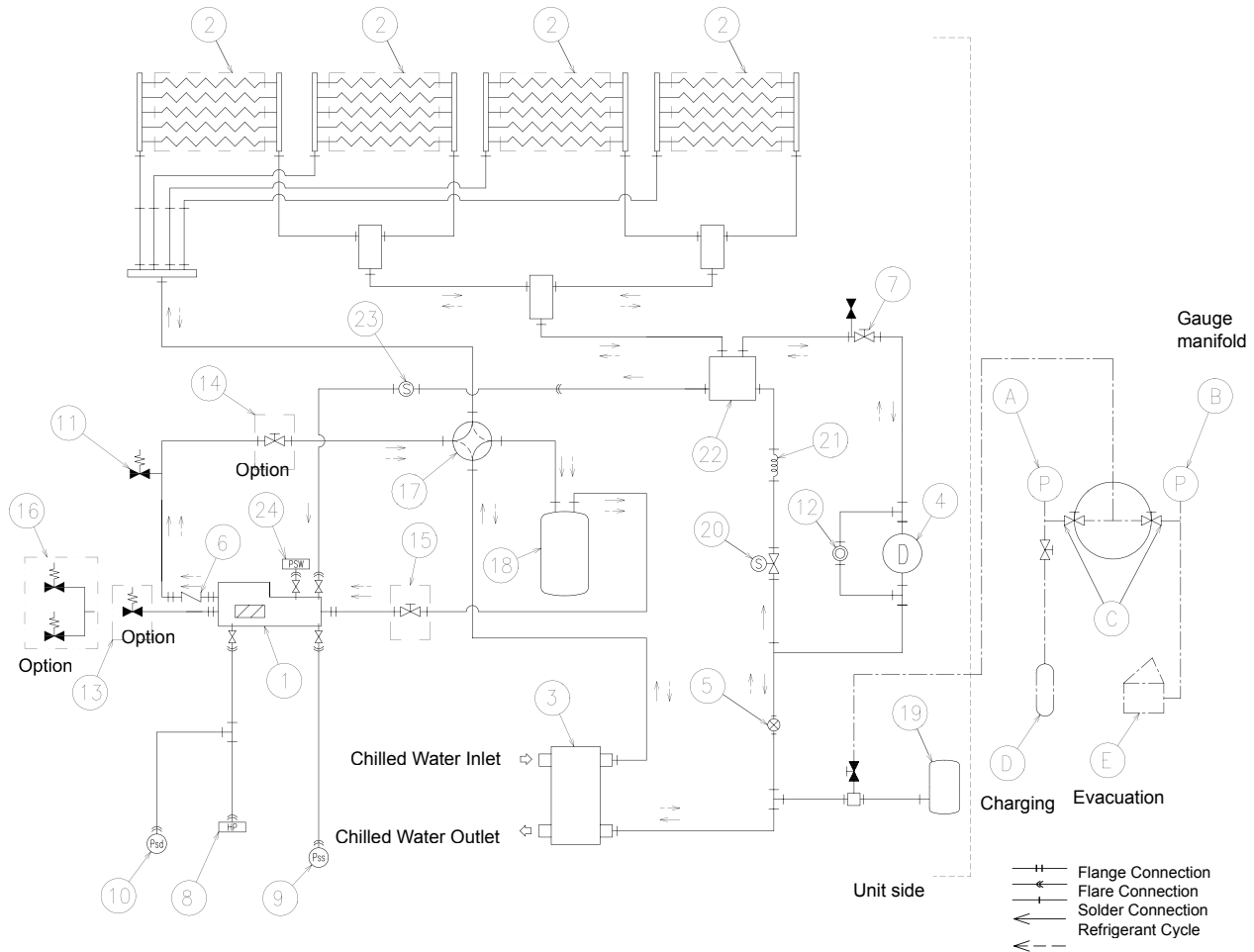

No.	Name	No.	Name
1	Compressor	16	Compressor Dual Safety Valve (Option)
2	Air Side Heat Exchanger	17	4-Way Valve
3	Water Side Heat Exchanger	18	Accumulator
4	Biflow drier	19	Liquid Tank
5	Electronic Expansion Valve	20	Solenoid Valve
6	Check Valve	21	Capillary Tube
7	Stop Valve (with check Joint)	22	Economizer
8	High Pressure Switch	23	Strainer
9	Pressure Sensor (Low)	24	Pressure Switch
10	Pressure Sensor (High)	A	High Pressure Gauge
11	Pressure Relief Valve	B	Low Pressure Gauge
12	Sight Glass	C	Stop Valve
13	Compressor Safety Valve (Option)	D	Charging Cylinder
14	Stop Valve (Option)	E	Vacuum Pump
15	Stop Valve (Option)		

i NOTE:

R407C shall be charged by LIQUID

6.9. Overhaul work

Perform the work according to "Dissolution and Composition Manual of Hitachi Half Sealed Screw Compressor".

When compressor is removed from refrigeration cycle, high pressure part should be separated between projecting part flange of compressor and upper cover of oil separator. Do not be separated between check valve and projecting part flange of compressor, or collected refrigerant is ejected.

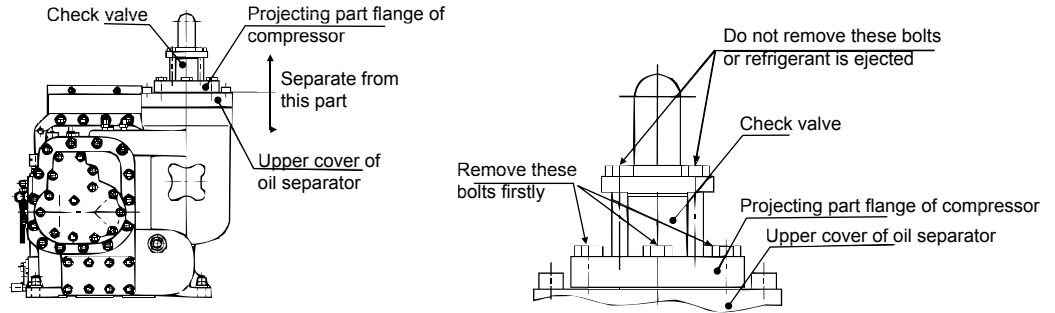

6.10. Vacuuming Procedure

Although refrigerant is collected to airside heat exchanger by the above collection operation, it is necessary to be vacuumed due to that refrigerant cycle of low pressure side pipe and of water side heat exchanger are open.

Vacuum should be performed in the following 2 positions.

- Stop valve for refrigerant insertion ((D) part)
- Check joint of compressor suction side ((E) part)

*Capillary for compound gauge in low pressure side is installed in check joint. This capillary should be removed from check joint.

Vacuuming procedure is shown in the following.

6.10.1. Vacuuming

- Manifold valve, vacuuming pump and vacuuming gauge for R407C are connected.
- Operate vacuuming pump for at least 1~2 hours until vacuum grade be below -755mmHg (5Torr).

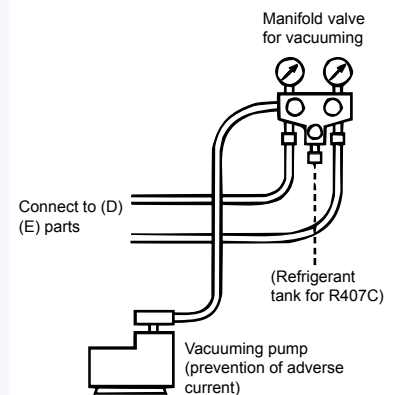
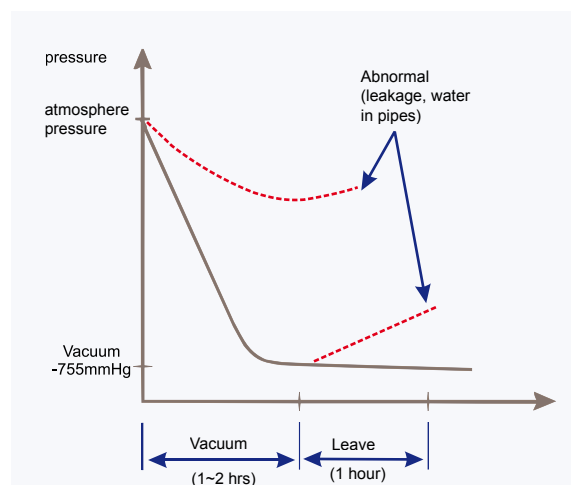

CAUTION

If vacuum grade is not decreased to -755mmHg in 1 hour, confirm if there is no leakage or if water is not in the pipes, and then keep vacuuming other 1 hour.

- Confirmation of vacuum

Vacuum gauge should be used to measure a target vacuum, however, it is impossible to read the vacuum gauge installed in the manifold very accurately. It is recommended to use a digital vacuum measure device, available in the market.

– Water evaporation>

In atmosphere pressure, water boils at 100°C, however, each time a pressure in pipes reaches to a vacuum state, water boils at lower temperature than 100°C.

The lower this temperature is, the more water evaporates and vacuum drying is kept.



If there is a possibility of dew condensation, vacuum (vacuuming time) should be controlled more strictly since water does not evaporate easily and it is difficult to know the degree of dew condensation. It is desirable to control the vacuum grade as a -755~758 mmHg (5~2 Torr).

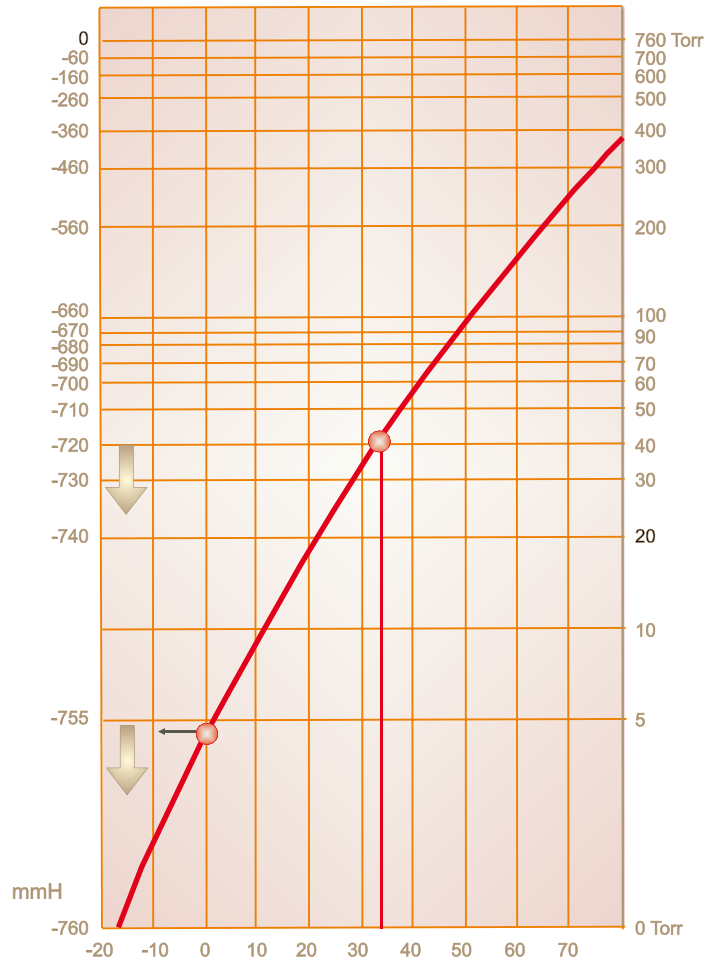

6

6.10.2. Leave

After finishing vacuuming, manifold valve is closed and vacuum pump is stopped, and then leave it for 1 hour to confirm if a pressure measured by vacuum gauge is not increased.



1. This process should be performed since air can be leaked due to the negative pressure although air leakage is not confirmed in air tight test.
2. In case of increasing pressure, it is possible that there is a slight leakage in some positions. Perform air tight test again, and perform vacuum drying again after repaired.

6.11. Additional refrigerant insertion

According to the refrigerant characteristics, the followings should be taken into account.



CAUTION

- Refrigerant should be added in liquid state not in gas state.
- Confirm if the tanks are specialised for R407C.
- The tank should be set so that refrigerant can be added in gas state.
- The valves or hose for charge should be specialised for R407C.

6.11.1. Confirmation of tank

1. Painting color is different from types of refrigerant. And a mark stamped in inspection also serves for the confirmation of refrigerant .

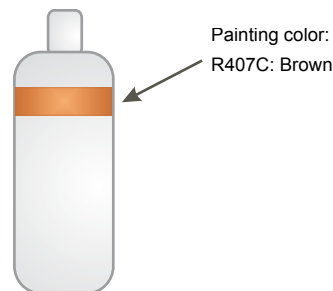

2. The refrigerant tank has two specifications as shown in the below. In any case, liquid refrigerant should be added.

The same structure as conventional tank.
<no siphon pipe>



Do not add refrigerant while being stand

Tank specialized for R407C
<with siphon pipe·Label attached>

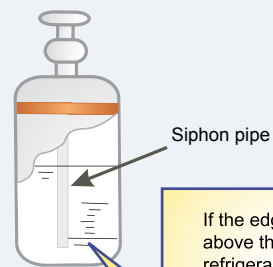

If the edge of siphon pipe becomes above the superficies of liquid refrigerant, it should take gas out. It is convenient to use manifold valve with sight glass to confirm if refrigerant is added in liquid state.

It is possible to add refrigerant while being stand

6.11.2. Measurement device used for refrigerant insertion

Measurement device for R407C is not compatible with that for R22 due to the following reasons, therefore, do not divert them. These devices should be controlled separately to avoid being mixed.

Measurement device	Reasons	Remarks
Manifold valve	<ul style="list-style-type: none"> - Pressure-proof criteria is different - Material spec. of packing is different (question of deterioration) - If R22 is mixed, sludge is occurred due to the flow of mineral oil to devices, which may cause a clogging of cycle or accident in compressor. 	Pay special attention not to use a hose for charge for R22. It is possible to change the composition when putting from refrigerant tank to charging cylinder. Under studying the handling.
Hose for charge		
Charging cylinder		
Detector of gas leakage	<ul style="list-style-type: none"> - Detection method is different - Sensor of conventional detector of gas leakage is very low, and practically it is impossible to use. 	

6

i NOTE:

The specification of connection screw is different from measurement device for R410A.

- R407C, R404A UNF7/16
- R410A UNF1/2

6.11.3. Procedure for refrigerant insertion

R407C should be added in liquid state.

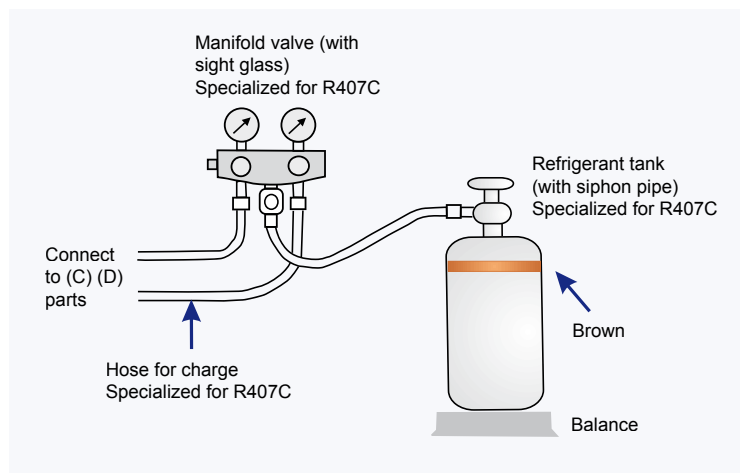

CAUTION

Do NOT add refrigerant in gas state from suction side of compressor (gas side stop valve).

1. After vacuuming, additional refrigerant should be inserted in liquid state with stop valve of liquid side and gas side close. (Confirm the volume by the balance)
In principal, collected refrigerant from water side heat exchanger to outside of refrigeration cycle by collection device is measured to determine the volume. If it is impossible to measure it, use the following figure to determine the volume, confirming the balance pressure after collection operation.
2. If it is impossible to add regulated volume due to the lower ambient temperature, compressor is operated in cooling mode and liquid refrigerant should be added from stop valve for refrigerant insertion (C). Then, regulated volume is added with the liquid side stop valve (high pressure side) open a little bit.

6.11.4. Check of leakage position

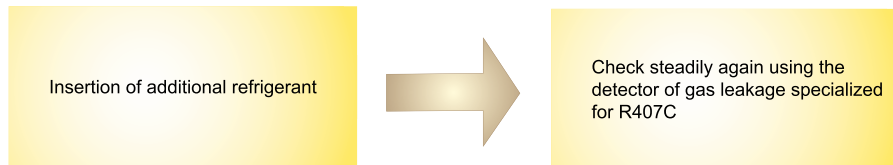

Alarm:

Check for refrigerant leakage should be performed steadily. The refrigerant used in this unit is incombustible, non-toxic and odourless safe one. However, toxic gas is produced when leaked refrigerant is exposed to fire. And oxygen will be lacked due to that refrigerant, its gravity is higher than air, is spread in the floor.

CAUTION

Refrigerant should be added in a suitable volume since excess or less insertion cause alarm or accident of compressor.

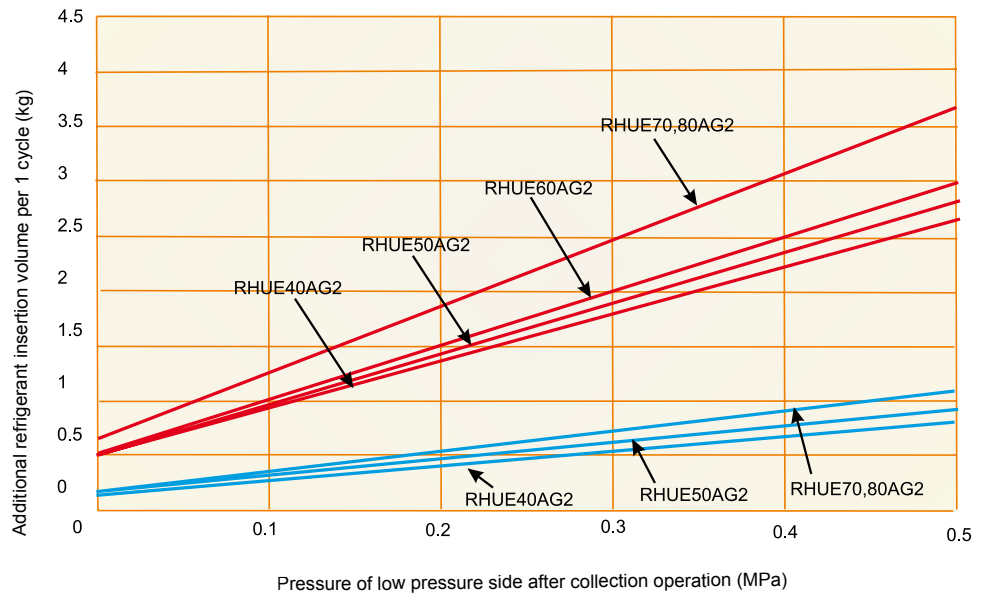

6.11.5. Caution at Replacement of Expansion Valve

The replacement of expansion valve can be performed by collecting the refrigerant to air side heat exchanger in the method shown in the "1 Collection of Refrigerant". And pay attention to the following points.

Electrical expansion valve is used in this product, and its opening is almost closed (10 pulse) at compressor stop. Therefore, when removing the welding of expansion valve, it is important not to remain the refrigerant between liquid outlet valve of air side heat exchange (A) and expansion valve.

1. In case of the model with economiser

☛ With economizer:

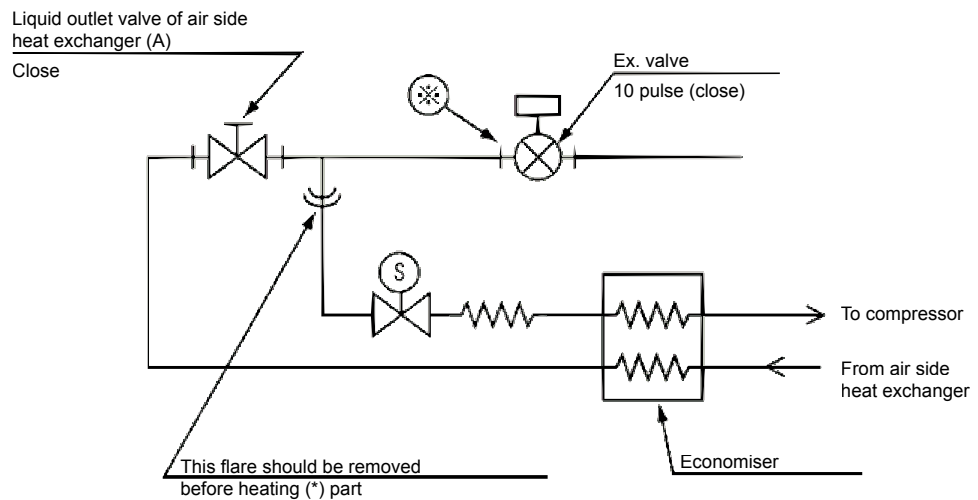

2. In case of the model without economiser

☛ Without economizer:

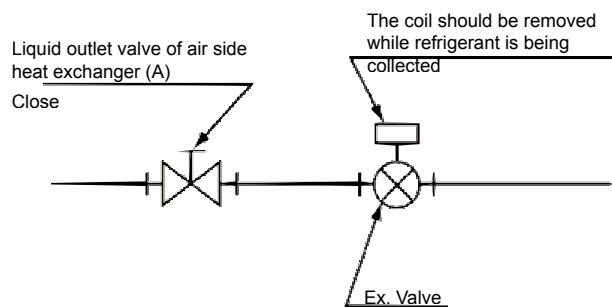

Applicable model:

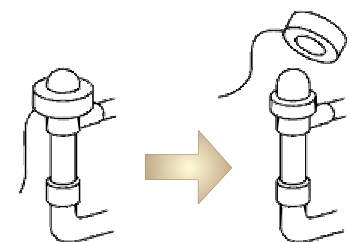

CAUTION

There will be a clearance between control value and actual value of expansion valve opening, therefore, zero point adjustment (re-input of power source) should be realized.

This operation makes expansion valve open in spite of compressor stop by low pressure setting.

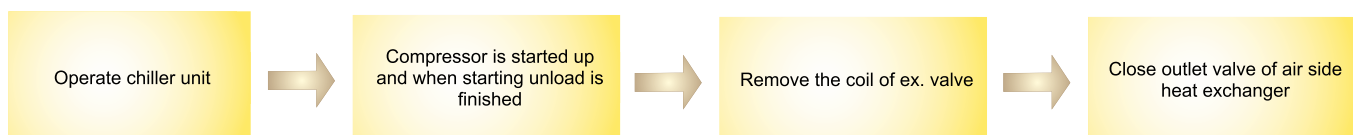



HITACHI participa en el programa de certificación EUROVENT.
Los productos cumplen con las especificaciones del directorio de productos certificados por EUROVENT.



Hitachi Air Conditioning Products Europe, S.A.
Ronda Shimizu, 1 - Polig. Ind. Can Torrella
08233 Vacarisses (Barcelona) España
ISO 9001, certificados por AENOR, España
ISO 14001, certificados por AENOR, España



Hitachi Air Conditioning Systems Operation
Shimizu-shi, Shizuoka-ken, Japan
ISO 9001, certificados por JQA, Japón
ISO 14001, certificados por JQA, Japón



Hitachi Air Conditioning Products (M) Sdn. Bnd.
Lot No. 10, Jalan Kemajuan Bangi Industrial Estate
43650 Bandar Baru Bangi, Selangor Darul Ehsan, Malasia
Certificación ISO 9001, Malasia
Certificación ISO 14001, Malasia

HITACHI
Inspire the Next