



# Air Conditioning Technical Data

Replacement VRV



EEDEN12-202

RQYQ-P



# TABLE OF CONTENTS

## RQYQ-P

1	Features .....	2
2	Specifications .....	3
	Technical Specifications .....	3
	Electrical Specifications .....	6
3	Electrical data .....	8
	Electrical Data .....	8
4	Options .....	10
	Options .....	10
5	Capacity tables .....	11
	Cooling Capacity Tables .....	11
	Heating Capacity Tables .....	55
	Capacity Correction Factor .....	99
6	Dimensional drawings .....	109
	Dimensional Drawings .....	109
	Dimensional Drawings with Accessories .....	111
7	Centre of gravity .....	112
	Centre of Gravity .....	112
8	Piping diagrams .....	114
	Piping Diagrams .....	114
9	Wiring diagrams .....	116
	Wiring Diagrams - Three Phase .....	116
10	External connection diagrams .....	120
	External Connection Diagrams .....	120
11	Sound data .....	122
	Sound Pressure Spectrum .....	122
12	Installation .....	123
	Installation Method .....	123
	Fixation and Foundation of Units .....	124
13	Operation range .....	125
	Operation Range .....	125

# 1 Features

- Cost effective and fast upgrade for R-22 systems as only the outdoor unit needs to be replaced, meaning no work has to be carried out inside your building
- Automatic cleaning of refrigerant piping ensures a clean piping network, even when a compressor breakdown has occurred
- No limitations on system history thanks to the combined refrigerant pipe cleaning and automatic charging function
- Efficiency gains of more than 40% can be realized, thank to technological developments in heat pump technology and the more efficient R-410A refrigerant
- Possibility to add indoor units and increase capacity without changing the refrigerant piping
- Less intrusive and time consuming installation compared to installing a new system, as the refrigerant piping can be maintained in most cases
- Possibility to spread the various stages of replacement thanks to the modular design of the VRV® system



## 2 Specifications

2-1 Technical Specifications				RQYQ140P	RQYQ8P	RQYQ10P	RQYQ12P	RQYQ14P	RQYQ16P	
System	Outdoor unit module 1			RQYQ140P	RQYQ8P	RQYQ10P	RQYQ12P	RQYQ14P	RQYQ16P	
Capacity range	HP			5	8	10	12	14	16	
Cooling capacity	Nom.	kW		14.0 (1)	22.4 (1)	28.0 (1)	33.5 (1)	40.0 (1)	45.0 (1)	
Heating capacity	Nom.	kW		16.0 (2)	25.0 (2)	31.5 (2)	37.5 (2)	45.0 (2)	50.0 (2)	
Capacity control	Steps		%	25 ~ 100	20 ~ 100	14 ~ 100		10 ~ 100		
Power input - 50Hz	Cooling	Nom.	kW	3.36	5.24	7.64	10.10	11.6	13.6	
	Heating	Nom.	kW	3.91	6.42	8.59	10.20	12.2	13.6	
EER				4.17	4.27	3.66	3.32	3.45	3.31	
COP				4.09	3.89	3.67	3.68	3.69	3.68	
Maximum number of connectable indoor units				10	17	21	26	30	34	
Indoor index connection	Min.			62.5	100	125	150	175	200	
	Nom.			125	200	250	300	350	400	
	Max.			162.5	260	325	390	455	520	
Dimensions	Unit	Height	mm	1,680						
		Width	mm	635	930			1,240		
		Depth	mm	765						
Weight	Unit		kg	175	230	284		381		
Heat exchanger	Type			Cross fin coil						
Fan	Type			Propeller fan						
	Air flow rate	Cooling	Nom.	m <sup>3</sup> /min	95	180	185	200	233	
	External static pressure	Max.		Pa	78					
Fan motor	Quantity			1			2			
	Drive			Direct drive						
	Output		W	350	750			350		
Fan motor 2	Drive			-			Direct drive			
	Output		W	-			350			
Sound power level	Cooling	Nom.	dBA	-						
Sound pressure level	Cooling	Nom.	dBA	54.0	57.0	58.0	60.0			
Compressor	Quantity			1		2		3		
	Type			Hermetically sealed scroll compressor						
	Piston displacement		m <sup>3</sup> /h	13.34	16.90	13.34				
	Speed		rpm	6,300	7,980	6,300				
	Output		W	2,800	4,500	1,400	3,300	1,600	2,700	
	Starting method			Soft start						
Compressor 2	Piston displacement		m <sup>3</sup> /h	-			10.53			
	Speed		rpm	-			2,900			
	Output		W	-			4,500			
	Starting method			-			Soft start			
Compressor 3	Piston displacement		m <sup>3</sup> /h	-			10.53			
	Speed		rpm	-			2,900			
	Output		W	-			4,500			
	Starting method			-			Soft start			
Operation range	Cooling	Min. ~Max.	°CDB	-5~43						
	Heating	Min. ~Max.	°CWB	-20~15.5						
Refrigerant	Type			R-410A						
	Charge		kg	11.1	10.8	11.7				
	Control			Electronic expansion valve						

## 2 Specifications

2

2-1 Technical Specifications				RQYQ140P	RQYQ8P	RQYQ10P	RQYQ12P	RQYQ14P	RQYQ16P	
Piping connections	Liquid	Type		Braze connection						
		OD	mm	9.52			12.7			
	Gas	Type		Braze connection						
		OD	mm	15.9	19.1	22.2	28.6			
	Piping length	OU - IU	Max.	m	150					
		After branch	Max.	m	40					
	Total piping length	System	Actual	m	300					
Level difference	OU - IU	Outdoor unit in highest position	m	50						
		Indoor unit in highest position	m	40						
	IU - IU	Max.	m	15						
Defrost method				Deicer						
Safety devices	Item	01	High pressure switch							
		02	Fan driver overload protector							
		03	Overcurrent relay							
		04	Inverter overload protector							

Standard Accessories : Clamps;  
 Standard Accessories : Operation manual;  
 Standard Accessories : Installation manual;  
 Standard Accessories : Connection pipes;

2-2 Electrical Specifications				RQYQ140P	RQYQ8P	RQYQ10P	RQYQ12P	RQYQ14P	RQYQ16P		
Power supply	Name			Y1							
	Phase			3~							
	Frequency		Hz	50							
	Voltage		V	380-415							
Voltage range	Min.		%	-10							
	Max.		%	10							
Current	Nominal running current (RLA) - 50Hz	Compressor 1	Cooling	A	4.8	8.2	4.5	7.0	3.4	6.1	
		Compressor 2	Cooling	A	-			6.8	6.7	7.5	7.6
		Compressor 3	Cooling	A	-				7.5	7.6	
Current - 50Hz	Starting current (MSC)			A	-		74	75	84	85	
	Minimum circuit amps (MCA)			A	11.9	18.5	21.6	22.7	31.5		
	Maximum fuse amps (MFA)			A	15	25			35		
	Total overcurrent amps (TOCA)			A	15.6	16.5	31.5		46.4		
	Full load amps (FLA)	Fan motor	A	0.7		0.9	1.2	0.6			
Fan motor 2		A	-						0.6		

### Notes

- (1) Cooling: indoor temp. 27°CDB, 19°CWB; outdoor temp. 35°CDB; equivalent piping length: 7.5m; level difference: 0m
- (2) Heating: indoor temp. 20°CDB; outdoor temp. 7°CDB, 6°CWB; equivalent refrigerant piping: 7.5m; level difference: 0m
- (3) RLA is based on following conditions: indoor temp. 27°CDB, 19°CWB; outdoor temp. 35°CDB
- (4) TOCA means the total value of each OC set.
- (5) MSC means the maximum current during start up of the compressor
- (6) Voltage range: units are suitable for use on electrical systems where voltage supplied to unit terminal is not below or above listed range limits.
- (7) Maximum allowable voltage range variation between phases is 2%.
- (8) Select wire size based on the larger value of MCA or TOCA
- (9) MFA is used to select the circuit breaker and the ground fault circuit interrupter (earth leakage circuit breaker).

## 2 Specifications

(10) Sound values are measured in an anechoic chamber. Operating sound level generally becomes higher than this value depending on the operating conditions, reflected sound, and peripheral noise.

(11) Select wire size based on the value of MCA or TOCA.

2-3 Technical Specifications				RQYQ18 P	RQYQ20 P	RQYQ22 P	RQYQ24 P	RQYQ26 P	RQYQ28 P	RQYQ30 P	RQYQ32 P	RQYQ34 P	RQYQ36 P
System	Outdoor unit module 1			RQYQ8P		RQYQ10P	RQYQ12P	RQYQ10P	RQYQ12P	RQYQ14P	RQYQ16P	RQYQ10P	
	Outdoor unit module 2			RQYQ10P	RQYQ12P			RQYQ16P				RQYQ10P	
	Outdoor unit module 3											RQYQ14P	RQYQ16P
Capacity range			HP	18	20	22	24	26	28	30	32	34	36
Cooling capacity	Nom.	kW	50.4 (1)	55.9 (1)	61.5 (1)	67.0 (1)	73.0 (1)	78.5 (1)	85.0 (1)	90.0 (1)	96.0 (1)	101 (1)	
Heating capacity	Nom.	kW	56.5 (2)	62.5 (2)	69.0 (2)	75.0 (2)	81.5 (2)	87.5 (2)	95.0 (2)	100 (2)	108 (2)	113 (2)	
Capacity control	Steps	%	9 ~ 100	8 ~ 100	7 ~ 100	6 ~ 100		5 ~ 100				4 ~ 100	
Power input - 50Hz	Cooling	Nom.	kW	12.9	15.4	17.8	20.2	21.3	23.7	25.2	27.2	26.9	28.9
	Heating	Nom.	kW	15.1	16.7	18.8	20.4	22.2	23.8	25.8	27.2	29.4	30.8
EER				3.91	3.63	3.46	3.32	3.43	3.31	3.37	3.31	3.57	3.49
COP				3.74		3.67	3.68	3.67	3.68			3.67	
Maximum number of connectable indoor units				39	43	47	52	56	60	64			
Indoor index connection	Min.			225	250	275	300	325	350	375	400	425	450
	Nom.			450	500	550	600	650	700	750	800	850	900
	Max.			585	650	715	780	845	910	975	1,040	1,105	1,170
Sound pressure level	Cooling	Nom.	dBA	61	62	63					64		
Piping connections	Liquid	Type		Braze connection									
		OD	mm	15.9				19.1					
	Gas	Type		Braze connection									
		OD	mm	28.6			34.9				41.3		
	Piping length	OU - IU	Max.	m	150								
		After branch	Max.	m	40								
	Total piping length	System	Actual	m	300								
	Level difference	OU - IU	Outdoor unit in highest position	m	50								
			Indoor unit in highest position	m	40								
		IU - IU	Max.	m	15								

Standard Accessories : Clamps;

Standard Accessories : Operation manual;

Standard Accessories : Installation manual;

Standard Accessories : Connection pipes;

2-4 Technical Specifications				RQYQ38P	RQYQ40P	RQYQ42P	RQYQ44P	RQYQ46P	RQYQ48P	
System	Outdoor unit module 1			RQYQ10P	RQYQ12P	RQYQ10P	RQYQ12P	RQYQ14P	RQYQ16P	
	Outdoor unit module 2			RQYQ12P			RQYQ16P			
	Outdoor unit module 3			RQYQ16P						
Capacity range			HP	38	40	42	44	46	48	
Cooling capacity	Nom.	kW	107 (1)	112 (1)	118 (1)	124 (1)	130 (1)	135 (1)		
Heating capacity	Nom.	kW	119 (2)	125 (2)	132 (2)	138 (2)	145 (2)	150 (2)		
Capacity control	Steps	%	4 ~ 100					3 ~ 100		
Power input - 50Hz	Cooling	Nom.	kW	31.4	33.8	34.9	35.3	38.8	40.8	
	Heating	Nom.	kW	32.4	34.0	35.8	36.0	39.4	40.8	
EER				3.41	3.31	3.38	3.51	3.35	3.31	
COP				3.67	3.68	3.69	3.83	3.68		
Maximum number of connectable indoor units				64						

## 2 Specifications

2-4 Technical Specifications				RQYQ38P	RQYQ40P	RQYQ42P	RQYQ44P	RQYQ46P	RQYQ48P	
Indoor index connection	Min.			475	500	525	550	575	600	
	Nom.			950	1,000	1,050	1,100	1,150	1,200	
	Max.			1,235	1,300	1,365	1,430	1,495	1,560	
Sound pressure level	Cooling	Nom.	dB(A)	65						
Piping connections	Liquid	Type		Braze connection						
		OD		mm	19.1					
	Gas	Type		Braze connection						
		OD		mm	41.3					
	Piping length	OU - IU	Max.	m	150					
		After branch	Max.	m	40					
	Total piping length	System	Actual	m	300					
	Level difference	OU - IU	Outdoor unit in highest position	m	50					
			Indoor unit in highest position	m	40					
		IU - IU	Max.	m	15					

Standard Accessories : Clamps;  
 Standard Accessories : Operation manual;  
 Standard Accessories : Installation manual;  
 Standard Accessories : Connection pipes;

2-5 Electrical Specifications			RQYQ18 P	RQYQ20 P	RQYQ22 P	RQYQ24 P	RQYQ26 P	RQYQ28 P	RQYQ30 P	RQYQ32 P	RQYQ34 P	RQYQ36 P
Current - 50Hz	Starting current (MSC)	A	78	79	88		98		108	109	110	111
	Minimum circuit amps (MCA)	A	40.1	41.2	44.3	45.4	53.1	54.2	63.0		74.7	75.8
	Maximum fuse amps (MFA)	A	45	50			60		70	90		
	Total overcurrent amps (TOCA)	A	48.0		63.0		77.9		92.8	109.4		

### Notes

- (1) Cooling: indoor temp. 27°CDB, 19°CWB; outdoor temp. 35°CDB; equivalent piping length: 7.5m; level difference: 0m
- (2) Heating: indoor temp. 20°CDB; outdoor temp. 7°CDB, 6°CWB; equivalent refrigerant piping: 7.5m; level difference: 0m
- (3) RLA is based on following conditions: indoor temp. 27°CDB, 19°CWB; outdoor temp. 35°CDB
- (4) TOCA means the total value of each OC set.
- (5) MSC means the maximum current during start up of the compressor
- (6) Voltage range: units are suitable for use on electrical systems where voltage supplied to unit terminal is not below or above listed range limits.
- (7) Maximum allowable voltage range variation between phases is 2%.
- (8) Select wire size based on the larger value of MCA or TOCA
- (9) MFA is used to select the circuit breaker and the ground fault circuit interrupter (earth leakage circuit breaker).
- (10) Sound values are measured in an anechoic chamber. Operating sound level generally becomes higher than this value depending on the operating conditions, reflected sound, and peripheral noise.
- (11) Select wire size based on the value of MCA or TOCA.

2-6 Electrical Specifications			RQYQ38P	RQYQ40P	RQYQ42P	RQYQ44P	RQYQ46P	RQYQ48P
Current - 50Hz	Starting current (MSC)	A	111		122		132	134
	Minimum circuit amps (MCA)	A	75.8	76.9	84.6	85.7	94.5	
	Maximum fuse amps (MFA)	A	90		100		110	
	Total overcurrent amps (TOCA)	A	109.4		124.3		139.3	

### Notes

- (1) Cooling: indoor temp. 27°CDB, 19°CWB; outdoor temp. 35°CDB; equivalent piping length: 7.5m; level difference: 0m
- (2) Heating: indoor temp. 20°CDB; outdoor temp. 7°CDB, 6°CWB; equivalent refrigerant piping: 7.5m; level difference: 0m
- (3) RLA is based on following conditions: indoor temp. 27°CDB, 19°CWB; outdoor temp. 35°CDB
- (4) TOCA means the total value of each OC set.
- (5) MSC means the maximum current during start up of the compressor



## 2 Specifications

- (6) Voltage range: units are suitable for use on electrical systems where voltage supplied to unit terminal is not below or above listed range limits.
- (7) Maximum allowable voltage range variation between phases is 2%.
- (8) Select wire size based on the larger value of MCA or TOCA
- (9) MFA is used to select the circuit breaker and the ground fault circuit interrupter (earth leakage circuit breaker).
- (10) Sound values are measured in an anechoic chamber. Operating sound level generally becomes higher than this value depending on the operating conditions, reflected sound, and peripheral noise.
- (11) Select wire size based on the value of MCA or TOCA.

### 3 Electrical data

#### 3 - 1 Electrical Data

3

##### RQYQ140P

Model Name		Units				Power Supply Comp.					OFM	
Combination Unit	Independent Unit	Hz	Volts	Min.	Max	MCA	TOCA	MFA	MSC	RLA	KW	FLA
RQYQ140P	RQYQ140P	50	380	342	456	11.9	15.6	15	-	4.6	0.35	0.7
			400						-	4.8		
			415						-	5.1		

##### SYMBOLS

- MCA : Min. Circuit Amps. (A)
- TOCA : Total Over-current Amps. (A)
- MFA : Max. Fuse Amps. (A)
- MSC : Max. Starting current
- RLA : Rated Load Amps. (A)
- OFM : Outdoor Fan Motor
- FLA : Full Load Amps. (A)
- kW : Rated Motor Output (kW)

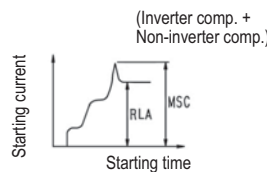

The relationship between the starting time and the starting current

##### NOTES

- RLA is based on the following conditions,  
Indoor temperature, 27°C DB/19.0 °C WB  
Outdoor temperature, 35°C DB
- TOCA means the total value of each OC set.
- MSC means the Max. current during the starting of compressor.
- Voltage range  
Units are suitable for use on electrical systems where voltage supplied to unit terminal is not below or above listed range limits.
- Maximum allowable voltage variation between phases is 2%
- Select wire size based on the larger value of MCA or TOCA.
- MFA is used to select the circuit breaker and the ground fault circuit interrupter (earth leakage circuit breaker).

3D066808

##### RQYQ8-16P

Model Name	Units				Power Supply			Comp.		OFM	
	Hz	Volts	Min.	Max	MCA	TOCA	MFA	MSC	RLA	KW	FLA
RQYQ8P	50	380	342	456	18.5	16.5	25	-	8.6	0.75	0.7
		400						-	8.2		
		415						-	7.9		
RQYQ10P	50	380	342	456	21.6	31.5	25	78	4.7+7.2	0.75	0.9
		400						74	4.5+6.8		
		415						72	4.3+6.6		
RQYQ12P	50	380	342	456	22.7	31.5	25	79	7.3+7.1	0.75	1.2
		400						75	7.0+6.7		
		415						72	6.7+6.5		
RQYQ14P	50	380	342	456	31.5	46.4	35	89	3.6+7.9x2	0.35x2	0.6x2
		400						84	3.4+7.5x2		
		415						81	3.3+7.3x2		
RQYQ16P	50	380	342	456	31.5	46.4	35	90	6.4+8.0x2	0.35x2	0.6x2
		400						85	6.1+7.6x2		
		415						82	5.9+7.3x2		

##### SYMBOLS

- MCA : Min. Circuit Amps. (A)
- TOCA : Total Over-current Amps. (A)
- MFA : Max. Fuse Amps. (A)
- MSC : Max. Starting current
- RLA : Rated Load Amps. (A)
- OFM : Outdoor Fan Motor
- FLA : Full Load Amps. (A)
- kW : Rated Motor Output (kW)

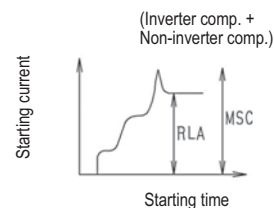

The relationship between the starting time and the starting current

##### NOTES

- RLA is based on the following conditions,  
Indoor temperature, 27°C DB/19.0 °C WB  
Outdoor temperature, 35°C DB
- TOCA means the total value of each OC set.
- MSC means the Max. current during the starting of compressor.
- Voltage range  
Units are suitable for use on electrical systems where voltage supplied to unit terminal is not below or above listed range limits.
- Maximum allowable voltage variation between phases is 2%
- Select wire size based on the larger value of MCA or TOCA.
- MFA is used to select the circuit breaker and the ground fault circuit interrupter (earth leakage circuit breaker).

3D070266

8

### 3 Electrical data

#### 3 - 1 Electrical Data

##### RQYQ18-32P

Model Name				Units				Power Supply			Comp.		OFM		
Combination Unit	Independent Unit			Hz	Volts	Min.	Max.	MCA	TOCA	MFA	MSC	RLA	KW	FLA	
RQYQ18P	RQYQ8P	RQYQ10P	RQYQ10P	380	50	400	342	456	40.1	48.0	45	82	8.6+4.7+7.2	0.75x2	0.7+0.9
				415								78	8.2+4.5+6.8		
				415								75	7.9+4.3+6.8		
RQYQ20P	RQYQ8P	RQYQ12P	RQYQ12P	380	50	400	342	456	41.2	48.0	50	83	8.6+7.3+7.1	0.75x2	0.7+1.2
				415								79	8.2+7.0+6.7		
				415								76	7.9+6.7+6.5		
RQYQ22P	RQYQ10P	RQYQ12P	RQYQ12P	380	50	400	342	456	44.3	63.3	50	92	4.7+7.2+7.3+7.1	0.75x2	0.9+1.2
				415								88	4.5+6.8+7.0+6.7		
				415								84	4.3+6.6+6.7+6.5		
RQYQ24P	RQYQ12P	RQYQ12P	RQYQ12P	380	50	400	342	456	45.4	63.0	50	93	(7.3+7.1)x2	0.75x2	1.2x2
				415								88	(7.0+6.7)x2		
				415								85	(6.7+6.5)x2		
RQYQ26P	RQYQ10P	RQYQ16P	RQYQ16P	380	50	400	342	456	53.1	77.9	60	103	4.7+7.2+6.4+8.0x2	0.75	+0.35x2
				415								98	4.5+6.8+6.1+7.6x2		
				415								94	4.3+6.6+5.9+7.3x2		
RQYQ28P	RQYQ12P	RQYQ16P	RQYQ16P	380	50	400	342	456	54.2	77.9	60	103	7.3+7.1+6.4+8.0x2	0.75	+0.35x2
				415								98	7.0+6.7+6.1+7.6x2		
				415								95	6.7+6.5+5.9+7.3x2		
RQYQ30P	RQYQ14P	RQYQ16P	RQYQ16P	380	50	400	342	456	63.0	92.8	70	113	3.6+7.9x2+6.4+8.0x2	0.75	0.6x2
				415								108	3.4+7.5x2+6.1+7.6x2		
				415								104	3.3+7.3x2+5.9+7.3x2		
RQYQ32P	RQYQ16P	RQYQ16P	RQYQ16P	380	50	400	342	456	63.0	92.8	70	115	(6.4+8.0x2)x2	(0.35x2)x2	(0.6x2)x2
				415								109	(6.1+7.6x2)x2		
				415								105	(5.9+7.3x2)x2		

##### SYMBOLS

- MCA : Min. Circuit Amps. (A)
- TOCA : Total Over-current Amps. (A)
- MFA : Max. Fuse Amps. (A)
- MSC : Max. Starting current
- RLA : Rated Load Amps. (A)
- OFM : Outdoor Fan Motor
- FLA : Full Load Amps. (A)
- kW : Rated Motor Output (kW)

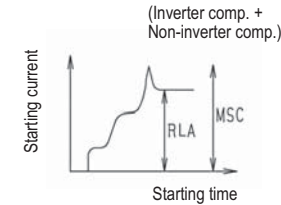

The relationship between the starting time and the starting current

##### NOTES

- RLA is based on the following conditions, Indoor temperature, 27°C DB/19.0 °C WB Outdoor temperature, 35°C DB
- TOCA means the total value of each OC set.
- MSC means the Max. current during the starting of compressor.
- Voltage range  
Units are suitable for use on electrical systems where voltage supplied to unit terminal is not below or above listed range limits.
- Maximum allowable voltage variation between phases is 2%
- Select wire size based on the larger value of MCA or TOCA.
- MFA is used to select the circuit breaker and the ground fault circuit interrupter (earth leakage circuit breaker).

3D070267

##### RQYQ34-48P

Model Name				Units				Power Supply			Comp.		OFM		
Combination Unit	Independent Unit			Hz	Volts	Min.	Max.	MCA	TOCA	MFA	MSC	RLA	KW	FLA	
RQYQ34P	RQYQ10P	RQYQ10P	RQYQ14P	380	50	400	342	456	74.7	109.4	90	115	(4.7+7.2)x2+3.6+7.9x2	0.75x2	0.9x2
				415								110	(4.5+6.8)x2+3.4+7.5x2		
				415								106	(4.3+6.6)x2+3.3+7.3x2		
RQYQ36P	RQYQ10P	RQYQ10P	RQYQ16P	380	50	400	342	456	75.8	109.4	90	117	4.7+7.2+7.3+7.1+6.4+8.0x2	0.75x2	0.9+1.2
				415								111	4.5+6.8+7.0+6.7+6.1+7.6x2		
				415								107	4.3+6.6+6.7+6.5+5.9+7.3x2		
RQYQ38P	RQYQ10P	RQYQ12P	RQYQ16P	380	50	400	342	456	75.8	109.4	90	117	4.7+7.2+7.3+7.1+6.4+8.0x2	0.75x2	0.9+1.2
				415								111	4.5+6.8+7.0+6.7+6.1+7.6x2		
				415								107	4.3+6.6+6.7+6.5+5.9+7.3x2		
RQYQ40P	RQYQ12P	RQYQ12P	RQYQ16P	380	50	400	342	456	76.9	109.4	90	117	(7.3+7.1)x2+6.4+8.0x2	0.75x2	1.2x2
				415								111	(7.0+6.7)x2+6.1+7.6x2		
				415								107	(6.7+6.5)x2+5.9+7.3x2		
RQYQ42P	RQYQ10P	RQYQ16P	RQYQ16P	380	50	400	342	456	84.6	124.3	100	128	4.7+7.2+(6.4+8.0x2)x2	0.75	+(0.35x2)x2
				415								122	4.5+6.8+(6.1+7.6x2)x2		
				415								118	4.3+6.6+(5.9+7.3x2)x2		
RQYQ44P	RQYQ12P	RQYQ16P	RQYQ16P	380	50	400	342	456	85.7	124.3	100	129	7.3+7.1+(6.4+8.0x2)x2	0.75	+(0.35x2)x2
				415								122	7.0+6.7+(6.1+7.6x2)x2		
				415								118	6.7+6.5+(5.9+7.3x2)x2		
RQYQ46P	RQYQ14P	RQYQ16P	RQYQ16P	380	50	400	342	456	94.5	139.3	110	139	3.6+7.9x2+(6.4+8.0x2)x2	0.35x2	+(0.6x2)x2
				415								132	3.4+7.5x2+(6.1+7.6x2)x2		
				415								127	3.3+7.3x2+(5.9+7.3x2)x2		
RQYQ48P	RQYQ16P	RQYQ16P	RQYQ16P	380	50	400	342	456	94.5	139.3	110	141	(6.4+8.0x2)x3	(0.35x2)x3	(0.6x2)x3
				415								134	(6.1+7.6x2)x3		
				415								129	(5.9+7.3x2)x3		

##### SYMBOLS

- MCA : Min. Circuit Amps. (A)
- TOCA : Total Over-current Amps. (A)
- MFA : Max. Fuse Amps. (A)
- MSC : Max. Starting current
- RLA : Rated Load Amps. (A)
- OFM : Outdoor Fan Motor
- FLA : Full Load Amps. (A)
- kW : Rated Motor Output (kW)

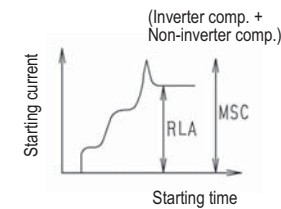

The relationship between the starting time and the starting current

##### NOTES

- RLA is based on the following conditions, Indoor temperature, 27°C DB/19.0 °C WB Outdoor temperature, 35°C DB
- TOCA means the total value of each OC set.
- MSC means the Max. current during the starting of compressor.
- Voltage range  
Units are suitable for use on electrical systems where voltage supplied to unit terminal is not below or above listed range limits.
- Maximum allowable voltage variation between phases is 2%
- Select wire size based on the larger value of MCA or TOCA.
- MFA is used to select the circuit breaker and the ground fault circuit interrupter (earth leakage circuit breaker).

3D070268

# 4 Options

## 4 - 1 Options

4

### RQYQ140P

Series		VRV III - Q
Model		RQYQ140P
Option name		
Cool/Heat selector		KRC19-26A
Fixing box		KJB11A
Distributive	Refnet header	KHRQ22M29H
	Refnet joint	KHRQ22M20T
Pipe size reducer		
Outdoor unit multi		
Connection piping kit		

3D066354

### RQYQ8-48P

Series		VRV III		
Model		RQYQ8P RQYQ10P RQYQ12P	RQYQ14P RQYQ16P	RQYQ18P RQYQ20P RQYQ22P
Option name				
Cool/Heat selector		KRC19-26A		
Fixing box		KJB111A		
Distributive	Refnet header	KHRQ22M29H	KHRQ22M29H, KHRQ22M64H	
	Refnet joint	KHRQ22M20T, KHRQ22M29T9	KHRQ22M20T, KHRQ22M29T9, KHRP26A72T	
Outdoor unit multi				BHFP22P100
Connection piping kit				
Digital pressure gauge kit		BHGP26A1		
Central drain pan kit		KWC26C280	KWC26C450	KWC26C280X2

Series		VRV III					
Model		RQYQ24P	RQYQ26P RQYQ28P	RQYQ30P RQYQ32P	RQYQ34P RQYQ36P RQYQ38P RQYQ40P	RQYQ42P RQYQ44P	RQYQ46P RQYQ48P
Option name							
Cool/Heat selector		KRC19-26A					
Fixing box		KJB111A					
Distributive	Refnet header	KHRQ22M29H, KHRQ22M64H, KHRQ22M75H					
	Refnet joint	KHRQ22M29H, KHRQ22M64H, KHRQ22M75H, KHRP26A73T					
Outdoor unit multi		BHFP22P100		BHFP22P151			
Connection piping kit		BHGP26A1X2		BHGP26A1X3			
Digital pressure gauge kit		BHGP26A1X2		BHGP26A1X3			
Central drain pan kit		KWC26C280X2	KWC26C450	KWC26C450X2	KWC26C280X2 KWC26C450	KWC26C280 KWC26C450X2	KWC26C450X3

3D069186A

# 5 Capacity tables

## 5 - 1 Cooling Capacity Tables

RQYQ140P		TC: Total Capacity; Power Input: kW (Comp. + Outdoor fan motor)																
Combination (%)	Capacity index (kW)	Outdoor air temp. °CDB	Indoor air temp. °CWB															
			14.0		16.0		18.0		19.0		20.0		22.0		24.0			
			TC	PI	TC	PI	TC	PI	TC	PI	TC	PI	TC	PI	TC	PI		
			kW															
130	18.20	10	12.3	1.62	14.6	1.98	17.0	2.36	17.6	2.41	17.9	2.36	18.3	2.26	18.7	2.16		
		12	12.3	1.65	14.6	2.02	17.0	2.40	17.4	2.40	17.6	2.35	18.1	2.25	18.5	2.21		
		14	12.3	1.68	14.6	2.06	17.0	2.43	17.2	2.38	17.4	2.33	17.8	2.32	18.3	2.34		
		16	12.3	1.71	14.6	2.10	16.7	2.42	16.9	2.41	17.2	2.42	17.6	2.44	18.1	2.46		
		18	12.3	1.75	14.6	2.14	16.5	2.52	16.7	2.53	16.9	2.54	17.4	2.57	17.8	2.59		
		20	12.3	1.78	14.6	2.28	16.3	2.64	16.5	2.65	16.7	2.66	17.2	2.69	17.6	2.72		
		21	12.3	1.83	14.6	2.36	16.2	2.70	16.4	2.71	16.6	2.73	17.0	2.75	17.5	2.78		
		23	12.3	1.96	14.6	2.53	15.9	2.82	16.2	2.84	16.4	2.85	16.8	2.88	17.3	2.91		
		25	12.3	2.10	14.6	2.71	15.7	2.95	15.9	2.96	16.1	2.98	16.6	3.01	17.0	3.04		
		27	12.3	2.24	14.6	2.90	15.5	3.07	15.7	3.09	15.9	3.10	16.4	3.14	16.8	3.17		
		29	12.3	2.39	14.6	3.10	15.2	3.19	15.5	3.21	15.7	3.23	16.1	3.26	16.6	3.30		
		31	12.3	2.55	14.6	3.28	15.0	3.32	15.2	3.34	15.5	3.36	15.9	3.39	16.3	3.43		
		33	12.3	2.72	14.3	3.41	14.8	3.45	15.0	3.46	15.2	3.48	15.7	3.52	16.1	3.56		
		35	12.3	2.90	14.1	3.53	14.6	3.57	14.8	3.59	15.0	3.61	15.5	3.65	15.9	3.69		
		37	12.3	3.08	13.9	3.66	14.3	3.70	14.6	3.72	14.8	3.74	15.2	3.78	15.7	3.83		
		39	12.3	3.28	13.7	3.78	14.1	3.83	14.3	3.85	14.6	3.87	15.0	3.92	15.4	3.96		
120	16.80	10	11.3	1.48	13.5	1.81	15.7	2.15	16.8	2.33	17.6	2.42	18.0	2.33	18.4	2.24		
		12	11.3	1.51	13.5	1.84	15.7	2.19	16.8	2.37	17.3	2.41	17.8	2.32	18.2	2.22		
		14	11.3	1.54	13.5	1.88	15.7	2.23	16.8	2.41	17.1	2.40	17.5	2.30	17.9	2.32		
		16	11.3	1.57	13.5	1.91	15.7	2.28	16.7	2.43	16.9	2.40	17.3	2.42	17.7	2.44		
		18	11.3	1.60	13.5	1.95	15.7	2.36	16.5	2.51	16.7	2.52	17.1	2.55	17.5	2.57		
		20	11.3	1.63	13.5	2.03	15.7	2.53	16.2	2.64	16.4	2.65	16.8	2.67	17.3	2.70		
		21	11.3	1.64	13.5	2.10	15.7	2.62	16.1	2.70	16.3	2.71	16.7	2.73	17.1	2.76		
		23	11.3	1.75	13.5	2.25	15.7	2.81	15.9	2.82	16.1	2.83	16.5	2.86	16.9	2.89		
		25	11.3	1.88	13.5	2.41	15.5	2.93	15.7	2.94	15.9	2.96	16.3	2.99	16.7	3.01		
		27	11.3	2.00	13.5	2.58	15.2	3.05	15.4	3.07	15.6	3.08	16.0	3.11	16.5	3.14		
		29	11.3	2.14	13.5	2.75	15.0	3.18	15.2	3.19	15.4	3.21	15.8	3.24	16.2	3.27		
		31	11.3	2.28	13.5	2.94	14.8	3.30	15.0	3.32	15.2	3.33	15.6	3.37	16.0	3.40		
		33	11.3	2.42	13.5	3.13	14.5	3.42	14.8	3.44	15.0	3.46	15.4	3.49	15.8	3.53		
		35	11.3	2.58	13.5	3.34	14.3	3.55	14.5	3.57	14.7	3.59	15.1	3.62	15.5	3.66		
		37	11.3	2.75	13.5	3.56	14.1	3.67	14.3	3.69	14.5	3.71	14.9	3.75	15.3	3.79		
		39	11.3	2.92	13.5	3.76	13.9	3.80	14.1	3.82	14.3	3.84	14.7	3.88	15.1	3.93		
110	15.40	10	10.4	1.34	12.4	1.64	14.4	1.94	15.4	2.10	16.4	2.26	17.7	2.40	18.0	2.32		
		12	10.4	1.37	12.4	1.67	14.4	1.98	15.4	2.14	16.4	2.30	17.4	2.39	17.8	2.30		
		14	10.4	1.39	12.4	1.70	14.4	2.02	15.4	2.18	16.4	2.35	17.2	2.38	17.6	2.30		
		16	10.4	1.42	12.4	1.73	14.4	2.06	15.4	2.23	16.4	2.39	17.0	2.41	17.4	2.43		
		18	10.4	1.45	12.4	1.77	14.4	2.10	15.4	2.29	16.4	2.51	16.8	2.53	17.1	2.55		
		20	10.4	1.47	12.4	1.80	14.4	2.22	15.4	2.46	16.2	2.63	16.5	2.65	16.9	2.68		
		21	10.4	1.49	12.4	1.86	14.4	2.30	15.4	2.55	16.0	2.69	16.4	2.72	16.8	2.74		
		23	10.4	1.56	12.4	1.99	14.4	2.47	15.4	2.73	15.8	2.82	16.2	2.84	16.6	2.86		
		25	10.4	1.67	12.4	2.13	14.4	2.64	15.4	2.93	15.6	2.94	16.0	2.96	16.3	2.99		
		27	10.4	1.78	12.4	2.27	14.4	2.83	15.2	3.05	15.4	3.06	15.7	3.09	16.1	3.12		
		29	10.4	1.89	12.4	2.42	14.4	3.02	14.9	3.17	15.1	3.19	15.5	3.21	15.9	3.24		
		31	10.4	2.02	12.4	2.59	14.4	3.23	14.7	3.30	14.9	3.31	15.3	3.34	15.7	3.37		
		33	10.4	2.15	12.4	2.76	14.3	3.40	14.5	3.42	14.7	3.44	15.1	3.47	15.4	3.50		
		35	10.4	2.28	12.4	2.94	14.1	3.53	14.3	3.54	14.4	3.56	14.8	3.60	15.2	3.63		
		37	10.4	2.43	12.4	3.13	13.8	3.65	14.0	3.67	14.2	3.69	14.6	3.72	15.0	3.76		
		39	10.4	2.58	12.4	3.33	13.6	3.78	13.8	3.80	14.0	3.81	14.4	3.85	14.7	3.89		
100	14.00	10	9.4	1.21	11.3	1.47	13.1	1.74	14.0	1.88	14.9	2.02	16.7	2.31	17.7	2.39		
		12	9.4	1.23	11.3	1.50	13.1	1.78	14.0	1.92	14.9	2.06	16.7	2.36	17.5	2.38		
		14	9.4	1.26	11.3	1.53	13.1	1.81	14.0	1.95	14.9	2.10	16.7	2.40	17.2	2.37		
		16	9.4	1.28	11.3	1.55	13.1	1.84	14.0	1.99	14.9	2.14	16.7	2.43	17.0	2.41		
		18	9.4	1.30	11.3	1.58	13.1	1.88	14.0	2.03	14.9	2.19	16.4	2.51	16.8	2.53		
		20	9.4	1.33	11.3	1.62	13.1	1.94	14.0	2.13	14.9	2.34	16.2	2.64	16.6	2.66		
		21	9.4	1.34	11.3	1.63	13.1	2.01	14.0	2.21	14.9	2.43	16.1	2.70	16.4	2.72		
		23	9.4	1.38	11.3	1.74	13.1	2.15	14.0	2.37	14.9	2.60	15.9	2.82	16.2	2.84		
		25	9.4	1.47	11.3	1.86	13.1	2.30	14.0	2.54	14.9	2.79	15.6	2.94	16.0	2.97		
		27	9.4	1.56	11.3	1.98	13.1	2.46	14.0	2.71	14.9	2.98	15.4	3.07	15.8	3.09		
		29	9.4	1.67	11.3	2.12	13.1	2.62	14.0	2.90	14.9	3.16	15.2	3.19	15.5	3.22		
		31	9.4	1.77	11.3	2.26	13.1	2.80	14.0	3.09	14.6	3.29	15.0	3.32	15.3	3.34		
		33	9.4	1.89	11.3	2.40	13.1	2.99	14.0	3.30	14.4	3.41	14.7	3.44	15.1	3.47		
		35	9.4	2.00	11.3	2.56	13.1	3.18	14.0	3.52	14.2	3.54	14.5	3.57	14.9	3.60		
		37	9.4	2.13	11.3	2.72	13.1	3.39	13.8	3.64	13.9	3.66	14.3	3.69	14.6	3.73		
		39	9.4	2.26	11.3	2.90	13.1	3.61	13.5	3.77	13.7	3.79	14.1	3.82	14.4	3.85		

S100071

**NOTES - ANMERKUNGEN - Σημειώσεις - NOTAS - REMARQUES - NOTE - OPMERKINGEN - Примечания - NOTLAR**

- The above table shows the average value of conditions which may occur.  
*Die obige Tabelle zeigt den Durchschnittswert der Bedingungen, die auftreten können.*  
 Στον παραπάνω πίνακα αναγράφεται η μέση τιμή για συνθήκες που μπορεί να προκύψουν.  
*La tabla de arriba muestra el valor medio de condiciones que pueden ocurrir.*  
 Le tableau ci-dessus donne la valeur moyenne pour des conditions qui peuvent survenir.  
*La tabella in alto mostra il valore delle condizioni medie che si possono riscontrare.*  
 De tabel hierboven geeft de gemiddelde waarde aan van situaties die kunnen voorvallen.  
 Таблица расположенная выше показывает среднее значение условий, которые могут наступить.  
 Yukarıdaki tablo meydana gelebilecek koşulların ortalama değerini göstermektedir.

# 5 Capacity tables

## 5 - 1 Cooling Capacity Tables

5

RQYQ140P			TC: Total Capacity; PI Power Input: kW (Comp. + Outdoor fan motor)													
Combination (%)	Capacity index (kW)	Outdoor air temp. °CDB	Indoor air temp. °CWB													
			14.0		16.0		18.0		19.0		20.0		22.0		24.0	
			TC	PI	TC	PI	TC	PI	TC	PI	TC	PI	TC	PI	TC	PI
90	12.60	10	8.5	1.09	10.1	1.31	11.8	1.55	12.6	1.67	13.4	1.79	15.1	2.05	16.7	2.31
		12	8.5	1.10	10.1	1.33	11.8	1.57	12.6	1.70	13.4	1.83	15.1	2.09	16.7	2.35
		14	8.5	1.12	10.1	1.36	11.8	1.60	12.6	1.73	13.4	1.86	15.1	2.13	16.7	2.40
		16	8.5	1.14	10.1	1.38	11.8	1.63	12.6	1.76	13.4	1.90	15.1	2.17	16.7	2.44
		18	8.5	1.16	10.1	1.41	11.8	1.67	12.6	1.80	13.4	1.94	15.1	2.21	16.4	2.51
		20	8.5	1.18	10.1	1.44	11.8	1.70	12.6	1.84	13.4	2.01	15.1	2.38	16.2	2.63
		21	8.5	1.20	10.1	1.45	11.8	1.73	12.6	1.90	13.4	2.08	15.1	2.46	16.1	2.70
		23	8.5	1.22	10.1	1.51	11.8	1.85	12.6	2.03	13.4	2.23	15.1	2.64	15.9	2.82
		25	8.5	1.28	10.1	1.61	11.8	1.98	12.6	2.18	13.4	2.38	15.1	2.83	15.6	2.94
		27	8.5	1.37	10.1	1.72	11.8	2.11	12.6	2.32	13.4	2.55	15.1	3.03	15.4	3.07
		29	8.5	1.45	10.1	1.83	11.8	2.25	12.6	2.48	13.4	2.72	14.9	3.17	15.2	3.19
		31	8.5	1.55	10.1	1.95	11.8	2.40	12.6	2.65	13.4	2.90	14.7	3.29	15.0	3.31
		33	8.5	1.64	10.1	2.07	11.8	2.56	12.6	2.82	13.4	3.10	14.4	3.41	14.7	3.44
		35	8.5	1.74	10.1	2.21	11.8	2.73	12.6	3.01	13.4	3.30	14.2	3.54	14.5	3.57
		37	8.5	1.85	10.1	2.35	11.8	2.90	12.6	3.20	13.4	3.52	14.0	3.66	14.3	3.69
		39	8.5	1.96	10.1	2.49	11.8	3.09	12.6	3.41	13.4	3.75	13.7	3.79	14.0	3.82
		80	11.20	10	7.6	0.96	9.0	1.15	10.5	1.36	11.2	1.46	11.9	1.57	13.4	1.79
12	7.6			0.98	9.0	1.17	10.5	1.38	11.2	1.49	11.9	1.60	13.4	1.82	14.8	2.05
14	7.6			1.00	9.0	1.19	10.5	1.41	11.2	1.51	11.9	1.63	13.4	1.86	14.8	2.09
16	7.6			1.01	9.0	1.22	10.5	1.43	11.2	1.54	11.9	1.66	13.4	1.89	14.8	2.13
18	7.6			1.03	9.0	1.24	10.5	1.46	11.2	1.57	11.9	1.69	13.4	1.93	14.8	2.17
20	7.6			1.05	9.0	1.26	10.5	1.49	11.2	1.60	11.9	1.72	13.4	2.00	14.8	2.33
21	7.6			1.06	9.0	1.27	10.5	1.50	11.2	1.62	11.9	1.76	13.4	2.07	14.8	2.41
23	7.6			1.08	9.0	1.30	10.5	1.58	11.2	1.73	11.9	1.88	13.4	2.22	14.8	2.58
25	7.6			1.11	9.0	1.38	10.5	1.68	11.2	1.84	11.9	2.01	13.4	2.37	14.8	2.77
27	7.6			1.18	9.0	1.47	10.5	1.79	11.2	1.97	11.9	2.15	13.4	2.54	14.8	2.96
29	7.6			1.26	9.0	1.57	10.5	1.91	11.2	2.10	11.9	2.29	13.4	2.71	14.8	3.16
31	7.6			1.33	9.0	1.67	10.5	2.04	11.2	2.24	11.9	2.45	13.4	2.89	14.6	3.29
33	7.6			1.42	9.0	1.77	10.5	2.17	11.2	2.38	11.9	2.61	13.4	3.09	14.4	3.41
35	7.6			1.50	9.0	1.88	10.5	2.31	11.2	2.54	11.9	2.78	13.4	3.29	14.2	3.53
37	7.6			1.59	9.0	2.00	10.5	2.45	11.2	2.70	11.9	2.96	13.4	3.51	13.9	3.66
39	7.6			1.69	9.0	2.12	10.5	2.61	11.2	2.87	11.9	3.15	13.4	3.73	13.7	3.78
70	9.80			10	6.6	0.85	7.9	1.01	9.2	1.17	9.8	1.26	10.4	1.35	11.7	1.54
		12	6.6	0.86	7.9	1.02	9.2	1.19	9.8	1.28	10.4	1.38	11.7	1.56	13.0	1.76
		14	6.6	0.87	7.9	1.04	9.2	1.22	9.8	1.31	10.4	1.40	11.7	1.59	13.0	1.79
		16	6.6	0.89	7.9	1.06	9.2	1.24	9.8	1.33	10.4	1.43	11.7	1.62	13.0	1.83
		18	6.6	0.90	7.9	1.08	9.2	1.26	9.8	1.36	10.4	1.45	11.7	1.66	13.0	1.86
		20	6.6	0.92	7.9	1.10	9.2	1.28	9.8	1.38	10.4	1.48	11.7	1.69	13.0	1.92
		21	6.6	0.93	7.9	1.11	9.2	1.30	9.8	1.40	10.4	1.50	11.7	1.71	13.0	1.98
		23	6.6	0.94	7.9	1.13	9.2	1.32	9.8	1.44	10.4	1.57	11.7	1.84	13.0	2.12
		25	6.6	0.96	7.9	1.17	9.2	1.41	9.8	1.54	10.4	1.67	11.7	1.96	13.0	2.27
		27	6.6	1.01	7.9	1.25	9.2	1.50	9.8	1.64	10.4	1.79	11.7	2.09	13.0	2.43
		29	6.6	1.08	7.9	1.32	9.2	1.60	9.8	1.75	10.4	1.90	11.7	2.23	13.0	2.59
		31	6.6	1.14	7.9	1.41	9.2	1.70	9.8	1.86	10.4	2.03	11.7	2.38	13.0	2.77
		33	6.6	1.21	7.9	1.49	9.2	1.81	9.8	1.98	10.4	2.16	11.7	2.54	13.0	2.95
		35	6.6	1.28	7.9	1.58	9.2	1.92	9.8	2.11	10.4	2.30	11.7	2.70	13.0	3.14
		37	6.6	1.35	7.9	1.68	9.2	2.04	9.8	2.24	10.4	2.44	11.7	2.88	13.0	3.35
		39	6.6	1.43	7.9	1.78	9.2	2.17	9.8	2.38	10.4	2.60	11.7	3.06	13.0	3.57
		60	8.40	10	5.7	0.74	6.8	0.87	7.9	1.00	8.4	1.07	8.9	1.14	10.0	1.29
12	5.7			0.75	6.8	0.88	7.9	1.02	8.4	1.09	8.9	1.16	10.0	1.32	11.1	1.48
14	5.7			0.76	6.8	0.89	7.9	1.03	8.4	1.11	8.9	1.18	10.0	1.34	11.1	1.50
16	5.7			0.77	6.8	0.91	7.9	1.05	8.4	1.13	8.9	1.21	10.0	1.37	11.1	1.53
18	5.7			0.78	6.8	0.92	7.9	1.07	8.4	1.15	8.9	1.23	10.0	1.39	11.1	1.56
20	5.7			0.79	6.8	0.94	7.9	1.09	8.4	1.17	8.9	1.25	10.0	1.42	11.1	1.59
21	5.7			0.80	6.8	0.95	7.9	1.10	8.4	1.18	8.9	1.26	10.0	1.43	11.1	1.61
23	5.7			0.81	6.8	0.96	7.9	1.12	8.4	1.20	8.9	1.29	10.0	1.49	11.1	1.71
25	5.7			0.83	6.8	0.98	7.9	1.16	8.4	1.26	8.9	1.37	10.0	1.59	11.1	1.83
27	5.7			0.86	6.8	1.04	7.9	1.24	8.4	1.35	8.9	1.46	10.0	1.70	11.1	1.95
29	5.7			0.91	6.8	1.10	7.9	1.32	8.4	1.43	8.9	1.55	10.0	1.81	11.1	2.08
31	5.7			0.96	6.8	1.17	7.9	1.40	8.4	1.52	8.9	1.65	10.0	1.92	11.1	2.22
33	5.7			1.02	6.8	1.24	7.9	1.48	8.4	1.62	8.9	1.75	10.0	2.05	11.1	2.36
35	5.7			1.08	6.8	1.31	7.9	1.58	8.4	1.72	8.9	1.86	10.0	2.18	11.1	2.51
37	5.7			1.14	6.8	1.39	7.9	1.67	8.4	1.82	8.9	1.98	10.0	2.31	11.1	2.67
39	5.7			1.20	6.8	1.47	7.9	1.77	8.4	1.93	8.9	2.10	10.0	2.46	11.1	2.84
50	7.00			10	4.72	0.63	5.6	0.73	6.5	0.84	7.0	0.89	7.5	0.95	8.4	1.07
		12	4.72	0.64	5.6	0.74	6.5	0.85	7.0	0.91	7.5	0.97	8.4	1.09	9.3	1.21
		14	4.72	0.65	5.6	0.75	6.5	0.87	7.0	0.92	7.5	0.98	8.4	1.10	9.3	1.23
		16	4.72	0.66	5.6	0.77	6.5	0.88	7.0	0.94	7.5	1.00	8.4	1.12	9.3	1.25
		18	4.72	0.67	5.6	0.78	6.5	0.89	7.0	0.95	7.5	1.02	8.4	1.14	9.3	1.28
		20	4.72	0.68	5.6	0.79	6.5	0.91	7.0	0.97	7.5	1.03	8.4	1.16	9.3	1.30
		21	4.72	0.68	5.6	0.80	6.5	0.92	7.0	0.98	7.5	1.04	8.4	1.18	9.3	1.31
		23	4.72	0.69	5.6	0.81	6.5	0.93	7.0	1.00	7.5	1.06	8.4	1.20	9.3	1.34
		25	4.72	0.70	5.6	0.82	6.5	0.95	7.0	1.02	7.5	1.09	8.4	1.26	9.3	1.43
		27	4.72	0.71	5.6	0.85	6.5	1.00	7.0	1.08	7.5	1.16	8.4	1.34	9.3	1.53
		29	4.72	0.76	5.6	0.90	6.5	1.06	7.0	1.15	7.5	1.24	8.4	1.42	9.3	1.63
		31	4.72	0.80	5.6	0.96	6.5	1.13	7.0	1.22	7.5	1.31	8.4	1.51	9.3	1.73
		33	4.72	0.84	5.6	1.01	6.5	1.19	7.0	1.29	7.5	1.39	8.4	1.61	9.3	1.84
		35	4.72	0.89	5.6	1.07										

# 5 Capacity tables

## 5 - 1 Cooling Capacity Tables

RQYQ8PY1			TC: Total Capacity: kW ; PI: Power Input: kW (compressor + outdoor fan motor)															
Combination (%)	Capacity index (kW)	Outdoor air temp. °CDB	Indoor air temperature: °CWB															
			14.0		16.0		18.0		19.0		20.0		22.0		24.0			
			TC	PI	TC	PI	TC	PI	TC	PI	TC	PI	TC	PI	TC	PI		
130	29.12	10	19.7	2.47	23.4	2.96	27.2	3.51	28.2	3.59	28.6	3.51	29.3	3.37	30.0	3.21		
		12	19.7	2.51	23.4	3.02	27.2	3.58	27.8	3.57	28.2	3.49	28.9	3.34	29.6	3.29		
		14	19.7	2.55	23.4	3.07	27.1	3.62	27.5	3.55	27.8	3.47	28.5	3.45	29.3	3.48		
		16	19.7	2.59	23.4	3.13	26.8	3.61	27.1	3.58	27.5	3.60	28.2	3.63	28.9	3.67		
		18	19.7	2.64	23.4	3.19	26.4	3.75	26.8	3.76	27.1	3.78	27.8	3.82	28.5	3.86		
		20	19.7	2.68	23.4	3.40	26.0	3.93	26.4	3.95	26.7	3.97	27.5	4.01	28.2	4.04		
		21	19.7	2.76	23.4	3.52	25.9	4.02	26.2	4.04	26.6	4.06	27.3	4.10	28.0	4.14		
		23	19.7	2.95	23.4	3.77	25.5	4.20	25.8	4.22	26.2	4.24	26.9	4.29	27.6	4.33		
		25	19.7	3.15	23.4	4.04	25.1	4.39	25.5	4.41	25.8	4.43	26.5	4.48	27.3	4.52		
		27	19.7	3.35	23.4	4.32	24.8	4.57	25.1	4.59	25.5	4.62	26.2	4.67	26.9	4.72		
		29	19.7	3.58	23.4	4.62	24.4	4.76	24.8	4.78	25.1	4.81	25.8	4.86	26.5	4.91		
		31	19.7	3.81	23.3	4.89	24.0	4.94	24.4	4.97	24.7	5.00	25.4	5.05	26.2	5.10		
		33	19.7	4.05	23.0	5.07	23.7	5.13	24.0	5.16	24.4	5.19	25.1	5.24	25.8	5.30		
		35	19.7	4.32	22.6	5.26	23.3	5.32	23.7	5.35	24.0	5.38	24.7	5.44	25.4	5.50		
		37	19.7	4.59	22.2	5.44	22.9	5.51	23.3	5.54	23.6	5.57	24.4	5.63	25.1	5.70		
		39	19.7	4.89	21.9	5.63	22.6	5.70	22.9	5.73	23.3	5.76	24.0	5.83	24.7	5.90		
		120	26.88	10	18.1	2.29	21.6	2.72	25.1	3.20	26.9	3.46	28.1	3.61	28.8	3.47	29.4	3.33
				12	18.1	2.33	21.6	2.77	25.1	3.26	26.9	3.53	27.8	3.59	28.4	3.45	29.1	3.31
14	18.1			2.36	21.6	2.82	25.1	3.32	26.9	3.59	27.4	3.57	28.0	3.43	28.7	3.45		
16	18.1			2.40	21.6	2.87	25.1	3.39	26.7	3.62	27.0	3.58	27.7	3.61	28.3	3.64		
18	18.1			2.44	21.6	2.92	25.1	3.50	26.3	3.74	26.7	3.76	27.3	3.79	28.0	3.83		
20	18.1			2.48	21.6	3.03	25.1	3.77	26.0	3.92	26.3	3.94	27.0	3.98	27.6	4.01		
21	18.1			2.50	21.6	3.14	25.1	3.90	25.8	4.02	26.1	4.03	26.8	4.07	27.4	4.11		
23	18.1			2.66	21.6	3.36	25.1	4.18	25.4	4.20	25.8	4.22	26.4	4.26	27.1	4.30		
25	18.1			2.84	21.6	3.59	24.7	4.36	25.1	4.38	25.4	4.40	26.0	4.44	26.7	4.49		
27	18.1			3.02	21.6	3.84	24.4	4.54	24.7	4.57	25.0	4.59	25.7	4.63	26.3	4.68		
29	18.1			3.22	21.6	4.10	24.0	4.73	24.3	4.75	24.7	4.77	25.3	4.82	26.0	4.87		
31	18.1			3.42	21.6	4.37	23.6	4.91	24.0	4.94	24.3	4.96	24.9	5.01	25.6	5.06		
33	18.1			3.63	21.6	4.66	23.3	5.10	23.6	5.12	23.9	5.15	24.6	5.20	25.2	5.26		
35	18.1			3.86	21.6	4.97	22.9	5.28	23.2	5.31	23.6	5.34	24.2	5.39	24.9	5.45		
37	18.1			4.10	21.6	5.30	22.5	5.47	22.9	5.50	23.2	5.53	23.9	5.59	24.5	5.65		
39	18.1			4.36	21.5	5.60	22.2	5.66	22.5	5.69	22.8	5.72	23.5	5.78	24.1	5.84		
110	24.64			10	16.6	2.13	19.8	2.49	23.0	2.91	24.6	3.13	26.2	3.36	28.3	3.57	28.9	3.45
				12	16.6	2.16	19.8	2.53	23.0	2.96	24.6	3.19	26.2	3.43	27.9	3.56	28.5	3.43
		14	16.6	2.19	19.8	2.57	23.0	3.01	24.6	3.25	26.2	3.49	27.5	3.54	28.1	3.43		
		16	16.6	2.22	19.8	2.62	23.0	3.07	24.6	3.31	26.2	3.56	27.2	3.58	27.8	3.61		
		18	16.6	2.25	19.8	2.66	23.0	3.13	24.6	3.40	26.2	3.74	26.8	3.77	27.4	3.80		
		20	16.6	2.29	19.8	2.71	23.0	3.31	24.6	3.66	25.9	3.92	26.5	3.95	27.1	3.98		
		21	16.6	2.30	19.8	2.79	23.0	3.43	24.6	3.79	25.7	4.01	26.3	4.04	26.9	4.08		
		23	16.6	2.40	19.8	2.98	23.0	3.68	24.6	4.06	25.3	4.19	25.9	4.23	26.5	4.26		
		25	16.6	2.56	19.8	3.18	23.0	3.93	24.6	4.35	24.9	4.37	25.5	4.41	26.1	4.45		
		27	16.6	2.72	19.8	3.40	23.0	4.21	24.3	4.54	24.6	4.56	25.2	4.60	25.8	4.64		
		29	16.6	2.89	19.8	3.62	23.0	4.50	23.9	4.72	24.2	4.74	24.8	4.79	25.4	4.83		
		31	16.6	3.06	19.8	3.86	23.0	4.80	23.5	4.91	23.8	4.93	24.4	4.97	25.0	5.02		
		33	16.6	3.25	19.8	4.11	22.9	5.07	23.2	5.09	23.5	5.11	24.1	5.16	24.7	5.21		
		35	16.6	3.45	19.8	4.37	22.5	5.25	22.8	5.28	23.1	5.30	23.7	5.35	24.3	5.40		
		37	16.6	3.66	19.8	4.65	22.2	5.44	22.5	5.46	22.8	5.49	23.4	5.54	24.0	5.60		
		39	16.6	3.88	19.8	4.95	21.8	5.62	22.1	5.65	22.4	5.68	23.0	5.73	23.6	5.79		
		100	22.40	10	15.1	1.98	18.0	2.28	20.9	2.63	22.4	2.82	23.9	3.02	26.8	3.44	28.3	3.57
				12	15.1	2.00	18.0	2.31	20.9	2.67	22.4	2.87	23.9	3.08	26.8	3.51	28.0	3.55
14	15.1			2.02	18.0	2.35	20.9	2.72	22.4	2.92	23.9	3.13	26.8	3.58	27.6	3.53		
16	15.1			2.05	18.0	2.38	20.9	2.77	22.4	2.98	23.9	3.19	26.7	3.62	27.2	3.59		
18	15.1			2.08	18.0	2.42	20.9	2.82	22.4	3.03	23.9	3.25	26.3	3.74	26.9	3.77		
20	15.1			2.11	18.0	2.46	20.9	2.90	22.4	3.18	23.9	3.48	26.0	3.92	26.5	3.95		
21	15.1			2.12	18.0	2.48	20.9	3.00	22.4	3.29	23.9	3.61	25.8	4.01	26.3	4.05		
23	15.1			2.17	18.0	2.64	20.9	3.21	22.4	3.53	23.9	3.87	25.4	4.20	25.9	4.23		
25	15.1			2.30	18.0	2.82	20.9	3.43	22.4	3.77	23.9	4.15	25.0	4.38	25.6	4.42		
27	15.1			2.44	18.0	3.00	20.9	3.66	22.4	4.04	23.9	4.44	24.7	4.56	25.2	4.60		
29	15.1			2.59	18.0	3.19	20.9	3.91	22.4	4.31	23.8	4.71	24.3	4.75	24.9	4.79		
31	15.1			2.74	18.0	3.39	20.9	4.17	22.4	4.60	23.4	4.89	23.9	4.94	24.5	4.98		
33	15.1			2.91	18.0	3.61	20.9	4.44	22.4	4.91	23.0	5.08	23.6	5.12	24.1	5.17		
35	15.1			3.08	18.0	3.83	20.9	4.73	22.4	5.24	22.7	5.26	23.2	5.31	23.8	5.36		
37	15.1			3.25	18.0	4.07	20.9	5.04	22.0	5.42	22.3	5.45	22.9	5.50	23.4	5.55		
39	15.1			3.44	18.0	4.32	20.9	5.37	21.7	5.61	21.9	5.64	22.5	5.69	23.0	5.74		

**NOTES - ANMERKUNGEN - Σημειώσεις - NOTAS - REMARQUES - NOTE - OPMERKINGEN - Примечания - NOTLAR**

- The above table shows the average value of conditions which may occur.  
 Die obige Tabelle zeigt den Durchschnittswert der Bedingungen, die auftreten können.  
 Στον παραπάνω πίνακα αναγράφεται η μέση τιμή για συνθήκες που μπορεί να προκύψουν.  
 La tabla de arriba muestra el valor medio de condiciones que pueden ocurrir.  
 Le tableau ci-dessus donne la valeur moyenne pour des conditions qui peuvent survenir.  
 La tabella in alto mostra il valore delle condizioni medie che si possono riscontrare.  
 De tabel hierboven geeft de gemiddelde waarde aan van situaties die kunnen voorvallen.  
 Таблица расположенная выше показывает среднее значение условий, которые могут наступить.  
 Yukarıdaki tablo meydana gelebilecek koşulların ortalama değerini göstermektedir.



# 5 Capacity tables

## 5 - 1 Cooling Capacity Tables

5

RQYQ8PY1

TC: Total Capacity: kW ; PI: Power Input: kW (compressor + outdoor fan motor)

Combination (%)	Capacity index (kW)	Outdoor air temp. °CDB	Indoor air temperature: °CWB													
			14.0		16.0		18.0		19.0		20.0		22.0		24.0	
			TC	PI	TC	PI	TC	PI	TC	PI	TC	PI	TC	PI	TC	PI
90	20.16	10	13.6	1.84	16.2	2.09	18.8	2.37	20.2	2.53	21.5	2.70	24.1	3.05	26.7	3.43
		12	13.6	1.86	16.2	2.11	18.8	2.41	20.2	2.57	21.5	2.74	24.1	3.11	26.7	3.50
		14	13.6	1.88	16.2	2.14	18.8	2.45	20.2	2.62	21.5	2.79	24.1	3.17	26.7	3.57
		16	13.6	1.90	16.2	2.17	18.8	2.49	20.2	2.66	21.5	2.84	24.1	3.23	26.7	3.63
		18	13.6	1.92	16.2	2.20	18.8	2.53	20.2	2.71	21.5	2.89	24.1	3.29	26.3	3.74
		20	13.6	1.94	16.2	2.24	18.8	2.57	20.2	2.76	21.5	3.00	24.1	3.54	25.9	3.92
		21	13.6	1.96	16.2	2.25	18.8	2.61	20.2	2.85	21.5	3.10	24.1	3.66	25.8	4.01
		23	13.6	1.98	16.2	2.34	18.8	2.79	20.2	3.05	21.5	3.32	24.1	3.93	25.4	4.20
		25	13.6	2.07	16.2	2.49	18.8	2.98	20.2	3.25	21.5	3.55	24.1	4.21	25.0	4.38
		27	13.6	2.20	16.2	2.64	18.8	3.17	20.2	3.47	21.5	3.79	24.1	4.50	24.7	4.56
		29	13.6	2.32	16.2	2.80	18.8	3.38	20.2	3.70	21.5	4.05	23.8	4.71	24.3	4.75
		31	13.6	2.46	16.2	2.98	18.8	3.60	20.2	3.95	21.5	4.32	23.4	4.90	23.9	4.93
		33	13.6	2.60	16.2	3.16	18.8	3.83	20.2	4.20	21.5	4.61	23.1	5.08	23.6	5.12
		35	13.6	2.74	16.2	3.35	18.8	4.07	20.2	4.48	21.5	4.91	22.7	5.27	23.2	5.31
		37	13.6	2.89	16.2	3.55	18.8	4.33	20.2	4.77	21.5	5.24	22.4	5.45	22.8	5.50
		39	13.6	3.06	16.2	3.76	18.8	4.60	20.2	5.07	21.5	5.58	22.0	5.64	22.5	5.69
		80	17.92	10	12.1	1.72	14.4	1.91	16.8	2.14	17.9	2.27	19.1	2.40	21.4	2.69
12	12.1			1.73	14.4	1.93	16.8	2.17	17.9	2.30	19.1	2.44	21.4	2.74	23.7	3.06
14	12.1			1.75	14.4	1.95	16.8	2.20	17.9	2.34	19.1	2.48	21.4	2.78	23.7	3.12
16	12.1			1.76	14.4	1.98	16.8	2.23	17.9	2.37	19.1	2.52	21.4	2.83	23.7	3.18
18	12.1			1.78	14.4	2.00	16.8	2.27	17.9	2.41	19.1	2.56	21.4	2.89	23.7	3.24
20	12.1			1.80	14.4	2.03	16.8	2.30	17.9	2.45	19.1	2.61	21.4	2.99	23.7	3.46
21	12.1			1.81	14.4	2.04	16.8	2.32	17.9	2.47	19.1	2.66	21.4	3.09	23.7	3.59
23	12.1			1.83	14.4	2.07	16.8	2.42	17.9	2.62	19.1	2.84	21.4	3.31	23.7	3.84
25	12.1			1.87	14.4	2.19	16.8	2.58	17.9	2.79	19.1	3.03	21.4	3.54	23.7	4.12
27	12.1			1.98	14.4	2.33	16.8	2.74	17.9	2.97	19.1	3.23	21.4	3.78	23.7	4.40
29	12.1			2.09	14.4	2.46	16.8	2.91	17.9	3.17	19.1	3.44	21.4	4.04	23.7	4.71
31	12.1			2.20	14.4	2.61	16.8	3.09	17.9	3.37	19.1	3.66	21.4	4.31	23.4	4.89
33	12.1			2.32	14.4	2.76	16.8	3.28	17.9	3.58	19.1	3.89	21.4	4.59	23.0	5.08
35	12.1			2.45	14.4	2.92	16.8	3.48	17.9	3.80	19.1	4.14	21.4	4.89	22.7	5.26
37	12.1			2.58	14.4	3.08	16.8	3.69	17.9	4.04	19.1	4.40	21.4	5.22	22.3	5.45
39	12.1			2.71	14.4	3.26	16.8	3.92	17.9	4.29	19.1	4.68	21.4	5.56	21.9	5.63
70	15.68			10	10.6	1.61	12.6	1.76	14.7	1.93	15.7	2.03	16.7	2.13	18.7	2.36
		12	10.6	1.62	12.6	1.77	14.7	1.95	15.7	2.06	16.7	2.16	18.7	2.40	20.8	2.65
		14	10.6	1.63	12.6	1.79	14.7	1.98	15.7	2.08	16.7	2.19	18.7	2.43	20.8	2.70
		16	10.6	1.65	12.6	1.81	14.7	2.00	15.7	2.11	16.7	2.23	18.7	2.47	20.8	2.75
		18	10.6	1.66	12.6	1.83	14.7	2.03	15.7	2.14	16.7	2.26	18.7	2.52	20.8	2.79
		20	10.6	1.67	12.6	1.85	14.7	2.06	15.7	2.17	16.7	2.29	18.7	2.56	20.8	2.87
		21	10.6	1.68	12.6	1.86	14.7	2.07	15.7	2.19	16.7	2.31	18.7	2.60	20.8	2.97
		23	10.6	1.69	12.6	1.88	14.7	2.10	15.7	2.25	16.7	2.41	18.7	2.77	20.8	3.17
		25	10.6	1.71	12.6	1.94	14.7	2.23	15.7	2.39	16.7	2.57	18.7	2.96	20.8	3.39
		27	10.6	1.79	12.6	2.05	14.7	2.36	15.7	2.54	16.7	2.73	18.7	3.15	20.8	3.62
		29	10.6	1.89	12.6	2.17	14.7	2.51	15.7	2.70	16.7	2.90	18.7	3.35	20.8	3.86
		31	10.6	1.98	12.6	2.29	14.7	2.65	15.7	2.86	16.7	3.08	18.7	3.57	20.8	4.12
		33	10.6	2.09	12.6	2.41	14.7	2.81	15.7	3.03	16.7	3.27	18.7	3.80	20.8	4.39
		35	10.6	2.19	12.6	2.54	14.7	2.97	15.7	3.21	16.7	3.47	18.7	4.04	20.8	4.68
		37	10.6	2.30	12.6	2.68	14.7	3.14	15.7	3.40	16.7	3.68	18.7	4.29	20.8	4.98
		39	10.6	2.41	12.6	2.83	14.7	3.32	15.7	3.60	16.7	3.90	18.7	4.56	20.8	5.31
		60	13.44	10	9.1	1.52	10.8	1.63	12.6	1.75	13.4	1.82	14.3	1.90	16.1	2.07
12	9.1			1.53	10.8	1.64	12.6	1.77	13.4	1.84	14.3	1.92	16.1	2.10	17.8	2.29
14	9.1			1.54	10.8	1.65	12.6	1.79	13.4	1.86	14.3	1.94	16.1	2.12	17.8	2.32
16	9.1			1.55	10.8	1.66	12.6	1.80	13.4	1.88	14.3	1.97	16.1	2.15	17.8	2.36
18	9.1			1.56	10.8	1.68	12.6	1.82	13.4	1.90	14.3	1.99	16.1	2.18	17.8	2.40
20	9.1			1.57	10.8	1.69	12.6	1.84	13.4	1.93	14.3	2.02	16.1	2.22	17.8	2.43
21	9.1			1.57	10.8	1.70	12.6	1.85	13.4	1.94	14.3	2.03	16.1	2.23	17.8	2.46
23	9.1			1.58	10.8	1.71	12.6	1.87	13.4	1.96	14.3	2.06	16.1	2.31	17.8	2.60
25	9.1			1.59	10.8	1.73	12.6	1.93	13.4	2.05	14.3	2.18	16.1	2.46	17.8	2.77
27	9.1			1.63	10.8	1.82	12.6	2.04	13.4	2.17	14.3	2.31	16.1	2.61	17.8	2.95
29	9.1			1.72	10.8	1.92	12.6	2.16	13.4	2.30	14.3	2.44	16.1	2.77	17.8	3.14
31	9.1			1.80	10.8	2.02	12.6	2.28	13.4	2.43	14.3	2.59	16.1	2.94	17.8	3.34
33	9.1			1.89	10.8	2.12	12.6	2.40	13.4	2.56	14.3	2.74	16.1	3.12	17.8	3.55
35	9.1			1.97	10.8	2.23	12.6	2.53	13.4	2.71	14.3	2.89	16.1	3.30	17.8	3.77
37	9.1			2.07	10.8	2.34	12.6	2.67	13.4	2.86	14.3	3.06	16.1	3.50	17.8	4.00
39	9.1			2.16	10.8	2.46	12.6	2.81	13.4	3.02	14.3	3.23	16.1	3.71	17.8	4.25
50	11.20			10	7.56	1.45	9.0	1.52	10.5	1.60	11.2	1.65	11.9	1.70	13.4	1.82
		12	7.56	1.46	9.0	1.53	10.5	1.61	11.2	1.66	11.9	1.72	13.4	1.84	14.8	1.97
		14	7.56	1.46	9.0	1.53	10.5	1.63	11.2	1.68	11.9	1.73	13.4	1.86	14.8	2.00
		16	7.56	1.47	9.0	1.54	10.5	1.64	11.2	1.69	11.9	1.75	13.4	1.88	14.8	2.02
		18	7.56	1.47	9.0	1.55	10.5	1.65	11.2	1.71	11.9	1.77	13.4	1.90	14.8	2.05
		20	7.56	1.48	9.0	1.56	10.5	1.66	11.2	1.72	11.9	1.78	13.4	1.92	14.8	2.08
		21	7.56	1.48	9.0	1.57	10.5	1.67	11.2	1.73	11.9	1.79	13.4	1.93	14.8	2.09
		23	7.56	1.49	9.0	1.58	10.5	1.69	11.2	1.75	11.9	1.81	13.4	1.96	14.8	2.13
		25	7.56	1.50	9.0	1.59	10.5	1.70	11.2	1.77	11.9	1.85	13.4	2.04	14.8	2.26
		27	7.56	1.51	9.0	1.63	10.5	1.78	11.2	1.87	11.9	1.96	13.4	2.16	14.8	2.40
		29	7.56	1.58	9.0	1.71	10.5	1.87	11.2	1.97	11.9	2.07	13.4	2.29	14.8	2.54
		31	7.56	1.65	9.0	1.79	10.5									



# 5 Capacity tables

## 5 - 1 Cooling Capacity Tables

**RQYQ10PY1**

TC: Total Capacity: kW ; PI: Power Input: kW (compressor + outdoor fan motor)

Combination (%)	Capacity index (kW)	Outdoor air temp. °CDB	Indoor air temperature: °CWB															
			14.0		16.0		18.0		19.0		20.0		22.0		24.0			
			TC	PI	TC	PI	TC	PI	TC	PI	TC	PI	TC	PI	TC	PI		
130	36.40	10	24.6	3.80	29.3	4.47	34.0	5.15	35.3	5.23	35.7	5.12	36.6	4.91	37.5	4.69		
		12	24.6	3.85	29.3	4.53	34.0	5.23	34.8	5.20	35.3	5.09	36.1	4.87	37.0	4.80		
		14	24.6	3.91	29.3	4.60	33.9	5.28	34.4	5.18	34.8	5.07	35.7	5.03	36.6	5.07		
		16	24.6	3.97	29.3	4.68	33.5	5.26	33.9	5.22	34.3	5.25	35.2	5.30	36.1	5.35		
		18	24.6	4.03	29.3	4.75	33.0	5.46	33.4	5.49	33.9	5.51	34.8	5.57	35.7	5.62		
		20	24.6	4.10	29.3	5.05	32.5	5.73	33.0	5.75	33.4	5.78	34.3	5.84	35.2	5.90		
		21	24.6	4.20	29.3	5.22	32.3	5.86	32.8	5.89	33.2	5.92	34.1	5.98	35.0	6.04		
		23	24.6	4.48	29.3	5.57	31.9	6.13	32.3	6.16	32.7	6.19	33.6	6.25	34.5	6.31		
		25	24.6	4.77	29.3	5.95	31.4	6.39	31.8	6.43	32.3	6.46	33.2	6.53	34.1	6.59		
		27	24.6	5.08	29.3	6.34	31.0	6.66	31.4	6.70	31.8	6.73	32.7	6.80	33.6	6.87		
		29	24.6	5.40	29.3	6.75	30.5	6.93	30.9	6.97	31.4	7.01	32.3	7.08	33.2	7.16		
		31	24.6	5.73	29.2	7.13	30.0	7.21	30.5	7.24	30.9	7.28	31.8	7.36	32.7	7.44		
		33	24.6	6.08	28.7	7.39	29.6	7.48	30.0	7.52	30.5	7.56	31.4	7.64	32.2	7.73		
		35	24.6	6.45	28.2	7.66	29.1	7.75	29.6	7.80	30.0	7.84	30.9	7.93	31.8	8.02		
		37	24.6	6.84	27.8	7.93	28.7	8.03	29.1	8.07	29.6	8.12	30.4	8.21	31.3	8.30		
		39	24.6	7.26	27.3	8.21	28.2	8.30	28.7	8.35	29.1	8.40	30.0	8.50	30.9	8.60		
		120	33.60	10	22.7	3.54	27.0	4.14	31.4	4.77	33.6	5.09	35.2	5.26	36.0	5.06	36.8	4.86
				12	22.7	3.59	27.0	4.21	31.4	4.84	33.6	5.17	34.7	5.23	35.5	5.03	36.3	4.83
14	22.7			3.64	27.0	4.27	31.4	4.92	33.6	5.25	34.2	5.20	35.1	5.00	35.9	5.04		
16	22.7			3.69	27.0	4.34	31.4	5.00	33.4	5.28	33.8	5.21	34.6	5.26	35.4	5.31		
18	22.7			3.75	27.0	4.41	31.4	5.15	32.9	5.46	33.3	5.48	34.1	5.53	35.0	5.58		
20	22.7			3.81	27.0	4.57	31.4	5.52	32.5	5.72	32.9	5.75	33.7	5.80	34.5	5.85		
21	22.7			3.84	27.0	4.72	31.4	5.71	32.2	5.85	32.6	5.88	33.5	5.94	34.3	5.99		
23	22.7			4.08	27.0	5.04	31.4	6.09	31.8	6.12	32.2	6.15	33.0	6.21	33.8	6.27		
25	22.7			4.34	27.0	5.37	30.9	6.36	31.3	6.39	31.7	6.42	32.6	6.48	33.4	6.54		
27	22.7			4.62	27.0	5.72	30.5	6.63	30.9	6.66	31.3	6.69	32.1	6.75	32.9	6.82		
29	22.7			4.90	27.0	6.08	30.0	6.89	30.4	6.93	30.8	6.96	31.6	7.03	32.5	7.10		
31	22.7			5.20	27.0	6.47	29.5	7.16	30.0	7.20	30.4	7.23	31.2	7.31	32.0	7.38		
33	22.7			5.52	27.0	6.87	29.1	7.43	29.5	7.47	29.9	7.51	30.7	7.59	31.5	7.66		
35	22.7			5.85	27.0	7.30	28.6	7.70	29.0	7.74	29.5	7.78	30.3	7.87	31.1	7.95		
37	22.7			6.20	27.0	7.75	28.2	7.98	28.6	8.02	29.0	8.06	29.8	8.15	30.6	8.23		
39	22.7			6.56	26.9	8.16	27.7	8.25	28.1	8.29	28.5	8.34	29.4	8.43	30.2	8.52		
110	30.80			10	20.8	3.29	24.8	3.83	28.8	4.39	30.8	4.68	32.8	4.97	35.3	5.21	36.1	5.03
				12	20.8	3.33	24.8	3.88	28.8	4.46	30.8	4.75	32.8	5.05	34.9	5.18	35.6	5.00
		14	20.8	3.38	24.8	3.94	28.8	4.53	30.8	4.83	32.8	5.13	34.4	5.16	35.2	5.00		
		16	20.8	3.42	24.8	4.00	28.8	4.60	30.8	4.91	32.8	5.21	34.0	5.23	34.7	5.27		
		18	20.8	3.48	24.8	4.07	28.8	4.68	30.8	5.02	32.8	5.45	33.5	5.49	34.3	5.54		
		20	20.8	3.53	24.8	4.13	28.8	4.94	30.8	5.38	32.3	5.71	33.1	5.76	33.8	5.81		
		21	20.8	3.55	24.8	4.25	28.8	5.10	30.8	5.57	32.1	5.84	32.8	5.89	33.6	5.94		
		23	20.8	3.70	24.8	4.53	28.8	5.45	30.8	5.95	31.6	6.11	32.4	6.16	33.1	6.22		
		25	20.8	3.94	24.8	4.83	28.8	5.82	30.8	6.35	31.2	6.38	31.9	6.43	32.7	6.49		
		27	20.8	4.18	24.8	5.13	28.8	6.20	30.3	6.62	30.7	6.65	31.5	6.71	32.2	6.76		
		29	20.8	4.44	24.8	5.46	28.8	6.60	29.9	6.88	30.3	6.91	31.0	6.98	31.8	7.04		
		31	20.8	4.70	24.8	5.80	28.8	7.02	29.4	7.15	29.8	7.19	30.6	7.25	31.3	7.32		
		33	20.8	4.98	24.8	6.15	28.6	7.39	29.0	7.42	29.4	7.46	30.1	7.53	30.9	7.60		
		35	20.8	5.28	24.8	6.53	28.1	7.65	28.5	7.69	28.9	7.73	29.6	7.80	30.4	7.88		
		37	20.8	5.59	24.8	6.92	27.7	7.92	28.1	7.96	28.4	8.00	29.2	8.08	29.9	8.16		
		39	20.8	5.91	24.8	7.34	27.2	8.20	27.6	8.24	28.0	8.28	28.7	8.36	29.5	8.44		
		100	28.00	10	18.9	3.04	22.5	3.52	26.2	4.02	28.0	4.28	29.8	4.54	33.5	5.07	35.4	5.20
				12	18.9	3.08	22.5	3.57	26.2	4.08	28.0	4.34	29.8	4.61	33.5	5.15	34.9	5.17
14	18.9			3.12	22.5	3.62	26.2	4.14	28.0	4.41	29.8	4.68	33.5	5.23	34.5	5.14		
16	18.9			3.16	22.5	3.67	26.2	4.21	28.0	4.48	29.8	4.76	33.3	5.28	34.0	5.23		
18	18.9			3.21	22.5	3.73	26.2	4.28	28.0	4.55	29.8	4.83	32.9	5.45	33.6	5.50		
20	18.9			3.25	22.5	3.79	26.2	4.39	28.0	4.77	29.8	5.16	32.4	5.72	33.1	5.76		
21	18.9			3.28	22.5	3.82	26.2	4.53	28.0	4.93	29.8	5.34	32.2	5.85	32.9	5.90		
23	18.9			3.35	22.5	4.05	26.2	4.84	28.0	5.26	29.8	5.70	31.8	6.12	32.4	6.17		
25	18.9			3.56	22.5	4.31	26.2	5.16	28.0	5.61	29.8	6.08	31.3	6.39	32.0	6.44		
27	18.9			3.77	22.5	4.58	26.2	5.49	28.0	5.98	29.8	6.49	30.8	6.66	31.5	6.71		
29	18.9			4.00	22.5	4.87	26.2	5.84	28.0	6.36	29.7	6.87	30.4	6.93	31.1	6.98		
31	18.9			4.23	22.5	5.17	26.2	6.21	28.0	6.77	29.3	7.14	29.9	7.20	30.6	7.26		
33	18.9			4.48	22.5	5.48	26.2	6.59	28.0	7.19	28.8	7.40	29.5	7.47	30.2	7.53		
35	18.9			4.74	22.5	5.81	26.2	7.00	28.0	7.64	28.3	7.67	29.0	7.74	29.7	7.81		
37	18.9			5.01	22.5	6.15	26.2	7.43	27.5	7.91	27.9	7.94	28.6	8.02	29.2	8.09		
39	18.9			5.29	22.5	6.51	26.2	7.88	27.1	8.18	27.4	8.22	28.1	8.29	28.8	8.37		

**NOTES - ANMERKUNGEN - Σημειώσεις - NOTAS - REMARQUES - NOTE - OPMERKINGEN - Примечания - NOTLAR**

- The above table shows the average value of conditions which may occur.  
 Die obige Tabelle zeigt den Durchschnittswert der Bedingungen, die auftreten können.  
 Στον παραπάνω πίνακα αναγράφεται η μέση τιμή για συνθήκες που μπορεί να προκύψουν.  
 La tabla de arriba muestra el valor medio de condiciones que pueden ocurrir.  
 Le tableau ci-dessus donne la valeur moyenne pour des conditions qui peuvent survenir.  
 La tabella in alto mostra il valore delle condizioni medie che si possono riscontrare.  
 De tabel hierboven geeft de gemiddelde waarde aan van situaties die kunnen voorvallen.  
 Таблица расположенная выше показывает среднее значение условий, которые могут наступить.  
 Yukarıdaki tablo meydana gelebilecek kobluların ortalama değerini göstermektedir.

# 5 Capacity tables

## 5 - 1 Cooling Capacity Tables

5

RQYQ10PY1

TC: Total Capacity: kW ; PI: Power Input: kW (compressor + outdoor fan motor)

Combination (%)	Capacity index (kW)	Outdoor air temp. °CDB	Indoor air temperature: °CWB															
			14.0		16.0		18.0		19.0		20.0		22.0		24.0			
			TC	PI	TC	PI	TC	PI	TC	PI	TC	PI	TC	PI	TC	PI		
90	25.20	10	17.0	2.80	20.3	3.22	23.6	3.66	25.2	3.89	26.8	4.12	30.1	4.58	33.4	5.06		
		12	17.0	2.83	20.3	3.26	23.6	3.71	25.2	3.94	26.8	4.18	30.1	4.65	33.4	5.14		
		14	17.0	2.87	20.3	3.31	23.6	3.77	25.2	4.00	26.8	4.24	30.1	4.73	33.4	5.22		
		16	17.0	2.91	20.3	3.35	23.6	3.82	25.2	4.06	26.8	4.31	30.1	4.80	33.3	5.29		
		18	17.0	2.95	20.3	3.40	23.6	3.88	25.2	4.13	26.8	4.38	30.1	4.88	32.9	5.45		
		20	17.0	2.99	20.3	3.45	23.6	3.94	25.2	4.19	26.8	4.52	30.1	5.23	32.4	5.72		
		21	17.0	3.01	20.3	3.48	23.6	4.00	25.2	4.33	26.8	4.67	30.1	5.41	32.2	5.85		
		23	17.0	3.05	20.3	3.61	23.6	4.27	25.2	4.62	26.8	4.99	30.1	5.78	31.7	6.12		
		25	17.0	3.20	20.3	3.83	23.6	4.54	25.2	4.92	26.8	5.32	30.1	6.16	31.3	6.39		
		27	17.0	3.39	20.3	4.07	23.6	4.83	25.2	5.24	26.8	5.66	30.1	6.57	30.8	6.65		
		29	17.0	3.59	20.3	4.32	23.6	5.13	25.2	5.57	26.8	6.03	29.8	6.87	30.4	6.92		
		31	17.0	3.79	20.3	4.58	23.6	5.45	25.2	5.92	26.8	6.41	29.3	7.14	29.9	7.19		
		33	17.0	4.01	20.3	4.85	23.6	5.78	25.2	6.28	26.8	6.81	28.9	7.41	29.5	7.47		
		35	17.0	4.23	20.3	5.13	23.6	6.13	25.2	6.67	26.8	7.23	28.4	7.68	29.0	7.74		
		37	17.0	4.47	20.3	5.43	23.6	6.50	25.2	7.07	26.8	7.67	27.9	7.95	28.6	8.01		
		39	17.0	4.72	20.3	5.74	23.6	6.88	25.2	7.50	26.8	8.14	27.5	8.22	28.1	8.29		
		80	22.40	10	15.1	2.57	18.0	2.93	20.9	3.31	22.4	3.50	23.9	3.70	26.8	4.11	29.7	4.52
				12	15.1	2.60	18.0	2.96	20.9	3.35	22.4	3.55	23.9	3.75	26.8	4.17	29.7	4.59
14	15.1			2.63	18.0	3.00	20.9	3.40	22.4	3.60	23.9	3.81	26.8	4.23	29.7	4.66		
16	15.1			2.66	18.0	3.04	20.9	3.45	22.4	3.65	23.9	3.87	26.8	4.30	29.7	4.74		
18	15.1			2.69	18.0	3.09	20.9	3.50	22.4	3.71	23.9	3.93	26.8	4.37	29.7	4.81		
20	15.1			2.73	18.0	3.13	20.9	3.55	22.4	3.77	23.9	3.99	26.8	4.51	29.7	5.13		
21	15.1			2.75	18.0	3.15	20.9	3.58	22.4	3.80	23.9	4.06	26.8	4.66	29.7	5.31		
23	15.1			2.78	18.0	3.20	20.9	3.73	22.4	4.03	23.9	4.33	26.8	4.97	29.7	5.67		
25	15.1			2.86	18.0	3.39	20.9	3.97	22.4	4.28	23.9	4.61	26.8	5.30	29.7	6.05		
27	15.1			3.03	18.0	3.59	20.9	4.22	22.4	4.55	23.9	4.90	26.8	5.65	29.7	6.45		
29	15.1			3.20	18.0	3.81	20.9	4.48	22.4	4.83	23.9	5.21	26.8	6.01	29.7	6.87		
31	15.1			3.38	18.0	4.03	20.9	4.74	22.4	5.13	23.9	5.53	26.8	6.38	29.2	7.13		
33	15.1			3.57	18.0	4.26	20.9	5.03	22.4	5.44	23.9	5.87	26.8	6.78	28.8	7.40		
35	15.1			3.76	18.0	4.50	20.9	5.32	22.4	5.76	23.9	6.22	26.8	7.20	28.3	7.67		
37	15.1			3.97	18.0	4.76	20.9	5.63	22.4	6.11	23.9	6.60	26.8	7.64	27.9	7.94		
39	15.1			4.18	18.0	5.03	20.9	5.96	22.4	6.47	23.9	6.99	26.8	8.11	27.4	8.21		
70	19.60			10	13.2	2.35	15.8	2.65	18.3	2.97	19.6	3.13	20.9	3.30	23.4	3.64	26.0	3.99
				12	13.2	2.37	15.8	2.68	18.3	3.00	19.6	3.17	20.9	3.34	23.4	3.69	26.0	4.05
		14	13.2	2.40	15.8	2.71	18.3	3.04	19.6	3.21	20.9	3.39	23.4	3.75	26.0	4.11		
		16	13.2	2.42	15.8	2.75	18.3	3.08	19.6	3.26	20.9	3.44	23.4	3.80	26.0	4.18		
		18	13.2	2.45	15.8	2.78	18.3	3.13	19.6	3.31	20.9	3.49	23.4	3.86	26.0	4.24		
		20	13.2	2.48	15.8	2.82	18.3	3.17	19.6	3.35	20.9	3.54	23.4	3.92	26.0	4.35		
		21	13.2	2.50	15.8	2.84	18.3	3.19	19.6	3.38	20.9	3.57	23.4	3.98	26.0	4.49		
		23	13.2	2.53	15.8	2.87	18.3	3.24	19.6	3.48	20.9	3.72	23.4	4.24	26.0	4.79		
		25	13.2	2.56	15.8	2.97	18.3	3.44	19.6	3.70	20.9	3.96	23.4	4.51	26.0	5.11		
		27	13.2	2.69	15.8	3.15	18.3	3.65	19.6	3.92	20.9	4.20	23.4	4.80	26.0	5.44		
		29	13.2	2.84	15.8	3.33	18.3	3.87	19.6	4.16	20.9	4.46	23.4	5.10	26.0	5.78		
		31	13.2	2.99	15.8	3.52	18.3	4.10	19.6	4.41	20.9	4.73	23.4	5.41	26.0	6.14		
		33	13.2	3.16	15.8	3.72	18.3	4.33	19.6	4.66	20.9	5.01	23.4	5.74	26.0	6.53		
		35	13.2	3.32	15.8	3.92	18.3	4.58	19.6	4.94	20.9	5.30	23.4	6.08	26.0	6.93		
		37	13.2	3.50	15.8	4.14	18.3	4.84	19.6	5.22	20.9	5.61	23.4	6.45	26.0	7.35		
		39	13.2	3.68	15.8	4.36	18.3	5.12	19.6	5.52	20.9	5.94	23.4	6.83	26.0	7.80		
		60	16.80	10	11.3	2.13	13.5	2.38	15.7	2.64	16.8	2.77	17.9	2.91	20.1	3.19	22.3	3.48
				12	11.3	2.15	13.5	2.41	15.7	2.67	16.8	2.81	17.9	2.95	20.1	3.23	22.3	3.53
14	11.3			2.18	13.5	2.43	15.7	2.70	16.8	2.84	17.9	2.99	20.1	3.28	22.3	3.58		
16	11.3			2.20	13.5	2.46	15.7	2.74	16.8	2.88	17.9	3.03	20.1	3.33	22.3	3.63		
18	11.3			2.22	13.5	2.49	15.7	2.77	16.8	2.92	17.9	3.07	20.1	3.37	22.3	3.69		
20	11.3			2.24	13.5	2.52	15.7	2.81	16.8	2.96	17.9	3.11	20.1	3.42	22.3	3.75		
21	11.3			2.26	13.5	2.53	15.7	2.83	16.8	2.98	17.9	3.13	20.1	3.45	22.3	3.78		
23	11.3			2.28	13.5	2.57	15.7	2.86	16.8	3.02	17.9	3.18	20.1	3.57	22.3	4.00		
25	11.3			2.31	13.5	2.60	15.7	2.96	16.8	3.16	17.9	3.36	20.1	3.79	22.3	4.25		
27	11.3			2.38	13.5	2.74	15.7	3.14	16.8	3.35	17.9	3.56	20.1	4.03	22.3	4.52		
29	11.3			2.51	13.5	2.89	15.7	3.32	16.8	3.54	17.9	3.78	20.1	4.27	22.3	4.80		
31	11.3			2.64	13.5	3.05	15.7	3.50	16.8	3.75	17.9	4.00	20.1	4.52	22.3	5.09		
33	11.3			2.78	13.5	3.22	15.7	3.70	16.8	3.96	17.9	4.23	20.1	4.79	22.3	5.40		
35	11.3			2.92	13.5	3.39	15.7	3.91	16.8	4.18	17.9	4.47	20.1	5.07	22.3	5.72		
37	11.3			3.07	13.5	3.57	15.7	4.12	16.8	4.41	17.9	4.72	20.1	5.37	22.3	6.06		
39	11.3			3.22	13.5	3.76	15.7	4.34	16.8	4.66	17.9	4.98	20.1	5.67	22.3	6.42		
50	14.00			10	9.45	1.93	11.3	2.13	13.1	2.33	14.0	2.44	14.9	2.54	16.7	2.76	18.6	2.99
				12	9.45	1.95	11.3	2.15	13.1	2.36	14.0	2.46	14.9	2.57	16.7	2.80	18.6	3.03
		14	9.45	1.97	11.3	2.17	13.1	2.38	14.0	2.49	14.9	2.60	16.7	2.83	18.6	3.07		
		16	9.45	1.98	11.3	2.19	13.1	2.41	14.0	2.52	14.9	2.63	16.7	2.87	18.6	3.11		
		18	9.45	2.00	11.3	2.21	13.1	2.43	14.0	2.55	14.9	2.67	16.7	2.91	18.6	3.16		
		20	9.45	2.02	11.3	2.24	13.1	2.46	14.0	2.58	14.9	2.70	16.7	2.95	18.6	3.20		
		21	9.45	2.03	11.3	2.25	13.1	2.48	14.0	2.60	14.9	2.72	16.7	2.97	18.6	3.23		
		23	9.45	2.05	11.3	2.27	13.1	2.51	14.0	2.63	14.9	2.75	16.7	3.01	18.6	3.28		
		25	9.45	2.07	11.3	2.30	13.1	2.54	14.0	2.67	14.9	2.82	16.7	3.15	18.6	3.49		
		27	9.45	2.09	11.3	2.37	13.1	2.67	14.0	2.82	14.9	2.99	16.7	3.33	18.6	3.70		
		29	9.45	2.20	11.3	2.49	13.1	2.81	14.0	2.98	14.9	3.16	16.7	3.53	18.6	3.92		
		31	9.45	2.31														

# 5 Capacity tables

## 5 - 1 Cooling Capacity Tables

### RQYQ12PY1

TC: Total Capacity: kW ; PI: Power Input: kW (compressor + outdoor fan motor)

Combination (%)	Capacity index (kW)	Outdoor air temp. °CDB	Indoor air temperature: °CWB													
			14.0		16.0		18.0		19.0		20.0		22.0		24.0	
			TC	PI	TC	PI	TC	PI	TC	PI	TC	PI	TC	PI	TC	PI
130	43.55	10	29.4	4.76	35.1	5.71	40.7	6.77	42.2	6.91	42.7	6.77	43.8	6.49	44.8	6.20
		12	29.4	4.84	35.1	5.81	40.7	6.90	41.6	6.88	42.2	6.74	43.2	6.44	44.3	6.34
		14	29.4	4.92	35.1	5.92	40.6	6.99	41.1	6.84	41.6	6.70	42.7	6.64	43.8	6.71
		16	29.4	5.00	35.1	6.03	40.0	6.95	40.6	6.90	41.1	6.93	42.1	7.00	43.2	7.07
		18	29.4	5.08	35.1	6.15	39.5	7.22	40.0	7.25	40.5	7.29	41.6	7.36	42.7	7.43
		20	29.4	5.17	35.1	6.55	38.9	7.57	39.5	7.61	40.0	7.65	41.1	7.72	42.1	7.80
		21	29.4	5.31	35.1	6.78	38.7	7.75	39.2	7.79	39.7	7.82	40.8	7.90	41.8	7.98
		23	29.4	5.68	35.1	7.27	38.1	8.10	38.7	8.14	39.2	8.18	40.2	8.26	41.3	8.35
		25	29.4	6.06	35.1	7.78	37.6	8.45	38.1	8.50	38.6	8.54	39.7	8.63	40.8	8.72
		27	29.4	6.47	35.1	8.32	37.0	8.81	37.6	8.86	38.1	8.90	39.2	9.00	40.2	9.09
		29	29.4	6.89	35.1	8.90	36.5	9.17	37.0	9.22	37.5	9.27	38.6	9.36	39.7	9.46
		31	29.4	7.34	34.9	9.42	35.9	9.53	36.5	9.58	37.0	9.63	38.1	9.73	39.1	9.84
		33	29.4	7.82	34.3	9.78	35.4	9.89	35.9	9.94	36.5	10.00	37.5	10.11	38.6	10.22
		35	29.4	8.32	33.8	10.13	34.9	10.25	35.4	10.31	35.9	10.36	37.0	10.48	38.0	10.60
		37	29.4	8.85	33.2	10.49	34.3	10.61	34.8	10.67	35.4	10.73	36.4	10.9	37.5	11.0
		39	29.4	9.42	32.7	10.8	33.8	11.0	34.3	11.0	34.8	11.1	35.9	11.2	36.9	11.4
		120	40.20	10	27.1	4.42	32.4	5.24	37.6	6.17	40.2	6.67	42.1	6.95	43.0	6.69
12	27.1			4.48	32.4	5.33	37.6	6.29	40.2	6.79	41.5	6.92	42.5	6.65	43.5	6.38
14	27.1			4.55	32.4	5.43	37.6	6.41	40.2	6.93	41.0	6.88	41.9	6.61	42.9	6.66
16	27.1			4.62	32.4	5.52	37.6	6.53	39.9	6.98	40.4	6.89	41.4	6.95	42.4	7.02
18	27.1			4.70	32.4	5.63	37.6	6.75	39.4	7.21	39.9	7.24	40.9	7.31	41.8	7.38
20	27.1			4.78	32.4	5.84	37.6	7.26	38.8	7.56	39.3	7.60	40.3	7.67	41.3	7.74
21	27.1			4.82	32.4	6.05	37.6	7.52	38.6	7.74	39.1	7.78	40.0	7.85	41.0	7.92
23	27.1			5.13	32.4	6.47	37.5	8.05	38.0	8.09	38.5	8.13	39.5	8.21	40.5	8.28
25	27.1			5.47	32.4	6.92	37.0	8.41	37.5	8.45	38.0	8.49	38.9	8.57	39.9	8.65
27	27.1			5.82	32.4	7.39	36.4	8.76	36.9	8.80	37.4	8.84	38.4	8.93	39.4	9.02
29	27.1			6.20	32.4	7.90	35.9	9.11	36.4	9.16	36.9	9.20	37.9	9.29	38.8	9.38
31	27.1			6.59	32.4	8.42	35.4	9.47	35.8	9.52	36.3	9.56	37.3	9.66	38.3	9.76
33	27.1			7.01	32.4	8.98	34.8	9.83	35.3	9.88	35.8	9.93	36.8	10.03	37.7	10.13
35	27.1			7.45	32.4	9.58	34.3	10.18	34.8	10.24	35.2	10.29	36.2	10.40	37.2	10.51
37	27.1			7.91	32.4	10.21	33.7	10.54	34.2	10.60	34.7	10.66	35.7	10.77	36.7	10.9
39	27.1			8.40	32.2	10.79	33.2	10.9	33.7	11.0	34.2	11.0	35.1	11.1	36.1	11.3
110	36.85			10	24.9	4.10	29.7	4.80	34.5	5.60	36.9	6.04	39.2	6.48	42.3	6.89
		12	24.9	4.16	29.7	4.88	34.5	5.70	36.9	6.15	39.2	6.61	41.7	6.85	42.6	6.61
		14	24.9	4.21	29.7	4.96	34.5	5.81	36.9	6.26	39.2	6.73	41.2	6.82	42.1	6.61
		16	24.9	4.27	29.7	5.04	34.5	5.92	36.9	6.38	39.2	6.87	40.6	6.91	41.5	6.96
		18	24.9	4.34	29.7	5.13	34.5	6.03	36.9	6.56	39.2	7.20	40.1	7.26	41.0	7.32
		20	24.9	4.40	29.7	5.22	34.5	6.38	36.9	7.05	38.7	7.55	39.6	7.61	40.5	7.68
		21	24.9	4.44	29.7	5.38	34.5	6.61	36.9	7.30	38.4	7.73	39.3	7.79	40.2	7.86
		23	24.9	4.63	29.7	5.75	34.5	7.08	36.9	7.83	37.8	8.08	38.7	8.15	39.6	8.22
		25	24.9	4.93	29.7	6.14	34.5	7.58	36.9	8.39	37.3	8.43	38.2	8.51	39.1	8.58
		27	24.9	5.24	29.7	6.55	34.5	8.11	36.3	8.75	36.8	8.79	37.7	8.86	38.5	8.94
		29	24.9	5.56	29.7	6.98	34.5	8.67	35.8	9.10	36.2	9.14	37.1	9.22	38.0	9.31
		31	24.9	5.91	29.7	7.43	34.5	9.26	35.2	9.45	35.7	9.50	36.6	9.59	37.5	9.67
		33	24.9	6.27	29.7	7.92	34.2	9.76	34.7	9.81	35.1	9.86	36.0	9.95	36.9	10.04
		35	24.9	6.65	29.7	8.43	33.7	10.12	34.1	10.17	34.6	10.22	35.5	10.32	36.4	10.41
		37	24.9	7.05	29.7	8.97	33.1	10.48	33.6	10.53	34.0	10.58	34.9	10.68	35.8	10.79
		39	24.9	7.48	29.7	9.55	32.6	10.8	33.0	10.9	33.5	10.9	34.4	11.1	35.3	11.2
		100	33.50	10	22.6	3.81	27.0	4.39	31.3	5.07	33.5	5.44	35.7	5.82	40.0	6.64
12	22.6			3.85	27.0	4.46	31.3	5.16	33.5	5.53	35.7	5.93	40.0	6.76	41.8	6.84
14	22.6			3.90	27.0	4.53	31.3	5.24	33.5	5.63	35.7	6.04	40.0	6.89	41.3	6.80
16	22.6			3.95	27.0	4.60	31.3	5.34	33.5	5.74	35.7	6.15	39.9	6.99	40.7	6.91
18	22.6			4.00	27.0	4.67	31.3	5.43	33.5	5.84	35.7	6.27	39.4	7.21	40.2	7.26
20	22.6			4.06	27.0	4.75	31.3	5.59	33.5	6.13	35.7	6.72	38.8	7.56	39.6	7.62
21	22.6			4.09	27.0	4.79	31.3	5.78	33.5	6.35	35.7	6.96	38.5	7.74	39.4	7.80
23	22.6			4.18	27.0	5.09	31.3	6.19	33.5	6.80	35.7	7.46	38.0	8.09	38.8	8.15
25	22.6			4.44	27.0	5.43	31.3	6.61	33.5	7.28	35.7	7.99	37.4	8.44	38.3	8.51
27	22.6			4.71	27.0	5.78	31.3	7.06	33.5	7.78	35.7	8.55	36.9	8.80	37.7	8.87
29	22.6			4.99	27.0	6.15	31.3	7.53	33.5	8.31	35.5	9.08	36.4	9.15	37.2	9.23
31	22.6			5.29	27.0	6.54	31.3	8.03	33.5	8.87	35.0	9.43	35.8	9.51	36.6	9.59
33	22.6			5.60	27.0	6.95	31.3	8.56	33.5	9.47	34.5	9.79	35.3	9.87	36.1	9.96
35	22.6			5.93	27.0	7.38	31.3	9.12	33.5	10.10	33.9	10.14	34.7	10.23	35.5	10.32
37	22.6			6.27	27.0	7.85	31.3	9.72	33.0	10.46	33.4	10.50	34.2	10.60	35.0	10.69
39	22.6			6.64	27.0	8.33	31.3	10.36	32.4	10.81	32.8	10.9	33.6	11.0	34.4	11.1

**NOTES - ANMERKUNGEN - Σημειώσεις - NOTAS - REMARQUES - NOTE - OPMERKINGEN - Примечания - NOTLAR**

- The above table shows the average value of conditions which may occur.  
 Die obige Tabelle zeigt den Durchschnittswert der Bedingungen, die auftreten können.  
 Στον παραπάνω πίνακα αναγράφεται η μέση τιμή για συνθήκες που μπορεί να προκύψουν.  
 La tabla de arriba muestra el valor medio de condiciones que pueden ocurrir.  
 Le tableau ci-dessus donne la valeur moyenne pour des conditions qui peuvent survenir.  
 La tabella in alto mostra il valore delle condizioni medie che si possono riscontrare.  
 De tabel hierboven geeft de gemiddelde waarde aan van situaties die kunnen voorvallen.  
 Таблица расположенная выше показывает среднее значение условий, которые могут наступить.  
 Yukarıdaki tablo meydana gelebilecek koşulların ortalama değerini göstermektedir.

# 5 Capacity tables

## 5 - 1 Cooling Capacity Tables

5

### RQYQ12PY1

TC: Total Capacity: kW ; PI: Power Input: kW (compressor + outdoor fan motor)

Combination (%)	Capacity index (kW)	Outdoor air temp. °CDB	Indoor air temperature: °CWB															
			14.0		16.0		18.0		19.0		20.0		22.0		24.0			
			TC	PI	TC	PI	TC	PI	TC	PI	TC	PI	TC	PI	TC	PI		
90	30.15	10	20.3	3.54	24.3	4.02	28.2	4.58	30.2	4.88	32.1	5.20	36.0	5.89	40.0	6.62		
		12	20.3	3.58	24.3	4.07	28.2	4.65	30.2	4.96	32.1	5.29	36.0	5.99	40.0	6.75		
		14	20.3	3.62	24.3	4.13	28.2	4.72	30.2	5.04	32.1	5.38	36.0	6.11	40.0	6.88		
		16	20.3	3.66	24.3	4.19	28.2	4.80	30.2	5.13	32.1	5.48	36.0	6.22	39.9	6.99		
		18	20.3	3.70	24.3	4.25	28.2	4.88	30.2	5.22	32.1	5.58	36.0	6.34	39.3	7.21		
		20	20.3	3.75	24.3	4.31	28.2	4.96	30.2	5.31	32.1	5.78	36.0	6.82	38.8	7.56		
		21	20.3	3.77	24.3	4.34	28.2	5.04	30.2	5.49	32.1	5.98	36.0	7.06	38.5	7.74		
		23	20.3	3.82	24.3	4.50	28.2	5.38	30.2	5.87	32.1	6.40	36.0	7.57	38.0	8.09		
		25	20.3	4.00	24.3	4.79	28.2	5.74	30.2	6.27	32.1	6.85	36.0	8.11	37.4	8.44		
		27	20.3	4.23	24.3	5.09	28.2	6.12	30.2	6.69	32.1	7.31	36.0	8.68	36.9	8.80		
		29	20.3	4.48	24.3	5.41	28.2	6.51	30.2	7.14	32.1	7.81	35.6	9.09	36.3	9.15		
		31	20.3	4.73	24.3	5.74	28.2	6.93	30.2	7.61	32.1	8.33	35.1	9.44	35.8	9.51		
		33	20.3	5.00	24.3	6.08	28.2	7.38	30.2	8.10	32.1	8.88	34.5	9.79	35.3	9.87		
		35	20.3	5.28	24.3	6.45	28.2	7.85	30.2	8.63	32.1	9.47	34.0	10.15	34.7	10.23		
		37	20.3	5.58	24.3	6.84	28.2	8.34	30.2	9.19	32.1	10.09	33.4	10.51	34.2	10.60		
		39	20.3	5.89	24.3	7.25	28.2	8.87	30.2	9.78	32.1	10.76	32.9	10.9	33.6	11.0		
		80	26.80	10	18.1	3.31	21.6	3.68	25.1	4.13	26.8	4.37	28.5	4.63	32.0	5.19	35.5	5.79
				12	18.1	3.34	21.6	3.72	25.1	4.18	26.8	4.43	28.5	4.70	32.0	5.28	35.5	5.90
14	18.1			3.37	21.6	3.77	25.1	4.24	26.8	4.50	28.5	4.78	32.0	5.37	35.5	6.01		
16	18.1			3.40	21.6	3.81	25.1	4.30	26.8	4.57	28.5	4.85	32.0	5.46	35.5	6.12		
18	18.1			3.43	21.6	3.86	25.1	4.37	26.8	4.64	28.5	4.94	32.0	5.56	35.5	6.24		
20	18.1			3.47	21.6	3.91	25.1	4.43	26.8	4.72	28.5	5.02	32.0	5.76	35.5	6.67		
21	18.1			3.49	21.6	3.94	25.1	4.47	26.8	4.76	28.5	5.12	32.0	5.96	35.5	6.91		
23	18.1			3.52	21.6	3.99	25.1	4.67	26.8	5.05	28.5	5.47	32.0	6.38	35.5	7.41		
25	18.1			3.61	21.6	4.23	25.1	4.97	26.8	5.39	28.5	5.83	32.0	6.82	35.5	7.93		
27	18.1			3.82	21.6	4.48	25.1	5.28	26.8	5.73	28.5	6.22	32.0	7.29	35.5	8.49		
29	18.1			4.03	21.6	4.75	25.1	5.61	26.8	6.10	28.5	6.62	32.0	7.78	35.5	9.08		
31	18.1			4.25	21.6	5.03	25.1	5.96	26.8	6.49	28.5	7.05	32.0	8.30	35.0	9.43		
33	18.1			4.48	21.6	5.32	25.1	6.33	26.8	6.89	28.5	7.50	32.0	8.85	34.4	9.78		
35	18.1			4.71	21.6	5.62	25.1	6.71	26.8	7.32	28.5	7.98	32.0	9.43	33.9	10.14		
37	18.1			4.96	21.6	5.94	25.1	7.12	26.8	7.78	28.5	8.49	32.0	10.05	33.3	10.50		
39	18.1			5.23	21.6	6.28	25.1	7.55	26.8	8.26	28.5	9.03	32.0	10.71	32.8	10.9		
70	23.45			10	15.8	3.10	18.9	3.39	21.9	3.72	23.5	3.91	25.0	4.11	28.0	4.55	31.1	5.03
				12	15.8	3.12	18.9	3.42	21.9	3.77	23.5	3.96	25.0	4.17	28.0	4.62	31.1	5.11
		14	15.8	3.15	18.9	3.45	21.9	3.81	23.5	4.01	25.0	4.23	28.0	4.69	31.1	5.20		
		16	15.8	3.17	18.9	3.49	21.9	3.86	23.5	4.07	25.0	4.29	28.0	4.77	31.1	5.29		
		18	15.8	3.20	18.9	3.52	21.9	3.91	23.5	4.12	25.0	4.35	28.0	4.85	31.1	5.39		
		20	15.8	3.22	18.9	3.56	21.9	3.96	23.5	4.18	25.0	4.42	28.0	4.93	31.1	5.53		
		21	15.8	3.24	18.9	3.58	21.9	3.99	23.5	4.22	25.0	4.46	28.0	5.00	31.1	5.72		
		23	15.8	3.27	18.9	3.62	21.9	4.05	23.5	4.34	25.0	4.65	28.0	5.34	31.1	6.12		
		25	15.8	3.30	18.9	3.74	21.9	4.30	23.5	4.61	25.0	4.95	28.0	5.70	31.1	6.54		
		27	15.8	3.46	18.9	3.96	21.9	4.56	23.5	4.90	25.0	5.26	28.0	6.07	31.1	6.98		
		29	15.8	3.64	18.9	4.18	21.9	4.83	23.5	5.20	25.0	5.59	28.0	6.46	31.1	7.45		
		31	15.8	3.82	18.9	4.41	21.9	5.11	23.5	5.51	25.0	5.94	28.0	6.88	31.1	7.94		
		33	15.8	4.02	18.9	4.65	21.9	5.41	23.5	5.84	25.0	6.30	28.0	7.32	31.1	8.46		
		35	15.8	4.22	18.9	4.90	21.9	5.72	23.5	6.19	25.0	6.68	28.0	7.78	31.1	9.02		
		37	15.8	4.43	18.9	5.17	21.9	6.05	23.5	6.55	25.0	7.09	28.0	8.27	31.1	9.61		
		39	15.8	4.65	18.9	5.45	21.9	6.40	23.5	6.94	25.0	7.52	28.0	8.80	31.1	10.23		
		60	20.10	10	13.6	2.93	16.2	3.13	18.8	3.38	20.1	3.51	21.4	3.66	24.0	3.99	26.6	4.35
				12	13.6	2.95	16.2	3.16	18.8	3.41	20.1	3.55	21.4	3.70	24.0	4.04	26.6	4.41
14	13.6			2.96	16.2	3.18	18.8	3.44	20.1	3.59	21.4	3.75	24.0	4.09	26.6	4.48		
16	13.6			2.98	16.2	3.20	18.8	3.48	20.1	3.63	21.4	3.79	24.0	4.15	26.6	4.54		
18	13.6			3.00	16.2	3.23	18.8	3.51	20.1	3.67	21.4	3.84	24.0	4.21	26.6	4.62		
20	13.6			3.02	16.2	3.26	18.8	3.55	20.1	3.71	21.4	3.89	24.0	4.27	26.6	4.69		
21	13.6			3.03	16.2	3.27	18.8	3.57	20.1	3.74	21.4	3.92	24.0	4.30	26.6	4.73		
23	13.6			3.05	16.2	3.30	18.8	3.61	20.1	3.79	21.4	3.97	24.0	4.45	26.6	5.02		
25	13.6			3.07	16.2	3.34	18.8	3.73	20.1	3.95	21.4	4.20	24.0	4.74	26.6	5.35		
27	13.6			3.15	16.2	3.51	18.8	3.94	20.1	4.19	21.4	4.45	24.0	5.03	26.6	5.69		
29	13.6			3.31	16.2	3.69	18.8	4.16	20.1	4.43	21.4	4.71	24.0	5.34	26.6	6.05		
31	13.6			3.47	16.2	3.89	18.8	4.39	20.1	4.68	21.4	4.99	24.0	5.67	26.6	6.44		
33	13.6			3.63	16.2	4.09	18.8	4.63	20.1	4.94	21.4	5.27	24.0	6.01	26.6	6.84		
35	13.6			3.80	16.2	4.29	18.8	4.88	20.1	5.22	21.4	5.58	24.0	6.37	26.6	7.26		
37	13.6			3.98	16.2	4.51	18.8	5.15	20.1	5.51	21.4	5.89	24.0	6.75	26.6	7.72		
39	13.6			4.17	16.2	4.74	18.8	5.42	20.1	5.81	21.4	6.23	24.0	7.15	26.6	8.19		
50	16.75			10	11.3	2.80	13.5	2.93	15.7	3.09	16.8	3.18	17.8	3.28	20.0	3.51	22.2	3.76
				12	11.3	2.81	13.5	2.94	15.7	3.11	16.8	3.21	17.8	3.31	20.0	3.54	22.2	3.80
		14	11.3	2.82	13.5	2.96	15.7	3.13	16.8	3.23	17.8	3.34	20.0	3.58	22.2	3.85		
		16	11.3	2.83	13.5	2.98	15.7	3.16	16.8	3.26	17.8	3.37	20.0	3.62	22.2	3.90		
		18	11.3	2.84	13.5	2.99	15.7	3.18	16.8	3.29	17.8	3.40	20.0	3.66	22.2	3.95		
		20	11.3	2.85	13.5	3.01	15.7	3.21	16.8	3.32	17.8	3.44	20.0	3.70	22.2	4.00		
		21	11.3	2.86	13.5	3.02	15.7	3.22	16.8	3.33	17.8	3.46	20.0	3.73	22.2	4.03		
		23	11.3	2.87	13.5	3.04	15.7	3.25	16.8	3.37	17.8	3.49	20.0	3.77	22.2	4.10		
		25	11.3	2.89	13.5	3.06	15.7	3.28	16.8	3.41	17.8	3.57	20.0	3.94	22.2	4.35		
		27	11.3	2.90	13.5	3.14	15.7	3.43	16.8	3.60	17.8	3.77	20.0	4.17	22.2	4.62		
		29	11.3	3.04	13.5	3.30	15.7	3.61	16.8	3.79	17.8	3.98	20.0	4.41	22.2	4.89		
		31																

# 5 Capacity tables

## 5 - 1 Cooling Capacity Tables

### RQYQ14PY1

TC: Total Capacity: kW ; PI: Power Input: kW (compressor + outdoor fan motor)

Combination (%)	Capacity index (kW)	Outdoor air temp. °CDB	Indoor air temperature: °CWB															
			14.0		16.0		18.0		19.0		20.0		22.0		24.0			
			TC	PI	TC	PI	TC	PI	TC	PI	TC	PI	TC	PI	TC	PI		
130	52.00	10	35,1	5,77	41,9	6,78	48,6	7,82	50,4	7,94	51,0	7,78	52,3	7,45	53,5	7,12		
		12	35,1	5,85	41,9	6,88	48,6	7,94	49,7	7,90	50,4	7,74	51,6	7,40	52,9	7,29		
		14	35,1	5,94	41,9	6,99	48,4	8,02	49,1	7,86	49,7	7,69	51,0	7,63	52,2	7,70		
		16	35,1	6,03	41,9	7,10	47,8	7,98	48,4	7,93	49,1	7,96	50,3	8,04	51,6	8,12		
		18	35,1	6,12	41,9	7,22	47,1	8,29	47,8	8,33	48,4	8,37	49,7	8,45	50,9	8,53		
		20	35,1	6,22	41,9	7,66	46,5	8,7	47,1	8,7	47,8	8,8	49,0	8,9	50,3	9,0		
		21	35,1	6,38	41,9	7,92	46,2	8,9	46,8	8,9	47,4	9,0	48,7	9,1	50,0	9,2		
		23	35,1	6,80	41,9	8,46	45,5	9,3	46,1	9,3	46,8	9,4	48,0	9,5	49,3	9,6		
		25	35,1	7,25	41,9	9,0	44,9	9,7	45,5	9,8	46,1	9,8	47,4	9,9	48,7	10,0		
		27	35,1	7,71	41,9	9,6	44,2	10,1	44,8	10,2	45,5	10,2	46,7	10,3	48,0	10,4		
		29	35,1	8,19	41,9	10,2	43,6	10,5	44,2	10,6	44,8	10,6	46,1	10,8	47,4	10,9		
		31	35,1	8,70	41,6	10,8	42,9	10,9	43,5	11,0	44,2	11,1	45,4	11,2	46,7	11,3		
		33	35,1	9,2	41,0	11,2	42,3	11,4	42,9	11,4	43,5	11,5	44,8	11,6	46,1	11,7		
		35	35,1	9,8	40,3	11,6	41,6	11,8	42,2	11,8	42,9	11,9	44,1	12,0	45,4	12,2		
		37	35,1	10,4	39,7	12,0	41,0	12,2	41,6	12,3	42,2	12,3	43,5	12,5	44,8	12,6		
		39	35,1	11,0	39,0	12,5	40,3	12,6	40,9	12,7	41,6	12,8	42,8	12,9	44,1	13,1		
		120	48.00	10	32,4	5,37	38,6	6,29	44,9	7,24	48,0	7,72	50,2	7,98	51,4	7,68	52,6	7,38
				12	32,4	5,45	38,6	6,39	44,9	7,35	48,0	7,84	49,6	7,94	50,7	7,64	51,9	7,33
14	32,4			5,53	38,6	6,48	44,9	7,47	48,0	7,97	48,9	7,90	50,1	7,59	51,2	7,65		
16	32,4			5,61	38,6	6,59	44,9	7,59	47,7	8,01	48,3	7,92	49,4	7,99	50,6	8,06		
18	32,4			5,69	38,6	6,69	44,9	7,83	47,0	8,28	47,6	8,32	48,8	8,40	49,9	8,47		
20	32,4			5,78	38,6	6,93	44,9	8,38	46,4	8,7	47,0	8,7	48,1	8,8	49,3	8,9		
21	32,4			5,83	38,6	7,16	44,9	8,67	46,1	8,9	46,6	8,9	47,8	9,0	49,0	9,1		
23	32,4			6,20	38,6	7,65	44,8	9,2	45,4	9,3	46,0	9,3	47,2	9,4	48,3	9,5		
25	32,4			6,60	38,6	8,15	44,2	9,7	44,8	9,7	45,3	9,7	46,5	9,8	47,7	9,9		
27	32,4			7,01	38,6	8,68	43,5	10,1	44,1	10,1	44,7	10,2	45,9	10,3	47,0	10,4		
29	32,4			7,45	38,6	9,2	42,9	10,5	43,4	10,5	44,0	10,6	45,2	10,7	46,4	10,8		
31	32,4			7,90	38,6	9,8	42,2	10,9	42,8	10,9	43,4	11,0	44,6	11,1	45,7	11,2		
33	32,4			8,38	38,6	10,4	41,6	11,3	42,1	11,3	42,7	11,4	43,9	11,5	45,1	11,6		
35	32,4			8,88	38,6	11,1	40,9	11,7	41,5	11,8	42,1	11,8	43,2	11,9	44,4	12,1		
37	32,4			9,4	38,6	11,8	40,3	12,1	40,8	12,2	41,4	12,2	42,6	12,4	43,8	12,5		
39	32,4			10,0	38,4	12,4	39,6	12,5	40,2	12,6	40,8	12,7	41,9	12,8	43,1	12,9		
110	44.00			10	29,7	4,99	35,4	5,81	41,1	6,67	44,0	7,11	46,9	7,55	50,5	7,91	51,6	7,64
				12	29,7	5,06	35,4	5,90	41,1	6,77	44,0	7,22	46,9	7,67	49,8	7,87	50,9	7,59
		14	29,7	5,13	35,4	5,99	41,1	6,88	44,0	7,33	46,9	7,79	49,2	7,83	50,3	7,59		
		16	29,7	5,20	35,4	6,08	41,1	6,99	44,0	7,45	46,9	7,91	48,5	7,93	49,6	8,00		
		18	29,7	5,28	35,4	6,17	41,1	7,10	44,0	7,63	46,8	8,27	47,9	8,34	49,0	8,41		
		20	29,7	5,36	35,4	6,27	41,1	7,49	44,0	8,17	46,2	8,7	47,2	8,7	48,3	8,8		
		21	29,7	5,40	35,4	6,45	41,1	7,75	44,0	8,45	45,8	8,9	46,9	8,9	48,0	9,0		
		23	29,7	5,62	35,4	6,88	41,1	8,28	44,0	9,0	45,2	9,3	46,3	9,4	47,3	9,4		
		25	29,7	5,98	35,4	7,33	41,1	8,8	44,0	9,6	44,5	9,7	45,6	9,8	46,7	9,9		
		27	29,7	6,35	35,4	7,80	41,1	9,4	43,4	10,0	43,9	10,1	45,0	10,2	46,0	10,3		
		29	29,7	6,74	35,4	8,29	41,1	10,0	42,7	10,5	43,2	10,5	44,3	10,6	45,4	10,7		
		31	29,7	7,14	35,4	8,80	41,1	10,7	42,0	10,9	42,6	10,9	43,7	11,0	44,7	11,1		
		33	29,7	7,57	35,4	9,3	40,9	11,2	41,4	11,3	41,9	11,3	43,0	11,4	44,1	11,5		
		35	29,7	8,01	35,4	9,9	40,2	11,6	40,7	11,7	41,3	11,7	42,4	11,8	43,4	12,0		
		37	29,7	8,48	35,4	10,5	39,6	12,0	40,1	12,1	40,6	12,2	41,7	12,3	42,8	12,4		
		39	29,7	8,97	35,4	11,1	38,9	12,4	39,4	12,5	40,0	12,6	41,1	12,7	42,1	12,8		
		100	40.00	10	27,0	4,61	32,2	5,34	37,4	6,11	40,0	6,50	42,6	6,89	47,8	7,69	50,6	7,89
				12	27,0	4,67	32,2	5,42	37,4	6,20	40,0	6,60	42,6	7,00	47,8	7,81	49,9	7,85
14	27,0			4,74	32,2	5,50	37,4	6,29	40,0	6,70	42,6	7,11	47,8	7,94	49,3	7,81		
16	27,0			4,80	32,2	5,58	37,4	6,39	40,0	6,80	42,6	7,22	47,6	8,02	48,6	7,94		
18	27,0			4,87	32,2	5,66	37,4	6,49	40,0	6,91	42,6	7,34	47,0	8,28	48,0	8,34		
20	27,0			4,94	32,2	5,75	37,4	6,66	40,0	7,24	42,6	7,84	46,3	8,7	47,3	8,8		
21	27,0			4,97	32,2	5,80	37,4	6,88	40,0	7,48	42,6	8,10	46,0	8,9	47,0	9,0		
23	27,0			5,08	32,2	6,15	37,4	7,35	40,0	7,99	42,6	8,66	45,4	9,3	46,3	9,4		
25	27,0			5,40	32,2	6,55	37,4	7,83	40,0	8,52	42,6	9,2	44,7	9,7	45,7	9,8		
27	27,0			5,73	32,2	6,96	37,4	8,34	40,0	9,1	42,6	9,8	44,1	10,1	45,0	10,2		
29	27,0			6,07	32,2	7,39	37,4	8,87	40,0	9,7	42,4	10,4	43,4	10,5	44,4	10,6		
31	27,0			6,43	32,2	7,84	37,4	9,4	40,0	10,3	41,8	10,8	42,8	10,9	43,7	11,0		
33	27,0			6,80	32,2	8,32	37,4	10,0	40,0	10,9	41,1	11,2	42,1	11,3	43,1	11,4		
35	27,0			7,20	32,2	8,82	37,4	10,6	40,0	11,6	40,5	11,7	41,5	11,8	42,4	11,9		
37	27,0			7,61	32,2	9,3	37,4	11,3	39,3	12,0	39,8	12,1	40,8	12,2	41,8	12,3		
39	27,0			8,04	32,2	9,9	37,4	12,0	38,7	12,4	39,2	12,5	40,2	12,6	41,1	12,7		

**NOTES - ANMERKUNGEN - Σημειώσεις - NOTAS - REMARQUES - NOTE - OPMERKINGEN - Примечания - NOTLAR**

- The above table shows the average value of conditions which may occur.  
 Die obige Tabelle zeigt den Durchschnittswert der Bedingungen, die auftreten können.  
 Στον παραπάνω πίνακα αναγράφεται η μέση τιμή για συνθήκες που μπορεί να προκύψουν.  
 La tabla de arriba muestra el valor medio de condiciones que pueden ocurrir.  
 Le tableau ci-dessus donne la valeur moyenne pour des conditions qui peuvent survenir.  
 La tabella in alto mostra il valore delle condizioni medie che si possono riscontrare.  
 De tabel hierboven geeft de gemiddelde waarde aan van situaties die kunnen voorvallen.  
 Таблица расположенная выше показывает среднее значение условий, которые могут наступить.  
 Yukarıdaki tablo meydana gelebilecek kobluların ortalama değerini göstermektedir.



# 5 Capacity tables

## 5 - 1 Cooling Capacity Tables

5

RQYQ14PY1

TC: Total Capacity: kW ; PI: Power Input: kW (compressor + outdoor fan motor)

Combination (%)	Capacity index (kW)	Outdoor air temp. °CDB	Indoor air temperature: °CWB													
			14.0		16.0		18.0		19.0		20.0		22.0		24.0	
			TC	PI	TC	PI	TC	PI	TC	PI	TC	PI	TC	PI	TC	PI
90	36.00	10	24.3	4.25	29.0	4.89	33.7	5.56	36.0	5.90	38.3	6.25	43.0	6.96	47.7	7.68
		12	24.3	4.30	29.0	4.95	33.7	5.64	36.0	5.99	38.3	6.34	43.0	7.07	47.7	7.80
		14	24.3	4.36	29.0	5.02	33.7	5.72	36.0	6.08	38.3	6.44	43.0	7.18	47.7	7.92
		16	24.3	4.41	29.0	5.09	33.7	5.80	36.0	6.17	38.3	6.54	43.0	7.29	47.6	8.03
		18	24.3	4.47	29.0	5.17	33.7	5.89	36.0	6.27	38.3	6.64	43.0	7.41	47.0	8.28
		20	24.3	4.53	29.0	5.24	33.7	5.99	36.0	6.37	38.3	6.87	43.0	7.54	46.3	8.7
		21	24.3	4.56	29.0	5.28	33.7	6.08	36.0	6.58	38.3	7.10	43.0	8.21	46.0	8.9
		23	24.3	4.63	29.0	5.48	33.7	6.48	36.0	7.01	38.3	7.58	43.0	8.8	45.3	9.3
		25	24.3	4.85	29.0	5.82	33.7	6.90	36.0	7.47	38.3	8.08	43.0	9.4	44.7	9.7
		27	24.3	5.14	29.0	6.18	33.7	7.33	36.0	7.95	38.3	8.60	43.0	10.0	44.0	10.1
		29	24.3	5.44	29.0	6.56	33.7	7.79	36.0	8.45	38.3	9.1	42.5	10.4	43.4	10.5
		31	24.3	5.76	29.0	6.95	33.7	8.27	36.0	9.0	38.3	9.7	41.9	10.8	42.7	10.9
		33	24.3	6.09	29.0	7.36	33.7	8.78	36.0	9.5	38.3	10.3	41.2	11.2	42.1	11.3
		35	24.3	6.43	29.0	7.79	33.7	9.3	36.0	10.1	38.3	11.0	40.6	11.7	41.4	11.8
		37	24.3	6.79	29.0	8.24	33.7	9.9	36.0	10.7	38.3	11.6	39.9	12.1	40.8	12.2
		39	24.3	7.16	29.0	8.72	33.7	10.5	36.0	11.4	38.3	12.4	39.3	12.5	40.1	12.6
		80	32.00	10	21.6	3.90	25.8	4.45	29.9	5.02	32.0	5.32	34.1	5.62	38.2	6.23
12	21.6			3.94	25.8	4.50	29.9	5.09	32.0	5.39	34.1	5.70	38.2	6.33	42.4	6.97
14	21.6			3.99	25.8	4.56	29.9	5.16	32.0	5.47	34.1	5.78	38.2	6.42	42.4	7.08
16	21.6			4.04	25.8	4.62	29.9	5.23	32.0	5.55	34.1	5.87	38.2	6.52	42.4	7.19
18	21.6			4.09	25.8	4.69	29.9	5.31	32.0	5.63	34.1	5.96	38.2	6.63	42.4	7.31
20	21.6			4.14	25.8	4.75	29.9	5.39	32.0	5.72	34.1	6.05	38.2	6.84	42.4	7.79
21	21.6			4.17	25.8	4.79	29.9	5.43	32.0	5.76	34.1	6.17	38.2	7.07	42.4	8.06
23	21.6			4.22	25.8	4.86	29.9	5.67	32.0	6.11	34.1	6.57	38.2	7.55	42.4	8.61
25	21.6			4.34	25.8	5.14	29.9	6.03	32.0	6.50	34.1	7.00	38.2	8.05	42.4	9.2
27	21.6			4.59	25.8	5.45	29.9	6.40	32.0	6.91	34.1	7.44	38.2	8.57	42.4	9.8
29	21.6			4.86	25.8	5.78	29.9	6.80	32.0	7.34	34.1	7.91	38.2	9.1	42.4	10.4
31	21.6			5.13	25.8	6.12	29.9	7.20	32.0	7.79	34.1	8.40	38.2	9.7	41.8	10.8
33	21.6			5.42	25.8	6.47	29.9	7.63	32.0	8.26	34.1	8.91	38.2	10.3	41.1	11.2
35	21.6			5.71	25.8	6.84	29.9	8.08	32.0	8.75	34.1	9.4	38.2	10.9	40.4	11.6
37	21.6			6.02	25.8	7.22	29.9	8.56	32.0	9.27	34.1	10.0	38.2	11.6	39.8	12.1
39	21.6			6.35	25.8	7.63	29.9	9.05	32.0	9.82	34.1	10.6	38.2	12.3	39.1	12.5
70	28.00			10	18.9	3.56	22.5	4.02	26.2	4.50	28.0	4.75	29.8	5.01	33.5	5.53
		12	18.9	3.60	22.5	4.07	26.2	4.56	28.0	4.81	29.8	5.07	33.5	5.61	37.1	6.15
		14	18.9	3.64	22.5	4.12	26.2	4.62	28.0	4.88	29.8	5.15	33.5	5.69	37.1	6.25
		16	18.9	3.68	22.5	4.17	26.2	4.68	28.0	4.95	29.8	5.22	33.5	5.77	37.1	6.34
		18	18.9	3.72	22.5	4.22	26.2	4.75	28.0	5.02	29.8	5.30	33.5	5.86	37.1	6.44
		20	18.9	3.77	22.5	4.28	26.2	4.81	28.0	5.09	29.8	5.38	33.5	5.95	37.1	6.60
		21	18.9	3.79	22.5	4.31	26.2	4.85	28.0	5.13	29.8	5.42	33.5	6.04	37.1	6.82
		23	18.9	3.84	22.5	4.36	26.2	4.93	28.0	5.28	29.8	5.65	33.5	6.43	37.1	7.28
		25	18.9	3.88	22.5	4.52	26.2	5.23	28.0	5.61	29.8	6.01	33.5	6.85	37.1	7.75
		27	18.9	4.08	22.5	4.78	26.2	5.55	28.0	5.95	29.8	6.38	33.5	7.28	37.1	8.25
		29	18.9	4.31	22.5	5.06	26.2	5.88	28.0	6.31	29.8	6.77	33.5	7.74	37.1	8.78
		31	18.9	4.55	22.5	5.34	26.2	6.22	28.0	6.69	29.8	7.18	33.5	8.21	37.1	9.3
		33	18.9	4.79	22.5	5.64	26.2	6.58	28.0	7.08	29.8	7.60	33.5	8.71	37.1	9.9
		35	18.9	5.05	22.5	5.96	26.2	6.96	28.0	7.49	29.8	8.05	33.5	9.2	37.1	10.5
		37	18.9	5.31	22.5	6.28	26.2	7.35	28.0	7.93	29.8	8.52	33.5	9.8	37.1	11.2
		39	18.9	5.59	22.5	6.63	26.2	7.77	28.0	8.38	29.8	9.02	33.5	10.4	37.1	11.8
		60	24.00	10	16.2	3.24	19.3	3.61	22.4	4.01	24.0	4.21	25.6	4.42	28.7	4.85
12	16.2			3.27	19.3	3.65	22.4	4.05	24.0	4.26	25.6	4.47	28.7	4.91	31.8	5.36
14	16.2			3.30	19.3	3.69	22.4	4.10	24.0	4.32	25.6	4.53	28.7	4.98	31.8	5.44
16	16.2			3.34	19.3	3.73	22.4	4.15	24.0	4.37	25.6	4.59	28.7	5.05	31.8	5.52
18	16.2			3.37	19.3	3.78	22.4	4.21	24.0	4.43	25.6	4.66	28.7	5.12	31.8	5.60
20	16.2			3.41	19.3	3.82	22.4	4.26	24.0	4.49	25.6	4.72	28.7	5.20	31.8	5.69
21	16.2			3.43	19.3	3.85	22.4	4.29	24.0	4.52	25.6	4.76	28.7	5.24	31.8	5.73
23	16.2			3.46	19.3	3.89	22.4	4.35	24.0	4.58	25.6	4.82	28.7	5.42	31.8	6.07
25	16.2			3.50	19.3	3.95	22.4	4.50	24.0	4.79	25.6	5.10	28.7	5.76	31.8	6.46
27	16.2			3.61	19.3	4.16	22.4	4.76	24.0	5.08	25.6	5.41	28.7	6.11	31.8	6.86
29	16.2			3.81	19.3	4.39	22.4	5.04	24.0	5.38	25.6	5.73	28.7	6.48	31.8	7.29
31	16.2			4.01	19.3	4.64	22.4	5.32	24.0	5.69	25.6	6.07	28.7	6.87	31.8	7.73
33	16.2			4.22	19.3	4.89	22.4	5.62	24.0	6.01	25.6	6.42	28.7	7.28	31.8	8.20
35	16.2			4.43	19.3	5.15	22.4	5.93	24.0	6.35	25.6	6.78	28.7	7.70	31.8	8.69
37	16.2			4.66	19.3	5.42	22.4	6.26	24.0	6.70	25.6	7.16	28.7	8.15	31.8	9.2
39	16.2			4.89	19.3	5.70	22.4	6.60	24.0	7.07	25.6	7.57	28.7	8.62	31.8	9.7
50	20.00			10	13.5	2.94	16.1	3.23	18.7	3.54	20.0	3.70	21.3	3.86	23.9	4.20
		12	13.5	2.96	16.1	3.26	18.7	3.58	20.0	3.74	21.3	3.91	23.9	4.25	26.5	4.60
		14	13.5	2.99	16.1	3.29	18.7	3.61	20.0	3.78	21.3	3.95	23.9	4.30	26.5	4.67
		16	13.5	3.01	16.1	3.32	18.7	3.65	20.0	3.82	21.3	4.00	23.9	4.36	26.5	4.73
		18	13.5	3.04	16.1	3.36	18.7	3.70	20.0	3.87	21.3	4.05	23.9	4.42	26.5	4.80
		20	13.5	3.07	16.1	3.39	18.7	3.74	20.0	3.92	21.3	4.10	23.9	4.48	26.5	4.86
		21	13.5	3.08	16.1	3.41	18.7	3.76	20.0	3.94	21.3	4.13	23.9	4.51	26.5	4.90
		23	13.5	3.11	16.1	3.45	18.7	3.81	20.0	3.99	21.3	4.18	23.9	4.57	26.5	4.99
		25	13.5	3.14	16.1	3.49	18.7	3.86	20.0	4.05	21.3	4.29	23.9	4.78	26.5	5.30
		27	13.5	3.18	16.1	3.59	18.7	4.05	20.0	4.29	21.3	4.54	23.9	5.06	26.5	5.62
		29	13.5	3.34	16.1	3.79	18.7	4.27	20.0	4.53	21.3	4.80	23.9	5.36	26.5	5.95
		31	13.5	3.51	16.1	3.99	18.7									

# 5 Capacity tables

## 5 - 1 Cooling Capacity Tables

### RQYQ16PY1

TC: Total Capacity: kW ; PI: Power Input: kW (compressor + outdoor fan motor)

Combination (%)	Capacity index (kW)	Outdoor air temp. °CDB	Indoor air temperature: °CWB															
			14.0		16.0		18.0		19.0		20.0		22.0		24.0			
			TC	PI	TC	PI	TC	PI	TC	PI	TC	PI	TC	PI	TC	PI		
130	58.50	10	39.5	6.76	47.1	7.95	54.7	9.2	56.7	9.3	57.4	9.1	58.8	8.7	60.2	8.34		
		12	39.5	6.86	47.1	8.07	54.7	9.3	55.9	9.3	56.7	9.1	58.1	8.7	59.5	8.5		
		14	39.5	6.96	47.1	8.20	54.5	9.4	55.2	9.2	55.9	9.0	57.3	8.9	58.8	9.0		
		16	39.5	7.07	47.1	8.33	53.8	9.4	54.5	9.3	55.2	9.3	56.6	9.4	58.0	9.5		
		18	39.5	7.18	47.1	8.46	53.0	9.7	53.7	9.8	54.5	9.8	55.9	9.9	57.3	10.0		
		20	39.5	7.29	47.1	9.0	52.3	10.2	53.0	10.2	53.7	10.3	55.2	10.4	56.6	10.5		
		21	39.5	7.48	47.1	9.3	51.9	10.4	52.7	10.5	53.4	10.5	54.8	10.6	56.2	10.7		
		23	39.5	7.98	47.1	9.9	51.2	10.9	51.9	11.0	52.6	11.0	54.1	11.1	55.5	11.2		
		25	39.5	8.50	47.1	10.6	50.5	11.4	51.2	11.4	51.9	11.5	53.3	11.6	54.7	11.7		
		27	39.5	9.0	47.1	11.3	49.7	11.9	50.5	11.9	51.2	12.0	52.6	12.1	54.0	12.2		
		29	39.5	9.6	47.1	12.0	49.0	12.3	49.7	12.4	50.4	12.5	51.9	12.6	53.3	12.7		
		31	39.5	10.2	46.9	12.7	48.3	12.8	49.0	12.9	49.7	13.0	51.1	13.1	52.5	13.2		
		33	39.5	10.8	46.1	13.2	47.5	13.3	48.3	13.4	49.0	13.5	50.4	13.6	51.8	13.8		
		35	39.5	11.5	45.4	13.6	46.8	13.8	47.5	13.9	48.2	14.0	49.7	14.1	51.1	14.3		
		37	39.5	12.2	44.7	14.1	46.1	14.3	46.8	14.4	47.5	14.5	48.9	14.6	50.4	14.8		
		39	39.5	12.9	43.9	14.6	45.4	14.8	46.1	14.9	46.8	15.0	48.2	15.1	49.6	15.3		
		120	54.00	10	36.4	6.30	43.5	7.38	50.5	8.49	54.0	9.1	56.5	9.4	57.8	9.0	59.1	8.7
				12	36.4	6.39	43.5	7.49	50.5	8.62	54.0	9.2	55.8	9.3	57.1	9.0	58.4	8.6
14	36.4			6.48	43.5	7.60	50.5	8.8	54.0	9.3	55.0	9.3	56.3	8.9	57.7	9.0		
16	36.4			6.58	43.5	7.72	50.5	8.9	53.6	9.4	54.3	9.3	55.6	9.4	56.9	9.4		
18	36.4			6.68	43.5	7.85	50.5	9.2	52.9	9.7	53.6	9.8	54.9	9.8	56.2	9.9		
20	36.4			6.78	43.5	8.13	50.5	9.8	52.2	10.2	52.8	10.2	54.1	10.3	55.5	10.4		
21	36.4			6.83	43.5	8.40	50.5	10.2	51.8	10.4	52.5	10.5	53.8	10.6	55.1	10.7		
23	36.4			7.27	43.5	9.0	50.4	10.8	51.1	10.9	51.7	10.9	53.0	11.1	54.4	11.2		
25	36.4			7.73	43.5	9.6	49.7	11.3	50.3	11.4	51.0	11.4	52.3	11.5	53.6	11.6		
27	36.4			8.22	43.5	10.2	49.0	11.8	49.6	11.9	50.3	11.9	51.6	12.0	52.9	12.1		
29	36.4			8.73	43.5	10.8	48.2	12.3	48.9	12.3	49.5	12.4	50.9	12.5	52.2	12.6		
31	36.4			9.3	43.5	11.5	47.5	12.7	48.1	12.8	48.8	12.9	50.1	13.0	51.4	13.1		
33	36.4			9.8	43.5	12.2	46.8	13.2	47.4	13.3	48.1	13.4	49.4	13.5	50.7	13.6		
35	36.4			10.4	43.5	13.0	46.0	13.7	46.7	13.8	47.3	13.9	48.7	14.0	50.0	14.1		
37	36.4			11.0	43.5	13.8	45.3	14.2	46.0	14.3	46.6	14.4	47.9	14.5	49.2	14.7		
39	36.4			11.7	43.2	14.5	44.6	14.7	45.2	14.8	45.9	14.8	47.2	15.0	48.5	15.2		
110	49.50			10	33.4	5.85	39.8	6.82	46.3	7.82	49.5	8.33	52.7	8.8	56.8	9.3	58.0	9.0
				12	33.4	5.93	39.8	6.91	46.3	7.94	49.5	8.46	52.7	9.0	56.1	9.2	57.3	8.9
		14	33.4	6.01	39.8	7.02	46.3	8.06	49.5	8.60	52.7	9.1	55.3	9.2	56.5	8.9		
		16	33.4	6.10	39.8	7.13	46.3	8.19	49.5	8.7	52.7	9.3	54.6	9.3	55.8	9.4		
		18	33.4	6.19	39.8	7.24	46.3	8.32	49.5	8.9	52.7	9.7	53.9	9.8	55.1	9.9		
		20	33.4	6.28	39.8	7.35	46.3	8.8	49.5	9.6	51.9	10.2	53.1	10.3	54.3	10.3		
		21	33.4	6.33	39.8	7.56	46.3	9.1	49.5	9.9	51.6	10.4	52.8	10.5	54.0	10.6		
		23	33.4	6.59	39.8	8.06	46.3	9.7	49.5	10.6	50.8	10.9	52.0	11.0	53.2	11.1		
		25	33.4	7.01	39.8	8.59	46.3	10.4	49.5	11.3	50.1	11.4	51.3	11.5	52.5	11.6		
		27	33.4	7.45	39.8	9.1	46.3	11.0	48.8	11.8	49.4	11.8	50.6	11.9	51.8	12.0		
		29	33.4	7.90	39.8	9.7	46.3	11.7	48.0	12.3	48.6	12.3	49.8	12.4	51.0	12.5		
		31	33.4	8.37	39.8	10.3	46.3	12.5	47.3	12.7	47.9	12.8	49.1	12.9	50.3	13.0		
		33	33.4	8.87	39.8	11.0	46.0	13.1	46.6	13.2	47.2	13.3	48.4	13.4	49.6	13.5		
		35	33.4	9.4	39.8	11.6	45.2	13.6	45.8	13.7	46.4	13.8	47.6	13.9	48.9	14.0		
		37	33.4	9.9	39.8	12.3	44.5	14.1	45.1	14.2	45.7	14.2	46.9	14.4	48.1	14.5		
		39	33.4	10.5	39.8	13.1	43.8	14.6	44.4	14.7	45.0	14.7	46.2	14.9	47.4	15.0		
		100	45.00	10	30.4	5.41	36.2	6.27	42.1	7.16	45.0	7.62	47.9	8.08	53.8	9.0	56.9	9.3
				12	30.4	5.48	36.2	6.35	42.1	7.27	45.0	7.73	47.9	8.21	53.8	9.2	56.2	9.2
14	30.4			5.55	36.2	6.45	42.1	7.38	45.0	7.85	47.9	8.33	53.8	9.3	55.4	9.2		
16	30.4			5.63	36.2	6.54	42.1	7.49	45.0	7.98	47.9	8.47	53.6	9.4	54.7	9.3		
18	30.4			5.71	36.2	6.64	42.1	7.61	45.0	8.11	47.9	8.61	52.9	9.7	54.0	9.8		
20	30.4			5.79	36.2	6.74	42.1	7.81	45.0	8.48	47.9	9.2	52.1	10.2	53.2	10.3		
21	30.4			5.83	36.2	6.80	42.1	8.07	45.0	8.8	47.9	9.5	51.8	10.4	52.9	10.5		
23	30.4			5.96	36.2	7.22	42.1	8.61	45.0	9.4	47.9	10.2	51.0	10.9	52.1	11.0		
25	30.4			6.33	36.2	7.68	42.1	9.2	45.0	10.0	47.9	10.8	50.3	11.4	51.4	11.5		
27	30.4			6.71	36.2	8.16	42.1	9.8	45.0	10.6	47.9	11.5	49.6	11.8	50.7	11.9		
29	30.4			7.12	36.2	8.67	42.1	10.4	45.0	11.3	47.7	12.2	48.8	12.3	49.9	12.4		
31	30.4			7.54	36.2	9.2	42.1	11.0	45.0	12.0	47.0	12.7	48.1	12.8	49.2	12.9		
33	30.4			7.98	36.2	9.8	42.1	11.7	45.0	12.8	46.3	13.2	47.4	13.3	48.5	13.4		
35	30.4			8.44	36.2	10.3	42.1	12.5	45.0	13.6	45.5	13.7	46.6	13.8	47.7	13.9		
37	30.4			8.92	36.2	10.9	42.1	13.2	44.3	14.1	44.8	14.1	45.9	14.3	47.0	14.4		
39	30.4			9.4	36.2	11.6	42.1	14.0	43.5	14.6	44.1	14.6	45.2	14.8	46.3	14.9		

### NOTES - ANMERKUNGEN - Σημειώσεις - NOTAS - REMARQUES - NOTE - OPMERKINGEN - Примечания - NOTLAR

- The above table shows the average value of conditions which may occur.  
 Die obige Tabelle zeigt den Durchschnittswert der Bedingungen, die auftreten können.  
 Στον παραπάνω πίνακα αναγράφεται η μέση τιμή για συνθήκες που μπορεί να προκύψουν.  
 La tabla de arriba muestra el valor medio de condiciones que pueden ocurrir.  
 Le tableau ci-dessus donne la valeur moyenne pour des conditions qui peuvent survenir.  
 La tabella in alto mostra il valore delle condizioni medie che si possono riscontrare.  
 De tabel hierboven geeft de gemiddelde waarde aan van situaties die kunnen voorvallen.  
 Таблица расположенная выше показывает среднее значение условий, которые могут наступить.  
 Yukarıdaki tablo meydana gelebilecek kopyaların ortalama değerini göstermektedir.

# 5 Capacity tables

## 5 - 1 Cooling Capacity Tables

5

RQYQ16PY1

TC: Total Capacity: kW ; PI: Power Input: kW (compressor + outdoor fan motor)

Combination (%)	Capacity index (kW)	Outdoor air temp. °CDB	Indoor air temperature: °CWB															
			14.0		16.0		18.0		19.0		20.0		22.0		24.0			
			TC	PI	TC	PI	TC	PI	TC	PI	TC	PI	TC	PI	TC	PI		
90	40.50	10	27.3	4.98	32.6	5.73	37.9	6.51	40.5	6.92	43.1	7.33	48.4	8.16	53.7	9.0		
		12	27.3	5.04	32.6	5.81	37.9	6.61	40.5	7.02	43.1	7.44	48.4	8.28	53.7	9.1		
		14	27.3	5.11	32.6	5.89	37.9	6.70	40.5	7.12	43.1	7.55	48.4	8.41	53.7	9.3		
		16	27.3	5.17	32.6	5.97	37.9	6.80	40.5	7.23	43.1	7.67	48.4	8.55	53.6	9.4		
		18	27.3	5.24	32.6	6.06	37.9	6.91	40.5	7.35	43.1	7.79	48.4	8.7	52.8	9.7		
		20	27.3	5.31	32.6	6.15	37.9	7.02	40.5	7.46	43.1	8.05	48.4	9.3	52.1	10.2		
		21	27.3	5.35	32.6	6.19	37.9	7.13	40.5	7.71	43.1	8.32	48.4	9.6	51.7	10.4		
		23	27.3	5.43	32.6	6.42	37.9	7.59	40.5	8.22	43.1	8.9	48.4	10.3	51.0	10.9		
		25	27.3	5.69	32.6	6.83	37.9	8.08	40.5	8.76	43.1	9.5	48.4	11.0	50.3	11.4		
		27	27.3	6.03	32.6	7.25	37.9	8.60	40.5	9.3	43.1	10.1	48.4	11.7	49.5	11.8		
		29	27.3	6.38	32.6	7.69	37.9	9.1	40.5	9.9	43.1	10.7	47.8	12.2	48.8	12.3		
		31	27.3	6.75	32.6	8.15	37.9	9.7	40.5	10.5	43.1	11.4	47.1	12.7	48.1	12.8		
		33	27.3	7.13	32.6	8.63	37.9	10.3	40.5	11.2	43.1	12.1	46.4	13.2	47.4	13.3		
		35	27.3	7.54	32.6	9.1	37.9	10.9	40.5	11.9	43.1	12.9	45.6	13.7	46.6	13.8		
		37	27.3	7.96	32.6	9.7	37.9	11.6	40.5	12.6	43.1	13.7	44.9	14.2	45.9	14.3		
		39	27.3	8.40	32.6	10.2	37.9	12.3	40.5	13.3	43.1	14.5	44.2	14.6	45.2	14.8		
		80	36.00	10	24.3	4.57	29.0	5.21	33.7	5.88	36.0	6.23	38.3	6.59	43.0	7.31	47.7	8.05
				12	24.3	4.62	29.0	5.28	33.7	5.97	36.0	6.32	38.3	6.68	43.0	7.42	47.7	8.17
14	24.3			4.68	29.0	5.35	33.7	6.05	36.0	6.41	38.3	6.78	43.0	7.53	47.7	8.30		
16	24.3			4.74	29.0	5.42	33.7	6.14	36.0	6.51	38.3	6.88	43.0	7.65	47.7	8.43		
18	24.3			4.79	29.0	5.49	33.7	6.23	36.0	6.60	38.3	6.99	43.0	7.77	47.7	8.57		
20	24.3			4.86	29.0	5.57	33.7	6.32	36.0	6.71	38.3	7.10	43.0	8.02	47.7	9.1		
21	24.3			4.89	29.0	5.61	33.7	6.37	36.0	6.76	38.3	7.23	43.0	8.29	47.7	9.4		
23	24.3			4.95	29.0	5.69	33.7	6.65	36.0	7.17	38.3	7.71	43.0	8.9	47.7	10.1		
25	24.3			5.09	29.0	6.03	33.7	7.07	36.0	7.62	38.3	8.20	43.0	9.4	47.7	10.8		
27	24.3			5.39	29.0	6.39	33.7	7.51	36.0	8.10	38.3	8.73	43.0	10.0	47.7	11.5		
29	24.3			5.69	29.0	6.77	33.7	7.97	36.0	8.61	38.3	9.3	43.0	10.7	47.7	12.2		
31	24.3			6.01	29.0	7.17	33.7	8.45	36.0	9.1	38.3	9.8	43.0	11.4	47.0	12.7		
33	24.3			6.35	29.0	7.58	33.7	8.95	36.0	9.7	38.3	10.4	43.0	12.1	46.2	13.2		
35	24.3			6.70	29.0	8.02	33.7	9.5	36.0	10.3	38.3	11.1	43.0	12.8	45.5	13.7		
37	24.3			7.06	29.0	8.47	33.7	10.0	36.0	10.9	38.3	11.7	43.0	13.6	44.8	14.1		
39	24.3			7.44	29.0	8.95	33.7	10.6	36.0	11.5	38.3	12.4	43.0	14.4	44.0	14.6		
70	31.50			10	21.3	4.18	25.4	4.71	29.5	5.28	31.5	5.57	33.5	5.87	37.6	6.48	41.7	7.11
				12	21.3	4.22	25.4	4.77	29.5	5.35	31.5	5.64	33.5	5.95	37.6	6.57	41.7	7.21
		14	21.3	4.27	25.4	4.83	29.5	5.42	31.5	5.72	33.5	6.03	37.6	6.67	41.7	7.32		
		16	21.3	4.31	25.4	4.89	29.5	5.49	31.5	5.80	33.5	6.12	37.6	6.77	41.7	7.44		
		18	21.3	4.36	25.4	4.95	29.5	5.57	31.5	5.88	33.5	6.21	37.6	6.87	41.7	7.55		
		20	21.3	4.42	25.4	5.01	29.5	5.64	31.5	5.97	33.5	6.30	37.6	6.98	41.7	7.74		
		21	21.3	4.44	25.4	5.05	29.5	5.69	31.5	6.01	33.5	6.35	37.6	7.08	41.7	7.99		
		23	21.3	4.50	25.4	5.12	29.5	5.78	31.5	6.19	33.5	6.62	37.6	7.54	41.7	8.53		
		25	21.3	4.55	25.4	5.29	29.5	6.13	31.5	6.58	33.5	7.04	37.6	8.03	41.7	9.1		
		27	21.3	4.79	25.4	5.61	29.5	6.50	31.5	6.98	33.5	7.48	37.6	8.54	41.7	9.7		
		29	21.3	5.05	25.4	5.93	29.5	6.89	31.5	7.40	33.5	7.94	37.6	9.1	41.7	10.3		
		31	21.3	5.33	25.4	6.27	29.5	7.29	31.5	7.84	33.5	8.41	37.6	9.6	41.7	10.9		
		33	21.3	5.62	25.4	6.62	29.5	7.72	31.5	8.30	33.5	8.92	37.6	10.2	41.7	11.6		
		35	21.3	5.92	25.4	6.98	29.5	8.16	31.5	8.79	33.5	9.4	37.6	10.8	41.7	12.3		
		37	21.3	6.23	25.4	7.37	29.5	8.62	31.5	9.3	33.5	10.0	37.6	11.5	41.7	13.1		
		39	21.3	6.55	25.4	7.77	29.5	9.11	31.5	9.8	33.5	10.6	37.6	12.2	41.7	13.9		
		60	27.00	10	18.2	3.80	21.7	4.24	25.2	4.70	27.0	4.94	28.8	5.18	32.3	5.68	35.8	6.20
				12	18.2	3.84	21.7	4.28	25.2	4.75	27.0	5.00	28.8	5.25	32.3	5.76	35.8	6.29
14	18.2			3.87	21.7	4.33	25.2	4.81	27.0	5.06	28.8	5.31	32.3	5.84	35.8	6.38		
16	18.2			3.91	21.7	4.38	25.2	4.87	27.0	5.13	28.8	5.39	32.3	5.92	35.8	6.47		
18	18.2			3.95	21.7	4.43	25.2	4.93	27.0	5.19	28.8	5.46	32.3	6.00	35.8	6.57		
20	18.2			3.99	21.7	4.48	25.2	5.00	27.0	5.26	28.8	5.54	32.3	6.09	35.8	6.67		
21	18.2			4.02	21.7	4.51	25.2	5.03	27.0	5.30	28.8	5.58	32.3	6.14	35.8	6.72		
23	18.2			4.06	21.7	4.57	25.2	5.10	27.0	5.38	28.8	5.66	32.3	6.35	35.8	7.12		
25	18.2			4.11	21.7	4.63	25.2	5.27	27.0	5.62	28.8	5.98	32.3	6.75	35.8	7.57		
27	18.2			4.23	21.7	4.88	25.2	5.58	27.0	5.96	28.8	6.34	32.3	7.17	35.8	8.05		
29	18.2			4.46	21.7	5.15	25.2	5.90	27.0	6.30	28.8	6.72	32.3	7.60	35.8	8.54		
31	18.2			4.70	21.7	5.43	25.2	6.24	27.0	6.67	28.8	7.11	32.3	8.05	35.8	9.1		
33	18.2			4.94	21.7	5.73	25.2	6.59	27.0	7.05	28.8	7.52	32.3	8.53	35.8	9.6		
35	18.2			5.20	21.7	6.04	25.2	6.95	27.0	7.44	28.8	7.95	32.3	9.03	35.8	10.2		
37	18.2			5.46	21.7	6.35	25.2	7.33	27.0	7.86	28.8	8.40	32.3	9.6	35.8	10.8		
39	18.2			5.73	21.7	6.69	25.2	7.73	27.0	8.29	28.8	8.87	32.3	10.1	35.8	11.4		
50	22.50			10	15.2	3.44	18.1	3.79	21.0	4.15	22.5	4.34	24.0	4.53	26.9	4.92	29.8	5.33
				12	15.2	3.47	18.1	3.82	21.0	4.19	22.5	4.38	24.0	4.58	26.9	4.98	29.8	5.40
		14	15.2	3.50	18.1	3.86	21.0	4.24	22.5	4.43	24.0	4.63	26.9	5.04	29.8	5.47		
		16	15.2	3.53	18.1	3.90	21.0	4.28	22.5	4.48	24.0	4.69	26.9	5.11	29.8	5.54		
		18	15.2	3.56	18.1	3.94	21.0	4.33	22.5	4.54	24.0	4.75	26.9	5.18	29.8	5.62		
		20	15.2	3.60	18.1	3.98	21.0	4.38	22.5	4.59	24.0	4.81	26.9	5.25	29.8	5.70		
		21	15.2	3.61	18.1	4.00	21.0	4.41	22.5	4.62	24.0	4.84	26.9	5.28	29.8	5.74		
		23	15.2	3.65	18.1	4.05	21.0	4.46	22.5	4.68	24.0	4.90	26.9	5.36	29.8	5.85		
		25	15.2	3.68	18.1	4.09	21.0	4.52	22.5	4.75	24.0	5.03	26.9	5.60	29.8	6.21		
		27	15.2	3.72	18.1	4.21	21.0	4.75	22.5	5.03	24.0	5.32	26.9	5.93	29.8	6.59		
		29	15.2	3.92	18.1	4.44	21.0	5.01	22.5	5.31	24.0	5.62	26.9	6.28	29.8	6.98		
		31	15.2	4.12	18.1	4.68	21.0											



# 5 Capacity tables

## 5 - 1 Cooling Capacity Tables

### RQYQ18PY1

TC: Total Capacity: kW ; PI: Power Input: kW (compressor + outdoor fan motor)

Combination (%)	Capacity index (kW)	Outdoor air temp. °CDB	Indoor air temperature: °CWB															
			14.0		16.0		18.0		19.0		20.0		22.0		24.0			
			TC	PI	TC	PI	TC	PI	TC	PI	TC	PI	TC	PI	TC	PI		
130	65.52	10	44.2	6.41	52.7	7.54	61.3	8.7	63.5	8.8	64.3	8.7	65.9	8.29	67.5	7.91		
		12	44.2	6.51	52.7	7.66	61.3	8.8	62.7	8.8	63.5	8.6	65.0	8.23	66.6	8.10		
		14	44.2	6.60	52.7	7.77	61.0	8.9	61.8	8.7	62.6	8.6	64.2	8.5	65.8	8.6		
		16	44.2	6.70	52.7	7.90	60.2	8.9	61.0	8.8	61.8	8.9	63.4	8.9	65.0	9.0		
		18	44.2	6.81	52.7	8.03	59.4	9.2	60.2	9.3	61.0	9.3	62.6	9.4	64.2	9.5		
		20	44.2	6.92	52.7	8.52	58.6	9.7	59.4	9.7	60.2	9.8	61.8	9.9	63.4	10.0		
		21	44.2	7.10	52.7	8.8	58.2	9.9	59.0	9.9	59.8	10.0	61.4	10.1	63.0	10.2		
		23	44.2	7.57	52.7	9.4	57.4	10.3	58.1	10.4	58.9	10.5	60.5	10.6	62.1	10.7		
		25	44.2	8.06	52.7	10.0	56.5	10.8	57.3	10.9	58.1	10.9	59.7	11.0	60.8	11.1		
		27	44.2	8.57	52.7	10.7	55.7	11.3	56.5	11.3	57.3	11.4	58.9	11.5	59.3	11.5		
		29	44.2	9.1	52.7	11.4	54.9	11.7	55.7	11.8	56.5	11.8	57.6	11.9	57.7	11.9		
		31	44.2	9.7	52.5	12.0	54.1	12.2	54.9	12.2	55.7	12.3	56.0	12.3	56.2	12.3		
		33	44.2	10.3	51.7	12.5	53.3	12.6	54.0	12.7	54.3	12.7	54.5	12.7	54.6	12.7		
		35	44.2	10.9	50.8	12.9	52.4	13.1	52.7	13.1	52.8	13.1	52.9	13.1	53.1	13.2		
		37	44.2	11.6	50.0	13.4	51.1	13.5	51.2	13.5	51.2	13.5	51.4	13.5	51.6	13.5		
		39	44.2	12.3	49.2	13.9	49.5	13.9	49.6	13.9	49.7	13.9	49.8	13.9	50.0	13.9		
		120	60.48	10	40.8	5.97	48.7	7.00	56.5	8.05	60.5	8.6	63.3	8.9	64.7	8.5	66.2	8.21
				12	40.8	6.06	48.7	7.10	56.5	8.18	60.5	8.7	62.5	8.8	63.9	8.5	65.4	8.15
14	40.8			6.15	48.7	7.21	56.5	8.31	60.5	8.9	61.6	8.8	63.1	8.4	64.6	8.5		
16	40.8			6.24	48.7	7.32	56.5	8.44	60.1	8.9	60.8	8.8	62.3	8.9	63.8	9.0		
18	40.8			6.33	48.7	7.44	56.5	8.7	59.3	9.2	60.0	9.3	61.5	9.3	62.9	9.4		
20	40.8			6.43	48.7	7.71	56.5	9.3	58.4	9.7	59.2	9.7	60.6	9.8	62.1	9.9		
21	40.8			6.48	48.7	7.97	56.5	9.6	58.0	9.9	58.8	9.9	60.2	10.0	61.7	10.1		
23	40.8			6.89	48.7	8.50	56.5	10.3	57.2	10.3	57.9	10.4	59.4	10.5	60.9	10.6		
25	40.8			7.33	48.7	9.1	55.6	10.7	56.4	10.8	57.1	10.8	58.6	10.9	60.1	11.0		
27	40.8			7.80	48.7	9.7	54.8	11.2	55.6	11.2	56.3	11.3	57.8	11.4	59.2	11.5		
29	40.8			8.28	48.7	10.3	54.0	11.6	54.7	11.7	55.5	11.8	57.0	11.9	57.7	11.9		
31	40.8			8.79	48.7	10.9	53.2	12.1	53.9	12.2	54.7	12.2	56.0	12.3	56.2	12.3		
33	40.8			9.3	48.7	11.6	52.4	12.5	53.1	12.6	53.8	12.7	54.5	12.7	54.6	12.7		
35	40.8			9.9	48.7	12.3	51.6	13.0	52.3	13.1	52.8	13.1	52.9	13.1	53.1	13.2		
37	40.8			10.5	48.7	13.1	50.7	13.5	51.2	13.5	51.2	13.5	51.4	13.5	51.6	13.5		
39	40.8			11.1	48.4	13.8	49.5	13.9	49.6	13.9	49.7	13.9	49.8	13.9	50.0	13.9		
110	55.44			10	37.4	5.55	44.6	6.46	51.8	7.42	55.4	7.90	59.0	8.39	63.6	8.8	65.0	8.5
				12	37.4	5.62	44.6	6.56	51.8	7.53	55.4	8.03	59.0	8.5	62.8	8.8	64.1	8.4
		14	37.4	5.70	44.6	6.66	51.8	7.65	55.4	8.15	59.0	8.7	62.0	8.7	63.3	8.4		
		16	37.4	5.78	44.6	6.76	51.8	7.77	55.4	8.28	59.0	8.8	61.2	8.8	62.5	8.9		
		18	37.4	5.87	44.6	6.86	51.8	7.90	55.4	8.48	59.0	9.2	60.3	9.3	61.7	9.3		
		20	37.4	5.96	44.6	6.97	51.8	8.33	55.4	9.1	58.2	9.6	59.5	9.7	60.9	9.8		
		21	37.4	6.00	44.6	7.17	51.8	8.6	55.4	9.4	57.8	9.9	59.1	10.0	60.5	10.0		
		23	37.4	6.25	44.6	7.65	51.8	9.2	55.4	10.0	56.9	10.3	58.3	10.4	59.6	10.5		
		25	37.4	6.65	44.6	8.15	51.8	9.8	55.4	10.7	56.1	10.8	57.5	10.9	58.8	11.0		
		27	37.4	7.06	44.6	8.67	51.8	10.5	54.6	11.2	55.3	11.2	56.6	11.3	58.0	11.4		
		29	37.4	7.49	44.6	9.2	51.8	11.1	53.8	11.6	54.5	11.7	55.8	11.8	57.2	11.9		
		31	37.4	7.94	44.6	9.8	51.8	11.9	53.0	12.1	53.7	12.1	55.0	12.2	56.2	12.3		
		33	37.4	8.42	44.6	10.4	51.5	12.5	52.2	12.5	52.8	12.6	54.2	12.7	54.6	12.7		
		35	37.4	8.91	44.6	11.0	50.7	12.9	51.3	13.0	52.0	13.1	52.9	13.1	53.1	13.2		
		37	37.4	9.4	44.6	11.7	49.8	13.4	50.5	13.4	51.2	13.5	51.4	13.5	51.6	13.5		
		39	37.4	10.0	44.6	12.4	49.0	13.8	49.6	13.9	49.7	13.9	49.8	13.9	50.0	13.9		
		100	50.40	10	34.0	5.13	40.6	5.94	47.1	6.79	50.4	7.23	53.7	7.67	60.2	8.6	63.7	8.8
				12	34.0	5.20	40.6	6.03	47.1	6.89	50.4	7.34	53.7	7.78	60.2	8.7	62.9	8.7
14	34.0			5.27	40.6	6.11	47.1	7.00	50.4	7.45	53.7	7.91	60.2	8.8	62.1	8.7		
16	34.0			5.34	40.6	6.20	47.1	7.11	50.4	7.57	53.7	8.03	60.0	8.9	61.3	8.8		
18	34.0			5.41	40.6	6.30	47.1	7.22	50.4	7.69	53.7	8.16	59.2	9.2	60.4	9.3		
20	34.0			5.49	40.6	6.40	47.1	7.41	50.4	8.05	53.7	8.7	58.4	9.7	59.6	9.7		
21	34.0			5.53	40.6	6.45	47.1	7.66	50.4	8.32	53.7	9.0	58.0	9.9	59.2	10.0		
23	34.0			5.65	40.6	6.84	47.1	8.17	50.4	8.9	53.7	9.6	57.2	10.3	58.4	10.4		
25	34.0			6.00	40.6	7.28	47.1	8.71	50.4	9.5	53.7	10.3	56.3	10.8	57.6	10.9		
27	34.0			6.37	40.6	7.74	47.1	9.3	50.4	10.1	53.7	11.0	55.5	11.2	56.7	11.3		
29	34.0			6.75	40.6	8.22	47.1	9.9	50.4	10.7	53.5	11.6	54.7	11.7	55.9	11.8		
31	34.0			7.15	40.6	8.72	47.1	10.5	50.4	11.4	52.7	12.0	53.9	12.2	55.1	12.3		
33	34.0			7.57	40.6	9.3	47.1	11.1	50.4	12.1	51.8	12.5	53.1	12.6	54.3	12.7		
35	34.0			8.00	40.6	9.8	47.1	11.8	50.4	12.9	51.0	13.0	52.2	13.1	53.1	13.2		
37	34.0			8.46	40.6	10.4	47.1	12.5	49.6	13.4	50.2	13.4	51.4	13.5	51.6	13.5		
39	34.0			8.94	40.6	11.0	47.1	13.3	48.8	13.8	49.4	13.9	49.8	13.9	50.0	13.9		

**NOTES - ANMERKUNGEN - Σημειώσεις - NOTAS - REMARQUES - NOTE - OPMERKINGEN - Примечания - NOTLAR**

- The above table shows the average value of conditions which may occur.  
 Die obige Tabelle zeigt den Durchschnittswert der Bedingungen, die auftreten können.  
 Στον παραπάνω πίνακα αναγράφεται η μέση τιμή για συνθήκες που μπορεί να προκύψουν.  
 La tabla de arriba muestra el valor medio de condiciones que pueden ocurrir.  
 Le tableau ci-dessus donne la valeur moyenne pour des conditions qui peuvent survenir.  
 La tabella in alto mostra il valore delle condizioni medie che si possono riscontrare.  
 De tabel hierboven geeft de gemiddelde waarde aan van situaties die kunnen voorvallen.  
 Таблица расположенная выше показывает среднее значение условий, которые могут наступить.  
 Yukarıdaki tablo meydana gelebilecek koşulların ortalama değerini göstermektedir.

# 5 Capacity tables

## 5 - 1 Cooling Capacity Tables

5

**RQYQ18PY1**

TC: Total Capacity: kW ; PI: Power Input: kW (compressor + outdoor fan motor)

Combination (%)	Capacity index (kW)	Outdoor air temp. °CDB	Indoor air temperature: °CWB															
			14.0		16.0		18.0		19.0		20.0		22.0		24.0			
			TC	PI	TC	PI	TC	PI	TC	PI	TC	PI	TC	PI	TC	PI		
90	44.36	10	30.6	4.73	36.5	5.43	42.4	6.18	45.4	6.56	48.3	6.95	54.2	7.74	60.1	8.5		
		12	30.6	4.78	36.5	5.51	42.4	6.27	45.4	6.66	48.3	7.05	54.2	7.86	60.1	8.7		
		14	30.6	4.85	36.5	5.58	42.4	6.36	45.4	6.76	48.3	7.16	54.2	7.98	60.1	8.8		
		16	30.6	4.91	36.5	5.66	42.4	6.45	45.4	6.86	48.3	7.27	54.2	8.11	60.0	8.9		
		18	30.6	4.97	36.5	5.75	42.4	6.55	45.4	6.97	48.3	7.39	54.2	8.24	59.2	9.2		
		20	30.6	5.04	36.5	5.83	42.4	6.66	45.4	7.08	48.3	7.64	54.2	8.8	58.4	9.7		
		21	30.6	5.08	36.5	5.88	42.4	6.76	45.4	7.31	48.3	7.89	54.2	9.1	58.0	9.9		
		23	30.6	5.15	36.5	6.09	42.4	7.20	45.4	7.80	48.3	8.42	54.2	9.8	57.1	10.3		
		25	30.6	5.40	36.5	6.47	42.4	7.67	45.4	8.31	48.3	9.0	54.2	10.4	56.3	10.8		
		27	30.6	5.72	36.5	6.87	42.4	8.16	45.4	8.8	48.3	9.6	54.2	11.1	55.5	11.2		
		29	30.6	6.05	36.5	7.29	42.4	8.66	45.4	9.4	48.3	10.2	53.6	11.6	54.7	11.7		
		31	30.6	6.40	36.5	7.73	42.4	9.2	45.4	10.0	48.3	10.8	52.8	12.1	53.9	12.1		
		33	30.6	6.77	36.5	8.18	42.4	9.8	45.4	10.6	48.3	11.5	51.9	12.5	53.0	12.6		
		35	30.6	7.15	36.5	8.66	42.4	10.3	45.4	11.3	48.3	12.2	51.1	13.0	52.2	13.1		
		37	30.6	7.55	36.5	9.2	42.4	11.0	45.4	11.9	48.3	13.0	50.3	13.4	51.4	13.5		
		39	30.6	7.97	36.5	9.7	42.4	11.6	45.4	12.7	48.3	13.7	49.5	13.9	50.0	13.9		
		80	40.32	10	27.2	4.34	32.5	4.94	37.7	5.58	40.3	5.91	42.9	6.25	48.2	6.93	53.4	7.63
				12	27.2	4.39	32.5	5.01	37.7	5.66	40.3	5.99	42.9	6.34	48.2	7.04	53.4	7.75
				14	27.2	4.44	32.5	5.07	37.7	5.74	40.3	6.08	42.9	6.43	48.2	7.14	53.4	7.87
16	27.2			4.49	32.5	5.14	37.7	5.82	40.3	6.17	42.9	6.53	48.2	7.25	53.4	8.00		
18	27.2			4.55	32.5	5.21	37.7	5.91	40.3	6.26	42.9	6.63	48.2	7.37	53.4	8.13		
20	27.2			4.61	32.5	5.28	37.7	5.99	40.3	6.36	42.9	6.73	48.2	7.61	53.4	8.7		
21	27.2			4.64	32.5	5.32	37.7	6.04	40.3	6.41	42.9	6.86	48.2	7.87	53.4	9.0		
23	27.2			4.70	32.5	5.40	37.7	6.31	40.3	6.80	42.9	7.31	48.2	8.40	53.4	9.6		
25	27.2			4.83	32.5	5.72	37.7	6.71	40.3	7.23	42.9	7.78	48.2	9.0	53.4	10.2		
27	27.2			5.11	32.5	6.07	37.7	7.12	40.3	7.69	42.9	8.28	48.2	9.5	53.4	10.9		
29	27.2			5.40	32.5	6.43	37.7	7.56	40.3	8.16	42.9	8.79	48.2	10.1	53.4	11.6		
31	27.2			5.71	32.5	6.80	37.7	8.01	40.3	8.66	42.9	9.3	48.2	10.8	52.6	12.0		
33	27.2			6.02	32.5	7.19	37.7	8.49	40.3	9.2	42.9	9.9	48.2	11.5	51.8	12.5		
35	27.2			6.35	32.5	7.60	37.7	9.0	40.3	9.7	42.9	10.5	48.2	12.2	51.0	13.0		
37	27.2			6.70	32.5	8.03	37.7	9.5	40.3	10.3	42.9	11.1	48.2	12.9	50.1	13.4		
39	27.2			7.06	32.5	8.49	37.7	10.1	40.3	10.9	42.9	11.8	48.2	13.7	49.3	13.9		
70	35.28			10	23.8	3.96	28.4	4.47	33.0	5.01	35.3	5.28	37.6	5.57	42.2	6.15	46.8	6.74
				12	23.8	4.00	28.4	4.52	33.0	5.07	35.3	5.35	37.6	5.64	42.2	6.23	46.8	6.84
				14	23.8	4.05	28.4	4.58	33.0	5.14	35.3	5.43	37.6	5.72	42.2	6.33	46.8	6.95
		16	23.8	4.09	28.4	4.64	33.0	5.21	35.3	5.50	37.6	5.80	42.2	6.42	46.8	7.05		
		18	23.8	4.14	28.4	4.69	33.0	5.28	35.3	5.58	37.6	5.89	42.2	6.52	46.8	7.17		
		20	23.8	4.19	28.4	4.76	33.0	5.35	35.3	5.66	37.6	5.98	42.2	6.62	46.8	7.34		
		21	23.8	4.21	28.4	4.79	33.0	5.39	35.3	5.71	37.6	6.02	42.2	6.71	46.8	7.58		
		23	23.8	4.27	28.4	4.85	33.0	5.48	35.3	5.87	37.6	6.28	42.2	7.15	46.8	8.09		
		25	23.8	4.32	28.4	5.02	33.0	5.82	35.3	6.24	37.6	6.68	42.2	7.62	46.8	8.62		
		27	23.8	4.54	28.4	5.32	33.0	6.17	35.3	6.62	37.6	7.10	42.2	8.10	46.8	9.2		
		29	23.8	4.79	28.4	5.62	33.0	6.53	35.3	7.02	37.6	7.53	42.2	8.60	46.8	9.8		
		31	23.8	5.06	28.4	5.94	33.0	6.92	35.3	7.44	37.6	7.98	42.2	9.1	46.8	10.4		
		33	23.8	5.33	28.4	6.28	33.0	7.32	35.3	7.88	37.6	8.46	42.2	9.7	46.8	11.0		
		35	23.8	5.61	28.4	6.62	33.0	7.74	35.3	8.33	37.6	8.95	42.2	10.3	46.8	11.7		
		37	23.8	5.91	28.4	6.99	33.0	8.18	35.3	8.81	37.6	9.5	42.2	10.9	46.8	12.4		
		39	23.8	6.22	28.4	7.37	33.0	8.64	35.3	9.3	37.6	10.0	42.2	11.5	46.8	13.2		
		60	30.24	10	20.4	3.60	24.3	4.02	28.3	4.46	30.2	4.68	32.2	4.91	36.1	5.39	40.1	5.88
				12	20.4	3.64	24.3	4.06	28.3	4.51	30.2	4.74	32.2	4.98	36.1	5.46	40.1	5.96
				14	20.4	3.67	24.3	4.11	28.3	4.56	30.2	4.80	32.2	5.04	36.1	5.54	40.1	6.05
16	20.4			3.71	24.3	4.15	28.3	4.62	30.2	4.86	32.2	5.11	36.1	5.61	40.1	6.14		
18	20.4			3.75	24.3	4.20	28.3	4.68	30.2	4.93	32.2	5.18	36.1	5.70	40.1	6.23		
20	20.4			3.79	24.3	4.25	28.3	4.74	30.2	4.99	32.2	5.25	36.1	5.78	40.1	6.33		
21	20.4			3.81	24.3	4.28	28.3	4.77	30.2	5.03	32.2	5.29	36.1	5.82	40.1	6.38		
23	20.4			3.85	24.3	4.33	28.3	4.84	30.2	5.10	32.2	5.37	36.1	6.02	40.1	6.75		
25	20.4			3.90	24.3	4.39	28.3	5.00	30.2	5.33	32.2	5.68	36.1	6.40	40.1	7.18		
27	20.4			4.02	24.3	4.63	28.3	5.29	30.2	5.65	32.2	6.02	36.1	6.80	40.1	7.63		
29	20.4			4.23	24.3	4.89	28.3	5.60	30.2	5.98	32.2	6.37	36.1	7.21	40.1	8.10		
31	20.4			4.46	24.3	5.15	28.3	5.92	30.2	6.32	32.2	6.75	36.1	7.64	40.1	8.60		
33	20.4			4.69	24.3	5.43	28.3	6.25	30.2	6.68	32.2	7.13	36.1	8.09	40.1	9.1		
35	20.4			4.93	24.3	5.72	28.3	6.60	30.2	7.06	32.2	7.54	36.1	8.56	40.1	9.7		
37	20.4			5.18	24.3	6.03	28.3	6.96	30.2	7.45	32.2	7.97	36.1	9.1	40.1	10.2		
39	20.4			5.44	24.3	6.34	28.3	7.34	30.2	7.86	32.2	8.41	36.1	9.6	40.1	10.8		
50	25.20			10	17.0	3.27	20.3	3.59	23.6	3.94	25.2	4.11	26.8	4.29	30.1	4.67	33.4	5.06
				12	17.0	3.29	20.3	3.63	23.6	3.98	25.2	4.16	26.8	4.34	30.1	4.73	33.4	5.12
				14	17.0	3.32	20.3	3.66	23.6	4.02	25.2	4.20	26.8	4.39	30.1	4.78	33.4	5.19
		16	17.0	3.35	20.3	3.70	23.6	4.06	25.2	4.25	26.8	4.45	30.1	4.85	33.4	5.26		
		18	17.0	3.38	20.3	3.74	23.6	4.11	25.2	4.30	26.8	4.50	30.1	4.91	33.4	5.33		
		20	17.0	3.41	20.3	3.77	23.6	4.16	25.2	4.36	26.8	4.56	30.1	4.98	33.4	5.41		
		21	17.0	3.43	20.3	3.79	23.6	4.18	25.2	4.38	26.8	4.59	30.1	5.01	33.4	5.45		
		23	17.0	3.46	20.3	3.84	23.6	4.23	25.2	4.44	26.8	4.65	30.1	5.08	33.4	5.55		
		25	17.0	3.49	20.3	3.88	23.6	4.29	25.2	4.51	26.8	4.77	30.1	5.31	33.4	5.89		
		27	17.0	3.53	20.3	4.00	23.6	4.50	25.2	4.77	26.8	5.04	30.1	5.63	33.4	6.25		
		29	17.0	3.72	20.3	4.21	23.6	4.75	25.2	5.04	26.8	5.33	30.1	5.96	33.4	6.62		
		31	17.0	3.90	20.3	4.44	23.6</											

# 5 Capacity tables

## 5 - 1 Cooling Capacity Tables

RQYQ20PY1			TC: Total Capacity: kW ; PI: Power Input: kW (compressor + outdoor fan motor)													
Combination (%)	Capacity index (kW)	Outdoor air temp. °CDB	Indoor air temperature: °CWB													
			14.0		16.0		18.0		19.0		20.0		22.0		24.0	
			TC	PI	TC	PI	TC	PI	TC	PI	TC	PI	TC	PI	TC	PI
130	72.67	10	49.0	7.65	58.5	9.00	67.9	10.4	70.4	10.5	71.3	10.3	73.1	9.9	74.8	9.45
		12	49.0	7.77	58.5	9.14	67.9	10.5	69.5	10.5	70.4	10.3	72.1	9.8	73.9	9.7
		14	49.0	7.88	58.5	9.28	67.7	10.7	68.6	10.4	69.5	10.2	71.2	10.1	73.0	10.2
		16	49.0	8.00	58.5	9.43	66.8	10.6	67.7	10.5	68.6	10.6	70.3	10.7	72.1	10.8
		18	49.0	8.13	58.5	9.58	65.9	11.0	66.8	11.1	67.7	11.1	69.4	11.2	71.2	11.3
		20	49.0	8.26	58.5	10.2	65.0	11.5	65.9	11.6	66.7	11.7	68.5	11.8	70.3	11.9
		21	49.0	8.47	58.5	10.5	64.5	11.8	65.4	11.9	66.3	11.9	68.1	12.0	69.8	12.2
		23	49.0	9.03	58.5	11.2	63.6	12.3	64.5	12.4	65.4	12.5	67.1	12.6	68.9	12.7
		25	49.0	9.62	58.5	12.0	62.7	12.9	63.6	13.0	64.5	13.0	66.2	13.2	68.0	13.3
		27	49.0	10.2	58.5	12.8	61.8	13.4	62.7	13.5	63.6	13.6	65.3	13.7	67.1	13.9
		29	49.0	10.9	58.5	13.6	60.9	14.0	61.8	14.1	62.7	14.1	64.4	14.3	66.2	14.4
		31	49.0	11.6	58.2	14.4	60.0	14.5	60.9	14.6	61.7	14.7	63.5	14.8	65.3	15.0
		33	49.0	12.3	57.3	14.9	59.1	15.1	59.9	15.2	60.8	15.2	62.6	15.4	64.4	15.6
		35	49.0	13.0	56.4	15.4	58.2	15.6	59.0	15.7	59.9	15.8	61.7	16.0	63.5	16.2
		37	49.0	13.8	55.5	16.0	57.2	16.2	58.1	16.3	59.0	16.4	60.8	16.6	62.5	16.7
		39	49.0	14.6	54.6	16.5	56.3	16.7	57.2	16.8	58.1	16.9	59.9	17.1	61.6	17.3
		120	67.08	10	45.3	7.13	54.0	8.35	62.7	9.62	67.1	10.3	70.2	10.6	71.8	10.2
12	45.3			7.23	54.0	8.48	62.7	9.76	67.1	10.4	69.3	10.5	70.9	10.1	72.5	9.7
14	45.3			7.34	54.0	8.61	62.7	9.9	67.1	10.6	68.4	10.5	70.0	10.1	71.6	10.1
16	45.3			7.45	54.0	8.74	62.7	10.1	66.6	10.6	67.4	10.5	69.1	10.6	70.7	10.7
18	45.3			7.56	54.0	8.88	62.7	10.4	65.7	11.0	66.5	11.0	68.2	11.1	69.8	11.2
20	45.3			7.68	54.0	9.20	62.7	11.1	64.8	11.5	65.6	11.6	67.3	11.7	68.9	11.8
21	45.3			7.74	54.0	9.51	62.7	11.5	64.4	11.8	65.2	11.9	66.8	12.0	68.4	12.1
23	45.3			8.23	54.0	10.2	62.6	12.3	63.4	12.3	64.3	12.4	65.9	12.5	67.5	12.6
25	45.3			8.76	54.0	10.8	61.7	12.8	62.5	12.9	63.4	12.9	65.0	13.1	66.6	13.2
27	45.3			9.31	54.0	11.5	60.8	13.4	61.6	13.4	62.4	13.5	64.1	13.6	65.7	13.7
29	45.3			9.88	54.0	12.3	59.9	13.9	60.7	14.0	61.5	14.0	63.2	14.2	64.8	14.3
31	45.3			10.5	54.0	13.0	59.0	14.4	59.8	14.5	60.6	14.6	62.3	14.7	63.9	14.9
33	45.3			11.1	54.0	13.9	58.1	15.0	58.9	15.1	59.7	15.1	61.3	15.3	63.0	15.4
35	45.3			11.8	54.0	14.7	57.2	15.5	58.0	15.6	58.8	15.7	60.4	15.9	62.1	16.0
37	45.3			12.5	54.0	15.6	56.3	16.1	57.1	16.2	57.9	16.2	59.5	16.4	61.2	16.6
39	45.3			13.2	53.7	16.4	55.4	16.6	56.2	16.7	57.0	16.8	58.6	17.0	60.3	17.2
110	61.49			10	41.5	6.62	49.5	7.72	57.5	8.86	61.5	9.44	65.5	10.0	70.6	10.5
		12	41.5	6.71	49.5	7.83	57.5	8.99	61.5	9.58	65.5	10.2	69.6	10.5	71.1	10.1
		14	41.5	6.81	49.5	7.95	57.5	9.13	61.5	9.73	65.5	10.3	68.7	10.4	70.2	10.1
		16	41.5	6.90	49.5	8.07	57.5	9.28	61.5	9.9	65.5	10.5	67.8	10.5	69.3	10.6
		18	41.5	7.00	49.5	8.20	57.5	9.43	61.5	10.1	65.4	11.0	66.9	11.1	68.4	11.2
		20	41.5	7.11	49.5	8.33	57.5	10.0	61.5	10.8	64.5	11.5	66.0	11.6	67.5	11.7
		21	41.5	7.16	49.5	8.56	57.5	10.3	61.5	11.2	64.1	11.8	65.6	11.9	67.1	12.0
		23	41.5	7.47	49.5	9.13	57.5	11.0	61.5	12.0	63.2	12.3	64.6	12.4	66.1	12.5
		25	41.5	7.94	49.5	9.73	57.5	11.7	61.5	12.8	62.2	12.9	63.7	13.0	65.2	13.1
		27	41.5	8.43	49.5	10.3	57.5	12.5	60.6	13.3	61.3	13.4	62.8	13.5	64.3	13.6
		29	41.5	8.94	49.5	11.0	57.5	13.3	59.7	13.9	60.4	13.9	61.9	14.1	63.4	14.2
		31	41.5	9.48	49.5	11.7	57.5	14.1	58.8	14.4	59.5	14.5	61.0	14.6	62.5	14.8
		33	41.5	10.05	49.5	12.4	57.1	14.9	57.9	15.0	58.6	15.0	60.1	15.2	61.6	15.3
		35	41.5	10.6	49.5	13.2	56.2	15.4	56.9	15.5	57.7	15.6	59.2	15.7	60.7	15.9
		37	41.5	11.3	49.5	14.0	55.3	16.0	56.0	16.1	56.8	16.1	58.3	16.3	59.8	16.4
		39	41.5	11.9	49.5	14.8	54.4	16.5	55.1	16.6	55.9	16.7	57.4	16.9	58.9	17.0
		100	55.90	10	37.7	6.12	45.0	7.09	52.3	8.11	55.9	8.63	59.5	9.15	66.8	10.2
12	37.7			6.20	45.0	7.19	52.3	8.23	55.9	8.76	59.5	9.29	66.8	10.4	69.8	10.4
14	37.7			6.29	45.0	7.30	52.3	8.35	55.9	8.89	59.5	9.44	66.8	10.5	68.8	10.4
16	37.7			6.37	45.0	7.41	52.3	8.48	55.9	9.03	59.5	9.59	66.6	10.7	67.9	10.5
18	37.7			6.46	45.0	7.52	52.3	8.62	55.9	9.18	59.5	9.75	65.7	11.0	67.0	11.1
20	37.7			6.56	45.0	7.64	52.3	8.84	55.9	9.61	59.5	10.4	64.8	11.5	66.1	11.6
21	37.7			6.60	45.0	7.70	52.3	9.14	55.9	9.9	59.5	10.8	64.3	11.8	65.7	11.9
23	37.7			6.75	45.0	8.17	52.3	9.75	55.9	10.6	59.5	11.5	63.4	12.3	64.8	12.4
25	37.7			7.17	45.0	8.69	52.3	10.4	55.9	11.3	59.5	12.3	62.5	12.9	63.8	13.0
27	37.7			7.60	45.0	9.24	52.3	11.1	55.9	12.0	59.5	13.1	61.6	13.4	62.9	13.5
29	37.7			8.06	45.0	9.81	52.3	11.8	55.9	12.8	59.3	13.8	60.7	14.0	62.0	14.1
31	37.7			8.53	45.0	10.4	52.3	12.5	55.9	13.6	58.4	14.4	59.8	14.5	61.1	14.6
33	37.7			9.03	45.0	11.0	52.3	13.3	55.9	14.5	57.5	14.9	58.8	15.1	60.2	15.2
35	37.7			9.55	45.0	11.7	52.3	14.1	55.9	15.4	56.6	15.5	57.9	15.6	59.3	15.7
37	37.7			10.10	45.0	12.4	52.3	15.0	55.0	15.9	55.7	16.0	57.0	16.2	58.4	16.3
39	37.7			10.7	45.0	13.1	52.3	15.9	54.1	16.5	54.8	16.6	56.1	16.7	57.5	16.9

**NOTES - ANMERKUNGEN - Σημειώσεις - NOTAS - REMARQUES - NOTE - OPMERKINGEN - Примечания - NOTLAR**

- The above table shows the average value of conditions which may occur.  
 Die obige Tabelle zeigt den Durchschnittswert der Bedingungen, die auftreten können.  
 Στον παραπάνω πίνακα αναγράφεται η μέση τιμή για συνθήκες που μπορεί να προκύψουν.  
 La tabla de arriba muestra el valor medio de condiciones que pueden ocurrir.  
 Le tableau ci-dessus donne la valeur moyenne pour des conditions qui peuvent survenir.  
 La tabella in alto mostra il valore delle condizioni medie che si possono riscontrare.  
 De tabel hierboven geeft de gemiddelde waarde aan van situaties die kunnen voorvallen.  
 Таблица расположенная выше показывает среднее значение условий, которые могут наступить.  
 Yukarıdaki tablo meydana gelebilecek koşulların ortalama değerini göstermektedir.

# 5 Capacity tables

## 5 - 1 Cooling Capacity Tables

5

RQYQ20PY1																
Combination (%)	Capacity index (kW)	Outdoor air temp. °CDB	Indoor air temperature: °CWB													
			14.0		16.0		18.0		19.0		20.0		22.0		24.0	
			TC	PI	TC	PI	TC	PI	TC	PI	TC	PI	TC	PI	TC	PI
			kW	kW	kW	kW	kW	kW	kW	kW	kW	kW	kW	kW	kW	kW
90	50.31	10	34.0	5.64	40.5	6.49	47.0	7.38	50.3	7.83	53.6	8.29	60.1	9.24	66.7	10.2
		12	34.0	5.71	40.5	6.58	47.0	7.48	50.3	7.95	53.6	8.42	60.1	9.38	66.7	10.4
		14	34.0	5.78	40.5	6.67	47.0	7.59	50.3	8.07	53.6	8.55	60.1	9.53	66.7	10.5
		16	34.0	5.86	40.5	6.76	47.0	7.71	50.3	8.19	53.6	8.68	60.1	9.68	66.6	10.7
		18	34.0	5.94	40.5	6.86	47.0	7.82	50.3	8.32	53.6	8.82	60.1	9.8	65.6	11.0
		20	34.0	6.02	40.5	6.96	47.0	7.95	50.3	8.45	53.6	9.12	60.1	10.5	64.7	11.5
		21	34.0	6.06	40.5	7.01	47.0	8.07	50.3	8.73	53.6	9.42	60.1	10.9	64.3	11.8
		23	34.0	6.15	40.5	7.27	47.0	8.60	50.3	9.31	53.6	10.1	60.1	11.6	63.4	12.3
		25	34.0	6.44	40.5	7.73	47.0	9.16	50.3	9.92	53.6	10.7	60.1	12.4	62.5	12.9
		27	34.0	6.83	40.5	8.21	47.0	9.74	50.3	10.6	53.6	11.4	60.1	13.2	61.6	13.4
		29	34.0	7.23	40.5	8.70	47.0	10.3	50.3	11.2	53.6	12.1	59.4	13.9	60.6	14.0
		31	34.0	7.64	40.5	9.23	47.0	11.0	50.3	11.9	53.6	12.9	58.5	14.4	59.7	14.5
		33	34.0	8.08	40.5	9.77	47.0	11.7	50.3	12.7	53.6	13.7	57.6	14.9	58.8	15.1
		35	34.0	8.53	40.5	10.3	47.0	12.4	50.3	13.4	53.6	14.6	56.7	15.5	57.9	15.6
		37	34.0	9.01	40.5	10.9	47.0	13.1	50.3	14.3	53.6	15.5	55.8	16.0	57.0	16.2
		39	34.0	9.51	40.5	11.6	47.0	13.9	50.3	15.1	53.6	16.4	54.9	16.6	56.1	16.7
		80	44.72	10	30.2	5.18	36.0	5.90	41.8	6.66	44.7	7.06	47.6	7.46	53.4	8.28
12	30.2			5.24	36.0	5.98	41.8	6.75	44.7	7.16	47.6	7.56	53.4	8.40	59.3	9.25
14	30.2			5.30	36.0	6.05	41.8	6.85	44.7	7.26	47.6	7.68	53.4	8.53	59.3	9.40
16	30.2			5.36	36.0	6.14	41.8	6.95	44.7	7.37	47.6	7.79	53.4	8.66	59.3	9.55
18	30.2			5.43	36.0	6.22	41.8	7.05	44.7	7.48	47.6	7.91	53.4	8.80	59.3	9.70
20	30.2			5.50	36.0	6.31	41.8	7.16	44.7	7.59	47.6	8.04	53.4	9.09	59.3	10.3
21	30.2			5.53	36.0	6.35	41.8	7.21	44.7	7.65	47.6	8.19	53.4	9.39	59.3	10.7
23	30.2			5.61	36.0	6.45	41.8	7.33	44.7	7.76	47.6	8.33	53.4	9.69	59.3	11.1
25	30.2			5.76	36.0	6.63	41.8	7.53	44.7	8.03	47.6	8.63	53.4	10.0	59.3	11.4
27	30.2			6.10	36.0	7.24	41.8	8.00	44.7	8.63	47.6	9.29	53.4	10.7	59.3	12.2
29	30.2			6.45	36.0	7.67	41.8	8.50	44.7	9.18	47.6	9.88	53.4	11.4	59.3	13.0
31	30.2			6.81	36.0	8.12	41.8	9.02	44.7	9.74	47.6	10.5	53.4	12.1	59.3	13.8
33	30.2			7.19	36.0	8.59	41.8	9.56	44.7	10.3	47.6	11.1	53.4	12.9	58.3	14.4
35	30.2			7.58	36.0	9.08	41.8	10.13	44.7	11.0	47.6	11.8	53.4	13.7	57.4	14.9
37	30.2			8.00	36.0	9.59	41.8	10.7	44.7	11.6	47.6	12.5	53.4	14.5	56.5	15.5
39	30.2			8.43	36.0	10.13	41.8	11.4	44.7	12.3	47.6	13.3	53.4	15.4	55.6	16.0
70	39.13			10	26.4	4.73	31.5	5.34	36.6	5.98	39.1	6.31	41.7	6.65	46.8	7.34
		12	26.4	4.78	31.5	5.40	36.6	6.05	39.1	6.39	41.7	6.74	46.8	7.44	51.9	8.17
		14	26.4	4.83	31.5	5.47	36.6	6.13	39.1	6.48	41.7	6.83	46.8	7.55	51.9	8.29
		16	26.4	4.89	31.5	5.53	36.6	6.22	39.1	6.57	41.7	6.93	46.8	7.67	51.9	8.42
		18	26.4	4.94	31.5	5.60	36.6	6.30	39.1	6.66	41.7	7.03	46.8	7.78	51.9	8.55
		20	26.4	5.00	31.5	5.68	36.6	6.39	39.1	6.76	41.7	7.14	46.8	7.90	51.9	8.76
		21	26.4	5.03	31.5	5.72	36.6	6.44	39.1	6.81	41.7	7.19	46.8	8.01	51.9	9.05
		23	26.4	5.09	31.5	5.79	36.6	6.54	39.1	7.01	41.7	7.50	46.8	8.54	51.9	9.66
		25	26.4	5.16	31.5	5.99	36.6	6.94	39.1	7.45	41.7	7.98	46.8	9.09	51.9	10.3
		27	26.4	5.42	31.5	6.35	36.6	7.36	39.1	7.91	41.7	8.47	46.8	9.67	51.9	11.0
		29	26.4	5.72	31.5	6.71	36.6	7.80	39.1	8.38	41.7	8.99	46.8	10.3	51.9	11.7
		31	26.4	6.04	31.5	7.09	36.6	8.26	39.1	8.88	41.7	9.53	46.8	10.9	51.9	12.4
		33	26.4	6.36	31.5	7.49	36.6	8.74	39.1	9.40	41.7	10.10	46.8	11.6	51.9	13.2
		35	26.4	6.70	31.5	7.91	36.6	9.24	39.1	9.95	41.7	10.7	46.8	12.3	51.9	14.0
		37	26.4	7.05	31.5	8.34	36.6	9.76	39.1	10.5	41.7	11.3	46.8	13.0	51.9	14.8
		39	26.4	7.42	31.5	8.80	36.6	10.31	39.1	11.1	41.7	12.0	46.8	13.8	51.9	15.7
		60	33.54	10	22.6	4.30	27.0	4.80	31.4	5.32	33.5	5.59	35.7	5.87	40.1	6.43
12	22.6			4.34	27.0	4.85	31.4	5.38	33.5	5.66	35.7	5.94	40.1	6.52	44.4	7.12
14	22.6			4.39	27.0	4.90	31.4	5.45	33.5	5.73	35.7	6.02	40.1	6.61	44.4	7.22
16	22.6			4.43	27.0	4.96	31.4	5.52	33.5	5.80	35.7	6.10	40.1	6.70	44.4	7.33
18	22.6			4.48	27.0	5.02	31.4	5.59	33.5	5.88	35.7	6.18	40.1	6.80	44.4	7.44
20	22.6			4.52	27.0	5.08	31.4	5.66	33.5	5.96	35.7	6.27	40.1	6.90	44.4	7.55
21	22.6			4.55	27.0	5.11	31.4	5.70	33.5	6.00	35.7	6.31	40.1	6.95	44.4	7.61
23	22.6			4.60	27.0	5.17	31.4	5.77	33.5	6.09	35.7	6.41	40.1	7.19	44.4	8.06
25	22.6			4.65	27.0	5.24	31.4	5.97	33.5	6.37	35.7	6.78	40.1	7.64	44.4	8.57
27	22.6			4.79	27.0	5.52	31.4	6.32	33.5	6.74	35.7	7.18	40.1	8.11	44.4	9.11
29	22.6			5.05	27.0	5.83	31.4	6.69	33.5	7.14	35.7	7.61	40.1	8.61	44.4	9.67
31	22.6			5.32	27.0	6.15	31.4	7.06	33.5	7.55	35.7	8.05	40.1	9.12	44.4	10.3
33	22.6			5.60	27.0	6.49	31.4	7.46	33.5	7.98	35.7	8.52	40.1	9.66	44.4	10.9
35	22.6			5.88	27.0	6.83	31.4	7.87	33.5	8.43	35.7	9.00	40.1	10.22	44.4	11.5
37	22.6			6.18	27.0	7.20	31.4	8.30	33.5	8.90	35.7	9.51	40.1	10.8	44.4	12.2
39	22.6			6.49	27.0	7.57	31.4	8.76	33.5	9.39	35.7	10.04	40.1	11.4	44.4	12.9
50	27.95			10	18.9	3.90	22.5	4.29	26.1	4.70	28.0	4.91	29.8	5.13	33.4	5.57
		12	18.9	3.93	22.5	4.33	26.1	4.75	28.0	4.96	29.8	5.19	33.4	5.64	37.0	6.11
		14	18.9	3.96	22.5	4.37	26.1	4.80	28.0	5.02	29.8	5.25	33.4	5.71	37.0	6.19
		16	18.9	4.00	22.5	4.41	26.1	4.85	28.0	5.08	29.8	5.31	33.4	5.79	37.0	6.28
		18	18.9	4.03	22.5	4.46	26.1	4.91	28.0	5.14	29.8	5.37	33.4	5.86	37.0	6.37
		20	18.9	4.07	22.5	4.51	26.1	4.96	28.0	5.20	29.8	5.44	33.4	5.94	37.0	6.46
		21	18.9	4.09	22.5	4.53	26.1	4.99	28.0	5.23	29.8	5.48	33.4	5.98	37.0	6.50
		23	18.9	4.13	22.5	4.58	26.1	5.05	28.0	5.30	29.8	5.55	33.4	6.07	37.0	6.62
		25	18.9	4.17	22.5	4.63	26.1	5.12	28.0	5.38	29.8	5.69	33.4	6.34	37.0	7.03
		27	18.9	4.22	22.5	4.77	26.1	5.37	28.0	5.69	29.8	6.02	33.4	6.72	37.0	7.46
		29	18.9	4.44	22.5	5.03	26.1	5.67	28.0	6.01	29.8	6.37	33.4	7.11	37.0	7.90

# 5 Capacity tables

## 5 - 1 Cooling Capacity Tables

RQYQ22PY1

TC: Total Capacity: kW ; PI: Power Input: kW (compressor + outdoor fan motor)

Combination (%)	Capacity index (kW)	Outdoor air temp. °CDB	Indoor air temperature: °CWB															
			14.0		16.0		18.0		19.0		20.0		22.0		24.0			
			TC	PI	TC	PI	TC	PI	TC	PI	TC	PI	TC	PI	TC	PI		
130	79.95	10	54.0	8.85	64.4	10.40	74.8	12.0	77.5	12.2	78.4	11.9	80.4	11.4	82.3	10.9		
		12	54.0	8.98	64.4	10.56	74.8	12.2	76.5	12.1	77.4	11.9	79.4	11.4	81.3	11.2		
		14	54.0	9.11	64.4	10.7	74.5	12.3	75.5	12.1	76.4	11.8	78.4	11.7	80.3	11.8		
		16	54.0	9.25	64.4	10.9	73.5	12.3	74.5	12.2	75.4	12.2	77.4	12.3	79.3	12.5		
		18	54.0	9.39	64.4	11.1	72.5	12.7	73.5	12.8	74.4	12.8	76.4	13.0	78.3	13.1		
		20	54.0	9.54	64.4	11.8	71.5	13.3	72.5	13.4	73.4	13.5	75.4	13.6	77.3	13.7		
		21	54.0	9.79	64.4	12.2	71.0	13.7	72.0	13.7	72.9	13.8	74.9	13.9	76.8	14.1		
		23	54.0	10.44	64.4	13.0	70.0	14.3	71.0	14.3	71.9	14.4	73.9	14.6	75.8	14.7		
		25	54.0	11.1	64.4	13.9	69.0	14.9	70.0	15.0	70.9	15.1	72.9	15.2	74.8	15.4		
		27	54.0	11.8	64.4	14.8	68.0	15.5	69.0	15.6	69.9	15.7	71.9	15.9	73.8	16.0		
		29	54.0	12.6	64.4	15.7	67.0	16.2	68.0	16.2	68.9	16.3	70.9	16.5	72.8	16.7		
		31	54.0	13.4	64.0	16.6	66.0	16.8	67.0	16.9	67.9	17.0	69.9	17.2	71.8	17.3		
		33	54.0	14.2	63.0	17.2	65.0	17.4	66.0	17.5	66.9	17.6	68.9	17.8	70.8	18.0		
		35	54.0	15.0	62.0	17.9	64.0	18.1	65.0	18.2	65.9	18.3	67.9	18.5	69.8	18.7		
		37	54.0	15.9	61.0	18.5	63.0	18.7	64.0	18.8	64.9	18.9	66.9	19.1	68.8	19.3		
		39	54.0	16.9	60.0	19.1	62.0	19.3	63.0	19.5	63.9	19.6	65.9	19.8	67.8	20.0		
		120	73.80	10	49.8	8.24	59.4	9.66	69.0	11.1	73.8	11.9	77.2	12.2	79.0	11.8	80.8	11.3
				12	49.8	8.36	59.4	9.80	69.0	11.3	73.8	12.0	76.2	12.2	78.0	11.7	79.8	11.2
14	49.8			8.48	59.4	9.95	69.0	11.5	73.8	12.2	75.2	12.1	77.0	11.6	78.8	11.7		
16	49.8			8.61	59.4	10.11	69.0	11.6	73.3	12.3	74.2	12.1	76.0	12.3	77.8	12.4		
18	49.8			8.74	59.4	10.27	69.0	12.0	72.3	12.7	73.2	12.8	75.0	12.9	76.8	13.0		
20	49.8			8.87	59.4	10.64	69.0	12.9	71.3	13.3	72.2	13.4	74.0	13.5	75.8	13.6		
21	49.8			8.94	59.4	11.0	69.0	13.3	70.8	13.6	71.7	13.7	73.5	13.8	75.3	14.0		
23	49.8			9.51	59.4	11.7	68.9	14.2	69.8	14.3	70.7	14.3	72.5	14.5	74.3	14.6		
25	49.8			10.12	59.4	12.5	67.9	14.8	68.8	14.9	69.7	15.0	71.5	15.1	73.3	15.2		
27	49.8			10.76	59.4	13.3	66.9	15.4	67.8	15.5	68.7	15.6	70.5	15.7	72.3	15.9		
29	49.8			11.4	59.4	14.2	65.9	16.1	66.8	16.1	67.7	16.2	69.5	16.4	71.3	16.5		
31	49.8			12.1	59.4	15.1	64.9	16.7	65.8	16.8	66.7	16.9	68.5	17.0	70.3	17.2		
33	49.8			12.9	59.4	16.0	63.9	17.3	64.8	17.4	65.7	17.5	67.5	17.7	69.3	17.9		
35	49.8			13.6	59.4	17.0	62.9	17.9	63.8	18.0	64.7	18.1	66.5	18.3	68.3	18.5		
37	49.8			14.4	59.4	18.1	61.9	18.6	62.8	18.7	63.7	18.8	65.5	19.0	67.3	19.2		
39	49.8			15.3	59.1	19.0	60.9	19.2	61.8	19.3	62.7	19.4	64.5	19.6	66.3	19.9		
110	67.65			10	45.7	7.65	54.5	8.92	63.3	10.24	67.7	10.9	72.0	11.6	77.6	12.1	79.3	11.7
				12	45.7	7.76	54.5	9.05	63.3	10.39	67.7	11.1	72.0	11.8	76.6	12.1	78.3	11.6
		14	45.7	7.87	54.5	9.19	63.3	10.55	67.7	11.2	72.0	11.9	75.6	12.0	77.3	11.6		
		16	45.7	7.98	54.5	9.33	63.3	10.7	67.7	11.4	72.0	12.1	74.6	12.2	76.3	12.3		
		18	45.7	8.10	54.5	9.47	63.3	10.9	67.7	11.7	72.0	12.7	73.6	12.8	75.3	12.9		
		20	45.7	8.22	54.5	9.62	63.3	11.5	67.7	12.5	71.0	13.3	72.6	13.4	74.3	13.5		
		21	45.7	8.28	54.5	9.90	63.3	11.9	67.7	13.0	70.5	13.6	72.1	13.7	73.8	13.8		
		23	45.7	8.63	54.5	10.55	63.3	12.7	67.7	13.9	69.5	14.2	71.1	14.4	72.8	14.5		
		25	45.7	9.18	54.5	11.2	63.3	13.5	67.7	14.8	68.5	14.9	70.1	15.0	71.8	15.1		
		27	45.7	9.74	54.5	12.0	63.3	14.4	66.7	15.4	67.5	15.5	69.1	15.6	70.8	15.8		
		29	45.7	10.34	54.5	12.7	63.3	15.4	65.7	16.0	66.5	16.1	68.1	16.3	69.8	16.4		
		31	45.7	10.96	54.5	13.5	63.3	16.4	64.7	16.7	65.5	16.7	67.1	16.9	68.8	17.1		
		33	45.7	11.6	54.5	14.3	62.8	17.2	63.7	17.3	64.5	17.4	66.1	17.5	67.8	17.7		
		35	45.7	12.3	54.5	15.2	61.8	17.8	62.7	17.9	63.5	18.0	65.1	18.2	66.8	18.4		
		37	45.7	13.0	54.5	16.1	60.8	18.5	61.7	18.6	62.5	18.6	64.1	18.8	65.8	19.0		
		39	45.7	13.8	54.5	17.1	59.8	19.1	60.6	19.2	61.5	19.3	63.1	19.5	64.8	19.7		
		100	61.50	10	41.5	7.08	49.5	8.20	57.5	9.37	61.5	9.97	65.5	10.58	73.5	11.8	77.7	12.1
				12	41.5	7.17	49.5	8.32	57.5	9.51	61.5	10.12	65.5	10.7	73.5	12.0	76.7	12.0
14	41.5			7.27	49.5	8.44	57.5	9.66	61.5	10.28	65.5	10.9	73.5	12.2	75.7	12.0		
16	41.5			7.37	49.5	8.56	57.5	9.81	61.5	10.44	65.5	11.1	73.2	12.3	74.7	12.2		
18	41.5			7.47	49.5	8.69	57.5	9.96	61.5	10.61	65.5	11.3	72.2	12.7	73.7	12.8		
20	41.5			7.58	49.5	8.83	57.5	10.22	61.5	11.1	65.5	12.0	71.2	13.3	72.7	13.4		
21	41.5			7.63	49.5	8.89	57.5	10.56	61.5	11.5	65.5	12.4	70.7	13.6	72.2	13.7		
23	41.5			7.80	49.5	9.44	57.5	11.3	61.5	12.3	65.5	13.3	69.7	14.3	71.2	14.4		
25	41.5			8.28	49.5	10.05	57.5	12.0	61.5	13.1	65.5	14.2	68.7	14.9	70.2	15.0		
27	41.5			8.79	49.5	10.68	57.5	12.8	61.5	13.9	65.5	15.1	67.7	15.5	69.2	15.6		
29	41.5			9.31	49.5	11.3	57.5	13.6	61.5	14.8	65.2	16.0	66.7	16.1	68.2	16.3		
31	41.5			9.86	49.5	12.0	57.5	14.5	61.5	15.8	64.2	16.6	65.7	16.8	67.2	16.9		
33	41.5			10.44	49.5	12.8	57.5	15.4	61.5	16.8	63.2	17.3	64.7	17.4	66.2	17.5		
35	41.5			11.04	49.5	13.5	57.5	16.3	61.5	17.8	62.2	17.9	63.7	18.0	65.2	18.2		
37	41.5			11.7	49.5	14.3	57.5	17.3	60.5	18.4	61.2	18.5	62.7	18.7	64.2	18.8		
39	41.5			12.3	49.5	15.2	57.5	18.4	59.5	19.1	60.2	19.1	61.7	19.3	63.2	19.5		

**NOTES - ANMERKUNGEN - Σημειώσεις - NOTAS - REMARQUES - NOTE - OPMERKINGEN - Примечания - NOTLAR**

- The above table shows the average value of conditions which may occur.  
 Die obige Tabelle zeigt den Durchschnittswert der Bedingungen, die auftreten können.  
 Στον παραπάνω πίνακα αναγράφεται η μέση τιμή για συνθήκες που μπορεί να προκύψουν.  
 La tabla de arriba muestra el valor medio de condiciones que pueden ocurrir.  
 Le tableau ci-dessus donne la valeur moyenne pour des conditions qui peuvent survenir.  
 La tabella in alto mostra il valore delle condizioni medie che si possono riscontrare.  
 De tabel hierboven geeft de gemiddelde waarde aan van situaties die kunnen voorvallen.  
 Таблица расположенная выше показывает среднее значение условий, которые могут наступить.  
 Yukarıdaki tablo meydana gelebilecek koşulların ortalama değerini göstermektedir.



# 5 Capacity tables

## 5 - 1 Cooling Capacity Tables

5

RQYQ22PY1

TC: Total Capacity: kW ; PI: Power Input: kW (compressor + outdoor fan motor)

Combination (%)	Capacity index (kW)	Outdoor air temp. °CDB	Indoor air temperature: °CWB															
			14.0		16.0		18.0		19.0		20.0		22.0		24.0			
			TC	PI	TC	PI	TC	PI	TC	PI	TC	PI	TC	PI	TC	PI		
90	55.35	10	37.4	6.52	44.6	7.50	51.8	8.52	55.4	9.05	58.9	9.59	66.1	10.7	73.3	11.8		
		12	37.4	6.60	44.6	7.60	51.8	8.65	55.4	9.19	58.9	9.73	66.1	10.8	73.3	12.0		
		14	37.4	6.69	44.6	7.71	51.8	8.77	55.4	9.32	58.9	9.88	66.1	11.0	73.3	12.2		
		16	37.4	6.77	44.6	7.81	51.8	8.91	55.4	9.47	58.9	10.03	66.1	11.2	73.2	12.3		
		18	37.4	6.86	44.6	7.93	51.8	9.04	55.4	9.62	58.9	10.20	66.1	11.4	72.2	12.7		
		20	37.4	6.96	44.6	8.05	51.8	9.19	55.4	9.77	58.9	10.54	66.1	12.2	71.2	13.3		
		21	37.4	7.00	44.6	8.11	51.8	9.33	55.4	10.09	58.9	10.9	66.1	12.6	70.7	13.6		
		23	37.4	7.10	44.6	8.40	51.8	9.94	55.4	10.76	58.9	11.6	66.1	13.5	69.7	14.3		
		25	37.4	7.45	44.6	8.93	51.8	10.58	55.4	11.5	58.9	12.4	66.1	14.4	68.7	14.9		
		27	37.4	7.89	44.6	9.48	51.8	11.3	55.4	12.2	58.9	13.2	66.1	15.3	67.7	15.5		
		29	37.4	8.35	44.6	10.06	51.8	12.0	55.4	13.0	58.9	14.0	65.4	16.0	66.7	16.1		
		31	37.4	8.83	44.6	10.66	51.8	12.7	55.4	13.8	58.9	14.9	64.4	16.6	65.7	16.8		
		33	37.4	9.34	44.6	11.3	51.8	13.5	55.4	14.6	58.9	15.9	63.4	17.3	64.7	17.4		
		35	37.4	9.86	44.6	12.0	51.8	14.3	55.4	15.5	58.9	16.8	62.4	17.9	63.7	18.0		
		37	37.4	10.42	44.6	12.6	51.8	15.1	55.4	16.5	58.9	17.9	61.4	18.5	62.7	18.7		
		39	37.4	10.99	44.6	13.4	51.8	16.0	55.4	17.5	58.9	19.0	60.4	19.2	61.7	19.3		
		80	49.20	10	33.2	5.98	39.6	6.82	46.0	7.70	49.2	8.16	52.4	8.62	58.8	9.56	65.2	10.53
				12	33.2	6.05	39.6	6.91	46.0	7.81	49.2	8.27	52.4	8.74	58.8	9.71	65.2	10.7
14	33.2			6.12	39.6	7.00	46.0	7.92	49.2	8.39	52.4	8.87	58.8	9.86	65.2	10.9		
16	33.2			6.20	39.6	7.09	46.0	8.03	49.2	8.51	52.4	9.01	58.8	10.01	65.2	11.0		
18	33.2			6.28	39.6	7.19	46.0	8.15	49.2	8.64	52.4	9.15	58.8	10.17	65.2	11.2		
20	33.2			6.36	39.6	7.29	46.0	8.27	49.2	8.78	52.4	9.29	58.8	10.50	65.2	12.0		
21	33.2			6.40	39.6	7.34	46.0	8.34	49.2	8.85	52.4	9.46	58.8	10.9	65.2	12.4		
23	33.2			6.48	39.6	7.45	46.0	8.70	49.2	9.38	52.4	10.09	58.8	11.6	65.2	13.2		
25	33.2			6.66	39.6	7.89	46.0	9.25	49.2	9.98	52.4	10.74	58.8	12.4	65.2	14.1		
27	33.2			7.05	39.6	8.37	46.0	9.83	49.2	10.61	52.4	11.4	58.8	13.2	65.2	15.0		
29	33.2			7.45	39.6	8.87	46.0	10.43	49.2	11.3	52.4	12.1	58.8	14.0	65.2	16.0		
31	33.2			7.87	39.6	9.38	46.0	11.05	49.2	12.0	52.4	12.9	58.8	14.9	64.2	16.6		
33	33.2			8.31	39.6	9.93	46.0	11.7	49.2	12.7	52.4	13.7	58.8	15.8	63.2	17.2		
35	33.2			8.77	39.6	10.49	46.0	12.4	49.2	13.4	52.4	14.5	58.8	16.8	62.2	17.9		
37	33.2			9.24	39.6	11.09	46.0	13.1	49.2	14.2	52.4	15.4	58.8	17.8	61.2	18.5		
39	33.2			9.74	39.6	11.7	46.0	13.9	49.2	15.1	52.4	16.3	58.8	18.9	60.2	19.1		
70	43.05			10	29.1	5.47	34.7	6.17	40.3	6.91	43.1	7.29	45.8	7.68	51.4	8.48	57.0	9.30
				12	29.1	5.52	34.7	6.24	40.3	7.00	43.1	7.39	45.8	7.79	51.4	8.60	57.0	9.44
		14	29.1	5.58	34.7	6.32	40.3	7.09	43.1	7.49	45.8	7.89	51.4	8.73	57.0	9.59		
		16	29.1	5.65	34.7	6.40	40.3	7.19	43.1	7.59	45.8	8.01	51.4	8.86	57.0	9.73		
		18	29.1	5.71	34.7	6.48	40.3	7.28	43.1	7.70	45.8	8.13	51.4	9.00	57.0	9.89		
		20	29.1	5.78	34.7	6.56	40.3	7.39	43.1	7.81	45.8	8.25	51.4	9.14	57.0	10.12		
		21	29.1	5.81	34.7	6.61	40.3	7.44	43.1	7.87	45.8	8.31	51.4	9.26	57.0	10.46		
		23	29.1	5.89	34.7	6.70	40.3	7.56	43.1	8.10	45.8	8.67	51.4	9.87	57.0	11.2		
		25	29.1	5.96	34.7	6.93	40.3	8.02	43.1	8.61	45.8	9.22	51.4	10.51	57.0	11.9		
		27	29.1	6.27	34.7	7.34	40.3	8.51	43.1	9.14	45.8	9.79	51.4	11.2	57.0	12.7		
		29	29.1	6.62	34.7	7.76	40.3	9.02	43.1	9.69	45.8	10.39	51.4	11.9	57.0	13.5		
		31	29.1	6.98	34.7	8.20	40.3	9.55	43.1	10.26	45.8	11.01	51.4	12.6	57.0	14.3		
		33	29.1	7.35	34.7	8.66	40.3	10.10	43.1	10.87	45.8	11.7	51.4	13.4	57.0	15.2		
		35	29.1	7.74	34.7	9.14	40.3	10.68	43.1	11.5	45.8	12.4	51.4	14.2	57.0	16.1		
		37	29.1	8.15	34.7	9.64	40.3	11.28	43.1	12.2	45.8	13.1	51.4	15.0	57.0	17.1		
		39	29.1	8.58	34.7	10.17	40.3	11.9	43.1	12.9	45.8	13.8	51.4	15.9	57.0	18.2		
		60	36.90	10	24.9	4.97	29.7	5.55	34.5	6.15	36.9	6.46	39.3	6.78	44.1	7.44	48.9	8.11
				12	24.9	5.02	29.7	5.61	34.5	6.22	36.9	6.54	39.3	6.87	44.1	7.54	48.9	8.23
14	24.9			5.07	29.7	5.67	34.5	6.30	36.9	6.62	39.3	6.96	44.1	7.64	48.9	8.35		
16	24.9			5.12	29.7	5.73	34.5	6.38	36.9	6.71	39.3	7.05	44.1	7.75	48.9	8.47		
18	24.9			5.17	29.7	5.80	34.5	6.46	36.9	6.80	39.3	7.14	44.1	7.86	48.9	8.60		
20	24.9			5.23	29.7	5.87	34.5	6.54	36.9	6.89	39.3	7.25	44.1	7.98	48.9	8.73		
21	24.9			5.26	29.7	5.90	34.5	6.58	36.9	6.94	39.3	7.30	44.1	8.04	48.9	8.80		
23	24.9			5.31	29.7	5.98	34.5	6.67	36.9	7.04	39.3	7.40	44.1	8.31	48.9	9.31		
25	24.9			5.38	29.7	6.05	34.5	6.90	36.9	7.36	39.3	7.83	44.1	8.83	48.9	9.91		
27	24.9			5.54	29.7	6.38	34.5	7.31	36.9	7.80	39.3	8.30	44.1	9.38	48.9	10.53		
29	24.9			5.84	29.7	6.74	34.5	7.73	36.9	8.25	39.3	8.80	44.1	9.95	48.9	11.2		
31	24.9			6.15	29.7	7.11	34.5	8.17	36.9	8.73	39.3	9.31	44.1	10.54	48.9	11.9		
33	24.9			6.47	29.7	7.50	34.5	8.62	36.9	9.22	39.3	9.84	44.1	11.2	48.9	12.6		
35	24.9			6.80	29.7	7.90	34.5	9.10	36.9	9.74	39.3	10.41	44.1	11.8	48.9	13.3		
37	24.9			7.15	29.7	8.32	34.5	9.60	36.9	10.28	39.3	10.99	44.1	12.5	48.9	14.1		
39	24.9			7.50	29.7	8.75	34.5	10.12	36.9	10.85	39.3	11.6	44.1	13.2	48.9	14.9		
50	30.75			10	20.8	4.51	24.8	4.96	28.8	5.43	30.8	5.68	32.7	5.93	36.7	6.44	40.7	6.98
				12	20.8	4.54	24.8	5.00	28.8	5.49	30.8	5.74	32.7	5.99	36.7	6.52	40.7	7.07
		14	20.8	4.58	24.8	5.05	28.8	5.55	30.8	5.80	32.7	6.06	36.7	6.60	40.7	7.16		
		16	20.8	4.62	24.8	5.10	28.8	5.61	30.8	5.87	32.7	6.14	36.7	6.69	40.7	7.26		
		18	20.8	4.66	24.8	5.15	28.8	5.67	30.8	5.94	32.7	6.21	36.7	6.78	40.7	7.36		
		20	20.8	4.71	24.8	5.21	28.8	5.74	30.8	6.01	32.7	6.29	36.7	6.87	40.7	7.46		
		21	20.8	4.73	24.8	5.24	28.8	5.77	30.8	6.05	32.7	6.33	36.7	6.91	40.7	7.52		
		23	20.8	4.77	24.8	5.29	28.8	5.84	30.8	6.13	32.7	6.42	36.7	7.01	40.7	7.65		
		25	20.8	4.82	24.8	5.35	28.8	5.92	30.8	6.22	32.7	6.58	36.7	7.33	40.7	8.13		
		27	20.8	4.87	24.8	5.52	28.8	6.21	30.8	6.58	32.7	6.96	36.7	7.76	40.7	8.62		
		29	20.8	5.13	24.8	5.81	28.8	6.56	30.8	6.95	32.7	7.36	36.7	8.22	40.7	9.13		

# 5 Capacity tables

## 5 - 1 Cooling Capacity Tables

RQYQ24PY1

TC: Total Capacity: kW ; PI: Power Input: kW (compressor + outdoor fan motor)

Combination (%)	Capacity index (kW)	Outdoor air temp. °CDB	Indoor air temperature: °CWB															
			14.0		16.0		18.0		19.0		20.0		22.0		24.0			
			TC	PI	TC	PI	TC	PI	TC	PI	TC	PI	TC	PI	TC	PI		
130	87.10	10	58,8	10,04	70,1	11,8	81,4	13,6	84,4	13,8	85,4	13,5	87,6	13,0	89,7	12,4		
		12	58,8	10,2	70,1	12,0	81,4	13,8	83,3	13,8	84,4	13,5	86,5	12,9	88,6	12,7		
		14	58,8	10,3	70,1	12,2	81,1	14,0	82,2	13,7	83,3	13,4	85,4	13,3	87,5	13,4		
		16	58,8	10,5	70,1	12,4	80,1	13,9	81,1	13,8	82,2	13,9	84,3	14,0	86,4	14,1		
		18	58,8	10,7	70,1	12,6	79,0	14,4	80,0	14,5	81,1	14,6	83,2	14,7	85,3	14,9		
		20	58,8	10,8	70,1	13,3	77,9	15,1	78,9	15,2	80,0	15,3	82,1	15,4	84,2	15,6		
		21	58,8	11,1	70,1	13,8	77,3	15,5	78,4	15,6	79,5	15,6	81,6	15,8	83,7	16,0		
		23	58,8	11,8	70,1	14,7	76,2	16,2	77,3	16,3	78,4	16,4	80,5	16,5	82,6	16,7		
		25	58,8	12,6	70,1	15,7	75,2	16,9	76,2	17,0	77,3	17,1	79,4	17,3	81,5	17,4		
		27	58,8	13,4	70,1	16,8	74,1	17,6	75,1	17,7	76,2	17,8	78,3	18,0	80,4	18,2		
		29	58,8	14,3	70,1	17,8	73,0	18,3	74,0	18,4	75,1	18,5	77,2	18,7	79,3	18,9		
		31	58,8	15,2	69,8	18,8	71,9	19,1	72,9	19,2	74,0	19,3	76,1	19,5	78,2	19,7		
		33	58,8	16,1	68,7	19,6	70,8	19,8	71,9	19,9	72,9	20,0	75,0	20,2	77,1	20,4		
		35	58,8	17,1	67,6	20,3	69,7	20,5	70,8	20,6	71,8	20,7	73,9	21,0	76,1	21,2		
		37	58,8	18,1	66,5	21,0	68,6	21,2	69,7	21,3	70,7	21,5	72,9	21,7	75,0	22,0		
		39	58,8	19,2	65,4	21,7	67,5	22,0	68,6	22,1	69,6	22,2	71,8	22,5	73,9	22,7		
		120	80.40	10	54,3	9,36	64,7	11,0	75,2	12,6	80,4	13,5	84,1	13,9	86,1	13,4	88,0	12,8
				12	54,3	9,49	64,7	11,1	75,2	12,8	80,4	13,7	83,0	13,8	85,0	13,3	86,9	12,8
14	54,3			9,63	64,7	11,3	75,2	13,0	80,4	13,9	81,9	13,8	83,9	13,2	85,8	13,3		
16	54,3			9,77	64,7	11,5	75,2	13,2	79,9	14,0	80,8	13,8	82,8	13,9	84,8	14,0		
18	54,3			9,92	64,7	11,7	75,2	13,6	78,8	14,4	79,7	14,5	81,7	14,6	83,7	14,8		
20	54,3			10,07	64,7	12,1	75,2	14,6	77,7	15,1	78,7	15,2	80,6	15,3	82,6	15,5		
21	54,3			10,15	64,7	12,5	75,2	15,1	77,1	15,5	78,1	15,6	80,1	15,7	82,0	15,8		
23	54,3			10,8	64,7	13,3	75,1	16,1	76,0	16,2	77,0	16,3	79,0	16,4	80,9	16,6		
25	54,3			11,5	64,7	14,2	74,0	16,8	75,0	16,9	75,9	17,0	77,9	17,1	79,8	17,3		
27	54,3			12,2	64,7	15,1	72,9	17,5	73,9	17,6	74,8	17,7	76,8	17,9	78,8	18,0		
29	54,3			13,0	64,7	16,1	71,8	18,2	72,8	18,3	73,8	18,4	75,7	18,6	77,7	18,8		
31	54,3			13,8	64,7	17,1	70,7	18,9	71,7	19,0	72,7	19,1	74,6	19,3	76,6	19,5		
33	54,3			14,6	64,7	18,2	69,6	19,7	70,6	19,8	71,6	19,9	73,5	20,1	75,5	20,3		
35	54,3			15,5	64,7	19,3	68,5	20,4	69,5	20,5	70,5	20,6	72,4	20,8	74,4	21,0		
37	54,3			16,4	64,7	20,5	67,4	21,1	68,4	21,2	69,4	21,3	71,4	21,5	73,3	21,8		
39	54,3			17,4	64,4	21,6	66,3	21,8	67,3	21,9	68,3	22,1	70,3	22,3	72,2	22,5		
110	73.70			10	49,7	8,69	59,3	10,12	68,9	11,6	73,7	12,4	78,5	13,1	84,6	13,8	86,4	13,3
				12	49,7	8,80	59,3	10,3	68,9	11,8	73,7	12,6	78,5	13,3	83,5	13,7	85,3	13,2
		14	49,7	8,93	59,3	10,4	68,9	12,0	73,7	12,8	78,5	13,6	82,4	13,6	84,2	13,2		
		16	49,7	9,06	59,3	10,6	68,9	12,2	73,7	13,0	78,5	13,8	81,3	13,8	83,1	13,9		
		18	49,7	9,19	59,3	10,7	68,9	12,4	73,7	13,3	78,4	14,4	80,2	14,5	82,0	14,6		
		20	49,7	9,33	59,3	10,9	68,9	13,1	73,7	14,2	77,3	15,1	79,1	15,2	80,9	15,4		
		21	49,7	9,40	59,3	11,2	68,9	13,5	73,7	14,7	76,8	15,5	78,6	15,6	80,4	15,7		
		23	49,7	9,79	59,3	12,0	68,9	14,4	73,7	15,7	75,7	16,2	77,5	16,3	79,3	16,4		
		25	49,7	10,4	59,3	12,8	68,9	15,4	73,7	16,8	74,6	16,9	76,4	17,0	78,2	17,2		
		27	49,7	11,1	59,3	13,6	68,9	16,4	72,6	17,5	73,5	17,6	75,3	17,7	77,1	17,9		
		29	49,7	11,7	59,3	14,4	68,9	17,4	71,5	18,2	72,4	18,3	74,2	18,4	76,0	18,6		
		31	49,7	12,4	59,3	15,3	68,9	18,6	70,4	18,9	71,3	19,0	73,1	19,2	74,9	19,3		
		33	49,7	13,2	59,3	16,3	68,4	19,5	69,3	19,6	70,2	19,7	72,0	19,9	73,8	20,1		
		35	49,7	14,0	59,3	17,3	67,4	20,2	68,3	20,3	69,2	20,4	70,9	20,6	72,7	20,8		
		37	49,7	14,8	59,3	18,3	66,3	21,0	67,2	21,1	68,1	21,2	69,9	21,4	71,6	21,6		
		39	49,7	15,6	59,3	19,4	65,2	21,7	66,1	21,8	67,0	21,9	68,8	22,1	70,6	22,3		
		100	67.00	10	45,2	8,03	53,9	9,31	62,6	10,6	67,0	11,3	71,4	12,0	80,1	13,4	84,7	13,7
				12	45,2	8,14	53,9	9,44	62,6	10,8	67,0	11,5	71,4	12,2	80,1	13,6	83,6	13,7
14	45,2			8,25	53,9	9,57	62,6	11,0	67,0	11,7	71,4	12,4	80,1	13,8	82,5	13,6		
16	45,2			8,36	53,9	9,72	62,6	11,1	67,0	11,8	71,4	12,6	79,8	14,0	81,4	13,8		
18	45,2			8,48	53,9	9,86	62,6	11,3	67,0	12,0	71,4	12,8	78,7	14,4	80,3	14,5		
20	45,2			8,60	53,9	10,02	62,6	11,6	67,0	12,6	71,4	13,6	77,6	15,1	79,3	15,2		
21	45,2			8,66	53,9	10,09	62,6	12,0	67,0	13,0	71,4	14,1	77,1	15,5	78,7	15,6		
23	45,2			8,85	53,9	10,7	62,6	12,8	67,0	13,9	71,4	15,1	76,0	16,2	77,6	16,3		
25	45,2			9,40	53,9	11,4	62,6	13,6	67,0	14,8	71,4	16,1	74,9	16,9	76,5	17,0		
27	45,2			9,97	53,9	12,1	62,6	14,5	67,0	15,8	71,4	17,2	73,8	17,6	75,4	17,7		
29	45,2			10,6	53,9	12,9	62,6	15,4	67,0	16,8	71,1	18,2	72,7	18,3	74,3	18,5		
31	45,2			11,2	53,9	13,7	62,6	16,4	67,0	17,9	70,0	18,9	71,6	19,0	73,3	19,2		
33	45,2			11,8	53,9	14,5	62,6	17,4	67,0	19,0	68,9	19,6	70,5	19,7	72,2	19,9		
35	45,2			12,5	53,9	15,4	62,6	18,5	67,0	20,2	67,8	20,3	69,4	20,5	71,1	20,6		
37	45,2			13,2	53,9	16,3	62,6	19,6	65,9	20,9	66,7	21,0	68,4	21,2	70,0	21,4		
39	45,2			14,0	53,9	17,2	62,6	20,8	64,8	21,6	65,6	21,7	67,3	21,9	68,9	22,1		

**NOTES - ANMERKUNGEN - Σημειώσεις - NOTAS - REMARQUES - NOTE - OPMERKINGEN - Примечания - NOTLAR**

- The above table shows the average value of conditions which may occur.  
 Die obige Tabelle zeigt den Durchschnittswert der Bedingungen, die auftreten können.  
 Στον παραπάνω πίνακα αναγράφεται η μέση τιμή για συνθήκες που μπορεί να προκύψουν.  
 La tabla de arriba muestra el valor medio de condiciones que pueden ocurrir.  
 Le tableau ci-dessus donne la valeur moyenne pour des conditions qui peuvent survenir.  
 La tabella in alto mostra il valore delle condizioni medie che si possono riscontrare.  
 De tabel hierboven geeft de gemiddelde waarde aan van situaties die kunnen voorvallen.  
 Таблица расположенная выше показывает среднее значение условий, которые могут наступить.  
 Yukarıdaki tablo meydana gelebilecek kobluların ortalama değerini göstermektedir.

# 5 Capacity tables

## 5 - 1 Cooling Capacity Tables

5

RQYQ24PY1

TC: Total Capacity: kW ; PI: Power Input: kW (compressor + outdoor fan motor)

Combination (%)	Capacity index (kW)	Outdoor air temp. °CDB	Indoor air temperature: °CWB															
			14.0		16.0		18.0		19.0		20.0		22.0		24.0			
			TC	PI	TC	PI	TC	PI	TC	PI	TC	PI	TC	PI	TC	PI		
90	60.30	10	40.7	7.40	48.5	8.51	56.4	9.67	60.3	10.3	64.2	10.9	72.1	12.1	79.9	13.4		
		12	40.7	7.49	48.5	8.63	56.4	9.81	60.3	10.4	64.2	11.0	72.1	12.3	79.9	13.6		
		14	40.7	7.59	48.5	8.74	56.4	9.96	60.3	10.6	64.2	11.2	72.1	12.5	79.9	13.8		
		16	40.7	7.69	48.5	8.87	56.4	10.11	60.3	10.7	64.2	11.4	72.1	12.7	79.8	14.0		
		18	40.7	7.79	48.5	9.00	56.4	10.3	60.3	10.9	64.2	11.6	72.1	12.9	78.7	14.4		
		20	40.7	7.89	48.5	9.13	56.4	10.4	60.3	11.1	64.2	12.0	72.1	13.8	77.6	15.1		
		21	40.7	7.95	48.5	9.20	56.4	10.6	60.3	11.5	64.2	12.4	72.1	14.3	77.0	15.5		
		23	40.7	8.06	48.5	9.54	56.4	11.3	60.3	12.2	64.2	13.2	72.1	15.3	76.0	16.2		
		25	40.7	8.45	48.5	10.14	56.4	12.0	60.3	13.0	64.2	14.1	72.1	16.3	74.9	16.9		
		27	40.7	8.95	48.5	10.8	56.4	12.8	60.3	13.8	64.2	15.0	72.1	17.4	73.8	17.6		
		29	40.7	9.48	48.5	11.4	56.4	13.6	60.3	14.7	64.2	15.9	71.2	18.2	72.7	18.3		
		31	40.7	10.03	48.5	12.1	56.4	14.4	60.3	15.6	64.2	16.9	70.1	18.9	71.6	19.0		
		33	40.7	10.60	48.5	12.8	56.4	15.3	60.3	16.6	64.2	18.0	69.0	19.6	70.5	19.7		
		35	40.7	11.2	48.5	13.6	56.4	16.2	60.3	17.6	64.2	19.1	67.9	20.3	69.4	20.5		
		37	40.7	11.8	48.5	14.4	56.4	17.2	60.3	18.7	64.2	20.3	66.9	21.0	68.3	21.2		
		39	40.7	12.5	48.5	15.2	56.4	18.2	60.3	19.8	64.2	21.5	65.8	21.7	67.2	21.9		
		80	53.60	10	36.2	6.79	43.1	7.74	50.1	8.74	53.6	9.26	57.1	9.78	64.1	10.9	71.0	12.0
				12	36.2	6.87	43.1	7.84	50.1	8.86	53.6	9.39	57.1	9.92	64.1	11.0	71.0	12.1
14	36.2			6.95	43.1	7.94	50.1	8.98	53.6	9.52	57.1	10.07	64.1	11.2	71.0	12.3		
16	36.2			7.03	43.1	8.05	50.1	9.11	53.6	9.66	57.1	10.2	64.1	11.4	71.0	12.5		
18	36.2			7.12	43.1	8.16	50.1	9.25	53.6	9.81	57.1	10.4	64.1	11.5	71.0	12.7		
20	36.2			7.21	43.1	8.27	50.1	9.39	53.6	9.96	57.1	10.5	64.1	11.9	71.0	13.6		
21	36.2			7.26	43.1	8.33	50.1	9.46	53.6	10.04	57.1	10.7	64.1	12.3	71.0	14.0		
23	36.2			7.36	43.1	8.45	50.1	9.87	53.6	10.6	57.1	11.4	64.1	13.1	71.0	15.0		
25	36.2			7.56	43.1	8.96	50.1	10.5	53.6	11.3	57.1	12.2	64.1	14.0	71.0	16.0		
27	36.2			8.00	43.1	9.50	50.1	11.2	53.6	12.0	57.1	13.0	64.1	14.9	71.0	17.0		
29	36.2			8.46	43.1	10.06	50.1	11.8	53.6	12.8	57.1	13.8	64.1	15.9	71.0	18.2		
31	36.2			8.93	43.1	10.6	50.1	12.5	53.6	13.6	57.1	14.6	64.1	16.9	69.9	18.9		
33	36.2			9.43	43.1	11.3	50.1	13.3	53.6	14.4	57.1	15.5	64.1	17.9	68.8	19.6		
35	36.2			9.95	43.1	11.9	50.1	14.1	53.6	15.2	57.1	16.5	64.1	19.0	67.8	20.3		
37	36.2			10.49	43.1	12.6	50.1	14.9	53.6	16.1	57.1	17.4	64.1	20.2	66.7	21.0		
39	36.2			11.1	43.1	13.3	50.1	15.8	53.6	17.1	57.1	18.5	64.1	21.4	65.6	21.7		
70	46.90			10	31.7	6.20	37.8	7.00	43.9	7.84	46.9	8.27	49.9	8.72	56.0	9.62	62.1	10.6
				12	31.7	6.27	37.8	7.08	43.9	7.94	46.9	8.38	49.9	8.84	56.0	9.76	62.1	10.7
		14	31.7	6.34	37.8	7.17	43.9	8.05	46.9	8.50	49.9	8.96	56.0	9.91	62.1	10.9		
		16	31.7	6.41	37.8	7.26	43.9	8.15	46.9	8.62	49.9	9.09	56.0	10.05	62.1	11.0		
		18	31.7	6.48	37.8	7.35	43.9	8.27	46.9	8.74	49.9	9.22	56.0	10.2	62.1	11.2		
		20	31.7	6.56	37.8	7.45	43.9	8.38	46.9	8.87	49.9	9.36	56.0	10.4	62.1	11.5		
		21	31.7	6.60	37.8	7.50	43.9	8.44	46.9	8.93	49.9	9.43	56.0	10.5	62.1	11.9		
		23	31.7	6.68	37.8	7.60	43.9	8.58	46.9	9.20	49.9	9.84	56.0	11.2	62.1	12.7		
		25	31.7	6.76	37.8	7.86	43.9	9.11	46.9	9.77	49.9	10.5	56.0	11.9	62.1	13.5		
		27	31.7	7.11	37.8	8.33	43.9	9.66	46.9	10.37	49.9	11.1	56.0	12.7	62.1	14.4		
		29	31.7	7.51	37.8	8.81	43.9	10.23	46.9	11.0	49.9	11.8	56.0	13.5	62.1	15.3		
		31	31.7	7.92	37.8	9.31	43.9	10.8	46.9	11.6	49.9	12.5	56.0	14.3	62.1	16.2		
		33	31.7	8.34	37.8	9.83	43.9	11.5	46.9	12.3	49.9	13.2	56.0	15.2	62.1	17.3		
		35	31.7	8.79	37.8	10.37	43.9	12.1	46.9	13.0	49.9	14.0	56.0	16.1	62.1	18.3		
		37	31.7	9.25	37.8	10.9	43.9	12.8	46.9	13.8	49.9	14.8	56.0	17.1	62.1	19.4		
		39	31.7	9.73	37.8	11.5	43.9	13.5	46.9	14.6	49.9	15.7	56.0	18.1	62.1	20.6		
		60	40.20	10	27.1	5.64	32.4	6.29	37.6	6.98	40.2	7.33	42.8	7.69	48.0	8.44	53.3	9.21
				12	27.1	5.70	32.4	6.36	37.6	7.06	40.2	7.42	42.8	7.79	48.0	8.55	53.3	9.34
14	27.1			5.75	32.4	6.43	37.6	7.15	40.2	7.52	42.8	7.89	48.0	8.67	53.3	9.47		
16	27.1			5.81	32.4	6.50	37.6	7.23	40.2	7.61	42.8	8.00	48.0	8.79	53.3	9.61		
18	27.1			5.87	32.4	6.58	37.6	7.33	40.2	7.71	42.8	8.11	48.0	8.92	53.3	9.76		
20	27.1			5.93	32.4	6.66	37.6	7.42	40.2	7.82	42.8	8.22	48.0	9.05	53.3	9.91		
21	27.1			5.96	32.4	6.70	37.6	7.47	40.2	7.87	42.8	8.28	48.0	9.12	53.3	9.98		
23	27.1			6.03	32.4	6.78	37.6	7.57	40.2	7.98	42.8	8.40	48.0	9.43	53.3	10.6		
25	27.1			6.10	32.4	6.87	37.6	7.83	40.2	8.35	42.8	8.89	48.0	10.03	53.3	11.2		
27	27.1			6.29	32.4	7.25	37.6	8.29	40.2	8.85	42.8	9.42	48.0	10.6	53.3	12.0		
29	27.1			6.63	32.4	7.65	37.6	8.77	40.2	9.36	42.8	9.98	48.0	11.3	53.3	12.7		
31	27.1			6.98	32.4	8.07	37.6	9.27	40.2	9.90	42.8	10.6	48.0	12.0	53.3	13.5		
33	27.1			7.34	32.4	8.51	37.6	9.79	40.2	10.47	42.8	11.2	48.0	12.7	53.3	14.3		
35	27.1			7.72	32.4	8.96	37.6	10.33	40.2	11.1	42.8	11.8	48.0	13.4	53.3	15.1		
37	27.1			8.11	32.4	9.44	37.6	10.9	40.2	11.7	42.8	12.5	48.0	14.2	53.3	16.0		
39	27.1			8.52	32.4	9.93	37.6	11.5	40.2	12.3	42.8	13.2	48.0	15.0	53.3	17.0		
50	33.50			10	22.6	5.11	27.0	5.62	31.3	6.16	33.5	6.44	35.7	6.72	40.0	7.31	44.4	7.92
				12	22.6	5.16	27.0	5.68	31.3	6.23	33.5	6.51	35.7	6.80	40.0	7.40	44.4	8.02
		14	22.6	5.20	27.0	5.73	31.3	6.29	33.5	6.58	35.7	6.88	40.0	7.49	44.4	8.12		
		16	22.6	5.24	27.0	5.79	31.3	6.36	33.5	6.66	35.7	6.96	40.0	7.59	44.4	8.24		
		18	22.6	5.29	27.0	5.85	31.3	6.44	33.5	6.74	35.7	7.05	40.0	7.69	44.4	8.35		
		20	22.6	5.34	27.0	5.91	31.3	6.51	33.5	6.82	35.7	7.14	40.0	7.79	44.4	8.47		
		21	22.6	5.37	27.0	5.94	31.3	6.55	33.5	6.86	35.7	7.19	40.0	7.85	44.4	8.53		
		23	22.6	5.42	27.0	6.01	31.3	6.63	33.5	6.95	35.7	7.28	40.0	7.96	44.4	8.69		
		25	22.6	5.47	27.0	6.08	31.3	6.71	33.5	7.06	35.7	7.47	40.0	8.32	44.4	9.22		
		27	22.6	5.53	27.0	6.26	31.3	7.05	33.5	7.47	35.7	7.90	40.0	8.81	44.4	9.78		
		29	22.6	5.82	27.0	6.60	31.3	7.44	33.5	7.89	35.7	8.35	40.0	9.33	44.4	10.37		
		31	22.6</															



# 5 Capacity tables

## 5 - 1 Cooling Capacity Tables

RQYQ26PY1			TC: Total Capacity: kW ; PI: Power Input: kW (compressor + outdoor fan motor)															
Combination (%)	Capacity index (kW)	Outdoor air temp. °CDB	Indoor air temperature: °CWB															
			14.0		16.0		18.0		19.0		20.0		22.0		24.0			
			TC	PI	TC	PI	TC	PI	TC	PI	TC	PI	TC	PI	TC	PI		
130	94.90	10	64.0	10.6	76.4	12.4	88.7	14.4	91.9	14.6	93.1	14.3	95.4	13.7	97.7	13.1		
		12	64.0	10.7	76.4	12.6	88.7	14.6	90.8	14.5	91.9	14.2	94.2	13.6	96.5	13.4		
		14	64.0	10.9	76.4	12.8	88.4	14.7	89.6	14.4	90.7	14.1	93.0	14.0	95.3	14.1		
		16	64.0	11.1	76.4	13.0	87.2	14.7	88.4	14.6	89.5	14.6	91.8	14.8	94.2	14.9		
		18	64.0	11.2	76.4	13.3	86.0	15.2	87.2	15.3	88.3	15.4	90.7	15.5	93.0	15.7		
		20	64.0	11.4	76.4	14.1	84.8	16.0	86.0	16.0	87.2	16.1	89.5	16.3	91.8	16.4		
		21	64.0	11.7	76.4	14.5	84.3	16.3	85.4	16.4	86.6	16.5	88.9	16.7	91.2	16.8		
		23	64.0	12.5	76.4	15.5	83.1	17.1	84.2	17.2	85.4	17.3	87.7	17.4	90.0	17.6		
		25	64.0	13.3	76.4	16.6	81.9	17.8	83.0	17.9	84.2	18.0	86.5	18.2	88.8	18.4		
		27	64.0	14.2	76.4	17.7	80.7	18.6	81.8	18.7	83.0	18.8	85.3	19.0	87.6	19.2		
		29	64.0	15.0	76.4	18.8	79.5	19.3	80.7	19.4	81.8	19.5	84.1	19.7	86.4	20.0		
		31	64.0	16.0	76.0	19.9	78.3	20.1	79.5	20.2	80.6	20.3	82.9	20.5	85.2	20.7		
		33	64.0	17.0	74.8	20.6	77.1	20.8	78.3	21.0	79.4	21.1	81.7	21.3	84.1	21.5		
		35	64.0	18.0	73.6	21.4	75.9	21.6	77.1	21.7	78.3	21.9	80.6	22.1	82.9	22.3		
		37	64.0	19.1	72.4	22.1	74.8	22.4	75.9	22.5	77.1	22.6	79.4	22.9	81.7	23.2		
		39	64.0	20.2	71.3	22.9	73.6	23.2	74.7	23.3	75.9	23.4	78.2	23.7	80.5	24.0		
		120	87.60	10	59.1	9.9	70.5	11.6	81.9	13.3	87.6	14.2	91.6	14.7	93.8	14.1	95.9	13.5
				12	59.1	10.0	70.5	11.7	81.9	13.5	87.6	14.4	90.5	14.6	92.6	14.0	94.7	13.5
14	59.1			10.1	70.5	11.9	81.9	13.7	87.6	14.6	89.3	14.5	91.4	13.9	93.5	14.0		
16	59.1			10.3	70.5	12.1	81.9	13.9	87.0	14.7	88.1	14.5	90.2	14.7	92.3	14.8		
18	59.1			10.5	70.5	12.3	81.9	14.4	85.8	15.2	86.9	15.3	89.0	15.4	91.2	15.6		
20	59.1			10.6	70.5	12.7	81.9	15.4	84.6	16.0	85.7	16.0	87.8	16.2	90.0	16.3		
21	59.1			10.7	70.5	13.2	81.9	15.9	84.0	16.3	85.1	16.4	87.2	16.5	89.4	16.7		
23	59.1			11.4	70.5	14.0	81.8	17.0	82.9	17.1	83.9	17.1	86.1	17.3	88.2	17.5		
25	59.1			12.1	70.5	15.0	80.6	17.7	81.7	17.8	82.7	17.9	84.9	18.1	87.0	18.2		
27	59.1			12.9	70.5	15.9	79.4	18.5	80.5	18.6	81.5	18.7	83.7	18.8	85.8	19.0		
29	59.1			13.7	70.5	17.0	78.2	19.2	79.3	19.3	80.4	19.4	82.5	19.6	84.6	19.8		
31	59.1			14.5	70.5	18.0	77.0	20.0	78.1	20.1	79.2	20.2	81.3	20.4	83.4	20.6		
33	59.1			15.4	70.5	19.2	75.9	20.7	76.9	20.8	78.0	20.9	80.1	21.1	82.2	21.4		
35	59.1			16.3	70.5	20.4	74.7	21.5	75.7	21.6	76.8	21.7	78.9	21.9	81.1	22.2		
37	59.1			17.3	70.5	21.6	73.5	22.2	74.5	22.4	75.6	22.5	77.7	22.7	79.9	23.0		
39	59.1			18.3	70.2	22.7	72.3	23.0	73.4	23.1	74.4	23.3	76.6	23.5	78.7	23.8		
110	80.30			10	54.2	9.16	64.6	10.7	75.1	12.2	80.3	13.1	85.5	13.9	92.1	14.5	94.1	14.0
				12	54.2	9.28	64.6	10.8	75.1	12.4	80.3	13.3	85.5	14.1	91.0	14.5	92.9	13.9
		14	54.2	9.41	64.6	11.0	75.1	12.6	80.3	13.5	85.5	14.3	89.8	14.4	91.7	13.9		
		16	54.2	9.55	64.6	11.2	75.1	12.8	80.3	13.7	85.5	14.5	88.6	14.6	90.5	14.7		
		18	54.2	9.69	64.6	11.3	75.1	13.0	80.3	14.0	85.4	15.2	87.4	15.3	89.3	15.4		
		20	54.2	9.8	64.6	11.5	75.1	13.8	80.3	15.0	84.2	15.9	86.2	16.1	88.2	16.2		
		21	54.2	9.9	64.6	11.8	75.1	14.2	80.3	15.5	83.7	16.3	85.6	16.4	87.6	16.6		
		23	54.2	10.3	64.6	12.6	75.1	15.2	80.3	16.6	82.5	17.0	84.4	17.2	86.4	17.3		
		25	54.2	11.0	64.6	13.5	75.1	16.2	80.3	17.7	81.3	17.8	83.2	17.9	85.2	18.1		
		27	54.2	11.7	64.6	14.3	75.1	17.3	79.1	18.4	80.1	18.5	82.0	18.7	84.0	18.9		
		29	54.2	12.4	64.6	15.2	75.1	18.4	77.9	19.2	78.9	19.3	80.9	19.5	82.8	19.6		
		31	54.2	13.1	64.6	16.2	75.1	19.6	76.7	19.9	77.7	20.0	79.7	20.2	81.6	20.4		
		33	54.2	13.9	64.6	17.2	74.6	20.6	75.6	20.7	76.5	20.8	78.5	21.0	80.4	21.2		
		35	54.2	14.7	64.6	18.2	73.4	21.3	74.4	21.4	75.3	21.5	77.3	21.8	79.3	22.0		
		37	54.2	15.6	64.6	19.3	72.2	22.1	73.2	22.2	74.2	22.3	76.1	22.5	78.1	22.7		
		39	54.2	16.5	64.6	20.5	71.0	22.8	72.0	23.0	73.0	23.1	74.9	23.3	76.9	23.5		
		100	73.00	10	49.3	8.47	58.8	9.8	68.3	11.2	73.0	11.9	77.7	12.7	87.2	14.1	92.3	14.5
				12	49.3	8.58	58.8	10.0	68.3	11.4	73.0	12.1	77.7	12.9	87.2	14.3	91.1	14.4
14	49.3			8.70	58.8	10.1	68.3	11.6	73.0	12.3	77.7	13.1	87.2	14.6	89.9	14.3		
16	49.3			8.82	58.8	10.2	68.3	11.7	73.0	12.5	77.7	13.3	86.9	14.7	88.7	14.6		
18	49.3			8.94	58.8	10.4	68.3	11.9	73.0	12.7	77.7	13.5	85.8	15.2	87.5	15.3		
20	49.3			9.07	58.8	10.6	68.3	12.2	73.0	13.3	77.7	14.4	84.6	15.9	86.3	16.1		
21	49.3			9.13	58.8	10.6	68.3	12.6	73.0	13.7	77.7	14.9	84.0	16.3	85.8	16.4		
23	49.3			9.33	58.8	11.3	68.3	13.5	73.0	14.7	77.7	15.9	82.8	17.1	84.6	17.2		
25	49.3			9.9	58.8	12.0	68.3	14.4	73.0	15.6	77.7	17.0	81.6	17.8	83.4	17.9		
27	49.3			10.5	58.8	12.8	68.3	15.3	73.0	16.7	77.7	18.1	80.4	18.6	82.2	18.7		
29	49.3			11.1	58.8	13.6	68.3	16.3	73.0	17.7	77.5	19.1	79.2	19.3	81.0	19.5		
31	49.3			11.8	58.8	14.4	68.3	17.3	73.0	18.9	76.3	19.9	78.0	20.1	79.8	20.2		
33	49.3			12.5	58.8	15.3	68.3	18.4	73.0	20.0	75.1	20.6	76.9	20.8	78.6	21.0		
35	49.3			13.2	58.8	16.2	68.3	19.5	73.0	21.3	73.9	21.4	75.7	21.6	77.4	21.8		
37	49.3			14.0	58.8	17.1	68.3	20.7	71.8	22.1	72.7	22.1	74.5	22.3	76.3	22.5		
39	49.3			14.8	58.8	18.2	68.3	22.0	70.6	22.8	71.5	22.9	73.3	23.1	75.1	23.3		

**NOTES - ANMERKUNGEN - Σημειώσεις - NOTAS - REMARQUES - NOTE - OPMERKINGEN - Примечания - NOTLAR**

- The above table shows the average value of conditions which may occur.  
 Die obige Tabelle zeigt den Durchschnittswert der Bedingungen, die auftreten können.  
 Στον παραπάνω πίνακα αναγράφεται η μέση τιμή για συνθήκες που μπορεί να προκύψουν.  
 La tabla de arriba muestra el valor medio de condiciones que pueden ocurrir.  
 Le tableau ci-dessus donne la valeur moyenne pour des conditions qui peuvent survenir.  
 La tabella in alto mostra il valore delle condizioni medie che si possono riscontrare.  
 De tabel hierboven geeft de gemiddelde waarde aan van situaties die kunnen voorvallen.  
 Таблица расположенная выше показывает среднее значение условий, которые могут наступить.  
 Yukarıdaki tablo meydana gelebilecek kobluların ortalama değerini göstermektedir.

# 5 Capacity tables

## 5 - 1 Cooling Capacity Tables

5

RQYQ26PY1

TC: Total Capacity: kW ; PI: Power Input: kW (compressor + outdoor fan motor)

Combination (%)	Capacity index (kW)	Outdoor air temp. °CDB	Indoor air temperature: °CWB													
			14.0		16.0		18.0		19.0		20.0		22.0		24.0	
			TC	PI	TC	PI	TC	PI	TC	PI	TC	PI	TC	PI	TC	PI
90	65.70	10	44.3	7.80	52.9	8.97	61.4	10.2	65.7	10.8	70.0	11.5	78.5	12.8	87.1	14.1
		12	44.3	7.90	52.9	9.10	61.4	10.3	65.7	11.0	70.0	11.6	78.5	13.0	87.1	14.3
		14	44.3	8.00	52.9	9.22	61.4	10.5	65.7	11.2	70.0	11.8	78.5	13.2	87.1	14.5
		16	44.3	8.10	52.9	9.35	61.4	10.7	65.7	11.3	70.0	12.0	78.5	13.4	86.9	14.7
		18	44.3	8.21	52.9	9.49	61.4	10.8	65.7	11.5	70.0	12.2	78.5	13.6	85.7	15.2
		20	44.3	8.32	52.9	9.63	61.4	11.0	65.7	11.7	70.0	12.6	78.5	14.6	84.5	15.9
		21	44.3	8.38	52.9	9.70	61.4	11.2	65.7	12.1	70.0	13.0	78.5	15.1	83.9	16.3
		23	44.3	8.50	52.9	10.1	61.4	11.9	65.7	12.9	70.0	13.9	78.5	16.1	82.8	17.1
		25	44.3	8.91	52.9	10.7	61.4	12.7	65.7	13.7	70.0	14.8	78.5	17.2	81.6	17.8
		27	44.3	9.44	52.9	11.3	61.4	13.5	65.7	14.6	70.0	15.8	78.5	18.3	80.4	18.6
		29	44.3	9.99	52.9	12.0	61.4	14.3	65.7	15.5	70.0	16.8	77.6	19.2	79.2	19.3
		31	44.3	10.6	52.9	12.8	61.4	15.2	65.7	16.5	70.0	17.9	76.4	19.9	78.0	20.1
		33	44.3	11.2	52.9	13.5	61.4	16.1	65.7	17.5	70.0	19.0	75.2	20.7	76.8	20.8
		35	44.3	11.8	52.9	14.3	61.4	17.1	65.7	18.6	70.0	20.1	74.0	21.4	75.6	21.6
		37	44.3	12.5	52.9	15.1	61.4	18.1	65.7	19.7	70.0	21.4	72.8	22.2	74.4	22.3
		39	44.3	13.2	52.9	16.0	61.4	19.2	65.7	20.9	70.0	22.7	71.7	22.9	73.3	23.1
		80	58.40	10	39.4	7.16	47.0	8.16	54.6	9.22	58.4	9.76	62.2	10.3	69.8	11.4
12	39.4			7.24	47.0	8.27	54.6	9.34	58.4	9.9	62.2	10.5	69.8	11.6	77.4	12.8
14	39.4			7.33	47.0	8.37	54.6	9.47	58.4	10.0	62.2	10.6	69.8	11.8	77.4	13.0
16	39.4			7.42	47.0	8.49	54.6	9.61	58.4	10.2	62.2	10.8	69.8	12.0	77.4	13.2
18	39.4			7.51	47.0	8.60	54.6	9.75	58.4	10.3	62.2	10.9	69.8	12.2	77.4	13.4
20	39.4			7.61	47.0	8.72	54.6	9.9	58.4	10.5	62.2	11.1	69.8	12.6	77.4	14.3
21	39.4			7.66	47.0	8.79	54.6	10.0	58.4	10.6	62.2	11.3	69.8	13.0	77.4	14.8
23	39.4			7.76	47.0	8.92	54.6	10.4	58.4	11.2	62.2	12.1	69.8	13.9	77.4	15.8
25	39.4			7.97	47.0	9.45	54.6	11.1	58.4	11.9	62.2	12.8	69.8	14.8	77.4	16.9
27	39.4			8.44	47.0	10.0	54.6	11.8	58.4	12.7	62.2	13.7	69.8	15.7	77.4	18.0
29	39.4			8.92	47.0	10.6	54.6	12.5	58.4	13.5	62.2	14.5	69.8	16.7	77.4	19.1
31	39.4			9.42	47.0	11.2	54.6	13.2	58.4	14.3	62.2	15.4	69.8	17.8	76.2	19.9
33	39.4			9.94	47.0	11.9	54.6	14.0	58.4	15.2	62.2	16.4	69.8	18.9	75.0	20.6
35	39.4			10.5	47.0	12.6	54.6	14.8	58.4	16.1	62.2	17.4	69.8	20.1	73.8	21.4
37	39.4			11.1	47.0	13.3	54.6	15.7	58.4	17.0	62.2	18.4	69.8	21.3	72.6	22.1
39	39.4			11.7	47.0	14.0	54.6	16.6	58.4	18.0	62.2	19.5	69.8	22.6	71.4	22.9
70	51.10			10	34.5	6.54	41.1	7.38	47.8	8.27	51.1	8.72	54.4	9.19	61.1	10.1
		12	34.5	6.61	41.1	7.47	47.8	8.37	51.1	8.84	54.4	9.32	61.1	10.3	67.7	11.3
		14	34.5	6.68	41.1	7.56	47.8	8.48	51.1	8.96	54.4	9.45	61.1	10.4	67.7	11.5
		16	34.5	6.76	41.1	7.65	47.8	8.60	51.1	9.09	54.4	9.58	61.1	10.6	67.7	11.6
		18	34.5	6.83	41.1	7.75	47.8	8.72	51.1	9.22	54.4	9.72	61.1	10.8	67.7	11.8
		20	34.5	6.92	41.1	7.85	47.8	8.84	51.1	9.35	54.4	9.9	61.1	10.9	67.7	12.1
		21	34.5	6.96	41.1	7.91	47.8	8.90	51.1	9.42	54.4	9.9	61.1	11.1	67.7	12.5
		23	34.5	7.04	41.1	8.01	47.8	9.04	51.1	9.70	54.4	10.4	61.1	11.8	67.7	13.4
		25	34.5	7.13	41.1	8.29	47.8	9.60	51.1	10.3	54.4	11.0	61.1	12.6	67.7	14.2
		27	34.5	7.50	41.1	8.78	47.8	10.2	51.1	10.9	54.4	11.7	61.1	13.4	67.7	15.2
		29	34.5	7.92	41.1	9.29	47.8	10.8	51.1	11.6	54.4	12.4	61.1	14.2	67.7	16.1
		31	34.5	8.35	41.1	9.81	47.8	11.4	51.1	12.3	54.4	13.2	61.1	15.1	67.7	17.1
		33	34.5	8.80	41.1	10.4	47.8	12.1	51.1	13.0	54.4	14.0	61.1	16.0	67.7	18.2
		35	34.5	9.27	41.1	10.9	47.8	12.8	51.1	13.8	54.4	14.8	61.1	17.0	67.7	19.3
		37	34.5	9.75	41.1	11.5	47.8	13.5	51.1	14.6	54.4	15.6	61.1	18.0	67.7	20.5
		39	34.5	10.26	41.1	12.2	47.8	14.3	51.1	15.4	54.4	16.6	61.1	19.0	67.7	21.7
		60	43.80	10	29.6	5.95	35.3	6.64	41.0	7.36	43.8	7.73	46.6	8.11	52.3	8.90
12	29.6			6.01	35.3	6.71	41.0	7.45	43.8	7.83	46.6	8.22	52.3	9.02	58.0	9.8
14	29.6			6.07	35.3	6.78	41.0	7.54	43.8	7.93	46.6	8.32	52.3	9.14	58.0	10.0
16	29.6			6.13	35.3	6.86	41.0	7.63	43.8	8.03	46.6	8.43	52.3	9.27	58.0	10.1
18	29.6			6.19	35.3	6.94	41.0	7.73	43.8	8.13	46.6	8.55	52.3	9.40	58.0	10.3
20	29.6			6.26	35.3	7.02	41.0	7.83	43.8	8.24	46.6	8.67	52.3	9.54	58.0	10.4
21	29.6			6.29	35.3	7.06	41.0	7.88	43.8	8.30	46.6	8.73	52.3	9.62	58.0	10.5
23	29.6			6.36	35.3	7.15	41.0	7.99	43.8	8.42	46.6	8.86	52.3	9.9	58.0	11.1
25	29.6			6.43	35.3	7.24	41.0	8.26	43.8	8.80	46.6	9.37	52.3	10.6	58.0	11.9
27	29.6			6.63	35.3	7.64	41.0	8.74	43.8	9.33	46.6	9.94	52.3	11.2	58.0	12.6
29	29.6			6.99	35.3	8.07	41.0	9.25	43.8	9.87	46.6	10.5	52.3	11.9	58.0	13.4
31	29.6			7.36	35.3	8.51	41.0	9.77	43.8	10.4	46.6	11.1	52.3	12.6	58.0	14.2
33	29.6			7.74	35.3	8.97	41.0	10.3	43.8	11.0	46.6	11.8	52.3	13.4	58.0	15.1
35	29.6			8.14	35.3	9.45	41.0	10.9	43.8	11.7	46.6	12.5	52.3	14.1	58.0	16.0
37	29.6			8.55	35.3	9.95	41.0	11.5	43.8	12.3	46.6	13.2	52.3	15.0	58.0	16.9
39	29.6			8.98	35.3	10.5	41.0	12.1	43.8	13.0	46.6	13.9	52.3	15.8	58.0	17.9
50	36.50			10	24.6	5.39	29.4	5.93	34.1	6.50	36.5	6.79	38.9	7.09	43.6	7.71
		12	24.6	5.44	29.4	5.99	34.1	6.57	36.5	6.87	38.9	7.17	43.6	7.80	48.4	8.46
		14	24.6	5.48	29.4	6.04	34.1	6.64	36.5	6.94	38.9	7.26	43.6	7.90	48.4	8.57
		16	24.6	5.53	29.4	6.10	34.1	6.71	36.5	7.02	38.9	7.34	43.6	8.00	48.4	8.68
		18	24.6	5.58	29.4	6.17	34.1	6.79	36.5	7.11	38.9	7.43	43.6	8.11	48.4	8.80
		20	24.6	5.63	29.4	6.23	34.1	6.87	36.5	7.19	38.9	7.53	43.6	8.22	48.4	8.93
		21	24.6	5.66	29.4	6.27	34.1	6.91	36.5	7.24	38.9	7.58	43.6	8.27	48.4	9.00
		23	24.6	5.71	29.4	6.34	34.1	6.99	36.5	7.33	38.9	7.68	43.6	8.39	48.4	9.16
		25	24.6	5.77	29.4	6.41	34.1	7.08	36.5	7.45	38.9	7.77	43.6	8.77	48.4	9.72
		27	24.6	5.83	29.4	6.60	34.1	7.43	36.5	7.87	38.9	8.33	43.6	9.29	48.4	10.3
		29	24.6	6.14	29.4	6.96	34.1	7.85	36.5	8.32	38.9	8.80	43.6	9.83	48.4	10.9
		31	24.6	6.45												

# 5 Capacity tables

## 5 - 1 Cooling Capacity Tables

RQYQ28PY1

TC: Total Capacity: kW ; PI: Power Input: kW (compressor + outdoor fan motor)

Combination (%)	Capacity index (kW)	Outdoor air temp. °CDB	Indoor air temperature: °CWB															
			14.0		16.0		18.0		19.0		20.0		22.0		24.0			
			TC	PI	TC	PI	TC	PI	TC	PI	TC	PI	TC	PI	TC	PI		
130	102.05	10	68.9	11.8	82.1	13.9	95.4	16.0	98.9	16.2	100	15.9	103	15.2	105	14.5		
		12	68.9	12.0	82.1	14.1	95.4	16.2	97.6	16.1	98.8	15.8	101	15.1	104	14.9		
		14	68.9	12.1	82.1	14.3	95.1	16.4	96.3	16.1	97.6	15.7	100	15.6	103	15.7		
		16	68.9	12.3	82.1	14.5	93.8	16.3	95.0	16.2	96.3	16.3	98.8	16.4	101	16.6		
		18	68.9	12.5	82.1	14.7	92.5	16.9	93.8	17.0	95.0	17.1	97.5	17.3	100	17.4		
		20	68.9	12.7	82.1	15.7	91.2	17.8	92.5	17.9	93.7	17.9	96.2	18.1	98.7	18.3		
		21	68.9	13.0	82.1	16.2	90.6	18.2	91.8	18.3	93.1	18.4	95.6	18.5	98.1	18.7		
		23	68.9	13.9	82.1	17.3	89.3	19.0	90.6	19.1	91.8	19.2	94.3	19.4	96.8	19.6		
		25	68.9	14.8	82.1	18.4	88.0	19.8	89.3	19.9	90.5	20.0	93.0	20.2	95.5	20.5		
		27	68.9	15.8	82.1	19.7	86.8	20.7	88.0	20.8	89.3	20.9	91.7	21.1	94.2	21.3		
		29	68.9	16.7	82.1	20.9	85.5	21.5	86.7	21.6	88.0	21.7	90.5	22.0	92.9	22.2		
		31	68.9	17.8	81.7	22.1	84.2	22.4	85.5	22.5	86.7	22.6	89.2	22.8	91.7	23.1		
		33	68.9	18.9	80.5	22.9	82.9	23.2	84.2	23.3	85.4	23.5	87.9	23.7	90.4	24.0		
		35	68.9	20.0	79.2	23.8	81.7	24.0	82.9	24.2	84.1	24.3	86.6	24.6	89.1	24.9		
		37	68.9	21.2	77.9	24.6	80.4	24.9	81.6	25.0	82.9	25.2	85.4	25.5	87.8	25.8		
		39	68.9	22.5	76.6	25.5	79.1	25.8	80.4	25.9	81.6	26.1	84.1	26.4	86.6	26.7		
		120	94.20	10	63.6	11.0	75.8	12.9	88.1	14.8	94.2	15.8	98.5	16.3	101	15.7	103	15.1
				12	63.6	11.1	75.8	13.0	88.1	15.0	94.2	16.0	97.3	16.2	99.6	15.6	102	15.0
				14	63.6	11.3	75.8	13.2	88.1	15.3	94.2	16.3	96.0	16.1	98.3	15.5	101	15.6
16	63.6			11.5	75.8	13.5	88.1	15.5	93.6	16.4	94.7	16.2	97.0	16.3	99.3	16.5		
18	63.6			11.6	75.8	13.7	88.1	16.0	92.3	16.9	93.4	17.0	95.7	17.2	98.0	17.3		
20	63.6			11.8	75.8	14.2	88.1	17.1	91.0	17.7	92.2	17.8	94.5	18.0	96.7	18.2		
21	63.6			11.9	75.8	14.6	88.1	17.7	90.4	18.2	91.5	18.2	93.8	18.4	96.1	18.6		
23	63.6			12.7	75.8	15.6	88.0	18.9	89.1	19.0	90.2	19.1	92.5	19.3	94.8	19.4		
25	63.6			13.5	75.8	16.7	86.7	19.7	87.8	19.8	89.0	19.9	91.3	20.1	93.6	20.3		
27	63.6			14.3	75.8	17.7	85.4	20.6	86.5	20.7	87.7	20.8	90.0	21.0	92.3	21.2		
29	63.6			15.2	75.8	18.9	84.1	21.4	85.3	21.5	86.4	21.6	88.7	21.8	91.0	22.0		
31	63.6			16.1	75.8	20.1	82.8	22.2	84.0	22.3	85.1	22.4	87.4	22.7	89.7	22.9		
33	63.6			17.1	75.8	21.3	81.6	23.1	82.7	23.2	83.9	23.3	86.2	23.5	88.4	23.8		
35	63.6			18.1	75.8	22.6	80.3	23.9	81.4	24.0	82.6	24.1	84.9	24.4	87.2	24.7		
37	63.6			19.2	75.8	24.0	79.0	24.7	80.2	24.9	81.3	25.0	83.6	25.3	85.9	25.4		
39	63.6			20.4	75.4	25.3	77.7	25.6	78.9	25.7	80.0	25.9	82.3	26.2	84.6	26.5		
110	86.35			10	58.3	10.19	69.5	11.9	80.7	13.6	86.4	14.5	92.0	15.4	99.1	16.2	101	15.6
				12	58.3	10.33	69.5	12.1	80.7	13.8	86.4	14.7	92.0	15.7	97.8	16.1	99.9	15.5
				14	58.3	10.5	69.5	12.2	80.7	14.1	86.4	15.0	92.0	15.9	96.5	16.0	98.6	15.5
		16	58.3	10.6	69.5	12.4	80.7	14.3	86.4	15.2	92.0	16.2	95.3	16.2	97.4	16.3		
		18	58.3	10.8	69.5	12.6	80.7	14.5	86.4	15.6	91.9	16.9	94.0	17.0	96.1	17.2		
		20	58.3	10.9	69.5	12.8	80.7	15.3	86.4	16.7	90.6	17.7	92.7	17.9	94.8	18.0		
		21	58.3	11.0	69.5	13.2	80.7	15.8	86.4	17.3	90.0	18.1	92.1	18.3	94.2	18.4		
		23	58.3	11.5	69.5	14.1	80.7	16.9	86.4	18.5	88.7	19.0	90.8	19.1	92.9	19.3		
		25	58.3	12.2	69.5	15.0	80.7	18.0	86.4	19.7	87.4	19.8	89.5	20.0	91.6	20.1		
		27	58.3	13.0	69.5	15.9	80.7	19.2	85.1	20.5	86.1	20.6	88.2	20.8	90.3	21.0		
		29	58.3	13.8	69.5	16.9	80.7	20.5	83.8	21.4	84.9	21.5	87.0	21.6	89.1	21.8		
		31	58.3	14.6	69.5	18.0	80.7	21.8	82.5	22.2	83.6	22.3	85.7	22.5	87.8	22.7		
		33	58.3	15.5	69.5	19.1	80.2	22.9	81.2	23.0	82.3	23.1	84.4	23.3	86.5	23.6		
		35	58.3	16.4	69.5	20.3	78.9	23.7	80.0	23.9	81.0	24.0	83.1	24.2	85.2	24.4		
		37	58.3	17.3	69.5	21.5	77.6	24.6	78.7	24.7	79.7	24.8	81.8	25.1	83.9	25.3		
		39	58.3	18.3	69.5	22.8	76.4	25.4	77.4	25.6	78.5	25.7	80.6	25.9	82.7	26.2		
		100	78.50	10	53.0	9.43	63.2	10.9	73.4	12.5	78.5	13.3	83.6	14.1	93.8	15.7	99.2	16.1
				12	53.0	9.55	63.2	11.1	73.4	12.7	78.5	13.5	83.6	14.3	93.8	16.0	98.0	16.0
				14	53.0	9.68	63.2	11.2	73.4	12.9	78.5	13.7	83.6	14.5	93.8	16.2	96.7	16.0
16	53.0			9.81	63.2	11.4	73.4	13.1	78.5	13.9	83.6	14.8	93.5	16.4	95.4	16.2		
18	53.0			9.95	63.2	11.6	73.4	13.3	78.5	14.1	83.6	15.0	92.2	16.9	94.1	17.0		
20	53.0			10.09	63.2	11.8	73.4	13.6	78.5	14.8	83.6	16.0	90.9	17.7	92.9	17.9		
21	53.0			10.16	63.2	11.8	73.4	14.1	78.5	15.3	83.6	16.6	90.3	18.2	92.2	18.3		
23	53.0			10.39	63.2	12.6	73.4	15.0	78.5	16.3	83.6	17.7	89.0	19.0	90.9	19.1		
25	53.0			11.0	63.2	13.4	73.4	16.0	78.5	17.4	83.6	18.9	87.8	19.8	89.7	20.0		
27	53.0			11.7	63.2	14.2	73.4	17.0	78.5	18.5	83.6	20.1	86.5	20.6	88.4	20.8		
29	53.0			12.4	63.2	15.1	73.4	18.1	78.5	19.7	83.3	21.3	85.2	21.5	87.1	21.7		
31	53.0			13.1	63.2	16.0	73.4	19.3	78.5	21.0	82.0	22.1	83.9	22.3	85.8	22.5		
33	53.0			13.9	63.2	17.0	73.4	20.4	78.5	22.3	80.7	23.0	82.6	23.2	84.6	23.4		
35	53.0			14.7	63.2	18.0	73.4	21.7	78.5	23.7	79.5	23.8	81.4	24.0	83.3	24.2		
37	53.0			15.5	63.2	19.1	73.4	23.0	77.2	24.5	78.2	24.6	80.1	24.9	82.0	25.1		
39	53.0			16.4	63.2	20.2	73.4	24.4	75.9	25.4	76.9	25.5	78.8	25.7	80.7	26.0		

**NOTES - ANMERKUNGEN - Σημειώσεις - NOTAS - REMARQUES - NOTE - OPMERKINGEN - Примечания - NOTLAR**

- The above table shows the average value of conditions which may occur.  
 Die obige Tabelle zeigt den Durchschnittswert der Bedingungen, die auftreten können.  
 Στον παραπάνω πίνακα αναγράφεται η μέση τιμή για συνθήκες που μπορεί να προκύψουν.  
 La tabla de arriba muestra el valor medio de condiciones que pueden ocurrir.  
 Le tableau ci-dessus donne la valeur moyenne pour des conditions qui peuvent survenir.  
 La tabella in alto mostra il valore delle condizioni medie che si possono riscontrare.  
 De tabel hierboven geeft de gemiddelde waarde aan van situaties die kunnen voorvallen.  
 Таблица расположенная выше показывает среднее значение условий, которые могут наступить.  
 Yukarıdaki tablo meydana gelebilecek kopyaların ortalama değerini göstermektedir.

# 5 Capacity tables

## 5 - 1 Cooling Capacity Tables

5

RQYQ28PY1

TC: Total Capacity: kW ; PI: Power Input: kW (compressor + outdoor fan motor)

Combination (%)	Capacity index (kW)	Outdoor air temp. °CDB	Indoor air temperature: °CWB															
			14.0		16.0		18.0		19.0		20.0		22.0		24.0			
			TC	PI	TC	PI	TC	PI	TC	PI	TC	PI	TC	PI	TC	PI		
90	70.65	10	47.7	8.68	56.9	9.98	66.1	11.4	70.7	12.1	75.2	12.8	84.4	14.2	93.6	15.7		
		12	47.7	8.79	56.9	10.12	66.1	11.5	70.7	12.2	75.2	13.0	84.4	14.4	93.6	15.9		
		14	47.7	8.90	56.9	10.26	66.1	11.7	70.7	12.4	75.2	13.2	84.4	14.7	93.6	16.2		
		16	47.7	9.02	56.9	10.41	66.1	11.9	70.7	12.6	75.2	13.4	84.4	14.9	93.5	16.4		
		18	47.7	9.14	56.9	10.6	66.1	12.0	70.7	12.8	75.2	13.6	84.4	15.1	92.2	16.9		
		20	47.7	9.26	56.9	10.7	66.1	12.2	70.7	13.0	75.2	14.0	84.4	16.2	90.9	17.7		
		21	47.7	9.33	56.9	10.8	66.1	12.4	70.7	13.4	75.2	14.5	84.4	16.8	90.3	18.2		
		23	47.7	9.46	56.9	11.2	66.1	13.2	70.7	14.3	75.2	15.5	84.4	17.9	89.0	19.0		
		25	47.7	9.91	56.9	11.9	66.1	14.1	70.7	15.3	75.2	16.5	84.4	19.1	87.7	19.8		
		27	47.7	10.51	56.9	12.6	66.1	15.0	70.7	16.2	75.2	17.6	84.4	20.4	86.4	20.6		
		29	47.7	11.1	56.9	13.4	66.1	15.9	70.7	17.3	75.2	18.7	83.4	21.3	85.2	21.5		
		31	47.7	11.8	56.9	14.2	66.1	16.9	70.7	18.4	75.2	19.9	82.2	22.2	83.9	22.3		
		33	47.7	12.4	56.9	15.0	66.1	17.9	70.7	19.5	75.2	21.1	80.9	23.0	82.6	23.2		
		35	47.7	13.1	56.9	15.9	66.1	19.0	70.7	20.7	75.2	22.4	79.6	23.8	81.3	24.0		
		37	47.7	13.9	56.9	16.8	66.1	20.2	70.7	21.9	75.2	23.8	78.3	24.7	80.1	24.9		
		39	47.7	14.6	56.9	17.8	66.1	21.4	70.7	23.3	75.2	25.3	77.1	25.5	78.8	25.7		
		80	62.80	10	42.4	7.97	50.5	9.08	58.7	10.26	62.8	10.9	66.9	11.5	75.1	12.7	83.2	14.0
				12	42.4	8.06	50.5	9.20	58.7	10.40	62.8	11.0	66.9	11.6	75.1	12.9	83.2	14.2
14	42.4			8.15	50.5	9.32	58.7	10.5	62.8	11.2	66.9	11.8	75.1	13.1	83.2	14.5		
16	42.4			8.25	50.5	9.44	58.7	10.7	62.8	11.3	66.9	12.0	75.1	13.3	83.2	14.7		
18	42.4			8.36	50.5	9.57	58.7	10.9	62.8	11.5	66.9	12.2	75.1	13.5	83.2	14.9		
20	42.4			8.46	50.5	9.71	58.7	11.0	62.8	11.7	66.9	12.4	75.1	14.0	83.2	15.9		
21	42.4			8.52	50.5	9.78	58.7	11.1	62.8	11.8	66.9	12.6	75.1	14.5	83.2	16.5		
23	42.4			8.63	50.5	9.92	58.7	11.6	62.8	12.5	66.9	13.4	75.1	15.4	83.2	17.6		
25	42.4			8.87	50.5	10.51	58.7	12.3	62.8	13.3	66.9	14.3	75.1	16.4	83.2	18.8		
27	42.4			9.39	50.5	11.1	58.7	13.1	62.8	14.1	66.9	15.2	75.1	17.5	83.2	20.0		
29	42.4			9.92	50.5	11.8	58.7	13.9	62.8	15.0	66.9	16.2	75.1	18.6	83.2	21.3		
31	42.4			10.48	50.5	12.5	58.7	14.7	62.8	15.9	66.9	17.2	75.1	19.8	81.9	22.1		
33	42.4			11.1	50.5	13.2	58.7	15.6	62.8	16.9	66.9	18.2	75.1	21.0	80.7	23.0		
35	42.4			11.7	50.5	14.0	58.7	16.5	62.8	17.9	66.9	19.3	75.1	22.3	79.4	23.8		
37	42.4			12.3	50.5	14.8	58.7	17.5	62.8	18.9	66.9	20.5	75.1	23.7	78.1	24.6		
39	42.4			13.0	50.5	15.6	58.7	18.5	62.8	20.1	66.9	21.7	75.1	25.2	76.8	25.5		
70	54.95			10	37.1	7.28	44.2	8.21	51.4	9.20	55.0	9.71	58.5	10.23	65.7	11.3	72.8	12.4
				12	37.1	7.36	44.2	8.31	51.4	9.32	55.0	9.84	58.5	10.37	65.7	11.5	72.8	12.6
		14	37.1	7.44	44.2	8.41	51.4	9.44	55.0	9.97	58.5	10.5	65.7	11.6	72.8	12.8		
		16	37.1	7.52	44.2	8.52	51.4	9.57	55.0	10.11	58.5	10.7	65.7	11.8	72.8	13.0		
		18	37.1	7.60	44.2	8.62	51.4	9.70	55.0	10.25	58.5	10.8	65.7	12.0	72.8	13.2		
		20	37.1	7.69	44.2	8.74	51.4	9.84	55.0	10.40	58.5	11.0	65.7	12.2	72.8	13.5		
		21	37.1	7.74	44.2	8.80	51.4	9.91	55.0	10.5	58.5	11.1	65.7	12.3	72.8	13.9		
		23	37.1	7.84	44.2	8.92	51.4	10.06	55.0	10.8	58.5	11.5	65.7	13.1	72.8	14.9		
		25	37.1	7.94	44.2	9.23	51.4	10.7	55.0	11.5	58.5	12.3	65.7	14.0	72.8	15.8		
		27	37.1	8.34	44.2	9.77	51.4	11.3	55.0	12.2	58.5	13.0	65.7	14.9	72.8	16.9		
		29	37.1	8.81	44.2	10.33	51.4	12.0	55.0	12.9	58.5	13.8	65.7	15.8	72.8	17.9		
		31	37.1	9.29	44.2	10.9	51.4	12.7	55.0	13.7	58.5	14.7	65.7	16.8	72.8	19.1		
		33	37.1	9.79	44.2	11.5	51.4	13.4	55.0	14.5	58.5	15.5	65.7	17.8	72.8	20.2		
		35	37.1	10.31	44.2	12.2	51.4	14.2	55.0	15.3	58.5	16.5	65.7	18.9	72.8	21.5		
		37	37.1	10.85	44.2	12.8	51.4	15.0	55.0	16.2	58.5	17.4	65.7	20.0	72.8	22.8		
		39	37.1	11.4	44.2	13.5	51.4	15.9	55.0	17.1	58.5	18.4	65.7	21.2	72.8	24.2		
		60	47.10	10	31.8	6.62	37.9	7.38	44.0	8.19	47.1	8.60	50.2	9.03	56.3	9.90	62.4	10.8
				12	31.8	6.68	37.9	7.46	44.0	8.28	47.1	8.71	50.2	9.14	56.3	10.03	62.4	11.0
14	31.8			6.75	37.9	7.55	44.0	8.38	47.1	8.82	50.2	9.26	56.3	10.17	62.4	11.1		
16	31.8			6.82	37.9	7.63	44.0	8.49	47.1	8.93	50.2	9.38	56.3	10.32	62.4	11.3		
18	31.8			6.89	37.9	7.72	44.0	8.60	47.1	9.05	50.2	9.51	56.3	10.5	62.4	11.4		
20	31.8			6.96	37.9	7.81	44.0	8.71	47.1	9.17	50.2	9.65	56.3	10.6	62.4	11.6		
21	31.8			7.00	37.9	7.86	44.0	8.77	47.1	9.24	50.2	9.72	56.3	10.7	62.4	11.7		
23	31.8			7.08	37.9	7.96	44.0	8.89	47.1	9.37	50.2	9.86	56.3	11.1	62.4	12.4		
25	31.8			7.16	37.9	8.06	44.0	9.19	47.1	9.80	50.2	10.43	56.3	11.8	62.4	13.2		
27	31.8			7.38	37.9	8.50	44.0	9.73	47.1	10.38	50.2	11.1	56.3	12.5	62.4	14.0		
29	31.8			7.78	37.9	8.98	44.0	10.29	47.1	11.0	50.2	11.7	56.3	13.2	62.4	14.9		
31	31.8			8.19	37.9	9.47	44.0	10.9	47.1	11.6	50.2	12.4	56.3	14.0	62.4	15.8		
33	31.8			8.61	37.9	9.98	44.0	11.5	47.1	12.3	50.2	13.1	56.3	14.9	62.4	16.7		
35	31.8			9.06	37.9	10.52	44.0	12.1	47.1	13.0	50.2	13.9	56.3	15.7	62.4	17.7		
37	31.8			9.51	37.9	11.1	44.0	12.8	47.1	13.7	50.2	14.6	56.3	16.6	62.4	18.8		
39	31.8			9.99	37.9	11.7	44.0	13.5	47.1	14.4	50.2	15.5	56.3	17.6	62.4	19.9		
50	39.25			10	26.5	6.00	31.6	6.60	36.7	7.23	39.3	7.56	41.8	7.89	46.9	8.58	52.0	9.29
				12	26.5	6.05	31.6	6.66	36.7	7.31	39.3	7.64	41.8	7.98	46.9	8.68	52.0	9.41
		14	26.5	6.10	31.6	6.73	36.7	7.38	39.3	7.73	41.8	8.07	46.9	8.79	52.0	9.53		
		16	26.5	6.15	31.6	6.79	36.7	7.47	39.3	7.81	41.8	8.17	46.9	8.90	52.0	9.66		
		18	26.5	6.21	31.6	6.86	36.7	7.55	39.3	7.91	41.8	8.27	46.9	9.02	52.0	9.80		
		20	26.5	6.27	31.6	6.93	36.7	7.64	39.3	8.00	41.8	8.38	46.9	9.14	52.0	9.94		
		21	26.5	6.30	31.6	6.97	36.7	7.68	39.3	8.05	41.8	8.43	46.9	9.21	52.0	10.01		
		23	26.5	6.36	31.6	7.05	36.7	7.78	39.3	8.16	41.8	8.54	46.9	9.34	52.0	10.19		
		25	26.5	6.42	31.6	7.13	36.7	7.88	39.3	8.28	41.8	8.76	46.9	9.76	52.0	10.8		
		27	26.5	6.49	31.6	7.34	36.7	8.27	39.3	8.76	41.8	9.27	46.9	10.34	52.0	11.5		
		29	26.5	6.83	31.6	7.74	36.7	8.73	39.3	9.25	41.8	9.80	46.9	10.9	52.0	12.2		

# 5 Capacity tables

## 5 - 1 Cooling Capacity Tables

RQYQ30PY1

TC: Total Capacity: kW ; PI: Power Input: kW (compressor + outdoor fan motor)

Combination (%)	Capacity index (kW)	Outdoor air temp. °CDB	Indoor air temperature: °CWB															
			14.0		16.0		18.0		19.0		20.0		22.0		24.0			
			TC	PI	TC	PI	TC	PI	TC	PI	TC	PI	TC	PI	TC	PI		
130	110.50	10	74,6	12,5	88,9	14,7	103	17,0	107	17,2	108	16,9	111	16,2	114	15,5		
		12	74,6	12,7	88,9	15,0	103	17,3	106	17,2	107	16,8	110	16,1	112	15,8		
		14	74,6	12,9	88,9	15,2	103	17,4	104	17,1	106	16,7	108	16,6	111	16,7		
		16	74,6	13,1	88,9	15,4	102	17,3	103	17,2	104	17,3	107	17,5	110	17,6		
		18	74,6	13,3	88,9	15,7	100	18,0	102	18,1	103	18,2	106	18,4	108	18,5		
		20	74,6	13,5	88,9	16,6	98,8	18,9	100	19,0	101	19,1	104	19,3	107	19,5		
		21	74,6	13,9	88,9	17,2	98,1	19,3	99,5	19,4	101	19,5	103	19,7	106	19,9		
		23	74,6	14,8	88,9	18,4	96,7	20,2	98,1	20,3	99,4	20,4	102	20,6	105	20,8		
		25	74,6	15,7	88,9	19,6	95,3	21,1	96,7	21,2	98,0	21,3	101	21,5	103	21,7		
		27	74,6	16,7	88,9	20,9	94,0	22,0	95,3	22,1	96,6	22,2	99,3	22,4	102	22,7		
		29	74,6	17,8	88,9	22,3	92,6	22,9	93,9	23,0	95,3	23,1	98,0	23,4	101	23,6		
		31	74,6	18,9	88,5	23,5	91,2	23,8	92,5	23,9	93,9	24,0	96,6	24,3	99,3	24,5		
		33	74,6	20,1	87,1	24,4	89,8	24,7	91,2	24,8	92,5	24,9	95,2	25,2	97,9	25,5		
		35	74,6	21,3	85,7	25,3	88,4	25,6	89,8	25,7	91,1	25,9	93,8	26,1	96,5	26,4		
		37	74,6	22,6	84,4	26,2	87,0	26,5	88,4	26,6	89,7	26,8	92,4	27,1	95,1	27,4		
		39	74,6	23,9	83,0	27,1	85,7	27,4	87,0	27,6	88,4	27,7	91,0	28,0	93,7	28,4		
		120	102.00	10	68,8	11,7	82,1	13,7	95,4	15,7	102	16,8	107	17,3	109	16,7	112	16,0
				12	68,8	11,8	82,1	13,9	95,4	16,0	102	17,0	105	17,3	108	16,6	110	15,9
				14	68,8	12,0	82,1	14,1	95,4	16,2	102	17,3	104	17,2	106	16,5	109	16,6
16	68,8			12,2	82,1	14,3	95,4	16,5	101	17,4	103	17,2	105	17,4	108	17,5		
18	68,8			12,4	82,1	14,5	95,4	17,0	99,9	18,0	101	18,1	104	18,2	106	18,4		
20	68,8			12,6	82,1	15,1	95,4	18,2	98,6	18,9	99,8	19,0	102	19,1	105	19,3		
21	68,8			12,7	82,1	15,6	95,4	18,8	97,9	19,3	99,1	19,4	102	19,6	104	19,8		
23	68,8			13,5	82,1	16,6	95,2	20,1	96,5	20,2	97,7	20,3	100	20,5	103	20,7		
25	68,8			14,3	82,1	17,7	93,9	21,0	95,1	21,1	96,3	21,2	98,8	21,4	101	21,6		
27	68,8			15,2	82,1	18,9	92,5	21,9	93,7	22,0	95,0	22,1	97,4	22,3	99,9	22,5		
29	68,8			16,2	82,1	20,1	91,1	22,7	92,3	22,8	93,6	23,0	96,1	23,2	98,5	23,4		
31	68,8			17,2	82,1	21,3	89,7	23,6	90,9	23,7	92,2	23,9	94,7	24,1	97,2	24,3		
33	68,8			18,2	82,1	22,7	88,3	24,5	89,6	24,6	90,8	24,8	93,3	25,0	95,8	25,3		
35	68,8			19,3	82,1	24,1	86,9	25,4	88,2	25,5	89,4	25,7	91,9	25,9	94,4	26,2		
37	68,8			20,4	82,1	25,6	85,6	26,3	86,8	26,4	88,0	26,6	90,5	26,9	93,0	27,2		
39	68,8			21,6	81,7	26,9	84,2	27,2	85,4	27,4	86,7	27,5	89,1	27,8	91,6	28,1		
110	93.50			10	63,1	10,8	75,3	12,6	87,4	14,5	93,5	15,4	99,6	16,4	107	17,2	110	16,6
				12	63,1	11,0	75,3	12,8	87,4	14,7	93,5	15,7	99,6	16,7	106	17,1	108	16,5
				14	63,1	11,1	75,3	13,0	87,4	14,9	93,5	15,9	99,6	16,9	105	17,0	107	16,5
		16	63,1	11,3	75,3	13,2	87,4	15,2	93,5	16,2	99,6	17,2	103	17,2	105	17,4		
		18	63,1	11,5	75,3	13,4	87,4	15,4	93,5	16,6	99,5	18,0	102	18,1	104	18,3		
		20	63,1	11,6	75,3	13,6	87,4	16,3	93,5	17,7	98,1	18,8	100	19,0	103	19,2		
		21	63,1	11,7	75,3	14,0	87,4	16,8	93,5	18,4	97,4	19,3	99,7	19,4	102	19,6		
		23	63,1	12,2	75,3	14,9	87,4	18,0	93,5	19,6	96,0	20,2	98,3	20,3	101	20,5		
		25	63,1	13,0	75,3	15,9	87,4	19,2	93,5	20,9	94,6	21,0	96,9	21,2	99,2	21,4		
		27	63,1	13,8	75,3	16,9	87,4	20,4	92,1	21,8	93,3	21,9	95,5	22,1	97,8	22,3		
		29	63,1	14,6	75,3	18,0	87,4	21,8	90,7	22,7	91,9	22,8	94,2	23,0	96,4	23,2		
		31	63,1	15,5	75,3	19,1	87,4	23,2	89,4	23,6	90,5	23,7	92,8	23,9	95,0	24,1		
		33	63,1	16,4	75,3	20,3	86,8	24,4	88,0	24,5	89,1	24,6	91,4	24,8	93,7	25,1		
		35	63,1	17,4	75,3	21,5	85,5	25,2	86,6	25,4	87,7	25,5	90,0	25,7	92,3	26,0		
		37	63,1	18,4	75,3	22,8	84,1	26,1	85,2	26,3	86,3	26,4	88,6	26,7	90,9	26,9		
		39	63,1	19,5	75,3	24,2	82,7	27,0	83,8	27,2	85,0	27,3	87,2	27,6	89,5	27,9		
		100	85.00	10	57,4	10,0	68,4	11,6	79,5	13,3	85,0	14,1	90,5	15,0	102	16,7	107	17,1
				12	57,4	10,2	68,4	11,8	79,5	13,5	85,0	14,3	90,5	15,2	102	17,0	106	17,1
				14	57,4	10,3	68,4	11,9	79,5	13,7	85,0	14,6	90,5	15,4	102	17,2	105	17,0
16	57,4			10,4	68,4	12,1	79,5	13,9	85,0	14,8	90,5	15,7	101	17,4	103	17,2		
18	57,4			10,6	68,4	12,3	79,5	14,1	85,0	15,0	90,5	15,9	99,9	18,0	102	18,1		
20	57,4			10,7	68,4	12,5	79,5	14,5	85,0	15,7	90,5	17,0	98,5	18,9	101	19,0		
21	57,4			10,8	68,4	12,6	79,5	15,0	85,0	16,3	90,5	17,6	97,8	19,3	99,8	19,5		
23	57,4			11,0	68,4	13,4	79,5	16,0	85,0	17,4	90,5	18,8	96,4	20,2	98,5	20,3		
25	57,4			11,7	68,4	14,2	79,5	17,0	85,0	18,5	90,5	20,1	95,0	21,1	97,1	21,2		
27	57,4			12,4	68,4	15,1	79,5	18,1	85,0	19,7	90,5	21,4	93,6	22,0	95,7	22,1		
29	57,4			13,2	68,4	16,1	79,5	19,3	85,0	21,0	90,2	22,7	92,3	22,8	94,3	23,0		
31	57,4			14,0	68,4	17,0	79,5	20,5	85,0	22,3	88,8	23,5	90,9	23,7	92,9	23,9		
33	57,4			14,8	68,4	18,1	79,5	21,7	85,0	23,7	87,4	24,4	89,5	24,6	91,6	24,8		
35	57,4			15,6	68,4	19,2	79,5	23,1	85,0	25,2	86,0	25,3	88,1	25,5	90,2	25,8		
37	57,4			16,5	68,4	20,3	79,5	24,5	83,6	26,1	84,7	26,2	86,7	26,4	88,8	26,7		
39	57,4			17,5	68,4	21,5	79,5	26,0	82,2	27,0	83,3	27,1	85,3	27,4	87,4	27,6		

**NOTES - ANMERKUNGEN - Σημειώσεις - NOTAS - REMARQUES - NOTE - OPMERKINGEN - Примечания - NOTLAR**

- The above table shows the average value of conditions which may occur.  
 Die obige Tabelle zeigt den Durchschnittswert der Bedingungen, die auftreten können.  
 Στον παραπάνω πίνακα αναγράφεται η μέση τιμή για συνθήκες που μπορεί να προκύψουν.  
 La tabla de arriba muestra el valor medio de condiciones que pueden ocurrir.  
 Le tableau ci-dessus donne la valeur moyenne pour des conditions qui peuvent survenir.  
 La tabella in alto mostra il valore delle condizioni medie che si possono riscontrare.  
 De tabel hierboven geeft de gemiddelde waarde aan van situaties die kunnen voorvallen.  
 Таблица расположенная выше показывает среднее значение условий, которые могут наступить.  
 Yukarıdaki tablo meydana gelebilecek kobluların ortalama değerini göstermektedir.



# 5 Capacity tables

## 5 - 1 Cooling Capacity Tables

5

RQYQ30PY1

TC: Total Capacity: kW ; PI: Power Input: kW (compressor + outdoor fan motor)

Combination (%)	Capacity index (kW)	Outdoor air temp. °CDB	Indoor air temperature: °CWB													
			14.0		16.0		18.0		19.0		20.0		22.0		24.0	
			TC	PI	TC	PI	TC	PI	TC	PI	TC	PI	TC	PI	TC	PI
90	76.50	10	51.6	9.23	61.6	10.6	71.5	12.1	76.5	12.8	81.5	13.6	91.4	15.1	101	16.7
		12	51.6	9.35	61.6	10.8	71.5	12.2	76.5	13.0	81.5	13.8	91.4	15.3	101	16.9
		14	51.6	9.46	61.6	10.9	71.5	12.4	76.5	13.2	81.5	14.0	91.4	15.6	101	17.2
		16	51.6	9.59	61.6	11.1	71.5	12.6	76.5	13.4	81.5	14.2	91.4	15.8	101	17.4
		18	51.6	9.72	61.6	11.2	71.5	12.8	76.5	13.6	81.5	14.4	91.4	16.1	99.8	18.0
		20	51.6	9.85	61.6	11.4	71.5	13.0	76.5	13.8	81.5	14.9	91.4	17.2	98.4	18.9
		21	51.6	9.92	61.6	11.5	71.5	13.2	76.5	14.3	81.5	15.4	91.4	17.8	97.7	19.3
		23	51.6	10.1	61.6	11.9	71.5	14.1	76.5	15.2	81.5	16.5	91.4	19.1	96.4	20.2
		25	51.6	10.5	61.6	12.6	71.5	15.0	76.5	16.2	81.5	17.5	91.4	20.3	95.0	21.1
		27	51.6	11.2	61.6	13.4	71.5	15.9	76.5	17.3	81.5	18.7	91.4	21.7	93.6	21.9
		29	51.6	11.8	61.6	14.2	71.5	16.9	76.5	18.4	81.5	19.9	90.3	22.7	92.2	22.8
		31	51.6	12.5	61.6	15.1	71.5	18.0	76.5	19.5	81.5	21.1	89.0	23.6	90.8	23.7
		33	51.6	13.2	61.6	16.0	71.5	19.1	76.5	20.7	81.5	22.4	87.6	24.4	89.4	24.6
		35	51.6	14.0	61.6	16.9	71.5	20.2	76.5	22.0	81.5	23.8	86.2	25.3	88.1	25.5
		37	51.6	14.7	61.6	17.9	71.5	21.4	76.5	23.3	81.5	25.3	84.8	26.2	86.7	26.4
		39	51.6	15.6	61.6	18.9	71.5	22.7	76.5	24.7	81.5	26.8	83.4	27.1	85.3	27.3
		80	68.00	10	45.9	8.47	54.7	9.66	63.6	10.9	68.0	11.5	72.4	12.2	81.3	13.5
12	45.9			8.57	54.7	9.78	63.6	11.1	68.0	11.7	72.4	12.4	81.3	13.7	90.1	15.1
14	45.9			8.67	54.7	9.91	63.6	11.2	68.0	11.9	72.4	12.6	81.3	14.0	90.1	15.4
16	45.9			8.77	54.7	10.0	63.6	11.4	68.0	12.1	72.4	12.8	81.3	14.2	90.1	15.6
18	45.9			8.88	54.7	10.2	63.6	11.5	68.0	12.2	72.4	12.9	81.3	14.4	90.1	15.9
20	45.9			9.00	54.7	10.3	63.6	11.7	68.0	12.4	72.4	13.2	81.3	14.9	90.1	16.9
21	45.9			9.06	54.7	10.4	63.6	11.8	68.0	12.5	72.4	13.4	81.3	15.4	90.1	17.5
23	45.9			9.18	54.7	10.5	63.6	12.3	68.0	13.3	72.4	14.3	81.3	16.4	90.1	18.7
25	45.9			9.43	54.7	11.2	63.6	13.1	68.0	14.1	72.4	15.2	81.3	17.5	90.1	19.9
27	45.9			9.98	54.7	11.8	63.6	13.9	68.0	15.0	72.4	16.2	81.3	18.6	90.1	21.3
29	45.9			10.6	54.7	12.6	63.6	14.8	68.0	15.9	72.4	17.2	81.3	19.8	90.1	22.6
31	45.9			11.1	54.7	13.3	63.6	15.7	68.0	16.9	72.4	18.2	81.3	21.1	88.7	23.5
33	45.9			11.8	54.7	14.1	63.6	16.6	68.0	17.9	72.4	19.4	81.3	22.4	87.3	24.4
35	45.9			12.4	54.7	14.9	63.6	17.6	68.0	19.0	72.4	20.5	81.3	23.8	86.0	25.3
37	45.9			13.1	54.7	15.7	63.6	18.6	68.0	20.1	72.4	21.8	81.3	25.2	84.6	26.2
39	45.9			13.8	54.7	16.6	63.6	19.7	68.0	21.3	72.4	23.1	81.3	26.8	83.2	27.1
70	59.50			10	40.2	7.74	47.9	8.73	55.6	9.78	59.5	10.3	63.4	10.9	71.1	12.0
		12	40.2	7.82	47.9	8.84	55.6	9.91	59.5	10.5	63.4	11.0	71.1	12.2	78.8	13.4
		14	40.2	7.91	47.9	8.94	55.6	10.0	59.5	10.6	63.4	11.2	71.1	12.4	78.8	13.6
		16	40.2	7.99	47.9	9.05	55.6	10.2	59.5	10.7	63.4	11.3	71.1	12.5	78.8	13.8
		18	40.2	8.09	47.9	9.17	55.6	10.3	59.5	10.9	63.4	11.5	71.1	12.7	78.8	14.0
		20	40.2	8.18	47.9	9.29	55.6	10.5	59.5	11.1	63.4	11.7	71.1	12.9	78.8	14.3
		21	40.2	8.23	47.9	9.35	55.6	10.5	59.5	11.1	63.4	11.8	71.1	13.1	78.8	14.8
		23	40.2	8.33	47.9	9.48	55.6	10.7	59.5	11.5	63.4	12.3	71.1	14.0	78.8	15.8
		25	40.2	8.44	47.9	9.81	55.6	11.4	59.5	12.2	63.4	13.1	71.1	14.9	78.8	16.8
		27	40.2	8.87	47.9	10.4	55.6	12.0	59.5	12.9	63.4	13.9	71.1	15.8	78.8	17.9
		29	40.2	9.37	47.9	11.0	55.6	12.8	59.5	13.7	63.4	14.7	71.1	16.8	78.8	19.1
		31	40.2	9.88	47.9	11.6	55.6	13.5	59.5	14.5	63.4	15.6	71.1	17.8	78.8	20.3
		33	40.2	10.4	47.9	12.3	55.6	14.3	59.5	15.4	63.4	16.5	71.1	18.9	78.8	21.5
		35	40.2	11.0	47.9	12.9	55.6	15.1	59.5	16.3	63.4	17.5	71.1	20.1	78.8	22.8
		37	40.2	11.5	47.9	13.6	55.6	16.0	59.5	17.2	63.4	18.5	71.1	21.3	78.8	24.2
		39	40.2	12.1	47.9	14.4	55.6	16.9	59.5	18.2	63.4	19.6	71.1	22.5	78.8	25.7
		60	51.00	10	34.4	7.04	41.1	7.85	47.7	8.71	51.0	9.15	54.3	9.60	60.9	10.5
12	34.4			7.11	41.1	7.94	47.7	8.81	51.0	9.26	54.3	9.72	60.9	10.7	67.6	11.6
14	34.4			7.18	41.1	8.02	47.7	8.91	51.0	9.38	54.3	9.85	60.9	10.8	67.6	11.8
16	34.4			7.25	41.1	8.11	47.7	9.03	51.0	9.50	54.3	10.0	60.9	11.0	67.6	12.0
18	34.4			7.32	41.1	8.21	47.7	9.14	51.0	9.62	54.3	10.1	60.9	11.1	67.6	12.2
20	34.4			7.40	41.1	8.31	47.7	9.26	51.0	9.75	54.3	10.3	60.9	11.3	67.6	12.4
21	34.4			7.44	41.1	8.36	47.7	9.32	51.0	9.82	54.3	10.3	60.9	11.4	67.6	12.5
23	34.4			7.52	41.1	8.46	47.7	9.45	51.0	10.0	54.3	10.5	60.9	11.8	67.6	13.2
25	34.4			7.61	41.1	8.57	47.7	9.77	51.0	10.4	54.3	11.1	60.9	12.5	67.6	14.0
27	34.4			7.84	41.1	9.04	47.7	10.3	51.0	11.0	54.3	11.8	60.9	13.3	67.6	14.9
29	34.4			8.27	41.1	9.54	47.7	10.9	51.0	11.7	54.3	12.5	60.9	14.1	67.6	15.8
31	34.4			8.71	41.1	10.07	47.7	11.6	51.0	12.4	54.3	13.2	60.9	14.9	67.6	16.8
33	34.4			9.16	41.1	10.6	47.7	12.2	51.0	13.1	54.3	13.9	60.9	15.8	67.6	17.8
35	34.4			9.63	41.1	11.2	47.7	12.9	51.0	13.8	54.3	14.7	60.9	16.7	67.6	18.9
37	34.4			10.12	41.1	11.8	47.7	13.6	51.0	14.6	54.3	15.6	60.9	17.7	67.6	20.0
39	34.4			10.6	41.1	12.4	47.7	14.3	51.0	15.4	54.3	16.4	60.9	18.7	67.6	21.2
50	42.50			10	28.7	6.38	34.2	7.02	39.7	7.69	42.5	8.03	45.3	8.39	50.8	9.12
		12	28.7	6.43	34.2	7.08	39.7	7.77	42.5	8.12	45.3	8.48	50.8	9.23	56.3	10.0
		14	28.7	6.49	34.2	7.15	39.7	7.85	42.5	8.21	45.3	8.58	50.8	9.35	56.3	10.1
		16	28.7	6.54	34.2	7.22	39.7	7.94	42.5	8.31	45.3	8.69	50.8	9.47	56.3	10.3
		18	28.7	6.60	34.2	7.30	39.7	8.03	42.5	8.41	45.3	8.80	50.8	9.59	56.3	10.4
		20	28.7	6.66	34.2	7.37	39.7	8.12	42.5	8.51	45.3	8.91	50.8	9.72	56.3	10.6
		21	28.7	6.69	34.2	7.41	39.7	8.17	42.5	8.56	45.3	8.96	50.8	9.79	56.3	10.6
		23	28.7	6.76	34.2	7.50	39.7	8.27	42.5	8.67	45.3	9.08	50.8	9.9	56.3	10.8
		25	28.7	6.83	34.2	7.58	39.7	8.38	42.5	8.81	45.3	9.31	50.8	10.4	56.3	11.5
		27	28.7	6.90	34.2	7.81	39.7	8.79	42.5	9.31	45.3	9.85	50.8	11.0	56.3	12.2
		29	28.7	7.26	34.2	8.23	39.7	9.28	42.5	9.84	45.3	10.4	50.8	11.6	56.3	12.9

# 5 Capacity tables

## 5 - 1 Cooling Capacity Tables

RQYQ32PY1

TC: Total Capacity: kW ; PI: Power Input: kW (compressor + outdoor fan motor)

Combination (%)	Capacity index (kW)	Outdoor air temp. °CDB	Indoor air temperature: °CWB															
			14.0		16.0		18.0		19.0		20.0		22.0		24.0			
			TC	PI	TC	PI	TC	PI	TC	PI	TC	PI	TC	PI	TC	PI		
130	117.00	10	79.0	13.5	94.2	15.9	109	18.3	113	18.6	115	18.2	118	17.5	120	16.7		
		12	79.0	13.7	94.2	16.1	109	18.6	112	18.5	113	18.1	116	17.4	119	17.1		
		14	79.0	13.9	94.2	16.4	109	18.8	110	18.4	112	18.0	115	17.9	118	18.1		
		16	79.0	14.1	94.2	16.7	108	18.7	109	18.6	110	18.7	113	18.9	116	19.0		
		18	79.0	14.4	94.2	16.9	106	19.4	107	19.5	109	19.6	112	19.8	115	20.0		
		20	79.0	14.6	94.2	18.0	105	20.4	106	20.5	107	20.6	110	20.8	113	21.0		
		21	79.0	15.0	94.2	18.6	104	20.9	105	21.0	107	21.1	110	21.3	112	21.5		
		23	79.0	16.0	94.2	19.8	102	21.8	104	21.9	105	22.0	108	22.3	111	22.5		
		25	79.0	17.0	94.2	21.2	101	22.8	102	22.9	104	23.0	107	23.2	109	23.5		
		27	79.0	18.1	94.2	22.6	99.5	23.7	101	23.9	102	24.0	105	24.2	108	24.5		
		29	79.0	19.2	94.2	24.0	98.0	24.7	99.4	24.8	101	25.0	104	25.2	107	25.5		
		31	79.0	20.4	93.7	25.4	96.6	25.7	98.0	25.8	99.4	25.9	102	26.2	105	26.5		
		33	79.0	21.7	92.2	26.3	95.1	26.6	96.5	26.8	97.9	26.9	101	27.2	104	27.5		
		35	79.0	23.0	90.8	27.3	93.6	27.6	95.1	27.8	96.5	27.9	99.3	28.2	102	28.5		
		37	79.0	24.4	89.3	28.2	92.2	28.6	93.6	28.7	95.0	28.9	97.9	29.2	101	29.6		
		39	79.0	25.8	87.9	29.2	90.7	29.6	92.1	29.7	93.5	29.9	96.4	30.3	99.2	30.6		
		120	108.00	10	72.9	12.6	86.9	14.8	101	17.0	108	18.1	113	18.7	116	18.0	118	17.3
				12	72.9	12.8	86.9	15.0	101	17.2	108	18.4	112	18.6	114	17.9	117	17.2
				14	72.9	13.0	86.9	15.2	101	17.5	108	18.7	110	18.5	113	17.8	115	17.9
16	72.9			13.2	86.9	15.4	101	17.8	107	18.8	109	18.6	111	18.7	114	18.9		
18	72.9			13.4	86.9	15.7	101	18.3	106	19.4	107	19.5	110	19.7	112	19.9		
20	72.9			13.6	86.9	16.3	101	19.7	104	20.4	106	20.5	108	20.6	111	20.8		
21	72.9			13.7	86.9	16.8	101	20.3	104	20.8	105	20.9	108	21.1	110	21.3		
23	72.9			14.5	86.9	17.9	101	21.7	102	21.8	103	21.9	106	22.1	109	22.3		
25	72.9			15.5	86.9	19.1	99.4	22.6	101	22.7	102	22.9	105	23.1	107	23.3		
27	72.9			16.4	86.9	20.4	97.9	23.6	99.2	23.7	101	23.8	103	24.0	106	24.3		
29	72.9			17.5	86.9	21.7	96.4	24.5	97.8	24.7	99.1	24.8	102	25.0	104	25.3		
31	72.9			18.5	86.9	23.0	95.0	25.5	96.3	25.6	97.6	25.8	100	26.0	103	26.3		
33	72.9			19.6	86.9	24.5	93.5	26.5	94.8	26.6	96.1	26.7	98.8	27.0	101	27.3		
35	72.9			20.8	86.9	26.0	92.1	27.4	93.4	27.6	94.7	27.7	97.3	28.0	99.9	28.3		
37	72.9			22.1	86.9	27.6	90.6	28.4	91.9	28.5	93.2	28.7	95.8	29.0	98.5	29.3		
39	72.9			23.4	86.5	29.0	89.1	29.4	90.4	29.5	91.8	29.7	94.4	30.0	97.0	30.3		
110	99.00			10	66.8	11.7	79.7	13.6	92.6	15.6	99.0	16.7	105	17.7	114	18.6	116	17.9
				12	66.8	11.9	79.7	13.8	92.6	15.9	99.0	16.9	105	18.0	112	18.5	115	17.8
				14	66.8	12.0	79.7	14.0	92.6	16.1	99.0	17.2	105	18.3	111	18.4	113	17.8
		16	66.8	12.2	79.7	14.3	92.6	16.4	99.0	17.5	105	18.6	109	18.6	112	18.8		
		18	66.8	12.4	79.7	14.5	92.6	16.6	99.0	17.9	105	19.4	108	19.6	110	19.7		
		20	66.8	12.6	79.7	14.7	92.6	17.6	99.0	19.2	104	20.3	106	20.5	109	20.7		
		21	66.8	12.7	79.7	15.1	92.6	18.2	99.0	19.8	103	20.8	106	21.0	108	21.2		
		23	66.8	13.2	79.7	16.1	92.6	19.4	99.0	21.2	102	21.8	104	21.9	106	22.1		
		25	66.8	14.0	79.7	17.2	92.6	20.7	99.0	22.6	100	22.7	103	22.9	105	23.1		
		27	66.8	14.9	79.7	18.3	92.6	22.1	97.5	23.6	98.7	23.7	101	23.9	104	24.1		
		29	66.8	15.8	79.7	19.4	92.6	23.5	96.1	24.5	97.3	24.6	99.7	24.8	102	25.1		
		31	66.8	16.7	79.7	20.6	92.6	25.0	94.6	25.5	95.8	25.6	98.2	25.8	101	26.1		
		33	66.8	17.7	79.7	21.9	91.9	26.3	93.1	26.4	94.4	26.5	96.8	26.8	99.2	27.0		
		35	66.8	18.8	79.7	23.2	90.5	27.3	91.7	27.4	92.9	27.5	95.3	27.8	97.7	28.0		
		37	66.8	19.9	79.7	24.7	89.0	28.2	90.2	28.4	91.4	28.5	93.8	28.8	96.2	29.1		
		39	66.8	21.0	79.7	26.1	87.6	29.2	88.8	29.3	90.0	29.5	92.4	29.8	94.8	30.1		
		100	90.00	10	60.7	10.8	72.4	12.5	84.1	14.3	90.0	15.2	95.9	16.2	108	18.0	114	18.5
				12	60.7	11.0	72.4	12.7	84.1	14.5	90.0	15.5	95.9	16.4	108	18.3	112	18.4
				14	60.7	11.1	72.4	12.9	84.1	14.8	90.0	15.7	95.9	16.7	108	18.6	111	18.3
16	60.7			11.3	72.4	13.1	84.1	15.0	90.0	16.0	95.9	16.9	107	18.8	109	18.6		
18	60.7			11.4	72.4	13.3	84.1	15.2	90.0	16.2	95.9	17.2	106	19.4	108	19.6		
20	60.7			11.6	72.4	13.5	84.1	15.6	90.0	17.0	95.9	18.4	104	20.4	106	20.5		
21	60.7			11.7	72.4	13.6	84.1	16.1	90.0	17.5	95.9	19.0	104	20.8	106	21.0		
23	60.7			11.9	72.4	14.4	84.1	17.2	90.0	18.7	95.9	20.3	102	21.8	104	22.0		
25	60.7			12.7	72.4	15.4	84.1	18.4	90.0	20.0	95.9	21.7	101	22.7	103	22.9		
27	60.7			13.4	72.4	16.3	84.1	19.5	90.0	21.3	95.9	23.1	99.1	23.7	101	23.9		
29	60.7			14.2	72.4	17.3	84.1	20.8	90.0	22.6	95.5	24.5	97.7	24.7	99.9	24.9		
31	60.7			15.1	72.4	18.4	84.1	22.1	90.0	24.1	94.0	25.4	96.2	25.6	98.4	25.8		
33	60.7			16.0	72.4	19.5	84.1	23.5	90.0	25.6	92.6	26.4	94.7	26.6	96.9	26.8		
35	60.7			16.9	72.4	20.7	84.1	24.9	90.0	27.2	91.1	27.3	93.3	27.6	95.5	27.8		
37	60.7			17.8	72.4	21.9	84.1	26.4	88.5	28.2	89.6	28.3	91.8	28.5	94.0	28.8		
39	60.7			18.8	72.4	23.2	84.1	28.0	87.1	29.1	88.2	29.3	90.4	29.5	92.5	29.8		

**NOTES - ANMERKUNGEN - Σημειώσεις - NOTAS - REMARQUES - NOTE - OPMERKINGEN - Примечания - NOTLAR**

- The above table shows the average value of conditions which may occur.  
 Die obige Tabelle zeigt den Durchschnittswert der Bedingungen, die auftreten können.  
 Στον παραπάνω πίνακα αναγράφεται η μέση τιμή για συνθήκες που μπορεί να προκύψουν.  
 La tabla de arriba muestra el valor medio de condiciones que pueden ocurrir.  
 Le tableau ci-dessus donne la valeur moyenne pour des conditions qui peuvent survenir.  
 La tabella in alto mostra il valore delle condizioni medie che si possono riscontrare.  
 De tabel hierboven geeft de gemiddelde waarde aan van situaties die kunnen voorvallen.  
 Таблица расположенная выше показывает среднее значение условий, которые могут наступить.  
 Yukarıdaki tablo meydana gelebilecek kobluların ortalama değerini göstermektedir.

# 5 Capacity tables

## 5 - 1 Cooling Capacity Tables

5

RQYQ32PY1

TC: Total Capacity: kW ; PI: Power Input: kW (compressor + outdoor fan motor)

Combination (%)	Capacity index (kW)	Outdoor air temp. °CDB	Indoor air temperature: °CWB													
			14.0		16.0		18.0		19.0		20.0		22.0		24.0	
			TC	PI	TC	PI	TC	PI	TC	PI	TC	PI	TC	PI	TC	PI
90	81.00	10	54.7	9.97	65.2	11.5	75.7	13.0	81.0	13.8	86.3	14.7	96.8	16.3	107	18.0
		12	54.7	10.1	65.2	11.6	75.7	13.2	81.0	14.0	86.3	14.9	96.8	16.6	107	18.3
		14	54.7	10.2	65.2	11.8	75.7	13.4	81.0	14.2	86.3	15.1	96.8	16.8	107	18.6
		16	54.7	10.3	65.2	11.9	75.7	13.6	81.0	14.5	86.3	15.3	96.8	17.1	107	18.8
		18	54.7	10.5	65.2	12.1	75.7	13.8	81.0	14.7	86.3	15.6	96.8	17.4	106	19.4
		20	54.7	10.6	65.2	12.3	75.7	14.0	81.0	14.9	86.3	16.1	96.8	18.6	104	20.4
		21	54.7	10.7	65.2	12.4	75.7	14.3	81.0	15.4	86.3	16.6	96.8	19.2	103	20.8
		23	54.7	10.9	65.2	12.8	75.7	15.2	81.0	16.4	86.3	17.8	96.8	20.6	102	21.8
		25	54.7	11.4	65.2	13.7	75.7	16.2	81.0	17.5	86.3	18.9	96.8	21.9	101	22.7
		27	54.7	12.1	65.2	14.5	75.7	17.2	81.0	18.6	86.3	20.2	96.8	23.4	99.1	23.7
		29	54.7	12.8	65.2	15.4	75.7	18.3	81.0	19.8	86.3	21.5	95.7	24.5	97.6	24.7
		31	54.7	13.5	65.2	16.3	75.7	19.4	81.0	21.1	86.3	22.8	94.2	25.4	96.2	25.6
		33	54.7	14.3	65.2	17.3	75.7	20.6	81.0	22.4	86.3	24.2	92.7	26.4	94.7	26.6
		35	54.7	15.1	65.2	18.3	75.7	21.8	81.0	23.7	86.3	25.7	91.3	27.3	93.2	27.6
		37	54.7	15.9	65.2	19.3	75.7	23.1	81.0	25.2	86.3	27.3	89.8	28.3	91.8	28.5
		39	54.7	16.8	65.2	20.4	75.7	24.5	81.0	26.7	86.3	29.0	88.3	29.3	90.3	29.5
		80	72.00	10	48.6	9.14	58.0	10.4	67.3	11.8	72.0	12.5	76.7	13.2	86.0	14.6
12	48.6			9.25	58.0	10.6	67.3	11.9	72.0	12.6	76.7	13.4	86.0	14.8	95.4	16.3
14	48.6			9.36	58.0	10.7	67.3	12.1	72.0	12.8	76.7	13.6	86.0	15.1	95.4	16.6
16	48.6			9.47	58.0	10.8	67.3	12.3	72.0	13.0	76.7	13.8	86.0	15.3	95.4	16.9
18	48.6			9.59	58.0	11.0	67.3	12.5	72.0	13.2	76.7	14.0	86.0	15.5	95.4	17.1
20	48.6			9.71	58.0	11.1	67.3	12.6	72.0	13.4	76.7	14.2	86.0	16.0	95.4	18.3
21	48.6			9.78	58.0	11.2	67.3	12.7	72.0	13.5	76.7	14.5	86.0	16.6	95.4	18.9
23	48.6			9.91	58.0	11.4	67.3	13.3	72.0	14.3	76.7	15.4	86.0	17.7	95.4	20.2
25	48.6			10.2	58.0	12.1	67.3	14.1	72.0	15.2	76.7	16.4	86.0	18.9	95.4	21.5
27	48.6			10.8	58.0	12.8	67.3	15.0	72.0	16.2	76.7	17.5	86.0	20.1	95.4	23.0
29	48.6			11.4	58.0	13.5	67.3	15.9	72.0	17.2	76.7	18.5	86.0	21.4	95.4	24.4
31	48.6			12.0	58.0	14.3	67.3	16.9	72.0	18.3	76.7	19.7	86.0	22.7	93.9	25.4
33	48.6			12.7	58.0	15.2	67.3	17.9	72.0	19.4	76.7	20.9	86.0	24.1	92.5	26.4
35	48.6			13.4	58.0	16.0	67.3	19.0	72.0	20.5	76.7	22.2	86.0	25.6	91.0	27.3
37	48.6			14.1	58.0	16.9	67.3	20.1	72.0	21.7	76.7	23.5	86.0	27.2	89.5	28.3
39	48.6			14.9	58.0	17.9	67.3	21.2	72.0	23.0	76.7	24.9	86.0	28.9	88.1	29.2
70	63.00			10	42.5	8.35	50.7	9.43	58.9	10.6	63.0	11.1	67.1	11.7	75.3	13.0
		12	42.5	8.44	50.7	9.54	58.9	10.7	63.0	11.3	67.1	11.9	75.3	13.1	83.5	14.4
		14	42.5	8.53	50.7	9.65	58.9	10.8	63.0	11.4	67.1	12.1	75.3	13.3	83.5	14.6
		16	42.5	8.63	50.7	9.77	58.9	11.0	63.0	11.6	67.1	12.2	75.3	13.5	83.5	14.9
		18	42.5	8.73	50.7	9.90	58.9	11.1	63.0	11.8	67.1	12.4	75.3	13.7	83.5	15.1
		20	42.5	8.83	50.7	10.0	58.9	11.3	63.0	11.9	67.1	12.6	75.3	14.0	83.5	15.5
		21	42.5	8.88	50.7	10.1	58.9	11.4	63.0	12.0	67.1	12.7	75.3	14.2	83.5	16.0
		23	42.5	8.99	50.7	10.2	58.9	11.6	63.0	12.4	67.1	13.2	75.3	15.1	83.5	17.1
		25	42.5	9.11	50.7	10.6	58.9	12.3	63.0	13.2	67.1	14.1	75.3	16.1	83.5	18.2
		27	42.5	9.58	50.7	11.2	58.9	13.0	63.0	14.0	67.1	15.0	75.3	17.1	83.5	19.4
		29	42.5	10.11	50.7	11.9	58.9	13.8	63.0	14.8	67.1	15.9	75.3	18.1	83.5	20.6
		31	42.5	10.7	50.7	12.5	58.9	14.6	63.0	15.7	67.1	16.8	75.3	19.3	83.5	21.9
		33	42.5	11.2	50.7	13.2	58.9	15.4	63.0	16.6	67.1	17.8	75.3	20.4	83.5	23.2
		35	42.5	11.8	50.7	14.0	58.9	16.3	63.0	17.6	67.1	18.9	75.3	21.7	83.5	24.7
		37	42.5	12.5	50.7	14.7	58.9	17.2	63.0	18.6	67.1	20.0	75.3	23.0	83.5	26.2
		39	42.5	13.1	50.7	15.5	58.9	18.2	63.0	19.6	67.1	21.1	75.3	24.3	83.5	27.8
		60	54.00	10	36.4	7.60	43.5	8.47	50.5	9.40	54.0	9.87	57.5	10.4	64.5	11.4
12	36.4			7.67	43.5	8.57	50.5	9.51	54.0	9.99	57.5	10.5	64.5	11.5	71.6	12.6
14	36.4			7.75	43.5	8.66	50.5	9.62	54.0	10.1	57.5	10.6	64.5	11.7	71.6	12.8
16	36.4			7.82	43.5	8.76	50.5	9.74	54.0	10.3	57.5	10.8	64.5	11.8	71.6	12.9
18	36.4			7.90	43.5	8.86	50.5	9.87	54.0	10.4	57.5	10.9	64.5	12.0	71.6	13.1
20	36.4			7.99	43.5	8.97	50.5	10.00	54.0	10.5	57.5	11.1	64.5	12.2	71.6	13.3
21	36.4			8.03	43.5	9.02	50.5	10.1	54.0	10.6	57.5	11.2	64.5	12.3	71.6	13.4
23	36.4			8.12	43.5	9.13	50.5	10.2	54.0	10.8	57.5	11.3	64.5	12.7	71.6	14.2
25	36.4			8.21	43.5	9.25	50.5	10.5	54.0	11.2	57.5	12.0	64.5	13.5	71.6	15.1
27	36.4			8.47	43.5	9.76	50.5	11.2	54.0	11.9	57.5	12.7	64.5	14.3	71.6	16.1
29	36.4			8.92	43.5	10.3	50.5	11.8	54.0	12.6	57.5	13.4	64.5	15.2	71.6	17.1
31	36.4			9.40	43.5	10.9	50.5	12.5	54.0	13.3	57.5	14.2	64.5	16.1	71.6	18.1
33	36.4			9.89	43.5	11.5	50.5	13.2	54.0	14.1	57.5	15.0	64.5	17.1	71.6	19.2
35	36.4			10.39	43.5	12.1	50.5	13.9	54.0	14.9	57.5	15.9	64.5	18.1	71.6	20.4
37	36.4			10.9	43.5	12.7	50.5	14.7	54.0	15.7	57.5	16.8	64.5	19.1	71.6	21.6
39	36.4			11.5	43.5	13.4	50.5	15.5	54.0	16.6	57.5	17.7	64.5	20.2	71.6	22.8
50	45.00			10	30.4	6.88	36.2	7.57	42.1	8.30	45.0	8.67	47.9	9.06	53.8	9.84
		12	30.4	6.94	36.2	7.64	42.1	8.38	45.0	8.77	47.9	9.16	53.8	9.96	59.6	10.8
		14	30.4	7.00	36.2	7.72	42.1	8.47	45.0	8.87	47.9	9.27	53.8	10.1	59.6	10.9
		16	30.4	7.06	36.2	7.80	42.1	8.57	45.0	8.97	47.9	9.38	53.8	10.2	59.6	11.1
		18	30.4	7.12	36.2	7.88	42.1	8.67	45.0	9.08	47.9	9.49	53.8	10.4	59.6	11.2
		20	30.4	7.19	36.2	7.96	42.1	8.77	45.0	9.19	47.9	9.61	53.8	10.5	59.6	11.4
		21	30.4	7.22	36.2	8.00	42.1	8.82	45.0	9.24	47.9	9.68	53.8	10.6	59.6	11.5
		23	30.4	7.30	36.2	8.09	42.1	8.93	45.0	9.36	47.9	9.80	53.8	10.7	59.6	11.7
		25	30.4	7.37	36.2	8.18	42.1	9.04	45.0	9.51	47.9	10.05	53.8	11.2	59.6	12.4
		27	30.4	7.45	36.2	8.43	42.1	9.49	45.0	10.05	47.9	10.6	53.8	11.9	59.6	13.2
		29	30.4	7.83	36.2	8.88	42.1	10.02	45.0	10.6	47.9	11.2	53.8	12.6	59.6	14.0
		31	30.4	8.23	36.2											



# 5 Capacity tables

## 5 - 1 Cooling Capacity Tables

**RQYQ34PY1**

TC: Total Capacity: kW ; PI: Power Input: kW (compressor + outdoor fan motor)

Combination (%)	Capacity index (kW)	Outdoor air temp. °CDB	Indoor air temperature: °CWB															
			14.0		16.0		18.0		19.0		20.0		22.0		24.0			
			TC	PI	TC	PI	TC	PI	TC	PI	TC	PI	TC	PI	TC	PI		
130	122.20	10	84.2	13.4	100	15.7	117	18.1	121	18.4	122	18.0	125	17.3	129	16.5		
		12	84.2	13.6	100	16.0	117	18.4	119	18.3	121	17.9	124	17.2	127	16.9		
		14	84.2	13.8	100	16.2	116	18.6	118	18.2	119	17.8	122	17.7	125	17.9		
		16	84.2	14.0	100	16.5	115	18.5	116	18.4	118	18.5	121	18.6	124	18.8		
		18	84.2	14.2	100	16.7	113	19.2	115	19.3	116	19.4	119	19.6	122	19.8		
		20	84.2	14.4	100	17.8	112	20.2	113	20.3	115	20.4	118	20.6	121	20.8		
		21	84.2	14.8	100	18.4	111	20.6	112	20.7	114	20.8	117	21.0	120	21.3		
		23	84.2	15.8	100	19.6	109	21.6	111	21.7	112	21.8	115	22.0	118	22.2		
		25	84.2	16.8	100	20.9	108	22.5	109	22.6	111	22.7	114	23.0	117	23.2		
		27	84.2	17.9	100	22.3	106	23.5	108	23.6	109	23.7	112	24.0	115	24.2		
		29	84.2	19.0	100	23.8	105	24.4	106	24.5	108	24.7	111	24.9	114	25.2		
		31	84.2	20.2	100	25.1	103	25.4	105	25.5	106	25.6	109	25.9	112	26.2		
		33	84.2	21.4	98.4	26.0	101	26.3	103	26.5	104	26.6	108	26.9	111	27.2		
		35	84.2	22.7	96.8	27.0	99.9	27.3	101	27.4	103	27.6	106	27.9	109	28.2		
		37	84.2	24.1	95.3	27.9	98.3	28.3	99.8	28.4	101	28.6	104	28.9	107	29.2		
		39	84.2	25.5	93.7	28.9	96.7	29.2	98.3	29.4	99.8	29.6	103	29.9	106	30.3		
		120	112.80	10	77.7	12.5	92.7	14.6	108	16.8	115	17.9	121	18.5	123	17.8	126	17.1
				12	77.7	12.6	92.7	14.8	108	17.1	115	18.2	119	18.4	122	17.7	125	17.0
14	77.7			12.8	92.7	15.0	108	17.3	115	18.5	117	18.3	120	17.6	123	17.7		
16	77.7			13.0	92.7	15.3	108	17.6	114	18.6	116	18.4	119	18.5	121	18.7		
18	77.7			13.2	92.7	15.5	108	18.1	113	19.2	114	19.3	117	19.5	120	19.6		
20	77.7			13.4	92.7	16.1	108	19.4	111	20.1	113	20.2	116	20.4	118	20.6		
21	77.7			13.5	92.7	16.6	108	20.1	111	20.6	112	20.7	115	20.9	118	21.1		
23	77.7			14.4	92.7	17.7	108	21.5	109	21.6	110	21.7	113	21.9	116	22.1		
25	77.7			15.3	92.7	18.9	106	22.4	107	22.5	109	22.6	112	22.8	114	23.0		
27	77.7			16.3	92.7	20.1	104	23.3	106	23.4	107	23.6	110	23.8	113	24.0		
29	77.7			17.3	92.7	21.4	103	24.3	104	24.4	106	24.5	108	24.8	111	25.0		
31	77.7			18.3	92.7	22.8	101	25.2	103	25.3	104	25.5	107	25.7	110	26.0		
33	77.7			19.4	92.7	24.2	99.8	26.2	101	26.3	103	26.4	105	26.7	108	27.0		
35	77.7			20.6	92.7	25.7	98.2	27.1	99.6	27.3	101	27.4	104	27.7	107	28.0		
37	77.7			21.8	92.7	27.3	96.6	28.1	98.0	28.2	99.4	28.4	102	28.7	105	29.0		
39	77.7			23.1	92.3	28.7	95.1	29.0	96.5	29.2	97.9	29.4	101	29.7	103	30.0		
110	103.40			10	71.3	11.6	85.0	13.5	98.7	15.5	106	16.5	112	17.5	121	18.3	124	17.7
				12	71.3	11.7	85.0	13.7	98.7	15.7	106	16.7	112	17.8	120	18.3	122	17.6
		14	71.3	11.9	85.0	13.9	98.7	15.9	106	17.0	112	18.1	118	18.2	121	17.6		
		16	71.3	12.1	85.0	14.1	98.7	16.2	106	17.3	112	18.4	116	18.4	119	18.5		
		18	71.3	12.2	85.0	14.3	98.7	16.5	106	17.7	112	19.2	115	19.3	117	19.5		
		20	71.3	12.4	85.0	14.5	98.7	17.4	106	18.9	111	20.1	113	20.3	116	20.4		
		21	71.3	12.5	85.0	15.0	98.7	18.0	106	19.6	110	20.6	113	20.8	115	20.9		
		23	71.3	13.0	85.0	16.0	98.7	19.2	106	20.9	108	21.5	111	21.7	114	21.9		
		25	71.3	13.9	85.0	17.0	98.7	20.5	106	22.4	107	22.5	109	22.7	112	22.9		
		27	71.3	14.7	85.0	18.1	98.7	21.8	104	23.3	105	23.4	108	23.6	110	23.8		
		29	71.3	15.6	85.0	19.2	98.7	23.2	102	24.2	104	24.3	106	24.6	109	24.8		
		31	71.3	16.6	85.0	20.4	98.7	24.7	101	25.2	102	25.3	105	25.5	107	25.8		
		33	71.3	17.5	85.0	21.7	98.1	26.0	99.4	26.1	101	26.3	103	26.5	106	26.7		
		35	71.3	18.6	85.0	23.0	96.5	27.0	97.8	27.1	99.1	27.2	102	27.5	104	27.7		
		37	71.3	19.7	85.0	24.4	94.9	27.9	96.2	28.0	97.5	28.2	100	28.5	103	28.7		
		39	71.3	20.8	85.0	25.8	93.4	28.9	94.7	29.0	96.0	29.1	98.5	29.4	101	29.7		
		100	94.00	10	64.8	10.7	77.3	12.4	89.8	14.2	96.0	15.1	102	16.0	115	17.8	121	18.3
				12	64.8	10.8	77.3	12.6	89.8	14.4	96.0	15.3	102	16.2	115	18.1	120	18.2
14	64.8			11.0	77.3	12.7	89.8	14.6	96.0	15.5	102	16.5	115	18.4	118	18.1		
16	64.8			11.1	77.3	12.9	89.8	14.8	96.0	15.8	102	16.7	114	18.6	117	18.4		
18	64.8			11.3	77.3	13.1	89.8	15.1	96.0	16.0	102	17.0	113	19.2	115	19.3		
20	64.8			11.5	77.3	13.3	89.8	15.4	96.0	16.8	102	18.2	111	20.1	114	20.3		
21	64.8			11.5	77.3	13.4	89.8	16.0	96.0	17.3	102	18.8	110	20.6	113	20.8		
23	64.8			11.8	77.3	14.3	89.8	17.0	96.0	18.5	102	20.1	109	21.5	111	21.7		
25	64.8			12.5	77.3	15.2	89.8	18.2	96.0	19.8	102	21.4	107	22.5	110	22.7		
27	64.8			13.3	77.3	16.1	89.8	19.3	96.0	21.0	102	22.8	106	23.4	108	23.6		
29	64.8			14.1	77.3	17.1	89.8	20.6	96.0	22.4	102	24.2	104	24.4	107	24.6		
31	64.8			14.9	77.3	18.2	89.8	21.9	96.0	23.8	100	25.1	103	25.3	105	25.5		
33	64.8			15.8	77.3	19.3	89.8	23.2	96.0	25.3	98.7	26.1	101	26.3	103	26.5		
35	64.8			16.7	77.3	20.4	89.8	24.6	96.0	26.9	97.2	27.0	99.5	27.3	102	27.5		
37	64.8			17.6	77.3	21.7	89.8	26.1	94.4	27.8	95.6	28.0	97.9	28.2	100	28.5		
39	64.8			18.6	77.3	22.9	89.8	27.7	92.9	28.8	94.0	28.9	96.4	29.2	98.7	29.5		

**NOTES - ANMERKUNGEN - Σημειώσεις - NOTAS - REMARQUES - NOTE - OPMERKINGEN - Примечания - NOTLAR**

- The above table shows the average value of conditions which may occur.  
 Die obige Tabelle zeigt den Durchschnittswert der Bedingungen, die auftreten können.  
 Στον παραπάνω πίνακα αναγράφεται η μέση τιμή για συνθήκες που μπορεί να προκύψουν.  
 La tabla de arriba muestra el valor medio de condiciones que pueden ocurrir.  
 Le tableau ci-dessus donne la valeur moyenne pour des conditions qui peuvent survenir.  
 La tabella in alto mostra il valore delle condizioni medie che si possono riscontrare.  
 De tabel hierboven geeft de gemiddelde waarde aan van situaties die kunnen voorvallen.  
 Таблица расположенная выше показывает среднее значение условий, которые могут наступить.  
 Yukarıdaki tablo meydana gelebilecek koşulların ortalama değerini göstermektedir.

# 5 Capacity tables

## 5 - 1 Cooling Capacity Tables

5

RQYQ34PY1

TC: Total Capacity: kW ; PI: Power Input: kW (compressor + outdoor fan motor)

Combination (%)	Capacity index (kW)	Outdoor air temp. °CDB	Indoor air temperature: °CWB															
			14.0		16.0		18.0		19.0		20.0		22.0		24.0			
			TC	PI	TC	PI	TC	PI	TC	PI	TC	PI	TC	PI	TC	PI		
90	84.60	10	58.3	9.86	69.5	11.3	80.8	12.9	86.4	13.7	92.0	14.5	103	16.1	114	17.8		
		12	58.3	9.98	69.5	11.5	80.8	13.1	86.4	13.9	92.0	14.7	103	16.4	114	18.1		
		14	58.3	10.10	69.5	11.6	80.8	13.3	86.4	14.1	92.0	14.9	103	16.6	114	18.4		
		16	58.3	10.23	69.5	11.8	80.8	13.5	86.4	14.3	92.0	15.2	103	16.9	114	18.6		
		18	58.3	10.37	69.5	12.0	80.8	13.7	86.4	14.5	92.0	15.4	103	17.2	113	19.2		
		20	58.3	10.51	69.5	12.2	80.8	13.9	86.4	14.8	92.0	15.9	103	18.4	111	20.1		
		21	58.3	10.59	69.5	12.3	80.8	14.1	86.4	15.2	92.0	16.5	103	19.0	110	20.6		
		23	58.3	10.7	69.5	12.7	80.8	15.0	86.4	16.3	92.0	17.6	103	20.3	109	21.5		
		25	58.3	11.3	69.5	13.5	80.8	16.0	86.4	17.3	92.0	18.7	103	21.7	107	22.5		
		27	58.3	11.9	69.5	14.3	80.8	17.0	86.4	18.4	92.0	19.9	103	23.1	106	23.4		
		29	58.3	12.6	69.5	15.2	80.8	18.1	86.4	19.6	92.0	21.2	102	24.2	104	24.4		
		31	58.3	13.4	69.5	16.1	80.8	19.2	86.4	20.8	92.0	22.6	100	25.1	103	25.3		
		33	58.3	14.1	69.5	17.1	80.8	20.4	86.4	22.1	92.0	24.0	98.9	26.1	101	26.3		
		35	58.3	14.9	69.5	18.1	80.8	21.6	86.4	23.5	92.0	25.4	97.4	27.0	99.5	27.3		
		37	58.3	15.7	69.5	19.1	80.8	22.9	86.4	24.9	92.0	27.0	95.8	28.0	97.9	28.2		
		39	58.3	16.6	69.5	20.2	80.8	24.2	86.4	26.4	92.0	28.7	94.2	29.0	96.3	29.2		
		80	75.20	10	51.8	9.04	61.8	10.31	71.8	11.6	76.8	12.3	81.8	13.0	91.8	14.5	102	15.9
				12	51.8	9.15	61.8	10.44	71.8	11.8	76.8	12.5	81.8	13.2	91.8	14.7	102	16.2
				14	51.8	9.25	61.8	10.58	71.8	12.0	76.8	12.7	81.8	13.4	91.8	14.9	102	16.4
16	51.8			9.37	61.8	10.7	71.8	12.1	76.8	12.9	81.8	13.6	91.8	15.1	102	16.7		
18	51.8			9.48	61.8	10.9	71.8	12.3	76.8	13.1	81.8	13.8	91.8	15.4	102	16.9		
20	51.8			9.61	61.8	11.0	71.8	12.5	76.8	13.3	81.8	14.0	91.8	15.9	102	18.1		
21	51.8			9.67	61.8	11.1	71.8	12.6	76.8	13.4	81.8	14.3	91.8	16.4	102	18.7		
23	51.8			9.80	61.8	11.3	71.8	13.2	76.8	14.2	81.8	15.2	91.8	17.5	102	20.0		
25	51.8			10.07	61.8	11.9	71.8	14.0	76.8	15.1	81.8	16.2	91.8	18.7	102	21.3		
27	51.8			10.65	61.8	12.6	71.8	14.9	76.8	16.0	81.8	17.3	91.8	19.9	102	22.7		
29	51.8			11.3	61.8	13.4	71.8	15.8	76.8	17.0	81.8	18.3	91.8	21.1	102	24.2		
31	51.8			11.9	61.8	14.2	71.8	16.7	76.8	18.1	81.8	19.5	91.8	22.5	100	25.1		
33	51.8			12.6	61.8	15.0	71.8	17.7	76.8	19.1	81.8	20.7	91.8	23.9	98.6	26.1		
35	51.8			13.2	61.8	15.9	71.8	18.7	76.8	20.3	81.8	21.9	91.8	25.4	97.1	27.0		
37	51.8			14.0	61.8	16.8	71.8	19.8	76.8	21.5	81.8	23.2	91.8	26.9	95.5	28.0		
39	51.8			14.7	61.8	17.7	71.8	21.0	76.8	22.8	81.8	24.6	91.8	28.6	94.0	28.9		
70	65.80			10	45.4	8.26	54.1	9.32	62.8	10.44	67.2	11.0	71.6	11.6	80.3	12.8	89.0	14.1
				12	45.4	8.35	54.1	9.43	62.8	10.57	67.2	11.2	71.6	11.8	80.3	13.0	89.0	14.3
				14	45.4	8.44	54.1	9.55	62.8	10.7	67.2	11.3	71.6	11.9	80.3	13.2	89.0	14.5
		16	45.4	8.53	54.1	9.67	62.8	10.9	67.2	11.5	71.6	12.1	80.3	13.4	89.0	14.7		
		18	45.4	8.63	54.1	9.79	62.8	11.0	67.2	11.6	71.6	12.3	80.3	13.6	89.0	14.9		
		20	45.4	8.73	54.1	9.92	62.8	11.2	67.2	11.8	71.6	12.5	80.3	13.8	89.0	15.3		
		21	45.4	8.79	54.1	9.98	62.8	11.2	67.2	11.9	71.6	12.6	80.3	14.0	89.0	15.8		
		23	45.4	8.89	54.1	10.12	62.8	11.4	67.2	12.2	71.6	13.1	80.3	14.9	89.0	16.9		
		25	45.4	9.01	54.1	10.47	62.8	12.1	67.2	13.0	71.6	13.9	80.3	15.9	89.0	18.0		
		27	45.4	9.47	54.1	11.1	62.8	12.9	67.2	13.8	71.6	14.8	80.3	16.9	89.0	19.1		
		29	45.4	10.00	54.1	11.7	62.8	13.6	67.2	14.6	71.6	15.7	80.3	17.9	89.0	20.4		
		31	45.4	10.54	54.1	12.4	62.8	14.4	67.2	15.5	71.6	16.6	80.3	19.0	89.0	21.6		
		33	45.4	11.1	54.1	13.1	62.8	15.3	67.2	16.4	71.6	17.6	80.3	20.2	89.0	23.0		
		35	45.4	11.7	54.1	13.8	62.8	16.1	67.2	17.4	71.6	18.7	80.3	21.4	89.0	24.4		
		37	45.4	12.3	54.1	14.6	62.8	17.1	67.2	18.4	71.6	19.8	80.3	22.7	89.0	25.9		
		39	45.4	13.0	54.1	15.4	62.8	18.0	67.2	19.4	71.6	20.9	80.3	24.1	89.0	27.5		
		60	56.40	10	38.9	7.52	46.4	8.38	53.9	9.29	57.6	9.76	61.3	10.25	68.8	11.2	76.3	12.3
				12	38.9	7.59	46.4	8.47	53.9	9.40	57.6	9.88	61.3	10.38	68.8	11.4	76.3	12.4
				14	38.9	7.66	46.4	8.56	53.9	9.52	57.6	10.01	61.3	10.51	68.8	11.5	76.3	12.6
16	38.9			7.74	46.4	8.66	53.9	9.63	57.6	10.14	61.3	10.7	68.8	11.7	76.3	12.8		
18	38.9			7.82	46.4	8.76	53.9	9.76	57.6	10.27	61.3	10.8	68.8	11.9	76.3	13.0		
20	38.9			7.90	46.4	8.87	53.9	9.88	57.6	10.41	61.3	10.9	68.8	12.1	76.3	13.2		
21	38.9			7.94	46.4	8.92	53.9	9.95	57.6	10.48	61.3	11.0	68.8	12.1	76.3	13.3		
23	38.9			8.03	46.4	9.03	53.9	10.09	57.6	10.6	61.3	11.2	68.8	12.6	76.3	14.1		
25	38.9			8.12	46.4	9.15	53.9	10.43	57.6	11.1	61.3	11.8	68.8	13.4	76.3	15.0		
27	38.9			8.37	46.4	9.65	53.9	11.0	57.6	11.8	61.3	12.5	68.8	14.2	76.3	15.9		
29	38.9			8.83	46.4	10.19	53.9	11.7	57.6	12.5	61.3	13.3	68.8	15.0	76.3	16.9		
31	38.9			9.29	46.4	10.75	53.9	12.3	57.6	13.2	61.3	14.1	68.8	15.9	76.3	17.9		
33	38.9			9.78	46.4	11.3	53.9	13.0	57.6	13.9	61.3	14.9	68.8	16.9	76.3	19.0		
35	38.9			10.28	46.4	11.9	53.9	13.8	57.6	14.7	61.3	15.7	68.8	17.9	76.3	20.1		
37	38.9			10.80	46.4	12.6	53.9	14.5	57.6	15.5	61.3	16.6	68.8	18.9	76.3	21.3		
39	38.9			11.3	46.4	13.2	53.9	15.3	57.6	16.4	61.3	17.5	68.8	20.0	76.3	22.6		
50	47.00			10	32.4	6.81	38.6	7.49	44.9	8.21	48.0	8.58	51.1	8.96	57.4	9.73	63.6	10.54
				12	32.4	6.86	38.6	7.56	44.9	8.29	48.0	8.67	51.1	9.06	57.4	9.85	63.6	10.7
				14	32.4	6.92	38.6	7.63	44.9	8.38	48.0	8.77	51.1	9.16	57.4	9.98	63.6	10.8
		16	32.4	6.98	38.6	7.71	44.9	8.47	48.0	8.87	51.1	9.27	57.4	10.11	63.6	11.0		
		18	32.4	7.05	38.6	7.79	44.9	8.57	48.0	8.98	51.1	9.39	57.4	10.24	63.6	11.1		
		20	32.4	7.11	38.6	7.87	44.9	8.67	48.0	9.08	51.1	9.51	57.4	10.38	63.6	11.3		
		21	32.4	7.15	38.6	7.91	44.9	8.72	48.0	9.14	51.1	9.57	57.4	10.45	63.6	11.4		
		23	32.4	7.21	38.6	8.00	44.9	8.83	48.0	9.26	51.1	9.70	57.4	10.6	63.6	11.6		
		25	32.4	7.29	38.6	8.09	44.9	8.94	48.0	9.40	51.1	9.94	57.4	11.1	63.6	12.3		
		27	32.4	7.37	38.6	8.34	44.9	9.39	48.0	9.94	51.1	10.52	57.4	11.7	63.6	13.0		
		29	32.4	7.75	38.6	8.78	44.9	9.91	48.0	10.50	51.1	11.1	57.4	12.4	63.6	13.8		
		31	32.4	8.14														

# 5 Capacity tables

## 5 - 1 Cooling Capacity Tables

**RQYQ36PY1**

TC: Total Capacity: kW ; PI: Power Input: kW (compressor + outdoor fan motor)

Combination (%)	Capacity index (kW)	Outdoor air temp. °CDB	Indoor air temperature: °CWB													
			14.0		16.0		18.0		19.0		20.0		22.0		24.0	
			TC	PI	TC	PI	TC	PI	TC	PI	TC	PI	TC	PI	TC	PI
130	127.40	10	88,6	14,4	106	16,9	123	19,5	127	19,8	129	19,4	132	18,6	135	17,7
		12	88,6	14,6	106	17,1	123	19,8	126	19,7	127	19,3	130	18,4	134	18,2
		14	88,6	14,8	106	17,4	122	20,0	124	19,6	126	19,2	129	19,0	132	19,2
		16	88,6	15,0	106	17,7	121	19,9	122	19,7	124	19,8	127	20,0	130	20,2
		18	88,6	15,3	106	18,0	119	20,7	121	20,8	122	20,9	125	21,1	129	21,3
		20	88,6	15,5	106	19,1	117	21,7	119	21,8	121	21,9	124	22,1	127	22,3
		21	88,6	15,9	106	19,7	117	22,2	118	22,3	120	22,4	123	22,6	126	22,8
		23	88,6	17,0	106	21,1	115	23,2	117	23,3	118	23,4	121	23,6	125	23,9
		25	88,6	18,1	106	22,5	113	24,2	115	24,3	116	24,4	120	24,7	123	24,9
		27	88,6	19,2	106	24,0	112	25,2	113	25,3	115	25,5	118	25,7	121	26,0
		29	88,6	20,4	106	25,5	110	26,2	112	26,4	113	26,5	116	26,8	120	27,1
		31	88,6	21,7	105	27,0	108	27,3	110	27,4	112	27,6	115	27,9	118	28,1
		33	88,6	23,0	104	28,0	107	28,3	108	28,4	110	28,6	113	28,9	116	29,2
		35	88,6	24,4	102	29,0	105	29,3	107	29,5	108	29,7	111	30,0	115	30,3
		37	88,6	25,9	100	30,0	103	30,4	105	30,5	107	30,7	110	31,1	113	31,4
		39	88,6	27,4	98,6	31,0	102	31,4	103	31,6	105	31,8	108	32,1	111	32,5
		120	117.60	10	81,8	13,4	97,6	15,7	113	18,0	121	19,2	127	19,9	130	19,1
12	81,8			13,6	97,6	15,9	113	18,3	121	19,5	125	19,8	128	19,0	131	18,3
14	81,8			13,8	97,6	16,2	113	18,6	121	19,9	124	19,7	126	18,9	129	19,0
16	81,8			14,0	97,6	16,4	113	18,9	120	20,0	122	19,7	125	19,9	128	20,1
18	81,8			14,2	97,6	16,7	113	19,5	119	20,6	120	20,7	123	20,9	126	21,1
20	81,8			14,4	97,6	17,3	113	20,9	117	21,6	119	21,7	122	21,9	124	22,1
21	81,8			14,5	97,6	17,9	113	21,6	116	22,1	118	22,2	121	22,5	124	22,7
23	81,8			15,4	97,6	19,1	113	23,0	115	23,2	116	23,3	119	23,5	122	23,7
25	81,8			16,4	97,6	20,3	112	24,1	113	24,2	114	24,3	117	24,5	120	24,7
27	81,8			17,5	97,6	21,6	110	25,1	111	25,2	113	25,3	116	25,6	119	25,8
29	81,8			18,6	97,6	23,0	108	26,1	110	26,2	111	26,3	114	26,6	117	26,9
31	81,8			19,7	97,6	24,5	107	27,1	108	27,2	110	27,4	112	27,6	115	27,9
33	81,8			20,9	97,6	26,0	105	28,1	106	28,3	108	28,4	111	28,7	114	29,0
35	81,8			22,1	97,6	27,6	103	29,1	105	29,3	106	29,4	109	29,8	112	30,1
37	81,8			23,4	97,6	29,3	102	30,2	103	30,3	105	30,5	108	30,8	111	31,1
39	81,8			24,8	97,1	30,9	100	31,2	101	31,4	103	31,5	106	31,9	109	32,2
110	107.80			10	75,0	12,4	89,4	14,5	104	16,6	111	17,7	118	18,8	127	19,7
		12	75,0	12,6	89,4	14,7	104	16,9	111	18,0	118	19,1	126	19,6	129	18,9
		14	75,0	12,8	89,4	14,9	104	17,1	111	18,3	118	19,4	124	19,5	127	18,9
		16	75,0	13,0	89,4	15,1	104	17,4	111	18,6	118	19,7	123	19,8	125	19,9
		18	75,0	13,1	89,4	15,4	104	17,7	111	19,0	118	20,6	121	20,8	124	20,9
		20	75,0	13,3	89,4	15,6	104	18,7	111	20,4	117	21,6	119	21,8	122	22,0
		21	75,0	13,4	89,4	16,1	104	19,3	111	21,1	116	22,1	118	22,3	121	22,5
		23	75,0	14,0	89,4	17,1	104	20,6	111	22,5	114	23,1	117	23,3	120	23,5
		25	75,0	14,9	89,4	18,3	104	22,0	111	24,0	112	24,1	115	24,3	118	24,5
		27	75,0	15,8	89,4	19,4	104	23,4	109	25,0	111	25,1	114	25,4	116	25,6
		29	75,0	16,8	89,4	20,6	104	25,0	108	26,0	109	26,2	112	26,4	115	26,6
		31	75,0	17,8	89,4	21,9	104	26,6	106	27,1	108	27,2	110	27,4	113	27,7
		33	75,0	18,9	89,4	23,3	103	27,9	105	28,1	106	28,2	109	28,5	111	28,7
		35	75,0	20,0	89,4	24,7	102	29,0	103	29,1	104	29,2	107	29,5	110	29,8
		37	75,0	21,1	89,4	26,2	99,9	30,0	101	30,1	103	30,3	105	30,6	108	30,9
		39	75,0	22,4	89,4	27,8	98,3	31,0	99,6	31,2	101	31,3	104	31,6	106	31,9
		100	98.00	10	68,2	11,5	81,3	13,3	94,4	15,2	101	16,2	108	17,2	121	19,2
12	68,2			11,6	81,3	13,5	94,4	15,4	101	16,4	108	17,4	121	19,5	126	19,6
14	68,2			11,8	81,3	13,7	94,4	15,7	101	16,7	108	17,7	121	19,8	124	19,5
16	68,2			12,0	81,3	13,9	94,4	15,9	101	17,0	108	18,0	120	20,0	123	19,8
18	68,2			12,1	81,3	14,1	94,4	16,2	101	17,2	108	18,3	119	20,6	121	20,8
20	68,2			12,3	81,3	14,3	94,4	16,6	101	18,0	108	19,5	117	21,6	119	21,8
21	68,2			12,4	81,3	14,4	94,4	17,2	101	18,6	108	20,2	116	22,1	119	22,3
23	68,2			12,7	81,3	15,3	94,4	18,3	101	19,9	108	21,6	115	23,1	117	23,3
25	68,2			13,4	81,3	16,3	94,4	19,5	101	21,2	108	23,0	113	24,2	115	24,4
27	68,2			14,3	81,3	17,3	94,4	20,8	101	22,6	108	24,5	111	25,2	114	25,4
29	68,2			15,1	81,3	18,4	94,4	22,1	101	24,1	107	26,0	110	26,2	112	26,4
31	68,2			16,0	81,3	19,5	94,4	23,5	101	25,6	106	27,0	108	27,2	110	27,4
33	68,2			16,9	81,3	20,7	94,4	24,9	101	27,2	104	28,0	106	28,2	109	28,5
35	68,2			17,9	81,3	22,0	94,4	26,5	101	28,9	102	29,0	105	29,3	107	29,5
37	68,2			19,0	81,3	23,3	94,4	28,1	101	29,9	101	30,1	103	30,3	106	30,6
39	68,2			20,0	81,3	24,6	94,4	29,8	97,7	30,9	98,9	31,1	101	31,4	104	31,7

**NOTES - ANMERKUNGEN - Σημειώσεις - NOTAS - REMARQUES - NOTE - OPMERKINGEN - Примечания - NOTLAR**

- The above table shows the average value of conditions which may occur.  
 Die obige Tabelle zeigt den Durchschnittswert der Bedingungen, die auftreten können.  
 Στον παραπάνω πίνακα αναγράφεται η μέση τιμή για συνθήκες που μπορεί να προκύψουν.  
 La tabla de arriba muestra el valor medio de condiciones que pueden ocurrir.  
 Le tableau ci-dessus donne la valeur moyenne pour des conditions qui peuvent survenir.  
 La tabella in alto mostra il valore delle condizioni medie che si possono riscontrare.  
 De tabel hierboven geeft de gemiddelde waarde aan van situaties die kunnen voorvallen.  
 Таблица расположенная выше показывает среднее значение условий, которые могут наступить.  
 Yukarıdaki tablo meydana gelebilecek kopyulların ortalama değerini göstermektedir.

# 5 Capacity tables

## 5 - 1 Cooling Capacity Tables

5

RQYQ36PY1

TC: Total Capacity: kW ; PI: Power Input: kW (compressor + outdoor fan motor)

Combination (%)	Capacity index (kW)	Outdoor air temp. °CDB	Indoor air temperature: °CWB															
			14.0		16.0		18.0		19.0		20.0		22.0		24.0			
			TC	PI	TC	PI	TC	PI	TC	PI	TC	PI	TC	PI	TC	PI		
90	88.20	10	61.3	10.59	73.2	12.2	85.0	13.8	90.9	14.7	96.8	15.6	109	17.3	120	19.1		
		12	61.3	10.7	73.2	12.3	85.0	14.0	90.9	14.9	96.8	15.8	109	17.6	120	19.4		
		14	61.3	10.9	73.2	12.5	85.0	14.2	90.9	15.1	96.8	16.0	109	17.9	120	19.7		
		16	61.3	11.0	73.2	12.7	85.0	14.5	90.9	15.4	96.8	16.3	109	18.2	120	20.0		
		18	61.3	11.1	73.2	12.9	85.0	14.7	90.9	15.6	96.8	16.6	109	18.5	119	20.6		
		20	61.3	11.3	73.2	13.1	85.0	14.9	90.9	15.9	96.8	17.1	109	19.8	117	21.6		
		21	61.3	11.4	73.2	13.2	85.0	15.1	90.9	16.4	96.8	17.7	109	20.4	116	22.1		
		23	61.3	11.5	73.2	13.6	85.0	16.1	90.9	17.5	96.8	18.9	109	21.8	114	23.1		
		25	61.3	12.1	73.2	14.5	85.0	17.2	90.9	18.6	96.8	20.1	109	23.3	113	24.2		
		27	61.3	12.8	73.2	15.4	85.0	18.3	90.9	19.8	96.8	21.4	109	24.9	111	25.2		
		29	61.3	13.6	73.2	16.3	85.0	19.4	90.9	21.1	96.8	22.8	107	26.0	110	26.2		
		31	61.3	14.3	73.2	17.3	85.0	20.6	90.9	22.4	96.8	24.2	106	27.0	108	27.2		
		33	61.3	15.2	73.2	18.3	85.0	21.9	90.9	23.8	96.8	25.7	104	28.0	106	28.2		
		35	61.3	16.0	73.2	19.4	85.0	23.2	90.9	25.2	96.8	27.3	102	29.0	105	29.3		
		37	61.3	16.9	73.2	20.5	85.0	24.6	90.9	26.7	96.8	29.0	101	30.1	103	30.3		
		39	61.3	17.8	73.2	21.7	85.0	26.0	90.9	28.4	96.8	30.8	99.1	31.1	101	31.4		
		80	78.40	10	54.5	9.71	65.0	11.1	75.5	12.5	80.8	13.2	86.1	14.0	96.6	15.5	107	17.1
				12	54.5	9.83	65.0	11.2	75.5	12.7	80.8	13.4	86.1	14.2	96.6	15.8	107	17.4
				14	54.5	9.94	65.0	11.4	75.5	12.9	80.8	13.6	86.1	14.4	96.6	16.0	107	17.6
16	54.5			10.06	65.0	11.5	75.5	13.0	80.8	13.8	86.1	14.6	96.6	16.3	107	17.9		
18	54.5			10.19	65.0	11.7	75.5	13.2	80.8	14.0	86.1	14.8	96.6	16.5	107	18.2		
20	54.5			10.32	65.0	11.8	75.5	13.4	80.8	14.3	86.1	15.1	96.6	17.1	107	19.4		
21	54.5			10.39	65.0	11.9	75.5	13.5	80.8	14.4	86.1	15.4	96.6	17.6	107	20.1		
23	54.5			10.53	65.0	12.1	75.5	14.1	80.8	15.2	86.1	16.4	96.6	18.8	107	21.4		
25	54.5			10.8	65.0	12.8	75.5	15.0	80.8	16.2	86.1	17.4	96.6	20.1	107	22.9		
27	54.5			11.4	65.0	13.6	75.5	16.0	80.8	17.2	86.1	18.5	96.6	21.4	107	24.4		
29	54.5			12.1	65.0	14.4	75.5	16.9	80.8	18.3	86.1	19.7	96.6	22.7	107	26.0		
31	54.5			12.8	65.0	15.2	75.5	17.9	80.8	19.4	86.1	20.9	96.6	24.2	105	27.0		
33	54.5			13.5	65.0	16.1	75.5	19.0	80.8	20.6	86.1	22.2	96.6	25.7	104	28.0		
35	54.5			14.2	65.0	17.0	75.5	20.1	80.8	21.8	86.1	23.5	96.6	27.2	102	29.0		
37	54.5			15.0	65.0	18.0	75.5	21.3	80.8	23.1	86.1	25.0	96.6	28.9	100	30.0		
39	54.5			15.8	65.0	19.0	75.5	22.6	80.8	24.5	86.1	26.4	96.6	30.7	98.8	31.1		
70	68.60			10	47.7	8.88	56.9	10.02	66.1	11.2	70.7	11.8	75.3	12.5	84.5	13.8	93.7	15.1
				12	47.7	8.97	56.9	10.13	66.1	11.4	70.7	12.0	75.3	12.6	84.5	14.0	93.7	15.3
				14	47.7	9.07	56.9	10.26	66.1	11.5	70.7	12.2	75.3	12.8	84.5	14.2	93.7	15.6
		16	47.7	9.17	56.9	10.38	66.1	11.7	70.7	12.3	75.3	13.0	84.5	14.4	93.7	15.8		
		18	47.7	9.27	56.9	10.52	66.1	11.8	70.7	12.5	75.3	13.2	84.5	14.6	93.7	16.1		
		20	47.7	9.38	56.9	10.66	66.1	12.0	70.7	12.7	75.3	13.4	84.5	14.8	93.7	16.4		
		21	47.7	9.44	56.9	10.7	66.1	12.1	70.7	12.8	75.3	13.5	84.5	15.0	93.7	17.0		
		23	47.7	9.55	56.9	10.9	66.1	12.3	70.7	13.2	75.3	14.1	84.5	16.0	93.7	18.1		
		25	47.7	9.68	56.9	11.2	66.1	13.0	70.7	14.0	75.3	15.0	84.5	17.1	93.7	19.3		
		27	47.7	10.17	56.9	11.9	66.1	13.8	70.7	14.8	75.3	15.9	84.5	18.1	93.7	20.6		
		29	47.7	10.74	56.9	12.6	66.1	14.6	70.7	15.7	75.3	16.9	84.5	19.3	93.7	21.9		
		31	47.7	11.3	56.9	13.3	66.1	15.5	70.7	16.7	75.3	17.9	84.5	20.5	93.7	23.2		
		33	47.7	11.9	56.9	14.1	66.1	16.4	70.7	17.6	75.3	18.9	84.5	21.7	93.7	24.7		
		35	47.7	12.6	56.9	14.8	66.1	17.3	70.7	18.7	75.3	20.1	84.5	23.0	93.7	26.2		
		37	47.7	13.2	56.9	15.7	66.1	18.3	70.7	19.7	75.3	21.2	84.5	24.4	93.7	27.8		
		39	47.7	13.9	56.9	16.5	66.1	19.4	70.7	20.9	75.3	22.5	84.5	25.8	93.7	29.5		
		60	58.80	10	40.9	8.07	48.8	9.00	56.7	9.98	60.6	10.49	64.5	11.0	72.4	12.1	80.3	13.2
				12	40.9	8.15	48.8	9.10	56.7	10.10	60.6	10.62	64.5	11.1	72.4	12.2	80.3	13.4
				14	40.9	8.23	48.8	9.20	56.7	10.22	60.6	10.8	64.5	11.3	72.4	12.4	80.3	13.5
16	40.9			8.31	48.8	9.31	56.7	10.35	60.6	10.9	64.5	11.4	72.4	12.6	80.3	13.7		
18	40.9			8.40	48.8	9.41	56.7	10.48	60.6	11.0	64.5	11.6	72.4	12.8	80.3	14.0		
20	40.9			8.49	48.8	9.53	56.7	10.62	60.6	11.2	64.5	11.8	72.4	12.9	80.3	14.2		
21	40.9			8.53	48.8	9.58	56.7	10.7	60.6	11.3	64.5	11.8	72.4	13.0	80.3	14.3		
23	40.9			8.63	48.8	9.70	56.7	10.8	60.6	11.4	64.5	12.0	72.4	13.5	80.3	15.1		
25	40.9			8.73	48.8	9.83	56.7	11.2	60.6	11.9	64.5	12.7	72.4	14.3	80.3	16.1		
27	40.9			9.00	48.8	10.37	56.7	11.9	60.6	12.7	64.5	13.5	72.4	15.2	80.3	17.1		
29	40.9			9.48	48.8	10.9	56.7	12.5	60.6	13.4	64.5	14.3	72.4	16.2	80.3	18.2		
31	40.9			9.98	48.8	11.5	56.7	13.3	60.6	14.2	64.5	15.1	72.4	17.1	80.3	19.3		
33	40.9			10.50	48.8	12.2	56.7	14.0	60.6	15.0	64.5	16.0	72.4	18.1	80.3	20.4		
35	40.9			11.04	48.8	12.8	56.7	14.8	60.6	15.8	64.5	16.9	72.4	19.2	80.3	21.6		
37	40.9			11.6	48.8	13.5	56.7	15.6	60.6	16.7	64.5	17.8	72.4	20.3	80.3	22.9		
39	40.9			12.2	48.8	14.2	56.7	16.4	60.6	17.6	64.5	18.9	72.4	21.5	80.3	24.3		
50	49.00			10	34.1	7.32	40.6	8.05	47.2	8.82	50.5	9.21	53.8	9.62	60.4	10.46	66.9	11.3
				12	34.1	7.38	40.6	8.12	47.2	8.91	50.5	9.32	53.8	9.73	60.4	10.59	66.9	11.5
				14	34.1	7.44	40.6	8.20	47.2	9.00	50.5	9.42	53.8	9.84	60.4	10.7	66.9	11.6
		16	34.1	7.50	40.6	8.28	47.2	9.10	50.5	9.53	53.8	9.96	60.4	10.9	66.9	11.8		
		18	34.1	7.57	40.6	8.37	47.2	9.21	50.5	9.64	53.8	10.09	60.4	11.0	66.9	11.9		
		20	34.1	7.64	40.6	8.46	47.2	9.32	50.5	9.76	53.8	10.21	60.4	11.1	66.9	12.1		
		21	34.1	7.68	40.6	8.50	47.2	9.37	50.5	9.82	53.8	10.28	60.4	11.2	66.9	12.2		
		23	34.1	7.75	40.6	8.60	47.2	9.49	50.5	9.95	53.8	10.42	60.4	11.4	66.9	12.4		
		25	34.1	7.83	40.6	8.69	47.2	9.61	50.5	10.10	53.8	10.68	60.4	11.9	66.9	13.2		
		27	34.1	7.91	40.6	8.96	47.2	10.08	50.5	10.68	53.8	11.3	60.4	12.6	66.9	14.0		
		29	34.1	8.32	40.6	9.44	47.2	10.65	50.5	11.3	53.8	11.9	60.4	13.3	66.9	14.8		
		31	34.1	8.75	40.6	9.												

# 5 Capacity tables

## 5 - 1 Cooling Capacity Tables

RQYQ38PY1

TC: Total Capacity: kW ; PI: Power Input: kW (compressor + outdoor fan motor)

Combination (%)	Capacity index (kW)	Outdoor air temp. °CDB	Indoor air temperature: °CWB															
			14.0		16.0		18.0		19.0		20.0		22.0		24.0			
			TC	PI	TC	PI	TC	PI	TC	PI	TC	PI	TC	PI	TC	PI		
130	136.50	10	93.9	15.6	112	18.4	130	21.2	135	21.5	136	21.1	140	20.2	143	19.3		
		12	93.9	15.8	112	18.6	130	21.5	133	21.4	135	20.9	138	20.0	141	19.7		
		14	93.9	16.1	112	18.9	130	21.7	131	21.3	133	20.8	136	20.7	140	20.8		
		16	93.9	16.3	112	19.2	128	21.6	130	21.5	131	21.6	135	21.8	138	22.0		
		18	93.9	16.6	112	19.5	126	22.4	128	22.6	129	22.7	133	22.9	136	23.1		
		20	93.9	16.8	112	20.7	124	23.5	126	23.7	128	23.8	131	24.0	135	24.2		
		21	93.9	17.3	112	21.4	123	24.1	125	24.2	127	24.3	130	24.6	134	24.8		
		23	93.9	18.4	112	22.9	122	25.2	123	25.3	125	25.4	129	25.7	132	26.0		
		25	93.9	19.6	112	24.4	120	26.3	122	26.4	123	26.6	127	26.8	130	27.1		
		27	93.9	20.9	112	26.0	118	27.4	120	27.5	122	27.7	125	28.0	128	28.3		
		29	93.9	22.2	112	27.7	117	28.5	118	28.7	120	28.8	123	29.1	127	29.4		
		31	93.9	23.6	111	29.3	115	29.6	116	29.8	118	29.9	122	30.3	125	30.6		
		33	93.9	25.0	110	30.4	113	30.7	115	30.9	116	31.1	120	31.4	123	31.8		
		35	93.9	26.5	108	31.5	111	31.9	113	32.0	115	32.2	118	32.6	121	32.9		
		37	93.9	28.1	106	32.6	110	33.0	111	33.2	113	33.4	116	33.8	120	34.1		
		39	93.9	29.8	104	33.7	108	34.1	110	34.3	111	34.5	115	34.9	118	35.3		
		120	126.00	10	86.7	14.5	103	17.0	120	19.6	128	20.9	134	21.6	137	20.8	141	20.0
				12	86.7	14.7	103	17.3	120	19.9	128	21.2	133	21.5	136	20.7	139	19.8
				14	86.7	15.0	103	17.6	120	20.2	128	21.6	131	21.4	134	20.5	137	20.7
16	86.7			15.2	103	17.8	120	20.5	128	21.7	129	21.4	132	21.6	135	21.8		
18	86.7			15.4	103	18.1	120	21.2	126	22.4	127	22.5	130	22.7	134	22.9		
20	86.7			15.7	103	18.8	120	22.7	124	23.5	126	23.6	129	23.8	132	24.1		
21	86.7			15.8	103	19.4	120	23.5	123	24.1	125	24.2	128	24.4	131	24.6		
23	86.7			16.8	103	20.7	120	25.0	121	25.2	123	25.3	126	25.5	129	25.7		
25	86.7			17.9	103	22.1	118	26.1	120	26.3	121	26.4	124	26.6	128	26.9		
27	86.7			19.0	103	23.5	116	27.2	118	27.4	120	27.5	123	27.8	126	28.0		
29	86.7			20.2	103	25.0	115	28.3	116	28.5	118	28.6	121	28.9	124	29.2		
31	86.7			21.4	103	26.6	113	29.4	114	29.6	116	29.7	119	30.0	122	30.3		
33	86.7			22.7	103	28.2	111	30.5	113	30.7	114	30.9	117	31.2	121	31.5		
35	86.7			24.0	103	30.0	109	31.7	111	31.8	113	32.0	116	32.3	119	32.7		
37	86.7			25.5	103	31.8	108	32.8	109	33.0	111	33.1	114	33.5	117	33.8		
39	86.7			27.0	103	33.5	106	33.9	108	34.1	109	34.3	112	34.6	115	35.0		
110	115.50			10	79.4	13.5	94.7	15.7	110	18.1	118	19.2	125	20.4	135	21.4	138	20.7
				12	79.4	13.7	94.7	16.0	110	18.3	118	19.5	125	20.8	133	21.3	136	20.6
				14	79.4	13.9	94.7	16.2	110	18.6	118	19.8	125	21.1	132	21.2	134	20.5
		16	79.4	14.1	94.7	16.5	110	18.9	118	20.2	125	21.4	130	21.5	133	21.6		
		18	79.4	14.3	94.7	16.7	110	19.2	118	20.6	125	22.4	128	22.6	131	22.8		
		20	79.4	14.5	94.7	17.0	110	20.3	118	22.1	123	23.5	126	23.7	129	23.9		
		21	79.4	14.6	94.7	17.5	110	21.0	118	22.9	123	24.0	125	24.2	128	24.4		
		23	79.4	15.2	94.7	18.6	110	22.4	118	24.4	121	25.1	124	25.3	127	25.5		
		25	79.4	16.2	94.7	19.8	110	23.9	118	26.1	119	26.2	122	26.4	125	26.7		
		27	79.4	17.2	94.7	21.1	110	25.5	116	27.2	117	27.3	120	27.6	123	27.8		
		29	79.4	18.2	94.7	22.4	110	27.1	114	28.3	116	28.4	119	28.7	121	28.9		
		31	79.4	19.3	94.7	23.8	110	28.8	112	29.4	114	29.5	117	29.8	120	30.1		
		33	79.4	20.5	94.7	25.3	109	30.4	111	30.5	112	30.6	115	30.9	118	31.2		
		35	79.4	21.7	94.7	26.8	108	31.5	109	31.6	110	31.8	113	32.1	116	32.4		
		37	79.4	23.0	94.7	28.5	106	32.6	107	32.7	109	32.9	112	33.2	114	33.5		
		39	79.4	24.3	94.7	30.2	104	33.7	106	33.9	107	34.0	110	34.4	113	34.7		
		100	105.00	10	72.2	12.5	86.1	14.5	100	16.5	107	17.6	114	18.7	128	20.8	135	21.4
				12	72.2	12.7	86.1	14.7	100	16.8	107	17.9	114	18.9	128	21.2	134	21.3
				14	72.2	12.8	86.1	14.9	100	17.0	107	18.1	114	19.2	128	21.5	132	21.1
16	72.2			13.0	86.1	15.1	100	17.3	107	18.4	114	19.6	127	21.7	130	21.5		
18	72.2			13.2	86.1	15.3	100	17.6	107	18.7	114	19.9	126	22.4	128	22.6		
20	72.2			13.4	86.1	15.6	100	18.0	107	19.6	114	21.2	124	23.5	127	23.7		
21	72.2			13.5	86.1	15.7	100	18.6	107	20.2	114	21.9	123	24.1	126	24.2		
23	72.2			13.8	86.1	16.7	100	19.9	107	21.6	114	23.4	121	25.1	124	25.3		
25	72.2			14.6	86.1	17.7	100	21.2	107	23.1	114	25.0	120	26.2	122	26.5		
27	72.2			15.5	86.1	18.8	100	22.6	107	24.6	114	26.7	118	27.4	120	27.6		
29	72.2			16.4	86.1	20.0	100	24.0	107	26.1	114	28.2	116	28.5	119	28.7		
31	72.2			17.4	86.1	21.2	100	25.5	107	27.8	112	29.3	114	29.6	117	29.8		
33	72.2			18.4	86.1	22.5	100	27.1	107	29.6	110	30.4	113	30.7	115	31.0		
35	72.2			19.5	86.1	23.9	100	28.8	107	31.4	108	31.5	111	31.8	114	32.1		
37	72.2			20.6	86.1	25.3	100	30.5	105	32.5	107	32.7	109	32.9	112	33.2		
39	72.2			21.8	86.1	26.8	100	32.4	104	33.6	105	33.8	107	34.1	110	34.4		

**NOTES - ANMERKUNGEN - Σημειώσεις - NOTAS - REMARQUES - NOTE - OPMERKINGEN - Примечания - NOTLAR**

- The above table shows the average value of conditions which may occur.  
 Die obige Tabelle zeigt den Durchschnittswert der Bedingungen, die auftreten können.  
 Στον παραπάνω πίνακα αναγράφεται η μέση τιμή για συνθήκες που μπορεί να προκύψουν.  
 La tabla de arriba muestra el valor medio de condiciones que pueden ocurrir.  
 Le tableau ci-dessus donne la valeur moyenne pour des conditions qui peuvent survenir.  
 La tabella in alto mostra il valore delle condizioni medie che si possono riscontrare.  
 De tabel hierboven geeft de gemiddelde waarde aan van situaties die kunnen voorvallen.  
 Таблица расположенная выше показывает среднее значение условий, которые могут наступить.  
 Yukarıdaki tablo meydana gelebilecek kopyulların ortalama deđerini göstermektedir.



# 5 Capacity tables

## 5 - 1 Cooling Capacity Tables

5

RQYQ38PY1

TC: Total Capacity: kW ; PI: Power Input: kW (compressor + outdoor fan motor)

Combination (%)	Capacity index (kW)	Outdoor air temp. °CDB	Indoor air temperature: °CWB															
			14.0		16.0		18.0		19.0		20.0		22.0		24.0			
			TC	PI	TC	PI	TC	PI	TC	PI	TC	PI	TC	PI	TC	PI		
90	94.50	10	65.0	11.5	77.5	13.2	90.0	15.0	96.3	16.0	103	16.9	115	18.8	128	20.8		
		12	65.0	11.6	77.5	13.4	90.0	15.3	96.3	16.2	103	17.2	115	19.1	128	21.1		
		14	65.0	11.8	77.5	13.6	90.0	15.5	96.3	16.4	103	17.4	115	19.4	128	21.4		
		16	65.0	11.9	77.5	13.8	90.0	15.7	96.3	16.7	103	17.7	115	19.7	127	21.7		
		18	65.0	12.1	77.5	14.0	90.0	16.0	96.3	17.0	103	18.0	115	20.1	126	22.4		
		20	65.0	12.3	77.5	14.2	90.0	16.2	96.3	17.2	103	18.6	115	21.5	124	23.5		
		21	65.0	12.4	77.5	14.3	90.0	16.5	96.3	17.8	103	19.2	115	22.2	123	24.0		
		23	65.0	12.5	77.5	14.8	90.0	17.5	96.3	19.0	103	20.5	115	23.7	121	25.1		
		25	65.0	13.1	77.5	15.8	90.0	18.7	96.3	20.2	103	21.9	115	25.3	120	26.2		
		27	65.0	13.9	77.5	16.7	90.0	19.9	96.3	21.5	103	23.3	115	27.0	118	27.3		
		29	65.0	14.7	77.5	17.7	90.0	21.1	96.3	22.9	103	24.8	114	28.2	116	28.5		
		31	65.0	15.6	77.5	18.8	90.0	22.4	96.3	24.3	103	26.3	112	29.3	114	29.6		
		33	65.0	16.5	77.5	19.9	90.0	23.8	96.3	25.8	103	28.0	110	30.5	113	30.7		
		35	65.0	17.4	77.5	21.1	90.0	25.2	96.3	27.4	103	29.7	109	31.6	111	31.8		
		37	65.0	18.4	77.5	22.3	90.0	26.7	96.3	29.1	103	31.5	107	32.7	109	32.9		
		39	65.0	19.4	77.5	23.6	90.0	28.3	96.3	30.8	103	33.5	105	33.8	107	34.1		
		80	84.00	10	57.8	10.56	68.9	12.0	80.0	13.6	85.6	14.4	91.2	15.2	102	16.9	113	18.6
				12	57.8	10.68	68.9	12.2	80.0	13.8	85.6	14.6	91.2	15.4	102	17.1	113	18.9
14	57.8			10.80	68.9	12.3	80.0	14.0	85.6	14.8	91.2	15.7	102	17.4	113	19.2		
16	57.8			10.93	68.9	12.5	80.0	14.2	85.6	15.0	91.2	15.9	102	17.7	113	19.5		
18	57.8			11.07	68.9	12.7	80.0	14.4	85.6	15.2	91.2	16.1	102	17.9	113	19.8		
20	57.8			11.21	68.9	12.9	80.0	14.6	85.6	15.5	91.2	16.4	102	18.5	113	21.1		
21	57.8			11.28	68.9	13.0	80.0	14.7	85.6	15.6	91.2	16.7	102	19.2	113	21.8		
23	57.8			11.4	68.9	13.1	80.0	15.4	85.6	16.5	91.2	17.8	102	20.4	113	23.3		
25	57.8			11.8	68.9	13.9	80.0	16.3	85.6	17.6	91.2	18.9	102	21.8	113	24.9		
27	57.8			12.4	68.9	14.8	80.0	17.3	85.6	18.7	91.2	20.1	102	23.2	113	26.5		
29	57.8			13.1	68.9	15.6	80.0	18.4	85.6	19.9	91.2	21.4	102	24.7	113	28.2		
31	57.8			13.9	68.9	16.6	80.0	19.5	85.6	21.1	91.2	22.7	102	26.2	112	29.3		
33	57.8			14.7	68.9	17.5	80.0	20.7	85.6	22.4	91.2	24.1	102	27.9	110	30.4		
35	57.8			15.5	68.9	18.5	80.0	21.9	85.6	23.7	91.2	25.6	102	29.6	108	31.5		
37	57.8			16.3	68.9	19.6	80.0	23.2	85.6	25.1	91.2	27.1	102	31.4	106	32.6		
39	57.8			17.2	68.9	20.7	80.0	24.5	85.6	26.6	91.2	28.7	102	33.3	105	33.8		
70	73.50			10	50.5	9.64	60.3	10.88	70.0	12.2	74.9	12.9	79.8	13.5	89.5	15.0	99.3	16.4
				12	50.5	9.75	60.3	11.01	70.0	12.3	74.9	13.0	79.8	13.7	89.5	15.2	99.3	16.7
		14	50.5	9.85	60.3	11.14	70.0	12.5	74.9	13.2	79.8	13.9	89.5	15.4	99.3	16.9		
		16	50.5	9.96	60.3	11.28	70.0	12.7	74.9	13.4	79.8	14.1	89.5	15.6	99.3	17.2		
		18	50.5	10.08	60.3	11.4	70.0	12.9	74.9	13.6	79.8	14.3	89.5	15.9	99.3	17.4		
		20	50.5	10.19	60.3	11.6	70.0	13.0	74.9	13.8	79.8	14.6	89.5	16.1	99.3	17.9		
		21	50.5	10.26	60.3	11.7	70.0	13.1	74.9	13.9	79.8	14.7	89.5	16.3	99.3	18.5		
		23	50.5	10.38	60.3	11.8	70.0	13.3	74.9	14.3	79.8	15.3	89.5	17.4	99.3	19.7		
		25	50.5	10.51	60.3	12.2	70.0	14.2	74.9	15.2	79.8	16.3	89.5	18.5	99.3	21.0		
		27	50.5	11.05	60.3	12.9	70.0	15.0	74.9	16.1	79.8	17.3	89.5	19.7	99.3	22.3		
		29	50.5	11.7	60.3	13.7	70.0	15.9	74.9	17.1	79.8	18.3	89.5	20.9	99.3	23.8		
		31	50.5	12.3	60.3	14.5	70.0	16.8	74.9	18.1	79.8	19.4	89.5	22.2	99.3	25.3		
		33	50.5	13.0	60.3	15.3	70.0	17.8	74.9	19.2	79.8	20.6	89.5	23.6	99.3	26.8		
		35	50.5	13.7	60.3	16.1	70.0	18.8	74.9	20.3	79.8	21.8	89.5	25.0	99.3	28.5		
		37	50.5	14.4	60.3	17.0	70.0	19.9	74.9	21.5	79.8	23.1	89.5	26.5	99.3	30.2		
		39	50.5	15.1	60.3	17.9	70.0	21.0	74.9	22.7	79.8	24.4	89.5	28.1	99.3	32.0		
		60	63.00	10	43.3	8.77	51.7	9.78	60.0	10.85	64.2	11.4	68.4	12.0	76.7	13.1	85.1	14.3
				12	43.3	8.86	51.7	9.89	60.0	10.98	64.2	11.5	68.4	12.1	76.7	13.3	85.1	14.5
14	43.3			8.94	51.7	10.00	60.0	11.11	64.2	11.7	68.4	12.3	76.7	13.5	85.1	14.7		
16	43.3			9.03	51.7	10.11	60.0	11.25	64.2	11.8	68.4	12.4	76.7	13.7	85.1	14.9		
18	43.3			9.13	51.7	10.23	60.0	11.4	64.2	12.0	68.4	12.6	76.7	13.9	85.1	15.2		
20	43.3			9.22	51.7	10.35	60.0	11.5	64.2	12.2	68.4	12.8	76.7	14.1	85.1	15.4		
21	43.3			9.27	51.7	10.41	60.0	11.6	64.2	12.2	68.4	12.9	76.7	14.2	85.1	15.5		
23	43.3			9.38	51.7	10.54	60.0	11.8	64.2	12.4	68.4	13.1	76.7	14.7	85.1	16.4		
25	43.3			9.48	51.7	10.68	60.0	12.2	64.2	13.0	68.4	13.8	76.7	15.6	85.1	17.5		
27	43.3			9.77	51.7	11.26	60.0	12.9	64.2	13.8	68.4	14.6	76.7	16.5	85.1	18.6		
29	43.3			10.30	51.7	11.9	60.0	13.6	64.2	14.6	68.4	15.5	76.7	17.5	85.1	19.7		
31	43.3			10.85	51.7	12.5	60.0	14.4	64.2	15.4	68.4	16.4	76.7	18.6	85.1	20.9		
33	43.3			11.41	51.7	13.2	60.0	15.2	64.2	16.3	68.4	17.4	76.7	19.7	85.1	22.2		
35	43.3			12.0	51.7	13.9	60.0	16.1	64.2	17.2	68.4	18.4	76.7	20.8	85.1	23.5		
37	43.3			12.6	51.7	14.7	60.0	16.9	64.2	18.1	68.4	19.4	76.7	22.1	85.1	24.9		
39	43.3			13.2	51.7	15.4	60.0	17.9	64.2	19.1	68.4	20.5	76.7	23.3	85.1	26.4		
50	52.50			10	36.1	7.95	43.1	8.74	50.0	9.58	53.5	10.01	57.0	10.45	63.9	11.4	70.9	12.3
				12	36.1	8.01	43.1	8.82	50.0	9.68	53.5	10.12	57.0	10.57	63.9	11.5	70.9	12.5
		14	36.1	8.08	43.1	8.91	50.0	9.78	53.5	10.23	57.0	10.70	63.9	11.6	70.9	12.6		
		16	36.1	8.15	43.1	9.00	50.0	9.89	53.5	10.35	57.0	10.83	63.9	11.8	70.9	12.8		
		18	36.1	8.23	43.1	9.09	50.0	10.00	53.5	10.48	57.0	10.96	63.9	12.0	70.9	13.0		
		20	36.1	8.30	43.1	9.19	50.0	10.12	53.5	10.60	57.0	11.10	63.9	12.1	70.9	13.2		
		21	36.1	8.34	43.1	9.24	50.0	10.18	53.5	10.67	57.0	11.17	63.9	12.2	70.9	13.3		
		23	36.1	8.42	43.1	9.34	50.0	10.31	53.5	10.81	57.0	11.3	63.9	12.4	70.9	13.5		
		25	36.1	8.51	43.1	9.45	50.0	10.44	53.5	10.98	57.0	11.6	63.9	12.9	70.9	14.3		
		27	36.1	8.60	43.1	9.73	50.0	10.96	53.5	11.6	57.0	12.3	63.9	13.7	70.9	15.2		
		29	36.1	9.04	43.1	10.25	50.0	11.6	53.5	12.3	57.0	13.0	63.9	14.5	70.9	16.1		
		31	36.1	9.50	43.1	10.80												



# 5 Capacity tables

## 5 - 1 Cooling Capacity Tables

RQYQ40PY1																		
TC: Total Capacity: kW ; PI: Power Input: kW (compressor + outdoor fan motor)																		
Combination (%)	Capacity index (kW)	Outdoor air temp. °CDB	Indoor air temperature: °CWB															
			14.0		16.0		18.0		19.0		20.0		22.0		24.0			
			TC	PI	TC	PI	TC	PI	TC	PI	TC	PI	TC	PI	TC	PI		
130	146.12	10	98,3	16,8	117	19,8	136	22,8	141	23,1	143	22,7	146	21,7	150	20,7		
		12	98,3	17,0	117	20,1	136	23,1	139	23,0	141	22,5	145	21,6	148	21,2		
		14	98,3	17,3	117	20,4	136	23,4	137	22,9	139	22,4	143	22,2	146	22,4		
		16	98,3	17,6	117	20,7	134	23,3	136	23,1	137	23,2	141	23,4	144	23,7		
		18	98,3	17,8	117	21,0	132	24,2	134	24,3	136	24,4	139	24,6	143	24,9		
		20	98,3	18,1	117	22,3	130	25,3	132	25,5	134	25,6	137	25,8	141	26,1		
		21	98,3	18,6	117	23,1	129	25,9	131	26,1	133	26,2	136	26,4	140	26,7		
		23	98,3	19,8	117	24,7	127	27,1	129	27,2	131	27,4	135	27,7	138	27,9		
		25	98,3	21,1	117	26,3	126	28,3	127	28,4	129	28,6	133	28,9	136	29,2		
		27	98,3	22,5	117	28,0	124	29,5	126	29,6	127	29,8	131	30,1	134	30,4		
		29	98,3	23,9	117	29,9	122	30,7	124	30,8	126	31,0	129	31,3	133	31,7		
		31	98,3	25,4	117	31,5	120	31,9	122	32,1	124	32,2	127	32,6	131	32,9		
		33	98,3	26,9	115	32,7	118	33,1	120	33,3	122	33,5	125	33,8	129	34,2		
		35	98,3	28,6	113	33,9	117	34,3	118	34,5	120	34,7	124	35,1	127	35,5		
		37	98,3	30,3	111	35,1	115	35,5	116	35,7	118	35,9	122	36,3	125	36,7		
		39	98,3	32,1	109	36,3	113	36,7	115	37,0	116	37,2	120	37,6	124	38,0		
		120	134.88	10	90,7	15,7	108	18,3	126	21,1	134	22,5	141	23,3	144	22,4	147	21,5
				12	90,7	15,9	108	18,6	126	21,4	134	22,9	139	23,1	142	22,3	145	21,4
				14	90,7	16,1	108	18,9	126	21,8	134	23,2	137	23,0	140	22,1	143	22,3
16	90,7			16,3	108	19,2	126	22,1	133	23,4	135	23,1	138	23,3	142	23,5		
18	90,7			16,6	108	19,5	126	22,8	132	24,1	133	24,2	137	24,5	140	24,7		
20	90,7			16,9	108	20,2	126	24,4	130	25,3	131	25,4	135	25,7	138	25,9		
21	90,7			17,0	108	20,9	126	25,3	129	25,9	131	26,0	134	26,3	137	26,5		
23	90,7			18,1	108	22,3	125	27,0	127	27,1	129	27,2	132	27,5	135	27,7		
25	90,7			19,2	108	23,8	124	28,1	125	28,3	127	28,4	130	28,7	133	28,9		
27	90,7			20,4	108	25,3	122	29,3	123	29,5	125	29,6	128	29,9	132	30,2		
29	90,7			21,7	108	26,9	120	30,5	122	30,6	123	30,8	127	31,1	130	31,4		
31	90,7			23,0	108	28,6	118	31,7	120	31,8	121	32,0	125	32,3	128	32,6		
33	90,7			24,4	108	30,4	116	32,9	118	33,0	120	33,2	123	33,6	126	33,9		
35	90,7			25,9	108	32,3	115	34,1	116	34,3	118	34,4	121	34,8	124	35,2		
37	90,7			27,4	108	34,3	113	35,3	114	35,5	116	35,7	119	36,0	123	36,4		
39	90,7			29,0	108	36,1	111	36,5	113	36,7	114	36,9	117	37,3	121	37,7		
110	123.64			10	83,1	14,5	99	16,9	115	19,4	123	20,7	131	22,0	141	23,1	144	22,3
				12	83,1	14,7	99	17,2	115	19,7	123	21,0	131	22,3	140	22,9	143	22,1
				14	83,1	14,9	99	17,4	115	20,0	123	21,4	131	22,7	138	22,8	141	22,1
		16	83,1	15,2	99	17,7	115	20,4	123	21,7	131	23,1	136	23,1	139	23,3		
		18	83,1	15,4	99	18,0	115	20,7	123	22,2	131	24,1	134	24,3	137	24,5		
		20	83,1	15,6	99	18,3	115	21,8	123	23,8	129	25,3	132	25,5	135	25,7		
		21	83,1	15,7	99	18,8	115	22,6	123	24,6	128	25,9	131	26,1	134	26,3		
		23	83,1	16,4	99	20,0	115	24,1	123	26,3	127	27,0	130	27,3	133	27,5		
		25	83,1	17,4	99	21,3	115	25,7	123	28,1	125	28,2	128	28,5	131	28,7		
		27	83,1	18,5	99	22,7	115	27,4	121	29,3	123	29,4	126	29,7	129	29,9		
		29	83,1	19,6	99	24,1	115	29,2	120	30,5	121	30,6	124	30,9	127	31,1		
		31	83,1	20,8	99	25,6	115	31,1	118	31,6	119	31,8	122	32,1	125	32,4		
		33	83,1	22,1	99	27,2	114	32,7	116	32,8	117	33,0	120	33,3	123	33,6		
		35	83,1	23,3	99	28,9	113	33,9	114	34,0	116	34,2	119	34,5	122	34,9		
		37	83,1	24,7	99	30,6	111	35,1	112	35,2	114	35,4	117	35,8	120	36,1		
		39	83,1	26,1	99	32,5	109	36,3	110	36,4	112	36,6	115	37,0	118	37,4		
		100	112.40	10	75,6	13,4	90,2	15,6	105	17,8	112	18,9	119	20,1	134	22,4	142	23,0
				12	75,6	13,6	90,2	15,8	105	18,1	112	19,2	119	20,4	134	22,8	140	22,9
				14	75,6	13,8	90,2	16,0	105	18,3	112	19,5	119	20,7	134	23,1	138	22,8
16	75,6			14,0	90,2	16,3	105	18,6	112	19,8	119	21,0	133	23,4	136	23,1		
18	75,6			14,2	90,2	16,5	105	18,9	112	20,1	119	21,4	132	24,1	134	24,3		
20	75,6			14,4	90,2	16,8	105	19,4	112	21,1	119	22,8	130	25,3	132	25,5		
21	75,6			14,5	90,2	16,9	105	20,1	112	21,8	119	23,6	129	25,9	132	26,1		
23	75,6			14,8	90,2	17,9	105	21,4	112	23,3	119	25,2	127	27,1	130	27,3		
25	75,6			15,7	90,2	19,1	105	22,8	112	24,8	119	26,9	125	28,3	128	28,5		
27	75,6			16,7	90,2	20,3	105	24,3	112	26,4	119	28,7	123	29,4	126	29,7		
29	75,6			17,7	90,2	21,5	105	25,8	112	28,1	119	30,4	122	30,6	124	30,9		
31	75,6			18,7	90,2	22,9	105	27,5	112	29,9	117	31,6	120	31,8	122	32,1		
33	75,6			19,8	90,2	24,2	105	29,2	112	31,8	115	32,8	118	33,0	121	33,3		
35	75,6			21,0	90,2	25,7	105	31,0	112	33,8	113	33,9	116	34,2	119	34,5		
37	75,6			22,2	90,2	27,2	105	32,9	110	35,0	112	35,1	114	35,5	117	35,8		
39	75,6			23,4	90,2	28,8	105	34,9	108	36,2	110	36,4	112	36,7	115	37,0		

**NOTES - ANMERKUNGEN - Σημειώσεις - NOTAS - REMARQUES - NOTE - OPMERKINGEN - Примечания - NOTLAR**

- The above table shows the average value of conditions which may occur.  
 Die obige Tabelle zeigt den Durchschnittswert der Bedingungen, die auftreten können.  
 Στον παραπάνω πίνακα αναγράφεται η μέση τιμή για συνθήκες που μπορεί να προκύψουν.  
 La tabla de arriba muestra el valor medio de condiciones que pueden ocurrir.  
 Le tableau ci-dessus donne la valeur moyenne pour des conditions qui peuvent survenir.  
 La tabella in alto mostra il valore delle condizioni medie che si possono riscontrare.  
 De tabel hierboven geeft de gemiddelde waarde aan van situaties die kunnen voorvallen.  
 Таблица расположенная выше показывает среднее значение условий, которые могут наступить.  
 Yukarıdaki tablo meydana gelebilecek koşulların ortalama değerini göstermektedir.

# 5 Capacity tables

## 5 - 1 Cooling Capacity Tables

5

RQYQ40PY1

TC: Total Capacity: kW ; PI: Power Input: kW (compressor + outdoor fan motor)

Combination (%)	Capacity index (kW)	Outdoor air temp. °CDB	Indoor air temperature: °CWB															
			14.0		16.0		18.0		19.0		20.0		22.0		24.0			
			TC	PI	TC	PI	TC	PI	TC	PI	TC	PI	TC	PI	TC	PI		
90	101.16	10	68.0	12.4	81.1	14.2	94.2	16.2	101	17.2	107	18.2	120	20.3	134	22.4		
		12	68.0	12.5	81.1	14.4	94.2	16.4	101	17.4	107	18.5	120	20.6	134	22.7		
		14	68.0	12.7	81.1	14.6	94.2	16.7	101	17.7	107	18.8	120	20.9	134	23.1		
		16	68.0	12.9	81.1	14.8	94.2	16.9	101	18.0	107	19.1	120	21.2	133	23.4		
		18	68.0	13.0	81.1	15.1	94.2	17.2	101	18.3	107	19.4	120	21.6	132	24.1		
		20	68.0	13.2	81.1	15.3	94.2	17.4	101	18.6	107	20.0	120	23.1	130	25.3		
		21	68.0	13.3	81.1	15.4	94.2	17.7	101	19.2	107	20.7	120	23.9	129	25.9		
		23	68.0	13.5	81.1	16.0	94.2	18.9	101	20.4	107	22.1	120	25.6	127	27.1		
		25	68.0	14.1	81.1	17.0	94.2	20.1	101	21.8	107	23.5	120	27.3	125	28.3		
		27	68.0	15.0	81.1	18.0	94.2	21.4	101	23.2	107	25.1	120	29.1	123	29.4		
		29	68.0	15.9	81.1	19.1	94.2	22.7	101	24.6	107	26.7	119	30.4	122	30.6		
		31	68.0	16.8	81.1	20.2	94.2	24.1	101	26.2	107	28.3	117	31.6	120	31.8		
		33	68.0	17.7	81.1	21.4	94.2	25.6	101	27.8	107	30.1	115	32.8	118	33.0		
		35	68.0	18.7	81.1	22.7	94.2	27.1	101	29.5	107	32.0	114	34.0	116	34.2		
		37	68.0	19.8	81.1	24.0	94.2	28.7	101	31.3	107	33.9	112	35.2	114	35.5		
		39	68.0	20.9	81.1	25.4	94.2	30.5	101	33.2	107	36.0	110	36.4	112	36.7		
		80	89.92	10	60.5	11.4	72.1	13.0	83.8	14.6	89.6	15.5	95.4	16.4	107	18.2	119	20.0
				12	60.5	11.5	72.1	13.1	83.8	14.8	89.6	15.7	95.4	16.6	107	18.4	119	20.3
				14	60.5	11.6	72.1	13.3	83.8	15.0	89.6	15.9	95.4	16.8	107	18.7	119	20.6
16	60.5			11.8	72.1	13.5	83.8	15.2	89.6	16.2	95.4	17.1	107	19.0	119	21.0		
18	60.5			11.9	72.1	13.7	83.8	15.5	89.6	16.4	95.4	17.4	107	19.3	119	21.3		
20	60.5			12.1	72.1	13.8	83.8	15.7	89.6	16.7	95.4	17.6	107	19.9	119	22.7		
21	60.5			12.1	72.1	13.9	83.8	15.8	89.6	16.8	95.4	18.0	107	20.6	119	23.5		
23	60.5			12.3	72.1	14.1	83.8	16.5	89.6	17.8	95.4	19.2	107	22.0	119	25.1		
25	60.5			12.6	72.1	15.0	83.8	17.6	89.6	18.9	95.4	20.4	107	23.5	119	26.8		
27	60.5			13.4	72.1	15.9	83.8	18.7	89.6	20.1	95.4	21.7	107	25.0	119	28.5		
29	60.5			14.2	72.1	16.8	83.8	19.8	89.6	21.4	95.4	23.0	107	26.6	119	30.4		
31	60.5			14.9	72.1	17.8	83.8	21.0	89.6	22.7	95.4	24.5	107	28.2	117	31.6		
33	60.5			15.8	72.1	18.8	83.8	22.2	89.6	24.1	95.4	26.0	107	30.0	115	32.7		
35	60.5			16.6	72.1	19.9	83.8	23.6	89.6	25.5	95.4	27.5	107	31.9	113	33.9		
37	60.5			17.5	72.1	21.1	83.8	24.9	89.6	27.0	95.4	29.2	107	33.8	111	35.1		
39	60.5			18.5	72.1	22.2	83.8	26.4	89.6	28.6	95.4	30.9	107	35.9	110	36.3		
70	78.68			10	52.9	10.38	63.1	11.7	73.3	13.1	78.4	13.8	83.5	14.6	93.7	16.1	104	17.7
				12	52.9	10.49	63.1	11.9	73.3	13.3	78.4	14.0	83.5	14.8	93.7	16.3	104	17.9
				14	52.9	10.60	63.1	12.0	73.3	13.5	78.4	14.2	83.5	15.0	93.7	16.6	104	18.2
		16	52.9	10.72	63.1	12.1	73.3	13.6	78.4	14.4	83.5	15.2	93.7	16.8	104	18.5		
		18	52.9	10.85	63.1	12.3	73.3	13.8	78.4	14.6	83.5	15.4	93.7	17.1	104	18.8		
		20	52.9	10.97	63.1	12.5	73.3	14.0	78.4	14.8	83.5	15.7	93.7	17.3	104	19.2		
		21	52.9	11.04	63.1	12.5	73.3	14.1	78.4	14.9	83.5	15.8	93.7	17.6	104	19.9		
		23	52.9	11.2	63.1	12.7	73.3	14.4	78.4	15.4	83.5	16.5	93.7	18.7	104	21.2		
		25	52.9	11.3	63.1	13.2	73.3	15.2	78.4	16.3	83.5	17.5	93.7	20.0	104	22.6		
		27	52.9	11.9	63.1	13.9	73.3	16.2	78.4	17.4	83.5	18.6	93.7	21.2	104	24.0		
		29	52.9	12.6	63.1	14.7	73.3	17.1	78.4	18.4	83.5	19.7	93.7	22.5	104	25.6		
		31	52.9	13.2	63.1	15.6	73.3	18.1	78.4	19.5	83.5	20.9	93.7	23.9	104	27.2		
		33	52.9	14.0	63.1	16.4	73.3	19.2	78.4	20.6	83.5	22.2	93.7	25.4	104	28.9		
		35	52.9	14.7	63.1	17.4	73.3	20.3	78.4	21.8	83.5	23.5	93.7	26.9	104	30.6		
		37	52.9	15.5	63.1	18.3	73.3	21.4	78.4	23.1	83.5	24.8	93.7	28.5	104	32.5		
		39	52.9	16.3	63.1	19.3	73.3	22.6	78.4	24.4	83.5	26.3	93.7	30.2	104	34.5		
		60	67.44	10	45.4	9.44	54.1	10.53	62.8	11.7	67.2	12.3	71.6	12.9	80.3	14.1	89.0	15.4
				12	45.4	9.53	54.1	10.64	62.8	11.8	67.2	12.4	71.6	13.0	80.3	14.3	89.0	15.6
				14	45.4	9.63	54.1	10.76	62.8	12.0	67.2	12.6	71.6	13.2	80.3	14.5	89.0	15.8
16	45.4			9.72	54.1	10.88	62.8	12.1	67.2	12.7	71.6	13.4	80.3	14.7	89.0	16.1		
18	45.4			9.82	54.1	11.01	62.8	12.3	67.2	12.9	71.6	13.6	80.3	14.9	89.0	16.3		
20	45.4			9.93	54.1	11.14	62.8	12.4	67.2	13.1	71.6	13.8	80.3	15.1	89.0	16.6		
21	45.4			9.98	54.1	11.2	62.8	12.5	67.2	13.2	71.6	13.9	80.3	15.3	89.0	16.7		
23	45.4			10.09	54.1	11.3	62.8	12.7	67.2	13.4	71.6	14.1	80.3	15.8	89.0	17.7		
25	45.4			10.21	54.1	11.5	62.8	13.1	67.2	14.0	71.6	14.9	80.3	16.8	89.0	18.8		
27	45.4			10.52	54.1	12.1	62.8	13.9	67.2	14.8	71.6	15.8	80.3	17.8	89.0	20.0		
29	45.4			11.09	54.1	12.8	62.8	14.7	67.2	15.7	71.6	16.7	80.3	18.9	89.0	21.2		
31	45.4			11.7	54.1	13.5	62.8	15.5	67.2	16.6	71.6	17.7	80.3	20.0	89.0	22.5		
33	45.4			12.3	54.1	14.2	62.8	16.4	67.2	17.5	71.6	18.7	80.3	21.2	89.0	23.9		
35	45.4			12.9	54.1	15.0	62.8	17.3	67.2	18.5	71.6	19.8	80.3	22.4	89.0	25.3		
37	45.4			13.6	54.1	15.8	62.8	18.2	67.2	19.5	71.6	20.9	80.3	23.7	89.0	26.8		
39	45.4			14.3	54.1	16.6	62.8	19.2	67.2	20.6	71.6	22.0	80.3	25.1	89.0	28.4		
50	56.20			10	37.8	8.56	45.1	9.41	52.4	10.31	56.0	10.78	59.6	11.3	66.9	12.2	74.2	13.2
				12	37.8	8.63	45.1	9.50	52.4	10.42	56.0	10.89	59.6	11.4	66.9	12.4	74.2	13.4
				14	37.8	8.70	45.1	9.59	52.4	10.53	56.0	11.02	59.6	11.5	66.9	12.5	74.2	13.6
		16	37.8	8.77	45.1	9.69	52.4	10.65	56.0	11.14	59.6	11.7	66.9	12.7	74.2	13.8		
		18	37.8	8.85	45.1	9.79	52.4	10.77	56.0	11.3	59.6	11.8	66.9	12.9	74.2	14.0		
		20	37.8	8.94	45.1	9.89	52.4	10.89	56.0	11.4	59.6	11.9	66.9	13.0	74.2	14.2		
		21	37.8	8.98	45.1	9.94	52.4	10.96	56.0	11.5	59.6	12.0	66.9	13.1	74.2	14.3		
		23	37.8	9.07	45.1	10.05	52.4	11.09	56.0	11.6	59.6	12.2	66.9	13.3	74.2	14.5		
		25	37.8	9.16	45.1	10.17	52.4	11.2	56.0	11.8	59.6	12.5	66.9	13.9	74.2	15.4		
		27	37.8	9.25	45.1	10.47	52.4	11.8	56.0	12.5	59.6	13.2	66.9	14.7	74.2	16.4		
		29	37.8	9.74	45.1	11.04	52.4	12.5	56.0	13.2	59.6	14.0	66.9	15.6	74.2	17.3		
		31	37.8	10.23	45.1	11.6	52.4	13.1	56.0	13.9	59.6	14.8						

# 5 Capacity tables

## 5 - 1 Cooling Capacity Tables

### RQYQ42PY1

TC: Total Capacity: kW ; PI: Power Input: kW (compressor + outdoor fan motor)

Combination (%)	Capacity index (kW)	Outdoor air temp. °CDB	Indoor air temperature: °CWB															
			14.0		16.0		18.0		19.0		20.0		22.0		24.0			
			TC	PI	TC	PI	TC	PI	TC	PI	TC	PI	TC	PI	TC	PI		
130	151.32	10	104	17.3	123	20.4	143	23.5	149	23.9	150	23.4	154	22.4	158	21.4		
		12	104	17.6	123	20.7	143	23.9	147	23.8	149	23.3	152	22.3	156	21.9		
		14	104	17.9	123	21.0	143	24.1	145	23.6	147	23.1	150	23.0	154	23.2		
		16	104	18.1	123	21.4	141	24.0	143	23.8	145	24.0	148	24.2	152	24.4		
		18	104	18.4	123	21.7	139	24.9	141	25.1	143	25.2	147	25.4	150	25.7		
		20	104	18.7	123	23.0	137	26.2	139	26.3	141	26.4	145	26.7	148	26.9		
		21	104	19.2	123	23.8	136	26.8	138	26.9	140	27.0	144	27.3	147	27.6		
		23	104	20.5	123	25.5	134	28.0	136	28.1	138	28.3	142	28.6	145	28.8		
		25	104	21.8	123	27.2	132	29.2	134	29.4	136	29.5	140	29.8	144	30.1		
		27	104	23.2	123	29.0	130	30.4	132	30.6	134	30.8	138	31.1	142	31.4		
		29	104	24.7	123	30.8	129	31.7	130	31.8	132	32.0	136	32.4	140	32.7		
		31	104	26.2	123	32.6	127	32.9	128	33.1	130	33.3	134	33.6	138	34.0		
		33	104	27.8	121	33.8	125	34.2	127	34.4	128	34.5	132	34.9	136	35.3		
		35	104	29.5	119	35.0	123	35.4	125	35.6	126	35.8	130	36.2	134	36.6		
		37	104	31.3	117	36.2	121	36.7	123	36.9	125	37.1	128	37.5	132	37.9		
		39	104	33.1	115	37.5	119	37.9	121	38.2	123	38.4	126	38.8	130	39.3		
		120	139.68	10	95.6	16.2	114	18.9	132	21.8	142	23.2	148	24.0	152	23.1	155	22.2
				12	95.6	16.4	114	19.2	132	22.1	142	23.6	146	23.9	150	23.0	153	22.0
				14	95.6	16.6	114	19.5	132	22.5	142	24.0	144	23.8	148	22.8	151	23.0
16	95.6			16.9	114	19.8	132	22.8	141	24.1	142	23.8	146	24.0	149	24.2		
18	95.6			17.1	114	20.1	132	23.5	139	24.9	140	25.0	144	25.3	147	25.5		
20	95.6			17.4	114	20.9	132	25.2	137	26.1	139	26.3	142	26.5	145	26.7		
21	95.6			17.5	114	21.6	132	26.1	136	26.7	138	26.9	141	27.1	144	27.4		
23	95.6			18.6	114	23.0	132	27.8	134	28.0	136	28.1	139	28.4	143	28.6		
25	95.6			19.8	114	24.5	130	29.0	132	29.2	134	29.3	137	29.6	141	29.9		
27	95.6			21.1	114	26.1	128	30.3	130	30.4	132	30.6	135	30.9	139	31.2		
29	95.6			22.4	114	27.8	126	31.5	128	31.6	130	31.8	133	32.1	137	32.4		
31	95.6			23.8	114	29.6	125	32.7	126	32.9	128	33.0	131	33.4	135	33.7		
33	95.6			25.2	114	31.4	123	34.0	124	34.1	126	34.3	130	34.7	133	35.0		
35	95.6			26.7	114	33.3	121	35.2	122	35.4	124	35.6	128	35.9	131	36.3		
37	95.6			28.3	114	35.4	119	36.4	120	36.6	122	36.8	126	37.2	129	37.6		
39	95.6			30.0	113	37.3	117	37.7	119	37.9	120	38.1	124	38.5	127	38.9		
110	128.04			10	87.6	15.0	104	17.5	121	20.1	130	21.4	138	22.7	149	23.8	152	23.0
				12	87.6	15.2	104	17.7	121	20.4	130	21.7	138	23.1	147	23.7	150	22.8
				14	87.6	15.4	104	18.0	121	20.7	130	22.1	138	23.4	145	23.6	148	22.8
		16	87.6	15.6	104	18.3	121	21.0	130	22.4	138	23.8	143	23.9	146	24.1		
		18	87.6	15.9	104	18.6	121	21.4	130	22.9	138	24.9	141	25.1	144	25.3		
		20	87.6	16.1	104	18.9	121	22.5	130	24.6	136	26.1	139	26.3	143	26.5		
		21	87.6	16.2	104	19.4	121	23.3	130	25.4	135	26.7	138	26.9	142	27.2		
		23	87.6	16.9	104	20.7	121	24.9	130	27.2	133	27.9	136	28.2	140	28.4		
		25	87.6	18.0	104	22.0	121	26.6	130	29.0	131	29.1	135	29.4	138	29.6		
		27	87.6	19.1	104	23.5	121	28.3	128	30.2	129	30.4	133	30.6	136	30.9		
		29	87.6	20.3	104	24.9	121	30.1	126	31.4	128	31.6	131	31.9	134	32.2		
		31	87.6	21.5	104	26.5	121	32.1	124	32.7	126	32.8	129	33.1	132	33.4		
		33	87.6	22.8	104	28.1	121	33.7	122	33.9	124	34.1	127	34.4	130	34.7		
		35	87.6	24.1	104	29.8	119	35.0	120	35.1	122	35.3	125	35.6	128	36.0		
		37	87.6	25.5	104	31.6	117	36.2	118	36.4	120	36.6	123	36.9	126	37.3		
		39	87.6	27.0	104	33.5	115	37.4	116	37.6	118	37.8	121	38.2	124	38.6		
		100	116.40	10	79.6	13.9	95.0	16.1	110	18.4	118	19.5	126	20.7	141	23.1	149	23.7
				12	79.6	14.1	95.0	16.3	110	18.6	118	19.8	126	21.1	141	23.5	147	23.6
				14	79.6	14.2	95.0	16.5	110	18.9	118	20.2	126	21.4	141	23.9	145	23.5
16	79.6			14.4	95.0	16.8	110	19.2	118	20.5	126	21.7	141	24.1	143	23.9		
18	79.6			14.6	95.0	17.0	110	19.5	118	20.8	126	22.1	139	24.9	141	25.1		
20	79.6			14.9	95.0	17.3	110	20.0	118	21.8	126	23.6	137	26.1	140	26.3		
21	79.6			15.0	95.0	17.4	110	20.7	118	22.5	126	24.4	136	26.7	139	26.9		
23	79.6			15.3	95.0	18.5	110	22.1	118	24.0	126	26.0	134	28.0	137	28.2		
25	79.6			16.2	95.0	19.7	110	23.6	118	25.6	126	27.8	132	29.2	135	29.4		
27	79.6			17.2	95.0	20.9	110	25.1	118	27.3	126	29.6	130	30.4	133	30.6		
29	79.6			18.3	95.0	22.2	110	26.7	118	29.1	125	31.4	128	31.6	131	31.9		
31	79.6			19.3	95.0	23.6	110	28.3	118	30.9	123	32.6	126	32.9	129	33.1		
33	79.6			20.5	95.0	25.0	110	30.1	118	32.9	121	33.8	124	34.1	127	34.4		
35	79.6			21.6	95.0	26.5	110	32.0	118	34.9	119	35.1	122	35.4	125	35.7		
37	79.6			22.9	95.0	28.1	110	33.9	116	36.1	118	36.3	120	36.6	123	36.9		
39	79.6			24.2	95.0	29.8	110	36.0	114	37.4	116	37.5	118	37.9	121	38.2		

### NOTES - ANMERKUNGEN - Σημειώσεις - NOTAS - REMARQUES - NOTE - OPMERKINGEN - Примечания - NOTLAR

- The above table shows the average value of conditions which may occur.  
 Die obige Tabelle zeigt den Durchschnittswert der Bedingungen, die auftreten können.  
 Στον παραπάνω πίνακα αναγράφεται η μέση τιμή για συνθήκες που μπορεί να προκύψουν.  
 La tabla de arriba muestra el valor medio de condiciones que pueden ocurrir.  
 Le tableau ci-dessus donne la valeur moyenne pour des conditions qui peuvent survenir.  
 La tabella in alto mostra il valore delle condizioni medie che si possono riscontrare.  
 De tabel hierboven geeft de gemiddelde waarde aan van situaties die kunnen voorvallen.  
 Таблица расположенная выше показывает среднее значение условий, которые могут наступить.  
 Yukarıdaki tablo meydana gelebilecek koşulların ortalama değerini göstermektedir.

# 5 Capacity tables

## 5 - 1 Cooling Capacity Tables

5

RQYQ42PY1

TC: Total Capacity: kW ; PI: Power Input: kW (compressor + outdoor fan motor)

Combination (%)	Capacity index (kW)	Outdoor air temp. °CDB	Indoor air temperature: °CWB															
			14.0		16.0		18.0		19.0		20.0		22.0		24.0			
			TC	PI	TC	PI	TC	PI	TC	PI	TC	PI	TC	PI	TC	PI		
90	104.76	10	71.7	12.8	85.5	14.7	99.3	16.7	106	17.7	113	18.8	127	20.9	141	23.1		
		12	71.7	12.9	85.5	14.9	99.3	17.0	106	18.0	113	19.1	127	21.3	141	23.5		
		14	71.7	13.1	85.5	15.1	99.3	17.2	106	18.3	113	19.4	127	21.6	141	23.8		
		16	71.7	13.3	85.5	15.3	99.3	17.5	106	18.6	113	19.7	127	21.9	140	24.2		
		18	71.7	13.5	85.5	15.5	99.3	17.7	106	18.9	113	20.0	127	22.3	139	24.9		
		20	71.7	13.6	85.5	15.8	99.3	18.0	106	19.2	113	20.7	127	23.9	137	26.1		
		21	71.7	13.7	85.5	15.9	99.3	18.3	106	19.8	113	21.4	127	24.7	136	26.7		
		23	71.7	13.9	85.5	16.5	99.3	19.5	106	21.1	113	22.8	127	26.4	134	27.9		
		25	71.7	14.6	85.5	17.5	99.3	20.7	106	22.5	113	24.3	127	28.2	132	29.2		
		27	71.7	15.5	85.5	18.6	99.3	22.1	106	23.9	113	25.9	127	30.0	130	30.4		
		29	71.7	16.4	85.5	19.7	99.3	23.4	106	25.4	113	27.5	125	31.4	128	31.6		
		31	71.7	17.3	85.5	20.9	99.3	24.9	106	27.0	113	29.3	124	32.6	126	32.9		
		33	71.7	18.3	85.5	22.1	99.3	26.4	106	28.7	113	31.1	122	33.8	124	34.1		
		35	71.7	19.3	85.5	23.4	99.3	28.0	106	30.4	113	33.0	120	35.1	122	35.4		
		37	71.7	20.4	85.5	24.8	99.3	29.7	106	32.3	113	35.0	118	36.3	120	36.6		
		39	71.7	21.6	85.5	26.2	99.3	31.4	106	34.2	113	37.2	116	37.6	118	37.9		
		80	93.12	10	63.7	11.7	76.0	13.4	88.3	15.1	94.4	16.0	101	16.9	113	18.8	125	20.6
				12	63.7	11.9	76.0	13.5	88.3	15.3	94.4	16.2	101	17.1	113	19.0	125	21.0
14	63.7			12.0	76.0	13.7	88.3	15.5	94.4	16.5	101	17.4	113	19.3	125	21.3		
16	63.7			12.2	76.0	13.9	88.3	15.7	94.4	16.7	101	17.7	113	19.6	125	21.6		
18	63.7			12.3	76.0	14.1	88.3	16.0	94.4	16.9	101	17.9	113	19.9	125	22.0		
20	63.7			12.5	76.0	14.3	88.3	16.2	94.4	17.2	101	18.2	113	20.6	125	23.4		
21	63.7			12.5	76.0	14.4	88.3	16.3	94.4	17.3	101	18.5	113	21.3	125	24.2		
23	63.7			12.7	76.0	14.6	88.3	17.1	94.4	18.4	101	19.8	113	22.7	125	25.9		
25	63.7			13.1	76.0	15.5	88.3	18.1	94.4	19.6	101	21.1	113	24.2	125	27.6		
27	63.7			13.8	76.0	16.4	88.3	19.3	94.4	20.8	101	22.4	113	25.8	125	29.5		
29	63.7			14.6	76.0	17.4	88.3	20.4	94.4	22.1	101	23.8	113	27.4	125	31.4		
31	63.7			15.4	76.0	18.4	88.3	21.7	94.4	23.4	101	25.3	113	29.2	123	32.6		
33	63.7			16.3	76.0	19.5	88.3	23.0	94.4	24.8	101	26.8	113	31.0	121	33.8		
35	63.7			17.2	76.0	20.6	88.3	24.3	94.4	26.3	101	28.4	113	32.9	119	35.0		
37	63.7			18.1	76.0	21.7	88.3	25.7	94.4	27.9	101	30.1	113	34.9	117	36.3		
39	63.7			19.1	76.0	23.0	88.3	27.2	94.4	29.5	101	31.9	113	37.1	115	37.5		
70	81.48			10	55.7	10.72	66.5	12.1	77.2	13.5	82.6	14.3	88.0	15.1	98.7	16.6	109	18.2
				12	55.7	10.83	66.5	12.2	77.2	13.7	82.6	14.5	88.0	15.3	98.7	16.9	109	18.5
		14	55.7	10.95	66.5	12.4	77.2	13.9	82.6	14.7	88.0	15.5	98.7	17.1	109	18.8		
		16	55.7	11.1	66.5	12.5	77.2	14.1	82.6	14.9	88.0	15.7	98.7	17.4	109	19.1		
		18	55.7	11.2	66.5	12.7	77.2	14.3	82.6	15.1	88.0	15.9	98.7	17.6	109	19.4		
		20	55.7	11.3	66.5	12.9	77.2	14.5	82.6	15.3	88.0	16.2	98.7	17.9	109	19.9		
		21	55.7	11.4	66.5	13.0	77.2	14.6	82.6	15.4	88.0	16.3	98.7	18.2	109	20.5		
		23	55.7	11.5	66.5	13.1	77.2	14.8	82.6	15.9	88.0	17.0	98.7	19.4	109	21.9		
		25	55.7	11.7	66.5	13.6	77.2	15.7	82.6	16.9	88.0	18.1	98.7	20.6	109	23.3		
		27	55.7	12.3	66.5	14.4	77.2	16.7	82.6	17.9	88.0	19.2	98.7	21.9	109	24.8		
		29	55.7	13.0	66.5	15.2	77.2	17.7	82.6	19.0	88.0	20.4	98.7	23.3	109	26.4		
		31	55.7	13.7	66.5	16.1	77.2	18.7	82.6	20.1	88.0	21.6	98.7	24.7	109	28.1		
		33	55.7	14.4	66.5	17.0	77.2	19.8	82.6	21.3	88.0	22.9	98.7	26.2	109	29.8		
		35	55.7	15.2	66.5	17.9	77.2	20.9	82.6	22.5	88.0	24.2	98.7	27.8	109	31.6		
		37	55.7	16.0	66.5	18.9	77.2	22.1	82.6	23.8	88.0	25.6	98.7	29.5	109	33.6		
		39	55.7	16.8	66.5	19.9	77.2	23.4	82.6	25.2	88.0	27.1	98.7	31.2	109	35.6		
		60	69.84	10	47.8	9.75	57.0	10.87	66.2	12.1	70.8	12.7	75.4	13.3	84.6	14.6	93.8	15.9
				12	47.8	9.84	57.0	10.99	66.2	12.2	70.8	12.8	75.4	13.5	84.6	14.8	93.8	16.1
14	47.8			9.94	57.0	11.1	66.2	12.3	70.8	13.0	75.4	13.6	84.6	15.0	93.8	16.4		
16	47.8			10.04	57.0	11.2	66.2	12.5	70.8	13.2	75.4	13.8	84.6	15.2	93.8	16.6		
18	47.8			10.14	57.0	11.4	66.2	12.7	70.8	13.3	75.4	14.0	84.6	15.4	93.8	16.9		
20	47.8			10.25	57.0	11.5	66.2	12.8	70.8	13.5	75.4	14.2	84.6	15.6	93.8	17.1		
21	47.8			10.31	57.0	11.6	66.2	12.9	70.8	13.6	75.4	14.3	84.6	15.8	93.8	17.2		
23	47.8			10.42	57.0	11.7	66.2	13.1	70.8	13.8	75.4	14.5	84.6	16.3	93.8	18.3		
25	47.8			10.54	57.0	11.9	66.2	13.5	70.8	14.4	75.4	15.4	84.6	17.3	93.8	19.4		
27	47.8			10.86	57.0	12.5	66.2	14.3	70.8	15.3	75.4	16.3	84.6	18.4	93.8	20.6		
29	47.8			11.5	57.0	13.2	66.2	15.2	70.8	16.2	75.4	17.2	84.6	19.5	93.8	21.9		
31	47.8			12.1	57.0	13.9	66.2	16.0	70.8	17.1	75.4	18.3	84.6	20.7	93.8	23.3		
33	47.8			12.7	57.0	14.7	66.2	16.9	70.8	18.1	75.4	19.3	84.6	21.9	93.8	24.7		
35	47.8			13.3	57.0	15.5	66.2	17.8	70.8	19.1	75.4	20.4	84.6	23.2	93.8	26.1		
37	47.8			14.0	57.0	16.3	66.2	18.8	70.8	20.2	75.4	21.6	84.6	24.5	93.8	27.7		
39	47.8			14.7	57.0	17.2	66.2	19.8	70.8	21.3	75.4	22.8	84.6	25.9	93.8	29.3		
50	58.20			10	39.8	8.83	47.5	9.72	55.2	10.65	59.0	11.1	62.8	11.6	70.5	12.6	78.2	13.7
				12	39.8	8.91	47.5	9.81	55.2	10.76	59.0	11.2	62.8	11.8	70.5	12.8	78.2	13.9
		14	39.8	8.98	47.5	9.90	55.2	10.87	59.0	11.4	62.8	11.9	70.5	12.9	78.2	14.0		
		16	39.8	9.06	47.5	10.00	55.2	10.99	59.0	11.5	62.8	12.0	70.5	13.1	78.2	14.2		
		18	39.8	9.14	47.5	10.10	55.2	11.1	59.0	11.6	62.8	12.2	70.5	13.3	78.2	14.4		
		20	39.8	9.23	47.5	10.21	55.2	11.2	59.0	11.8	62.8	12.3	70.5	13.5	78.2	14.6		
		21	39.8	9.27	47.5	10.27	55.2	11.3	59.0	11.9	62.8	12.4	70.5	13.6	78.2	14.7		
		23	39.8	9.36	47.5	10.38	55.2	11.5	59.0	12.0	62.8	12.6	70.5	13.7	78.2	15.0		
		25	39.8	9.45	47.5	10.50	55.2	11.6	59.0	12.2	62.8	12.9	70.5	14.4	78.2	15.9		
		27	39.8	9.56	47.5	10.81	55.2	12.2	59.0	12.9	62.8	13.6	70.5	15.2	78.2	16.9		
		29	39.8	10.05	47.5	11.4	55.2	12.9	59.0	13.6	62.8	14.4	70.5	16.1	78.2	17.9		
		31	39.8	10.56	47.5	12.0	55.2	13.6	59.0	14.4	62.8	15.2	70.5	17.0</				

# 5 Capacity tables

## 5 - 1 Cooling Capacity Tables

### RQYQ44PY1

TC: Total Capacity: kW ; PI: Power Input: kW (compressor + outdoor fan motor)

Combination (%)	Capacity index (kW)	Outdoor air temp. °CDB	Indoor air temperature: °CWB															
			14.0		16.0		18.0		19.0		20.0		22.0		24.0			
			TC	PI	TC	PI	TC	PI	TC	PI	TC	PI	TC	PI	TC	PI		
130	156.52	10	109	17.5	130	20.6	151	23.8	156	24.2	158	23.7	162	22.7	166	21.7		
		12	109	17.8	130	20.9	151	24.2	154	24.0	156	23.5	160	22.5	164	22.2		
		14	109	18.1	130	21.3	150	24.4	152	23.9	154	23.4	158	23.2	162	23.4		
		16	109	18.3	130	21.6	148	24.3	150	24.1	152	24.2	156	24.5	160	24.7		
		18	109	18.6	130	22.0	146	25.2	148	25.4	150	25.5	154	25.7	158	26.0		
		20	109	18.9	130	23.3	144	26.5	146	26.6	148	26.7	152	27.0	156	27.2		
		21	109	19.4	130	24.1	143	27.1	145	27.2	147	27.3	151	27.6	155	27.9		
		23	109	20.7	130	25.8	141	28.3	143	28.5	145	28.6	149	28.9	153	29.2		
		25	109	22.1	130	27.5	139	29.5	141	29.7	143	29.9	147	30.2	151	30.5		
		27	109	23.5	130	29.3	137	30.8	139	31.0	141	31.1	145	31.4	149	31.8		
		29	109	24.9	130	31.2	135	32.0	137	32.2	139	32.4	143	32.7	147	33.1		
		31	109	26.5	129	32.9	133	33.3	135	33.5	137	33.7	141	34.0	145	34.4		
		33	109	28.1	127	34.2	131	34.6	133	34.7	135	34.9	139	35.3	143	35.7		
		35	109	29.8	125	35.4	129	35.8	131	36.0	133	36.2	137	36.6	141	37.0		
		37	109	31.6	123	36.7	127	37.1	129	37.3	131	37.5	135	37.9	139	38.4		
		39	109	33.5	121	37.9	125	38.4	127	38.6	129	38.8	133	39.3	137	39.7		
		120	144.48	10	100	16.3	120	19.1	139	22.0	149	23.5	156	24.3	159	23.4	163	22.5
				12	100	16.6	120	19.4	139	22.4	149	23.9	154	24.2	157	23.2	161	22.3
14	100			16.8	120	19.7	139	22.7	149	24.3	152	24.0	155	23.1	159	23.3		
16	100			17.1	120	20.0	139	23.1	148	24.4	150	24.1	153	24.3	157	24.5		
18	100			17.3	120	20.4	139	23.8	146	25.2	148	25.3	151	25.5	155	25.8		
20	100			17.6	120	21.1	139	25.5	144	26.4	146	26.6	149	26.8	153	27.0		
21	100			17.7	120	21.8	139	26.4	143	27.0	145	27.2	148	27.4	152	27.7		
23	100			18.9	120	23.3	139	28.1	141	28.3	143	28.4	146	28.7	150	28.9		
25	100			20.1	120	24.8	137	29.4	139	29.5	141	29.7	144	29.9	148	30.2		
27	100			21.3	120	26.4	135	30.6	137	30.8	139	30.9	142	31.2	146	31.5		
29	100			22.7	120	28.1	133	31.8	135	32.0	137	32.2	140	32.5	144	32.8		
31	100			24.0	120	29.9	131	33.1	133	33.3	134	33.4	138	33.8	142	34.1		
33	100			25.5	120	31.8	129	34.3	131	34.5	132	34.7	136	35.0	140	35.4		
35	100			27.0	120	33.7	127	35.6	129	35.8	130	36.0	134	36.3	138	36.7		
37	100			28.6	120	35.8	125	36.9	127	37.0	128	37.2	132	37.6	136	38.0		
39	100			30.3	119	37.7	123	38.1	125	38.3	126	38.5	130	38.9	134	39.4		
110	132.44			10	92.1	15.2	110	17.7	128	20.3	136	21.6	145	23.0	157	24.1	160	23.2
				12	92.1	15.4	110	17.9	128	20.6	136	22.0	145	23.3	154	24.0	158	23.1
		14	92.1	15.6	110	18.2	128	20.9	136	22.3	145	23.7	152	23.8	156	23.1		
		16	92.1	15.8	110	18.5	128	21.3	136	22.7	145	24.1	150	24.1	154	24.3		
		18	92.1	16.1	110	18.8	128	21.6	136	23.2	145	25.2	148	25.4	152	25.6		
		20	92.1	16.3	110	19.1	128	22.8	136	24.9	143	26.4	146	26.6	150	26.8		
		21	92.1	16.4	110	19.6	128	23.6	136	25.7	142	27.0	145	27.2	149	27.5		
		23	92.1	17.1	110	20.9	128	25.2	136	27.5	140	28.2	143	28.5	147	28.7		
		25	92.1	18.2	110	22.3	128	26.9	136	29.3	138	29.5	141	29.7	145	30.0		
		27	92.1	19.3	110	23.7	128	28.6	134	30.6	136	30.7	139	31.0	143	31.3		
		29	92.1	20.5	110	25.2	128	30.5	132	31.8	134	31.9	137	32.2	141	32.5		
		31	92.1	21.7	110	26.8	128	32.4	130	33.0	132	33.2	135	33.5	139	33.8		
		33	92.1	23.0	110	28.4	127	34.1	128	34.3	130	34.5	133	34.8	137	35.1		
		35	92.1	24.4	110	30.2	125	35.4	126	35.5	128	35.7	131	36.1	135	36.4		
		37	92.1	25.8	110	32.0	123	36.6	124	36.8	126	37.0	129	37.3	133	37.7		
		39	92.1	27.3	110	33.9	121	37.9	122	38.1	124	38.2	127	38.6	131	39.0		
		100	120.40	10	83.7	14.0	99.8	16.3	116	18.6	124	19.8	132	21.0	148	23.4	157	24.0
				12	83.7	14.2	99.8	16.5	116	18.9	124	20.1	132	21.3	148	23.8	155	23.9
14	83.7			14.4	99.8	16.7	116	19.1	124	20.4	132	21.6	148	24.2	153	23.8		
16	83.7			14.6	99.8	17.0	116	19.4	124	20.7	132	22.0	148	24.4	151	24.2		
18	83.7			14.8	99.8	17.2	116	19.8	124	21.0	132	22.3	146	25.2	149	25.4		
20	83.7			15.0	99.8	17.5	116	20.3	124	22.0	132	23.8	144	26.4	147	26.6		
21	83.7			15.1	99.8	17.6	116	21.0	124	22.8	132	24.7	143	27.0	146	27.2		
23	83.7			15.5	99.8	18.7	116	22.4	124	24.3	132	26.3	141	28.3	144	28.5		
25	83.7			16.4	99.8	19.9	116	23.8	124	25.9	132	28.1	139	29.5	142	29.7		
27	83.7			17.4	99.8	21.2	116	25.4	124	27.6	132	30.0	137	30.8	140	31.0		
29	83.7			18.5	99.8	22.5	116	27.0	124	29.4	132	31.7	135	32.0	138	32.3		
31	83.7			19.6	99.8	23.9	116	28.7	124	31.3	130	33.0	133	33.2	136	33.5		
33	83.7			20.7	99.8	25.3	116	30.5	124	33.2	128	34.2	131	34.5	134	34.8		
35	83.7			21.9	99.8	26.8	116	32.3	124	35.3	126	35.5	129	35.8	132	36.1		
37	83.7			23.1	99.8	28.4	116	34.3	122	36.5	123	36.7	127	37.0	130	37.4		
39	83.7			24.5	99.8	30.1	116	36.4	120	37.8	121	38.0	124	38.3	128	38.7		

**NOTES - ANMERKUNGEN - Σημειώσεις - NOTAS - REMARQUES - NOTE - OPMERKINGEN - Примечания - NOTLAR**

- The above table shows the average value of conditions which may occur.  
 Die obige Tabelle zeigt den Durchschnittswert der Bedingungen, die auftreten können.  
 Στον παραπάνω πίνακα αναγράφεται η μέση τιμή για συνθήκες που μπορεί να προκύψουν.  
 La tabla de arriba muestra el valor medio de condiciones que pueden ocurrir.  
 Le tableau ci-dessus donne la valeur moyenne pour des conditions qui peuvent survenir.  
 La tabella in alto mostra il valore delle condizioni medie che si possono riscontrare.  
 De tabel hierboven geeft de gemiddelde waarde aan van situaties die kunnen voorvallen.  
 Таблица расположенная выше показывает среднее значение условий, которые могут наступить.  
 Yukarıdaki tablo meydana gelebilecek koşulların ortalama değerini göstermektedir.



# 5 Capacity tables

## 5 - 1 Cooling Capacity Tables

5

RQYQ44PY1

TC: Total Capacity: kW ; PI: Power Input: kW (compressor + outdoor fan motor)

Combination (%)	Capacity index (kW)	Outdoor air temp. °CDB	Indoor air temperature: °CWB															
			14.0		16.0		18.0		19.0		20.0		22.0		24.0			
			TC	PI	TC	PI	TC	PI	TC	PI	TC	PI	TC	PI	TC	PI		
90	108.36	10	75.3	12.9	89.8	14.9	104	16.9	112	18.0	119	19.0	133	21.2	148	23.4		
		12	75.3	13.1	89.8	15.1	104	17.1	112	18.2	119	19.3	133	21.5	148	23.7		
		14	75.3	13.3	89.8	15.3	104	17.4	112	18.5	119	19.6	133	21.8	148	24.1		
		16	75.3	13.4	89.8	15.5	104	17.7	112	18.8	119	19.9	133	22.2	148	24.4		
		18	75.3	13.6	89.8	15.7	104	17.9	112	19.1	119	20.2	133	22.6	146	25.2		
		20	75.3	13.8	89.8	16.0	104	18.2	112	19.4	119	20.9	133	24.1	144	26.4		
		21	75.3	13.9	89.8	16.1	104	18.5	112	20.0	119	21.6	133	25.0	143	27.0		
		23	75.3	14.1	89.8	16.7	104	19.7	112	21.3	119	23.1	133	26.7	141	28.3		
		25	75.3	14.8	89.8	17.7	104	21.0	112	22.7	119	24.6	133	28.5	139	29.5		
		27	75.3	15.6	89.8	18.8	104	22.3	112	24.2	119	26.2	133	30.4	137	30.7		
		29	75.3	16.6	89.8	20.0	104	23.7	112	25.7	119	27.8	132	31.8	135	32.0		
		31	75.3	17.5	89.8	21.1	104	25.2	112	27.3	119	29.6	130	33.0	133	33.2		
		33	75.3	18.5	89.8	22.4	104	26.7	112	29.0	119	31.4	128	34.2	130	34.5		
		35	75.3	19.6	89.8	23.7	104	28.3	112	30.8	119	33.4	126	35.5	128	35.8		
		37	75.3	20.7	89.8	25.1	104	30.0	112	32.7	119	35.4	124	36.7	126	37.0		
		39	75.3	21.8	89.8	26.5	104	31.8	112	34.6	119	37.6	122	38.0	124	38.3		
		80	96.32	10	66.9	11.9	79.8	13.5	92.7	15.3	99.2	16.2	106	17.1	119	19.0	131	20.9
				12	66.9	12.0	79.8	13.7	92.7	15.5	99.2	16.4	106	17.3	119	19.3	131	21.2
				14	66.9	12.1	79.8	13.9	92.7	15.7	99.2	16.6	106	17.6	119	19.5	131	21.5
16	66.9			12.3	79.8	14.1	92.7	15.9	99.2	16.9	106	17.9	119	19.9	131	21.9		
18	66.9			12.4	79.8	14.3	92.7	16.2	99.2	17.1	106	18.1	119	20.2	131	22.2		
20	66.9			12.6	79.8	14.5	92.7	16.4	99.2	17.4	106	18.4	119	20.8	131	23.7		
21	66.9			12.7	79.8	14.6	92.7	16.5	99.2	17.5	106	18.8	119	21.5	131	24.5		
23	66.9			12.9	79.8	14.8	92.7	17.3	99.2	18.6	106	20.0	119	23.0	131	26.2		
25	66.9			13.2	79.8	15.7	92.7	18.3	99.2	19.8	106	21.3	119	24.5	131	27.9		
27	66.9			14.0	79.8	16.6	92.7	19.5	99.2	21.0	106	22.6	119	26.1	131	29.8		
29	66.9			14.8	79.8	17.6	92.7	20.7	99.2	22.3	106	24.1	119	27.7	131	31.7		
31	66.9			15.6	79.8	18.6	92.7	21.9	99.2	23.7	106	25.6	119	29.5	129	33.0		
33	66.9			16.5	79.8	19.7	92.7	23.2	99.2	25.1	106	27.1	119	31.3	127	34.2		
35	66.9			17.4	79.8	20.8	92.7	24.6	99.2	26.6	106	28.8	119	33.3	125	35.4		
37	66.9			18.3	79.8	22.0	92.7	26.0	99.2	28.2	106	30.5	119	35.3	123	36.7		
39	66.9			19.3	79.8	23.2	92.7	27.5	99.2	29.9	106	32.3	119	37.5	121	38.0		
70	84.28			10	58.6	10.84	69.9	12.2	81.2	13.7	86.8	14.5	92.4	15.2	104	16.8	115	18.5
				12	58.6	11.0	69.9	12.4	81.2	13.9	86.8	14.7	92.4	15.4	104	17.1	115	18.7
				14	58.6	11.1	69.9	12.5	81.2	14.1	86.8	14.9	92.4	15.7	104	17.3	115	19.0
		16	58.6	11.2	69.9	12.7	81.2	14.2	86.8	15.1	92.4	15.9	104	17.6	115	19.3		
		18	58.6	11.3	69.9	12.8	81.2	14.4	86.8	15.3	92.4	16.1	104	17.8	115	19.6		
		20	58.6	11.5	69.9	13.0	81.2	14.7	86.8	15.5	92.4	16.4	104	18.1	115	20.1		
		21	58.6	11.5	69.9	13.1	81.2	14.8	86.8	15.6	92.4	16.5	104	18.4	115	20.8		
		23	58.6	11.7	69.9	13.3	81.2	15.0	86.8	16.1	92.4	17.2	104	19.6	115	22.1		
		25	58.6	11.8	69.9	13.7	81.2	15.9	86.8	17.1	92.4	18.3	104	20.8	115	23.6		
		27	58.6	12.4	69.9	14.5	81.2	16.9	86.8	18.1	92.4	19.4	104	22.2	115	25.1		
		29	58.6	13.1	69.9	15.4	81.2	17.9	86.8	19.2	92.4	20.6	104	23.5	115	26.7		
		31	58.6	13.8	69.9	16.3	81.2	18.9	86.8	20.4	92.4	21.8	104	25.0	115	28.4		
		33	58.6	14.6	69.9	17.2	81.2	20.0	86.8	21.6	92.4	23.1	104	26.5	115	30.1		
		35	58.6	15.4	69.9	18.1	81.2	21.2	86.8	22.8	92.4	24.5	104	28.1	115	32.0		
		37	58.6	16.2	69.9	19.1	81.2	22.4	86.8	24.1	92.4	25.9	104	29.8	115	34.0		
		39	58.6	17.0	69.9	20.2	81.2	23.6	86.8	25.5	92.4	27.4	104	31.6	115	36.0		
		60	72.24	10	50.2	9.86	59.9	11.0	69.6	12.2	74.4	12.8	79.2	13.4	88.9	14.7	98.6	16.1
				12	50.2	9.96	59.9	11.1	69.6	12.3	74.4	13.0	79.2	13.6	88.9	14.9	98.6	16.3
				14	50.2	10.05	59.9	11.2	69.6	12.5	74.4	13.1	79.2	13.8	88.9	15.2	98.6	16.6
16	50.2			10.15	59.9	11.4	69.6	12.6	74.4	13.3	79.2	14.0	88.9	15.4	98.6	16.8		
18	50.2			10.26	59.9	11.5	69.6	12.8	74.4	13.5	79.2	14.2	88.9	15.6	98.6	17.0		
20	50.2			10.37	59.9	11.6	69.6	13.0	74.4	13.7	79.2	14.4	88.9	15.8	98.6	17.3		
21	50.2			10.42	59.9	11.7	69.6	13.1	74.4	13.8	79.2	14.5	88.9	15.9	98.6	17.4		
23	50.2			10.54	59.9	11.9	69.6	13.2	74.4	14.0	79.2	14.7	88.9	16.5	98.6	18.5		
25	50.2			10.66	59.9	12.0	69.6	13.7	74.4	14.6	79.2	15.5	88.9	17.5	98.6	19.7		
27	50.2			11.0	59.9	12.7	69.6	14.5	74.4	15.5	79.2	16.5	88.9	18.6	98.6	20.9		
29	50.2			11.6	59.9	13.4	69.6	15.3	74.4	16.4	79.2	17.4	88.9	19.7	98.6	22.2		
31	50.2			12.2	59.9	14.1	69.6	16.2	74.4	17.3	79.2	18.5	88.9	20.9	98.6	23.5		
33	50.2			12.8	59.9	14.9	69.6	17.1	74.4	18.3	79.2	19.5	88.9	22.1	98.6	24.9		
35	50.2			13.5	59.9	15.7	69.6	18.0	74.4	19.3	79.2	20.6	88.9	23.4	98.6	26.4		
37	50.2			14.2	59.9	16.5	69.6	19.0	74.4	20.4	79.2	21.8	88.9	24.8	98.6	28.0		
39	50.2			14.9	59.9	17.4	69.6	20.1	74.4	21.5	79.2	23.0	88.9	26.2	98.6	29.6		
50	60.20			10	41.8	8.94	49.9	9.83	58.0	10.77	62.0	11.3	66.0	11.8	74.1	12.8	82.2	13.8
				12	41.8	9.01	49.9	9.92	58.0	10.9	62.0	11.4	66.0	11.9	74.1	12.9	82.2	14.0
				14	41.8	9.08	49.9	10.02	58.0	11.0	62.0	11.5	66.0	12.0	74.1	13.1	82.2	14.2
		16	41.8	9.16	49.9	10.12	58.0	11.1	62.0	11.6	66.0	12.2	74.1	13.3	82.2	14.4		
		18	41.8	9.25	49.9	10.22	58.0	11.2	62.0	11.8	66.0	12.3	74.1	13.4	82.2	14.6		
		20	41.8	9.33	49.9	10.33	58.0	11.4	62.0	11.9	66.0	12.5	74.1	13.6	82.2	14.8		
		21	41.8	9.38	49.9	10.38	58.0	11.4	62.0	12.0	66.0	12.6	74.1	13.7	82.2	14.9		
		23	41.8	9.47	49.9	10.50	58.0	11.6	62.0	12.1	66.0	12.7	74.1	13.9	82.2	15.2		
		25	41.8	9.56	49.9	10.62	58.0	11.7	62.0	12.3	66.0	13.0	74.1	14.5	82.2	16.1		
		27	41.8	9.67	49.9	10.94	58.0	12.3	62.0	13.0	66.0	13.8	74.1	15.4	82.2	17.1		
		29	41.8	10.17	49.9	11.5	58.0	13.0	62.0	13.8	66.0	14.6	74.1	16.3	82.2	18.1		
		31	41.8	10.69	49.9	12.1	58.0	13.7	62.0	14.5	66.0	15.4	74.1	17.2	82.2	19.2		
		33	41.8															



# 5 Capacity tables

## 5 - 1 Cooling Capacity Tables

### RQYQ46PY1

TC: Total Capacity: kW ; PI: Power Input: kW (compressor + outdoor fan motor)

Combination (%)	Capacity index (kW)	Outdoor air temp. °CDB	Indoor air temperature: °CWB															
			14.0		16.0		18.0		19.0		20.0		22.0		24.0			
			TC	PI	TC	PI	TC	PI	TC	PI	TC	PI	TC	PI	TC	PI		
130	163.80	10	114	19,3	136	22,7	158	26,2	164	26,6	166	26,0	170	24,9	174	23,8		
		12	114	19,6	136	23,0	158	26,6	162	26,4	164	25,9	168	24,8	172	24,4		
		14	114	19,9	136	23,4	157	26,8	160	26,3	162	25,7	166	25,5	170	25,8		
		16	114	20,2	136	23,8	155	26,7	157	26,5	159	26,6	164	26,9	168	27,1		
		18	114	20,5	136	24,1	153	27,7	155	27,9	157	28,0	161	28,3	166	28,5		
		20	114	20,8	136	25,6	151	29,1	153	29,2	155	29,4	159	29,7	163	29,9		
		21	114	21,3	136	26,5	150	29,8	152	29,9	154	30,1	158	30,4	162	30,7		
		23	114	22,8	136	28,3	148	31,1	150	31,3	152	31,4	156	31,7	160	32,1		
		25	114	24,2	136	30,2	146	32,5	148	32,6	150	32,8	154	33,1	158	33,5		
		27	114	25,8	136	32,2	144	33,8	146	34,0	148	34,2	152	34,6	156	34,9		
		29	114	27,4	136	34,3	142	35,2	144	35,4	146	35,6	150	36,0	154	36,3		
		31	114	29,1	135	36,2	139	36,6	142	36,8	144	37,0	148	37,4	152	37,8		
		33	114	30,9	133	37,6	137	38,0	139	38,2	141	38,4	146	38,8	150	39,2		
		35	114	32,8	131	38,9	135	39,4	137	39,6	139	39,8	143	40,3	148	40,7		
		37	114	34,8	129	40,3	133	40,8	135	41,0	137	41,2	141	41,7	145	42,2		
		39	114	36,8	127	41,7	131	42,2	133	42,4	135	42,7	139	43,2	143	43,7		
		120	151.20	10	105	18,0	126	21,0	146	24,2	156	25,8	163	26,7	167	25,7	171	24,7
				12	105	18,2	126	21,4	146	24,6	156	26,2	161	26,6	165	25,5	169	24,5
14	105			18,5	126	21,7	146	25,0	156	26,7	159	26,4	163	25,4	167	25,6		
16	105			18,8	126	22,0	146	25,4	155	26,8	157	26,5	161	26,7	164	26,9		
18	105			19,0	126	22,4	146	26,2	153	27,7	155	27,8	159	28,1	162	28,3		
20	105			19,3	126	23,2	146	28,0	151	29,1	153	29,2	156	29,5	160	29,7		
21	105			19,5	126	24,0	146	29,0	150	29,7	152	29,9	155	30,1	159	30,4		
23	105			20,7	126	25,6	146	30,9	148	31,1	149	31,2	153	31,5	157	31,8		
25	105			22,1	126	27,3	144	32,3	145	32,4	147	32,6	151	32,9	155	33,2		
27	105			23,5	126	29,0	141	33,6	143	33,8	145	34,0	149	34,3	153	34,6		
29	105			24,9	126	30,9	139	35,0	141	35,2	143	35,4	147	35,7	151	36,1		
31	105			26,4	126	32,9	137	36,4	139	36,6	141	36,7	145	37,1	149	37,5		
33	105			28,0	126	34,9	135	37,7	137	37,9	139	38,1	143	38,5	146	38,9		
35	105			29,7	126	37,1	133	39,1	135	39,3	137	39,5	141	39,9	144	40,4		
37	105			31,5	126	39,4	131	40,5	133	40,7	135	40,9	138	41,4	142	41,8		
39	105			33,3	125	41,4	129	41,9	131	42,1	133	42,4	136	42,8	140	43,3		
110	138.60			10	96,5	16,7	115	19,4	134	22,3	143	23,8	152	25,2	164	26,5	168	25,5
				12	96,5	16,9	115	19,7	134	22,7	143	24,1	152	25,6	162	26,3	165	25,4
		14	96,5	17,1	115	20,0	134	23,0	143	24,5	152	26,0	160	26,2	163	25,4		
		16	96,5	17,4	115	20,3	134	23,4	143	24,9	152	26,5	158	26,5	161	26,8		
		18	96,5	17,6	115	20,6	134	23,7	143	25,5	152	27,7	156	27,9	159	28,1		
		20	96,5	17,9	115	21,0	134	25,1	143	27,3	150	29,0	154	29,3	157	29,5		
		21	96,5	18,0	115	21,6	134	25,9	143	28,3	149	29,7	152	29,9	156	30,2		
		23	96,5	18,8	115	23,0	134	27,7	143	30,2	147	31,0	150	31,3	154	31,6		
		25	96,5	20,0	115	24,5	134	29,5	143	32,2	145	32,4	148	32,7	152	33,0		
		27	96,5	21,2	115	26,1	134	31,5	141	33,6	143	33,8	146	34,1	150	34,4		
		29	96,5	22,5	115	27,7	134	33,5	139	35,0	141	35,1	144	35,4	147	35,8		
		31	96,5	23,9	115	29,4	134	35,6	137	36,3	138	36,5	142	36,8	145	37,2		
		33	96,5	25,3	115	31,3	133	37,5	135	37,7	136	37,9	140	38,2	143	38,6		
		35	96,5	26,8	115	33,2	131	38,9	132	39,1	134	39,3	138	39,6	141	40,0		
		37	96,5	28,4	115	35,2	129	40,2	130	40,4	132	40,6	136	41,0	139	41,4		
		39	96,5	30,0	115	37,3	126	41,6	128	41,8	130	42,0	133	42,5	137	42,9		
		100	126.00	10	87,7	15,4	105	17,9	122	20,4	130	21,7	138	23,1	155	25,7	164	26,4
				12	87,7	15,6	105	18,1	122	20,7	130	22,1	138	23,4	155	26,1	162	26,3
14	87,7			15,8	105	18,4	122	21,0	130	22,4	138	23,8	155	26,6	160	26,1		
16	87,7			16,1	105	18,7	122	21,4	130	22,8	138	24,2	155	26,8	158	26,6		
18	87,7			16,3	105	18,9	122	21,7	130	23,1	138	24,6	153	27,7	156	27,9		
20	87,7			16,5	105	19,2	122	22,3	130	24,2	138	26,2	151	29,0	154	29,3		
21	87,7			16,6	105	19,4	122	23,0	130	25,0	138	27,1	150	29,7	153	30,0		
23	87,7			17,0	105	20,6	122	24,6	130	26,7	138	29,0	147	31,1	151	31,3		
25	87,7			18,1	105	21,9	122	26,2	130	28,5	138	30,9	145	32,4	148	32,7		
27	87,7			19,2	105	23,3	122	27,9	130	30,4	138	32,9	143	33,8	146	34,1		
29	87,7			20,3	105	24,7	122	29,7	130	32,3	138	34,9	141	35,2	144	35,5		
31	87,7			21,5	105	26,2	122	31,5	130	34,4	136	36,2	139	36,5	142	36,9		
33	87,7			22,8	105	27,8	122	33,5	130	36,5	134	37,6	137	37,9	140	38,3		
35	87,7			24,1	105	29,5	122	35,5	130	38,8	132	39,0	135	39,3	138	39,7		
37	87,7			25,4	105	31,2	122	37,7	128	40,2	129	40,3	133	40,7	136	41,1		
39	87,7			26,9	105	33,1	122	40,0	126	41,5	127	41,7	131	42,1	134	42,5		

**NOTES - ANMERKUNGEN - Σημειώσεις - NOTAS - REMARQUES - NOTE - OPMERKINGEN - Примечания - NOTLAR**

- The above table shows the average value of conditions which may occur.  
 Die obige Tabelle zeigt den Durchschnittswert der Bedingungen, die auftreten können.  
 Στον παραπάνω πίνακα αναγράφεται η μέση τιμή για συνθήκες που μπορεί να προκύψουν.  
 La tabla de arriba muestra el valor medio de condiciones que pueden ocurrir.  
 Le tableau ci-dessus donne la valeur moyenne pour des conditions qui peuvent survenir.  
 La tabella in alto mostra il valore delle condizioni medie che si possono riscontrare.  
 De tabel hierboven geeft de gemiddelde waarde aan van situaties die kunnen voorvallen.  
 Таблица расположенная выше показывает среднее значение условий, которые могут наступить.  
 Yukarıdaki tablo meydana gelebilecek koşulların ortalama değerini göstermektedir.

# 5 Capacity tables

## 5 - 1 Cooling Capacity Tables

5

**RQYQ46PY1**

TC: Total Capacity: kW ; PI: Power Input: kW (compressor + outdoor fan motor)

Combination (%)	Capacity index (kW)	Outdoor air temp. °CDB	Indoor air temperature: °CWB													
			14.0		16.0		18.0		19.0		20.0		22.0		24.0	
			TC	PI	TC	PI	TC	PI	TC	PI	TC	PI	TC	PI	TC	PI
90	113.40	10	79.0	14.2	94.2	16.3	109	18.6	117	19.7	125	20.9	140	23.3	155	25.7
		12	79.0	14.4	94.2	16.6	109	18.8	117	20.0	125	21.2	140	23.6	155	26.1
		14	79.0	14.6	94.2	16.8	109	19.1	117	20.3	125	21.5	140	24.0	155	26.5
		16	79.0	14.8	94.2	17.0	109	19.4	117	20.6	125	21.9	140	24.4	155	26.9
		18	79.0	15.0	94.2	17.3	109	19.7	117	21.0	125	22.2	140	24.8	153	27.7
		20	79.0	15.2	94.2	17.5	109	20.0	117	21.3	125	23.0	140	26.5	151	29.0
		21	79.0	15.3	94.2	17.7	109	20.3	117	22.0	125	23.7	140	27.5	149	29.7
		23	79.0	15.5	94.2	18.3	109	21.7	117	23.5	125	25.3	140	29.3	147	31.1
		25	79.0	16.2	94.2	19.5	109	23.1	117	25.0	125	27.0	140	31.3	145	32.4
		27	79.0	17.2	94.2	20.7	109	24.5	117	26.6	125	28.8	140	33.4	143	33.8
		29	79.0	18.2	94.2	21.9	109	26.1	117	28.3	125	30.6	138	34.9	141	35.2
		31	79.0	19.3	94.2	23.2	109	27.7	117	30.0	125	32.5	136	36.3	139	36.5
		33	79.0	20.4	94.2	24.6	109	29.4	117	31.9	125	34.6	134	37.6	137	37.9
		35	79.0	21.5	94.2	26.1	109	31.1	117	33.8	125	36.7	132	39.0	135	39.3
		37	79.0	22.7	94.2	27.6	109	33.0	117	35.9	125	39.0	130	40.4	133	40.7
		39	79.0	24.0	94.2	29.2	109	35.0	117	38.1	125	41.3	128	41.8	130	42.1
		80	100.80	10	70.2	13.0	83.7	14.9	97.2	16.8	104	17.8	111	18.8	124	20.8
12	70.2			13.2	83.7	15.1	97.2	17.0	104	18.0	111	19.1	124	21.2	138	23.3
14	70.2			13.3	83.7	15.3	97.2	17.3	104	18.3	111	19.3	124	21.5	138	23.7
16	70.2			13.5	83.7	15.5	97.2	17.5	104	18.6	111	19.6	124	21.8	138	24.1
18	70.2			13.7	83.7	15.7	97.2	17.8	104	18.8	111	19.9	124	22.2	138	24.4
20	70.2			13.9	83.7	15.9	97.2	18.0	104	19.1	111	20.3	124	22.9	138	26.1
21	70.2			13.9	83.7	16.0	97.2	18.2	104	19.3	111	20.6	124	23.7	138	26.9
23	70.2			14.1	83.7	16.2	97.2	19.0	104	20.4	111	22.0	124	25.3	138	28.8
25	70.2			14.5	83.7	17.2	97.2	20.2	104	21.8	111	23.4	124	26.9	138	30.7
27	70.2			15.4	83.7	18.2	97.2	21.4	104	23.1	111	24.9	124	28.7	138	32.7
29	70.2			16.2	83.7	19.3	97.2	22.7	104	24.6	111	26.5	124	30.5	138	34.9
31	70.2			17.2	83.7	20.5	97.2	24.1	104	26.0	111	28.1	124	32.4	136	36.2
33	70.2			18.1	83.7	21.6	97.2	25.5	104	27.6	111	29.8	124	34.4	134	37.6
35	70.2			19.1	83.7	22.9	97.2	27.0	104	29.3	111	31.6	124	36.6	131	39.0
37	70.2			20.1	83.7	24.2	97.2	28.6	104	31.0	111	33.5	124	38.8	129	40.3
39	70.2			21.2	83.7	25.5	97.2	30.3	104	32.8	111	35.5	124	41.2	127	41.7
70	88.20			10	61.4	11.9	73.2	13.4	85.1	15.1	91.0	15.9	96.9	16.7	109	18.5
		12	61.4	12.0	73.2	13.6	85.1	15.3	91.0	16.1	96.9	17.0	109	18.8	121	20.6
		14	61.4	12.2	73.2	13.8	85.1	15.5	91.0	16.3	96.9	17.2	109	19.0	121	20.9
		16	61.4	12.3	73.2	13.9	85.1	15.7	91.0	16.6	96.9	17.5	109	19.3	121	21.2
		18	61.4	12.4	73.2	14.1	85.1	15.9	91.0	16.8	96.9	17.7	109	19.6	121	21.6
		20	61.4	12.6	73.2	14.3	85.1	16.1	91.0	17.0	96.9	18.0	109	19.9	121	22.1
		21	61.4	12.7	73.2	14.4	85.1	16.2	91.0	17.2	96.9	18.1	109	20.2	121	22.8
		23	61.4	12.8	73.2	14.6	85.1	16.5	91.0	17.7	96.9	18.9	109	21.5	121	24.3
		25	61.4	13.0	73.2	15.1	85.1	17.5	91.0	18.8	96.9	20.1	109	22.9	121	25.9
		27	61.4	13.7	73.2	16.0	85.1	18.6	91.0	19.9	96.9	21.3	109	24.4	121	27.6
		29	61.4	14.4	73.2	16.9	85.1	19.7	91.0	21.1	96.9	22.6	109	25.9	121	29.4
		31	61.4	15.2	73.2	17.9	85.1	20.8	91.0	22.4	96.9	24.0	109	27.5	121	31.2
		33	61.4	16.0	73.2	18.9	85.1	22.0	91.0	23.7	96.9	25.4	109	29.1	121	33.1
		35	61.4	16.9	73.2	19.9	85.1	23.3	91.0	25.1	96.9	26.9	109	30.9	121	35.2
		37	61.4	17.8	73.2	21.0	85.1	24.6	91.0	26.5	96.9	28.5	109	32.8	121	37.3
		39	61.4	18.7	73.2	22.2	85.1	26.0	91.0	28.0	96.9	30.2	109	34.7	121	39.6
		60	75.60	10	52.6	10.84	62.8	12.1	72.9	13.4	78.0	14.1	83.1	14.8	93.2	16.2
12	52.6			10.94	62.8	12.2	72.9	13.6	78.0	14.3	83.1	15.0	93.2	16.4	103	17.9
14	52.6			11.05	62.8	12.4	72.9	13.7	78.0	14.4	83.1	15.2	93.2	16.7	103	18.2
16	52.6			11.16	62.8	12.5	72.9	13.9	78.0	14.6	83.1	15.4	93.2	16.9	103	18.5
18	52.6			11.3	62.8	12.6	72.9	14.1	78.0	14.8	83.1	15.6	93.2	17.1	103	18.7
20	52.6			11.4	62.8	12.8	72.9	14.3	78.0	15.0	83.1	15.8	93.2	17.4	103	19.0
21	52.6			11.5	62.8	12.9	72.9	14.4	78.0	15.1	83.1	15.9	93.2	17.5	103	19.2
23	52.6			11.6	62.8	13.0	72.9	14.5	78.0	15.3	83.1	16.1	93.2	18.1	103	20.3
25	52.6			11.7	62.8	13.2	72.9	15.0	78.0	16.0	83.1	17.1	93.2	19.3	103	21.6
27	52.6			12.1	62.8	13.9	72.9	15.9	78.0	17.0	83.1	18.1	93.2	20.4	103	23.0
29	52.6			12.7	62.8	14.7	72.9	16.8	78.0	18.0	83.1	19.2	93.2	21.7	103	24.4
31	52.6			13.4	62.8	15.5	72.9	17.8	78.0	19.0	83.1	20.3	93.2	23.0	103	25.9
33	52.6			14.1	62.8	16.3	72.9	18.8	78.0	20.1	83.1	21.5	93.2	24.3	103	27.4
35	52.6			14.8	62.8	17.2	72.9	19.8	78.0	21.2	83.1	22.7	93.2	25.8	103	29.1
37	52.6			15.6	62.8	18.1	72.9	20.9	78.0	22.4	83.1	24.0	93.2	27.2	103	30.8
39	52.6			16.4	62.8	19.1	72.9	22.1	78.0	23.7	83.1	25.3	93.2	28.8	103	32.6
50	63.00			10	43.9	9.82	52.3	10.80	60.8	11.8	65.0	12.4	69.2	12.9	77.7	14.0
		12	43.9	9.90	52.3	10.90	60.8	12.0	65.0	12.5	69.2	13.1	77.7	14.2	86.1	15.4
		14	43.9	9.99	52.3	11.01	60.8	12.1	65.0	12.6	69.2	13.2	77.7	14.4	86.1	15.6
		16	43.9	10.07	52.3	11.12	60.8	12.2	65.0	12.8	69.2	13.4	77.7	14.6	86.1	15.8
		18	43.9	10.16	52.3	11.2	60.8	12.4	65.0	12.9	69.2	13.5	77.7	14.8	86.1	16.0
		20	43.9	10.26	52.3	11.4	60.8	12.5	65.0	13.1	69.2	13.7	77.7	15.0	86.1	16.3
		21	43.9	10.31	52.3	11.4	60.8	12.6	65.0	13.2	69.2	13.8	77.7	15.1	86.1	16.4
		23	43.9	10.41	52.3	11.5	60.8	12.7	65.0	13.4	69.2	14.0	77.7	15.3	86.1	16.7
		25	43.9	10.51	52.3	11.7	60.8	12.9	65.0	13.6	69.2	14.3	77.7	16.0	86.1	17.7
		27	43.9	10.62	52.3	12.0	60.8	13.5	65.0	14.3	69.2	15.2	77.7	16.9	86.1	18.8
		29	43.9	11.18	52.3	12.7	60.8	14.3	65.0	15.1	69.2	16.0	77.7	17.9	86.1	19.9
		31	43.9	11.7	52.3	13.3	60.8	15.1	65.0	16.0	69.2	16.9	77.7	18.9	86.1	21.1
		33	43.9	12.3	52.3	14.										

# 5 Capacity tables

## 5 - 1 Cooling Capacity Tables

### RQYQ48PY1

TC: Total Capacity: kW ; PI: Power Input: kW (compressor + outdoor fan motor)

Combination (%)	Capacity index (kW)	Outdoor air temp. °CDB	Indoor air temperature: °CWB															
			14.0		16.0		18.0		19.0		20.0		22.0		24.0			
			TC	PI	TC	PI	TC	PI	TC	PI	TC	PI	TC	PI	TC	PI		
130	170.95	10	118	20,3	141	23,8	164	27,5	170	27,9	172	27,4	176	26,2	181	25,0		
		12	118	20,6	141	24,2	164	27,9	168	27,8	170	27,2	174	26,0	179	25,6		
		14	118	20,9	141	24,6	164	28,2	166	27,6	168	27,0	172	26,8	176	27,1		
		16	118	21,2	141	25,0	161	28,1	163	27,9	166	28,0	170	28,3	174	28,5		
		18	118	21,5	141	25,4	159	29,2	161	29,3	163	29,4	168	29,7	172	30,0		
		20	118	21,9	141	26,9	157	30,6	159	30,7	161	30,9	165	31,2	170	31,5		
		21	118	22,4	141	27,9	156	31,3	158	31,4	160	31,6	164	31,9	169	32,2		
		23	118	23,9	141	29,8	154	32,7	156	32,9	158	33,1	162	33,4	166	33,7		
		25	118	25,5	141	31,8	151	34,2	154	34,3	156	34,5	160	34,9	164	35,2		
		27	118	27,1	141	33,8	149	35,6	151	35,8	153	36,0	158	36,3	162	36,7		
		29	118	28,8	141	36,0	147	37,0	149	37,2	151	37,4	156	37,8	160	38,2		
		31	118	30,6	141	38,1	145	38,5	147	38,7	149	38,9	153	39,3	158	39,7		
		33	118	32,5	138	39,5	143	39,9	145	40,2	147	40,4	151	40,8	155	41,3		
		35	118	34,5	136	40,9	140	41,4	143	41,6	145	41,9	149	42,3	153	42,8		
		37	118	36,6	134	42,4	138	42,9	140	43,1	143	43,4	147	43,9	151	44,4		
		39	118	38,7	132	43,8	136	44,3	138	44,6	140	44,9	145	45,4	149	45,9		
		120	157.80	10	109	18,9	130	22,1	151	25,5	162	27,2	169	28,1	173	27,0	177	26,0
				12	109	19,2	130	22,5	151	25,9	162	27,6	167	27,9	171	26,9	175	25,8
14	109			19,4	130	22,8	151	26,3	162	28,0	165	27,8	169	26,7	173	26,9		
16	109			19,7	130	23,2	151	26,7	161	28,2	163	27,8	167	28,1	171	28,3		
18	109			20,0	130	23,5	151	27,5	159	29,1	161	29,3	165	29,5	169	29,8		
20	109			20,3	130	24,4	151	29,5	157	30,6	158	30,7	162	31,0	166	31,3		
21	109			20,5	130	25,2	151	30,5	155	31,3	157	31,4	161	31,7	165	32,0		
23	109			21,8	130	26,9	151	32,5	153	32,7	155	32,8	159	33,2	163	33,5		
25	109			23,2	130	28,7	149	34,0	151	34,1	153	34,3	157	34,6	161	34,9		
27	109			24,7	130	30,5	147	35,4	149	35,6	151	35,7	155	36,1	159	36,4		
29	109			26,2	130	32,5	145	36,8	147	37,0	149	37,2	153	37,5	156	37,9		
31	109			27,8	130	34,5	142	38,2	144	38,4	146	38,6	150	39,0	154	39,4		
33	109			29,5	130	36,7	140	39,7	142	39,9	144	40,1	148	40,5	152	40,9		
35	109			31,2	130	39,0	138	41,1	140	41,4	142	41,6	146	42,0	150	42,4		
37	109			33,1	130	41,4	136	42,6	138	42,8	140	43,1	144	43,5	148	44,0		
39	109			35,0	130	43,6	134	44,1	136	44,3	138	44,5	142	45,0	146	45,5		
110	144.65			10	100	17,5	120	20,4	139	23,5	149	25,0	158	26,5	170	27,8	174	26,9
				12	100	17,8	120	20,7	139	23,8	149	25,4	158	27,0	168	27,7	172	26,7
		14	100	18,0	120	21,1	139	24,2	149	25,8	158	27,4	166	27,5	170	26,7		
		16	100	18,3	120	21,4	139	24,6	149	26,2	158	27,8	164	27,9	167	28,1		
		18	100	18,6	120	21,7	139	25,0	149	26,8	158	29,1	162	29,3	165	29,6		
		20	100	18,8	120	22,1	139	26,4	149	28,7	156	30,5	159	30,8	163	31,0		
		21	100	19,0	120	22,7	139	27,3	149	29,7	155	31,2	158	31,5	162	31,7		
		23	100	19,8	120	24,2	139	29,1	149	31,8	153	32,6	156	32,9	160	33,2		
		25	100	21,0	120	25,8	139	31,1	149	33,9	150	34,1	154	34,4	158	34,7		
		27	100	22,3	120	27,4	139	33,1	146	35,3	148	35,5	152	35,8	155	36,1		
		29	100	23,7	120	29,1	139	35,2	144	36,8	146	36,9	150	37,3	153	37,6		
		31	100	25,1	120	31,0	139	37,5	142	38,2	144	38,4	147	38,7	151	39,1		
		33	100	26,6	120	32,9	138	39,4	140	39,6	142	39,8	145	40,2	149	40,6		
		35	100	28,2	120	34,9	136	40,9	138	41,1	139	41,3	143	41,7	147	42,1		
		37	100	29,8	120	37,0	134	42,3	135	42,5	137	42,7	141	43,2	144	43,6		
		39	100	31,6	120	39,2	131	43,8	133	44,0	135	44,2	139	44,7	142	45,1		
		100	131.50	10	91,1	16,2	109	18,8	126	21,5	135	22,9	144	24,2	161	27,1	171	27,8
				12	91,1	16,4	109	19,1	126	21,8	135	23,2	144	24,6	161	27,5	168	27,6
14	91,1			16,7	109	19,3	126	22,1	135	23,6	144	25,0	161	27,9	166	27,5		
16	91,1			16,9	109	19,6	126	22,5	135	23,9	144	25,4	161	28,2	164	27,9		
18	91,1			17,1	109	19,9	126	22,8	135	24,3	144	25,8	159	29,1	162	29,3		
20	91,1			17,4	109	20,2	126	23,4	135	25,4	144	27,6	156	30,5	160	30,8		
21	91,1			17,5	109	20,4	126	24,2	135	26,3	144	28,5	155	31,3	159	31,5		
23	91,1			17,9	109	21,6	126	25,8	135	28,1	144	30,5	153	32,7	156	32,9		
25	91,1			19,0	109	23,0	126	27,5	135	30,0	144	32,5	151	34,1	154	34,4		
27	91,1			20,1	109	24,5	126	29,3	135	31,9	144	34,6	149	35,5	152	35,8		
29	91,1			21,4	109	26,0	126	31,2	135	34,0	143	36,7	147	37,0	150	37,3		
31	91,1			22,6	109	27,6	126	33,1	135	36,1	141	38,1	144	38,4	148	38,8		
33	91,1			23,9	109	29,3	126	35,2	135	38,4	139	39,5	142	39,9	145	40,2		
35	91,1			25,3	109	31,0	126	37,4	135	40,8	137	41,0	140	41,3	143	41,7		
37	91,1			26,8	109	32,8	126	39,7	133	42,2	134	42,4	138	42,8	141	43,2		
39	91,1			28,3	109	34,8	126	42,1	131	43,7	132	43,9	136	44,3	139	44,7		

**NOTES - ANMERKUNGEN - Σημειώσεις - NOTAS - REMARQUES - NOTE - OPMERKINGEN - Примечания - NOTLAR**

- The above table shows the average value of conditions which may occur.  
 Die obige Tabelle zeigt den Durchschnittswert der Bedingungen, die auftreten können.  
 Στον παραπάνω πίνακα αναγράφεται η μέση τιμή για συνθήκες που μπορεί να προκύψουν.  
 La tabla de arriba muestra el valor medio de condiciones que pueden ocurrir.  
 Le tableau ci-dessus donne la valeur moyenne pour des conditions qui peuvent survenir.  
 La tabella in alto mostra il valore delle condizioni medie che si possono riscontrare.  
 De tabel hierboven geeft de gemiddelde waarde aan van situaties die kunnen voorvallen.  
 Таблица расположенная выше показывает среднее значение условий, которые могут наступить.  
 Yukarıdaki tablo meydana gelebilecek koşulların ortalama değerini göstermektedir.

# 5 Capacity tables

## 5 - 1 Cooling Capacity Tables

5

**RQYQ48PY1**

TC: Total Capacity: kW ; PI: Power Input: kW (compressor + outdoor fan motor)

Combination (%)	Capacity index (kW)	Outdoor air temp. °CDB	Indoor air temperature: °CWB															
			14.0		16.0		18.0		19.0		20.0		22.0		24.0			
			TC	PI	TC	PI	TC	PI	TC	PI	TC	PI	TC	PI	TC	PI		
90	118.35	10	82.0	14.9	97.8	17.2	114	19.5	122	20.7	129	22.0	145	24.5	161	27.0		
		12	82.0	15.1	97.8	17.4	114	19.8	122	21.1	129	22.3	145	24.8	161	27.4		
		14	82.0	15.3	97.8	17.7	114	20.1	122	21.4	129	22.6	145	25.2	161	27.9		
		16	82.0	15.5	97.8	17.9	114	20.4	122	21.7	129	23.0	145	25.6	161	28.2		
		18	82.0	15.7	97.8	18.2	114	20.7	122	22.0	129	23.4	145	26.1	159	29.1		
		20	82.0	15.9	97.8	18.4	114	21.1	122	22.4	129	24.2	145	27.9	156	30.5		
		21	82.0	16.1	97.8	18.6	114	21.4	122	23.1	129	25.0	145	28.9	155	31.2		
		23	82.0	16.3	97.8	19.3	114	22.8	122	24.7	129	26.6	145	30.8	153	32.7		
		25	82.0	17.1	97.8	20.5	114	24.3	122	26.3	129	28.4	145	32.9	151	34.1		
		27	82.0	18.1	97.8	21.7	114	25.8	122	28.0	129	30.2	145	35.1	149	35.5		
		29	82.0	19.1	97.8	23.1	114	27.4	122	29.7	129	32.2	143	36.7	146	37.0		
		31	82.0	20.3	97.8	24.4	114	29.1	122	31.6	129	34.2	141	38.1	144	38.4		
		33	82.0	21.4	97.8	25.9	114	30.9	122	33.5	129	36.3	139	39.6	142	39.9		
		35	82.0	22.6	97.8	27.4	114	32.7	122	35.6	129	38.6	137	41.0	140	41.3		
		37	82.0	23.9	97.8	29.0	114	34.7	122	37.8	129	41.0	135	42.5	138	42.8		
		39	82.0	25.2	97.8	30.7	114	36.8	122	40.0	129	43.5	133	43.9	135	44.3		
		80	105.20	10	72.9	13.7	86.9	15.6	101	17.7	108	18.7	115	19.8	129	21.9	143	24.1
				12	72.9	13.9	86.9	15.8	101	17.9	108	19.0	115	20.0	129	22.3	143	24.5
14	72.9			14.0	86.9	16.0	101	18.1	108	19.2	115	20.3	129	22.6	143	24.9		
16	72.9			14.2	86.9	16.3	101	18.4	108	19.5	115	20.6	129	22.9	143	25.3		
18	72.9			14.4	86.9	16.5	101	18.7	108	19.8	115	21.0	129	23.3	143	25.7		
20	72.9			14.6	86.9	16.7	101	19.0	108	20.1	115	21.3	129	24.1	143	27.4		
21	72.9			14.7	86.9	16.8	101	19.1	108	20.3	115	21.7	129	24.9	143	28.3		
23	72.9			14.9	86.9	17.1	101	19.9	108	21.5	115	23.1	129	26.6	143	30.3		
25	72.9			15.3	86.9	18.1	101	21.2	108	22.9	115	24.6	129	28.3	143	32.3		
27	72.9			16.2	86.9	19.2	101	22.5	108	24.3	115	26.2	129	30.1	143	34.4		
29	72.9			17.1	86.9	20.3	101	23.9	108	25.8	115	27.8	129	32.1	143	36.7		
31	72.9			18.0	86.9	21.5	101	25.3	108	27.4	115	29.5	129	34.1	141	38.1		
33	72.9			19.0	86.9	22.8	101	26.8	108	29.0	115	31.3	129	36.2	139	39.5		
35	72.9			20.1	86.9	24.0	101	28.4	108	30.8	115	33.2	129	38.5	137	41.0		
37	72.9			21.2	86.9	25.4	101	30.1	108	32.6	115	35.2	129	40.8	134	42.4		
39	72.9			22.3	86.9	26.8	101	31.8	108	34.5	115	37.3	129	43.3	132	43.9		
70	92.05			10	63.8	12.5	76.1	14.1	88.4	15.8	94.5	16.7	101	17.6	113	19.4	125	21.3
				12	63.8	12.7	76.1	14.3	88.4	16.0	94.5	16.9	101	17.8	113	19.7	125	21.6
		14	63.8	12.8	76.1	14.5	88.4	16.2	94.5	17.2	101	18.1	113	20.0	125	22.0		
		16	63.8	12.9	76.1	14.7	88.4	16.5	94.5	17.4	101	18.4	113	20.3	125	22.3		
		18	63.8	13.1	76.1	14.8	88.4	16.7	94.5	17.7	101	18.6	113	20.6	125	22.7		
		20	63.8	13.2	76.1	15.0	88.4	16.9	94.5	17.9	101	18.9	113	20.9	125	23.2		
		21	63.8	13.3	76.1	15.1	88.4	17.1	94.5	18.0	101	19.1	113	21.2	125	24.0		
		23	63.8	13.5	76.1	15.4	88.4	17.3	94.5	18.6	101	19.9	113	22.6	125	25.6		
		25	63.8	13.7	76.1	15.9	88.4	18.4	94.5	19.7	101	21.1	113	24.1	125	27.3		
		27	63.8	14.4	76.1	16.8	88.4	19.5	94.5	20.9	101	22.4	113	25.6	125	29.0		
		29	63.8	15.2	76.1	17.8	88.4	20.7	94.5	22.2	101	23.8	113	27.2	125	30.9		
		31	63.8	16.0	76.1	18.8	88.4	21.9	94.5	23.5	101	25.2	113	28.9	125	32.8		
		33	63.8	16.9	76.1	19.9	88.4	23.1	94.5	24.9	101	26.7	113	30.6	125	34.8		
		35	63.8	17.8	76.1	21.0	88.4	24.5	94.5	26.4	101	28.3	113	32.5	125	37.0		
		37	63.8	18.7	76.1	22.1	88.4	25.9	94.5	27.9	101	30.0	113	34.4	125	39.2		
		39	63.8	19.7	76.1	23.3	88.4	27.3	94.5	29.5	101	31.7	113	36.5	125	41.6		
		60	78.90	10	54.7	11.4	65.2	12.7	75.7	14.1	81.0	14.8	86.3	15.5	96.8	17.0	107	18.6
				12	54.7	11.5	65.2	12.8	75.7	14.3	81.0	15.0	86.3	15.7	96.8	17.3	107	18.9
14	54.7			11.6	65.2	13.0	75.7	14.4	81.0	15.2	86.3	15.9	96.8	17.5	107	19.1		
16	54.7			11.7	65.2	13.1	75.7	14.6	81.0	15.4	86.3	16.2	96.8	17.8	107	19.4		
18	54.7			11.9	65.2	13.3	75.7	14.8	81.0	15.6	86.3	16.4	96.8	18.0	107	19.7		
20	54.7			12.0	65.2	13.4	75.7	15.0	81.0	15.8	86.3	16.6	96.8	18.3	107	20.0		
21	54.7			12.0	65.2	13.5	75.7	15.1	81.0	15.9	86.3	16.7	96.8	18.4	107	20.2		
23	54.7			12.2	65.2	13.7	75.7	15.3	81.0	16.1	86.3	17.0	96.8	19.1	107	21.3		
25	54.7			12.3	65.2	13.9	75.7	15.8	81.0	16.9	86.3	18.0	96.8	20.3	107	22.7		
27	54.7			12.7	65.2	14.6	75.7	16.7	81.0	17.9	86.3	19.0	96.8	21.5	107	24.1		
29	54.7			13.4	65.2	15.5	75.7	17.7	81.0	18.9	86.3	20.2	96.8	22.8	107	25.6		
31	54.7			14.1	65.2	16.3	75.7	18.7	81.0	20.0	86.3	21.3	96.8	24.2	107	27.2		
33	54.7			14.8	65.2	17.2	75.7	19.8	81.0	21.1	86.3	22.6	96.8	25.6	107	28.8		
35	54.7			15.6	65.2	18.1	75.7	20.9	81.0	22.3	86.3	23.9	96.8	27.1	107	30.6		
37	54.7			16.4	65.2	19.1	75.7	22.0	81.0	23.6	86.3	25.2	96.8	28.7	107	32.4		
39	54.7			17.2	65.2	20.1	75.7	23.2	81.0	24.9	86.3	26.6	96.8	30.3	107	34.3		
50	65.75			10	45.6	10.33	54.3	11.4	63.1	12.4	67.5	13.0	71.9	13.6	80.7	14.8	89.4	16.0
				12	45.6	10.41	54.3	11.5	63.1	12.6	67.5	13.2	71.9	13.7	80.7	14.9	89.4	16.2
		14	45.6	10.50	54.3	11.6	63.1	12.7	67.5	13.3	71.9	13.9	80.7	15.1	89.4	16.4		
		16	45.6	10.59	54.3	11.7	63.1	12.9	67.5	13.5	71.9	14.1	80.7	15.3	89.4	16.6		
		18	45.6	10.69	54.3	11.8	63.1	13.0	67.5	13.6	71.9	14.2	80.7	15.5	89.4	16.9		
		20	45.6	10.79	54.3	11.9	63.1	13.2	67.5	13.8	71.9	14.4	80.7	15.7	89.4	17.1		
		21	45.6	10.84	54.3	12.0	63.1	13.2	67.5	13.9	71.9	14.5	80.7	15.8	89.4	17.2		
		23	45.6	10.94	54.3	12.1	63.1	13.4	67.5	14.0	71.9	14.7	80.7	16.1	89.4	17.5		
		25	45.6	11.05	54.3	12.3	63.1	13.6	67.5	14.3	71.9	15.1	80.7	16.8	89.4	18.6		
		27	45.6	11.17	54.3	12.6	63.1	14.2	67.5	15.1	71.9	16.0	80.7	17.8	89.4	19.8		
		29	45.6	11.8	54.3	13.3	63.1	15.0	67.5	15.9	71.9	16.9	80.7	18.8	89.4	20.9		
		31	45.6	12.4	54.3	14.0	63.1	15.8	67.5	16.8	71.9	17.8	80.7	19.9	89.4	22.2		
		33	45.6	13.0	54.3	14.8	63.1	16.7	67.5	1								

# 5 Capacity tables

## 5 - 2 Heating Capacity Tables

RQYQ140P		TC: Total Capacity; PI Power Input: kW (Comp. + Outdoor fan motor)													
Combination (%)	Capacity index (kW)	Outdoor air temp.		Indoor air temp. CDB											
				16.0		18.0		20.0		21.0		22.0		24.0	
		°CDB	°CWB	TC	PI	TC	PI	TC	PI	TC	PI	TC	PI	TC	PI
130	18.20	-19.8	-20.0	10.6	2.83	10.5	3.02	10.5	3.22	10.5	3.31	10.4	3.41	10.4	3.60
		-18.8	-19.0	10.9	2.94	10.8	3.12	10.8	3.31	10.8	3.40	10.8	3.50	10.7	3.68
		-16.7	-17.0	11.5	3.13	11.5	3.30	11.4	3.48	11.4	3.57	11.4	3.66	11.3	3.83
		-13.7	-15.0	12.1	3.30	12.1	3.47	12.0	3.63	12.0	3.72	12.0	3.80	12.0	3.96
		-11.8	-13.0	12.7	3.45	12.7	3.61	12.7	3.77	12.7	3.85	12.6	3.93	12.6	4.08
		-9.8	-11.0	13.4	3.59	13.3	3.74	13.3	3.89	13.3	3.97	13.3	4.04	13.2	4.19
		-9.5	-10.0	13.7	3.66	13.7	3.80	13.6	3.95	13.6	4.02	13.6	4.10	13.5	4.24
		-8.5	-9.1	14.0	3.71	13.9	3.86	13.9	4.00	13.9	4.07	13.9	4.14	13.8	4.29
		-7.0	-7.6	14.4	3.80	14.4	3.94	14.4	4.08	14.3	4.15	14.3	4.22	14.3	4.36
		-5.0	-5.6	15.1	3.91	15.0	4.04	15.0	4.18	15.0	4.24	15.0	4.31	14.9	4.44
		-3.0	-3.7	15.7	4.01	15.6	4.13	15.6	4.26	15.6	4.32	15.5	4.39	15.5	4.52
		0.0	-0.7	16.6	4.14	16.6	4.26	16.5	4.38	16.5	4.44	16.5	4.50	16.5	4.62
		3.0	2.2	17.5	4.26	17.5	4.37	17.4	4.49	17.4	4.55	17.4	4.60	17.4	4.72
		5.0	4.1	18.1	4.33	18.1	4.44	18.0	4.55	18.0	4.61	18.0	4.66	18.0	4.77
		7.0	6.0	18.7	4.40	18.7	4.51	18.6	4.61	18.6	4.67	18.6	4.72	18.1	4.65
		9.0	7.9	19.3	4.46	19.3	4.57	19.2	4.67	19.2	4.72	19.2	4.77	18.1	4.48
		11.0	9.8	19.9	4.52	19.8	4.62	19.8	4.72	19.8	4.77	19.5	4.70	18.1	4.31
13.0	11.8	20.5	4.58	20.5	4.68	20.4	4.78	20.1	4.72	19.5	4.53	18.1	4.15		
15.0	13.7	21.1	4.63	21.1	4.73	20.8	4.74	20.1	4.55	19.5	4.37	18.1	4.01		
120	16.80	-19.8	-20.0	10.5	3.09	10.5	3.27	10.4	3.45	10.4	3.54	10.4	3.62	10.4	3.80
		-18.8	-19.0	10.8	3.19	10.8	3.36	10.8	3.53	10.7	3.62	10.7	3.71	10.7	3.88
		-16.7	-17.0	11.4	3.37	11.4	3.53	11.4	3.69	11.4	3.77	11.3	3.85	11.3	4.02
		-13.7	-15.0	12.1	3.52	12.0	3.68	12.0	3.83	12.0	3.91	12.0	3.98	11.9	4.14
		-11.8	-13.0	12.7	3.67	12.7	3.81	12.6	3.96	12.6	4.03	12.6	4.10	12.6	4.25
		-9.8	-11.0	13.3	3.80	13.3	3.93	13.3	4.07	13.2	4.14	13.2	4.21	13.2	4.35
		-9.5	-10.0	13.6	3.86	13.6	3.99	13.6	4.13	13.6	4.19	13.5	4.26	13.5	4.40
		-8.5	-9.1	13.9	3.91	13.9	4.04	13.9	4.17	13.8	4.24	13.8	4.30	13.8	4.44
		-7.0	-7.6	14.4	3.99	14.4	4.12	14.3	4.24	14.3	4.31	14.3	4.37	14.3	4.50
		-5.0	-5.6	15.0	4.09	15.0	4.21	14.9	4.33	14.9	4.40	14.9	4.46	14.9	4.58
		-3.0	-3.7	15.6	4.18	15.6	4.30	15.5	4.41	15.5	4.47	15.5	4.53	15.5	4.65
		0.0	-0.7	16.5	4.30	16.5	4.42	16.5	4.53	16.5	4.58	16.4	4.64	16.4	4.75
		3.0	2.2	17.5	4.41	17.4	4.52	17.4	4.63	17.4	4.68	17.4	4.73	16.7	4.58
		5.0	4.1	18.1	4.48	18.0	4.58	18.0	4.68	18.0	4.74	17.9	4.79	16.7	4.39
		7.0	6.0	18.6	4.54	18.6	4.64	18.6	4.74	18.6	4.79	18.0	4.60	16.7	4.22
		9.0	7.9	19.2	4.60	19.2	4.70	19.2	4.79	18.6	4.61	18.0	4.43	16.7	4.06
		11.0	9.8	19.8	4.66	19.8	4.75	19.2	4.62	18.6	4.44	18.0	4.26	16.7	3.92
13.0	11.8	20.5	4.71	20.4	4.80	19.2	4.45	18.6	4.28	18.0	4.11	16.7	3.77		
15.0	13.7	21.1	4.76	20.4	4.64	19.2	4.30	18.6	4.13	18.0	3.97	16.7	3.65		
110	15.40	-19.8	-20.0	10.5	3.35	10.4	3.51	10.4	3.68	10.4	3.76	10.4	3.84	10.3	4.00
		-18.8	-19.0	10.8	3.44	10.7	3.60	10.7	3.76	10.7	3.84	10.7	3.91	10.6	4.07
		-16.7	-17.0	11.4	3.60	11.4	3.75	11.3	3.90	11.3	3.98	11.3	4.05	11.3	4.20
		-13.7	-15.0	12.0	3.75	12.0	3.89	12.0	4.03	11.9	4.10	11.9	4.17	11.9	4.31
		-11.8	-13.0	12.6	3.88	12.6	4.01	12.6	4.15	12.6	4.21	12.6	4.28	12.5	4.41
		-9.8	-11.0	13.3	4.00	13.2	4.13	13.2	4.25	13.2	4.32	13.2	4.38	13.2	4.51
		-9.5	-10.0	13.6	4.05	13.6	4.18	13.5	4.30	13.5	4.36	13.5	4.43	13.5	4.55
		-8.5	-9.1	13.9	4.10	13.8	4.22	13.8	4.34	13.8	4.40	13.8	4.47	13.7	4.59
		-7.0	-7.6	14.3	4.18	14.3	4.29	14.3	4.41	14.3	4.47	14.2	4.53	14.2	4.65
		-5.0	-5.6	15.0	4.27	14.9	4.38	14.9	4.49	14.9	4.55	14.9	4.61	14.8	4.72
		-3.0	-3.7	15.6	4.35	15.5	4.46	15.5	4.57	15.5	4.62	15.5	4.67	15.3	4.73
		0.0	-0.7	16.5	4.47	16.5	4.57	16.4	4.67	16.4	4.72	16.4	4.77	15.3	4.40
		3.0	2.2	17.4	4.57	17.4	4.67	17.3	4.76	17.0	4.68	16.5	4.49	15.3	4.12
		5.0	4.1	18.0	4.63	18.0	4.72	17.6	4.67	17.0	4.49	16.5	4.31	15.3	3.96
		7.0	6.0	18.6	4.69	18.6	4.78	17.6	4.49	17.0	4.31	16.5	4.14	15.3	3.80
		9.0	7.9	19.2	4.74	18.7	4.66	17.6	4.32	17.0	4.15	16.5	3.99	15.3	3.66
		11.0	9.8	19.8	4.79	18.7	4.49	17.6	4.16	17.0	4.00	16.5	3.84	15.3	3.53
13.0	11.8	19.9	4.64	18.7	4.32	17.6	4.01	17.0	3.85	16.5	3.70	15.3	3.41		
15.0	13.7	19.9	4.48	18.7	4.17	17.6	3.87	17.0	3.72	16.5	3.58	15.3	3.30		
100	14.00	-19.8	-20.0	10.4	3.61	10.4	3.76	10.4	3.91	10.3	3.98	10.3	4.06	10.3	4.20
		-18.8	-19.0	10.7	3.69	10.7	3.84	10.7	3.98	10.7	4.05	10.6	4.12	10.6	4.27
		-16.7	-17.0	11.3	3.84	11.3	3.98	11.3	4.11	11.3	4.18	11.3	4.25	11.2	4.38
		-13.7	-15.0	12.0	3.97	11.9	4.10	11.9	4.23	11.9	4.29	11.9	4.36	11.9	4.49
		-11.8	-13.0	12.6	4.09	12.6	4.21	12.5	4.34	12.5	4.40	12.5	4.46	12.5	4.58
		-9.8	-11.0	13.2	4.20	13.2	4.32	13.2	4.43	13.2	4.49	13.1	4.55	13.1	4.66
		-9.5	-10.0	13.5	4.25	13.5	4.36	13.5	4.48	13.5	4.53	13.5	4.59	13.4	4.70
		-8.5	-9.1	13.8	4.30	13.8	4.41	13.8	4.52	13.7	4.57	13.7	4.63	13.7	4.74
		-7.0	-7.6	14.3	4.36	14.3	4.47	14.2	4.58	14.2	4.63	14.2	4.68	13.9	4.67
		-5.0	-5.6	14.9	4.45	14.9	4.55	14.9	4.65	14.8	4.70	14.8	4.76	13.9	4.42
		-3.0	-3.7	15.5	4.52	15.5	4.62	15.5	4.72	15.4	4.77	15.0	4.60	13.9	4.21
		0.0	-0.7	16.4	4.63	16.4	4.72	16.0	4.63	15.5	4.45	15.0	4.27	13.9	3.92
		3.0	2.2	17.4	4.72	17.0	4.68	16.0	4.34	15.5	4.17	15.0	4.00	13.9	3.68
		5.0	4.1	18.0	4.78	17.0	4.49	16.0	4.16	15.5	4.00	15.0	3.84	13.9	3.54
		7.0	6.0	18.1	4.63	17.0	4.31	16.0	4.00	15.5	3.85	15.0	3.70	13.9	3.40
		9.0	7.9	18.1	4.45	17.0	4.15	16.0	3.85	15.5	3.71	15.0	3.56	13.9	3.28
		11.0	9.8	18.1	4.29	17.0	4.00	16.0	3.71	15.5	3.57	15.0	3.44	13.9	3.17
13.0	11.8	18.1	4.13	17.0	3.85	16.0	3.58	15.5	3.45	15.0	3.32	13.9	3.06		
15.0	13.7	18.1	3.99	17.0	3.72	16.0	3.46	15.5	3.33	15.0	3.21	13.9	2.96		

S100071

**NOTES - ANMERKUNGEN - Σημειώσεις - NOTAS - REMARQUES - NOTE - OPMERKINGEN - Примечания - NOTLAR**

- is shown as reference. When selecting the unit models, avoid the Outdoor air temperature range shown by [ ].  
 dient als Verweis. Vermeiden Sie bei der Auswahl der Gerätemodelle den als [ ] markierten Temperaturbereich der Außenluft.  
 Η είναι ενδεικτική. κατά την επιλογή των μοντέλων των μονάδων, αποφεύγετε το εύρος θερμοκρασίας εξωτερικού αέρα που υποδεικνύεται.  
 se muestra como referencia. Cuando seleccione los modelos de unidad, evite el intervalo de temperaturas del aire exterior indicado mediante [ ].  
 est montré comme référence. Lors du choix des modèles d'unités, évitez la plage de températures de l'air extérieur illustré par [ ].  
 valori riportati unicamente come riferimento. Nel selezionare i modelli delle unità, non considerare i valori di temperatura dell'aria esterna indicati con il colore [ ].  
 is als referentie getoond. Wanneer modellen van eenheden worden gekozen, vermijd dan het bereik van buitenluchttemperaturen geïllustreerd door [ ].
- The above table shows the average value of conditions which may occur.  
 Die obige Tabelle zeigt den Durchschnittswert der Bedingungen, die auftreten können.  
 Στον παραπάνω πίνακα αναγράφεται η μέση τιμή για συνθήκες που μπορεί να προκύψουν.  
 La tabla de arriba muestra el valor medio de condiciones que pueden ocurrir.  
 Le tableau ci-dessus donne la valeur moyenne pour des conditions qui peuvent survenir.  
 La tabella in alto mostra il valore delle condizioni medie che si possono riscontrare.  
 De tabel hierboven geeft de gemiddelde waarde aan van situaties die kunnen voorvallen.  
 Таблица расположенная выше показывает среднее значение условий, которые могут наступить.  
 Yukarıdaki tablo meydana gelebilecek koşulların ortalama değerini göstermektedir.



# 5 Capacity tables

## 5 - 2 Heating Capacity Tables

5

RQYQ140P		TC: Total Capacity; PI Power Input: kW (Comp. + Outdoor fan motor)															
Combination (%)	Capacity index (kW)	Outdoor air temp.		Indoor air temp. CDB													
				16.0		18.0		20.0		21.0		22.0		24.0			
		°CDB	°CWB	TC	PI	TC	PI	TC	PI	TC	PI	TC	PI	TC	PI		
90	12.60	-19.8	-20.0	10.4	3.87	10.3	4.00	10.3	4.14	10.3	4.20	10.3	4.27	10.3	4.33	10.3	4.40
		-18.8	-19.0	10.7	3.94	10.6	4.07	10.6	4.20	10.6	4.27	10.6	4.33	10.6	4.39	10.6	4.46
		-16.7	-17.0	11.3	4.08	11.3	4.20	11.2	4.32	11.2	4.38	11.2	4.44	11.2	4.50	11.2	4.57
		-13.7	-15.0	11.9	4.20	11.9	4.31	11.9	4.43	11.9	4.49	11.8	4.54	11.8	4.60	11.8	4.66
		-11.8	-13.0	12.6	4.31	12.5	4.42	12.5	4.53	12.5	4.58	12.5	4.63	12.5	4.68	12.4	4.74
		-9.8	-11.0	13.2	4.40	13.2	4.51	13.1	4.61	13.1	4.66	13.1	4.72	13.1	4.77	12.5	4.82
		-9.5	-10.0	13.5	4.45	13.5	4.55	13.4	4.65	13.4	4.70	13.4	4.75	13.4	4.80	12.5	4.85
		-8.5	-9.1	13.8	4.49	13.7	4.59	13.7	4.69	13.7	4.74	13.5	4.79	13.5	4.84	12.5	4.89
		-7.0	-7.6	14.2	4.55	14.2	4.65	14.2	4.74	13.9	4.66	13.5	4.67	13.5	4.72	12.5	4.77
		-5.0	-5.6	14.9	4.63	14.8	4.72	14.4	4.60	13.9	4.42	13.5	4.24	13.5	4.29	12.5	4.34
		-3.0	-3.7	15.5	4.70	15.3	4.73	14.4	4.38	13.9	4.21	13.5	4.04	13.5	4.09	12.5	4.14
		0.0	-0.7	16.3	4.72	15.3	4.40	14.4	4.08	13.9	3.92	13.5	3.77	13.5	3.82	12.5	3.87
		3.0	2.2	16.3	4.42	15.3	4.12	14.4	3.82	13.9	3.68	13.5	3.53	13.5	3.58	12.5	3.63
		5.0	4.1	16.3	4.24	15.3	3.95	14.4	3.67	13.9	3.53	13.5	3.40	13.5	3.45	12.5	3.50
		7.0	6.0	16.3	4.07	15.3	3.80	14.4	3.53	13.9	3.40	13.5	3.27	13.5	3.32	12.5	3.37
		9.0	7.9	16.3	3.92	15.3	3.66	14.4	3.40	13.9	3.28	13.5	3.16	13.5	3.21	12.5	3.26
		11.0	9.8	16.3	3.78	15.3	3.53	14.4	3.29	13.9	3.17	13.5	3.05	13.5	3.10	12.5	3.15
13.0	11.8	16.3	3.65	15.3	3.41	14.4	3.17	13.9	3.06	13.5	2.94	13.5	2.99	12.5	3.04		
15.0	13.7	16.3	3.52	15.3	3.29	14.4	3.07	13.9	2.96	13.5	2.85	13.5	2.90	12.5	2.95		
80	11.20	-19.8	-20.0	10.3	4.13	10.3	4.25	10.3	4.37	10.3	4.43	10.2	4.49	10.2	4.55	10.2	4.61
		-18.8	-19.0	10.6	4.20	10.6	4.31	10.6	4.43	10.6	4.48	10.6	4.54	10.5	4.60	10.5	4.66
		-16.7	-17.0	11.2	4.32	11.2	4.42	11.2	4.53	11.2	4.59	11.2	4.64	11.2	4.70	11.2	4.76
		-13.7	-15.0	11.9	4.42	11.9	4.53	11.8	4.63	11.8	4.68	11.8	4.73	11.8	4.79	11.2	4.85
		-11.8	-13.0	12.5	4.52	12.5	4.62	12.5	4.71	12.4	4.73	12.0	4.54	12.0	4.59	11.2	4.65
		-9.8	-11.0	13.1	4.61	13.1	4.70	12.8	4.63	12.4	4.45	12.0	4.27	12.0	4.32	11.2	4.38
		-9.5	-10.0	13.4	4.65	13.4	4.74	12.8	4.50	12.4	4.32	12.0	4.15	12.0	4.20	11.2	4.26
		-8.5	-9.1	13.7	4.68	13.6	4.73	12.8	4.38	12.4	4.21	12.0	4.04	12.0	4.09	11.2	4.15
		-7.0	-7.6	14.2	4.74	13.6	4.53	12.8	4.20	12.4	4.04	12.0	3.88	12.0	3.93	11.2	3.99
		-5.0	-5.6	14.4	4.62	13.6	4.30	12.8	3.99	12.4	3.84	12.0	3.69	12.0	3.74	11.2	3.80
		-3.0	-3.7	14.4	4.40	13.6	4.10	12.8	3.80	12.4	3.66	12.0	3.52	12.0	3.57	11.2	3.63
		0.0	-0.7	14.4	4.09	13.6	3.82	12.8	3.55	12.4	3.41	12.0	3.28	12.0	3.33	11.2	3.39
		3.0	2.2	14.4	3.84	13.6	3.58	12.8	3.33	12.4	3.21	12.0	3.09	12.0	3.14	11.2	3.20
		5.0	4.1	14.4	3.68	13.6	3.44	12.8	3.20	12.4	3.09	12.0	2.97	12.0	3.02	11.2	3.08
		7.0	6.0	14.4	3.55	13.6	3.31	12.8	3.09	12.4	2.97	12.0	2.86	12.0	2.91	11.2	2.96
		9.0	7.9	14.4	3.42	13.6	3.19	12.8	2.98	12.4	2.87	12.0	2.77	12.0	2.82	11.2	2.87
		11.0	9.8	14.4	3.30	13.6	3.09	12.8	2.88	12.4	2.78	12.0	2.67	12.0	2.72	11.2	2.77
13.0	11.8	14.4	3.18	13.6	2.98	12.8	2.78	12.4	2.68	12.0	2.59	12.0	2.64	11.2	2.69		
15.0	13.7	14.4	3.08	13.6	2.88	12.8	2.69	12.4	2.60	12.0	2.51	12.0	2.56	11.2	2.61		
70	9.80	-19.8	-20.0	10.3	4.39	10.2	4.49	10.2	4.60	10.2	4.65	10.2	4.70	9.8	4.75	9.8	4.80
		-18.8	-19.0	10.6	4.45	10.6	4.55	10.5	4.65	10.5	4.70	10.5	4.75	9.8	4.80	9.8	4.85
		-16.7	-17.0	11.2	4.55	11.2	4.65	11.2	4.74	10.8	4.58	10.5	4.40	9.8	4.45	9.8	4.50
		-13.7	-15.0	11.8	4.65	11.8	4.74	11.2	4.46	10.8	4.28	10.5	4.11	9.8	4.16	9.8	4.21
		-11.8	-13.0	12.5	4.73	11.9	4.51	11.2	4.18	10.8	4.02	10.5	3.86	9.8	3.91	9.8	3.96
		-9.8	-11.0	12.6	4.56	11.9	4.24	11.2	3.94	10.8	3.79	10.5	3.64	9.8	3.69	9.8	3.74
		-9.5	-10.0	12.6	4.43	11.9	4.12	11.2	3.83	10.8	3.68	10.5	3.54	9.8	3.59	9.8	3.64
		-8.5	-9.1	12.6	4.31	11.9	4.02	11.2	3.73	10.8	3.59	10.5	3.45	9.8	3.50	9.8	3.55
		-7.0	-7.6	12.6	4.14	11.9	3.86	11.2	3.59	10.8	3.45	10.5	3.32	9.8	3.37	9.8	3.42
		-5.0	-5.6	12.6	3.93	11.9	3.67	11.2	3.41	10.8	3.28	10.5	3.16	9.8	3.21	9.8	3.26
		-3.0	-3.7	12.6	3.75	11.9	3.50	11.2	3.26	10.8	3.14	10.5	3.02	9.8	3.07	9.8	3.12
		0.0	-0.7	12.6	3.49	11.9	3.27	11.2	3.04	10.8	2.93	10.5	2.83	9.8	2.88	9.8	2.93
		3.0	2.2	12.6	3.28	11.9	3.07	11.2	2.86	10.8	2.76	10.5	2.66	9.8	2.71	9.8	2.76
		5.0	4.1	12.6	3.16	11.9	2.96	11.2	2.76	10.8	2.66	10.5	2.57	9.8	2.62	9.8	2.67
		7.0	6.0	12.6	3.04	11.9	2.85	11.2	2.66	10.8	2.57	10.5	2.48	9.8	2.53	9.8	2.58
		9.0	7.9	12.6	2.94	11.9	2.75	11.2	2.57	10.8	2.48	10.5	2.39	9.8	2.44	9.8	2.49
		11.0	9.8	12.6	2.84	11.9	2.66	11.2	2.49	10.8	2.40	10.5	2.32	9.8	2.37	9.8	2.42
13.0	11.8	12.6	2.74	11.9	2.57	11.2	2.41	10.8	2.32	10.5	2.24	9.8	2.29	9.8	2.34		
15.0	13.7	12.6	2.66	11.9	2.49	11.2	2.33	10.8	2.25	10.5	2.18	9.8	2.23	9.8	2.28		
60	8.40	-19.8	-20.0	10.2	4.65	10.2	4.74	9.6	4.41	9.3	4.23	9.0	4.06	8.4	4.11	8.4	4.16
		-18.8	-19.0	10.5	4.70	10.2	4.58	9.6	4.24	9.3	4.08	9.0	3.92	8.4	3.97	8.4	4.02
		-16.7	-17.0	10.8	4.58	10.2	4.26	9.6	3.95	9.3	3.80	9.0	3.65	8.4	3.70	8.4	3.75
		-13.7	-15.0	10.8	4.28	10.2	3.99	9.6	3.70	9.3	3.56	9.0	3.43	8.4	3.48	8.4	3.53
		-11.8	-13.0	10.8	4.02	10.2	3.75	9.6	3.48	9.3	3.35	9.0	3.23	8.4	3.28	8.4	3.33
		-9.8	-11.0	10.8	3.79	10.2	3.53	9.6	3.29	9.3	3.17	9.0	3.05	8.4	3.10	8.4	3.15
		-9.5	-10.0	10.8	3.68	10.2	3.44	9.6	3.20	9.3	3.08	9.0	2.97	8.4	3.02	8.4	3.07
		-8.5	-9.1	10.8	3.59	10.2	3.35	9.6	3.12	9.3	3.01	9.0	2.90	8.4	2.95	8.4	3.00
		-7.0	-7.6	10.8	3.45	10.2	3.23	9.6	3.01	9.3	2.90	9.0	2.79	8.4	2.84	8.4	2.89
		-5.0	-5.6	10.8	3.28	10.2	3.07	9.6	2.86	9.3	2.76	9.0	2.66	8.4	2.71	8.4	2.76
		-3.0	-3.7	10.8	3.14	10.2	2.94	9.6	2.74	9.3	2.64	9.0	2.55	8.4	2.60	8.4	2.65
		0.0	-0.7	10.8	2.93	10.2	2.75	9.6	2.57	9.3	2.48	9.0	2.39	8.4	2.44	8.4	2.49
		3.0	2.2	10.8	2.76	10.2	2.59	9.6	2.42	9.3	2.34	9.0	2.26	8.4	2.31	8.4	2.36
		5.0	4.1	10.8	2.66	10.2	2.50	9.6	2.34	9.3	2.26	9.0	2.18	8.4	2.23	8.4	2.28
		7.0	6.0	10.8	2.57	10.2	2.41	9.6	2.26	9.3	2.18	9.0	2.11	8.4	2.16	8.4	2.21
		9.0	7.9	10.8	2.48	10.2	2.33	9.6	2.18	9.3	2.11	9.0	2.04	8.4	2.09	8.4	2.14
		11.0	9.8	10.8	2.40	10.2	2.26	9.6	2.12	9.3	2.05	9.0	1.98	8.4	2.03	8.4	2.08
13.0	11.8	10.8	2.32	10.2	2.18	9.6	2.05	9.3	1.98	9.0	1.92	8.4	1.97	8.4	2.02		
15.0	13.7	10.8	2.25	10.2	2.12	9.6	1.99	9.3	1.93	9.0	1.86	8.4	1.91	8.4	1.96		
50	7.00	-19.8	-20.0	9.0	4.09	8.5	3.81	8.0	3.54	7.7	3.41	7.5	3.28	7.0	3.33	7.0	3.38
		-18.8	-19.0	9.0	3.94	8.5	3.68	8.0	3.42	7.7	3.29	7.5	3.17	7.0	3.22	7.0	3.27
		-16.7	-17.0	9.0	3.68	8.5	3.43	8.0	3.20	7.7	3.08	7.5</					



# 5 Capacity tables

## 5 - 2 Heating Capacity Tables

RQYQ8PY1

TC: Total Capacity: kW ; PI: Power Input: kW (compressor + outdoor fan motor)

Combination (%)	Capacity index (kW)	Outdoor air temp.		Indoor air temperature: °CDB											
				16.0		18.0		20.0		21.0		22.0		24.0	
				TC	PI	TC	PI	TC	PI	TC	PI	TC	PI	TC	PI
130	29,12 kW	-19,8	-20,0	9,1	-0,76	9,1	-0,02	9,0	0,72	9,0	1,09	9,0	1,46	8,9	2,20
		-18,8	-19,0	9,8	0,16	9,7	0,84	9,6	1,52	9,6	1,86	9,6	2,20	9,5	2,88
		-16,7	-17,0	11,0	1,61	10,9	2,19	10,9	2,77	10,9	3,06	10,8	3,35	10,8	3,93
		-13,7	-15,0	12,2	2,67	12,2	3,17	12,1	3,67	12,1	3,92	12,1	4,18	12,0	4,68
		-11,8	-13,0	13,5	3,46	13,4	3,90	13,4	4,34	13,3	4,56	13,3	4,78	13,3	5,22
		-9,8	-11,0	14,7	4,05	14,7	4,44	14,6	4,84	14,6	5,03	14,6	5,23	14,5	5,62
		-9,5	-10,0	15,4	4,29	15,3	4,66	15,2	5,03	15,2	5,22	15,2	5,40	15,1	5,77
		-8,5	-9,1	15,9	4,48	15,9	4,83	15,8	5,18	15,8	5,36	15,7	5,54	15,7	5,89
		-7,0	-7,6	16,9	4,75	16,8	5,07	16,7	5,39	16,7	5,56	16,7	5,72	16,6	6,04
		-5,0	-5,6	18,1	5,02	18,0	5,31	18,0	5,60	18,0	5,75	17,9	5,89	17,9	6,19
		-3,0	-3,7	19,3	5,21	19,2	5,47	19,2	5,74	19,1	5,87	19,1	6,00	19,1	6,27
		0,0	-0,7	21,1	5,39	21,1	5,62	21,0	5,85	21,0	5,97	21,0	6,08	20,9	6,31
		3,0	2,2	23,0	5,47	22,9	5,67	22,8	5,87	22,8	5,98	22,8	6,08	22,7	6,28
		5,0	4,1	24,1	5,48	24,1	5,67	24,0	5,85	24,0	5,94	24,0	6,04	23,9	6,22
		7,0	6,0	25,3	5,46	25,3	5,63	25,2	5,80	25,2	5,89	25,1	5,98	25,1	6,15
		9,0	7,9	26,5	5,42	26,4	5,58	26,4	5,74	26,4	5,82	26,3	5,90	26,3	6,05
		11,0	9,8	27,7	5,36	27,6	5,51	27,6	5,65	27,5	5,72	27,5	5,80	27,5	5,94
13,0	11,8	28,9	5,27	28,9	5,41	28,8	5,54	28,8	5,61	28,8	5,68	28,3	5,72		
15,0	13,7	30,1	5,18	30,1	5,30	30,0	5,43	30,0	5,49	29,9	5,55	28,3	5,31		
120	26,88 kW	-19,8	-20,0	9,1	0,24	9,0	0,92	9,0	1,61	8,9	1,95	8,9	2,29	8,8	2,97
		-18,8	-19,0	9,7	1,08	9,6	1,71	9,6	2,33	9,5	2,64	9,5	2,96	9,5	3,58
		-16,7	-17,0	10,9	2,39	10,9	2,93	10,8	3,46	10,8	3,73	10,8	3,99	10,7	4,53
		-13,7	-15,0	12,2	3,35	12,1	3,81	12,1	4,27	12,0	4,51	12,0	4,74	12,0	5,20
		-11,8	-13,0	13,4	4,05	13,4	4,46	13,3	4,87	13,3	5,07	13,3	5,28	13,2	5,68
		-9,8	-11,0	14,7	4,58	14,6	4,94	14,6	5,30	14,5	5,48	14,5	5,66	14,4	6,03
		-9,5	-10,0	15,3	4,79	15,2	5,13	15,2	5,47	15,2	5,64	15,1	5,81	15,1	6,15
		-8,5	-9,1	15,8	4,96	15,8	5,28	15,7	5,60	15,7	5,77	15,7	5,93	15,6	6,25
		-7,0	-7,6	16,8	5,18	16,7	5,48	16,7	5,78	16,6	5,93	16,6	6,08	16,6	6,38
		-5,0	-5,6	18,0	5,41	18,0	5,68	17,9	5,95	17,9	6,09	17,9	6,22	17,8	6,49
		-3,0	-3,7	19,2	5,56	19,2	5,81	19,1	6,05	19,1	6,18	19,0	6,30	19,0	6,54
		0,0	-0,7	21,1	5,70	21,0	5,91	21,0	6,13	20,9	6,23	20,9	6,34	20,9	6,55
		3,0	2,2	22,9	5,74	22,8	5,93	22,8	6,12	22,7	6,21	22,7	6,30	22,7	6,49
		5,0	4,1	24,1	5,73	24,0	5,90	24,0	6,07	23,9	6,16	23,9	6,25	23,8	6,42
		7,0	6,0	25,2	5,69	25,2	5,85	25,1	6,01	25,1	6,09	25,1	6,17	25,0	6,33
		9,0	7,9	26,4	5,63	26,4	5,78	26,3	5,93	26,3	6,00	26,3	6,07	26,1	6,20
		11,0	9,8	27,6	5,56	27,6	5,69	27,5	5,83	27,5	5,89	27,4	5,96	26,1	5,75
13,0	11,8	28,9	5,46	28,8	5,58	28,7	5,70	28,7	5,77	28,1	5,67	26,1	5,31		
15,0	13,7	30,0	5,35	30,0	5,46	29,9	5,58	29,0	5,43	28,1	5,26	26,1	4,93		
110	24,64 kW	-19,8	-20,0	9,0	1,24	8,9	1,86	8,9	2,49	8,9	2,80	8,8	3,11	8,8	3,74
		-18,8	-19,0	9,6	2,00	9,6	2,57	9,5	3,14	9,5	3,43	9,5	3,72	9,4	4,29
		-16,7	-17,0	10,8	3,17	10,8	3,66	10,8	4,15	10,7	4,40	10,7	4,64	10,7	5,13
		-13,7	-15,0	12,1	4,03	12,0	4,45	12,0	4,88	12,0	5,09	11,9	5,30	11,9	5,73
		-11,8	-13,0	13,3	4,65	13,3	5,02	13,2	5,40	13,2	5,58	13,2	5,77	13,1	6,14
		-9,8	-11,0	14,6	5,11	14,5	5,44	14,5	5,77	14,5	5,94	14,4	6,10	14,4	6,43
		-9,5	-10,0	15,2	5,29	15,2	5,60	15,1	5,92	15,1	6,07	15,1	6,23	15,0	6,54
		-8,5	-9,1	15,8	5,43	15,7	5,73	15,7	6,02	15,6	6,17	15,6	6,32	15,6	6,62
		-7,0	-7,6	16,7	5,62	16,7	5,90	16,6	6,17	16,6	6,31	16,6	6,44	16,5	6,72
		-5,0	-5,6	17,9	5,81	17,9	6,05	17,8	6,30	17,8	6,42	17,8	6,55	17,8	6,79
		-3,0	-3,7	19,1	5,92	19,1	6,15	19,0	6,37	19,0	6,48	19,0	6,60	18,9	6,82
		0,0	-0,7	21,0	6,01	20,9	6,21	20,9	6,40	20,9	6,50	20,8	6,60	20,8	6,79
		3,0	2,2	22,8	6,02	22,8	6,19	22,7	6,36	22,7	6,44	22,7	6,53	22,6	6,70
		5,0	4,1	24,0	5,98	23,9	6,14	23,9	6,30	23,9	6,38	23,8	6,45	23,8	6,61
		7,0	6,0	25,2	5,93	25,1	6,07	25,1	6,21	25,0	6,29	25,0	6,36	24,0	6,18
		9,0	7,9	26,3	5,85	26,3	5,98	26,3	6,12	26,2	6,18	26,2	6,25	26,1	6,42
		11,0	9,8	27,5	5,75	27,5	5,88	27,4	6,00	26,6	5,84	26,6	5,91	26,5	6,15
13,0	11,8	28,8	5,64	28,7	5,75	28,7	5,86	28,6	5,93	28,5	6,00	28,4	6,23		
15,0	13,7	30,0	5,51	29,3	5,47	27,5	5,16	26,6	5,01	25,7	4,85	24,0	4,53		
100	22,40 kW	-19,8	-20,0	8,9	2,24	8,9	2,81	8,8	3,37	8,8	3,66	8,8	3,94	8,7	4,51
		-18,8	-19,0	9,5	2,91	9,5	3,43	9,4	3,96	9,4	4,22	9,4	4,48	9,4	5,00
		-16,7	-17,0	10,8	3,96	10,7	4,40	10,7	4,85	10,7	5,07	10,6	5,29	10,6	5,74
		-13,7	-15,0	12,0	4,70	12,0	5,09	11,9	5,48	11,9	5,67	11,9	5,86	11,8	6,25
		-11,8	-13,0	13,3	5,25	13,2	5,59	13,2	5,93	13,2	6,09	13,1	6,26	13,1	6,60
		-9,8	-11,0	14,5	5,64	14,5	5,94	14,4	6,24	14,4	6,39	14,4	6,54	14,3	6,84
		-9,5	-10,0	15,1	5,79	15,1	6,07	15,0	6,36	15,0	6,50	15,0	6,64	15,0	6,92
		-8,5	-9,1	15,7	5,90	15,6	6,17	15,6	6,44	15,6	6,58	15,6	6,71	15,5	6,98
		-7,0	-7,6	16,6	6,06	16,6	6,31	16,5	6,56	16,5	6,68	16,5	6,81	16,4	7,05
		-5,0	-5,6	17,9	6,20	17,8	6,43	17,8	6,65	17,8	6,76	17,7	6,87	17,7	7,10
		-3,0	-3,7	19,0	6,28	19,0	6,49	19,0	6,69	18,9	6,79	18,9	6,89	18,9	7,10
		0,0	-0,7	20,9	6,32	20,9	6,50	20,8	6,68	20,8	6,77	20,8	6,86	20,7	7,03
		3,0	2,2	22,7	6,29	22,7	6,44	22,6	6,60	22,6	6,68	22,6	6,75	21,8	6,62
		5,0	4,1	23,9	6,23	23,9	6,38	23,8	6,52	23,8	6,59	23,4	6,53	21,8	6,12
		7,0	6,0	25,1	6,16	25,0	6,29	25,0	6,42	24,2	6,23	23,4	6,04	21,8	5,65
		9,0	7,9	26,3	6,06	26,2	6,18	25,0	6,05	24,2	5,77	23,4	5,60	21,8	5,23
		11,0	9,8	27,5	5,95	26,6	5,84	25,0	5,52	24,2	5,35	23,4	5,18	21,8	4,84
13,0	11,8	28,2	5,70	26,6	5,40	25,0	5,09	24,2	4,94	23,4	4,78	21,8	4,46		
15,0	13,7	28,2	5,29	26,6	5,01	25,0	4,72	24,2	4,57	23,4	4,43	21,8	4,13		

**NOTES - ANMERKUNGEN - Σημειώσεις - NOTAS - REMARQUES - NOTE - OPMERKINGEN - Примечания - NOTLAR**

- is shown as reference. When selecting the unit models, avoid the Outdoor air temperature range shown by
- dient als Verweis. Vermeiden Sie bei der Auswahl der Gerätemodelle den als markierten Temperaturbereich der Außenluft
- Η είναι ενδεικτική, κατά την επιλογή των μοντέλων των μονάδων, αποφύγετε το εύρος θερμοκρασίας εξωτερικού αέρα που υποδεικνύεται
- se muestra como referencia. Cuando seleccione los modelos de unidad, evite el intervalo de temperaturas del aire exterior indicado mediante
- est montré comme référence. Lors du choix des modèles d'unités, évitez la plage de températures de l'air extérieur illustré par
- valori riportati unicamente come riferimento. Nel selezionare i modelli delle unità, non considerare i valori di temperatura dell'aria esterna indicati con il colore
- is als referentie getoond. Wanneer modellen van eenheden worden gekozen, vermijd dan het bereik van buitenluchttemperaturen geïllustreerd door
- показан как. При выборе модели устройства избегайте внешнюю температуру

воздуха, указанную в  
referans olarak gösterilmektedir. Ünite modellerini seçerken, belirtilen Dış hava sıcaklığı aralığından kaçınm

The above table shows the average value of conditions which may occur.  
Die obige Tabelle zeigt den Durchschnittswert der Bedingungen, die auftreten können.  
Στον παραπάνω πίνακα αναγράφεται η μέση τιμή για συνθήκες που μπορεί να προκύψουν.  
La tabla de arriba muestra el valor medio de condiciones que pueden ocurrir.  
Le tableau ci-dessus donne la valeur moyenne pour des conditions qui peuvent survenir.  
La tabella in alto mostra il valore delle condizioni medie che si possono riscontrare.  
De tabel hierboven geeft de gemiddelde waarde aan van situaties die kunnen voorvallen.  
Таблица расположенная выше показывает среднее значение условий, которые могут наступить.  
Yukarıdaki tablo meydana gelebilecek koşulların ortalama değerini göstermektedir.

# 5 Capacity tables

## 5 - 2 Heating Capacity Tables

5

RQYQ8PY1		TC: Total Capacity: kW ; PI: Power Input: kW (compressor + outdoor fan motor)													
Combination (%)	Capacity index (kW)	Outdoor air temp.		Indoor air temperature: °CDB											
				16.0		18.0		20.0		21.0		22.0		24.0	
				TC	PI	TC	PI	TC	PI	TC	PI	TC	PI	TC	PI
		°CDB	°CWB												
90%	20,16 kW	-19,8	-20,0	8,8	3,24	8,8	3,75	8,7	4,26	8,7	4,51	8,7	4,77	8,7	5,28
		-18,8	-19,0	9,4	3,83	9,4	4,30	9,4	4,77	9,3	5,00	9,3	5,24	9,3	5,71
		-16,7	-17,0	10,7	4,74	10,7	5,14	10,6	5,54	10,6	5,74	10,6	5,94	10,5	6,34
		-13,7	-15,0	11,9	5,38	11,9	5,73	11,9	6,08	11,8	6,25	11,8	6,43	11,8	6,78
		-11,8	-13,0	13,2	5,84	13,1	6,15	13,1	6,45	13,1	6,61	13,1	6,76	13,0	7,06
		-9,8	-11,0	14,4	6,17	14,4	6,44	14,3	6,71	14,3	6,84	14,3	6,98	14,3	7,25
		-9,5	-10,0	15,1	6,29	15,0	6,54	15,0	6,80	15,0	6,93	14,9	7,05	14,9	7,31
		-8,5	-9,1	15,6	6,38	15,6	6,62	15,5	6,86	15,5	6,99	15,5	7,11	15,5	7,35
		-7,0	-7,6	16,5	6,50	16,5	6,72	16,5	6,94	16,4	7,06	16,4	7,17	16,4	7,39
		-5,0	-5,6	17,8	6,59	17,8	6,80	17,7	7,00	17,7	7,10	17,7	7,20	17,6	7,40
		-3,0	-3,7	19,0	6,64	18,9	6,82	18,9	7,01	18,9	7,10	18,9	7,19	18,8	7,37
		0,0	-0,7	20,8	6,64	20,8	6,79	20,8	6,95	20,7	7,03	20,7	7,11	19,6	6,80
		3,0	2,2	22,6	6,56	22,6	6,70	22,5	6,82	21,8	6,62	21,1	6,42	19,6	6,00
		5,0	4,1	23,8	6,48	23,8	6,61	22,5	6,30	21,8	6,11	21,1	5,92	19,6	5,54
		7,0	6,0	25,0	6,39	23,9	6,17	22,5	5,83	21,8	5,65	21,1	5,47	19,6	5,11
		9,0	7,9	25,4	6,04	23,9	5,72	22,5	5,39	21,8	5,23	21,1	5,06	19,6	4,72
		11,0	9,8	25,4	5,60	23,9	5,30	22,5	4,99	21,8	4,84	21,1	4,68	19,6	4,36
		13,0	11,8	25,4	5,17	23,9	4,89	22,5	4,60	21,8	4,46	21,1	4,31	19,6	4,01
		15,0	13,7	25,4	4,79	23,9	4,53	22,5	4,26	21,8	4,12	21,1	3,99	19,6	3,71
		80%	17,92 kW	-19,8	-20,0	8,7	4,23	8,7	4,69	8,7	5,14	8,7	5,37	8,6	5,60
-18,8	-19,0			9,4	4,74	9,3	5,16	9,3	5,58	9,3	5,79	9,3	6,00	9,2	6,41
-16,7	-17,0			10,6	5,52	10,6	5,88	10,5	6,23	10,5	6,41	10,5	6,59	10,5	6,95
-13,7	-15,0			11,9	6,06	11,8	6,37	11,8	6,68	11,8	6,84	11,8	6,99	11,7	7,30
-11,8	-13,0			13,1	6,44	13,1	6,71	13,0	6,98	13,0	7,12	13,0	7,25	13,0	7,52
-9,8	-11,0			14,4	6,69	14,3	6,93	14,3	7,17	14,3	7,30	14,2	7,42	14,2	7,66
-9,5	-10,0			15,0	6,79	14,9	7,01	14,9	7,24	14,9	7,35	14,9	7,47	14,8	7,69
-8,5	-9,1			15,5	6,85	15,5	7,07	15,5	7,28	15,4	7,39	15,4	7,50	15,4	7,72
-7,0	-7,6			16,5	6,93	16,4	7,13	16,4	7,33	16,4	7,43	16,4	7,53	16,3	7,73
-5,0	-5,6			17,7	6,99	17,7	7,17	17,6	7,35	17,6	7,44	17,6	7,53	17,4	7,63
-3,0	-3,7			18,9	7,00	18,9	7,16	18,8	7,33	18,8	7,41	18,7	7,45	17,4	6,98
0,0	-0,7			20,8	6,95	20,7	7,09	20,0	6,93	19,4	6,72	18,7	6,52	17,4	6,09
3,0	2,2			22,6	6,83	21,3	6,48	20,0	6,12	19,4	5,93	18,7	5,74	17,4	5,36
5,0	4,1			22,6	6,32	21,3	5,98	20,0	5,64	19,4	5,47	18,7	5,29	17,4	4,93
7,0	6,0			22,6	5,85	21,3	5,53	20,0	5,21	19,4	5,05	18,7	4,88	17,4	4,55
9,0	7,9			22,6	5,41	21,3	5,11	20,0	4,81	19,4	4,66	18,7	4,51	17,4	4,19
11,0	9,8			22,6	5,01	21,3	4,73	20,0	4,45	19,4	4,30	18,7	4,16	17,4	3,87
13,0	11,8			22,6	4,62	21,3	4,36	20,0	4,09	19,4	3,96	18,7	3,83	17,4	3,55
15,0	13,7			22,6	4,27	21,3	4,03	20,0	3,78	19,4	3,66	18,7	3,53	17,4	3,28
70%	15,68 kW			-19,8	-20,0	8,7	5,23	8,6	5,63	8,6	6,03	8,6	6,22	8,6	6,42
		-18,8	-19,0	9,3	5,66	9,3	6,02	9,2	6,39	9,2	6,57	9,2	6,75	9,2	7,12
		-16,7	-17,0	10,5	6,30	10,5	6,62	10,5	6,93	10,5	7,08	10,4	7,24	10,4	7,55
		-13,7	-15,0	11,8	6,74	11,8	7,01	11,7	7,28	11,7	7,42	11,7	7,55	11,7	7,82
		-11,8	-13,0	13,0	7,03	13,0	7,27	13,0	7,51	13,0	7,63	12,9	7,75	12,9	7,98
		-9,8	-11,0	14,3	7,22	14,2	7,43	14,2	7,64	14,2	7,75	14,2	7,85	14,2	8,06
		-9,5	-10,0	14,9	7,28	14,9	7,48	14,8	7,68	14,8	7,78	14,8	7,88	14,8	8,08
		-8,5	-9,1	15,5	7,33	15,4	7,52	15,4	7,70	15,4	7,80	15,4	7,89	15,3	8,03
		-7,0	-7,6	16,4	7,37	16,4	7,54	16,3	7,72	16,3	7,80	16,3	7,89	15,3	7,44
		-5,0	-5,6	17,6	7,38	17,6	7,54	17,5	7,66	16,9	7,43	16,4	7,21	15,3	6,74
		-3,0	-3,7	18,8	7,36	18,6	7,42	17,5	7,01	16,9	6,80	16,4	6,59	15,3	6,15
		0,0	-0,7	19,7	6,85	18,6	6,49	17,5	6,12	16,9	5,93	16,4	5,74	15,3	5,35
		3,0	2,2	19,7	6,04	18,6	5,72	17,5	5,38	16,9	5,21	16,4	5,04	15,3	4,69
		5,0	4,1	19,7	5,57	18,6	5,27	17,5	4,95	16,9	4,79	16,4	4,63	15,3	4,31
		7,0	6,0	19,7	5,15	18,6	4,86	17,5	4,56	16,9	4,42	16,4	4,27	15,3	3,96
		9,0	7,9	19,7	4,75	18,6	4,48	17,5	4,21	16,9	4,07	16,4	3,93	15,3	3,65
		11,0	9,8	19,7	4,39	18,6	4,14	17,5	3,88	16,9	3,75	16,4	3,62	15,3	3,36
		13,0	11,8	19,7	4,04	18,6	3,81	17,5	3,57	16,9	3,45	16,4	3,32	15,3	3,08
		15,0	13,7	19,7	3,74	18,6	3,52	17,5	3,29	16,9	3,18	16,4	3,07	15,3	2,84
		60%	13,44 kW	-19,8	-20,0	8,6	6,23	8,6	6,57	8,5	6,91	8,5	7,08	8,5	7,25
-18,8	-19,0			9,2	6,58	9,2	6,89	9,2	7,20	9,2	7,36	9,1	7,51	9,1	7,83
-16,7	-17,0			10,5	7,09	10,4	7,35	10,4	7,62	10,4	7,75	10,4	7,89	10,4	8,16
-13,7	-15,0			11,7	7,42	11,7	7,65	11,7	7,88	11,6	8,00	11,6	8,12	11,6	8,35
-11,8	-13,0			13,0	7,63	12,9	7,83	12,9	8,04	12,9	8,14	12,9	8,24	12,8	8,44
-9,8	-11,0			14,2	7,75	14,2	7,93	14,1	8,11	14,1	8,20	14,0	8,23	13,1	7,71
-9,5	-10,0			14,8	7,78	14,8	7,95	14,8	8,12	14,5	8,05	14,0	7,80	13,1	7,30
-8,5	-9,1			15,4	7,80	15,4	7,96	15,0	7,91	14,5	7,68	14,0	7,44	13,1	6,96
-7,0	-7,6			16,3	7,81	16,0	7,76	15,0	7,33	14,5	7,11	14,0	6,89	13,1	6,43
-5,0	-5,6			16,9	7,43	16,0	7,04	15,0	6,64	14,5	6,43	14,0	6,23	13,1	5,81
-3,0	-3,7			16,9	6,80	16,0	6,43	15,0	6,06	14,5	5,87	14,0	5,67	13,1	5,28
0,0	-0,7			16,9	5,92	16,0	5,60	15,0	5,26	14,5	5,09	14,0	4,92	13,1	4,57
3,0	2,2			16,9	5,21	16,0	4,91	15,0	4,61	14,5	4,46	14,0	4,30	13,1	3,99
5,0	4,1			16,9	4,79	16,0	4,52	15,0	4,23	14,5	4,09	14,0	3,95	13,1	3,66
7,0	6,0			16,9	4,41	16,0	4,16	15,0	3,89	14,5	3,76	14,0	3,63	13,1	3,36
9,0	7,9			16,9	4,07	16,0	3,83	15,0	3,58	14,5	3,46	14,0	3,33	13,1	3,08
11,0	9,8			16,9	3,75	16,0	3,53	15,0	3,30	14,5	3,18	14,0	3,07	13,1	2,83
13,0	11,8			16,9	3,44	16,0	3,24	15,0	3,02	14,5	2,92	14,0	2,81	13,1	2,59
15,0	13,7			16,9	3,18	16,0	2,98	15,0	2,78	14,5	2,68	14,0	2,58	13,1	2,38
50%	11,20 kW			-19,8	-20,0	8,5	7,23	8,5	7,51	8,5	7,79	8,5	7,94	8,5	8,08
		-18,8	-19,0	9,1	7,49	9,1	7,75	9,1	8,01	9,1	8,14	9,1	8,27	9,1	8,53
		-16,7	-17,0	10,4	7,87	10,4	8,09	10,3	8,31	10,3	8,43	10,3	8,54	10,3	8,76
		-13,7	-15,0	11,6	8,10	11,6	8,29	11,6	8,49	11,6	8,58	11,6	8,68	10,9	8,25
		-11,8	-13,0	12,9	8,23	12,9	8,40	12,5	8,29	12,1	8,05	11,7	7,80	10,9	7,29
		-9,8	-11,0	14,1	8,27	13,3	7,84	12,5	7,40	12,1	7,17	11,7	6,95	10,9	6,48
		-9,5	-10,0	14,1	7,84	13,3	7,42	12,5	7,00	12,1	6,78	11,7	6,57	10,9	6,12
		-8,5	-9,1	14,1	7,47	13,3	7,08	12,5	6,67	12,1	6,46	11,7	6,25	10,9	5,82
		-7,0	-7,6	14,1	6,92	13,3	6,54	12,5	6,16	12,1	5,96	11,7	5,76	10,9	5,36
		-5,0	-5,6	14,1	6,26	13,3	5,91	12,5	5,55	12,1	5,37	11,7	5,19	10,9	4,82
		-3,0	-3,7	14,1	5,70	13,3	5,38	12,5	5,05	12,1	4,88	11,7	4,71	10,9	4,37
		0,0	-0,7	14,1	4,95	13,3	4,66	12,5	4,36	12,1	4,21	11,7	4,07	10,9	3,76
		3,0	2,2	14,1	4,33	13,3	4,								

# 5 Capacity tables

## 5 - 2 Heating Capacity Tables

RQYQ10PY1		TC: Total Capacity: kW ; PI: Power Input: kW (compressor + outdoor fan motor)													
Combination (%)	Capacity index (kW)	Outdoor air temp.		Indoor air temperature: °CDB											
				16.0		18.0		20.0		21.0		22.0		24.0	
				TC	PI	TC	PI	TC	PI	TC	PI	TC	PI	TC	PI
130	36,40 kW	-19,8	-20,0	18,6	5,18	18,5	5,67	18,4	6,16	18,4	6,41	18,4	6,66	18,3	7,15
		-18,8	-19,0	19,1	5,41	19,0	5,88	19,0	6,36	18,9	6,60	18,9	6,83	18,8	7,31
		-16,7	-17,0	20,2	5,82	20,1	6,26	20,1	6,70	20,0	6,93	20,0	7,15	19,9	7,59
		-13,7	-15,0	21,3	6,17	21,2	6,58	21,2	7,00	21,1	7,20	21,1	7,41	21,0	7,82
		-11,8	-13,0	22,4	6,46	22,3	6,85	22,3	7,24	22,2	7,43	22,2	7,63	22,1	8,01
		-9,8	-11,0	23,5	6,71	23,4	7,08	23,3	7,44	23,3	7,62	23,3	7,80	23,2	8,17
		-9,5	-10,0	24,0	6,82	24,0	7,18	23,9	7,53	23,9	7,71	23,8	7,88	23,7	8,23
		-8,5	-9,1	24,5	6,92	24,5	7,26	24,4	7,60	24,3	7,77	24,3	7,95	24,2	8,29
		-7,0	-7,6	25,3	7,05	25,3	7,38	25,2	7,71	25,2	7,87	25,1	8,04	25,1	8,37
		-5,0	-5,6	26,4	7,21	26,4	7,52	26,3	7,83	26,3	7,99	26,2	8,14	26,2	8,45
		-3,0	-3,7	27,5	7,33	27,4	7,63	27,3	7,92	27,3	8,07	27,3	8,22	27,2	8,51
		0,0	-0,7	29,1	7,49	29,0	7,76	29,0	8,03	28,9	8,17	28,9	8,30	28,8	8,57
		3,0	2,2	30,7	7,59	30,6	7,85	30,6	8,10	30,5	8,22	30,5	8,35	30,4	8,60
		5,0	4,1	31,7	7,65	31,7	7,89	31,6	8,13	31,6	8,25	31,5	8,37	31,5	8,61
		7,0	6,0	32,8	7,68	32,7	7,91	32,6	8,14	32,6	8,25	32,6	8,37	32,5	8,60
		9,0	7,9	33,8	7,71	33,7	7,93	33,7	8,14	33,6	8,25	33,6	8,36	33,5	8,58
		11,0	9,8	34,9	7,72	34,8	7,93	34,7	8,14	34,7	8,24	34,6	8,35	34,6	8,56
13,0	11,8	35,9	7,72	35,9	7,92	35,8	8,12	35,8	8,22	35,7	8,32	35,7	8,52		
15,0	13,7	37,0	7,72	36,9	7,91	36,8	8,10	36,8	8,19	36,8	8,29	36,7	8,12		
120	33,60 kW	-19,8	-20,0	18,5	5,84	18,4	6,30	18,3	6,75	18,3	6,98	18,3	7,21	18,2	7,66
		-18,8	-19,0	19,0	6,05	19,0	6,49	18,9	6,93	18,9	7,15	18,8	7,37	18,8	7,81
		-16,7	-17,0	20,1	6,42	20,0	6,83	20,0	7,23	19,9	7,44	19,9	7,64	19,8	8,05
		-13,7	-15,0	21,2	6,73	21,1	7,11	21,1	7,49	21,0	7,68	21,0	7,87	20,9	8,25
		-11,8	-13,0	22,3	6,99	22,2	7,34	22,2	7,70	22,1	7,88	22,1	8,06	22,0	8,42
		-9,8	-11,0	23,4	7,21	23,3	7,54	23,3	7,88	23,2	8,04	23,2	8,21	23,1	8,55
		-9,5	-10,0	23,9	7,30	23,9	7,63	23,8	7,95	23,8	8,11	23,7	8,28	23,7	8,60
		-8,5	-9,1	24,4	7,38	24,4	7,70	24,3	8,01	24,3	8,17	24,2	8,33	24,2	8,65
		-7,0	-7,6	25,3	7,50	25,2	7,80	25,1	8,10	25,1	8,25	25,1	8,41	25,0	8,71
		-5,0	-5,6	26,3	7,63	26,3	7,92	26,2	8,20	26,2	8,34	26,1	8,49	26,1	8,77
		-3,0	-3,7	27,4	7,73	27,3	8,00	27,2	8,28	27,2	8,41	27,2	8,55	27,1	8,82
		0,0	-0,7	29,0	7,86	29,0	8,11	28,9	8,36	28,9	8,48	28,8	8,61	28,8	8,86
		3,0	2,2	30,6	7,94	30,5	8,17	30,5	8,40	30,4	8,52	30,4	8,63	30,3	8,86
		5,0	4,1	31,6	7,97	31,6	8,19	31,5	8,41	31,5	8,52	31,4	8,63	31,4	8,86
		7,0	6,0	32,7	7,99	32,6	8,20	32,5	8,41	32,5	8,52	32,5	8,63	32,4	8,84
		9,0	7,9	33,7	8,00	33,7	8,20	33,6	8,41	33,6	8,51	33,5	8,61	33,5	8,86
		11,0	9,8	34,8	8,00	34,7	8,20	34,6	8,39	34,6	8,49	34,6	8,58	34,5	8,86
13,0	11,8	35,8	7,99	35,8	8,18	35,7	8,36	35,7	8,45	35,4	8,44	35,4	8,77		
15,0	13,7	36,9	7,97	36,8	8,15	36,8	8,33	36,6	8,37	35,4	8,04	35,4	7,39		
110	30,80 kW	-19,8	-20,0	18,4	6,51	18,3	6,93	18,3	7,34	18,2	7,55	18,2	7,76	18,1	8,18
		-18,8	-19,0	18,9	6,69	18,9	7,09	18,8	7,50	18,8	7,70	18,7	7,90	18,7	8,30
		-16,7	-17,0	20,0	7,02	20,0	7,39	19,9	7,76	19,9	7,95	19,8	8,14	19,8	8,51
		-13,7	-15,0	21,1	7,29	21,0	7,63	21,0	7,98	21,0	8,16	20,9	8,33	20,9	8,68
		-11,8	-13,0	22,2	7,51	22,1	7,84	22,1	8,17	22,1	8,33	22,0	8,49	22,0	8,82
		-9,8	-11,0	23,3	7,70	23,2	8,00	23,2	8,31	23,1	8,47	23,1	8,62	23,1	8,93
		-9,5	-10,0	23,8	7,78	23,8	8,08	23,7	8,37	23,7	8,52	23,7	8,67	23,6	8,97
		-8,5	-9,1	24,3	7,84	24,3	8,13	24,2	8,42	24,2	8,57	24,2	8,71	24,1	9,00
		-7,0	-7,6	25,2	7,94	25,1	8,22	25,0	8,50	25,0	8,64	25,0	8,77	24,9	9,05
		-5,0	-5,6	26,2	8,05	26,2	8,31	26,1	8,57	26,1	8,70	26,1	8,84	26,0	9,10
		-3,0	-3,7	27,3	8,13	27,2	8,38	27,2	8,63	27,1	8,75	27,1	8,88	27,0	9,13
		0,0	-0,7	28,9	8,22	28,9	8,45	28,8	8,68	28,8	8,80	28,7	8,91	28,7	9,14
		3,0	2,2	30,5	8,28	30,4	8,49	30,4	8,70	30,4	8,81	30,3	8,91	30,2	9,10
		5,0	4,1	31,5	8,29	31,5	8,50	31,4	8,70	31,4	8,80	31,4	8,90	31,3	9,10
		7,0	6,0	32,6	8,30	32,5	8,49	32,5	8,69	32,4	8,79	32,4	8,88	32,3	8,87
		9,0	7,9	33,6	8,30	33,6	8,48	33,5	8,67	33,5	8,76	33,4	8,84	33,4	8,87
		11,0	9,8	34,7	8,29	34,6	8,46	34,5	8,64	34,5	8,73	34,4	8,82	34,4	8,87
13,0	11,8	35,8	8,26	35,7	8,43	35,7	8,63	35,6	8,72	35,5	8,81	35,5	8,87		
15,0	13,7	36,8	8,23	36,7	8,39	36,7	8,58	36,6	8,67	36,5	8,75	36,4	8,84		
100	28,00 kW	-19,8	-20,0	18,3	7,17	18,2	7,55	18,2	7,93	18,1	8,12	18,1	8,31	18,1	8,69
		-18,8	-19,0	18,8	7,33	18,8	7,70	18,7	8,07	18,7	8,25	18,7	8,43	18,6	8,80
		-16,7	-17,0	19,9	7,61	19,9	7,95	19,8	8,29	19,8	8,46	19,8	8,63	19,7	8,97
		-13,7	-15,0	21,0	7,84	21,0	8,16	20,9	8,48	20,9	8,64	20,8	8,80	20,8	9,12
		-11,8	-13,0	22,1	8,03	22,1	8,33	22,0	8,63	22,0	8,78	21,9	8,93	21,9	9,22
		-9,8	-11,0	23,2	8,19	23,1	8,47	23,1	8,75	23,1	8,89	23,0	9,03	23,0	9,31
		-9,5	-10,0	23,7	8,25	23,7	8,52	23,6	8,80	23,6	8,93	23,6	9,07	23,5	9,34
		-8,5	-9,1	24,2	8,31	24,2	8,57	24,1	8,83	24,1	8,97	24,1	9,10	24,0	9,36
		-7,0	-7,6	25,1	8,38	25,0	8,64	24,9	8,89	24,9	9,02	24,9	9,14	24,8	9,39
		-5,0	-5,6	26,1	8,47	26,1	8,71	26,0	8,94	26,0	9,06	26,0	9,18	25,9	9,42
		-3,0	-3,7	27,2	8,53	27,1	8,75	27,1	9,01	27,0	9,09	27,0	9,21	27,0	9,43
		0,0	-0,7	28,8	8,59	28,8	8,80	28,7	9,08	28,7	9,11	28,7	9,21	28,6	9,43
		3,0	2,2	30,4	8,62	30,4	8,81	30,3	9,00	30,3	9,10	30,3	9,21	30,2	9,43
		5,0	4,1	31,4	8,62	31,4	8,80	31,3	8,99	31,3	9,09	31,3	9,21	31,2	9,43
		7,0	6,0	32,5	8,61	32,4	8,79	32,4	8,98	32,3	9,08	32,3	9,20	32,2	9,43
		9,0	7,9	33,5	8,59	33,5	8,76	33,4	8,95	33,4	9,05	33,3	9,17	33,3	9,43
		11,0	9,8	34,6	8,57	34,5	8,74	34,5	8,93	34,4	9,02	34,4	9,14	34,3	9,43
13,0	11,8	35,5	8,49	35,5	8,66	35,4	8,90	35,4	9,01	35,3	9,13	35,2	9,43		
15,0	13,7	35,5	8,08	35,5	7,54	35,5	7,01	35,5	6,75	35,5	6,50	35,5	6,00		

**NOTES - ANMERKUNGEN - Σημειώσεις - NOTAS - REMARQUES - NOTE - OPMERKINGEN - Примечания - NOTLAR**

- is shown as reference. When selecting the unit models, avoid the Outdoor air temperature range shown by
- dient als Verweis. Vermeiden Sie bei der Auswahl der Gerätemodelle den als markierten Temperaturbereich der Außenluft
- Η είναι ενδεικτική, κατά την επιλογή των μοντέλων των μονάδων, αποφύγετε το εύρος θερμοκρασίας εξωτερικού αέρα που υποδεικνύεται
- se muestra como referencia. Cuando seleccione los modelos de unidad, evite el intervalo de temperaturas del aire exterior indicado mediante
- est montré comme référence. Lors du choix des modèles d'unités, évitez la plage de températures de l'air extérieur illustré par
- valori riportati unicamente come riferimento. Nel selezionare i modelli delle unità, non considerare i valori di temperatura dell'aria esterna indicati con il colore
- is als referentie getoond. Wanneer modellen van eenheden worden gekozen, vermijd dan het bereik van buitenluchttemperaturen geïllustreerd door
- показан как. При выборе модели устройства избегайте внешнюю температуру

воздуха, указанную в  
referans olarak gösterilmektedir. Ünite modellerini seçerken, belirtilen Dış hava sıcaklığı aralığından kaçınm

The above table shows the average value of conditions which may occur.  
Die obige Tabelle zeigt den Durchschnittswert der Bedingungen, die auftreten können.  
Στον παραπάνω πίνακα αναγράφεται η μέση τιμή για συνθήκες που μπορεί να προκύψουν.  
La tabla de arriba muestra el valor medio de condiciones que pueden ocurrir.  
Le tableau ci-dessus donne la valeur moyenne pour des conditions qui peuvent survenir.  
La tabella in alto mostra il valore delle condizioni medie che si possono riscontrare.  
De tabel hierboven geeft de gemiddelde waarde aan van situaties die kunnen voorvallen.  
Таблица расположенная выше показывает среднее значение условий, которые могут наступить.  
Yukarıdaki tablo meydana gelebilecek koşulların ortalama değerini göstermektedir.

# 5 Capacity tables

## 5 - 2 Heating Capacity Tables

5

RQYQ10PY1		TC: Total Capacity: kW ; PI: Power Input: kW (compressor + outdoor fan motor)													
Combination (%)	Capacity index (kW)	Outdoor air temp.		Indoor air temperature: °CDB											
				16.0		18.0		20.0		21.0		22.0		24.0	
				TC	PI	TC	PI	TC	PI	TC	PI	TC	PI	TC	PI
		°CDB	°CWB												
90%	25,20 kW	-19,8	-20,0	18,2	7,84	18,1	8,18	18,1	8,52	18,1	8,69	18,0	8,87	18,0	9,21
		-18,8	-19,0	18,7	7,98	18,7	8,31	18,6	8,63	18,6	8,80	18,6	8,96	18,5	9,29
		-16,7	-17,0	19,8	8,21	19,8	8,52	19,7	8,82	19,7	8,98	19,7	9,13	19,6	9,44
		-13,7	-15,0	20,9	8,40	20,9	8,69	20,8	8,97	20,8	9,12	20,8	9,26	20,7	9,55
		-11,8	-13,0	22,0	8,56	22,0	8,82	21,9	9,09	21,9	9,23	21,9	9,36	21,8	9,63
		-9,8	-11,0	23,1	8,68	23,1	8,93	23,0	9,18	23,0	9,31	23,0	9,43	22,9	9,69
		-9,5	-10,0	23,6	8,73	23,6	8,97	23,5	9,22	23,5	9,34	23,5	9,46	23,4	9,71
		-8,5	-9,1	24,1	8,77	24,1	9,01	24,0	9,25	24,0	9,36	24,0	9,48	23,9	9,72
		-7,0	-7,6	25,0	8,83	24,9	9,06	24,9	9,28	24,8	9,40	24,8	9,51	24,7	9,70
		-5,0	-5,6	26,1	8,89	26,0	9,10	26,0	9,32	25,9	9,42	25,9	9,53	24,7	9,09
		-3,0	-3,7	27,1	8,92	27,0	9,13	27,0	9,33	27,0	9,43	26,5	9,31	24,7	8,55
		0,0	-0,7	28,7	8,96	28,7	9,14	28,4	9,19	27,4	8,84	26,5	8,49	24,7	7,81
		3,0	2,2	30,3	8,96	30,2	9,09	28,4	8,44	27,4	8,12	26,5	7,80	24,7	7,19
		5,0	4,1	31,4	8,94	30,2	8,60	28,4	7,99	27,4	7,69	26,5	7,40	24,7	6,82
		7,0	6,0	32,0	8,75	30,2	8,16	28,4	7,59	27,4	7,30	26,5	7,03	24,7	6,48
		9,0	7,9	32,0	8,31	30,2	7,75	28,4	7,21	27,4	6,94	26,5	6,68	24,7	6,17
		11,0	9,8	32,0	7,90	30,2	7,37	28,4	6,86	27,4	6,61	26,5	6,36	24,7	5,88
		13,0	11,8	32,0	7,49	30,2	7,00	28,4	6,52	27,4	6,28	26,5	6,05	24,7	5,59
		15,0	13,7	32,0	7,14	30,2	6,67	28,4	6,22	27,4	5,99	26,5	5,77	24,7	5,34
		80%	22,40 kW	-19,8	-20,0	18,1	8,51	18,0	8,81	18,0	9,11	18,0	9,27	18,0	9,42
-18,8	-19,0			18,6	8,62	18,6	8,91	18,5	9,20	18,5	9,35	18,5	9,50	18,5	9,79
-16,7	-17,0			19,7	8,81	19,7	9,08	19,6	9,35	19,6	9,49	19,6	9,63	19,5	9,90
-13,7	-15,0			20,8	8,96	20,8	9,21	20,7	9,47	20,7	9,60	20,7	9,72	20,6	9,98
-11,8	-13,0			21,9	9,08	21,9	9,32	21,8	9,56	21,8	9,67	21,8	9,79	21,7	10,03
-9,8	-11,0			23,0	9,17	23,0	9,39	22,9	9,62	22,9	9,73	22,9	9,84	22,0	9,48
-9,5	-10,0			23,5	9,21	23,5	9,42	23,5	9,64	23,4	9,75	23,4	9,86	22,0	9,15
-8,5	-9,1			24,0	9,23	24,0	9,45	24,0	9,66	23,9	9,76	23,6	9,66	22,0	8,87
-7,0	-7,6			24,9	9,27	24,8	9,47	24,8	9,68	24,4	9,56	23,6	9,18	22,0	8,44
-5,0	-5,6			26,0	9,30	25,9	9,50	25,2	9,30	24,4	8,95	23,6	8,60	22,0	7,91
-3,0	-3,7			27,0	9,32	26,8	9,43	25,2	8,76	24,4	8,43	23,6	8,10	22,0	7,46
0,0	-0,7			28,4	9,22	26,8	8,60	25,2	7,99	24,4	7,70	23,6	7,40	22,0	6,83
3,0	2,2			28,4	8,47	26,8	7,90	25,2	7,35	24,4	7,08	23,6	6,82	22,0	6,30
5,0	4,1			28,4	8,02	26,8	7,49	25,2	6,98	24,4	6,72	23,6	6,47	22,0	5,98
7,0	6,0			28,4	7,61	26,8	7,11	25,2	6,63	24,4	6,39	23,6	6,15	22,0	5,69
9,0	7,9			28,4	7,23	26,8	6,76	25,2	6,31	24,4	6,08	23,6	5,86	22,0	5,42
11,0	9,8			28,4	6,88	26,8	6,44	25,2	6,01	24,4	5,79	23,6	5,58	22,0	5,17
13,0	11,8			28,4	6,54	26,8	6,12	25,2	5,71	24,4	5,51	23,6	5,31	22,0	4,92
15,0	13,7			28,4	6,24	26,8	5,84	25,2	5,46	24,4	5,26	23,6	5,08	22,0	4,71
70%	19,60 kW			-19,8	-20,0	18,0	9,17	18,0	9,44	17,9	9,70	17,9	9,84	17,9	9,97
		-18,8	-19,0	18,5	9,26	18,5	9,52	18,5	9,77	18,4	9,90	18,4	10,03	18,4	10,28
		-16,7	-17,0	19,6	9,41	19,6	9,64	19,6	9,88	19,5	10,00	19,5	10,12	19,2	10,15
		-13,7	-15,0	20,7	9,52	20,7	9,74	20,6	9,96	20,6	10,07	20,6	10,19	19,2	9,38
		-11,8	-13,0	21,8	9,60	21,8	9,81	21,7	10,02	21,3	9,85	20,6	9,46	19,2	8,70
		-9,8	-11,0	22,9	9,66	22,9	9,86	22,1	9,53	21,3	9,16	20,6	8,81	19,2	8,11
		-9,5	-10,0	23,5	9,68	23,4	9,87	22,1	9,20	21,3	8,85	20,6	8,51	19,2	7,83
		-8,5	-9,1	23,9	9,70	23,5	9,60	22,1	8,92	21,3	8,58	20,6	8,25	19,2	7,60
		-7,0	-7,6	24,8	9,72	23,5	9,13	22,1	8,48	21,3	8,16	20,6	7,85	19,2	7,24
		-5,0	-5,6	24,9	9,16	23,5	8,55	22,1	7,95	21,3	7,66	20,6	7,37	19,2	6,80
		-3,0	-3,7	24,9	8,63	23,5	8,05	22,1	7,50	21,3	7,22	20,6	6,95	19,2	6,42
		0,0	-0,7	24,9	7,88	23,5	7,36	22,1	6,86	21,3	6,61	20,6	6,37	19,2	5,89
		3,0	2,2	24,9	7,25	23,5	6,78	22,1	6,32	21,3	6,10	20,6	5,88	19,2	5,44
		5,0	4,1	24,9	6,88	23,5	6,44	22,1	6,01	21,3	5,80	20,6	5,59	19,2	5,18
		7,0	6,0	24,9	6,53	23,5	6,12	22,1	5,71	21,3	5,52	20,6	5,32	19,2	4,93
		9,0	7,9	24,9	6,22	23,5	5,83	22,1	5,44	21,3	5,26	20,6	5,07	19,2	4,70
		11,0	9,8	24,9	5,92	23,5	5,55	22,1	5,19	21,3	5,01	20,6	4,84	19,2	4,49
		13,0	11,8	24,9	5,64	23,5	5,29	22,1	4,95	21,3	4,78	20,6	4,61	19,2	4,28
		15,0	13,7	24,9	5,38	23,5	5,05	22,1	4,73	21,3	4,57	20,6	4,41	19,2	4,10
		60%	16,80 kW	-19,8	-20,0	17,9	9,84	17,9	10,07	17,8	10,29	17,8	10,41	17,7	10,42
-18,8	-19,0			18,4	9,90	18,4	10,12	18,4	10,34	18,3	10,40	17,7	9,98	16,5	9,18
-16,7	-17,0			19,5	10,00	19,5	10,21	18,9	9,95	18,3	9,57	17,7	9,20	16,5	8,46
-13,7	-15,0			20,6	10,08	20,1	9,90	18,9	9,20	18,3	8,85	17,7	8,51	16,5	7,84
-11,8	-13,0			21,3	9,85	20,1	9,18	18,9	8,54	18,3	8,22	17,7	7,91	16,5	7,30
-9,8	-11,0			21,3	9,16	20,1	8,55	18,9	7,95	18,3	7,66	17,7	7,38	16,5	6,81
-9,5	-10,0			21,3	8,84	20,1	8,26	18,9	7,69	18,3	7,41	17,7	7,13	16,5	6,59
-8,5	-9,1			21,3	8,58	20,1	8,01	18,9	7,46	18,3	7,19	17,7	6,92	16,5	6,40
-7,0	-7,6			21,3	8,16	20,1	7,63	18,9	7,11	18,3	6,85	17,7	6,60	16,5	6,11
-5,0	-5,6			21,3	7,65	20,1	7,16	18,9	6,68	18,3	6,44	17,7	6,21	16,5	5,75
-3,0	-3,7			21,3	7,22	20,1	6,76	18,9	6,31	18,3	6,08	17,7	5,87	16,5	5,44
0,0	-0,7			21,3	6,61	20,1	6,19	18,9	5,79	18,3	5,59	17,7	5,39	16,5	5,00
3,0	2,2			21,3	6,10	20,1	5,72	18,9	5,35	18,3	5,17	17,7	4,98	16,5	4,63
5,0	4,1			21,3	5,79	20,1	5,44	18,9	5,09	18,3	4,92	17,7	4,75	16,5	4,41
7,0	6,0			21,3	5,51	20,1	5,18	18,9	4,85	18,3	4,68	17,7	4,52	16,5	4,21
9,0	7,9			21,3	5,25	20,1	4,93	18,9	4,62	18,3	4,47	17,7	4,32	16,5	4,02
11,0	9,8			21,3	5,01	20,1	4,71	18,9	4,42	18,3	4,27	17,7	4,13	16,5	3,84
13,0	11,8			21,3	4,77	20,1	4,49	18,9	4,21	18,3	4,08	17,7	3,94	16,5	3,67
15,0	13,7			21,3	4,56	20,1	4,30	18,9	4,03	18,3	3,90	17,7	3,77	16,5	3,52
50%	14,00 kW			-19,8	-20,0	17,8	10,49	16,8	9,78	15,8	9,09	15,2	8,75	14,7	8,41
		-18,8	-19,0	17,8	10,04	16,8	9,37	15,8	8,71	15,2	8,39	14,7	8,07	13,7	7,45
		-16,7	-17,0	17,8	9,25	16,8	8,64	15,8	8,04	15,2	7,75	14,7	7,46	13,7	6,89
		-13,7	-15,0	17,8	8,56	16,8	8,00	15,8	7,45	15,2	7,19	14,7	6,92	13,7	6,40
		-11,8	-13,0	17,8	7,95	16,8	7,44	15,8	6,94	15,2	6,69	14,7	6,45	13,7	5,97
		-9,8	-11,0	17,8	7,42	16,8	6,95	15,8	6,48	15,2	6,26	14,7	6,03	13,7	5,59
		-9,5	-10,0	17,8	7,17	16,8	6,72	15,8	6,27	15,2	6,06	14,7	5,84	13,7	5,42
		-8,5	-9,1	17,8	6,96	16,8	6,52	15,8	6,10	15,2	5,89	14,7	5,68	13,7	5,27
		-7,0	-7,6	17,8	6,64	16,8	6,22	15,8	5,82	15,2	5,62	14,7	5,42	13,7	5,03
		-5,0	-5,6	17,8	6,24	16,8	5,85	15,8	5,48	15,2	5,29	14,7	5,11	13,7	4,75
		-3,0	-3,7	17,8	5,90	16,8	5,54	15,8	5,19	15,2	5,01	14,7	4,84	13,7	4,50
		0,0	-0,7	17,8	5,42	16,8	5,09	15							



# 5 Capacity tables

## 5 - 2 Heating Capacity Tables

### RQYQ12PY1

TC: Total Capacity: kW ; PI: Power Input: kW (compressor + outdoor fan motor)

Combination (%)	Capacity index (kW)	Outdoor air temp.		Indoor air temperature: °CDB											
				16.0		18.0		20.0		21.0		22.0		24.0	
				TC	PI	TC	PI	TC	PI	TC	PI	TC	PI	TC	PI
130	43,55 kW	-19,8	-20,0	15,8	1,28	15,7	1,97	15,7	2,66	15,6	3,01	15,6	3,35	15,5	4,05
		-18,8	-19,0	16,6	1,92	16,5	2,58	16,5	3,23	16,4	3,56	16,4	3,89	16,3	4,54
		-16,7	-17,0	18,2	3,03	18,1	3,62	18,1	4,21	18,0	4,51	18,0	4,80	17,9	5,39
		-13,7	-15,0	19,9	3,95	19,8	4,49	19,7	5,03	19,6	5,30	19,6	5,57	19,5	6,11
		-11,8	-13,0	21,5	4,73	21,4	5,22	21,3	5,72	21,3	5,97	21,2	6,21	21,2	6,71
		-9,8	-11,0	23,2	5,40	23,1	5,85	23,0	6,31	22,9	6,54	22,9	6,77	22,8	7,23
		-9,5	-10,0	24,0	5,70	23,9	6,14	23,8	6,58	23,8	6,80	23,7	7,02	23,7	7,46
		-8,5	-9,1	24,8	5,95	24,7	6,37	24,6	6,80	24,5	7,01	24,5	7,23	24,4	7,65
		-7,0	-7,6	26,0	6,34	25,9	6,74	25,9	7,15	25,8	7,35	25,8	7,55	25,7	7,95
		-5,0	-5,6	27,7	6,80	27,6	7,18	27,6	7,56	27,5	7,75	27,5	7,93	27,4	8,31
		-3,0	-3,7	29,4	7,19	29,3	7,55	29,2	7,90	29,2	8,08	29,1	8,26	29,0	8,62
		0,0	-0,7	32,0	7,73	31,9	8,06	31,8	8,38	31,8	8,55	31,7	8,71	31,6	9,03
		3,0	2,2	34,6	8,18	34,5	8,48	34,4	8,78	34,3	8,93	34,3	9,08	34,2	9,38
		5,0	4,1	36,3	8,44	36,2	8,73	36,1	9,01	36,0	9,15	36,0	9,30	35,9	9,58
		7,0	6,0	38,0	8,68	37,9	8,95	37,8	9,22	37,8	9,36	37,7	9,49	37,6	9,77
		9,0	7,9	39,7	8,90	39,6	9,16	39,5	9,42	39,5	9,55	39,5	9,68	39,4	9,94
		11,0	9,8	41,5	9,10	41,4	9,35	41,3	9,60	41,2	9,72	41,2	9,85	41,1	10,09
13,0	11,8	43,3	9,30	43,2	9,53	43,2	9,77	43,1	9,89	43,1	10,01	42,5	10,10		
15,0	13,7	45,1	9,47	45,0	9,70	44,9	9,92	44,9	10,04	44,8	10,15	42,5	9,72		
120	40,20 kW	-19,8	-20,0	15,7	2,22	15,6	2,85	15,6	3,49	15,5	3,81	15,5	4,13	15,4	4,77
		-18,8	-19,0	16,5	2,81	16,4	3,41	16,3	4,01	16,3	4,32	16,3	4,62	16,2	5,22
		-16,7	-17,0	18,1	3,83	18,0	4,37	18,0	4,92	17,9	5,19	17,9	5,47	17,8	6,01
		-13,7	-15,0	19,7	4,68	19,7	5,18	19,6	5,67	19,5	5,92	19,5	6,17	19,4	6,67
		-11,8	-13,0	21,4	5,40	21,3	5,85	21,2	6,31	21,2	6,54	21,1	6,77	21,1	7,23
		-9,8	-11,0	23,0	6,01	23,0	6,44	22,9	6,86	22,8	7,07	22,8	7,28	22,7	7,70
		-9,5	-10,0	23,9	6,29	23,8	6,70	23,7	7,10	23,7	7,31	23,6	7,51	23,6	7,92
		-8,5	-9,1	24,6	6,52	24,6	6,92	24,5	7,31	24,4	7,51	24,4	7,70	24,3	8,10
		-7,0	-7,6	25,9	6,88	25,8	7,26	25,7	7,63	25,7	7,82	25,7	8,00	25,6	8,38
		-5,0	-5,6	27,6	7,31	27,5	7,66	27,5	8,01	27,4	8,18	27,4	8,36	27,3	8,71
		-3,0	-3,7	29,3	7,67	29,2	8,00	29,1	8,33	29,1	8,49	29,0	8,66	28,9	8,99
		0,0	-0,7	31,9	8,17	31,8	8,47	31,7	8,77	31,7	8,92	31,6	9,07	31,6	9,37
		3,0	2,2	34,4	8,59	34,4	8,86	34,3	9,14	34,2	9,28	34,2	9,42	34,1	9,69
		5,0	4,1	36,1	8,83	36,1	9,09	36,0	9,35	35,9	9,48	35,9	9,62	35,8	9,88
		7,0	6,0	37,9	9,05	37,8	9,30	37,7	9,55	37,7	9,67	37,6	9,80	37,5	10,05
		9,0	7,9	39,6	9,25	39,5	9,49	39,4	9,73	39,4	9,85	39,4	9,97	39,2	10,19
		11,0	9,8	41,3	9,44	41,3	9,66	41,2	9,89	41,1	10,01	41,1	10,12	39,2	9,78
13,0	11,8	43,2	9,62	43,1	9,84	43,0	10,06	43,0	10,16	42,1	10,02	39,2	9,38		
15,0	13,7	45,0	9,78	44,9	9,99	44,8	10,20	43,6	9,95	42,1	9,64	39,2	9,03		
110	36,85 kW	-19,8	-20,0	15,6	3,15	15,5	3,73	15,4	4,32	15,4	4,61	15,4	4,90	15,3	5,49
		-18,8	-19,0	16,4	3,69	16,3	4,24	16,2	4,80	16,2	5,07	16,2	5,35	16,1	5,91
		-16,7	-17,0	18,0	4,63	17,9	5,13	17,9	5,63	17,8	5,88	17,8	6,13	17,7	6,63
		-13,7	-15,0	19,6	5,41	19,6	5,86	19,5	6,32	19,4	6,55	19,4	6,78	19,3	7,23
		-11,8	-13,0	21,3	6,07	21,2	6,49	21,1	6,90	21,1	7,11	21,0	7,32	21,0	7,74
		-9,8	-11,0	22,9	6,63	22,9	7,02	22,8	7,41	22,7	7,60	22,7	7,79	22,6	8,18
		-9,5	-10,0	23,8	6,89	23,7	7,26	23,6	7,63	23,6	7,82	23,5	8,00	23,5	8,38
		-8,5	-9,1	24,5	7,10	24,4	7,46	24,4	7,82	24,3	8,00	24,3	8,18	24,2	8,54
		-7,0	-7,6	25,8	7,43	25,7	7,77	25,6	8,11	25,6	8,28	25,6	8,46	25,5	8,80
		-5,0	-5,6	27,5	7,82	27,4	8,14	27,4	8,46	27,3	8,62	27,3	8,78	27,2	9,10
		-3,0	-3,7	29,1	8,15	29,1	8,46	29,0	8,76	29,0	8,91	28,9	9,06	28,8	9,36
		0,0	-0,7	31,8	8,61	31,7	8,89	31,6	9,16	31,6	9,30	31,5	9,44	31,5	9,71
		3,0	2,2	34,3	8,99	34,3	9,24	34,2	9,50	34,1	9,63	34,1	9,75	34,0	10,01
		5,0	4,1	36,0	9,21	36,0	9,45	35,9	9,69	35,8	9,82	35,8	9,94	35,7	10,18
		7,0	6,0	37,7	9,41	37,7	9,64	37,6	9,87	37,6	9,99	37,5	10,10	35,9	9,82
		9,0	7,9	39,5	9,60	39,4	9,82	39,3	10,04	39,3	10,15	38,6	10,04	35,9	9,41
		11,0	9,8	41,2	9,77	41,2	9,98	41,1	10,19	39,9	9,94	38,6	9,64	35,9	9,02
13,0	11,8	43,1	9,94	43,0	10,14	41,3	9,83	39,9	9,54	38,6	9,25	35,9	8,64		
15,0	13,7	44,9	10,08	43,9	10,02	41,3	9,46	39,9	9,18	38,6	8,89	35,9	8,30		
100	33,50 kW	-19,8	-20,0	15,5	4,08	15,4	4,61	15,3	5,14	15,3	5,41	15,3	5,68	15,2	6,21
		-18,8	-19,0	16,3	4,57	16,2	5,08	16,1	5,58	16,1	5,83	16,1	6,08	16,0	6,59
		-16,7	-17,0	17,9	5,43	17,8	5,88	17,8	6,34	17,7	6,56	17,7	6,79	17,6	7,25
		-13,7	-15,0	19,5	6,14	19,4	6,55	19,4	6,97	19,3	7,17	19,3	7,38	19,2	7,79
		-11,8	-13,0	21,2	6,74	21,1	7,12	21,0	7,50	21,0	7,69	21,0	7,88	20,9	8,26
		-9,8	-11,0	22,8	7,25	22,7	7,60	22,7	7,95	22,6	8,13	22,6	8,31	22,5	8,66
		-9,5	-10,0	23,6	7,48	23,6	7,82	23,5	8,16	23,5	8,33	23,5	8,50	23,4	8,84
		-8,5	-9,1	24,4	7,68	24,3	8,00	24,3	8,33	24,2	8,50	24,2	8,66	24,1	8,99
		-7,0	-7,6	25,7	7,98	25,6	8,29	25,5	8,60	25,5	8,75	25,5	8,91	25,4	9,22
		-5,0	-5,6	27,4	8,33	27,3	8,62	27,2	8,91	27,2	9,06	27,2	9,20	27,1	9,50
		-3,0	-3,7	29,0	8,63	29,0	8,91	28,9	9,18	28,9	9,32	28,8	9,46	28,8	9,73
		0,0	-0,7	31,6	9,05	31,6	9,30	31,5	9,55	31,5	9,68	31,4	9,80	31,4	10,05
		3,0	2,2	34,2	9,40	34,1	9,63	34,1	9,86	34,0	9,97	34,0	10,09	32,7	9,84
		5,0	4,1	35,9	9,60	35,8	9,82	35,8	10,04	35,7	10,15	35,1	10,03	32,7	9,40
		7,0	6,0	37,6	9,78	37,6	9,99	37,5	10,20	36,3	9,90	35,1	9,60	32,7	8,98
		9,0	7,9	39,4	9,95	39,3	10,15	37,5	9,78	36,3	9,49	35,1	9,20	32,7	8,60
		11,0	9,8	41,1	10,11	39,9	9,94	37,5	9,39	36,3	9,10	35,1	8,82	32,7	8,24
13,0	11,8	42,3	10,06	39,9	9,54	37,5	9,00	36,3	8,72	35,1	8,45	32,7	7,88		
15,0	13,7	42,3	9,69	39,9	9,18	37,5	8,65	36,3	8,38	35,1	8,11	32,7	7,56		

**NOTES - ANMERKUNGEN - Σημειώσεις - NOTAS - REMARQUES - NOTE - OPMERKINGEN - Примечания - NOTLAR**

- is shown as reference. When selecting the unit models, avoid the Outdoor air temperature range shown by
- dient als Verweis. Vermeiden Sie bei der Auswahl der Gerätemodelle den als markierten Temperaturbereich der Außenluft
- Η είναι ενδεικτική, κατά την επιλογή των μοντέλων των μονάδων, αποφύγετε το εύρος θερμοκρασίας εξωτερικού αέρα που υποδεικνύεται
- se muestra como referencia. Cuando seleccione los modelos de unidad, evite el intervalo de temperaturas del aire exterior indicado mediante
- est montré comme référence. Lors du choix des modèles d'unités, évitez la plage de températures de l'air extérieur illustré par
- valori riportati unicamente come riferimento. Nel selezionare i modelli delle unità, non considerare i valori di temperatura dell'aria esterna indicati con il colore
- is als referentie getoond. Wanneer modellen van eenheden worden gekozen, vermijd dan het bereik van buitenluchttemperaturen geïllustreerd door
- показан как. При выборе модели устройства избегайте внешнюю температуру

воздуха, указанную в  
referans olarak gösterilmektedir. Ünite modellerini seçerken, belirtilen Dış hava sıcaklığı aralığından kaçınm

The above table shows the average value of conditions which may occur.  
Die obige Tabelle zeigt den Durchschnittswert der Bedingungen, die auftreten können.  
Στον παραπάνω πίνακα αναγράφεται η μέση τιμή για συνθήκες που μπορεί να προκύψουν.  
La tabla de arriba muestra el valor medio de condiciones que pueden ocurrir.  
Le tableau ci-dessus donne la valeur moyenne pour des conditions qui peuvent survenir.  
La tabella in alto mostra il valore delle condizioni medie che si possono riscontrare.  
De tabel hierboven geeft de gemiddelde waarde aan van situaties die kunnen voorvallen.  
Таблица расположенная выше показывает среднее значение условий, которые могут наступить.  
Yukarıdaki tablo meydana gelebilecek koşulların ortalama değerini göstermektedir.

# 5 Capacity tables

## 5 - 2 Heating Capacity Tables

5

RQYQ12PY1															
TC: Total Capacity: kW ; PI: Power Input: kW (compressor + outdoor fan motor)															
Combination (%)	Capacity index (kW)	Outdoor air temp.		Indoor air temperature: °CDB											
				16.0		18.0		20.0		21.0		22.0		24.0	
				TC	PI	TC	PI	TC	PI	TC	PI	TC	PI	TC	PI
		°CDB	°CWB												
90%	30,15 kW	-19,8	-20,0	15,4	5,01	15,3	5,49	15,2	5,97	15,2	6,21	15,2	6,45	15,1	6,93
		-18,8	-19,0	16,2	5,46	16,1	5,91	16,0	6,36	16,0	6,59	16,0	6,82	15,9	7,27
		-16,7	-17,0	17,8	6,23	17,7	6,63	17,6	7,04	17,6	7,25	17,6	7,45	17,5	7,86
		-13,7	-15,0	19,4	6,86	19,3	7,24	19,3	7,61	19,2	7,80	19,2	7,98	19,2	8,36
		-11,8	-13,0	21,0	7,40	21,0	7,75	20,9	8,09	20,9	8,26	20,9	8,43	20,8	8,78
		-9,8	-11,0	22,7	7,87	22,6	8,18	22,6	8,50	22,5	8,66	22,5	8,82	22,5	9,13
		-9,5	-10,0	23,5	8,08	23,5	8,38	23,4	8,69	23,4	8,84	23,4	8,99	23,3	9,30
		-8,5	-9,1	24,3	8,25	24,2	8,55	24,2	8,84	24,1	8,99	24,1	9,14	24,1	9,43
		-7,0	-7,6	25,6	8,52	25,5	8,80	25,4	9,08	25,4	9,22	25,4	9,36	25,3	9,64
		-5,0	-5,6	27,3	8,84	27,2	9,10	27,1	9,37	27,1	9,50	27,1	9,63	27,0	9,89
		-3,0	-3,7	28,9	9,12	28,8	9,36	28,8	9,61	28,8	9,73	28,7	9,85	28,7	10,10
		0,0	-0,7	31,5	9,49	31,5	9,72	31,4	9,94	31,4	10,05	31,3	10,17	29,4	9,62
		3,0	2,2	34,1	9,80	34,0	10,01	33,8	10,13	32,7	9,84	31,6	9,54	29,4	8,92
		5,0	4,1	35,8	9,98	35,7	10,18	33,8	9,68	32,7	9,39	31,6	9,10	29,4	8,51
		7,0	6,0	37,5	10,15	35,9	9,81	33,8	9,26	32,7	8,98	31,6	8,70	29,4	8,12
		9,0	7,9	38,1	9,92	35,9	9,40	33,8	8,87	32,7	8,59	31,6	8,32	29,4	7,76
		11,0	9,8	38,1	9,52	35,9	9,02	33,8	8,50	32,7	8,23	31,6	7,97	29,4	7,42
		13,0	11,8	38,1	9,13	35,9	8,64	33,8	8,13	32,7	7,88	31,6	7,62	29,4	7,09
		15,0	13,7	38,1	8,78	35,9	8,30	33,8	7,81	32,7	7,56	31,6	7,31	29,4	6,80
		80%	26,80 kW	-19,8	-20,0	15,2	5,95	15,2	6,37	15,1	6,80	15,1	7,01	15,1	7,22
-18,8	-19,0			16,0	6,34	16,0	6,75	15,9	7,15	15,9	7,35	15,9	7,55	15,8	7,95
-16,7	-17,0			17,7	7,02	17,6	7,39	17,5	7,75	17,5	7,93	17,5	8,12	17,4	8,48
-13,7	-15,0			19,3	7,59	19,2	7,92	19,2	8,26	19,1	8,42	19,1	8,59	19,1	8,92
-11,8	-13,0			20,9	8,07	20,9	8,38	20,8	8,68	20,8	8,84	20,8	8,99	20,7	9,29
-9,8	-11,0			22,6	8,49	22,5	8,77	22,5	9,05	22,4	9,19	22,4	9,33	22,4	9,61
-9,5	-10,0			23,4	8,67	23,4	8,94	23,3	9,21	23,3	9,35	23,3	9,48	23,2	9,76
-8,5	-9,1			24,2	8,83	24,1	9,09	24,1	9,35	24,0	9,48	24,0	9,61	24,0	9,88
-7,0	-7,6			25,4	9,07	25,4	9,32	25,3	9,56	25,3	9,69	25,3	9,81	25,2	10,06
-5,0	-5,6			27,1	9,35	27,1	9,59	27,0	9,82	27,0	9,94	27,0	10,05	26,1	9,91
-3,0	-3,7			28,8	9,60	28,7	9,82	28,7	10,03	28,7	10,14	28,1	10,00	26,1	9,37
0,0	-0,7			31,4	9,93	31,4	10,13	30,0	9,80	29,0	9,51	28,1	9,21	26,1	8,61
3,0	2,2			33,9	10,16	31,9	9,63	30,0	9,09	29,0	8,81	28,1	8,53	26,1	7,96
5,0	4,1			33,9	9,71	31,9	9,20	30,0	8,67	29,0	8,40	28,1	8,13	26,1	7,58
7,0	6,0			33,9	9,29	31,9	8,79	30,0	8,28	29,0	8,02	28,1	7,76	26,1	7,22
9,0	7,9			33,9	8,89	31,9	8,41	30,0	7,91	29,0	7,66	28,1	7,41	26,1	6,89
11,0	9,8			33,9	8,52	31,9	8,05	30,0	7,57	29,0	7,33	28,1	7,08	26,1	6,58
13,0	11,8			33,9	8,16	31,9	7,70	30,0	7,23	29,0	7,00	28,1	6,76	26,1	6,28
15,0	13,7			33,9	7,83	31,9	7,39	30,0	6,94	29,0	6,71	28,1	6,48	26,1	6,01
70%	23,45 kW			-19,8	-20,0	15,1	6,88	15,1	7,25	15,0	7,63	15,0	7,81	15,0	8,00
		-18,8	-19,0	15,9	7,23	15,9	7,58	15,8	7,93	15,8	8,11	15,8	8,28	15,7	8,64
		-16,7	-17,0	17,5	7,82	17,5	8,14	17,4	8,46	17,4	8,62	17,4	8,78	17,4	9,10
		-13,7	-15,0	19,2	8,32	19,1	8,61	19,1	8,90	19,0	9,05	19,0	9,19	19,0	9,48
		-11,8	-13,0	20,8	8,74	20,8	9,01	20,7	9,28	20,7	9,41	20,7	9,54	20,6	9,81
		-9,8	-11,0	22,5	9,10	22,4	9,35	22,4	9,60	22,3	9,72	22,3	9,84	22,3	10,09
		-9,5	-10,0	23,3	9,27	23,3	9,50	23,2	9,74	23,2	9,86	23,2	9,98	22,9	10,08
		-8,5	-9,1	24,1	9,40	24,0	9,63	24,0	9,86	23,9	9,98	23,9	10,09	22,9	9,78
		-7,0	-7,6	25,3	9,61	25,3	9,83	25,2	10,05	25,2	10,16	24,6	9,95	22,9	9,32
		-5,0	-5,6	27,0	9,86	27,0	10,07	26,3	9,94	25,4	9,65	24,6	9,35	22,9	8,75
		-3,0	-3,7	28,7	10,08	27,9	9,96	26,3	9,41	25,4	9,12	24,6	8,84	22,9	8,25
		0,0	-0,7	29,6	9,68	27,9	9,17	26,3	8,65	25,4	8,38	24,6	8,11	22,9	7,56
		3,0	2,2	29,6	8,98	27,9	8,49	26,3	8,00	25,4	7,74	24,6	7,49	22,9	6,97
		5,0	4,1	29,6	8,57	27,9	8,09	26,3	7,61	25,4	7,37	24,6	7,12	22,9	6,62
		7,0	6,0	29,6	8,18	27,9	7,72	26,3	7,25	25,4	7,02	24,6	6,78	22,9	6,29
		9,0	7,9	29,6	7,81	27,9	7,37	26,3	6,92	25,4	6,69	24,6	6,46	22,9	5,99
		11,0	9,8	29,6	7,48	27,9	7,05	26,3	6,61	25,4	6,39	24,6	6,17	22,9	5,71
		13,0	11,8	29,6	7,14	27,9	6,73	26,3	6,30	25,4	6,09	24,6	5,88	22,9	5,44
		15,0	13,7	29,6	6,85	27,9	6,44	26,3	6,03	25,4	5,83	24,6	5,62	22,9	5,20
		60%	20,10 kW	-19,8	-20,0	15,0	7,81	15,0	8,13	14,9	8,45	14,9	8,61	14,9	8,77
-18,8	-19,0			15,8	8,11	15,8	8,41	15,7	8,72	15,7	8,87	15,7	9,02	15,7	9,32
-16,7	-17,0			17,4	8,62	17,4	8,90	17,3	9,17	17,3	9,31	17,3	9,44	17,3	9,72
-13,7	-15,0			19,0	9,05	19,0	9,30	19,0	9,55	18,9	9,67	18,9	9,80	18,9	10,05
-11,8	-13,0			20,7	9,41	20,6	9,64	20,6	9,87	20,6	9,98	20,6	10,10	19,6	9,75
-9,8	-11,0			22,3	9,72	22,3	9,93	22,3	10,14	21,8	9,98	21,1	9,67	19,6	9,06
-9,5	-10,0			23,2	9,86	23,1	10,06	22,5	9,93	21,8	9,64	21,1	9,34	19,6	8,74
-8,5	-9,1			23,9	9,98	23,9	10,17	22,5	9,64	21,8	9,35	21,1	9,06	19,6	8,47
-7,0	-7,6			25,2	10,16	23,9	9,72	22,5	9,17	21,8	8,90	21,1	8,61	19,6	8,04
-5,0	-5,6			25,4	9,64	23,9	9,13	22,5	8,61	21,8	8,34	21,1	8,07	19,6	7,53
-3,0	-3,7			25,4	9,12	23,9	8,63	22,5	8,12	21,8	7,87	21,1	7,61	19,6	7,08
0,0	-0,7			25,4	8,37	23,9	7,91	22,5	7,43	21,8	7,19	21,1	6,95	19,6	6,46
3,0	2,2			25,4	7,74	23,9	7,30	22,5	6,85	21,8	6,62	21,1	6,39	19,6	5,93
5,0	4,1			25,4	7,36	23,9	6,94	22,5	6,51	21,8	6,29	21,1	6,07	19,6	5,62
7,0	6,0			25,4	7,01	23,9	6,60	22,5	6,19	21,8	5,97	21,1	5,76	19,6	5,33
9,0	7,9			25,4	6,69	23,9	6,29	22,5	5,89	21,8	5,69	21,1	5,48	19,6	5,07
11,0	9,8			25,4	6,38	23,9	6,00	22,5	5,61	21,8	5,42	21,1	5,22	19,6	4,82
13,0	11,8			25,4	6,09	23,9	5,72	22,5	5,34	21,8	5,15	21,1	4,96	19,6	4,58
15,0	13,7			25,4	5,82	23,9	5,46	22,5	5,10	21,8	4,92	21,1	4,74	19,6	4,36
50%	16,75 kW			-19,8	-20,0	14,9	8,75	14,9	9,01	14,8	9,28	14,8	9,41	14,8	9,55
		-18,8	-19,0	15,7	9,00	15,7	9,25	15,6	9,50	15,6	9,62	15,6	9,75	15,6	10,00
		-16,7	-17,0	17,3	9,42	17,3	9,65	17,2	9,88	17,2	9,99	17,2	10,11	16,3	9,71
		-13,7	-15,0	18,9	9,78	18,9	9,99	18,8	10,12	18,1	9,82	17,5	9,52	16,3	8,91
		-11,8	-13,0	20,6	10,08	20,0	9,91	18,8	9,35	18,1	9,07	17,5	8,79	16,3	8,21
		-9,8	-11,0	21,2	9,72	20,0	9,21	18,8	8,68	18,1	8,41	17,5	8,14	16,3	7,59
		-9,5	-10,0	21,2	9,39	20,0	8,88	18,8	8,37	18,1	8,11	17,5	7,84	16,3	7,31
		-8,5	-9,1	21,2	9,10	20,0	8,61	18,8	8,11	18,1	7,85	17,5	7,59	16,3	7,07
		-7,0	-7,6	21,2	8,66	20,0	8,18	18,8	7,69	18,1	7,45	17,5	7,20	16,3	6,69
		-5,0	-5,6	21,2	8,11	20,0	7,66	18,8	7,19	18,1	6,96	17,5	6,72	16,3	6,24
		-3,0	-3,7	21,2	7,64	20,0	7,21	18,8	6,76	18,1	6,54	17,5	6,31	16,3	5,85
		0,0	-0,7	21,2	6,99	20,0	6,58	18,8	6,16						



# 5 Capacity tables

## 5 - 2 Heating Capacity Tables

RQYQ14PY1		TC: Total Capacity: kW ; PI: Power Input: kW (compressor + outdoor fan motor)													
Combination (%)	Capacity index (kW)	Outdoor air temp.		Indoor air temperature: °CDB											
				16.0		18.0		20.0		21.0		22.0		24.0	
		°CDB	°CWB	TC	PI	TC	PI	TC	PI	TC	PI	TC	PI	TC	PI
130	52,00 kW	-19,8	-20,0	26,0	7,80	25,9	8,56	25,8	9,32	25,8	9,70	25,7	10,09	25,6	10,85
		-18,8	-19,0	26,9	8,24	26,8	8,97	26,7	9,70	26,7	10,06	26,6	10,43	26,5	11,16
		-16,7	-17,0	28,8	9,00	28,7	9,67	28,6	10,35	28,5	10,68	28,5	11,02	28,4	11,69
		-13,7	-15,0	30,6	9,63	30,5	10,26	30,4	10,88	30,4	11,19	30,3	11,50	30,2	12,12
		-11,8	-13,0	32,4	10,16	32,3	10,74	32,2	11,32	32,2	11,61	32,1	11,90	32,0	12,47
		-9,8	-11,0	34,3	10,60	34,2	11,14	34,1	11,68	34,0	11,95	34,0	12,22	33,9	12,8
		-9,5	-10,0	35,2	10,79	35,1	11,32	35,0	11,84	34,9	12,10	34,9	12,36	34,8	12,9
		-8,5	-9,1	36,0	10,95	35,9	11,46	35,8	11,96	35,8	12,22	35,7	12,47	35,6	13,0
		-7,0	-7,6	37,4	11,19	37,3	11,67	37,2	12,15	37,1	12,39	37,1	12,6	37,0	13,1
		-5,0	-5,6	39,2	11,45	39,1	11,91	39,0	12,4	39,0	12,6	38,9	12,8	38,8	13,3
		-3,0	-3,7	41,0	11,66	40,9	12,09	40,8	12,5	40,7	12,7	40,7	12,9	40,6	13,4
		0,0	-0,7	43,7	11,9	43,6	12,3	43,5	12,7	43,5	12,9	43,4	13,1	43,3	13,5
		3,0	2,2	46,4	12,1	46,3	12,4	46,2	12,8	46,1	13,0	46,1	13,2	46,0	13,5
		5,0	4,1	48,1	12,2	48,0	12,5	47,9	12,8	47,9	13,0	47,8	13,2	47,7	13,5
		7,0	6,0	49,9	12,2	49,8	12,5	49,6	12,9	49,6	13,0	49,5	13,2	49,4	13,5
		9,0	7,9	51,6	12,3	51,5	12,6	51,4	12,9	51,3	13,0	51,3	13,2	51,0	13,4
		11,0	9,8	53,3	12,3	53,2	12,6	53,1	12,9	53,1	13,0	53,0	13,2	51,0	12,7
13,0	11,8	55,2	12,3	55,1	12,5	55,0	12,8	54,9	13,0	54,7	13,1	51,0	12,0		
15,0	13,7	56,9	12,3	56,8	12,5	56,7	12,8	56,6	12,9	56,7	12,4	51,0	11,4		
120	48,00 kW	-19,8	-20,0	25,9	8,83	25,8	9,53	25,7	10,24	25,7	10,59	25,6	10,94	25,5	11,64
		-18,8	-19,0	26,8	9,22	26,7	9,90	26,6	10,57	26,6	10,91	26,5	11,25	26,4	11,92
		-16,7	-17,0	28,6	9,91	28,5	10,53	28,5	11,15	28,4	11,46	28,4	11,77	28,3	12,39
		-13,7	-15,0	30,5	10,47	30,4	11,05	30,3	11,62	30,2	11,91	30,2	12,20	30,1	12,77
		-11,8	-13,0	32,3	10,94	32,2	11,48	32,1	12,01	32,1	12,28	32,0	12,54	31,9	13,1
		-9,8	-11,0	34,1	11,33	34,0	11,83	33,9	12,33	33,9	12,57	33,9	12,8	33,8	13,3
		-9,5	-10,0	35,1	11,50	35,0	11,98	34,9	12,46	34,8	12,7	34,8	12,9	34,7	13,4
		-8,5	-9,1	35,9	11,64	35,8	12,10	35,7	12,6	35,6	12,8	35,6	13,0	35,5	13,5
		-7,0	-7,6	37,3	11,84	37,2	12,28	37,1	12,7	37,0	12,9	37,0	13,2	36,9	13,6
		-5,0	-5,6	39,1	12,06	39,0	12,5	38,9	12,9	38,8	13,1	38,8	13,3	38,7	13,7
		-3,0	-3,7	40,8	12,2	40,7	12,6	40,6	13,0	40,6	13,2	40,5	13,4	40,4	13,8
		0,0	-0,7	43,6	12,4	43,5	12,8	43,4	13,2	43,3	13,3	43,3	13,5	43,2	13,9
		3,0	2,2	46,2	12,6	46,1	12,9	46,0	13,2	46,0	13,4	45,9	13,6	45,9	13,9
		5,0	4,1	48,0	12,6	47,9	12,9	47,8	13,3	47,7	13,4	47,7	13,6	47,1	13,6
		7,0	6,0	49,7	12,7	49,6	13,0	49,5	13,3	49,5	13,4	49,4	13,6	47,1	12,9
		9,0	7,9	51,5	12,7	51,4	13,0	51,3	13,2	51,2	13,4	50,5	13,3	47,1	12,2
		11,0	9,8	53,2	12,7	53,1	12,9	53,0	13,2	52,3	13,1	50,5	12,5	47,1	11,5
13,0	11,8	55,0	12,6	54,9	12,9	54,0	12,8	52,3	12,4	50,5	11,9	47,1	10,9		
15,0	13,7	56,8	12,6	56,7	12,9	54,0	12,2	52,3	11,7	50,5	11,3	47,1	10,4		
110	44,00 kW	-19,8	-20,0	25,8	9,86	25,7	10,50	25,6	11,15	25,5	11,47	25,5	11,79	25,4	12,44
		-18,8	-19,0	26,7	10,21	26,6	10,83	26,5	11,45	26,5	11,76	26,4	12,07	26,3	12,68
		-16,7	-17,0	28,5	10,82	28,4	11,39	28,3	11,96	28,3	12,24	28,2	12,53	28,2	13,10
		-13,7	-15,0	30,3	11,32	30,2	11,84	30,2	12,37	30,1	12,63	30,1	12,90	30,0	13,4
		-11,8	-13,0	32,2	11,72	32,1	12,21	32,0	12,70	31,9	12,9	31,9	13,2	31,8	13,7
		-9,8	-11,0	34,0	12,06	33,9	12,51	33,8	13,0	33,8	13,2	33,7	13,4	33,7	13,9
		-9,5	-10,0	34,9	12,20	34,8	12,6	34,7	13,1	34,7	13,3	34,7	13,5	34,6	14,0
		-8,5	-9,1	35,7	12,32	35,7	12,7	35,6	13,2	35,5	13,4	35,5	13,6	35,4	14,0
		-7,0	-7,6	37,1	12,5	37,0	12,9	36,9	13,3	36,9	13,5	36,9	13,7	36,8	14,1
		-5,0	-5,6	38,9	12,7	38,9	13,1	38,8	13,4	38,7	13,6	38,7	13,8	38,6	14,2
		-3,0	-3,7	40,7	12,8	40,6	13,2	40,5	13,5	40,5	13,7	40,4	13,9	40,3	14,3
		0,0	-0,7	43,4	13,0	43,4	13,3	43,3	13,6	43,2	13,8	43,2	14,0	43,1	14,3
		3,0	2,2	46,1	13,1	46,0	13,4	45,9	13,7	45,9	13,8	45,8	14,0	43,1	13,0
		5,0	4,1	47,8	13,1	47,7	13,4	47,7	13,7	47,6	13,8	46,3	13,4	43,1	12,3
		7,0	6,0	49,6	13,1	49,5	13,4	49,4	13,6	47,9	13,2	46,3	12,6	43,1	11,6
		9,0	7,9	51,3	13,1	51,2	13,4	49,5	12,9	47,9	12,4	46,3	11,9	43,1	11,0
		11,0	9,8	53,1	13,1	52,7	13,2	49,5	12,2	47,9	11,8	46,3	11,3	43,1	10,4
13,0	11,8	54,9	13,0	52,7	12,5	49,5	11,6	47,9	11,1	46,3	10,7	43,1	9,85		
15,0	13,7	55,9	12,7	52,7	11,8	49,5	11,0	47,9	10,6	46,3	10,2	43,1	9,36		
100	40,00 kW	-19,8	-20,0	25,6	10,89	25,5	11,48	25,5	12,06	25,4	12,36	25,4	12,65	25,3	13,24
		-18,8	-19,0	26,5	11,20	26,5	11,76	26,4	12,32	26,3	12,60	26,3	12,88	26,2	13,4
		-16,7	-17,0	28,4	11,73	28,3	12,24	28,2	12,76	28,2	13,02	28,1	13,3	28,0	13,8
		-13,7	-15,0	30,2	12,16	30,1	12,64	30,0	13,1	30,0	13,4	30,0	13,6	29,9	14,1
		-11,8	-13,0	32,0	12,51	31,9	13,0	31,9	13,4	31,8	13,6	31,8	13,8	31,7	14,3
		-9,8	-11,0	33,9	12,8	33,8	13,2	33,7	13,6	33,7	13,8	33,6	14,0	33,5	14,4
		-9,5	-10,0	34,8	12,9	34,7	13,3	34,6	13,7	34,6	13,9	34,5	14,1	34,5	14,5
		-8,5	-9,1	35,6	13,0	35,5	13,4	35,4	13,8	35,4	14,0	35,4	14,2	35,3	14,6
		-7,0	-7,6	37,0	13,1	36,9	13,5	36,8	13,9	36,8	14,1	36,7	14,2	36,7	14,6
		-5,0	-5,6	38,8	13,3	38,7	13,6	38,7	14,0	38,6	14,2	38,6	14,3	38,5	14,7
		-3,0	-3,7	40,5	13,4	40,5	13,7	40,4	14,0	40,4	14,2	40,3	14,4	39,2	14,1
		0,0	-0,7	43,3	13,5	43,2	13,8	43,1	14,1	43,1	14,2	42,1	13,9	39,2	12,8
		3,0	2,2	46,0	13,5	45,9	13,8	45,0	13,7	43,6	13,2	42,1	12,7	39,2	11,6
		5,0	4,1	47,7	13,5	47,6	13,8	45,0	12,9	43,6	12,4	42,1	11,9	39,2	11,0
		7,0	6,0	49,4	13,5	47,9	13,1	45,0	12,2	43,6	11,7	42,1	11,3	39,2	10,38
		9,0	7,9	50,8	13,3	47,9	12,4	45,0	11,5	43,6	11,1	42,1	10,7	39,2	9,83
		11,0	9,8	50,8	12,6	47,9	11,8	45,0	10,9	43,6	10,5	42,1	10,12	39,2	9,33
13,0	11,8	50,8	11,9	47,9	11,1	45,0	10,3	43,6	9,96	42,1	9,58	39,2	8,84		
15,0	13,7	50,8	11,3	47,9	10,6	45,0	9,83	43,6	9,46	42,1	9,11	39,2	8,41		

**NOTES - ANMERKUNGEN - Σημειώσεις - NOTAS - REMARQUES - NOTE - OPMERKINGEN - Примечания - NOTLAR**

- is shown as reference. When selecting the unit models, avoid the Outdoor air temperature range shown by
- dient als Verweis. Vermeiden Sie bei der Auswahl der Gerätemodelle den als markierten Temperaturbereich der Außenluft
- Η είναι ενδεικτική, κατά την επιλογή των μοντέλων των μονάδων, αποφύγετε το εύρος θερμοκρασίας εξωτερικού αέρα που υποδεικνύεται
- se muestra como referencia. Cuando seleccione los modelos de unidad, evite el intervalo de temperaturas del aire exterior indicado mediante
- est montré comme référence. Lors du choix des modèles d'unités, évitez la plage de températures de l'air extérieur illustré par
- valori riportati unicamente come riferimento. Nel selezionare i modelli delle unità, non considerare i valori di temperatura dell'aria esterna indicati con il colore
- is als referentie getoond. Wanneer modellen van eenheden worden gekozen, vermijd dan het bereik van buitenluchttemperaturen geïllustreerd door
- показан как. При выборе модели устройства избегайте внешнюю температуру

воздуха, указанную в  
referans olarak gösterilmektedir. Ünite modellerini seçerken, belirtilen Dış hava sıcaklığı aralığından kaçının

The above table shows the average value of conditions which may occur.  
Die obige Tabelle zeigt den Durchschnittswert der Bedingungen, die auftreten können.  
Στον παραπάνω πίνακα αναγράφεται η μέση τιμή για συνθήκες που μπορεί να προκύψουν.  
La tabla de arriba muestra el valor medio de condiciones que pueden ocurrir.  
Le tableau ci-dessus donne la valeur moyenne pour des conditions qui peuvent survenir.  
La tabella in alto mostra il valore delle condizioni medie che si possono riscontrare.  
De tabel hierboven geeft de gemiddelde waarde aan van situaties die kunnen voorvallen.  
Таблица расположенная выше показывает среднее значение условий, которые могут наступить.  
Yukarıdaki tablo meydana gelebilecek koşulların ortalama değerini göstermektedir.

# 5 Capacity tables

## 5 - 2 Heating Capacity Tables

5

RQYQ14PY1															
TC: Total Capacity: kW ; PI: Power Input: kW (compressor + outdoor fan motor)															
Combination (%)	Capacity index (kW)	Outdoor air temp.		Indoor air temperature: °CDB											
				16.0		18.0		20.0		21.0		22.0		24.0	
				TC	PI	TC	PI	TC	PI	TC	PI	TC	PI	TC	PI
		°CDB	°CWB	kW		kW		kW		kW		kW		kW	
90%	36,00 kW	-19,8	-20,0	25,5	11,92	25,4	12,45	25,3	12,98	25,3	13,24	25,3	13,5	25,2	14,0
		-18,8	-19,0	26,4	12,18	26,3	12,69	26,2	13,20	26,2	13,4	26,2	13,7	26,1	14,2
		-16,7	-17,0	28,2	12,64	28,2	13,10	28,1	13,6	28,0	13,8	28,0	14,0	27,9	14,5
		-13,7	-15,0	30,1	13,00	30,0	13,4	29,9	13,9	29,9	14,1	29,8	14,3	29,8	14,7
		-11,8	-13,0	31,9	13,3	31,8	13,7	31,7	14,1	31,7	14,3	31,7	14,5	31,6	14,9
		-9,8	-11,0	33,7	13,5	33,7	13,9	33,6	14,3	33,5	14,4	33,5	14,6	33,4	15,0
		-9,5	-10,0	34,6	13,6	34,6	14,0	34,5	14,3	34,5	14,5	34,4	14,7	34,4	15,1
		-8,5	-9,1	35,5	13,7	35,4	14,0	35,3	14,4	35,3	14,6	35,2	14,7	35,2	15,1
		-7,0	-7,6	36,8	13,8	36,8	14,1	36,7	14,5	36,7	14,6	36,6	14,8	35,3	14,3
		-5,0	-5,6	38,7	13,9	38,6	14,2	38,5	14,5	38,5	14,7	37,9	14,5	35,3	13,3
		-3,0	-3,7	40,4	14,0	40,3	14,3	40,3	14,6	39,2	14,1	37,9	13,6	35,3	12,4
		0,0	-0,7	43,2	14,0	43,1	14,3	40,5	13,3	39,2	12,8	37,9	12,2	35,3	11,3
		3,0	2,2	45,7	14,0	43,1	13,0	40,5	12,1	39,2	11,6	37,9	11,2	35,3	10,29
		5,0	4,1	45,7	13,2	43,1	12,3	40,5	11,4	39,2	11,0	37,9	10,55	35,3	9,72
		7,0	6,0	45,7	12,4	43,1	11,6	40,5	10,8	39,2	10,37	37,9	9,98	35,3	9,21
		9,0	7,9	45,7	11,8	43,1	11,0	40,5	10,20	39,2	9,83	37,9	9,45	35,3	8,73
		11,0	9,8	45,7	11,1	43,1	10,4	40,5	9,67	39,2	9,32	37,9	8,97	35,3	8,29
		13,0	11,8	45,7	10,5	43,1	9,84	40,5	9,16	39,2	8,83	37,9	8,50	35,3	7,86
		15,0	13,7	45,7	10,0	43,1	9,35	40,5	8,71	39,2	8,40	37,9	8,09	35,3	7,49
		80%	32,00 kW	-19,8	-20,0	25,3	12,95	25,3	13,42	25,2	13,9	25,2	14,1	25,1	14,4
-18,8	-19,0			26,3	13,17	26,2	13,6	26,1	14,1	26,1	14,3	26,1	14,5	26,0	15,0
-16,7	-17,0			28,1	13,5	28,0	14,0	28,0	14,4	27,9	14,6	27,9	14,8	27,8	15,2
-13,7	-15,0			29,9	13,8	29,9	14,2	29,8	14,6	29,8	14,8	29,7	15,0	29,7	15,4
-11,8	-13,0			31,7	14,1	31,7	14,4	31,6	14,8	31,6	15,0	31,6	15,1	31,4	15,4
-9,8	-11,0			33,6	14,2	33,5	14,6	33,5	14,9	33,4	15,1	33,4	15,2	31,4	14,2
-9,5	-10,0			34,5	14,3	34,4	14,6	34,4	15,0	34,3	15,1	33,7	14,8	31,4	13,6
-8,5	-9,1			35,3	14,4	35,3	14,7	35,2	15,0	34,8	14,9	33,7	14,3	31,4	13,2
-7,0	-7,6			36,7	14,4	36,6	14,7	36,0	14,7	34,8	14,1	33,7	13,5	31,4	12,4
-5,0	-5,6			38,5	14,5	38,3	14,7	36,0	13,6	34,8	13,1	33,7	12,6	31,4	11,6
-3,0	-3,7			40,3	14,5	38,3	13,7	36,0	12,7	34,8	12,3	33,7	11,8	31,4	10,85
0,0	-0,7			40,6	13,3	38,3	12,4	36,0	11,5	34,8	11,1	33,7	10,68	31,4	9,84
3,0	2,2			40,6	12,1	38,3	11,3	36,0	10,53	34,8	10,14	33,7	9,76	31,4	9,01
5,0	4,1			40,6	11,4	38,3	10,7	36,0	9,95	34,8	9,58	33,7	9,23	31,4	8,53
7,0	6,0			40,6	10,8	38,3	10,10	36,0	9,41	34,8	9,07	33,7	8,74	31,4	8,08
9,0	7,9			40,6	10,24	38,3	9,57	36,0	8,92	34,8	8,60	33,7	8,29	31,4	7,67
11,0	9,8			40,6	9,71	38,3	9,08	36,0	8,47	34,8	8,17	33,7	7,88	31,4	7,29
13,0	11,8			40,6	9,20	38,3	8,61	36,0	8,03	34,8	7,75	33,7	7,47	31,4	6,93
15,0	13,7			40,6	8,75	38,3	8,19	36,0	7,65	34,8	7,38	33,7	7,12	31,4	6,60
70%	28,00 kW			-19,8	-20,0	25,2	14,0	25,1	14,4	25,1	14,8	25,1	15,0	25,0	15,2
		-18,8	-19,0	26,1	14,2	26,1	14,6	26,0	14,9	26,0	15,1	25,9	15,3	25,9	15,7
		-16,7	-17,0	27,9	14,5	27,9	14,8	27,8	15,2	27,8	15,4	27,8	15,5	27,5	15,7
		-13,7	-15,0	29,8	14,7	29,7	15,0	29,7	15,4	29,6	15,5	29,5	15,6	27,5	14,3
		-11,8	-13,0	31,6	14,8	31,6	15,2	31,5	15,5	30,5	14,9	29,5	14,3	27,5	13,1
		-9,8	-11,0	33,4	15,0	33,4	15,3	31,5	14,2	30,5	13,7	29,5	13,2	27,5	12,1
		-9,5	-10,0	34,4	15,0	33,5	14,8	31,5	13,7	30,5	13,2	29,5	12,6	27,5	11,6
		-8,5	-9,1	35,2	15,0	33,5	14,2	31,5	13,2	30,5	12,7	29,5	12,2	27,5	11,25
		-7,0	-7,6	35,5	14,4	33,5	13,5	31,5	12,5	30,5	12,0	29,5	11,6	27,5	10,66
		-5,0	-5,6	35,5	13,4	33,5	12,5	31,5	11,6	30,5	11,20	29,5	10,77	27,5	9,94
		-3,0	-3,7	35,5	12,6	33,5	11,7	31,5	10,90	30,5	10,50	29,5	10,10	27,5	9,33
		0,0	-0,7	35,5	11,4	33,5	10,62	31,5	9,89	30,5	9,53	29,5	9,18	27,5	8,49
		3,0	2,2	35,5	10,38	33,5	9,71	31,5	9,05	30,5	8,73	29,5	8,41	27,5	7,79
		5,0	4,1	35,5	9,80	33,5	9,18	31,5	8,56	30,5	8,26	29,5	7,96	27,5	7,38
		7,0	6,0	35,5	9,28	33,5	8,69	31,5	8,12	30,5	7,83	29,5	7,55	27,5	7,00
		9,0	7,9	35,5	8,80	33,5	8,25	31,5	7,70	30,5	7,44	29,5	7,18	27,5	6,66
		11,0	9,8	35,5	8,35	33,5	7,83	31,5	7,33	30,5	7,07	29,5	6,83	27,5	6,34
		13,0	11,8	35,5	7,92	33,5	7,43	31,5	6,96	30,5	6,72	29,5	6,49	27,5	6,03
		15,0	13,7	35,5	7,55	33,5	7,08	31,5	6,63	30,5	6,41	29,5	6,19	27,5	5,75
		60%	24,00 kW	-19,8	-20,0	25,1	15,0	25,0	15,4	25,0	15,7	24,9	15,9	24,9	16,1
-18,8	-19,0			26,0	15,1	25,9	15,5	25,9	15,8	25,9	16,0	25,3	15,6	23,5	14,3
-16,7	-17,0			27,8	15,4	27,8	15,7	27,0	15,3	26,1	14,8	25,3	14,2	23,5	13,0
-13,7	-15,0			29,6	15,5	28,7	15,1	27,0	14,0	26,1	13,5	25,3	12,9	23,5	11,92
-11,8	-13,0			30,5	14,9	28,7	13,8	27,0	12,9	26,1	12,4	25,3	11,9	23,5	10,97
-9,8	-11,0			30,5	13,7	28,7	12,8	27,0	11,9	26,1	11,43	25,3	10,99	23,5	10,14
-9,5	-10,0			30,5	13,2	28,7	12,3	27,0	11,42	26,1	11,00	25,3	10,59	23,5	9,77
-8,5	-9,1			30,5	12,7	28,7	11,9	27,0	11,04	26,1	10,64	25,3	10,24	23,5	9,46
-7,0	-7,6			30,5	12,0	28,7	11,23	27,0	10,46	26,1	10,08	25,3	9,70	23,5	8,97
-5,0	-5,6			30,5	11,19	28,7	10,47	27,0	9,76	26,1	9,41	25,3	9,06	23,5	8,39
-3,0	-3,7			30,5	10,49	28,7	9,82	27,0	9,16	26,1	8,84	25,3	8,52	23,5	7,89
0,0	-0,7			30,5	9,53	28,7	8,93	27,0	8,34	26,1	8,05	25,3	7,76	23,5	7,20
3,0	2,2			30,5	8,72	28,7	8,18	27,0	7,65	26,1	7,39	25,3	7,13	23,5	6,62
5,0	4,1			30,5	8,26	28,7	7,75	27,0	7,25	26,1	7,01	25,3	6,76	23,5	6,29
7,0	6,0			30,5	7,83	28,7	7,35	27,0	6,88	26,1	6,65	25,3	6,43	23,5	5,98
9,0	7,9			30,5	7,43	28,7	6,99	27,0	6,55	26,1	6,33	25,3	6,11	23,5	5,69
11,0	9,8			30,5	7,07	28,7	6,65	27,0	6,23	26,1	6,03	25,3	5,83	23,5	5,43
13,0	11,8			30,5	6,72	28,7	6,32	27,0	5,93	26,1	5,74	25,3	5,54	23,5	5,17
15,0	13,7			30,5	6,40	28,7	6,03	27,0	5,66	26,1	5,48	25,3	5,30	23,5	4,94
50%	20,00 kW			-19,8	-20,0	24,9	16,0	23,9	15,4	22,5	14,3	21,8	13,7	21,1	13,2
		-18,8	-19,0	25,4	15,7	23,9	14,6	22,5	13,6	21,8	13,1	21,1	12,6	19,6	11,58
		-16,7	-17,0	25,4	14,3	23,9	13,3	22,5	12,4	21,8	11,90	21,1	11,45	19,6	10,56
		-13,7	-15,0	25,4	13,0	23,9	12,2	22,5	11,32	21,8	10,91	21,1	10,50	19,6	9,70
		-11,8	-13,0	25,4	12,0	23,9	11,19	22,5	10,43	21,8	10,05	21,1	9,68	19,6	8,96
		-9,8	-11,0	25,4	11,06	23,9	10,35	22,5	9,65	21,8	9,31	21,1	8,97	19,6	8,31
		-9,5	-10,0	25,4	10,65	23,9	9,97	22,5	9,30	21,8	8,98	21,1	8,65	19,6	8,02
		-8,5	-9,1	25,4	10,30	23,9	9,64	22,5	9,01	21,8	8,69	21,1	8,38	19,6	7,77
		-7,0	-7,6	25,4	9,76	23,9	9,15	22,5	8,55	21,8	8,25	21,1	7,96	19,6	7,39
		-5,0	-5,6	25,4	9,11	23,9	8,55	22,5	7,99	21,8	7,72	21,1	7,45	19,6	6,92
		-3,0	-3,7	25,4	8,56	23,9	8,04	22,5	7,52	21,8	7,27	21,1	7,02	19,6	6,

# 5 Capacity tables

## 5 - 2 Heating Capacity Tables

### RQYQ16PY1

TC: Total Capacity: kW ; PI: Power Input: kW (compressor + outdoor fan motor)

Combination (%)	Capacity index (kW)	Outdoor air temp.		Indoor air temperature: °CDB											
				16.0		18.0		20.0		21.0		22.0		24.0	
				TC	PI	TC	PI	TC	PI	TC	PI	TC	PI	TC	PI
130	58,50 kW	-19,8	-20,0	28,4	8,14	28,3	9,00	28,2	9,85	28,1	10,27	28,0	10,70	27,9	11,55
		-18,8	-19,0	29,4	8,64	29,3	9,45	29,2	10,27	29,1	10,67	29,0	11,08	28,9	11,90
		-16,7	-17,0	31,4	9,50	31,3	10,25	31,2	11,00	31,1	11,37	31,0	11,75	30,9	12,50
		-13,7	-15,0	33,4	10,21	33,3	10,90	33,2	11,60	33,1	11,94	33,0	12,29	32,9	12,99
		-11,8	-13,0	35,4	10,80	35,3	11,45	35,1	12,09	35,1	12,42	35,0	12,74	34,9	13,38
		-9,8	-11,0	37,4	11,30	37,3	11,90	37,1	12,50	37,1	12,80	37,0	13,10	36,9	13,7
		-9,5	-10,0	38,4	11,52	38,3	12,10	38,1	12,68	38,1	12,97	38,0	13,3	37,9	13,8
		-8,5	-9,1	39,3	11,70	39,2	12,26	39,0	12,82	39,0	13,11	38,9	13,4	38,8	14,0
		-7,0	-7,6	40,8	11,97	40,6	12,50	40,5	13,0	40,5	13,3	40,4	13,6	40,3	14,1
		-5,0	-5,6	42,8	12,27	42,6	12,77	42,5	13,3	42,5	13,5	42,4	13,8	42,3	14,3
		-3,0	-3,7	44,7	12,51	44,5	13,0	44,4	13,5	44,4	13,7	44,3	13,9	44,2	14,4
		0,0	-0,7	47,6	12,8	47,5	13,2	47,4	13,7	47,4	13,9	47,3	14,1	47,2	14,5
		3,0	2,2	50,5	13,0	50,4	13,4	50,3	13,8	50,3	14,0	50,2	14,2	50,1	14,6
		5,0	4,1	52,4	13,1	52,3	13,5	52,2	13,9	52,2	14,0	52,1	14,2	52,0	14,6
		7,0	6,0	54,3	13,2	54,2	13,5	54,1	13,9	54,0	14,1	54,0	14,2	53,9	14,6
		9,0	7,9	56,2	13,2	56,1	13,5	56,0	13,9	55,9	14,1	55,9	14,2	55,8	14,6
		11,0	9,8	58,1	13,2	58,0	13,6	57,9	13,9	57,8	14,0	57,8	14,2	56,6	14,1
13,0	11,8	60,1	13,2	60,0	13,5	59,9	13,9	59,8	14,0	59,8	14,2	56,6	13,4		
15,0	13,7	62,0	13,2	61,9	13,5	61,8	13,8	61,7	14,0	60,8	13,8	56,6	12,7		
120	54,00 kW	-19,8	-20,0	28,2	9,29	28,1	10,08	28,0	10,86	28,0	11,26	27,9	11,65	27,8	12,43
		-18,8	-19,0	29,2	9,74	29,1	10,49	29,0	11,24	29,0	11,62	28,9	11,99	28,8	12,75
		-16,7	-17,0	31,2	10,51	31,1	11,20	31,0	11,89	31,0	12,24	30,9	12,59	30,8	13,28
		-13,7	-15,0	33,2	11,15	33,1	11,79	33,0	12,43	33,0	12,75	32,9	13,07	32,8	13,7
		-11,8	-13,0	35,2	11,68	35,1	12,27	35,0	12,87	35,0	13,16	34,9	13,5	34,8	14,1
		-9,8	-11,0	37,2	12,11	37,1	12,67	37,0	13,22	37,0	13,5	36,9	13,8	36,8	14,3
		-9,5	-10,0	38,2	12,30	38,1	12,84	38,0	13,4	38,0	13,6	37,9	13,9	37,8	14,4
		-8,5	-9,1	39,1	12,46	39,0	12,98	38,9	13,5	38,8	13,8	38,8	14,0	38,7	14,5
		-7,0	-7,6	40,6	12,69	40,5	13,2	40,4	13,7	40,3	13,9	40,3	14,2	40,2	14,7
		-5,0	-5,6	42,6	12,9	42,5	13,4	42,4	13,9	42,3	14,1	42,3	14,3	42,2	14,8
		-3,0	-3,7	44,5	13,1	44,4	13,6	44,3	14,0	44,2	14,2	44,2	14,5	44,1	14,9
		0,0	-0,7	47,5	13,4	47,4	13,8	47,3	14,2	47,2	14,4	47,2	14,6	47,1	15,0
		3,0	2,2	50,4	13,5	50,3	13,9	50,2	14,3	50,1	14,5	50,1	14,6	50,0	15,0
		5,0	4,1	52,3	13,6	52,2	14,0	52,1	14,3	52,0	14,5	52,0	14,7	51,9	15,0
		7,0	6,0	54,2	13,6	54,1	14,0	54,0	14,3	53,9	14,5	53,9	14,7	52,3	14,4
		9,0	7,9	56,1	13,7	56,0	14,0	55,9	14,3	55,8	14,5	55,8	14,6	52,3	13,6
		11,0	9,8	58,0	13,7	57,9	14,0	57,8	14,3	57,7	14,4	56,1	14,0	52,3	12,8
13,0	11,8	60,0	13,7	59,9	13,9	59,8	14,2	58,1	13,8	56,1	13,2	52,3	12,1		
15,0	13,7	61,9	13,6	61,8	13,9	60,0	13,6	58,1	13,1	56,1	12,5	52,3	11,5		
110	49,50 kW	-19,8	-20,0	28,1	10,44	28,0	11,16	27,9	11,88	27,8	12,24	27,8	12,60	27,7	13,32
		-18,8	-19,0	29,1	10,84	29,0	11,53	28,9	12,22	28,8	12,56	28,8	12,91	28,7	13,60
		-16,7	-17,0	31,1	11,52	31,0	12,16	30,9	12,79	30,8	13,11	30,8	13,43	30,7	14,1
		-13,7	-15,0	33,1	12,08	33,0	12,67	32,9	13,26	32,8	13,55	32,8	13,8	32,7	14,4
		-11,8	-13,0	35,1	12,55	35,0	13,09	34,9	13,6	34,8	13,9	34,8	14,2	34,7	14,7
		-9,8	-11,0	37,1	12,93	37,0	13,4	36,9	13,9	36,8	14,2	36,8	14,4	36,7	15,0
		-9,5	-10,0	38,1	13,09	38,0	13,6	37,9	14,1	37,8	14,3	37,8	14,6	37,7	15,1
		-8,5	-9,1	39,0	13,2	38,9	13,7	38,8	14,2	38,7	14,4	38,7	14,7	38,6	15,1
		-7,0	-7,6	40,5	13,4	40,4	13,9	40,3	14,3	40,2	14,5	40,2	14,8	40,1	15,2
		-5,0	-5,6	42,5	13,6	42,4	14,1	42,3	14,5	42,2	14,7	42,2	14,9	42,1	15,3
		-3,0	-3,7	44,3	13,8	44,2	14,2	44,2	14,6	44,1	14,8	44,1	15,0	44,0	15,4
		0,0	-0,7	47,3	14,0	47,2	14,3	47,1	14,7	47,1	14,9	47,0	15,1	47,0	15,4
		3,0	2,2	50,2	14,1	50,1	14,4	50,0	14,8	50,0	14,9	49,9	15,1	47,9	14,5
		5,0	4,1	52,1	14,1	52,0	14,4	51,9	14,8	51,9	14,9	51,5	14,9	47,9	13,7
		7,0	6,0	54,0	14,1	53,9	14,4	53,8	14,8	53,2	14,7	51,5	14,1	47,9	12,9
		9,0	7,9	55,9	14,1	55,8	14,4	55,0	14,4	53,2	13,9	51,5	13,3	47,9	12,2
		11,0	9,8	57,8	14,1	57,7	14,4	55,0	13,6	53,2	13,1	51,5	12,6	47,9	11,6
13,0	11,8	59,8	14,1	58,5	13,9	55,0	12,9	53,2	12,4	51,5	11,9	47,9	11,0		
15,0	13,7	61,7	14,0	58,5	13,2	55,0	12,2	53,2	11,8	51,5	11,3	47,9	10,4		
100	45,00 kW	-19,8	-20,0	27,9	11,59	27,8	12,25	27,7	12,90	27,7	13,23	27,7	13,55	27,6	14,2
		-18,8	-19,0	28,9	11,94	28,8	12,57	28,7	13,19	28,7	13,51	28,7	13,82	28,6	14,4
		-16,7	-17,0	30,9	12,54	30,8	13,11	30,7	13,69	30,7	14,0	30,7	14,3	30,6	14,8
		-13,7	-15,0	32,9	13,02	32,8	13,56	32,7	14,1	32,7	14,4	32,7	14,6	32,6	15,2
		-11,8	-13,0	34,9	13,42	34,8	13,9	34,7	14,4	34,7	14,7	34,6	14,9	34,6	15,4
		-9,8	-11,0	36,9	13,7	36,8	14,2	36,7	14,7	36,7	14,9	36,6	15,1	36,6	15,6
		-9,5	-10,0	37,9	13,9	37,8	14,3	37,7	14,8	37,7	15,0	37,6	15,2	37,6	15,7
		-8,5	-9,1	38,8	14,0	38,7	14,4	38,6	14,8	38,6	15,1	38,5	15,3	38,5	15,7
		-7,0	-7,6	40,3	14,1	40,2	14,6	40,1	15,0	40,1	15,2	40,0	15,4	39,9	15,8
		-5,0	-5,6	42,3	14,3	42,2	14,7	42,1	15,1	42,1	15,3	42,0	15,5	41,9	15,9
		-3,0	-3,7	44,2	14,4	44,1	14,8	44,0	15,2	44,0	15,3	43,9	15,5	43,6	15,7
		0,0	-0,7	47,2	14,6	47,1	14,9	47,0	15,2	47,0	15,4	46,8	15,5	43,6	14,2
		3,0	2,2	50,1	14,6	50,0	14,9	49,9	15,2	48,4	14,7	46,8	14,1	43,6	13,0
		5,0	4,1	52,0	14,6	51,9	14,9	50,0	14,4	48,4	13,9	46,8	13,3	43,6	12,2
		7,0	6,0	53,9	14,6	53,2	14,7	50,0	13,6	48,4	13,1	46,8	12,6	43,6	11,6
		9,0	7,9	55,8	14,6	53,2	13,9	50,0	12,9	48,4	12,4	46,8	11,9	43,6	11,0
		11,0	9,8	56,4	14,1	53,2	13,1	50,0	12,2	48,4	11,7	46,8	11,3	43,6	10,4
13,0	11,8	56,4	13,3	53,2	12,4	50,0	11,5	48,4	11,1	46,8	10,7	43,6	9,9		
15,0	13,7	56,4	12,6	53,2	11,8	50,0	11,0	48,4	10,5	46,8	10,2	43,6	9,37		

### NOTES - ANMERKUNGEN - Σημειώσεις - NOTAS - REMARQUES - NOTE - OPMERKINGEN - Примечания - NOTLAR

- is shown as reference. When selecting the unit models, avoid the Outdoor air temperature range shown by
- dient als Verweis. Vermeiden Sie bei der Auswahl der Gerätemodelle den als markierten Temperaturbereich der Außenluft
- Η είναι ενδεικτική, κατά την επιλογή των μοντέλων των μονάδων, αποφύγετε το εύρος θερμοκρασίας εξωτερικού αέρα που υποδεικνύεται
- se muestra como referencia. Cuando seleccione los modelos de unidad, evite el intervalo de temperaturas del aire exterior indicado mediante
- est montré comme référence. Lors du choix des modèles d'unités, évitez la plage de températures de l'air extérieur illustré par
- valori riportati unicamente come riferimento. Nel selezionare i modelli delle unità, non considerare i valori di temperatura dell'aria esterna indicati con il colore
- is als referentie getoond. Wanneer modellen van eenheden worden gekozen, vermijd dan het bereik van buitenluchttemperaturen geïllustreerd door
- показан как. При выборе модели устройства избегайте внешнюю температуру

воздуха, указанную в  
referans olarak gösterilmektedir. Ünite modellerini seçerken, belirtilen Dış hava sıcaklığı aralığından kaçının

The above table shows the average value of conditions which may occur.  
Die obige Tabelle zeigt den Durchschnittswert der Bedingungen, die auftreten können.  
Στον παραπάνω πίνακα αναγράφεται η μέση τιμή για συνθήκες που μπορεί να προκύψουν.  
La tabla de arriba muestra el valor medio de condiciones que pueden ocurrir.  
Le tableau ci-dessus donne la valeur moyenne pour des conditions qui peuvent survenir.  
La tabella in alto mostra il valore delle condizioni medie che si possono riscontrare.  
De tabel hierboven geeft de gemiddelde waarde aan van situaties die kunnen voorvallen.  
Таблица расположенная выше показывает среднее значение условий, которые могут наступить.  
Yukarıdaki tablo meydana gelebilecek koşulların ortalama değerini göstermektedir.

# 5 Capacity tables

## 5 - 2 Heating Capacity Tables

5

RQYQ16PY1

TC: Total Capacity: kW ; PI: Power Input: kW (compressor + outdoor fan motor)

Combination (%)	Capacity index (kW)	Outdoor air temp.		Indoor air temperature: °CDB											
				16.0		18.0		20.0		21.0		22.0		24.0	
				TC	PI	TC	PI	TC	PI	TC	PI	TC	PI	TC	PI
90%	40,50 kW	-19,8	-20,0	27,8	12,74	27,7	13,33	27,6	13,92	27,6	14,2	27,5	14,5	27,5	15,1
		-18,8	-19,0	28,8	13,04	28,7	13,60	28,6	14,2	28,6	14,4	28,5	14,7	28,5	15,3
		-16,7	-17,0	30,8	13,55	30,7	14,1	30,6	14,6	30,6	14,8	30,5	15,1	30,4	15,6
		-13,7	-15,0	32,8	14,0	32,7	14,4	32,6	14,9	32,6	15,2	32,5	15,4	32,4	15,9
		-11,8	-13,0	34,8	14,3	34,7	14,7	34,6	15,2	34,6	15,4	34,5	15,6	34,4	16,1
		-9,8	-11,0	36,8	14,5	36,7	15,0	36,6	15,4	36,6	15,6	36,5	15,8	36,4	16,2
		-9,5	-10,0	37,8	14,7	37,7	15,1	37,6	15,5	37,6	15,7	37,5	15,9	37,4	16,3
		-8,5	-9,1	38,6	14,7	38,6	15,1	38,5	15,5	38,5	15,7	38,4	15,9	38,3	16,3
		-7,0	-7,6	40,1	14,9	40,1	15,2	40,0	15,6	39,9	15,8	39,9	16,0	39,2	16,0
		-5,0	-5,6	42,1	15,0	42,1	15,3	42,0	15,7	41,9	15,9	41,9	16,0	39,2	14,8
		-3,0	-3,7	44,0	15,1	44,0	15,4	43,9	15,7	43,6	15,7	42,1	15,1	39,2	13,9
		0,0	-0,7	47,0	15,1	47,0	15,5	45,0	14,8	43,6	14,2	42,1	13,7	39,2	12,6
		3,0	2,2	49,9	15,2	47,9	14,5	45,0	13,5	43,6	13,0	42,1	12,5	39,2	11,5
		5,0	4,1	50,8	14,7	47,9	13,7	45,0	12,7	43,6	12,2	42,1	11,8	39,2	10,8
		7,0	6,0	50,8	13,9	47,9	12,9	45,0	12,0	43,6	11,6	42,1	11,1	39,2	10,3
		9,0	7,9	50,8	13,1	47,9	12,2	45,0	11,4	43,6	11,0	42,1	10,5	39,2	9,73
		11,0	9,8	50,8	12,4	47,9	11,6	45,0	10,8	43,6	10,4	42,1	10,0	39,2	9,24
		13,0	11,8	50,8	11,7	47,9	11,0	45,0	10,2	43,6	9,8	42,1	9,48	39,2	8,76
		15,0	13,7	50,8	11,2	47,9	10,4	45,0	9,7	43,6	9,37	42,1	9,02	39,2	8,35
		80%	36,00 kW	-19,8	-20,0	27,6	13,89	27,5	14,4	27,5	14,9	27,4	15,2	27,4	15,5
-18,8	-19,0			28,6	14,1	28,5	14,6	28,5	15,1	28,4	15,4	28,4	15,6	28,3	16,1
-16,7	-17,0			30,6	14,6	30,5	15,0	30,5	15,5	30,4	15,7	30,4	15,9	30,3	16,4
-13,7	-15,0			32,6	14,9	32,5	15,3	32,5	15,8	32,4	16,0	32,4	16,2	32,3	16,6
-11,8	-13,0			34,6	15,2	34,5	15,6	34,5	16,0	34,4	16,2	34,4	16,3	34,3	16,7
-9,8	-11,0			36,6	15,4	36,5	15,7	36,5	16,1	36,4	16,3	36,4	16,5	36,3	16,8
-9,5	-10,0			37,6	15,4	37,5	15,8	37,5	16,2	37,4	16,3	37,4	16,5	37,3	16,8
-8,5	-9,1			38,5	15,5	38,4	15,9	38,4	16,2	38,3	16,4	38,3	16,6	38,2	16,9
-7,0	-7,6			40,0	15,6	39,9	15,9	39,9	16,2	38,7	15,7	37,4	15,1	34,9	13,9
-5,0	-5,6			42,0	15,7	41,9	16,0	40,0	15,2	38,7	14,6	37,4	14,0	34,9	12,9
-3,0	-3,7			43,9	15,7	42,6	15,3	40,0	14,2	38,7	13,7	37,4	13,1	34,9	12,1
0,0	-0,7			45,1	14,8	42,6	13,8	40,0	12,9	38,7	12,4	37,4	11,9	34,9	11,0
3,0	2,2			45,1	13,5	42,6	12,6	40,0	11,7	38,7	11,3	37,4	10,9	34,9	10,05
5,0	4,1			45,1	12,8	42,6	11,9	40,0	11,1	38,7	10,7	37,4	10,29	34,9	9,50
7,0	6,0			45,1	12,1	42,6	11,3	40,0	10,5	38,7	10,11	37,4	9,74	34,9	9,01
9,0	7,9			45,1	11,4	42,6	10,7	40,0	9,95	38,7	9,99	37,4	9,24	34,9	8,55
11,0	9,8			45,1	10,8	42,6	10,1	40,0	9,44	38,7	9,11	37,4	8,78	34,9	8,13
13,0	11,8			45,1	10,3	42,6	9,60	40,0	8,96	38,7	8,64	37,4	8,33	34,9	7,72
15,0	13,7			45,1	9,7	42,6	9,13	40,0	8,53	38,7	8,23	37,4	7,94	34,9	7,36
70%	31,50 kW			-19,8	-20,0	27,5	15,0	27,4	15,5	27,3	16,0	27,3	16,2	27,3	16,4
		-18,8	-19,0	28,5	15,2	28,4	15,7	28,3	16,1	28,3	16,3	28,3	16,6	28,2	17,0
		-16,7	-17,0	30,5	15,6	30,4	16,0	30,3	16,4	30,3	16,6	30,3	16,8	30,2	17,2
		-13,7	-15,0	32,5	15,8	32,4	16,2	32,3	16,6	32,3	16,8	32,3	17,0	30,5	15,9
		-11,8	-13,0	34,4	16,0	34,4	16,4	34,3	16,7	33,9	16,6	32,8	15,9	30,5	14,6
		-9,8	-11,0	36,4	16,2	36,4	16,5	35,0	15,9	33,9	15,3	32,8	14,7	30,5	13,5
		-9,5	-10,0	37,4	16,2	37,2	16,4	35,0	15,3	33,9	14,7	32,8	14,1	30,5	13,0
		-8,5	-9,1	38,3	16,3	37,2	15,9	35,0	14,7	33,9	14,2	32,8	13,6	30,5	12,5
		-7,0	-7,6	39,5	16,1	37,2	15,0	35,0	13,9	33,9	13,4	32,8	12,9	30,5	11,9
		-5,0	-5,6	39,5	15,0	37,2	13,9	35,0	13,0	33,9	12,5	32,8	12,0	30,5	11,08
		-3,0	-3,7	39,5	14,0	37,2	13,1	35,0	12,2	33,9	11,7	32,8	11,3	30,5	10,40
		0,0	-0,7	39,5	12,7	37,2	11,8	35,0	11,0	33,9	10,63	32,8	10,23	30,5	9,46
		3,0	2,2	39,5	11,6	37,2	10,8	35,0	10,09	33,9	9,73	32,8	9,38	30,5	8,68
		5,0	4,1	39,5	10,9	37,2	10,23	35,0	9,55	33,9	9,21	32,8	8,88	30,5	8,23
		7,0	6,0	39,5	10,3	37,2	9,69	35,0	9,05	33,9	8,73	32,8	8,42	30,5	7,81
		9,0	7,9	39,5	9,81	37,2	9,19	35,0	8,59	33,9	8,29	32,8	8,00	30,5	7,42
		11,0	9,8	39,5	9,31	37,2	8,73	35,0	8,17	33,9	7,89	32,8	7,61	30,5	7,07
		13,0	11,8	39,5	8,83	37,2	8,29	35,0	7,75	33,9	7,49	32,8	7,23	30,5	6,72
		15,0	13,7	39,5	8,41	37,2	7,90	35,0	7,39	33,9	7,14	32,8	6,90	30,5	6,41
		60%	27,00 kW	-19,8	-20,0	27,3	16,2	27,3	16,6	27,2	17,0	27,2	17,2	27,1	17,4
-18,8	-19,0			28,3	16,3	28,3	16,7	28,2	17,1	28,2	17,3	28,1	17,4	26,1	16,0
-16,7	-17,0			30,3	16,6	30,2	16,9	30,0	17,1	29,0	16,4	28,1	15,8	26,1	14,5
-13,7	-15,0			32,3	16,8	31,9	16,8	30,0	15,6	29,0	15,0	28,1	14,4	26,1	13,3
-11,8	-13,0			33,9	16,6	31,9	15,4	30,0	14,3	29,0	13,8	28,1	13,3	26,1	12,2
-9,8	-11,0			33,9	15,3	31,9	14,2	30,0	13,2	29,0	12,7	28,1	12,3	26,1	11,31
-9,5	-10,0			33,9	14,7	31,9	13,7	30,0	12,7	29,0	12,3	28,1	11,8	26,1	10,89
-8,5	-9,1			33,9	14,2	31,9	13,2	30,0	12,3	29,0	11,9	28,1	11,4	26,1	10,54
-7,0	-7,6			33,9	13,4	31,9	12,5	30,0	11,7	29,0	11,23	28,1	10,82	26,1	10,00
-5,0	-5,6			33,9	12,5	31,9	11,7	30,0	10,87	29,0	10,49	28,1	10,10	26,1	9,35
-3,0	-3,7			33,9	11,7	31,9	10,95	30,0	10,21	29,0	9,85	28,1	9,49	26,1	8,80
0,0	-0,7			33,9	10,62	31,9	9,95	30,0	9,29	29,0	8,97	28,1	8,65	26,1	8,03
3,0	2,2			33,9	9,73	31,9	9,12	30,0	8,53	29,0	8,24	28,1	7,95	26,1	7,39
5,0	4,1			33,9	9,20	31,9	8,64	30,0	8,08	29,0	7,81	28,1	7,54	26,1	7,01
7,0	6,0			33,9	8,73	31,9	8,20	30,0	7,67	29,0	7,42	28,1	7,16	26,1	6,66
9,0	7,9			33,9	8,29	31,9	7,79	30,0	7,30	29,0	7,05	28,1	6,82	26,1	6,35
11,0	9,8			33,9	7,88	31,9	7,41	30,0	6,95	29,0	6,72	28,1	6,49	26,1	6,05
13,0	11,8			33,9	7,49	31,9	7,04	30,0	6,61	29,0	6,39	28,1	6,18	26,1	5,76
15,0	13,7			33,9	7,14	31,9	6,72	30,0	6,31	29,0	6,11	28,1	5,90	26,1	5,51
50%	22,50 kW			-19,8	-20,0	27,2	17,3	26,6	17,2	25,0	15,9	24,2	15,3	23,4	14,7
		-18,8	-19,0	28,2	17,4	26,6	16,3	25,0	15,1	24,2	14,6	23,4	14,0	21,8	12,9
		-16,7	-17,0	28,2	15,9	26,6	14,8	25,0	13,8	24,2	13,3	23,4	12,8	21,8	11,78
		-13,7	-15,0	28,2	14,5	26,6	13,6	25,0	12,6	24,2	12,2	23,4	11,70	21,8	10,81
		-11,8	-13,0	28,2	13,3	26,6	12,5	25,0	11,62	24,2	11,21	23,4	10,79	21,8	9,99
		-9,8	-11,0	28,2	12,3	26,6	11,5	25,0	10,76	24,2	10,38	23,4	10,00	21,8	9,27
		-9,5	-10,0	28,2	11,9	26,6	11,11	25,0	10,37	24,2	10,01	23,4	9,65	21,8	8,94
		-8,5	-9,1	28,2	11,5	26,6	10,75	25,0	10,04	24,2	9,69	23,4	9,34	21,8	8,66
		-7,0	-7,6	28,2	10,88	26,6	10,20	25,0	9,53	24,2	9,20	23,4	8,87	21,8	8,23
		-5,0	-5,6	28,2	10,16	26,6	9,53	25,0	8,91	24,2	8,61	23,4	8,31	21,8	7,72
		-3,0	-3,7	28,2	9,55	26,6	8,96	25,0	8,39	24,2	8,11	23,4	7,83	21,8	7,28
		0,0	-0,7	28,2	8,70	26,6	8,18	25,0	7,66						



# 5 Capacity tables

## 5 - 2 Heating Capacity Tables

**RQYQ18PY1**

TC: Total Capacity: kW ; PI: Power Input: kW (compressor + outdoor fan motor)

Combination (%)	Capacity index (kW)	Outdoor air temp.		Indoor air temperature: °CDB											
				16.0		18.0		20.0		21.0		22.0		24.0	
				TC	PI	TC	PI	TC	PI	TC	PI	TC	PI	TC	PI
130	65,52 kW	-19,8	-20,0	24,2	2,25	24,1	3,26	23,9	4,28	23,9	4,78	23,8	5,29	23,7	6,3
		-18,8	-19,0	25,4	3,19	25,3	4,15	25,2	5,11	25,1	5,59	25,0	6,1	24,9	7,0
		-16,7	-17,0	27,9	4,82	27,7	5,69	27,6	6,56	27,5	7,0	27,5	7,4	27,4	8,3
		-13,7	-15,0	30,4	6,18	30,2	6,97	30,1	7,8	30,0	8,2	30,0	8,6	29,8	9,4
		-11,8	-13,0	32,9	7,33	32,7	8,1	32,6	8,8	32,5	9,1	32,5	9,5	32,4	10,2
		-9,8	-11,0	35,4	8,3	35,3	9,0	35,2	9,7	35,1	10,0	35,0	10,3	34,9	11,0
		-9,5	-10,0	36,7	8,8	36,6	9,4	36,4	10,1	36,4	10,4	36,3	10,7	36,2	11,4
		-8,5	-9,1	37,9	9,1	37,7	9,8	37,6	10,4	37,5	10,7	37,5	11,0	37,3	11,6
		-7,0	-7,6	39,8	9,7	39,7	10,3	39,5	10,9	39,5	11,2	39,4	11,5	39,3	12,1
		-5,0	-5,6	42,4	10,4	42,3	11,0	42,2	11,5	42,1	11,8	42,0	12,1	41,9	12,6
		-3,0	-3,7	44,9	11,0	44,8	11,5	44,7	12,0	44,6	12,3	44,5	12,6	44,4	13,1
		0,0	-0,7	48,9	11,8	48,8	12,3	48,7	12,8	48,6	13,0	48,5	13,2	48,4	13,7
		3,0	2,2	52,9	12,5	52,7	12,9	52,6	13,3	52,5	13,6	52,5	13,8	52,3	14,2
		5,0	4,1	55,5	12,9	55,3	13,3	55,2	13,7	55,1	13,9	55,1	14,1	54,9	14,5
		7,0	6,0	58,1	13,2	58,0	13,6	57,8	14,0	57,8	14,2	57,7	14,4	57,6	14,8
		9,0	7,9	60,8	13,5	60,6	13,9	60,5	14,3	60,4	14,5	60,4	14,7	60,2	15,1
		11,0	9,8	63,4	13,8	63,3	14,2	63,2	14,6	63,1	14,8	63,0	15,0	62,9	15,3
13,0	11,8	66,3	14,1	66,1	14,5	66,0	14,9	66,0	15,0	65,9	15,2	64,0	14,9		
15,0	13,7	69,0	14,4	68,9	14,7	68,7	15,1	68,7	15,3	68,6	15,4	64,0	14,2		
120	60,48 kW	-19,8	-20,0	24,0	3,62	23,9	4,56	23,8	5,49	23,7	6,0	23,7	6,4	23,5	7,4
		-18,8	-19,0	25,2	4,49	25,1	5,38	25,0	6,3	24,9	6,7	24,9	7,2	24,8	8,0
		-16,7	-17,0	27,7	5,99	27,6	6,8	27,5	7,6	27,4	8,0	27,3	8,4	27,2	9,2
		-13,7	-15,0	30,2	7,2	30,1	8,0	29,9	8,7	29,9	9,1	29,8	9,4	29,7	10,2
		-11,8	-13,0	32,7	8,3	32,6	9,0	32,5	9,7	32,4	10,0	32,3	10,3	32,2	11,0
		-9,8	-11,0	35,2	9,2	35,1	9,8	35,0	10,5	34,9	10,8	34,9	11,1	34,8	11,7
		-9,5	-10,0	36,5	9,6	36,4	10,2	36,3	10,8	36,2	11,1	36,2	11,4	36,0	12,0
		-8,5	-9,1	37,7	10,0	37,6	10,6	37,4	11,1	37,4	11,4	37,3	11,7	37,2	12,3
		-7,0	-7,6	39,6	10,5	39,5	11,1	39,4	11,6	39,3	11,9	39,3	12,2	39,1	12,7
		-5,0	-5,6	42,2	11,2	42,1	11,7	42,0	12,2	41,9	12,4	41,9	12,7	41,8	13,2
		-3,0	-3,7	44,7	11,7	44,6	12,2	44,5	12,7	44,4	12,9	44,4	13,1	44,3	13,6
		0,0	-0,7	48,8	12,4	48,6	12,9	48,5	13,3	48,5	13,5	48,4	13,8	48,3	14,2
		3,0	2,2	52,7	13,1	52,6	13,5	52,4	13,9	52,4	14,1	52,3	14,3	52,2	14,7
		5,0	4,1	55,3	13,4	55,2	13,8	55,1	14,2	55,0	14,4	54,9	14,6	54,8	15,0
		7,0	6,0	57,9	13,8	57,8	14,1	57,7	14,5	57,6	14,7	57,6	14,9	57,4	15,2
		9,0	7,9	60,6	14,1	60,5	14,4	60,3	14,8	60,3	15,0	60,2	15,1	59,1	15,1
		11,0	9,8	63,3	14,3	63,1	14,7	63,0	15,0	63,0	15,2	62,9	15,4	59,1	14,3
13,0	11,8	66,1	14,6	66,0	14,9	65,9	15,3	65,9	15,4	63,4	14,8	59,1	13,6		
15,0	13,7	68,8	14,9	68,7	15,2	68,6	15,5	68,6	15,6	63,4	14,1	59,1	12,9		
110	55,44 kW	-19,8	-20,0	23,8	4,99	23,7	5,8	23,6	6,7	23,6	7,1	23,5	7,6	23,4	8,4
		-18,8	-19,0	25,1	5,79	25,0	6,6	24,8	7,4	24,8	7,8	24,7	8,2	24,6	9,0
		-16,7	-17,0	27,5	7,2	27,4	7,9	27,3	8,6	27,2	9,0	27,2	9,4	27,1	10,1
		-13,7	-15,0	30,0	8,3	29,9	9,0	29,8	9,7	29,7	10,0	29,7	10,3	29,6	11,0
		-11,8	-13,0	32,5	9,3	32,4	9,9	32,3	10,5	32,2	10,8	32,2	11,1	32,1	11,8
		-9,8	-11,0	35,1	10,1	35,0	10,7	34,8	11,3	34,8	11,6	34,7	11,8	34,6	12,4
		-9,5	-10,0	36,3	10,5	36,2	11,1	36,1	11,6	36,1	11,9	36,0	12,2	35,9	12,7
		-8,5	-9,1	37,5	10,8	37,4	11,4	37,3	11,9	37,2	12,2	37,2	12,4	37,1	13,0
		-7,0	-7,6	39,4	11,3	39,3	11,8	39,2	12,3	39,2	12,6	39,1	12,8	39,0	13,3
		-5,0	-5,6	42,1	11,9	42,0	12,4	41,8	12,9	41,8	13,1	41,7	13,3	41,6	13,8
		-3,0	-3,7	44,6	12,4	44,5	12,8	44,3	13,3	44,3	13,5	44,2	13,7	44,1	14,2
		0,0	-0,7	48,6	13,1	48,5	13,5	48,4	13,9	48,3	14,1	48,2	14,3	48,1	14,7
		3,0	2,2	52,5	13,7	52,4	14,0	52,3	14,4	52,2	14,6	52,2	14,8	52,1	15,2
		5,0	4,1	55,1	14,0	55,0	14,4	54,9	14,7	54,8	14,9	54,8	15,1	54,2	15,2
		7,0	6,0	57,7	14,3	57,6	14,6	57,5	15,0	57,5	15,2	57,4	15,3	54,2	14,4
		9,0	7,9	60,4	14,6	60,3	14,9	60,2	15,2	60,1	15,4	58,2	14,8	54,2	13,6
		11,0	9,8	63,1	14,8	63,0	15,2	62,2	15,2	60,2	14,6	58,2	14,0	54,2	12,9
13,0	11,8	65,9	15,1	65,8	15,4	62,2	14,4	60,2	13,9	58,2	13,3	54,2	12,3		
15,0	13,7	68,7	15,3	68,1	14,8	62,2	13,7	60,2	13,2	58,2	12,7	54,2	11,7		
100	50,40 kW	-19,8	-20,0	23,7	6,4	23,6	7,1	23,5	7,9	23,4	8,3	23,4	8,7	23,3	9,5
		-18,8	-19,0	24,9	7,1	24,8	7,8	24,7	8,6	24,6	8,9	24,6	9,3	24,5	10,0
		-16,7	-17,0	27,3	8,3	27,2	9,0	27,1	9,7	27,1	10,0	27,0	10,4	26,9	11,0
		-13,7	-15,0	29,8	9,4	29,7	10,0	29,6	10,6	29,6	10,9	29,5	11,2	29,4	11,8
		-11,8	-13,0	32,3	10,3	32,2	10,8	32,1	11,4	32,1	11,7	32,1	12,0	32,0	12,5
		-9,8	-11,0	34,9	11,0	34,8	11,6	34,7	12,1	34,6	12,3	34,6	12,6	34,5	13,1
		-9,5	-10,0	36,2	11,4	36,1	11,9	36,0	12,4	35,9	12,6	35,9	12,9	35,8	13,4
		-8,5	-9,1	37,3	11,7	37,2	12,2	37,1	12,6	37,1	12,9	37,0	13,1	36,9	13,6
		-7,0	-7,6	39,3	12,1	39,2	12,6	39,1	13,0	39,0	13,3	39,0	13,5	38,9	14,0
		-5,0	-5,6	41,9	12,7	41,8	13,1	41,7	13,5	41,6	13,7	41,6	13,9	41,5	14,4
		-3,0	-3,7	44,4	13,1	44,3	13,5	44,2	13,9	44,1	14,1	44,1	14,3	44,0	14,7
		0,0	-0,7	48,4	13,7	48,3	14,1	48,2	14,5	48,2	14,7	48,1	14,8	48,0	15,2
		3,0	2,2	52,3	14,3	52,2	14,6	52,1	14,9	52,1	15,1	52,0	15,3	49,2	14,4
		5,0	4,1	54,9	14,6	54,8	14,9	54,7	15,2	54,7	15,4	52,9	14,8	49,2	13,6
		7,0	6,0	57,6	14,8	57,5	15,2	56,5	15,1	54,7	14,5	52,9	14,0	49,2	12,8
		9,0	7,9	60,2	15,1	60,1	15,4	56,5	14,3	54,7	13,8	52,9	13,2	49,2	12,2
		11,0	9,8	62,9	15,3	60,1	14,6	56,5	13,6	54,7	13,1	52,9	12,6	49,2	11,6
13,0	11,8	63,8	14,9	60,1	13,9	56,5	12,9	54,7	12,4	52,9	11,9	49,2	11,0		
15,0	13,7	63,8	14,1	60,1	13,2	56,5	12,3	54,7	11,8	52,9	11,4	49,2	10,5		

**NOTES - ANMERKUNGEN - Σημειώσεις - NOTAS - REMARQUES - NOTE - OPMERKINGEN - Примечания - NOTLAR**

is shown as reference. When selecting the unit models, avoid the Outdoor air temperature range shown by

dient als Verweis. Vermeiden Sie bei der Auswahl der Gerätemodelle den als markierten Temperaturbereich der Außenluft

Η είναι ενδεικτική, κατά την επιλογή των μοντέλων των μονάδων, αποφύγετε το εύρος θερμοκρασίας εξωτερικού αέρα που υποδεικνύεται

se muestra como referencia. Cuando seleccione los modelos de unidad, evite el intervalo de temperaturas del aire exterior indicado mediante

est montré comme référence. Lors du choix des modèles d'unités, évitez la plage de températures de l'air extérieur illustré par

valori riportati unicamente come riferimento. Nel selezionare i modelli delle unità, non considerare i valori di temperatura dell'aria esterna indicati con il colore

is als referentie getoond. Wanneer modellen van eenheden worden gekozen, vermijd dan het bereik van buitenluchttemperaturen geïllustreerd door

показан как. При выборе модели устройства избегайте внешнюю температуру

воздуха, указанную в

referans olarak gösterilmektedir. Ünite modellerini seçerken, belirtilen Dış hava sıcaklığı aralığından kaçınm

The above table shows the average value of conditions which may occur.

Die obige Tabelle zeigt den Durchschnittswert der Bedingungen, die auftreten können.

Στον παραπάνω πίνακα αναγράφεται η μέση τιμή για συνθήκες που μπορεί να προκύψουν.

La tabla de arriba muestra el valor medio de condiciones que pueden ocurrir.

Le tableau ci-dessus donne la valeur moyenne pour des conditions qui peuvent survenir.

La tabella in alto mostra il valore delle condizioni medie che si possono riscontrare.

De tabel hierboven geeft de gemiddelde waarde aan van situaties die kunnen voorvallen.

Таблица расположенная выше показывает среднее значение условий, которые могут наступить.

Yukarıdaki tablo meydana gelebilecek koşulların ortalama değerini göstermektedir.

# 5 Capacity tables

## 5 - 2 Heating Capacity Tables

5

RQYQ18PY1		TC: Total Capacity: kW ; PI: Power Input: kW (compressor + outdoor fan motor)													
Combination (%)	Capacity index (kW)	Outdoor air temp.		Indoor air temperature: °CDB											
				16.0		18.0		20.0		21.0		22.0		24.0	
				TC	PI	TC	PI	TC	PI	TC	PI	TC	PI	TC	PI
90%	45,36 kW	-19,8	-20,0	23,5	7,7	23,4	8,4	23,3	9,1	23,3	9,5	23,2	9,8	23,1	10,5
		-18,8	-19,0	24,7	8,4	24,6	9,1	24,5	9,7	24,5	10,1	24,4	10,4	24,4	11,1
		-16,7	-17,0	27,2	9,5	27,1	10,1	27,0	10,7	26,9	11,0	26,9	11,3	26,8	11,9
		-13,7	-15,0	29,7	10,5	29,6	11,0	29,5	11,6	29,4	11,8	29,4	12,1	29,3	12,7
		-11,8	-13,0	32,2	11,3	32,1	11,8	32,0	12,3	32,0	12,5	31,9	12,8	31,8	13,3
		-9,8	-11,0	34,7	12,0	34,6	12,4	34,5	12,9	34,5	13,1	34,4	13,4	34,4	13,8
		-9,5	-10,0	36,0	12,3	35,9	12,7	35,8	13,2	35,8	13,4	35,7	13,6	35,6	14,1
		-8,5	-9,1	37,2	12,5	37,1	13,0	37,0	13,4	36,9	13,6	36,9	13,8	36,8	14,3
		-7,0	-7,6	39,1	12,9	39,0	13,3	38,9	13,8	38,9	14,0	38,8	14,2	38,7	14,6
		-5,0	-5,6	41,7	13,4	41,6	13,8	41,5	14,2	41,5	14,4	41,4	14,6	41,4	15,0
		-3,0	-3,7	44,2	13,8	44,1	14,2	44,0	14,5	44,0	14,7	44,0	14,9	43,9	15,3
		0,0	-0,7	48,2	14,4	48,1	14,7	48,0	15,1	48,0	15,2	47,6	15,2	44,3	14,0
		3,0	2,2	52,2	14,9	52,1	15,2	50,9	15,0	49,2	14,4	47,6	13,8	44,3	12,7
		5,0	4,1	54,8	15,1	54,1	15,2	50,9	14,1	49,2	13,6	47,6	13,0	44,3	12,0
		7,0	6,0	57,4	15,4	54,1	14,3	50,9	13,3	49,2	12,8	47,6	12,4	44,3	11,4
		9,0	7,9	57,4	14,6	54,1	13,6	50,9	12,6	49,2	12,2	47,6	11,7	44,3	10,8
		11,0	9,8	57,4	13,8	54,1	12,9	50,9	12,0	49,2	11,6	47,6	11,2	44,3	10,3
		13,0	11,8	57,4	13,1	54,1	12,3	50,9	11,4	49,2	11,0	47,6	10,6	44,3	9,8
		15,0	13,7	57,4	12,5	54,1	11,7	50,9	10,9	49,2	10,5	47,6	10,1	44,3	9,39
		80%	40,32 kW	-19,8	-20,0	23,3	9,1	23,2	9,7	23,2	10,4	23,1	10,7	23,1	11,0
-18,8	-19,0			24,5	9,7	24,5	10,3	24,4	10,9	24,3	11,2	24,3	11,5	24,2	12,1
-16,7	-17,0			27,0	10,7	26,9	11,2	26,8	11,8	26,8	12,0	26,8	12,3	26,7	12,8
-13,7	-15,0			29,5	11,5	29,4	12,0	29,3	12,5	29,3	12,8	29,2	13,0	29,2	13,5
-11,8	-13,0			32,0	12,3	31,9	12,7	31,8	13,2	31,8	13,4	31,8	13,6	31,7	14,0
-9,8	-11,0			34,5	12,9	34,5	13,3	34,4	13,7	34,3	13,9	34,3	14,1	34,2	14,5
-9,5	-10,0			35,8	13,1	35,7	13,5	35,7	13,9	35,6	14,1	35,6	14,3	35,5	14,7
-8,5	-9,1			37,0	13,4	36,9	13,8	36,8	14,1	36,8	14,3	36,7	14,5	36,7	14,9
-7,0	-7,6			38,9	13,7	38,8	14,1	38,8	14,5	38,7	14,7	38,7	14,8	38,6	15,2
-5,0	-5,6			41,5	14,2	41,5	14,5	41,4	14,9	41,3	15,0	41,3	15,2	39,4	14,5
-3,0	-3,7			44,0	14,5	44,0	14,9	43,9	15,2	43,7	15,3	43,7	15,3	39,4	13,5
0,0	-0,7			48,1	15,0	48,0	15,3	45,2	14,3	43,7	13,8	42,3	13,2	39,4	12,2
3,0	2,2			51,0	15,0	48,1	14,0	45,2	13,0	43,7	12,5	42,3	12,1	39,4	11,1
5,0	4,1			51,0	14,2	48,1	13,2	45,2	12,3	43,7	11,8	42,3	11,4	39,4	10,5
7,0	6,0			51,0	13,4	48,1	12,5	45,2	11,7	43,7	11,2	42,3	10,8	39,4	10,0
9,0	7,9			51,0	12,7	48,1	11,9	45,2	11,1	43,7	10,7	42,3	10,3	39,4	9,52
11,0	9,8			51,0	12,1	48,1	11,3	45,2	10,5	43,7	10,2	42,3	9,8	39,4	9,08
13,0	11,8			51,0	11,5	48,1	10,7	45,2	10,0	43,7	9,7	42,3	9,34	39,4	8,66
15,0	13,7			51,0	11,0	48,1	10,3	45,2	9,6	43,7	9,27	42,3	8,94	39,4	8,30
70%	35,28 kW			-19,8	-20,0	23,1	10,5	23,1	11,0	23,0	11,6	23,0	11,8	22,9	12,1
		-18,8	-19,0	24,4	11,0	24,3	11,5	24,2	12,0	24,2	12,3	24,2	12,5	24,1	13,1
		-16,7	-17,0	26,8	11,9	26,8	12,3	26,7	12,8	26,6	13,0	26,6	13,3	26,5	13,7
		-13,7	-15,0	29,3	12,6	29,2	13,0	29,2	13,5	29,1	13,7	29,1	13,9	29,0	14,3
		-11,8	-13,0	31,8	13,2	31,8	13,6	31,7	14,0	31,7	14,2	31,6	14,4	31,5	14,8
		-9,8	-11,0	34,4	13,8	34,3	14,1	34,2	14,5	34,2	14,7	34,2	14,9	34,1	15,2
		-9,5	-10,0	35,6	14,0	35,6	14,4	35,5	14,7	35,5	14,9	35,4	15,1	34,5	14,8
		-8,5	-9,1	36,8	14,2	36,7	14,6	36,7	14,9	36,6	15,1	36,6	15,2	34,5	14,2
		-7,0	-7,6	38,7	14,5	38,7	14,9	38,6	15,2	38,3	15,2	37,0	14,6	34,5	13,4
		-5,0	-5,6	41,4	14,9	41,3	15,2	39,6	14,6	38,3	14,0	37,0	13,5	34,5	12,4
		-3,0	-3,7	43,9	15,2	42,1	14,6	39,6	13,6	38,3	13,1	37,0	12,6	34,5	11,6
		0,0	-0,7	44,6	14,1	42,1	13,2	39,6	12,2	38,3	11,8	37,0	11,4	34,5	10,49
		3,0	2,2	44,6	12,8	42,1	12,0	39,6	11,2	38,3	10,8	37,0	10,4	34,5	9,61
		5,0	4,1	44,6	12,1	42,1	11,3	39,6	10,6	38,3	10,2	37,0	9,84	34,5	9,12
		7,0	6,0	44,6	11,5	42,1	10,8	39,6	10,0	38,3	9,70	37,0	9,35	34,5	8,67
		9,0	7,9	44,6	10,9	42,1	10,2	39,6	9,56	38,3	9,23	37,0	8,91	34,5	8,27
		11,0	9,8	44,6	10,4	42,1	9,7	39,6	9,12	38,3	8,81	37,0	8,50	34,5	7,90
		13,0	11,8	44,6	9,9	42,1	9,29	39,6	8,70	38,3	8,40	37,0	8,12	34,5	7,55
		15,0	13,7	44,6	9,5	42,1	8,89	39,6	8,33	38,3	8,06	37,0	7,78	34,5	7,24
		60%	30,24 kW	-19,8	-20,0	23,0	11,8	22,9	12,3	22,8	12,8	22,8	13,0	22,8	13,3
-18,8	-19,0			24,2	12,3	24,1	12,7	24,1	13,2	24,0	13,4	24,0	13,6	23,9	14,1
-16,7	-17,0			26,6	13,0	26,6	13,4	26,5	13,9	26,5	14,1	26,5	14,3	26,4	14,7
-13,7	-15,0			29,1	13,7	29,1	14,1	29,0	14,4	29,0	14,6	29,0	14,8	28,9	15,1
-11,8	-13,0			31,7	14,2	31,6	14,6	31,5	14,9	31,5	15,1	31,5	15,2	29,5	14,2
-9,8	-11,0			34,2	14,7	34,1	15,0	33,9	15,2	32,8	14,6	31,7	14,0	29,5	12,9
-9,5	-10,0			35,5	14,9	35,4	15,2	33,9	14,5	32,8	14,0	31,7	13,4	29,5	12,4
-8,5	-9,1			36,6	15,1	36,1	15,0	33,9	14,0	32,8	13,4	31,7	12,9	29,5	11,9
-7,0	-7,6			38,3	15,2	36,1	14,1	33,9	13,1	32,8	12,7	31,7	12,2	29,5	11,23
-5,0	-5,6			38,3	14,0	36,1	13,1	33,9	12,2	32,8	11,7	31,7	11,3	29,5	10,43
-3,0	-3,7			38,3	13,1	36,1	12,2	33,9	11,4	32,8	10,96	31,7	10,56	29,5	9,77
0,0	-0,7			38,3	11,8	36,1	11,0	33,9	10,30	32,8	9,94	31,7	9,58	29,5	8,88
3,0	2,2			38,3	10,8	36,1	10,10	33,9	9,44	32,8	9,12	31,7	8,80	29,5	8,17
5,0	4,1			38,3	10,2	36,1	9,57	33,9	8,96	32,8	8,65	31,7	8,35	29,5	7,76
7,0	6,0			38,3	9,69	36,1	9,10	33,9	8,52	32,8	8,24	31,7	7,95	29,5	7,40
9,0	7,9			38,3	9,22	36,1	8,67	33,9	8,12	32,8	7,86	31,7	7,59	29,5	7,07
11,0	9,8			38,3	8,80	36,1	8,28	33,9	7,77	32,8	7,51	31,7	7,26	29,5	6,77
13,0	11,8			38,3	8,40	36,1	7,91	33,9	7,42	32,8	7,18	31,7	6,95	29,5	6,48
15,0	13,7			38,3	8,05	36,1	7,58	33,9	7,12	32,8	6,90	31,7	6,67	29,5	6,23
50%	25,20 kW			-19,8	-20,0	22,8	13,2	22,7	13,6	22,7	14,0	22,7	14,2	22,6	14,4
		-18,8	-19,0	24,0	13,6	24,0	14,0	23,9	14,3	23,9	14,5	23,9	14,7	23,8	15,1
		-16,7	-17,0	26,5	14,2	26,4	14,6	26,4	14,9	26,3	15,1	26,3	15,2	24,6	14,1
		-13,7	-15,0	29,0	14,8	28,9	15,1	28,3	14,9	27,3	14,3	26,4	13,7	24,6	12,65
		-11,8	-13,0	31,5	15,2	30,1	14,5	28,3	13,4	27,3	12,9	26,4	12,45	24,6	11,48
		-9,8	-11,0	31,9	14,1	30,1	13,2	28,3	12,3	27,3	11,82	26,4	11,38	24,6	10,51
		-9,5	-10,0	31,9	13,5	30,1	12,6	28,3	11,76	27,3	11,33	26,4	10,91	24,6	10,09
		-8,5	-9,1	31,9	13,0	30,1	12,2	28,3	11,33	27,3	10,92	26,4	10,52	24,6	9,73
		-7,0	-7,6	31,9	12,2	30,1	11,45	28,3	10,68	27,3	10,30	26,4	9,93	24,6	9,20
		-5,0	-5,6	31,9	11,3	30,1	10,63	28,3	9,93	27,3	9,58	26,4	9,24	24,6	8,57
		-3,0	-3,7	31,9	10,62	30,1	9,95	28,3	9,31	27,3	8,99	26,4	8,67	24,6	8,05
		0,0	-0,7	31,9	9,63	30,1	9,05	28,3	8,47	27,3	8,19	26,4	7,91	24,6	7,36
		3,0	2,2	31,											



# 5 Capacity tables

## 5 - 2 Heating Capacity Tables

**RQYQ20PY1**

TC: Total Capacity: kW ; PI: Power Input: kW (compressor + outdoor fan motor)

Combination (%)	Capacity index (kW)	Outdoor air temp.		Indoor air temperature: °CDB													
				16.0		18.0		20.0		21.0		22.0		24.0			
				TC	PI	TC	PI	TC	PI	TC	PI	TC	PI	TC	PI		
130	72.67 kW	-19.8	-20.0	35.9	7.71	35.8	8.51	35.6	9.31	35.5	9.7	35.5	10.1	35.3	10.1	35.3	10.9
		-18.8	-19.0	37.0	8.14	36.8	8.92	36.7	9.7	36.6	10.1	36.5	10.5	36.4	11.3	36.4	11.3
		-16.7	-17.0	39.1	8.94	38.9	9.7	38.8	10.4	38.7	10.8	38.6	11.1	38.5	11.9	38.5	11.9
		-13.7	-15.0	41.2	9.65	41.0	10.3	40.9	11.0	40.8	11.4	40.7	11.7	40.6	12.4	40.6	12.4
		-11.8	-13.0	43.3	10.3	43.1	10.9	43.0	11.6	42.9	11.9	42.8	12.3	42.7	12.9	42.7	12.9
		-9.8	-11.0	45.4	10.9	45.2	11.5	45.1	12.1	45.0	12.4	45.0	12.7	44.8	13.4	44.8	13.4
		-9.5	-10.0	46.4	11.1	46.3	11.7	46.2	12.4	46.1	12.7	46.0	13.0	45.9	13.6	45.9	13.6
		-8.5	-9.1	47.4	11.4	47.2	12.0	47.1	12.6	47.0	12.9	47.0	13.2	46.8	13.8	46.8	13.8
		-7.0	-7.6	49.0	11.7	48.8	12.3	48.7	12.9	48.6	13.2	48.5	13.5	48.4	14.1	48.4	14.1
		-5.0	-5.6	51.1	12.2	50.9	12.7	50.8	13.3	50.7	13.6	50.6	13.8	50.5	14.4	50.5	14.4
		-3.0	-3.7	53.1	12.6	52.9	13.1	52.8	13.6	52.7	13.9	52.6	14.2	52.5	14.7	52.5	14.7
		0.0	-0.7	56.2	13.1	56.1	13.6	56.0	14.2	55.9	14.4	55.8	14.7	55.7	15.2	55.7	15.2
		3.0	2.2	59.3	13.6	59.2	14.1	59.0	14.6	58.9	14.8	58.8	15.1	58.7	15.5	58.7	15.5
		5.0	4.1	61.3	13.9	61.2	14.4	61.0	14.9	60.9	15.1	60.9	15.3	60.7	15.8	60.7	15.8
		7.0	6.0	63.3	14.2	63.2	14.7	63.0	15.1	62.9	15.3	62.9	15.5	62.7	16.0	62.7	16.0
		9.0	7.9	65.3	14.5	65.2	14.9	65.0	15.3	64.9	15.5	64.9	15.8	64.7	16.2	64.7	16.2
		11.0	9.8	67.3	14.7	67.2	15.1	67.0	15.6	66.9	15.8	66.9	16.0	66.7	16.4	66.7	16.4
13.0	11.8	69.4	15.0	69.3	15.4	69.1	15.8	69.1	16.0	69.0	16.2	68.8	16.6	68.8	16.6		
15.0	13.7	71.4	15.2	71.3	15.6	71.1	16.0	71.1	16.2	71.0	16.4	70.8	16.7	70.8	16.7		
120	67.08 kW	-19.8	-20.0	35.7	8.79	35.6	9.53	35.4	10.3	35.4	10.6	35.3	11.0	35.2	11.8	35.2	11.8
		-18.8	-19.0	36.8	9.19	36.6	9.9	36.5	10.6	36.4	11.0	36.4	11.4	36.2	12.1	36.2	12.1
		-16.7	-17.0	38.9	9.9	38.7	10.6	38.6	11.3	38.5	11.6	38.5	12.0	38.3	12.6	38.3	12.6
		-13.7	-15.0	41.0	10.6	40.8	11.2	40.7	11.9	40.6	12.2	40.6	12.5	40.4	13.2	40.4	13.2
		-11.8	-13.0	43.1	11.2	42.9	11.8	42.8	12.4	42.8	12.7	42.7	13.0	42.6	13.6	42.6	13.6
		-9.8	-11.0	45.2	11.7	45.1	12.3	44.9	12.9	44.9	13.2	44.8	13.5	44.7	14.0	44.7	14.0
		-9.5	-10.0	46.2	12.0	46.1	12.5	46.0	13.1	45.9	13.4	45.8	13.7	45.7	14.2	45.7	14.2
		-8.5	-9.1	47.2	12.2	47.1	12.7	46.9	13.3	46.9	13.6	46.8	13.8	46.7	14.4	46.7	14.4
		-7.0	-7.6	48.8	12.5	48.6	13.1	48.5	13.6	48.4	13.9	48.4	14.1	48.2	14.7	48.2	14.7
		-5.0	-5.6	50.9	12.9	50.7	13.4	50.6	14.0	50.6	14.2	50.5	14.5	50.4	15.0	50.4	15.0
		-3.0	-3.7	52.9	13.3	52.8	13.8	52.6	14.3	52.6	14.5	52.5	14.8	52.4	15.3	52.4	15.3
		0.0	-0.7	56.0	13.8	55.9	14.3	55.8	14.8	55.7	15.0	55.6	15.2	55.5	15.7	55.5	15.7
		3.0	2.2	59.1	14.3	59.0	14.7	58.8	15.2	58.8	15.4	58.7	15.6	58.6	16.0	58.6	16.0
		5.0	4.1	61.1	14.6	61.0	15.0	60.8	15.4	60.8	15.6	60.7	15.8	60.6	16.3	60.6	16.3
		7.0	6.0	63.1	14.8	63.0	15.2	62.8	15.6	62.8	15.8	62.7	16.0	62.6	16.5	62.6	16.5
		9.0	7.9	65.1	15.1	65.0	15.5	64.8	15.8	64.8	16.0	64.7	16.2	64.6	16.6	64.6	16.6
		11.0	9.8	67.1	15.3	67.0	15.7	66.8	16.1	66.8	16.2	66.7	16.4	66.6	16.8	66.6	16.8
13.0	11.8	69.2	15.5	69.1	15.9	69.0	16.3	69.0	16.4	68.9	16.6	68.8	16.9	68.8	16.9		
15.0	13.7	71.2	15.7	71.1	16.1	71.0	16.4	70.9	16.6	70.9	16.6	70.8	17.0	70.8	17.0		
110	61.49 kW	-19.8	-20.0	35.5	9.9	35.4	10.6	35.3	11.2	35.2	11.6	35.1	11.9	35.0	12.6	35.0	12.6
		-18.8	-19.0	36.6	10.2	36.4	10.9	36.3	11.6	36.3	11.9	36.2	12.2	36.1	12.9	36.1	12.9
		-16.7	-17.0	38.7	10.9	38.6	11.5	38.4	12.2	38.4	12.5	38.3	12.8	38.2	13.4	38.2	13.4
		-13.7	-15.0	40.8	11.5	40.7	12.1	40.5	12.7	40.5	13.0	40.4	13.3	40.3	13.9	40.3	13.9
		-11.8	-13.0	42.9	12.1	42.8	12.6	42.6	13.2	42.6	13.5	42.5	13.7	42.4	14.3	42.4	14.3
		-9.8	-11.0	45.0	12.6	44.9	13.1	44.8	13.6	44.7	13.9	44.6	14.2	44.5	14.7	44.5	14.7
		-9.5	-10.0	46.1	12.8	45.9	13.3	45.8	13.8	45.7	14.1	45.7	14.3	45.6	14.9	45.6	14.9
		-8.5	-9.1	47.0	13.0	46.9	13.5	46.8	14.0	46.7	14.3	46.6	14.5	46.5	15.0	46.5	15.0
		-7.0	-7.6	48.6	13.3	48.5	13.8	48.3	14.3	48.3	14.5	48.2	14.8	48.1	15.3	48.1	15.3
		-5.0	-5.6	50.7	13.7	50.6	14.2	50.4	14.6	50.4	14.9	50.3	15.1	50.2	15.6	50.2	15.6
		-3.0	-3.7	52.7	14.0	52.6	14.5	52.4	14.9	52.4	15.1	52.3	15.4	52.2	15.8	52.2	15.8
		0.0	-0.7	55.9	14.5	55.7	14.9	55.6	15.4	55.5	15.6	55.5	15.8	55.4	16.2	55.4	16.2
		3.0	2.2	58.9	14.9	58.8	15.3	58.7	15.7	58.6	15.9	58.5	16.1	58.4	16.5	58.4	16.5
		5.0	4.1	60.9	15.2	60.8	15.6	60.7	16.0	60.6	16.1	60.5	16.3	60.4	16.7	60.4	16.7
		7.0	6.0	62.9	15.4	62.8	15.8	62.7	16.2	62.6	16.4	62.6	16.5	62.5	16.9	62.5	16.9
		9.0	7.9	64.9	15.6	64.8	16.0	64.7	16.4	64.6	16.5	64.5	16.6	64.4	17.0	64.4	17.0
		11.0	9.8	66.9	15.8	66.8	16.2	66.7	16.6	66.6	16.7	66.5	16.8	66.4	17.3	66.4	17.3
13.0	11.8	69.0	16.1	68.9	16.4	68.8	16.7	68.7	16.8	68.6	16.9	68.5	17.4	68.5	17.4		
15.0	13.7	71.0	16.2	70.9	16.6	70.8	16.9	70.7	17.0	70.6	17.1	70.5	17.5	70.5	17.5		
100	55.90 kW	-19.8	-20.0	35.3	11.0	35.2	11.6	35.1	12.2	35.0	12.5	35.0	12.8	34.9	13.4	34.9	13.4
		-18.8	-19.0	36.4	11.3	36.3	11.9	36.2	12.5	36.1	12.8	36.0	13.1	35.9	13.7	35.9	13.7
		-16.7	-17.0	38.5	11.9	38.4	12.5	38.3	13.0	38.2	13.3	38.1	13.6	38.0	14.2	38.0	14.2
		-13.7	-15.0	40.6	12.5	40.5	13.0	40.4	13.5	40.3	13.8	40.3	14.1	40.1	14.6	40.1	14.6
		-11.8	-13.0	42.7	13.0	42.6	13.5	42.5	14.0	42.4	14.2	42.4	14.5	42.3	15.0	42.3	15.0
		-9.8	-11.0	44.8	13.4	44.7	13.9	44.6	14.4	44.5	14.6	44.5	14.9	44.4	15.3	44.4	15.3
		-9.5	-10.0	45.9	13.6	45.7	14.1	45.6	14.6	45.5	14.8	45.5	15.0	45.4	15.5	45.4	15.5
		-8.5	-9.1	46.8	13.8	46.7	14.3	46.6	14.7	46.5	15.0	46.5	15.2	46.4	15.6	46.4	15.6
		-7.0	-7.6	48.4	14.1	48.3	14.5	48.2	15.0	48.1	15.2	48.1	15.4	48.0	15.9	48.0	15.9
		-5.0	-5.6	50.5	14.4	50.4	14.9	50.3	15.3	50.2	15.5	50.2	15.7	50.1	16.1	50.1	16.1
		-3.0	-3.7	52.5	14.7	52.4	15.2	52.3	15.6	52.2	15.8	52.2	16.0	52.1	16.4	52.1	16.4
		0.0	-0.7	55.7	15.2	55.5	15.6	55.4	16.0	55.4	16.1	55.3	16.3	55.2	16.4	55.2	16.4
		3.0	2.2	58.7	15.6	58.6	15.9	58.5	16.3	58.4	16.5	58.4	16.7	58.3	16.8	58.3	16.8
		5.0	4.1	60.7	15.8	60.6	16.2	60.5	16.5	60.4	16.7	60.4	16.9	60.3	17.0	60.3	17.0
		7.0	6.0	62.7	16.0	62.6	16.4	62.5	16.7	62.4	16.9	62.4	17.1	62.3	17.1	62.3	17.1
		9.0	7.9	64.7	16.2	64.6	16.5	64.5	16.8	64.4	17.0	64.4	17.2	64.3	17.2	64.3	17.2
		11.0	9.8	66.7	16.4	66.5	16.7	66.4	17.0	66.3	17.2	66.3	17.4	66.2	17.4	66.2	17.4
13.0	11.8	68.8	16.6	68.6	16.9	68.5	17.2	68.4	17.4	68.4	17.6	68.3	17.6	68.3	17.6		
15.0	13.7	70.5	16.7	70.4	17.1	70.3	17.4	70.2	17.6	70.2	17.8	70.1	17.8	70.1	17.8		

**NOTES - ANMERKUNGEN - Σημειώσεις - NOTAS - REMARQUES - NOTE - OPMERKINGEN - Примечания - NOTLAR**

- is shown as reference. When selecting the unit models, avoid the Outdoor air temperature range shown by
- dient als Verweis. Vermeiden Sie bei der Auswahl der Gerätemodelle den als markierten Temperaturbereich der Außenluft
- Η είναι ενδεικτική, κατά την επιλογή των μοντέλων των μονάδων, αποφύγετε το εύρος θερμοκρασίας εξωτερικού αέρα που υποδεικνύεται
- se muestra como referencia. Cuando seleccione los modelos de unidad, evite el intervalo de temperaturas del aire exterior indicado mediante
- est montré comme référence. Lors du choix des modèles d'unités, évitez la plage de températures de l'air extérieur illustré par
- valori riportati unicamente come riferimento. Nel selezionare i modelli delle unità, non considerare i valori di temperatura dell'aria esterna indicati con il colore

# 5 Capacity tables

## 5 - 2 Heating Capacity Tables

5

RQYQ20PY1		TC: Total Capacity: kW ; PI: Power Input: kW (compressor + outdoor fan motor)															
Combination (%)	Capacity index (kW)	Outdoor air temp.		Indoor air temperature: °CDB													
				16.0		18.0		20.0		21.0		22.0		24.0			
				TC	PI	TC	PI	TC	PI	TC	PI	TC	PI	TC	PI		
		°CDB	°CWB	kW		kW		kW		kW		kW		kW			
90%	50,31 kW	-19,8	-20,0	35,1	12,0	35,0	12,6	34,9	13,2	34,9	13,4	34,8	13,7	34,7	14,0	34,7	14,3
		-18,8	-19,0	36,2	12,4	36,1	12,9	36,0	13,4	35,9	13,7	35,9	14,0	35,8	14,3	35,8	14,5
		-16,7	-17,0	38,3	12,9	38,2	13,4	38,1	13,9	38,0	14,2	38,0	14,4	37,9	14,7	37,9	14,9
		-13,7	-15,0	40,4	13,4	40,3	13,9	40,2	14,4	40,1	14,6	40,1	14,8	40,0	15,3	40,0	15,3
		-11,8	-13,0	42,5	13,9	42,4	14,3	42,3	14,8	42,3	15,0	42,2	15,2	42,1	15,7	42,1	15,7
		-9,8	-11,0	44,6	14,3	44,5	14,7	44,4	15,1	44,4	15,3	44,3	15,6	44,2	16,0	44,2	16,0
		-9,5	-10,0	45,7	14,4	45,6	14,9	45,5	15,3	45,4	15,5	45,4	15,7	45,3	16,1	45,3	16,1
		-8,5	-9,1	46,6	14,6	46,5	15,0	46,4	15,4	46,4	15,6	46,3	15,9	46,2	16,3	46,2	16,3
		-7,0	-7,6	48,2	14,9	48,1	15,3	48,0	15,7	47,9	15,9	47,9	16,1	47,8	16,5	47,8	16,5
		-5,0	-5,6	50,3	15,2	50,2	15,6	50,1	16,0	50,1	16,1	50,0	16,3	49,0	16,3	49,0	16,3
		-3,0	-3,7	52,3	15,5	52,2	15,8	52,1	16,2	52,1	16,4	52,0	16,6	49,0	15,5	49,0	15,5
		0,0	-0,7	55,5	15,9	55,4	16,2	55,3	16,6	54,4	16,4	52,6	15,7	49,0	14,5	49,0	14,5
		3,0	2,2	58,5	16,2	58,4	16,5	56,3	16,0	54,4	15,3	52,6	14,8	49,0	13,6	49,0	13,6
		5,0	4,1	60,5	16,4	59,9	16,5	56,3	15,3	54,4	14,8	52,6	14,2	49,0	13,1	49,0	13,1
		7,0	6,0	62,5	16,6	59,9	15,9	56,3	14,7	54,4	14,2	52,6	13,7	49,0	12,6	49,0	12,6
		9,0	7,9	63,5	16,4	59,9	15,3	56,3	14,2	54,4	13,7	52,6	13,2	49,0	12,2	49,0	12,2
		11,0	9,8	63,5	15,8	59,9	14,7	56,3	13,7	54,4	13,2	52,6	12,7	49,0	11,8	49,0	11,8
		13,0	11,8	63,5	15,2	59,9	14,2	56,3	13,2	54,4	12,8	52,6	12,3	49,0	11,4	49,0	11,4
		15,0	13,7	63,5	14,7	59,9	13,8	56,3	12,8	54,4	12,4	52,6	11,9	49,0	11,0	49,0	11,0
		80%	44,72 kW	-19,8	-20,0	34,9	13,1	34,8	13,6	34,8	14,1	34,7	14,4	34,7	14,6	34,6	15,1
-18,8	-19,0			36,0	13,4	35,9	13,9	35,8	14,4	35,8	14,6	35,7	14,8	35,6	15,3	35,6	15,3
-16,7	-17,0			38,1	13,9	38,0	14,3	37,9	14,8	37,9	15,0	37,8	15,3	37,7	15,7	37,7	15,7
-13,7	-15,0			40,2	14,3	40,1	14,8	40,0	15,2	40,0	15,4	39,9	15,6	39,8	16,1	39,8	16,1
-11,8	-13,0			42,3	14,7	42,2	15,1	42,1	15,6	42,1	15,8	42,0	16,0	42,0	16,4	42,0	16,4
-9,8	-11,0			44,4	15,1	44,3	15,5	44,2	15,9	44,2	16,1	44,2	16,3	43,6	16,4	43,6	16,4
-9,5	-10,0			45,5	15,3	45,4	15,6	45,3	16,0	45,3	16,2	45,2	16,4	43,6	15,9	43,6	15,9
-8,5	-9,1			46,4	15,4	46,3	15,8	46,2	16,2	46,2	16,3	46,2	16,5	43,6	15,5	43,6	15,5
-7,0	-7,6			48,0	15,6	47,9	16,0	47,8	16,4	47,8	16,5	46,8	16,2	43,6	14,9	43,6	14,9
-5,0	-5,6			50,1	15,9	50,0	16,3	49,9	16,6	48,4	16,0	46,8	15,4	43,6	14,2	43,6	14,2
-3,0	-3,7			52,1	16,2	52,0	16,5	50,0	15,9	48,4	15,3	46,8	14,7	43,6	13,5	43,6	13,5
0,0	-0,7			55,3	16,5	53,2	15,9	50,0	14,8	48,4	14,3	46,8	13,7	43,6	12,6	43,6	12,6
3,0	2,2			56,4	16,0	53,2	14,9	50,0	13,9	48,4	13,4	46,8	12,9	43,6	11,9	43,6	11,9
5,0	4,1			56,4	15,4	53,2	14,4	50,0	13,4	48,4	12,9	46,8	12,4	43,6	11,5	43,6	11,5
7,0	6,0			56,4	14,8	53,2	13,8	50,0	12,9	48,4	12,4	46,8	12,0	43,6	11,1	43,6	11,1
9,0	7,9			56,4	14,3	53,2	13,3	50,0	12,4	48,4	12,0	46,8	11,5	43,6	10,6,9	43,6	10,6,9
11,0	9,8			56,4	13,8	53,2	12,9	50,0	12,0	48,4	11,6	46,8	11,2	43,6	10,3,4	43,6	10,3,4
13,0	11,8			56,4	13,3	53,2	12,4	50,0	11,6	48,4	11,2	46,8	10,7,9	43,6	10,0,0	43,6	10,0,0
15,0	13,7			56,4	12,9	53,2	12,0	50,0	11,2	48,4	10,8,5	46,8	10,4,6	43,6	9,7,0	43,6	9,7,0
70%	39,13 kW			-19,8	-20,0	34,7	14,2	34,7	14,6	34,6	15,1	34,5	15,3	34,5	15,5	34,4	15,9
		-18,8	-19,0	35,8	14,5	35,7	14,9	35,6	15,3	35,6	15,5	35,6	15,7	35,5	16,1	35,5	16,1
		-16,7	-17,0	37,9	14,9	37,8	15,3	37,7	15,7	37,7	15,9	37,7	16,1	37,6	16,5	37,6	16,5
		-13,7	-15,0	40,0	15,3	39,9	15,7	39,9	16,0	39,8	16,2	39,8	16,4	38,1	15,8	38,1	15,8
		-11,8	-13,0	42,1	15,6	42,0	16,0	42,0	16,3	41,9	16,5	40,9	16,1	38,1	14,8	38,1	14,8
		-9,8	-11,0	44,2	16,0	44,1	16,3	43,8	16,4	42,3	15,8	40,9	15,2	38,1	14,0	38,1	14,0
		-9,5	-10,0	45,3	16,1	45,2	16,4	43,8	16,0	42,3	15,4	40,9	14,8	38,1	13,6	38,1	13,6
		-8,5	-9,1	46,2	16,2	46,1	16,6	43,8	15,6	42,3	15,0	40,9	14,4	38,1	13,3	38,1	13,3
		-7,0	-7,6	47,8	16,4	46,6	16,1	43,8	15,0	42,3	14,4	40,9	13,9	38,1	12,8	38,1	12,8
		-5,0	-5,6	49,4	16,4	46,6	15,3	43,8	14,2	42,3	13,7	40,9	13,2	38,1	12,2	38,1	12,2
		-3,0	-3,7	49,4	15,6	46,6	14,6	43,8	13,6	42,3	13,1	40,9	12,6	38,1	11,6	38,1	11,6
		0,0	-0,7	49,4	14,6	46,6	13,6	43,8	12,7	42,3	12,2	40,9	11,8	38,1	10,9	38,1	10,9
		3,0	2,2	49,4	13,7	46,6	12,8	43,8	12,0	42,3	11,5	40,9	11,1	38,1	10,2,9	38,1	10,2,9
		5,0	4,1	49,4	13,2	46,6	12,3	43,8	11,5	42,3	11,1	40,9	10,7,1	38,1	9,9,3	38,1	9,9,3
		7,0	6,0	49,4	12,7	46,6	11,9	43,8	11,1	42,3	10,7,2	40,9	10,3,4	38,1	9,5,9	38,1	9,5,9
		9,0	7,9	49,4	12,3	46,6	11,5	43,8	10,7,3	42,3	10,3,6	40,9	10,0,0	38,1	9,2,8	38,1	9,2,8
		11,0	9,8	49,4	11,8	46,6	11,1	43,8	10,3,8	42,3	10,0,3	40,9	9,6,8	38,1	8,9,9	38,1	8,9,9
		13,0	11,8	49,4	11,4	46,6	10,7,4	43,8	10,0,4	42,3	9,7,0	40,9	9,3,7	38,1	8,7,0	38,1	8,7,0
		15,0	13,7	49,4	11,1	46,6	10,4,1	43,8	9,7,4	42,3	9,4,1	40,9	9,0,9	38,1	8,4,5	38,1	8,4,5
		60%	33,54 kW	-19,8	-20,0	34,5	15,3	34,5	15,7	34,4	16,0	34,4	16,2	34,3	16,4	32,7	15,6
-18,8	-19,0			35,6	15,5	35,5	15,9	35,5	16,2	35,4	16,4	35,1	16,4	32,7	15,0	32,7	15,0
-16,7	-17,0			37,7	15,9	37,6	16,2	37,5	16,5	36,3	15,9	35,1	15,3	32,7	14,0	32,7	14,0
-13,7	-15,0			39,8	16,2	39,7	16,5	37,5	15,5	36,3	14,9	35,1	14,3	32,7	13,2	32,7	13,2
-11,8	-13,0			41,9	16,5	39,9	15,6	37,5	14,5	36,3	14,0	35,1	13,5	32,7	12,4	32,7	12,4
-9,8	-11,0			42,3	15,8	39,9	14,8	37,5	13,7	36,3	13,2	35,1	12,7	32,7	11,8	32,7	11,8
-9,5	-10,0			42,3	15,4	39,9	14,3	37,5	13,4	36,3	12,9	35,1	12,4	32,7	11,4	32,7	11,4
-8,5	-9,1			42,3	15,0	39,9	14,0	37,5	13,0	36,3	12,6	35,1	12,1	32,7	11,2	32,7	11,2
-7,0	-7,6			42,3	14,4	39,9	13,5	37,5	12,5	36,3	12,1	35,1	11,7	32,7	10,7,8	32,7	10,7,8
-5,0	-5,6			42,3	13,7	39,9	12,8	37,5	12,0	36,3	11,5	35,1	11,1	32,7	10,2,8	32,7	10,2,8
-3,0	-3,7			42,3	13,1	39,9	12,3	37,5	11,4	36,3	11,0	35,1	10,6,4	32,7	9,8,6	32,7	9,8,6
0,0	-0,7			42,3	12,2	39,9	11,5	37,5	10,7,2	36,3	10,3,5	35,1	9,9,8	32,7	9,2,6	32,7	9,2,6
3,0	2,2			42,3	11,5	39,9	10,8,1	37,5	10,1,1	36,3	9,7,7	35,1	9,4,3	32,7	8,7,6	32,7	8,7,6
5,0	4,1			42,3	11,1	39,9	10,4,2	37,5	9,7,5	36,3	9,4,2	35,1	9,1,0	32,7	8,4,6	32,7	8,4,6
7,0	6,0			42,3	10,7,2	39,9	10,0,6	37,5	9,4,2	36,3	9,1,1	35,1	8,8,0	32,7	8,1,8	32,7	8,1,8
9,0	7,9			42,3	10,3,6	39,9	9,7,3	37,5	9,1,2	36,3	8,8,2	35,1	8,5,2	32,7	7,9,3	32,7	7,9,3
11,0	9,8			42,3	10,0,2	39,9	9,4,2	37,5	8,8,3	36,3	8,5,4	35,1	8,2,6	32,7	7,6,9	32,7	7,6,9
13,0	11,8			42,3	9,7,0	39,9	9,1,2	37,5	8,5,6	36,3	8,2,8	35,1	8,0,0	32,7	7,4,6	32,7	7,4,6
15,0	13,7			42,3	9,4,1	39,9	8,8,5	37,5	8,3,1	36,3	8,0,4	35,1	7,7,8	32,7	7,2,5	32,7	7,2,5
50%	27,95 kW			-19,8	-20,0	34,4											

# 5 Capacity tables

## 5 - 2 Heating Capacity Tables

RQYQ22PY1

TC: Total Capacity: kW ; PI: Power Input: kW (compressor + outdoor fan motor)

Combination (%)	Capacity index (kW)	Outdoor air temp.		Indoor air temperature: °CDB													
				16.0		18.0		20.0		21.0		22.0		24.0			
				TC	PI	TC	PI	TC	PI	TC	PI	TC	PI	TC	PI		
130	79.95 kW	-19.8	-20.0	40.1	10.08	40.0	11.08	39.8	12.1	39.7	12.6	39.6	13.1	39.5	14.1	39.5	14.1
		-18.8	-19.0	41.3	10.58	41.1	11.6	41.0	12.5	40.9	13.0	40.8	13.5	40.7	14.5	40.7	14.5
		-16.7	-17.0	43.6	11.5	43.5	12.4	43.3	13.3	43.3	13.8	43.2	14.2	43.0	15.1	43.0	15.1
		-13.7	-15.0	46.0	12.3	45.8	13.1	45.7	14.0	45.6	14.4	45.5	14.8	45.4	15.7	45.4	15.7
		-11.8	-13.0	48.4	12.9	48.2	13.7	48.0	14.6	48.0	15.0	47.9	15.4	47.7	16.2	47.7	16.2
		-9.8	-11.0	50.7	13.5	50.6	14.3	50.4	15.1	50.3	15.4	50.2	15.8	50.1	16.6	50.1	16.6
		-9.5	-10.0	51.9	13.8	51.7	14.5	51.6	15.3	51.5	15.7	51.4	16.0	51.3	16.8	51.3	16.8
		-8.5	-9.1	53.0	14.0	52.8	14.8	52.6	15.5	52.6	15.8	52.5	16.2	52.3	16.9	52.3	16.9
		-7.0	-7.6	54.7	14.4	54.6	15.1	54.4	15.8	54.3	16.1	54.3	16.5	54.1	17.1	54.1	17.1
		-5.0	-5.6	57.1	14.8	56.9	15.5	56.8	16.1	56.7	16.4	56.6	16.8	56.5	17.4	56.5	17.4
		-3.0	-3.7	59.3	15.1	59.2	15.8	59.0	16.4	58.9	16.7	58.9	17.0	58.7	17.6	58.7	17.6
		0.0	-0.7	62.9	15.6	62.7	16.2	62.5	16.8	62.5	17.1	62.4	17.4	62.2	17.9	62.2	17.9
		3.0	2.2	66.3	16.0	66.1	16.5	66.0	17.1	65.9	17.3	65.8	17.6	65.6	18.2	65.6	18.2
		5.0	4.1	68.5	16.2	68.4	16.7	68.2	17.2	68.1	17.5	68.0	17.8	67.9	18.3	67.9	18.3
		7.0	6.0	70.8	16.4	70.6	16.9	70.4	17.4	70.4	17.6	70.3	17.9	70.1	18.4	70.1	18.4
		9.0	7.9	73.0	16.5	72.8	17.0	72.7	17.5	72.6	17.7	72.5	18.0	72.4	18.5	72.4	18.5
		11.0	9.8	75.2	16.7	75.1	17.1	74.9	17.6	74.8	17.8	74.8	18.0	74.6	18.6	74.6	18.6
13.0	11.8	77.6	16.8	77.4	17.2	77.3	17.7	77.2	17.9	77.1	18.1	77.0	18.6	77.0	18.6		
15.0	13.7	79.8	16.9	79.7	17.3	79.5	17.7	79.4	17.9	79.4	18.2	79.2	18.8	79.2	18.8		
120	73.95 kW	-19.8	-20.0	39.9	11.4	39.8	12.4	39.6	13.3	39.5	13.8	39.5	14.2	39.3	15.2	39.3	15.2
		-18.8	-19.0	41.1	11.9	40.9	12.8	40.8	13.7	40.7	14.1	40.6	14.6	40.5	15.5	40.5	15.5
		-16.7	-17.0	43.4	12.7	43.3	13.6	43.1	14.4	43.1	14.8	43.0	15.2	42.9	16.1	42.9	16.1
		-13.7	-15.0	45.8	13.4	45.6	14.2	45.5	15.0	45.4	15.4	45.4	15.8	45.2	16.6	45.2	16.6
		-11.8	-13.0	48.1	14.0	48.0	14.8	47.9	15.5	47.8	15.9	47.7	16.3	47.6	17.0	47.6	17.0
		-9.8	-11.0	50.5	14.6	50.4	15.3	50.2	16.0	50.1	16.3	50.1	16.7	49.9	17.4	49.9	17.4
		-9.5	-10.0	51.7	14.8	51.5	15.5	51.4	16.2	51.3	16.5	51.2	16.8	51.1	17.5	51.1	17.5
		-8.5	-9.1	52.7	15.0	52.6	15.7	52.5	16.3	52.4	16.6	52.3	17.0	52.2	17.7	52.2	17.7
		-7.0	-7.6	54.5	15.3	54.4	16.0	54.2	16.6	54.2	16.9	54.1	17.2	53.9	17.9	53.9	17.9
		-5.0	-5.6	56.9	15.7	56.7	16.3	56.6	16.9	56.5	17.2	56.4	17.5	56.3	18.1	56.3	18.1
		-3.0	-3.7	59.1	16.0	59.0	16.6	58.8	17.1	58.7	17.4	58.7	17.7	58.5	18.3	58.5	18.3
		0.0	-0.7	62.6	16.4	62.5	16.9	62.4	17.5	62.3	17.7	62.2	18.0	62.1	18.5	62.1	18.5
		3.0	2.2	66.1	16.7	65.9	17.2	65.8	17.7	65.7	18.0	65.6	18.2	65.5	18.7	65.5	18.7
		5.0	4.1	68.3	16.9	68.2	17.4	68.0	17.9	67.9	18.1	67.9	18.3	67.7	18.8	67.7	18.8
		7.0	6.0	70.5	17.0	70.4	17.5	70.3	18.0	70.2	18.2	70.1	18.4	70.0	18.9	70.0	18.9
		9.0	7.9	72.8	17.2	72.6	17.6	72.5	18.1	72.4	18.3	72.3	18.5	72.2	18.9	72.2	18.9
		11.0	9.8	75.0	17.3	74.9	17.7	74.7	18.1	74.7	18.4	74.6	18.6	74.5	19.0	74.5	19.0
13.0	11.8	77.4	17.4	77.2	17.8	77.1	18.2	77.0	18.4	76.9	18.6	76.8	19.0	76.8	19.0		
15.0	13.7	79.6	17.5	79.5	17.9	79.3	18.2	79.3	18.4	79.2	18.6	79.1	19.0	79.1	19.0		
110	67.65 kW	-19.8	-20.0	39.7	12.8	39.6	13.6	39.4	14.5	39.4	14.9	39.3	15.4	39.2	16.2	39.2	16.2
		-18.8	-19.0	40.9	13.2	40.7	14.0	40.6	14.9	40.5	15.3	40.5	15.7	40.3	16.5	40.3	16.5
		-16.7	-17.0	43.2	13.9	43.1	14.7	43.0	15.5	42.9	15.9	42.8	16.2	42.7	17.0	42.7	17.0
		-13.7	-15.0	45.6	14.6	45.4	15.3	45.3	16.0	45.2	16.4	45.2	16.7	45.0	17.5	45.0	17.5
		-11.8	-13.0	47.9	15.1	47.8	15.8	47.7	16.5	47.6	16.8	47.5	17.2	47.4	17.8	47.4	17.8
		-9.8	-11.0	50.3	15.6	50.2	16.2	50.0	16.9	50.0	17.2	49.9	17.5	49.8	18.2	49.8	18.2
		-9.5	-10.0	51.5	15.8	51.3	16.4	51.2	17.0	51.1	17.4	51.1	17.7	50.9	18.3	50.9	18.3
		-8.5	-9.1	52.5	16.0	52.4	16.6	52.3	17.2	52.2	17.5	52.1	17.8	52.0	18.4	52.0	18.4
		-7.0	-7.6	54.3	16.3	54.2	16.8	54.0	17.4	54.0	17.7	53.9	18.0	53.8	18.6	53.8	18.6
		-5.0	-5.6	56.7	16.6	56.5	17.1	56.4	17.7	56.3	18.0	56.3	18.2	56.1	18.8	56.1	18.8
		-3.0	-3.7	58.9	16.8	58.8	17.4	58.6	17.9	58.6	18.2	58.5	18.4	58.4	19.0	58.4	19.0
		0.0	-0.7	62.4	17.2	62.3	17.7	62.2	18.2	62.1	18.4	62.0	18.7	61.9	19.2	61.9	19.2
		3.0	2.2	65.9	17.5	65.7	17.9	65.6	18.4	65.5	18.6	65.5	18.8	65.3	19.3	65.3	19.3
		5.0	4.1	68.1	17.6	68.0	18.0	67.8	18.5	67.8	18.7	67.7	18.9	67.6	19.3	67.6	19.3
		7.0	6.0	70.3	17.7	70.2	18.1	70.1	18.6	70.0	18.8	69.9	19.0	69.8	19.6	69.8	19.6
		9.0	7.9	72.6	17.8	72.4	18.2	72.3	18.6	72.2	18.8	72.1	19.0	72.0	19.6	72.0	19.6
		11.0	9.8	74.8	17.9	74.7	18.3	74.5	18.7	74.5	18.9	74.4	19.1	74.3	19.6	74.3	19.6
13.0	11.8	77.2	18.0	77.0	18.4	76.9	18.8	76.8	19.0	76.7	19.2	76.6	19.6	76.6	19.6		
15.0	13.7	79.4	18.0	79.3	18.4	79.2	18.8	79.1	19.0	79.0	19.2	78.9	19.6	78.9	19.6		
100	61.50 kW	-19.8	-20.0	39.5	14.2	39.4	14.9	39.2	15.7	39.2	16.1	39.1	16.5	39.0	17.3	39.0	17.3
		-18.8	-19.0	40.7	14.5	40.5	15.3	40.4	16.0	40.3	16.4	40.3	16.8	40.2	17.5	40.2	17.5
		-16.7	-17.0	43.0	15.2	42.9	15.9	42.8	16.6	42.7	16.9	42.6	17.3	42.5	18.0	42.5	18.0
		-13.7	-15.0	45.4	15.7	45.2	16.4	45.1	17.0	45.1	17.4	45.0	17.7	44.9	18.4	44.9	18.4
		-11.8	-13.0	47.7	16.2	47.6	16.8	47.5	17.4	47.4	17.7	47.4	18.1	47.2	18.7	47.2	18.7
		-9.8	-11.0	50.1	16.6	50.0	17.2	49.8	17.8	49.8	18.1	49.7	18.4	49.6	18.9	49.6	18.9
		-9.5	-10.0	51.3	16.8	51.1	17.4	51.0	17.9	51.0	18.2	50.9	18.5	50.8	19.1	50.8	19.1
		-8.5	-9.1	52.3	17.0	52.2	17.5	52.1	18.1	52.0	18.3	52.0	18.6	51.8	19.2	51.8	19.2
		-7.0	-7.6	54.1	17.2	54.0	17.7	53.8	18.2	53.8	18.5	53.7	18.8	53.6	19.3	53.6	19.3
		-5.0	-5.6	56.4	17.5	56.3	18.0	56.2	18.5	56.1	18.7	56.1	19.0	56.0	19.5	56.0	19.5
		-3.0	-3.7	58.7	17.7	58.6	18.2	58.4	18.6	58.4	18.9	58.3	19.1	58.2	19.6	58.2	19.6
		0.0	-0.7	62.2	18.0	62.1	18.4	62.0	18.9	61.9	19.1	61.9	19.3	61.8	19.6	61.8	19.6
		3.0	2.2	65.6	18.2	65.5	18.6	65.4	19.0	65.3	19.2	65.2	19.4	65.1	19.6	65.1	19.6
		5.0	4.1	67.9	18.3	67.8	18.7	67.6	19.1	67.6	19.3	67.5	19.5	67.4	19.6	67.4	19.6
		7.0	6.0	70.1	18.4	70.0	18.8	69.9	19.2	69.8	19.4	69.7	19.6	69.6	19.6	69.6	19.6
		9.0	7.9	72.4	18.5	72.2	18.8	72.1	19.0	72.0	19.2	71.9	19.4	71.8	19.6	71.8	19.6
		11.0	9.8	74.6	18.5	74.4	18.8	74.3	19.0	74.2	19.2	74.1	19.4	74.0	19.6	74.0	19.6
13.0	11.8	77.0	18.6	76.8	18.8	76.7	19.0	76.6	19.2	76.5	19.4	76.4	19.6	76.4	19.6		
15.0	13.7	77.9	18.1	77.8	18.1	77.7	18.1	77.6	18.1	77.5	18.1	77.4	18.1	77.3	18.1		

**NOTES - ANMERKUNGEN - Σημειώσεις - NOTAS - REMARQUES - NOTE - OPMERKINGEN - Примечания - NOTLAR**

- is shown as reference. When selecting the unit models, avoid the Outdoor air temperature range shown by
- dient als Verweis. Vermeiden Sie bei der Auswahl der Gerätemodelle den als markierten Temperaturbereich der Außenluft
- Η είναι ενδεικτική, κατά την επιλογή των μοντέλων των μονάδων, αποφύγετε το εύρος θερμοκρασίας εξωτερικού αέρα που υποδεικνύεται
- se muestra como referencia. Cuando seleccione los modelos de unidad, evite el intervalo de temperaturas del aire exterior indicado mediante
- est montré comme référence. Lors du choix des

# 5 Capacity tables

## 5 - 2 Heating Capacity Tables

5

RQYQ22PY1		TC: Total Capacity: kW ; PI: Power Input: kW (compressor + outdoor fan motor)													
Combination (%)	Capacity index (kW)	Outdoor air temp.		Indoor air temperature: °CDB											
				16.0		18.0		20.0		21.0		22.0		24.0	
				TC	PI	TC	PI	TC	PI	TC	PI	TC	PI	TC	PI
		°CDB	°CWB												
90%	55,35 kW	-19,8	-20,0	39,3	15,5	39,1	16,2	39,0	16,9	39,0	17,3	38,9	17,6	38,8	18,3
		-18,8	-19,0	40,4	15,8	40,3	16,5	40,2	17,2	40,2	17,5	40,1	17,9	40,0	18,5
		-16,7	-17,0	42,8	16,4	42,7	17,0	42,6	17,7	42,5	18,0	42,5	18,3	42,4	18,9
		-13,7	-15,0	45,2	16,9	45,0	17,5	44,9	18,1	44,9	18,4	44,8	18,7	44,7	19,2
		-11,8	-13,0	47,5	17,3	47,4	17,8	47,3	18,4	47,2	18,7	47,2	19,0	47,1	19,5
		-9,8	-11,0	49,9	17,6	49,8	18,2	49,6	18,7	49,6	19,0	49,5	19,2	49,4	19,7
		-9,5	-10,0	51,0	17,8	50,9	18,3	50,8	18,8	50,8	19,1	50,7	19,3	50,6	19,8
		-8,5	-9,1	52,1	17,9	52,0	18,4	51,9	18,9	51,8	19,2	51,8	19,4	51,7	19,9
		-7,0	-7,6	53,9	18,1	53,8	18,6	53,7	19,1	53,6	19,3	53,5	19,6	53,4	20,0
		-5,0	-5,6	56,2	18,3	56,1	18,8	56,0	19,3	56,0	19,5	55,9	19,7	54,1	19,2
		-3,0	-3,7	58,5	18,5	58,4	19,0	58,3	19,4	58,2	19,6	58,1	19,8	54,1	18,2
		0,0	-0,7	62,0	18,8	61,9	19,2	61,8	19,6	60,1	19,0	58,1	18,2	54,1	16,8
		3,0	2,2	65,4	18,9	65,3	19,3	62,1	18,3	60,1	17,6	58,1	16,9	54,1	15,6
		5,0	4,1	67,7	19,0	66,1	18,7	62,1	17,4	60,1	16,7	58,1	16,1	54,1	14,8
		7,0	6,0	69,9	19,1	66,1	17,9	62,1	16,6	60,1	16,0	58,1	15,4	54,1	14,2
		9,0	7,9	70,1	18,3	66,1	17,1	62,1	15,9	60,1	15,3	58,1	14,7	54,1	13,6
		11,0	9,8	70,1	17,5	66,1	16,3	62,1	15,2	60,1	14,6	58,1	14,1	54,1	13,0
		13,0	11,8	70,1	16,7	66,1	15,6	62,1	14,5	60,1	14,0	58,1	13,5	54,1	12,5
		15,0	13,7	70,1	16,0	66,1	15,0	62,1	13,9	60,1	13,4	58,1	12,9	54,1	12,0
		80%	49,20 kW	-19,8	-20,0	39,0	16,9	38,9	17,5	38,9	18,1	38,8	18,4	38,8	18,7
-18,8	-19,0			40,2	17,1	40,1	17,7	40,0	18,3	40,0	18,6	39,9	18,9	39,8	19,5
-16,7	-17,0			42,6	17,6	42,5	18,2	42,4	18,7	42,3	19,0	42,3	19,3	42,2	19,9
-13,7	-15,0			44,9	18,0	44,8	18,6	44,7	19,1	44,7	19,3	44,6	19,6	44,6	20,1
-11,8	-13,0			47,3	18,4	47,2	18,9	47,1	19,4	47,1	19,6	47,0	19,9	46,9	20,4
-9,8	-11,0			49,7	18,7	49,6	19,1	49,5	19,6	49,4	19,8	49,4	20,1	48,1	19,8
-9,5	-10,0			50,8	18,8	50,7	19,2	50,6	19,7	50,6	19,9	50,5	20,2	48,1	19,2
-8,5	-9,1			51,9	18,9	51,8	19,3	51,7	19,8	51,7	20,0	51,6	20,2	48,1	18,6
-7,0	-7,6			53,7	19,1	53,6	19,5	53,5	19,9	53,4	20,1	51,7	19,3	48,1	17,8
-5,0	-5,6			56,0	19,2	55,9	19,6	55,2	19,7	53,4	18,9	51,7	18,2	48,1	16,8
-3,0	-3,7			58,3	19,4	58,2	19,8	55,2	18,6	53,4	17,9	51,7	17,2	48,1	15,9
0,0	-0,7			61,8	19,5	58,7	18,5	55,2	17,2	53,4	16,5	51,7	15,9	48,1	14,7
3,0	2,2			62,3	18,3	58,7	17,1	55,2	15,9	53,4	15,3	51,7	14,8	48,1	13,6
5,0	4,1			62,3	17,5	58,7	16,3	55,2	15,2	53,4	14,6	51,7	14,1	48,1	13,0
7,0	6,0			62,3	16,7	58,7	15,6	55,2	14,5	53,4	14,0	51,7	13,5	48,1	12,5
9,0	7,9			62,3	15,9	58,7	14,9	55,2	13,9	53,4	13,4	51,7	12,9	48,1	11,9
11,0	9,8			62,3	15,2	58,7	14,3	55,2	13,3	53,4	12,8	51,7	12,4	48,1	11,4
13,0	11,8			62,3	14,6	58,7	13,6	55,2	12,7	53,4	12,3	51,7	11,8	48,1	11,0
15,0	13,7			62,3	14,0	58,7	13,1	55,2	12,2	53,4	11,8	51,7	11,4	48,1	10,56
70%	43,05 kW			-19,8	-20,0	38,8	18,2	38,7	18,8	38,7	19,3	38,6	19,6	38,6	19,9
		-18,8	-19,0	40,0	18,5	39,9	19,0	39,8	19,5	39,8	19,8	39,8	20,0	39,7	20,6
		-16,7	-17,0	42,4	18,9	42,3	19,3	42,2	19,8	42,2	20,1	42,1	20,3	42,0	20,8
		-13,7	-15,0	44,7	19,2	44,6	19,6	44,6	20,1	44,5	20,3	44,5	20,6	42,1	19,4
		-11,8	-13,0	47,1	19,5	47,0	19,9	46,9	20,3	46,7	20,5	45,2	19,7	42,1	18,1
		-9,8	-11,0	49,4	19,7	49,4	20,1	48,3	19,9	46,7	19,1	45,2	18,4	42,1	16,9
		-9,5	-10,0	50,6	19,8	50,5	20,2	48,3	19,2	46,7	18,5	45,2	17,8	42,1	16,4
		-8,5	-9,1	51,7	19,9	51,4	20,1	48,3	18,7	46,7	18,0	45,2	17,3	42,1	15,9
		-7,0	-7,6	53,4	20,0	51,4	19,2	48,3	17,9	46,7	17,2	45,2	16,5	42,1	15,2
		-5,0	-5,6	54,5	19,4	51,4	18,1	48,3	16,8	46,7	16,2	45,2	15,6	42,1	14,4
		-3,0	-3,7	54,5	18,4	51,4	17,1	48,3	16,0	46,7	15,4	45,2	14,8	42,1	13,7
		0,0	-0,7	54,5	16,9	51,4	15,8	48,3	14,7	46,7	14,2	45,2	13,7	42,1	12,6
		3,0	2,2	54,5	15,7	51,4	14,7	48,3	13,7	46,7	13,2	45,2	12,7	42,1	11,8
		5,0	4,1	54,5	15,0	51,4	14,0	48,3	13,1	46,7	12,6	45,2	12,2	42,1	11,3
		7,0	6,0	54,5	14,3	51,4	13,4	48,3	12,5	46,7	12,1	45,2	11,6	42,1	10,79
		9,0	7,9	54,5	13,7	51,4	12,8	48,3	12,0	46,7	11,6	45,2	11,2	42,1	10,36
		11,0	9,8	54,5	13,1	51,4	12,3	48,3	11,5	46,7	11,1	45,2	10,71	42,1	9,95
		13,0	11,8	54,5	12,6	51,4	11,8	48,3	11,0	46,7	10,65	45,2	10,28	42,1	9,55
		15,0	13,7	54,5	12,1	51,4	11,3	48,3	10,60	46,7	10,24	45,2	9,89	42,1	9,20
		60%	36,90 kW	-19,8	-20,0	38,6	19,6	38,5	20,1	38,5	20,5	38,4	20,8	38,4	21,0
-18,8	-19,0			39,8	19,8	39,7	20,2	39,7	20,7	39,6	20,9	38,7	20,4	36,1	18,8
-16,7	-17,0			42,2	20,1	42,1	20,5	41,4	20,5	40,1	19,7	38,7	18,9	36,1	17,4
-13,7	-15,0			44,5	20,3	44,1	20,5	41,4	19,0	40,1	18,3	38,7	17,6	36,1	16,2
-11,8	-13,0			46,7	20,4	44,1	19,1	41,4	17,7	40,1	17,1	38,7	16,4	36,1	15,1
-9,8	-11,0			46,7	19,1	44,1	17,8	41,4	16,6	40,1	16,0	38,7	15,4	36,1	14,2
-9,5	-10,0			46,7	18,5	44,1	17,3	41,4	16,1	40,1	15,5	38,7	14,9	36,1	13,8
-8,5	-9,1			46,7	18,0	44,1	16,8	41,4	15,6	40,1	15,1	38,7	14,5	36,1	13,4
-7,0	-7,6			46,7	17,2	44,1	16,1	41,4	15,0	40,1	14,4	38,7	13,9	36,1	12,9
-5,0	-5,6			46,7	16,2	44,1	15,2	41,4	14,1	40,1	13,6	38,7	13,1	36,1	12,2
-3,0	-3,7			46,7	15,4	44,1	14,4	41,4	13,4	40,1	12,9	38,7	12,5	36,1	11,6
0,0	-0,7			46,7	14,2	44,1	13,3	41,4	12,4	40,1	12,0	38,7	11,6	36,1	10,73
3,0	2,2			46,7	13,2	44,1	12,4	41,4	11,6	40,1	11,18	38,7	10,79	36,1	10,02
5,0	4,1			46,7	12,6	44,1	11,8	41,4	11,07	40,1	10,70	38,7	10,33	36,1	9,60
7,0	6,0			46,7	12,1	44,1	11,3	41,4	10,61	40,1	10,25	38,7	9,90	36,1	9,21
9,0	7,9			46,7	11,6	44,1	10,86	41,4	10,18	40,1	9,84	38,7	9,51	36,1	8,85
11,0	9,8			46,7	11,1	44,1	10,43	41,4	9,78	40,1	9,46	38,7	9,14	36,1	8,51
13,0	11,8			46,7	10,64	44,1	10,01	41,4	9,39	40,1	9,08	38,7	8,78	36,1	8,18
15,0	13,7			46,7	10,24	44,1	9,64	41,4	9,04	40,1	8,75	38,7	8,46	36,1	7,89
50%	30,75 kW			-19,8	-20,0	38,4	21,0	36,7	20,0	34,5	18,6	33,4	17,9	32,3	17,2
		-18,8	-19,0	38,9	20,6	36,7	19,2	34,5	17,8	33,4	17,2	32,3	16,5	30,1	15,2
		-16,7	-17,0	38,9	19,0	36,7	17,8	34,5	16,5	33,4	15,9	32,3	15,3	30,1	14,2
		-13,7	-15,0	38,9	17,7	36,7	16,5	34,5	15,4	33,4	14,9	32,3	14,3	30,1	13,2
		-11,8	-13,0	38,9	16,5	36,7	15,5	34,5	14,4	33,4	13,9	32,3	13,4	30,1	12,4
		-9,8	-11,0	38,9	15,5	36,7	14,5	34,5	13,5	33,4	13,1	32,3	12,6	30,1	11,67
		-9,5	-10,0	38,9	15,0	36,7	14,1	34,5	13,1	33,4	12,7	32,3	12,2	30,1	11,34
		-8,5	-9,1	38,9	14,6	36,7	13,7	34,5	12,8	33,4	12,3	32,3	11,9	30,1	11,05
		-7,0	-7,6	38,9	14,0	36,7	13,1	34,5	12,3	33,4	11,8	32,3	11,42	30,1	10,60
		-5,0	-5,6	38,9	13,2	36,7	12,4	34,5	11,6	33,4	11,21	32,3	10,82	30,1	10,05
		-3,0	-3,7	38,9	12,5	36,7	11,8	34,5	11,03	33,4	10,67	32,3	10,30	30,1	9,58
		0,0	-0,7	38,9	11,6	36,7									



# 5 Capacity tables

## 5 - 2 Heating Capacity Tables

RQYQ24PY1		TC: Total Capacity: kW ; PI: Power Input: kW (compressor + outdoor fan motor)														
Combination (%)	Capacity index (kW)	Outdoor air temp.		Indoor air temperature: °CDB												
				16.0		18.0		20.0		21.0		22.0		24.0		
				TC	PI	TC	PI	TC	PI	TC	PI	TC	PI	TC	PI	
130	87,10 kW	-19,8	-20,0	41,0	9,50	40,8	10,7	40,6	11,8	40,5	12,4	40,5	13,0	40,3	40,3	14,2
		-18,8	-19,0	42,3	10,2	42,1	11,3	42,0	12,4	41,9	13,0	41,8	13,5	41,6	41,6	14,6
		-16,7	-17,0	45,0	11,3	44,8	12,4	44,7	13,4	44,6	13,9	44,5	14,5	44,3	44,3	15,5
		-13,7	-15,0	47,7	12,3	47,5	13,3	47,4	14,3	47,3	14,8	47,2	15,2	47,0	47,0	16,2
		-11,8	-13,0	50,4	13,2	50,2	14,1	50,0	15,0	50,0	15,5	49,9	15,9	49,7	49,7	16,8
		-9,8	-11,0	53,1	13,9	52,9	14,8	52,7	15,6	52,6	16,1	52,6	16,5	52,4	52,4	17,3
		-9,5	-10,0	54,4	14,3	54,3	15,1	54,1	15,9	54,0	16,3	53,9	16,8	53,7	53,7	17,6
		-8,5	-9,1	55,6	14,6	55,5	15,4	55,3	16,2	55,2	16,6	55,1	17,0	54,9	54,9	17,8
		-7,0	-7,6	57,7	15,0	57,5	15,8	57,3	16,5	57,2	16,9	57,1	17,3	57,0	57,0	18,1
		-5,0	-5,6	60,3	15,5	60,2	16,2	60,0	16,9	59,9	17,3	59,8	17,7	59,7	59,7	18,4
		-3,0	-3,7	62,9	15,9	62,7	16,6	62,6	17,3	62,5	17,6	62,4	18,0	62,2	62,2	18,7
		0,0	-0,7	66,9	16,5	66,8	17,1	66,6	17,7	66,5	18,1	66,4	18,4	66,3	66,3	19,0
		3,0	2,2	70,8	16,9	70,7	17,5	70,5	18,1	70,4	18,4	70,3	18,7	70,2	70,2	19,3
		5,0	4,1	73,4	17,1	73,2	17,7	73,1	18,3	73,0	18,6	72,9	18,9	72,7	72,7	19,4
		7,0	6,0	76,0	17,4	75,8	17,9	75,6	18,4	75,5	18,7	75,4	19,0	75,3	75,3	19,5
		9,0	7,9	78,5	17,5	78,3	18,1	78,2	18,6	78,1	18,8	78,0	19,1	77,8	77,8	19,6
		11,0	9,8	81,1	17,7	80,9	18,2	80,7	18,7	80,6	18,9	80,6	19,2	80,4	80,4	19,7
13,0	11,8	83,8	17,8	83,6	18,3	83,4	18,8	83,3	19,0	83,3	19,3	83,1	83,1	19,7		
15,0	13,7	86,3	17,9	86,2	18,4	86,0	18,8	85,9	19,1	85,8	19,3	85,0	85,0	19,5		
120	80,40 kW	-19,8	-20,0	40,7	11,1	40,6	12,2	40,4	13,2	40,3	13,8	40,3	14,3	40,1	15,4	
		-18,8	-19,0	42,1	11,7	41,9	12,7	41,8	13,7	41,7	14,3	41,6	14,8	41,4	15,8	
		-16,7	-17,0	44,8	12,7	44,6	13,7	44,5	14,7	44,4	15,1	44,3	15,6	44,1	16,6	
		-13,7	-15,0	47,5	13,6	47,3	14,5	47,1	15,4	47,1	15,9	47,0	16,3	46,8	17,2	
		-11,8	-13,0	50,2	14,4	50,0	15,3	49,8	16,1	49,8	16,5	49,7	16,9	49,5	17,8	
		-9,8	-11,0	52,8	15,1	52,7	15,9	52,5	16,7	52,5	17,1	52,4	17,4	52,2	18,2	
		-9,5	-10,0	54,2	15,4	54,0	16,2	53,9	16,9	53,8	17,3	53,7	17,7	53,6	18,4	
		-8,5	-9,1	55,4	15,6	55,2	16,4	55,1	17,1	55,0	17,5	54,9	17,9	54,8	18,6	
		-7,0	-7,6	57,4	16,0	57,3	16,7	57,1	17,4	57,0	17,8	56,9	18,2	56,8	18,9	
		-5,0	-5,6	60,1	16,5	60,0	17,1	59,8	17,8	59,7	18,2	59,6	18,5	59,5	19,2	
		-3,0	-3,7	62,7	16,8	62,5	17,5	62,4	18,1	62,3	18,4	62,2	18,8	62,0	62,0	19,4
		0,0	-0,7	66,7	17,3	66,6	17,9	66,4	18,5	66,3	18,8	66,2	19,1	66,1	66,1	19,7
		3,0	2,2	70,6	17,7	70,5	18,3	70,3	18,8	70,2	19,1	70,1	19,4	70,0	70,0	19,9
		5,0	4,1	73,2	17,9	73,0	18,4	72,9	19,0	72,8	19,2	72,7	19,5	72,5	72,5	20,0
		7,0	6,0	75,7	18,1	75,6	18,6	75,4	19,1	75,3	19,3	75,3	19,6	75,1	75,1	20,1
		9,0	7,9	78,3	18,2	78,1	18,7	78,0	19,2	77,9	19,4	77,8	19,7	77,7	77,7	20,2
		11,0	9,8	80,8	18,4	80,7	18,8	80,5	19,3	80,4	19,5	80,4	19,7	80,4	80,4	19,5
13,0	11,8	83,5	18,5	83,4	18,9	83,2	19,4	83,1	19,6	83,1	19,8	83,0	83,0	18,6		
15,0	13,7	86,1	18,6	85,9	19,0	85,8	19,4	85,7	19,6	84,2	19,3	84,1	84,1	17,8		
110	73,70 kW	-19,8	-20,0	40,5	12,6	40,4	13,6	40,2	14,6	40,1	15,1	40,1	15,6	39,9	16,6	
		-18,8	-19,0	41,8	13,2	41,7	14,1	41,6	15,1	41,5	15,6	41,4	16,0	41,3	17,0	
		-16,7	-17,0	44,5	14,1	44,4	15,0	44,2	15,9	44,2	16,3	44,1	16,8	44,0	17,7	
		-13,7	-15,0	47,2	15,0	47,1	15,8	46,9	16,6	46,9	17,0	46,8	17,4	46,7	18,2	
		-11,8	-13,0	49,9	15,6	49,8	16,4	49,6	17,2	49,6	17,6	49,5	18,0	49,3	18,7	
		-9,8	-11,0	52,6	16,2	52,5	17,0	52,3	17,7	52,3	18,0	52,2	18,4	52,0	19,1	
		-9,5	-10,0	54,0	16,5	53,8	17,2	53,7	17,9	53,6	18,3	53,5	18,6	53,4	19,3	
		-8,5	-9,1	55,2	16,7	55,0	17,4	54,9	18,1	54,8	18,4	54,7	18,8	54,6	19,4	
		-7,0	-7,6	57,2	17,1	57,0	17,7	56,9	18,4	56,8	18,7	56,8	19,0	56,6	19,7	
		-5,0	-5,6	59,9	17,5	59,7	18,1	59,6	18,7	59,5	19,0	59,4	19,3	59,3	19,9	
		-3,0	-3,7	62,4	17,8	62,3	18,4	62,2	18,9	62,1	19,2	62,0	19,5	61,9	61,9	20,1
		0,0	-0,7	66,5	18,2	66,3	18,7	66,2	19,3	66,1	19,5	66,0	19,8	65,9	65,9	20,4
		3,0	2,2	70,4	18,5	70,2	19,0	70,1	19,5	70,0	19,8	69,9	20,0	69,8	69,8	20,5
		5,0	4,1	72,9	18,7	72,8	19,2	72,6	19,6	72,6	19,9	72,5	20,1	71,9	71,9	20,4
		7,0	6,0	75,5	18,8	75,4	19,3	75,2	19,7	75,1	20,0	75,1	20,2	71,9	71,9	19,4
		9,0	7,9	78,1	18,9	77,9	19,4	77,8	19,8	77,7	20,0	77,2	20,1	71,9	71,9	18,5
		11,0	9,8	80,6	19,0	80,5	19,5	80,3	19,9	79,8	19,9	77,2	19,2	71,9	71,9	17,6
13,0	11,8	83,3	19,1	83,2	19,5	82,5	19,7	79,8	19,0	77,2	18,2	71,9	71,9	16,8		
15,0	13,7	85,9	19,2	85,7	19,6	82,5	18,9	79,8	18,1	77,2	17,4	71,9	71,9	16,1		
100	67,00 kW	-19,8	-20,0	40,3	14,2	40,1	15,1	40,0	16,0	39,9	16,5	39,9	16,9	39,7	17,8	
		-18,8	-19,0	41,6	14,7	41,5	15,6	41,4	16,4	41,3	16,9	41,2	17,3	41,1	18,1	
		-16,7	-17,0	44,3	15,5	44,2	16,3	44,0	17,1	44,0	17,5	43,9	17,9	43,8	18,7	
		-13,7	-15,0	47,0	16,3	46,9	17,0	46,7	17,8	46,7	18,1	46,6	18,5	46,5	19,2	
		-11,8	-13,0	49,7	16,9	49,6	17,6	49,4	18,3	49,4	18,6	49,3	19,0	49,2	19,7	
		-9,8	-11,0	52,4	17,4	52,3	18,0	52,1	18,7	52,1	19,0	52,0	19,4	51,9	20,0	
		-9,5	-10,0	53,7	17,6	53,6	18,3	53,5	18,9	53,4	19,2	53,3	19,5	53,2	20,2	
		-8,5	-9,1	54,9	17,8	54,8	18,4	54,7	19,0	54,6	19,4	54,5	19,7	54,4	20,3	
		-7,0	-7,6	57,0	18,1	56,8	18,7	56,7	19,3	56,6	19,6	56,6	19,9	56,4	20,5	
		-5,0	-5,6	59,7	18,4	59,5	19,0	59,4	19,6	59,3	19,8	59,3	20,1	59,1	20,7	
		-3,0	-3,7	62,2	18,7	62,1	19,2	61,9	19,8	61,9	20,0	61,8	20,3	61,7	20,8	
		0,0	-0,7	66,2	19,1	66,1	19,6	66,0	20,0	65,9	20,3	65,9	20,5	65,4	20,8	
		3,0	2,2	70,1	19,3	70,0	19,8	69,9	20,2	69,8	20,5	69,8	20,7	65,4	19,2	
		5,0	4,1	72,7	19,5	72,6	19,9	72,4	20,3	72,4	20,5	70,2	19,8	65,4	18,2	
		7,0	6,0	75,3	19,6	75,1	20,0	75,0	20,4	72,6	19,6	70,2	18,9	65,4	17,4	
		9,0	7,9	77,8	19,6	77,7	20,0	75,0	19,4	72,6	18,7	70,2	18,0	65,4	16,5	
		11,0	9,8	80,4	19,7	79,8	19,9	75,0	18,5	72,6	17,8	70,2	17,1	65,4	15,8	
13,0	11,8	83,1	19,8	79,8	19,0	75,0	17,6	72,6	17,0	70,2	16,3	65,4	15,1			
15,0	13,7	84,6	19,4	79,8	18,1	75,0	16,9	72,6	16,2	70,2	15,6	65,4	14,4			

**NOTES - ANMERKUNGEN - Σημειώσεις - NOTAS - REMARQUES - NOTE - OPMERKINGEN - Примечания - NOTLAR**

- is shown as reference. When selecting the unit models, avoid the Outdoor air temperature range shown by
- dient als Verweis. Vermeiden Sie bei der Auswahl der Gerätemodelle den als markierten Temperaturbereich der Außenluft
- είναι ενδεικτική, κατά την επιλογή των μοντέλων των μονάδων, αποφύγετε το εύρος θερμοκρασίας εξωτερικού αέρα που υποδεικνύεται
- se muestra como referencia. Cuando seleccione los modelos de unidad, evite el intervalo de temperaturas del aire exterior indicado mediante
- est montré comme référence. Lors du choix des modèles d'unités, évitez la plage de températures de l'air extérieur illustré par
- valori riportati unicamente come riferimento. Nel selezionare i modelli delle unità, non considerare i valori di temperatura dell'aria esterna indicati con il colore
- is als referentie getoond. Wanneer modellen van eenheden worden gekozen, vermijd dan het bereik van buitenluchttemperaturen geïllustreerd door
- показан как. При выборе модели устройства избегайте внешнюю температуру

воздуха, указанную в  
referans olarak gösterilmektedir. Ünite modellerini seçerken, belirtilen Dış hava sıcaklığı aralığından kaçınm

The above table shows the average value of conditions which may occur.  
Die obige Tabelle zeigt den Durchschnittswert der Bedingungen, die auftreten können.  
Στον παραπάνω πίνακα αναγράφεται η μέση τιμή για συνθήκες που μπορεί να προκύψουν.  
La tabla de arriba muestra el valor medio de condiciones que pueden ocurrir.  
Le tableau ci-dessus donne la valeur moyenne pour des conditions qui peuvent survenir.  
La tabella in alto mostra il valore delle condizioni medie che si possono riscontrare.  
De tabel hierboven geeft de gemiddelde waarde aan van situaties die kunnen voorvallen.  
Таблица расположенная выше показывает среднее значение условий, которые могут наступить.  
Yukarıdaki tablo meydana gelebilecek koşulların ortalama değerini göstermektedir.

# 5 Capacity tables

## 5 - 2 Heating Capacity Tables

5

RQYQ24PY1

TC: Total Capacity: kW ; PI: Power Input: kW (compressor + outdoor fan motor)

Combination (%)	Capacity index (kW)	Outdoor air temp.		Indoor air temperature: °CDB											
				16.0		18.0		20.0		21.0		22.0		24.0	
				TC	PI	TC	PI	TC	PI	TC	PI	TC	PI	TC	PI
90%	60,30 kW	-19,8	-20,0	40,0	15,8	39,9	16,6	39,8	17,4	39,7	17,8	39,7	18,2	39,6	19,0
		-18,8	-19,0	41,4	16,2	41,3	17,0	41,1	17,8	41,1	18,1	41,0	18,5	40,9	19,3
		-16,7	-17,0	44,1	17,0	44,0	17,7	43,8	18,4	43,8	18,8	43,7	19,1	43,6	19,8
		-13,7	-15,0	46,8	17,6	46,6	18,2	46,5	18,9	46,5	19,3	46,4	19,6	46,3	20,3
		-11,8	-13,0	49,5	18,1	49,3	18,7	49,2	19,4	49,2	19,7	49,1	20,0	49,0	20,6
		-9,8	-11,0	52,2	18,5	52,0	19,1	51,9	19,7	51,9	20,0	51,8	20,3	51,7	20,9
		-9,5	-10,0	53,5	18,7	53,4	19,3	53,3	19,9	53,2	20,2	53,1	20,5	53,0	21,0
		-8,5	-9,1	54,7	18,9	54,6	19,5	54,5	20,0	54,4	20,3	54,4	20,6	54,2	21,1
		-7,0	-7,6	56,7	19,1	56,6	19,7	56,5	20,2	56,4	20,5	56,4	20,7	56,3	21,3
		-5,0	-5,6	59,4	19,4	59,3	19,9	59,2	20,4	59,1	20,7	59,1	20,9	58,8	21,4
		-3,0	-3,7	62,0	19,6	61,9	20,1	61,7	20,6	61,7	20,8	61,6	21,1	58,8	20,1
		0,0	-0,7	66,0	19,9	65,9	20,4	65,8	20,8	65,3	20,8	63,2	20,0	58,8	18,4
		3,0	2,2	69,9	20,1	69,8	20,5	67,5	19,9	65,3	19,2	63,2	18,4	58,8	17,0
		5,0	4,1	72,5	20,2	71,8	20,4	67,5	18,9	65,3	18,2	63,2	17,5	58,8	16,2
		7,0	6,0	75,0	20,3	71,8	19,4	67,5	18,0	65,3	17,3	63,2	16,7	58,8	15,4
		9,0	7,9	76,2	19,8	71,8	18,5	67,5	17,2	65,3	16,5	63,2	15,9	58,8	14,7
		11,0	9,8	76,2	18,9	71,8	17,6	67,5	16,4	65,3	15,8	63,2	15,2	58,8	14,0
		13,0	11,8	76,2	18,0	71,8	16,8	67,5	15,6	65,3	15,1	63,2	14,5	58,8	13,4
		15,0	13,7	76,2	17,2	71,8	16,1	67,5	15,0	65,3	14,4	63,2	13,9	58,8	12,9
		80%	53,60 kW	-19,8	-20,0	39,8	17,4	39,7	18,1	39,6	18,8	39,5	19,2	39,5	19,5
-18,8	-19,0			41,2	17,7	41,0	18,4	40,9	19,1	40,9	19,4	40,8	19,8	40,7	20,5
-16,7	-17,0			43,8	18,4	43,7	19,0	43,6	19,6	43,6	20,0	43,5	20,3	43,4	20,9
-13,7	-15,0			46,5	18,9	46,4	19,5	46,3	20,1	46,3	20,4	46,2	20,7	46,1	21,3
-11,8	-13,0			49,2	19,3	49,1	19,9	49,0	20,4	49,0	20,7	48,9	21,0	48,8	21,6
-9,8	-11,0			51,9	19,7	51,8	20,2	51,7	20,7	51,7	21,0	51,6	21,3	51,5	21,8
-9,5	-10,0			53,3	19,9	53,2	20,4	53,1	20,9	53,0	21,1	52,9	21,4	52,3	21,5
-8,5	-9,1			54,5	20,0	54,4	20,5	54,3	21,0	54,2	21,2	54,2	21,5	52,3	20,9
-7,0	-7,6			56,5	20,2	56,4	20,7	56,3	21,1	56,2	21,4	56,1	21,6	52,3	19,8
-5,0	-5,6			59,2	20,4	59,1	20,9	59,0	21,3	58,1	21,0	56,1	20,2	52,3	18,6
-3,0	-3,7			61,7	20,6	61,6	21,0	60,0	20,6	58,1	19,8	56,1	19,1	52,3	17,6
0,0	-0,7			65,8	20,8	63,9	20,3	60,0	18,8	58,1	18,1	56,1	17,5	52,3	16,1
3,0	2,2			67,7	20,0	63,9	18,7	60,0	17,4	58,1	16,7	56,1	16,1	52,3	14,9
5,0	4,1			67,7	19,0	63,9	17,7	60,0	16,5	58,1	15,9	56,1	15,3	52,3	14,2
7,0	6,0			67,7	18,1	63,9	16,9	60,0	15,7	58,1	15,2	56,1	14,6	52,3	13,5
9,0	7,9			67,7	17,2	63,9	16,1	60,0	15,0	58,1	14,5	56,1	14,0	52,3	12,9
11,0	9,8			67,7	16,4	63,9	15,4	60,0	14,4	58,1	13,8	56,1	13,3	52,3	12,4
13,0	11,8			67,7	15,7	63,9	14,7	60,0	13,7	58,1	13,2	56,1	12,7	52,3	11,8
15,0	13,7			67,7	15,0	63,9	14,1	60,0	13,1	58,1	12,7	56,1	12,2	52,3	11,3
70%	46,90 kW			-19,8	-20,0	39,6	18,9	39,5	19,6	39,4	20,2	39,3	20,5	39,3	20,8
		-18,8	-19,0	40,9	19,2	40,8	19,8	40,7	20,4	40,7	20,7	40,6	21,0	40,6	21,6
		-16,7	-17,0	43,6	19,8	43,5	20,3	43,4	20,9	43,4	21,2	43,3	21,4	43,2	22,0
		-13,7	-15,0	46,3	20,2	46,2	20,7	46,1	21,2	46,1	21,5	46,0	21,8	45,8	22,1
		-11,8	-13,0	49,0	20,5	48,9	21,0	48,8	21,5	48,8	21,8	48,7	22,0	45,8	20,5
		-9,8	-11,0	51,7	20,8	51,6	21,3	51,5	21,8	50,8	21,6	49,1	20,7	45,8	19,1
		-9,5	-10,0	53,0	21,0	52,9	21,4	52,5	21,6	50,8	20,8	49,1	20,0	45,8	18,4
		-8,5	-9,1	54,2	21,1	54,2	21,5	52,5	21,0	50,8	20,2	49,1	19,4	45,8	17,9
		-7,0	-7,6	56,3	21,2	55,9	21,5	52,5	19,9	50,8	19,2	49,1	18,4	45,8	17,0
		-5,0	-5,6	59,0	21,4	55,9	20,1	52,5	18,7	50,8	18,0	49,1	17,3	45,8	16,0
		-3,0	-3,7	59,2	20,3	55,9	18,9	52,5	17,6	50,8	17,0	49,1	16,3	45,8	15,1
		0,0	-0,7	59,2	18,6	55,9	17,4	52,5	16,2	50,8	15,6	49,1	15,0	45,8	13,9
		3,0	2,2	59,2	17,1	55,9	16,0	52,5	14,9	50,8	14,4	49,1	13,9	45,8	12,9
		5,0	4,1	59,2	16,3	55,9	15,2	52,5	14,2	50,8	13,7	49,1	13,2	45,8	12,3
		7,0	6,0	59,2	15,5	55,9	14,5	52,5	13,6	50,8	13,1	49,1	12,6	45,8	11,7
		9,0	7,9	59,2	14,8	55,9	13,9	52,5	13,0	50,8	12,5	49,1	12,1	45,8	11,2
		11,0	9,8	59,2	14,2	55,9	13,3	52,5	12,4	50,8	12,0	49,1	11,6	45,8	10,7
		13,0	11,8	59,2	13,5	55,9	12,7	52,5	11,9	50,8	11,5	49,1	11,1	45,8	10,3
		15,0	13,7	59,2	13,0	55,9	12,2	52,5	11,4	50,8	11,0	49,1	10,6	45,8	9,87
		60%	40,20 kW	-19,8	-20,0	39,3	20,5	39,3	21,0	39,2	21,6	39,1	21,8	39,1	22,1
-18,8	-19,0			40,7	20,7	40,6	21,3	40,5	21,8	40,5	22,0	40,5	22,3	39,2	21,8
-16,7	-17,0			43,4	21,2	43,3	21,6	43,2	22,1	43,2	22,4	42,1	21,8	39,2	20,0
-13,7	-15,0			46,1	21,5	46,0	21,9	45,0	21,7	43,6	20,9	42,1	20,1	39,2	18,5
-11,8	-13,0			48,8	21,8	47,9	21,6	45,0	20,1	43,6	19,3	42,1	18,6	39,2	17,2
-9,8	-11,0			50,8	21,5	47,9	20,1	45,0	18,7	43,6	18,0	42,1	17,3	39,2	16,0
-9,5	-10,0			50,8	20,8	47,9	19,4	45,0	18,1	43,6	17,4	42,1	16,7	39,2	15,5
-8,5	-9,1			50,8	20,2	47,9	18,8	45,0	17,5	43,6	16,9	42,1	16,3	39,2	15,0
-7,0	-7,6			50,8	19,2	47,9	17,9	45,0	16,7	43,6	16,1	42,1	15,5	39,2	14,3
-5,0	-5,6			50,8	18,0	47,9	16,8	45,0	15,7	43,6	15,1	42,1	14,6	39,2	13,5
-3,0	-3,7			50,8	17,0	47,9	15,9	45,0	14,8	43,6	14,3	42,1	13,8	39,2	12,8
0,0	-0,7			50,8	15,6	47,9	14,6	45,0	13,6	43,6	13,2	42,1	12,7	39,2	11,8
3,0	2,2			50,8	14,4	47,9	13,5	45,0	12,6	43,6	12,2	42,1	11,8	39,2	10,9
5,0	4,1			50,8	13,7	47,9	12,9	45,0	12,0	43,6	11,6	42,1	11,2	39,2	10,45
7,0	6,0			50,8	13,1	47,9	12,3	45,0	11,5	43,6	11,1	42,1	10,7	39,2	10,00
9,0	7,9			50,8	12,5	47,9	11,8	45,0	11,0	43,6	10,6	42,1	10,29	39,2	9,58
11,0	9,8			50,8	12,0	47,9	11,3	45,0	10,6	43,6	10,21	42,1	9,87	39,2	9,19
13,0	11,8			50,8	11,5	47,9	10,8	45,0	10,11	43,6	9,78	42,1	9,45	39,2	8,81
15,0	13,7			50,8	11,0	47,9	10,3	45,0	9,71	43,6	9,40	42,1	9,09	39,2	8,48
50%	33,50 kW			-19,8	-20,0	39,1	22,1	39,0	22,5	37,5	21,64	36,3	20,8	35,1	20,0
		-18,8	-19,0	40,5	22,3	39,9	22,3	37,5	20,7	36,3	19,9	35,1	19,2	32,7	17,7
		-16,7	-17,0	42,3	21,9	39,9	20,4	37,5	19,0	36,3	18,3	35,1	17,6	32,7	16,3
		-13,7	-15,0	42,3	20,2	39,9	18,9	37,5	17,6	36,3	16,9	35,1	16,3	32,7	15,1
		-11,8	-13,0	42,3	18,7	39,9	17,5	37,5	16,3	36,3	15,7	35,1	15,2	32,7	14,0
		-9,8	-11,0	42,3	17,4	39,9	16,3	37,5	15,2	36,3	14,7	35,1	14,2	32,7	13,1
		-9,5	-10,0	42,3	16,8	39,9	15,8	37,5	14,7	36,3	14,2	35,1	13,7	32,7	12,7
		-8,5	-9,1	42,3	16,3	39,9	15,3	37,5	14,3	36,3	13,8	35,1	13,3	32,7	12,3
		-7,0	-7,6	42,3	15,6	39,9	14,6	37,5	13,6	36,3	13,2	35,1	12,7	32,7	11,8
		-5,0	-5,6	42,3	14,7	39,9	13,7	37,5	12,9	36,3	12,4	35,1	12,0	32,7	11,1
		-3,0	-3,7	42,3	13,9	39,9	13,0	37,5	12,2	36,3	11,8	35,1	11,4	32,7	10,57
		0,0	-0,7	42,3	12,8	39,9	12,0	37,5	11,2	36,3	10,9	35,1	10,50		



# 5 Capacity tables

## 5 - 2 Heating Capacity Tables

### RQYQ26PY1

TC: Total Capacity: kW ; PI: Power Input: kW (compressor + outdoor fan motor)

Combination (%)	Capacity index (kW)	Outdoor air temp.		Indoor air temperature: °CDB											
				16.0		18.0		20.0		21.0		22.0		24.0	
				TC	PI	TC	PI	TC	PI	TC	PI	TC	PI	TC	PI
130	94,90 kW	-19,8	-20,0	46,8	12,53	46,6	13,8	46,4	15,1	46,3	15,7	46,2	16,3	46,1	17,6
		-18,8	-19,0	48,4	13,2	48,2	14,5	48,0	15,7	47,9	16,3	47,8	16,9	47,6	18,1
		-16,7	-17,0	51,5	14,5	51,3	15,6	51,1	16,8	51,0	17,4	50,9	17,9	50,7	19,1
		-13,7	-15,0	54,6	15,6	54,4	16,6	54,2	17,7	54,1	18,2	54,0	18,8	53,8	19,8
		-11,8	-13,0	57,7	16,5	57,5	17,5	57,3	18,5	57,2	19,0	57,1	19,5	56,9	20,5
		-9,8	-11,0	60,8	17,3	60,6	18,2	60,4	19,2	60,3	19,6	60,2	20,1	60,0	21,0
		-9,5	-10,0	62,3	17,7	62,1	18,6	61,9	19,5	61,8	19,9	61,8	20,4	61,6	21,3
		-8,5	-9,1	63,7	18,0	63,5	18,8	63,3	19,7	63,2	20,2	63,1	20,6	63,0	21,5
		-7,0	-7,6	66,0	18,4	65,8	19,3	65,7	20,1	65,6	20,5	65,5	20,9	65,3	21,8
		-5,0	-5,6	69,1	18,9	68,9	19,7	68,8	20,5	68,7	20,9	68,6	21,3	68,4	22,1
		-3,0	-3,7	72,1	19,4	71,9	20,1	71,7	20,9	71,6	21,3	71,5	21,6	71,3	22,4
		0,0	-0,7	76,7	20,0	76,5	20,7	76,4	21,4	76,3	21,7	76,2	22,0	76,0	22,7
		3,0	2,2	81,2	20,4	81,0	21,0	80,8	21,7	80,8	22,0	80,7	22,3	80,5	23,0
		5,0	4,1	84,2	20,6	84,0	21,3	83,8	21,9	83,7	22,2	83,6	22,5	83,4	23,1
		7,0	6,0	87,1	20,8	86,9	21,4	86,7	22,0	86,6	22,3	86,6	22,6	86,4	23,2
		9,0	7,9	90,1	21,0	89,9	21,6	89,7	22,2	89,6	22,4	89,5	22,7	89,3	23,3
		11,0	9,8	93,0	21,2	92,8	21,7	92,6	22,2	92,5	22,5	92,4	22,8	92,3	23,3
		13,0	11,8	96,1	21,3	95,9	21,8	95,7	22,3	95,6	22,6	95,5	22,8	95,3	23,2
		15,0	13,7	99,1	21,4	98,9	21,9	98,7	22,4	98,6	22,6	98,5	22,9	98,3	23,2
		120	87,60 kW	-19,8	-20,0	46,6	14,2	46,4	15,4	46,2	16,6	46,1	17,2	46,0	17,8
-18,8	-19,0			48,1	14,9	47,9	16,0	47,8	17,2	47,7	17,7	47,6	18,3	47,4	19,4
-16,7	-17,0			51,2	16,0	51,0	17,1	50,9	18,1	50,8	18,7	50,7	19,2	50,5	20,2
-13,7	-15,0			54,3	17,0	54,1	18,0	54,0	19,0	53,9	19,5	53,8	20,0	53,6	20,9
-11,8	-13,0			57,4	17,8	57,2	18,8	57,1	19,7	57,0	20,1	56,9	20,6	56,7	21,5
-9,8	-11,0			60,5	18,6	60,3	19,4	60,2	20,3	60,1	20,7	60,0	21,1	59,8	22,0
-9,5	-10,0			62,1	18,9	61,9	19,7	61,7	20,5	61,6	21,0	61,5	21,4	61,4	22,2
-8,5	-9,1			63,5	19,1	63,3	20,0	63,1	20,8	63,0	21,2	62,9	21,6	62,8	22,4
-7,0	-7,6			65,8	19,5	65,6	20,3	65,4	21,1	65,3	21,5	65,3	21,9	65,1	22,6
-5,0	-5,6			68,9	20,0	68,7	20,7	68,5	21,5	68,4	21,8	68,4	22,2	68,2	22,9
-3,0	-3,7			71,8	20,4	71,7	21,1	71,5	21,8	71,4	22,1	71,3	22,5	71,1	23,2
0,0	-0,7			76,5	20,9	76,3	21,5	76,1	22,2	76,0	22,5	76,0	22,8	75,8	23,5
3,0	2,2			81,0	21,3	80,8	21,9	80,6	22,5	80,5	22,8	80,5	23,1	80,3	23,7
5,0	4,1			83,9	21,5	83,7	22,0	83,6	22,6	83,5	22,9	83,4	23,2	83,2	23,8
7,0	6,0			86,9	21,6	86,7	22,2	86,5	22,7	86,4	23,0	86,3	23,3	86,2	23,4
9,0	7,9			89,8	21,8	89,6	22,3	89,5	22,8	89,4	23,1	89,3	23,4	89,2	23,3
11,0	9,8			92,8	21,9	92,6	22,4	92,4	22,9	92,3	23,2	92,2	23,5	92,1	23,2
13,0	11,8			95,9	22,0	95,7	22,5	95,5	22,9	95,4	23,2	95,3	23,5	95,2	23,2
15,0	13,7			98,8	22,1	98,6	22,5	98,4	22,9	98,3	23,2	98,2	23,5	98,1	23,3
110	80,30 kW			-19,8	-20,0	46,3	16,0	46,1	17,0	46,0	18,1	45,9	18,7	45,8	19,2
		-18,8	-19,0	47,9	16,6	47,7	17,6	47,5	18,6	47,5	19,1	47,4	19,7	47,2	20,7
		-16,7	-17,0	51,0	17,6	50,8	18,5	50,6	19,5	50,6	20,0	50,5	20,5	50,3	21,4
		-13,7	-15,0	54,1	18,4	53,9	19,3	53,7	20,2	53,7	20,7	53,6	21,1	53,4	22,0
		-11,8	-13,0	57,2	19,2	57,0	20,0	56,8	20,9	56,8	21,3	56,7	21,7	56,5	22,5
		-9,8	-11,0	60,3	19,8	60,1	20,6	59,9	21,4	59,9	21,8	59,8	22,2	59,6	23,0
		-9,5	-10,0	61,8	20,1	61,6	20,9	61,5	21,6	61,4	22,0	61,3	22,4	61,2	23,1
		-8,5	-9,1	63,2	20,3	63,0	21,1	62,9	21,8	62,8	22,2	62,7	22,6	62,6	23,3
		-7,0	-7,6	65,5	20,7	65,4	21,4	65,2	22,1	65,1	22,5	65,1	22,8	64,9	23,5
		-5,0	-5,6	68,6	21,1	68,5	21,8	68,3	22,4	68,2	22,8	68,2	23,1	68,0	23,8
		-3,0	-3,7	71,6	21,4	71,4	22,1	71,3	22,7	71,2	23,0	71,1	23,3	70,9	24,0
		0,0	-0,7	76,2	21,8	76,1	22,4	75,9	23,0	75,8	23,3	75,8	23,6	75,6	24,2
		3,0	2,2	80,7	22,2	80,6	22,7	80,4	23,2	80,3	23,5	80,2	23,8	80,1	23,4
		5,0	4,1	83,7	22,3	83,5	22,8	83,3	23,4	83,3	23,6	83,2	23,9	83,1	23,2
		7,0	6,0	86,6	22,4	86,5	22,9	86,3	23,4	86,2	23,7	86,1	24,0	86,0	23,7
		9,0	7,9	89,6	22,6	89,4	23,0	89,2	23,5	89,1	23,8	89,0	24,1	88,9	23,8
		11,0	9,8	92,5	22,6	92,3	23,1	92,1	23,6	92,0	23,9	91,9	24,2	91,8	24,0
		13,0	11,8	95,6	22,7	95,4	23,1	95,2	23,6	95,1	23,9	95,0	24,1	94,9	23,9
		15,0	13,7	98,5	22,7	98,3	23,1	98,1	23,6	98,0	23,9	97,9	24,1	97,8	24,0
		100	73,00 kW	-19,8	-20,0	46,1	17,7	45,9	18,7	45,8	19,6	45,7	20,1	45,6	20,6
-18,8	-19,0			47,6	18,2	47,5	19,1	47,3	20,1	47,2	20,6	47,2	21,0	47,0	22,0
-16,7	-17,0			50,7	19,1	50,6	20,0	50,4	20,9	50,3	21,3	50,3	21,7	50,1	22,6
-13,7	-15,0			53,8	19,9	53,7	20,7	53,5	21,5	53,4	21,9	53,4	22,3	53,2	23,1
-11,8	-13,0			56,9	20,5	56,8	21,3	56,6	22,1	56,5	22,4	56,5	22,8	56,3	23,6
-9,8	-11,0			60,0	21,1	59,9	21,8	59,7	22,5	59,6	22,9	59,6	23,2	59,4	23,9
-9,5	-10,0			61,6	21,3	61,4	22,0	61,3	22,7	61,2	23,0	61,1	23,4	61,0	24,1
-8,5	-9,1			62,9	21,5	62,8	22,2	62,7	22,9	62,6	23,2	62,5	23,5	62,4	24,2
-7,0	-7,6			65,3	21,8	65,1	22,5	65,0	23,1	64,9	23,4	64,8	23,8	64,7	24,4
-5,0	-5,6			68,4	22,2	68,2	22,8	68,1	23,4	68,0	23,7	67,9	24,0	67,8	24,6
-3,0	-3,7			71,3	22,4	71,2	23,0	71,0	23,6	71,0	23,9	70,9	24,2	70,7	24,8
0,0	-0,7			76,0	22,8	75,8	23,3	75,7	23,9	75,6	24,1	75,5	24,4	75,4	24,7
3,0	2,2			80,5	23,0	80,3	23,5	80,2	24,0	80,1	24,3	80,0	24,6	79,9	24,9
5,0	4,1			83,4	23,2	83,3	23,6	83,2	24,1	83,1	24,4	83,0	24,7	82,9	25,0
7,0	6,0			86,4	23,2	86,2	23,7	86,1	24,2	86,0	24,5	85,9	24,8	85,8	25,1
9,0	7,9			89,3	23,3	89,1	23,8	89,0	24,3	88,9	24,6	88,8	24,9	88,7	25,2
11,0	9,8			92,0	23,3	91,8	23,8	91,7	24,3	91,6	24,6	91,5	24,9	91,4	25,3
13,0	11,8			94,9	23,3	94,7	23,8	94,6	24,3	94,5	24,6	94,4	24,9	94,3	25,3
15,0	13,7			97,8	23,3	97,6	23,8	97,5	24,3	97,4	24,6	97,3	24,9	97,2	25,3

#### NOTES - ANMERKUNGEN - Σημειώσεις - NOTAS - REMARQUES - NOTE - OPMERKINGEN - Примечания - NOTLAR

- is shown as reference. When selecting the unit models, avoid the Outdoor air temperature range shown by
- dient als Verweis. Vermeiden Sie bei der Auswahl der Gerätemodelle den als markierten Temperaturbereich der Außenluft
- Η είναι ενδεικτική, κατά την επιλογή των μοντέλων των μονάδων, αποφύγετε το εύρος θερμοκρασίας εξωτερικού αέρα που υποδεικνύεται
- se muestra como referencia. Cuando seleccione los modelos de unidad, evite el intervalo de temperaturas del aire exterior indicado mediante
- est montré comme référence. Lors du choix des modèles d'unités, évitez la plage de températures de l'air extérieur illustré par
- valori riportati unicamente come riferimento. Nel selezionare i modelli delle unità, non considerare i valori di temperatura dell'aria esterna indicati con il colore
- is als referentie getoond. Wanneer modellen van eenheden worden gekozen, vermijd dan het bereik van buitenluchttemperaturen geïllustreerd door
- показан как. При выборе модели устройства избегайте внешнюю температуру

воздуха, указанную в  
referans olarak gösterilmektedir. Ünite modellerini seçerken, belirtilen Dış hava sıcaklığı aralığından kaçının

The above table shows the average value of conditions which may occur.  
Die obige Tabelle zeigt den Durchschnittswert der Bedingungen, die auftreten können.  
Στον παραπάνω πίνακα αναγράφεται η μέση τιμή για συνθήκες που μπορεί να προκύψουν.  
La tabla de arriba muestra el valor medio de condiciones que pueden ocurrir.  
Le tableau ci-dessus donne la valeur moyenne pour des conditions qui peuvent survenir.  
La tabella in alto mostra il valore delle condizioni medie che si possono riscontrare.  
De tabel hierboven geeft de gemiddelde waarde aan van situaties die kunnen voorvallen.  
Таблица расположенная выше показывает среднее значение условий, которые могут наступить.  
Yukarıdaki tablo meydana gelebilecek koşulların ortalama değerini göstermektedir.

# 5 Capacity tables

## 5 - 2 Heating Capacity Tables

5

RQYQ26PY1

TC: Total Capacity: kW ; PI: Power Input: kW (compressor + outdoor fan motor)

Combination (%)	Capacity index (kW)	Outdoor air temp.		Indoor air temperature: °CDB											
				16.0		18.0		20.0		21.0		22.0		24.0	
				TC	PI	TC	PI	TC	PI	TC	PI	TC	PI	TC	PI
90%	65,70 kW	-19,8	-20,0	45,8	19,4	45,7	20,3	45,5	21,2	45,5	21,6	45,4	22,1	45,3	22,9
		-18,8	-19,0	47,4	19,9	47,2	20,7	47,1	21,6	47,0	22,0	47,0	22,4	46,8	23,3
		-16,7	-17,0	50,5	20,7	50,3	21,4	50,2	22,2	50,1	22,6	50,1	23,0	49,9	23,8
		-13,7	-15,0	53,6	21,3	53,4	22,0	53,3	22,8	53,2	23,1	53,2	23,5	53,0	24,2
		-11,8	-13,0	56,7	21,9	56,5	22,6	56,4	23,2	56,3	23,6	56,3	23,9	56,1	24,6
		-9,8	-11,0	59,8	22,3	59,6	23,0	59,5	23,6	59,4	23,9	59,4	24,3	59,2	24,9
		-9,5	-10,0	61,3	22,5	61,2	23,2	61,0	23,8	61,0	24,1	60,9	24,4	60,8	25,0
		-8,5	-9,1	62,7	22,7	62,6	23,3	62,4	23,9	62,4	24,2	62,3	24,5	62,2	25,1
		-7,0	-7,6	65,0	22,9	64,9	23,5	64,8	24,1	64,7	24,4	64,6	24,7	63,9	24,9
		-5,0	-5,6	68,1	23,2	68,0	23,8	67,9	24,3	67,8	24,6	67,7	24,9	63,9	23,3
		-3,0	-3,7	71,1	23,5	70,9	24,0	70,8	24,5	70,7	24,8	68,6	23,9	63,9	22,0
		0,0	-0,7	75,7	23,7	75,6	24,2	73,4	23,6	71,0	22,7	68,6	21,8	63,9	20,1
		3,0	2,2	80,2	23,9	78,1	23,4	73,4	21,7	71,0	20,9	68,6	20,1	63,9	18,5
		5,0	4,1	82,8	23,8	78,1	22,2	73,4	20,6	71,0	19,8	68,6	19,1	63,9	17,6
		7,0	6,0	82,8	22,6	78,1	21,1	73,4	19,6	71,0	18,9	68,6	18,2	63,9	16,8
		9,0	7,9	82,8	21,5	78,1	20,1	73,4	18,7	71,0	18,0	68,6	17,3	63,9	16,0
		11,0	9,8	82,8	20,5	78,1	19,1	73,4	17,8	71,0	17,2	68,6	16,5	63,9	15,3
		13,0	11,8	82,8	19,5	78,1	18,2	73,4	17,0	71,0	16,4	68,6	15,8	63,9	14,6
		15,0	13,7	82,8	18,7	78,1	17,4	73,4	16,3	71,0	15,7	68,6	15,1	63,9	14,0
		80%	58,40 kW	-19,8	-20,0	45,5	21,1	45,4	21,9	45,3	22,7	45,3	23,1	45,2	23,5
-18,8	-19,0			47,1	21,5	47,0	22,3	46,9	23,0	46,8	23,4	46,8	23,8	46,6	24,5
-16,7	-17,0			50,2	22,2	50,1	22,9	50,0	23,6	49,9	23,9	49,9	24,3	49,7	25,0
-13,7	-15,0			53,3	22,7	53,2	23,4	53,1	24,0	53,0	24,4	53,0	24,7	52,8	25,4
-11,8	-13,0			56,4	23,2	56,3	23,8	56,2	24,4	56,1	24,7	56,1	25,0	55,9	25,6
-9,8	-11,0			59,5	23,6	59,4	24,2	59,3	24,7	59,2	25,0	59,2	25,3	56,8	24,4
-9,5	-10,0			61,1	23,7	60,9	24,3	60,8	24,9	60,8	25,1	60,7	25,4	56,8	23,5
-8,5	-9,1			62,4	23,9	62,3	24,4	62,2	25,0	62,2	25,2	61,0	24,8	56,8	22,8
-7,0	-7,6			64,8	24,1	64,7	24,6	64,5	25,1	63,1	24,5	61,0	23,6	56,8	21,7
-5,0	-5,6			67,9	24,3	67,8	24,8	65,2	23,9	63,1	23,0	61,0	22,1	56,8	20,3
-3,0	-3,7			70,8	24,5	69,4	24,2	65,2	22,5	63,1	21,6	61,0	20,8	56,8	19,1
0,0	-0,7			73,6	23,7	69,4	22,1	65,2	20,5	63,1	19,8	61,0	19,0	56,8	17,5
3,0	2,2			73,6	21,8	69,4	20,3	65,2	18,9	63,1	18,2	61,0	17,5	56,8	16,2
5,0	4,1			73,6	20,7	69,4	19,3	65,2	18,0	63,1	17,3	61,0	16,7	56,8	15,4
7,0	6,0			73,6	19,7	69,4	18,4	65,2	17,1	63,1	16,5	61,0	15,9	56,8	14,7
9,0	7,9			73,6	18,7	69,4	17,5	65,2	16,3	63,1	15,8	61,0	15,2	56,8	14,0
11,0	9,8			73,6	17,9	69,4	16,7	65,2	15,6	63,1	15,1	61,0	14,5	56,8	13,4
13,0	11,8			73,6	17,0	69,4	16,0	65,2	14,9	63,1	14,4	61,0	13,9	56,8	12,8
15,0	13,7			73,6	16,3	69,4	15,3	65,2	14,3	63,1	13,8	61,0	13,3	56,8	12,3
70%	51,10 kW			-19,8	-20,0	45,3	22,8	45,2	23,5	45,1	24,2	45,0	24,6	45,0	24,9
		-18,8	-19,0	46,8	23,2	46,7	23,8	46,6	24,5	46,6	24,8	46,5	25,1	46,4	25,8
		-16,7	-17,0	49,9	23,7	49,8	24,3	49,7	24,9	49,7	25,3	49,6	25,6	49,5	26,2
		-13,7	-15,0	53,0	24,2	52,9	24,7	52,8	25,3	52,8	25,6	52,7	25,9	49,7	24,2
		-11,8	-13,0	56,1	24,5	56,0	25,1	55,9	25,6	55,2	25,4	53,4	24,4	49,7	22,4
		-9,8	-11,0	59,2	24,8	59,1	25,3	57,1	24,5	55,2	23,6	53,4	22,6	49,7	20,8
		-9,5	-10,0	60,8	25,0	60,7	25,5	57,1	23,6	55,2	22,7	53,4	21,8	49,7	20,1
		-8,5	-9,1	62,2	25,1	60,7	24,7	57,1	22,9	55,2	22,0	53,4	21,2	49,7	19,5
		-7,0	-7,6	64,4	25,1	60,7	23,4	57,1	21,8	55,2	20,9	53,4	20,1	49,7	18,6
		-5,0	-5,6	64,4	23,5	60,7	21,9	57,1	20,4	55,2	19,6	53,4	18,9	49,7	17,4
		-3,0	-3,7	64,4	22,1	60,7	20,7	57,1	19,2	55,2	18,5	53,4	17,8	49,7	16,5
		0,0	-0,7	64,4	20,2	60,7	18,9	57,1	17,6	55,2	17,0	53,4	16,4	49,7	15,1
		3,0	2,2	64,4	18,7	60,7	17,5	57,1	16,3	55,2	15,7	53,4	15,1	49,7	14,0
		5,0	4,1	64,4	17,7	60,7	16,6	57,1	15,5	55,2	14,9	53,4	14,4	49,7	13,3
		7,0	6,0	64,4	16,9	60,7	15,8	57,1	14,8	55,2	14,3	53,4	13,7	49,7	12,7
		9,0	7,9	64,4	16,1	60,7	15,1	57,1	14,1	55,2	13,6	53,4	13,1	49,7	12,2
		11,0	9,8	64,4	15,4	60,7	14,4	57,1	13,5	55,2	13,0	53,4	12,6	49,7	11,7
		13,0	11,8	64,4	14,7	60,7	13,8	57,1	12,9	55,2	12,5	53,4	12,0	49,7	11,2
		15,0	13,7	64,4	14,1	60,7	13,2	57,1	12,4	55,2	11,9	53,4	11,5	49,7	10,7
		60%	43,80 kW	-19,8	-20,0	45,0	24,6	45,0	25,2	44,9	25,7	44,8	26,0	44,8	26,3
-18,8	-19,0			46,6	24,8	46,5	25,4	46,4	26,0	46,4	26,2	46,4	26,0	42,6	23,9
-16,7	-17,0			49,7	25,3	49,6	25,8	48,9	25,8	47,3	24,8	45,8	23,8	42,6	21,9
-13,7	-15,0			52,8	25,6	52,0	25,6	48,9	23,7	47,3	22,8	45,8	21,9	42,6	20,2
-11,8	-13,0			55,2	25,4	52,0	23,6	48,9	22,0	47,3	21,1	45,8	20,3	42,6	18,7
-9,8	-11,0			55,2	23,5	52,0	22,0	48,9	20,4	47,3	19,7	45,8	18,9	42,6	17,5
-9,5	-10,0			55,2	22,7	52,0	21,2	48,9	19,7	47,3	19,0	45,8	18,3	42,6	16,9
-8,5	-9,1			55,2	22,0	52,0	20,6	48,9	19,1	47,3	18,4	45,8	17,7	42,6	16,4
-7,0	-7,6			55,2	20,9	52,0	19,6	48,9	18,2	47,3	17,6	45,8	16,9	42,6	15,6
-5,0	-5,6			55,2	19,6	52,0	18,3	48,9	17,1	47,3	16,5	45,8	15,9	42,6	14,7
-3,0	-3,7			55,2	18,5	52,0	17,3	48,9	16,2	47,3	15,6	45,8	15,0	42,6	13,9
0,0	-0,7			55,2	17,0	52,0	15,9	48,9	14,9	47,3	14,3	45,8	13,8	42,6	12,8
3,0	2,2			55,2	15,7	52,0	14,7	48,9	13,8	47,3	13,3	45,8	12,8	42,6	11,9
5,0	4,1			55,2	14,9	52,0	14,0	48,9	13,1	47,3	12,7	45,8	12,2	42,6	11,4
7,0	6,0			55,2	14,2	52,0	13,4	48,9	12,5	47,3	12,1	45,8	11,7	42,6	10,9
9,0	7,9			55,2	13,6	52,0	12,8	48,9	12,0	47,3	11,6	45,8	11,2	42,6	10,42
11,0	9,8			55,2	13,0	52,0	12,2	48,9	11,5	47,3	11,1	45,8	10,7	42,6	9,99
13,0	11,8			55,2	12,4	52,0	11,7	48,9	11,0	47,3	10,6	45,8	10,27	42,6	9,58
15,0	13,7			55,2	11,9	52,0	11,2	48,9	10,5	47,3	10,2	45,8	9,87	42,6	9,21
50%	36,50 kW			-19,8	-20,0	44,8	26,3	43,4	25,5	40,8	23,7	39,4	22,8	38,1	21,9
		-18,8	-19,0	46,0	26,2	43,4	24,4	40,8	22,7	39,4	21,8	38,1	21,0	35,5	19,3
		-16,7	-17,0	46,0	24,0	43,4	22,4	40,8	20,8	39,4	20,0	38,1	19,3	35,5	17,8
		-13,7	-15,0	46,0	22,1	43,4	20,6	40,8	19,2	39,4	18,5	38,1	17,8	35,5	16,5
		-11,8	-13,0	46,0	20,5	43,4	19,1	40,8	17,8	39,4	17,2	38,1	16,6	35,5	15,3
		-9,8	-11,0	46,0	19,0	43,4	17,8	40,8	16,6	39,4	16,0	38,1	15,5	35,5	14,3
		-9,5	-10,0	46,0	18,4	43,4	17,2	40,8	16,1	39,4	15,5	38,1	15,0	35,5	13,9
		-8,5	-9,1	46,0	17,8	43,4	16,7	40,8	15,6	39,4	15,1	38,1	14,5	35,5	13,5
		-7,0	-7,6	46,0	17,0	43,4	15,9	40,8	14,9	39,4	14,4	38,1	13,9	35,5	12,9
		-5,0	-5,6	46,0	16,0	43,4	15,0	40,8	14,0	39,4	13,5	38,1	13,1	35,5	12,2
		-3,0	-3,7	46,0	15,1	43,4	14,2	40,8	13,3	39,4	12,8	38,1	12,4	35,5	11,5
		0,0	-0,7	46,0	13,9	43,4	13,1	40,8	12,2	39,4	11,8	38,1	11,4	35,	

# 5 Capacity tables

## 5 - 2 Heating Capacity Tables

**RQYQ28PY1**

TC: Total Capacity: kW ; PI: Power Input: kW (compressor + outdoor fan motor)

Combination (%)	Capacity index (kW)	Outdoor air temp.		Indoor air temperature: °CDB											
				16.0		18.0		20.0		21.0		22.0		24.0	
				TC	PI	TC	PI	TC	PI	TC	PI	TC	PI	TC	PI
		°CDB	°CWB	kW	kW	kW	kW	kW	kW	kW	kW	kW	kW	kW	kW
130	102,05 kW	-19,8	-20,0	50,0	13,8	49,8	15,2	49,6	16,6	49,5	17,4	49,4	18,1	49,2	19,5
		-18,8	-19,0	51,6	14,5	51,4	15,9	51,2	17,3	51,1	18,0	51,0	18,7	50,8	20,1
		-16,7	-17,0	54,8	15,9	54,6	17,2	54,4	18,4	54,3	19,1	54,2	19,7	54,0	21,0
		-13,7	-15,0	58,1	17,0	57,9	18,2	57,7	19,4	57,6	20,0	57,5	20,6	57,3	21,8
		-11,8	-13,0	61,4	18,0	61,2	19,1	61,0	20,2	60,9	20,7	60,8	21,3	60,6	22,4
		-9,8	-11,0	64,6	18,8	64,4	19,8	64,2	20,8	64,1	21,3	64,0	21,9	63,8	22,9
		-9,5	-10,0	66,2	19,1	66,0	20,1	65,8	21,1	65,7	21,6	65,6	22,1	65,4	23,1
		-8,5	-9,1	67,7	19,4	67,5	20,4	67,3	21,4	67,2	21,8	67,1	22,3	66,9	23,3
		-7,0	-7,6	70,2	19,8	70,0	20,8	69,8	21,7	69,7	22,2	69,6	22,6	69,4	23,6
		-5,0	-5,6	73,4	20,3	73,2	21,2	73,0	22,1	72,9	22,5	72,8	23,0	72,6	23,8
		-3,0	-3,7	76,5	20,7	76,3	21,6	76,1	22,4	76,0	22,8	75,9	23,2	75,7	24,0
		0,0	-0,7	81,4	21,2	81,2	22,0	81,0	22,7	80,9	23,1	80,8	23,5	80,6	24,2
		3,0	2,2	86,1	21,5	85,9	22,2	85,7	22,9	85,6	23,3	85,5	23,7	85,3	24,4
		5,0	4,1	89,2	21,7	89,0	22,4	88,8	23,0	88,7	23,4	88,6	23,7	88,4	24,4
		7,0	6,0	92,3	21,8	92,1	22,5	91,9	23,1	91,8	23,4	91,7	23,7	91,5	24,4
		9,0	7,9	95,4	21,9	95,2	22,5	95,0	23,1	94,9	23,4	94,8	23,7	94,6	24,3
		11,0	9,8	98,5	22,0	98,3	22,5	98,1	23,1	98,0	23,4	97,9	23,7	97,7	24,3
13,0	11,8	101,8	22,0	101,6	22,5	101,4	23,1	101,3	23,3	101,2	23,6	99,1	23,5		
15,0	13,7	105	22,0	105	22,5	104	23,0	104	23,3	104	23,5	99,1	22,3		
120	94,20 kW	-19,8	-20,0	49,7	15,7	49,5	17,0	49,3	18,4	49,2	19,0	49,1	19,7	48,9	21,0
		-18,8	-19,0	51,3	16,4	51,1	17,7	50,9	19,0	50,9	19,6	50,8	20,2	50,6	21,5
		-16,7	-17,0	54,6	17,6	54,4	18,8	54,2	20,0	54,1	20,6	54,0	21,1	53,8	22,3
		-13,7	-15,0	57,8	18,6	57,6	19,7	57,5	20,8	57,4	21,4	57,3	21,9	57,1	23,0
		-11,8	-13,0	61,1	19,5	60,9	20,5	60,7	21,5	60,6	22,0	60,5	22,5	60,4	23,5
		-9,8	-11,0	64,4	20,2	64,2	21,1	64,0	22,1	63,9	22,5	63,8	23,0	63,6	24,0
		-9,5	-10,0	66,0	20,5	65,8	21,4	65,6	22,3	65,5	22,8	65,4	23,2	65,2	24,2
		-8,5	-9,1	67,4	20,7	67,3	21,6	67,1	22,5	67,0	23,0	66,9	23,4	66,7	24,3
		-7,0	-7,6	69,9	21,1	69,7	22,0	69,5	22,8	69,4	23,2	69,3	23,7	69,2	24,5
		-5,0	-5,6	73,1	21,5	73,0	22,3	72,8	23,1	72,7	23,5	72,6	23,9	72,4	24,7
		-3,0	-3,7	76,2	21,8	76,1	22,6	75,9	23,4	75,8	23,7	75,7	24,1	75,5	24,9
		0,0	-0,7	81,1	22,2	80,9	22,9	80,8	23,6	80,7	24,0	80,6	24,3	80,4	25,0
		3,0	2,2	85,9	22,5	85,7	23,1	85,5	23,8	85,4	24,1	85,3	24,4	85,1	25,1
		5,0	4,1	88,9	22,6	88,8	23,2	88,6	23,8	88,5	24,1	88,4	24,5	88,2	25,1
		7,0	6,0	92,0	22,7	91,9	23,3	91,7	23,9	91,6	24,1	91,5	24,4	91,3	25,0
		9,0	7,9	95,1	22,7	95,0	23,3	94,8	23,8	94,7	24,1	94,6	24,4	94,5	23,8
		11,0	9,8	98,2	22,7	98,1	23,3	97,9	23,8	97,8	24,1	97,7	24,3	97,5	22,5
13,0	11,8	101,5	22,7	101,3	23,2	101,1	23,7	101,0	24,0	98,3	23,2	91,5	21,4		
15,0	13,7	105	22,7	104	23,2	104	23,6	102	23,0	98,3	22,1	91,5	20,3		
110	86,35 kW	-19,8	-20,0	49,4	17,7	49,2	18,9	49,1	20,1	49,0	20,7	48,9	21,3	48,7	22,5
		-18,8	-19,0	51,0	18,3	50,9	19,4	50,7	20,6	50,6	21,2	50,5	21,8	50,4	22,9
		-16,7	-17,0	54,3	19,3	54,1	20,4	54,0	21,5	53,9	22,0	53,8	22,6	53,6	23,7
		-13,7	-15,0	57,6	20,2	57,4	21,2	57,2	22,2	57,1	22,7	57,1	23,2	56,9	24,2
		-11,8	-13,0	60,8	21,0	60,7	21,9	60,5	22,8	60,4	23,3	60,3	23,8	60,1	24,7
		-9,8	-11,0	64,1	21,6	63,9	22,4	63,7	23,3	63,7	23,7	63,6	24,2	63,4	25,1
		-9,5	-10,0	65,7	21,8	65,5	22,7	65,4	23,5	65,3	23,9	65,2	24,4	65,0	25,2
		-8,5	-9,1	67,2	22,0	67,0	22,9	66,8	23,7	66,8	24,1	66,7	24,5	66,5	25,3
		-7,0	-7,6	69,6	22,3	69,4	23,1	69,3	23,9	69,2	24,3	69,1	24,7	68,9	25,5
		-5,0	-5,6	72,9	22,7	72,7	23,4	72,5	24,2	72,5	24,5	72,4	24,9	72,2	25,6
		-3,0	-3,7	76,0	23,0	75,8	23,7	75,6	24,4	75,5	24,7	75,5	25,1	75,3	25,8
		0,0	-0,7	80,9	23,3	80,7	23,9	80,5	24,5	80,4	24,9	80,4	25,2	80,2	25,8
		3,0	2,2	85,6	23,4	85,4	24,0	85,2	24,6	85,2	24,9	85,1	25,2	83,9	25,3
		5,0	4,1	88,7	23,5	88,5	24,1	88,3	24,6	88,3	24,9	88,2	25,2	83,9	23,9
		7,0	6,0	91,8	23,5	91,6	24,1	91,4	24,6	91,4	24,9	90,1	24,6	83,9	22,6
		9,0	7,9	94,9	23,5	94,7	24,1	94,5	24,6	93,2	24,3	90,1	23,3	83,9	21,4
		11,0	9,8	98,0	23,5	97,8	24,0	96,3	24,0	93,2	23,0	90,1	22,1	83,9	20,4
13,0	11,8	101,2	23,5	101,1	23,9	96,3	22,7	93,2	21,8	90,1	21,0	83,9	19,3		
15,0	13,7	104	23,4	102	23,2	96,3	21,6	93,2	20,7	90,1	19,9	83,9	18,4		
100	78,50 kW	-19,8	-20,0	49,1	19,6	49,0	20,7	48,8	21,8	48,8	22,4	48,7	22,9	48,5	24,0
		-18,8	-19,0	50,8	20,1	50,6	21,2	50,5	22,3	50,4	22,8	50,3	23,3	50,2	24,4
		-16,7	-17,0	54,0	21,1	53,9	22,0	53,7	23,0	53,7	23,5	53,6	24,0	53,4	25,0
		-13,7	-15,0	57,3	21,8	57,1	22,7	57,0	23,6	56,9	24,1	56,8	24,6	56,7	25,5
		-11,8	-13,0	60,6	22,4	60,4	23,3	60,2	24,1	60,2	24,6	60,1	25,0	59,9	25,8
		-9,8	-11,0	63,8	23,0	63,7	23,7	63,5	24,5	63,4	24,9	63,3	25,3	63,2	26,1
		-9,5	-10,0	65,4	23,2	65,3	23,9	65,1	24,7	65,1	25,1	65,0	25,5	64,8	26,2
		-8,5	-9,1	66,9	23,3	66,8	24,1	66,6	24,8	66,5	25,2	66,4	25,6	66,3	26,3
		-7,0	-7,6	69,3	23,6	69,2	24,3	69,0	25,0	69,0	25,4	68,9	25,7	68,7	26,4
		-5,0	-5,6	72,6	23,9	72,5	24,5	72,3	25,2	72,2	25,6	72,1	25,9	72,0	26,6
		-3,0	-3,7	75,7	24,1	75,5	24,7	75,4	25,3	75,3	25,7	75,2	26,0	75,1	26,6
		0,0	-0,7	80,6	24,3	80,4	24,9	80,3	25,5	80,2	25,7	80,1	26,0	76,3	24,7
		3,0	2,2	85,3	24,4	85,2	24,9	85,0	25,5	84,7	25,6	81,9	24,6	76,3	22,6
		5,0	4,1	88,4	24,4	88,3	24,9	87,5	25,2	84,7	24,2	81,9	23,2	76,3	21,4
		7,0	6,0	91,5	24,4	91,3	24,9	87,5	23,8	84,7	22,9	81,9	22,0	76,3	20,2
		9,0	7,9	94,6	24,4	93,1	24,3	87,5	22,5	84,7	21,7	81,9	20,9	76,3	19,2
		11,0	9,8	97,7	24,3	93,1	23,0	87,5	21,4	84,7	20,6	81,9	19,8	76,3	18,2
13,0	11,8	98,7	23,4	93,1	21,8	87,5	20,3	84,7	19,5	81,9	18,8	76,3	17,3		
15,0	13,7	98,7	22,2	93,1	20,7	87,5	19,3	84,7	18,6	81,9	17,9	76,3	16,5		

**NOTES - ANMERKUNGEN - Σημειώσεις - NOTAS - REMARQUES - NOTE - OPMERKINGEN - Примечания - NOTLAR**

- is shown as reference. When selecting the unit models, avoid the Outdoor air temperature range shown by
- dient als Verweis. Vermeiden Sie bei der Auswahl der Gerätemodelle den als markierten Temperaturbereich der Außenluft
- είναι ενδεικτική, κατά την επιλογή των μοντέλων των μονάδων, αποφύγετε το εύρος θερμοκρασίας εξωτερικού αέρα που υποδεικνύεται
- se muestra como referencia. Cuando seleccione los modelos de unidad, evite el intervalo de temperaturas del aire exterior indicado mediante
- est montré comme référence. Lors du choix des modèles d'unités, évitez la plage de températures de l'air extérieur illustré par
- valori riportati unicamente come riferimento. Nel selezionare i modelli delle unità, non considerare i valori di temperatura dell'aria esterna indicati con il colore
- is als referentie getoond. Wanneer modellen van eenheden worden gekozen, vermijd dan het bereik van buitenluchttemperaturen geïllustreerd door
- показан как. При выборе модели устройства избегайте внешнюю температуру

воздуха, указанную в  
referans olarak gösterilmektedir. Ünite modellerini seçerken, belirtilen Dış hava sıcaklığı aralığından kaçınınız

The above table shows the average value of conditions which may occur.  
Die obige Tabelle zeigt den Durchschnittswert der Bedingungen, die auftreten können.  
Στον παραπάνω πίνακα αναγράφεται η μέση τιμή

# 5 Capacity tables

## 5 - 2 Heating Capacity Tables

5

RQYQ28PY1															TC: Total Capacity: kW ; PI: Power Input: kW (compressor + outdoor fan motor)	
Combination (%)	Capacity index (kW)	Outdoor air temp.		Indoor air temperature: °CDB												
				16.0		18.0		20.0		21.0		22.0		24.0		
				TC	PI	TC	PI	TC	PI	TC	PI	TC	PI	TC	PI	
		°CDB	°CWB													
90%	70,65 kW	-19,8	-20,0	48,9	21,5	48,7	22,5	48,6	23,5	48,5	24,0	48,5	24,5	48,3	25,5	
		-18,8	-19,0	50,5	22,0	50,4	22,9	50,2	23,9	50,2	24,4	50,1	24,9	50,0	25,8	
		-16,7	-17,0	53,8	22,8	53,6	23,7	53,5	24,5	53,4	25,0	53,3	25,4	53,2	26,3	
		-13,7	-15,0	57,0	23,4	56,9	24,2	56,7	25,1	56,7	25,5	56,6	25,9	56,5	26,7	
		-11,8	-13,0	60,3	23,9	60,1	24,7	60,0	25,5	59,9	25,8	59,9	26,2	59,7	27,0	
		-9,8	-11,0	63,5	24,3	63,4	25,1	63,3	25,8	63,2	26,1	63,1	26,5	63,0	27,2	
		-9,5	-10,0	65,2	24,5	65,0	25,2	64,9	25,9	64,8	26,2	64,8	26,6	64,6	27,3	
		-8,5	-9,1	66,6	24,7	66,5	25,3	66,4	26,0	66,3	26,3	66,2	26,7	66,1	27,3	
		-7,0	-7,6	69,1	24,9	68,9	25,5	68,8	26,1	68,7	26,5	68,7	26,8	68,5	27,4	
		-5,0	-5,6	72,3	25,1	72,2	25,7	72,1	26,3	72,0	26,6	71,9	26,9	71,8	27,4	
		-3,0	-3,7	75,4	25,2	75,3	25,8	75,2	26,3	75,1	26,6	75,0	26,9	74,9	27,4	
		0,0	-0,7	80,3	25,3	80,2	25,8	80,1	26,3	80,0	26,6	79,9	26,9	79,8	27,4	
		3,0	2,2	85,0	25,3	84,8	25,3	84,7	25,8	84,6	26,1	84,5	26,4	84,4	26,9	
		5,0	4,1	88,1	25,3	88,0	25,3	87,9	25,8	87,8	26,1	87,7	26,4	87,6	26,9	
		7,0	6,0	88,9	24,2	88,8	22,6	88,7	21,0	88,6	20,2	88,5	19,5	88,4	18,0	
		9,0	7,9	88,9	23,0	88,8	21,4	88,7	19,9	88,6	19,2	88,5	18,5	88,4	17,1	
		11,0	9,8	88,9	21,8	88,8	20,3	88,7	18,9	88,6	18,2	88,5	17,6	88,4	16,2	
		13,0	11,8	88,9	20,6	88,8	19,3	88,7	18,0	88,6	17,3	88,5	16,7	88,4	15,4	
		15,0	13,7	88,9	19,6	88,8	18,3	88,7	17,1	88,6	16,5	88,5	15,9	88,4	14,7	
		80%	62,80 kW	-19,8	-20,0	48,6	23,5	48,5	24,4	48,4	25,2	48,3	25,7	48,2	26,1	48,1
-18,8	-19,0			50,2	23,9	50,1	24,7	50,0	25,6	49,9	26,0	49,9	26,4	49,7	27,2	
-16,7	-17,0			53,5	24,5	53,4	25,3	53,2	26,1	53,2	26,5	53,1	26,9	53,0	27,6	
-13,7	-15,0			56,8	25,0	56,6	25,8	56,5	26,5	56,4	26,8	56,4	27,2	56,3	27,9	
-11,8	-13,0			60,0	25,4	59,9	26,1	59,8	26,8	59,7	27,1	59,6	27,5	59,5	28,1	
-9,8	-11,0			63,3	25,7	63,1	26,4	63,0	27,0	63,0	27,3	62,9	27,6	62,8	28,1	
-9,5	-10,0			64,9	25,9	64,8	26,5	64,7	27,1	64,6	27,4	64,5	27,7	64,4	28,1	
-8,5	-9,1			66,4	26,0	66,2	26,6	66,1	27,2	66,1	27,5	66,0	27,8	65,9	28,1	
-7,0	-7,6			68,8	26,1	68,7	26,7	68,6	27,2	68,5	27,5	68,4	27,8	68,3	28,1	
-5,0	-5,6			72,1	26,2	71,9	26,8	71,8	27,3	71,7	27,6	71,6	27,9	71,5	28,1	
-3,0	-3,7			75,2	26,3	75,1	26,9	75,0	27,4	74,9	27,7	74,8	28,0	74,7	28,1	
0,0	-0,7			79,0	25,8	78,9	24,0	78,8	22,3	78,7	21,5	78,6	20,7	78,5	19,1	
3,0	2,2			79,0	23,6	78,9	22,0	78,8	20,5	78,7	19,7	78,6	19,0	78,5	17,5	
5,0	4,1			79,0	22,3	78,9	20,8	78,8	19,4	78,7	18,7	78,6	18,0	78,5	16,6	
7,0	6,0			79,0	21,1	78,9	19,7	78,8	18,4	78,7	17,7	78,6	17,0	78,5	15,8	
9,0	7,9			79,0	20,0	78,9	18,7	78,8	17,4	78,7	16,8	78,6	16,2	78,5	15,0	
11,0	9,8			79,0	19,0	78,9	17,8	78,8	16,6	78,7	16,0	78,6	15,4	78,5	14,3	
13,0	11,8			79,0	18,0	78,9	17,5	78,8	16,9	78,7	16,5	78,6	16,1	78,5	13,6	
15,0	13,7			79,0	17,2	78,9	16,1	78,8	15,0	78,7	14,5	78,6	14,0	78,5	12,9	
70%	54,95 kW			-19,8	-20,0	48,3	25,4	48,2	26,2	48,1	27,0	48,0	27,3	48,0	27,7	47,9
		-18,8	-19,0	50,0	25,7	49,9	26,5	49,8	27,2	49,7	27,6	49,6	27,9	49,5	28,7	
		-16,7	-17,0	53,2	26,2	53,1	26,9	53,0	27,6	53,0	27,9	52,9	28,3	52,8	29,0	
		-13,7	-15,0	56,5	26,6	56,4	27,3	56,3	27,9	56,2	28,2	56,2	28,5	56,1	29,0	
		-11,8	-13,0	59,7	26,9	59,6	27,5	59,5	28,1	59,4	28,3	59,3	28,6	59,2	29,0	
		-9,8	-11,0	63,0	27,1	62,9	27,7	62,8	28,2	62,7	28,5	62,6	28,8	62,5	29,0	
		-9,5	-10,0	64,6	27,2	64,5	27,8	64,4	28,3	64,3	28,6	64,2	28,9	64,1	29,0	
		-8,5	-9,1	66,1	27,3	66,0	27,9	65,9	28,4	65,8	28,7	65,7	29,0	65,6	29,0	
		-7,0	-7,6	68,5	27,4	68,4	28,0	68,3	28,5	68,2	28,8	68,1	29,1	68,0	29,0	
		-5,0	-5,6	69,1	25,8	69,0	24,1	68,9	22,4	68,8	21,6	68,7	20,8	68,6	19,2	
		-3,0	-3,7	69,1	24,2	69,0	22,6	68,9	21,1	68,8	20,3	68,7	19,5	68,6	18,0	
		0,0	-0,7	69,1	22,0	69,0	20,6	68,9	19,2	68,8	18,5	68,7	17,8	68,6	16,5	
		3,0	2,2	69,1	20,2	69,0	18,9	68,9	17,6	68,8	17,0	68,7	16,4	68,6	15,1	
		5,0	4,1	69,1	19,1	69,0	17,9	68,9	16,7	68,8	16,1	68,7	15,5	68,6	14,4	
		7,0	6,0	69,1	18,1	69,0	17,0	68,9	15,8	68,8	15,3	68,7	14,7	68,6	13,7	
		9,0	7,9	69,1	17,2	69,0	16,1	68,9	15,1	68,8	14,5	68,7	14,0	68,6	13,0	
		11,0	9,8	69,1	16,3	69,0	15,3	68,9	14,3	68,8	13,8	68,7	13,4	68,6	12,4	
		13,0	11,8	69,1	15,5	69,0	14,6	68,9	13,6	68,8	13,2	68,7	12,7	68,6	11,8	
		15,0	13,7	69,1	14,8	69,0	13,9	68,9	13,0	68,8	12,6	68,7	12,1	68,6	11,3	
		60%	47,10 kW	-19,8	-20,0	48,1	27,3	48,0	28,0	47,9	28,7	47,8	29,0	47,8	29,3	47,8
-18,8	-19,0			49,7	27,6	49,6	28,2	49,5	28,8	49,5	29,2	49,4	29,2	49,4	26,8	
-16,7	-17,0			53,0	27,9	52,9	28,5	52,8	28,9	52,8	29,3	52,7	29,6	52,6	24,5	
-13,7	-15,0			56,2	28,2	56,1	28,8	56,0	29,3	55,9	29,6	55,8	30,0	55,7	22,6	
-11,8	-13,0			59,2	28,2	59,1	28,8	59,0	29,3	58,9	29,6	58,8	30,0	58,7	20,9	
-9,8	-11,0			59,2	26,1	59,1	24,4	59,0	22,7	58,9	21,8	58,8	21,0	58,7	19,4	
-9,5	-10,0			59,2	25,2	59,1	23,5	59,0	21,9	58,9	21,1	58,8	20,3	58,7	18,7	
-8,5	-9,1			59,2	24,3	59,1	22,7	59,0	21,2	58,9	20,4	58,8	19,6	58,7	18,1	
-7,0	-7,6			59,2	23,1	59,1	21,6	59,0	20,1	58,9	19,4	58,8	18,7	58,7	17,3	
-5,0	-5,6			59,2	21,6	59,1	20,2	59,0	18,8	58,9	18,1	58,8	17,5	58,7	16,2	
-3,0	-3,7			59,2	20,3	59,1	19,0	59,0	17,7	58,9	17,1	58,8	16,5	58,7	15,3	
0,0	-0,7			59,2	18,5	59,1	17,3	59,0	16,2	58,9	15,6	58,8	15,1	58,7	14,0	
3,0	2,2			59,2	17,0	59,1	15,9	59,0	14,9	58,9	14,4	58,8	13,9	58,7	12,9	
5,0	4,1			59,2	16,1	59,1	15,1	59,0	14,1	58,9	13,6	58,8	13,2	58,7	12,2	
7,0	6,0			59,2	15,3	59,1	14,3	59,0	13,4	58,9	13,0	58,8	12,5	58,7	11,7	
9,0	7,9			59,2	14,5	59,1	13,6	59,0	12,8	58,9	12,4	58,8	11,9	58,7	11,1	
11,0	9,8			59,2	13,8	59,1	13,0	59,0	12,2	58,9	11,8	58,8	11,4	58,7	10,6	
13,0	11,8			59,2	13,2	59,1	12,4	59,0	11,6	58,9	11,2	58,8	10,9	58,7	10,12	
15,0	13,7			59,2	12,6	59,1	11,8	59,0	11,1	58,9	10,7	58,8	10,4	58,7	9,68	
50%	39,25 kW			-19,8	-20,0	47,8	29,3	47,7	28,7	47,6	28,0	47,5	27,3	47,4	26,7	47,3
		-18,8	-19,0	49,4	29,4	49,3	28,8	49,2	28,1	49,1	27,4	49,0	26,8	48,9	21,7	
		-16,7	-17,0	49,4	26,8	49,3	25,1	49,2	23,3	49,1	22,4	49,0	21,6	48,9	19,9	
		-13,7	-15,0	49,4	24,7	49,3	23,0	49,2	21,5	49,1	20,7	49,0	19,9	48,9	18,4	
		-11,8	-13,0	49,4	22,8	49,3	21,3	49,2	19,9	49,1	19,2	49,0	18,5	48,9	17,1	
		-9,8	-11,0	49,4	21,1	49,3	19,8	49,2	18,5	49,1	17,8	49,0	17,2	48,9	15,9	
		-9,5	-10,0	49,4	20,4	49,3	19,1	49,2	17,8	49,1	17,2	49,0	16,6	48,9	15,4	
		-8,5	-9,1	49,4	19,7	49,3	18,5	49,2	17,3	49,1	16,7	49,0	16,1	48,9	14,9	
		-7,0	-7,6	49,4	18,8	49,3	17,6	49,2	16,4	49,1	15,9	49,0	15,3	48,9	14,2	
		-5,0	-5,6	49,4	17,6	49,3	16,5	49,2	15,4	49,1	14,9	49,0	14,4	48,9	13,4	
		-3,0	-3,7	49,4	16,6	49,3	15,5	49,2	14,5	49,1	14,1	49,0	13,6	48,9	12,6	
		0,0	-0,7	49,4	15,1	49,3	14,2	49,2	13,3	49,1</						



# 5 Capacity tables

## 5 - 2 Heating Capacity Tables

RQYQ30PY1		TC: Total Capacity: kW ; PI: Power Input: kW (compressor + outdoor fan motor)													
Combination (%)	Capacity index (kW)	Outdoor air temp.		Indoor air temperature: °CDB											
				16.0		18.0		20.0		21.0		22.0		24.0	
				TC	PI	TC	PI	TC	PI	TC	PI	TC	PI	TC	PI
130	110,50 kW	-19,8	-20,0	54,4	15,9	54,2	17,6	54,0	19,2	53,9	20,0	53,8	20,8	53,6	22,4
		-18,8	-19,0	56,3	16,9	56,1	18,4	55,9	20,0	55,8	20,7	55,7	21,5	55,5	23,1
		-16,7	-17,0	60,2	18,5	59,9	19,9	59,7	21,3	59,6	22,1	59,5	22,8	59,3	24,2
		-13,7	-15,0	64,0	19,8	63,8	21,2	63,6	22,5	63,4	23,1	63,3	23,8	63,1	25,1
		-11,8	-13,0	67,8	21,0	67,6	22,2	67,4	23,4	67,3	24,0	67,2	24,6	67,0	25,9
		-9,8	-11,0	71,6	21,9	71,4	23,0	71,2	24,2	71,1	24,8	71,0	25,3	70,8	26,5
		-9,5	-10,0	73,6	22,3	73,3	23,4	73,1	24,5	73,0	25,1	72,9	25,6	72,7	26,7
		-8,5	-9,1	75,3	22,7	75,1	23,7	74,9	24,8	74,7	25,3	74,6	25,9	74,4	26,9
		-7,0	-7,6	78,2	23,2	77,9	24,2	77,7	25,2	77,6	25,7	77,5	26,2	77,3	27,2
		-5,0	-5,6	82,0	23,7	81,8	24,7	81,6	25,6	81,4	26,1	81,3	26,6	81,1	27,5
		-3,0	-3,7	85,6	24,2	85,4	25,1	85,2	26,0	85,1	26,4	85,0	26,9	84,8	27,8
		0,0	-0,7	91,4	24,7	91,1	25,5	90,9	26,4	90,8	26,8	90,7	27,2	90,5	28,0
		3,0	2,2	96,9	25,1	96,7	25,8	96,5	26,6	96,4	27,0	96,3	27,4	96,0	28,1
		5,0	4,1	100,6	25,3	100,3	26,0	100,1	26,7	100,0	27,1	99,9	27,4	99,7	28,1
		7,0	6,0	104,2	25,4	104,0	26,1	103,8	26,7	103,6	27,1	103,5	27,4	103,3	28,1
		9,0	7,9	108	25,5	108	26,1	107	26,8	107	27,1	107	27,4	107	28,1
		11,0	9,8	111	25,5	111	26,1	111	26,7	111	27,1	111	27,4	108	26,8
13,0	11,8	115	25,5	115	26,1	115	26,7	115	27,0	115	27,3	108	25,3		
15,0	13,7	119	25,5	119	26,0	118	26,6	118	26,9	116	26,2	108	24,1		
120	102,00 kW	-19,8	-20,0	54,1	18,1	53,9	19,6	53,7	21,1	53,6	21,8	53,5	22,6	53,3	24,1
		-18,8	-19,0	56,0	19,0	55,8	20,4	55,6	21,8	55,5	22,5	55,4	23,2	55,2	24,7
		-16,7	-17,0	59,9	20,4	59,7	21,7	59,5	23,0	59,4	23,7	59,3	24,4	59,1	25,7
		-13,7	-15,0	63,7	21,6	63,5	22,8	63,3	24,1	63,2	24,7	63,1	25,3	62,9	26,5
		-11,8	-13,0	67,5	22,6	67,3	23,7	67,1	24,9	67,0	25,4	66,9	26,0	66,7	27,1
		-9,8	-11,0	71,4	23,4	71,2	24,5	71,0	25,5	70,9	26,1	70,8	26,6	70,6	27,7
		-9,5	-10,0	73,3	23,8	73,1	24,8	72,9	25,8	72,8	26,3	72,7	26,9	72,5	27,9
		-8,5	-9,1	75,0	24,1	74,8	25,1	74,6	26,1	74,5	26,6	74,4	27,1	74,2	28,0
		-7,0	-7,6	77,9	24,5	77,7	25,5	77,5	26,4	77,4	26,9	77,3	27,3	77,1	28,3
		-5,0	-5,6	81,7	25,0	81,5	25,9	81,3	26,8	81,2	27,2	81,1	27,7	80,9	28,5
		-3,0	-3,7	85,3	25,4	85,1	26,2	84,9	27,0	84,8	27,5	84,7	27,9	84,5	28,7
		0,0	-0,7	91,1	25,8	90,9	26,6	90,7	27,4	90,6	27,7	90,5	28,1	90,3	28,9
		3,0	2,2	96,6	26,1	96,4	26,8	96,2	27,5	96,1	27,9	96,0	28,2	95,8	28,9
		5,0	4,1	100,3	26,2	100,1	26,9	99,9	27,6	99,8	27,9	99,7	28,2	99,3	28,9
		7,0	6,0	103,9	26,3	103,7	26,9	103,5	27,6	103,4	27,9	103,3	28,2	99,3	27,2
		9,0	7,9	108	26,3	107	26,9	107	27,5	107	27,9	107	28,0	99,3	25,7
		11,0	9,8	111	26,3	111	26,9	111	27,5	110	27,6	107	26,5	99,3	24,4
13,0	11,8	115	26,3	115	26,9	114	27,2	110	26,1	107	25,1	99,3	23,0		
15,0	13,7	119	26,2	118	26,8	114	25,8	110	24,8	107	23,8	99,3	21,9		
110	93,50 kW	-19,8	-20,0	53,8	20,3	53,6	21,7	53,5	23,0	53,4	23,7	53,3	24,4	53,1	25,8
		-18,8	-19,0	55,7	21,0	55,6	22,4	55,4	23,7	55,3	24,3	55,2	25,0	55,0	26,3
		-16,7	-17,0	59,6	22,3	59,4	23,5	59,2	24,7	59,1	25,4	59,0	26,0	58,8	27,2
		-13,7	-15,0	63,4	23,4	63,2	24,5	63,0	25,6	62,9	26,2	62,8	26,7	62,7	27,9
		-11,8	-13,0	67,2	24,3	67,0	25,3	66,9	26,3	66,8	26,9	66,7	27,4	66,5	28,4
		-9,8	-11,0	71,1	25,0	70,9	25,9	70,7	26,9	70,6	27,4	70,5	27,9	70,3	28,8
		-9,5	-10,0	73,0	25,3	72,8	26,2	72,6	27,2	72,5	27,6	72,4	28,1	72,2	29,0
		-8,5	-9,1	74,7	25,5	74,5	26,4	74,3	27,3	74,2	27,8	74,1	28,3	74,0	29,2
		-7,0	-7,6	77,6	25,9	77,4	26,8	77,2	27,6	77,1	28,1	77,0	28,5	76,8	29,3
		-5,0	-5,6	81,4	26,3	81,2	27,1	81,0	27,9	80,9	28,3	80,8	28,7	80,7	29,5
		-3,0	-3,7	85,0	26,6	84,9	27,4	84,7	28,1	84,6	28,5	84,5	28,9	84,3	29,7
		0,0	-0,7	90,8	26,9	90,6	27,6	90,4	28,3	90,3	28,7	90,2	29,0	90,0	29,7
		3,0	2,2	96,3	27,1	96,1	27,8	96,0	28,4	95,9	28,7	95,8	29,1	91,1	27,6
		5,0	4,1	100,0	27,2	99,8	27,8	99,6	28,4	99,5	28,7	99,4	28,3	91,1	26,0
		7,0	6,0	103,6	27,2	103,4	27,8	103,2	28,4	101,1	27,8	97,8	26,7	91,1	24,5
		9,0	7,9	107	27,2	107	27,8	105	27,4	101	26,3	97,8	25,3	91,1	23,2
		11,0	9,8	111	27,2	111	27,7	105	25,9	101	24,9	97,8	23,9	91,1	22,0
13,0	11,8	115	27,1	111	26,4	105	24,5	101	23,5	97,8	22,6	91,1	20,8		
15,0	13,7	118	26,9	111	25,0	105	23,2	101	22,4	97,8	21,5	91,1	19,8		
100	85,00 kW	-19,8	-20,0	53,5	22,5	53,4	23,7	53,2	25,0	53,1	25,6	53,0	26,2	52,9	27,4
		-18,8	-19,0	55,5	23,1	55,3	24,3	55,1	25,5	55,0	26,1	55,0	26,7	54,8	27,9
		-16,7	-17,0	59,3	24,3	59,1	25,4	58,9	26,5	58,9	27,0	58,8	27,5	58,6	28,6
		-13,7	-15,0	63,1	25,2	62,9	26,2	62,8	27,2	62,7	27,7	62,6	28,2	62,4	29,2
		-11,8	-13,0	66,9	25,9	66,8	26,9	66,6	27,8	66,5	28,3	66,4	28,7	66,3	29,7
		-9,8	-11,0	70,8	26,5	70,6	27,4	70,4	28,3	70,3	28,7	70,3	29,2	70,1	30,0
		-9,5	-10,0	72,7	26,8	72,5	27,6	72,3	28,5	72,3	28,9	72,2	29,3	72,0	30,2
		-8,5	-9,1	74,4	27,0	74,2	27,8	74,1	28,6	74,0	29,0	73,9	29,4	73,7	30,3
		-7,0	-7,6	77,3	27,3	77,1	28,1	76,9	28,8	76,9	29,2	76,8	29,6	76,6	30,4
		-5,0	-5,6	81,1	27,6	80,9	28,3	80,8	29,1	80,7	29,4	80,6	29,8	80,4	30,5
		-3,0	-3,7	84,7	27,8	84,6	28,5	84,4	29,2	84,3	29,6	84,2	29,9	82,8	29,9
		0,0	-0,7	90,5	28,1	90,3	28,7	90,2	29,3	90,1	29,6	88,9	29,4	82,8	27,0
		3,0	2,2	96,0	28,2	95,9	28,8	95,0	29,0	91,9	27,9	88,9	26,8	82,8	24,6
		5,0	4,1	99,7	28,2	99,5	28,7	95,0	27,3	91,9	26,3	88,9	25,2	82,8	23,2
		7,0	6,0	103,3	28,2	101,1	27,8	95,0	25,8	91,9	24,8	88,9	23,8	82,8	21,9
		9,0	7,9	107	28,1	101	26,3	95,0	24,4	91,9	23,5	88,9	22,6	82,8	20,8
		11,0	9,8	107	26,7	101	24,9	95,0	23,1	91,9	22,2	88,9	21,4	82,8	19,7
13,0	11,8	107	25,2	101	23,5	95,0	21,9	91,9	21,1	88,9	20,3	82,8	18,7		
15,0	13,7	107	23,9	101	22,3	95,0	20,8	91,9	20,0	88,9	19,3	82,8	17,8		

**NOTES - ANMERKUNGEN - Σημειώσεις - NOTAS - REMARQUES - NOTE - OPMERKINGEN - Примечания - NOTLAR**

is shown as reference. When selecting the unit models, avoid the Outdoor air temperature range shown by .  
 dient als Verweis. Vermeiden Sie bei der Auswahl der Gerätemodelle den als markierten Temperaturbereich der Außenluft.  
 Η είναι ενδεικτική, κατά την επιλογή των μοντέλων των μονάδων, αποφύγετε το εύρος θερμοκρασίας εξωτερικού αέρα που υποδεικνύεται .  
 se muestra como referencia. Cuando seleccione los modelos de unidad, evite el intervalo de temperaturas del aire exterior indicado mediante .  
 est montré comme référence. Lors du choix des modèles d'unités, évitez la plage de températures de l'air extérieur illustré par .  
 valori riportati unicamente come riferimento. Nel selezionare i modelli delle unità, non considerare i valori di temperatura dell'aria esterna indicati con il colore .  
 is als referentie getoond. Wanneer modellen van eenheden worden gekozen, vermijd dan het bereik van buitenluchttemperaturen geïllustreerd door .  
 показан как. При выборе модели устройства избегайте внешнюю температуру .

воздуха, указанную в .  
 referans olarak gösterilmektedir. Ünite modellerini seçerken, belirtilen Dış hava sıcaklığı aralığından kaçınınız .

The above table shows the average value of conditions which may occur.  
 Die obige Tabelle zeigt den Durchschnittswert der Bedingungen, die auftreten können.  
 Στον παραπάνω πίνακα αναγράφεται η μέση τιμή για συνθήκες που μπορεί να προκύψουν.  
 La tabla de arriba muestra el valor medio de condiciones que pueden ocurrir.  
 Le tableau ci-dessus donne la valeur moyenne pour des conditions qui peuvent survenir.  
 La tabella in alto mostra il valore delle condizioni medie che si possono riscontrare.  
 De tabel hierboven geeft de gemiddelde waarde aan van situaties die kunnen voorvallen.  
 Таблица расположенная выше показывает среднее значение условий, которые могут наступить.  
 Yukarıdaki tablo meydana gelebilecek koşulların ortalama değerini göstermektedir.

# 5 Capacity tables

## 5 - 2 Heating Capacity Tables

5

RQYQ30PY1

TC: Total Capacity: kW ; PI: Power Input: kW (compressor + outdoor fan motor)

Combination (%)	Capacity index (kW)	Outdoor air temp.		Indoor air temperature: °CDB											
				16.0		18.0		20.0		21.0		22.0		24.0	
				TC	PI	TC	PI	TC	PI	TC	PI	TC	PI	TC	PI
90%	76,50 kW	-19,8	-20,0	53,2	24,7	53,1	25,8	52,9	26,9	52,9	27,5	52,8	28,0	52,6	29,1
		-18,8	-19,0	55,2	25,2	55,0	26,3	54,9	27,4	54,8	27,9	54,7	28,4	54,6	29,5
		-16,7	-17,0	59,0	26,2	58,8	27,2	58,7	28,2	58,6	28,6	58,5	29,1	58,4	30,1
		-13,7	-15,0	62,8	27,0	62,7	27,9	62,5	28,8	62,4	29,2	62,4	29,7	62,2	30,6
		-11,8	-13,0	66,6	27,6	66,5	28,4	66,3	29,3	66,3	29,7	66,2	30,1	66,0	31,0
		-9,8	-11,0	70,5	28,1	70,3	28,9	70,2	29,6	70,1	30,0	70,0	30,4	69,9	31,2
		-9,5	-10,0	72,4	28,3	72,2	29,0	72,1	29,8	72,0	30,2	71,9	30,6	71,8	31,3
		-8,5	-9,1	74,1	28,4	74,0	29,2	73,8	29,9	73,7	30,3	73,7	30,6	73,5	31,4
		-7,0	-7,6	77,0	28,7	76,8	29,4	76,7	30,1	76,6	30,4	76,5	30,8	74,5	30,3
		-5,0	-5,6	80,8	28,9	80,7	29,5	80,5	30,2	80,4	30,5	80,0	30,7	74,5	28,1
		-3,0	-3,7	84,4	29,0	84,3	29,7	84,1	30,3	82,8	29,8	80,0	28,7	74,5	26,3
		0,0	-0,7	90,2	29,2	90,0	29,7	85,5	28,0	82,8	27,0	80,0	25,9	74,5	23,8
		3,0	2,2	95,7	29,2	91,0	27,5	85,5	25,6	82,8	24,6	80,0	23,6	74,5	21,8
		5,0	4,1	96,5	27,8	91,0	25,9	85,5	24,1	82,8	23,2	80,0	22,3	74,5	20,6
		7,0	6,0	96,5	26,3	91,0	24,5	85,5	22,8	82,8	21,9	80,0	21,1	74,5	19,5
		9,0	7,9	96,5	24,9	91,0	23,2	85,5	21,6	82,8	20,8	80,0	20,0	74,5	18,5
		11,0	9,8	96,5	23,5	91,0	22,0	85,5	20,5	82,8	19,7	80,0	19,0	74,5	17,5
		13,0	11,8	96,5	22,3	91,0	20,8	85,5	19,4	82,8	18,7	80,0	18,0	74,5	16,6
		15,0	13,7	96,5	21,2	91,0	19,8	85,5	18,4	82,8	17,8	80,0	17,1	74,5	15,8
		80%	68,00 kW	-19,8	-20,0	53,0	26,8	52,8	27,8	52,7	28,8	52,6	29,3	52,6	29,8
-18,8	-19,0			54,9	27,3	54,7	28,3	54,6	29,2	54,5	29,7	54,5	30,2	54,3	31,1
-16,7	-17,0			58,7	28,1	58,6	29,0	58,4	29,9	58,4	30,3	58,3	30,7	58,2	31,6
-13,7	-15,0			62,5	28,7	62,4	29,5	62,3	30,4	62,2	30,8	62,1	31,2	62,0	32,0
-11,8	-13,0			66,4	29,2	66,2	30,0	66,1	30,7	66,0	31,1	66,0	31,5	65,8	32,2
-9,8	-11,0			70,2	29,6	70,0	30,3	69,9	31,0	69,8	31,4	69,8	31,7	66,2	30,0
-9,5	-10,0			72,1	29,8	72,0	30,4	71,8	31,1	71,8	31,4	71,1	31,4	66,2	28,8
-8,5	-9,1			73,8	29,9	73,7	30,5	73,6	31,2	73,5	31,5	71,1	30,3	66,2	27,8
-7,0	-7,6			76,7	30,0	76,6	30,7	76,0	31,0	73,6	29,8	71,1	28,6	66,2	26,3
-5,0	-5,6			80,5	30,2	80,4	30,8	76,0	28,8	73,6	27,7	71,1	26,6	66,2	24,5
-3,0	-3,7			84,2	30,3	80,9	29,0	76,0	26,9	73,6	25,9	71,1	24,9	66,2	22,9
0,0	-0,7			85,8	28,1	80,9	26,2	76,0	24,4	73,6	23,5	71,1	22,6	66,2	20,8
3,0	2,2			85,8	25,6	80,9	23,9	76,0	22,3	73,6	21,4	71,1	20,6	66,2	19,1
5,0	4,1			85,8	24,2	80,9	22,6	76,0	21,0	73,6	20,3	71,1	19,5	66,2	18,0
7,0	6,0			85,8	22,9	80,9	21,4	76,0	19,9	73,6	19,2	71,1	18,5	66,2	17,1
9,0	7,9			85,8	21,7	80,9	20,2	76,0	18,9	73,6	18,2	71,1	17,5	66,2	16,2
11,0	9,8			85,8	20,5	80,9	19,2	76,0	17,9	73,6	17,3	71,1	16,7	66,2	15,4
13,0	11,8			85,8	19,4	80,9	18,2	76,0	17,0	73,6	16,4	71,1	15,8	66,2	14,6
15,0	13,7			85,8	18,5	80,9	17,3	76,0	16,2	73,6	15,6	71,1	15,1	66,2	14,0
70%	59,50 kW			-19,8	-20,0	52,7	29,0	52,5	29,9	52,4	30,8	52,4	31,2	52,3	31,6
		-18,8	-19,0	54,6	29,4	54,5	30,2	54,3	31,1	54,3	31,5	54,2	31,9	54,1	32,7
		-16,7	-17,0	58,4	30,0	58,3	30,8	58,2	31,6	58,1	31,9	58,1	32,3	57,9	33,1
		-13,7	-15,0	62,2	30,5	62,1	31,2	62,0	31,9	61,9	32,3	61,9	32,6	58,0	30,2
		-11,8	-13,0	66,1	30,9	65,9	31,5	65,8	32,2	64,4	31,4	62,2	30,2	58,0	27,7
		-9,8	-11,0	69,9	31,1	69,8	31,8	66,5	30,1	64,4	29,0	62,2	27,8	58,0	25,6
		-9,5	-10,0	71,8	31,2	70,8	31,2	66,5	28,9	64,4	27,8	62,2	26,7	58,0	24,6
		-8,5	-9,1	73,5	31,3	70,8	30,1	66,5	28,0	64,4	26,9	62,2	25,8	58,0	23,8
		-7,0	-7,6	75,0	30,5	70,8	28,5	66,5	26,4	64,4	25,4	62,2	24,5	58,0	22,5
		-5,0	-5,6	75,0	28,4	70,8	26,5	66,5	24,6	64,4	23,7	62,2	22,8	58,0	21,0
		-3,0	-3,7	75,0	26,5	70,8	24,8	66,5	23,0	64,4	22,2	62,2	21,4	58,0	19,7
		0,0	-0,7	75,0	24,0	70,8	22,5	66,5	20,9	64,4	20,2	62,2	19,4	58,0	18,0
		3,0	2,2	75,0	21,9	70,8	20,5	66,5	19,1	64,4	18,5	62,2	17,8	58,0	16,5
		5,0	4,1	75,0	20,7	70,8	19,4	66,5	18,1	64,4	17,5	62,2	16,8	58,0	15,6
		7,0	6,0	75,0	19,6	70,8	18,4	66,5	17,2	64,4	16,6	62,2	16,0	58,0	14,8
		9,0	7,9	75,0	18,6	70,8	17,4	66,5	16,3	64,4	15,7	62,2	15,2	58,0	14,1
		11,0	9,8	75,0	17,7	70,8	16,6	66,5	15,5	64,4	15,0	62,2	14,4	58,0	13,4
		13,0	11,8	75,0	16,8	70,8	15,7	66,5	14,7	64,4	14,2	62,2	13,7	58,0	12,7
		15,0	13,7	75,0	16,0	70,8	15,0	66,5	14,0	64,4	13,6	62,2	13,1	58,0	12,2
		60%	51,00 kW	-19,8	-20,0	52,4	31,2	52,3	31,9	52,2	32,7	52,1	33,1	52,1	33,4
-18,8	-19,0			54,3	31,5	54,2	32,2	54,1	32,9	54,0	33,3	53,3	33,0	49,7	30,3
-16,7	-17,0			58,1	32,0	58,0	32,6	57,0	32,5	55,2	31,2	53,3	30,0	49,7	27,5
-13,7	-15,0			61,9	32,3	60,7	31,9	57,0	29,6	55,2	28,5	53,3	27,4	49,7	25,2
-11,8	-13,0			64,3	31,4	60,7	29,3	57,0	27,0	55,2	26,2	53,3	25,2	49,7	23,2
-9,8	-11,0			64,3	28,9	60,7	27,0	57,0	25,1	55,2	24,2	53,3	23,3	49,7	21,5
-9,5	-10,0			64,3	27,8	60,7	26,0	57,0	24,1	55,2	23,3	53,3	22,4	49,7	20,7
-8,5	-9,1			64,3	26,9	60,7	25,1	57,0	23,3	55,2	22,5	53,3	21,7	49,7	20,0
-7,0	-7,6			64,3	25,4	60,7	23,7	57,0	22,1	55,2	21,3	53,3	20,5	49,7	19,0
-5,0	-5,6			64,3	23,7	60,7	22,1	57,0	20,6	55,2	19,9	53,3	19,2	49,7	17,7
-3,0	-3,7			64,3	22,2	60,7	20,8	57,0	19,4	55,2	18,7	53,3	18,0	49,7	16,7
0,0	-0,7			64,3	20,1	60,7	18,9	57,0	17,6	55,2	17,0	53,3	16,4	49,7	15,2
3,0	2,2			64,3	18,5	60,7	17,3	57,0	16,2	55,2	15,6	53,3	15,1	49,7	14,0
5,0	4,1			64,3	17,5	60,7	16,4	57,0	15,3	55,2	14,8	53,3	14,3	49,7	13,3
7,0	6,0			64,3	16,6	60,7	15,5	57,0	14,6	55,2	14,1	53,3	13,6	49,7	12,6
9,0	7,9			64,3	15,7	60,7	14,8	57,0	13,8	55,2	13,4	53,3	12,9	49,7	12,0
11,0	9,8			64,3	15,0	60,7	14,1	57,0	13,2	55,2	12,7	53,3	12,3	49,7	11,5
13,0	11,8			64,3	14,2	60,7	13,4	57,0	12,5	55,2	12,1	53,3	11,7	49,7	10,9
15,0	13,7			64,3	13,5	60,7	12,7	57,0	12,0	55,2	11,6	53,3	11,2	49,7	10,4
50%	42,50 kW			-19,8	-20,0	52,1	33,4	50,6	32,5	47,5	30,2	46,0	29,0	44,4	27,9
		-18,8	-19,0	53,6	33,2	50,6	30,9	47,5	28,7	46,0	27,6	44,4	26,6	41,4	24,5
		-16,7	-17,0	53,6	30,1	50,6	28,1	47,5	26,1	46,0	25,2	44,4	24,2	41,4	22,3
		-13,7	-15,0	53,6	27,5	50,6	25,7	47,5	23,9	46,0	23,1	44,4	22,2	41,4	20,5
		-11,8	-13,0	53,6	25,3	50,6	23,7	47,5	22,0	46,0	21,3	44,4	20,5	41,4	18,9
		-9,8	-11,0	53,6	23,4	50,6	21,9	47,5	20,4	46,0	19,7	44,4	19,0	41,4	17,6
		-9,5	-10,0	53,6	22,5	50,6	21,1	47,5	19,7	46,0	19,0	44,4	18,3	41,4	17,0
		-8,5	-9,1	53,6	21,8	50,6	20,4	47,5	19,0	46,0	18,4	44,4	17,7	41,4	16,4
		-7,0	-7,6	53,6	20,6	50,6	19,3	47,5	18,1	46,0	17,4	44,4	16,8	41,4	15,6
		-5,0	-5,6	53,6	19,3	50,6	18,1	47,5	16,9	46,0	16,3	44,4	15,8	41,4	14,6
		-3,0	-3,7	53,6	18,1	50,6	17,0	47,5	15,9	46,0	15,4	44,4	14,8	41,4	13,8
		0,0	-0,7	53,6	16,5	50,6	15,5	47,5	14,5	46,0	14,1	44,4	13,6	41,4</	



# 5 Capacity tables

## 5 - 2 Heating Capacity Tables

RQYQ32PY1		TC: Total Capacity: kW ; PI: Power Input: kW (compressor + outdoor fan motor)													
Combination (%)	Capacity index (kW)	Outdoor air temp.		Indoor air temperature: °CDB											
				16.0		18.0		20.0		21.0		22.0		24.0	
				TC	PI	TC	PI	TC	PI	TC	PI	TC	PI	TC	PI
130	117,00 kW	-19,8	-20,0	56,8	16,3	56,5	18,0	56,3	19,7	56,2	20,5	56,1	21,39	55,9	23,09
		-18,8	-19,0	58,8	17,3	58,5	18,9	58,3	20,5	58,2	21,3	58,1	22,16	57,9	23,79
		-16,7	-17,0	62,8	19,0	62,5	20,5	62,3	22,0	62,2	22,7	62,1	23,49	61,9	24,99
		-13,7	-15,0	66,8	20,4	66,5	21,8	66,3	23,2	66,2	23,9	66,1	24,6	65,8	26,0
		-11,8	-13,0	70,7	21,6	70,5	22,9	70,3	24,2	70,2	24,8	70,1	25,5	69,8	26,8
		-9,8	-11,0	74,7	22,6	74,5	23,8	74,3	25,0	74,2	25,6	74,1	26,2	73,8	27,4
		-9,5	-10,0	76,7	23,0	76,5	24,2	76,3	25,4	76,2	25,9	76,1	26,5	75,8	27,7
		-8,5	-9,1	78,5	23,4	78,3	24,5	78,1	25,6	78,0	26,2	77,8	26,8	77,6	27,9
		-7,0	-7,6	81,5	23,9	81,3	25,0	81,1	26,1	81,0	26,6	80,8	27,1	80,6	28,2
		-5,0	-5,6	85,5	24,5	85,3	25,5	85,1	26,6	84,9	27,1	84,8	27,6	84,6	28,6
		-3,0	-3,7	89,3	25,0	89,1	26,0	88,9	26,9	88,7	27,4	88,6	27,9	88,4	28,8
		0,0	-0,7	95,3	25,6	95,1	26,5	94,8	27,3	94,7	27,8	94,6	28,2	94,4	29,1
		3,0	2,2	101,1	26,0	100,9	26,8	100,6	27,6	100,5	28,0	100,4	28,4	100,2	29,2
		5,0	4,1	104,9	26,2	104,6	26,9	104,4	27,7	104,3	28,1	104,2	28,5	104,0	29,2
		7,0	6,0	109	26,3	108	27,0	108	27,8	108	28,1	108	28,5	108	29,2
		9,0	7,9	112	26,4	112	27,1	112	27,8	112	28,1	112	28,5	112	29,2
		11,0	9,8	116	26,5	116	27,1	116	27,8	116	28,1	116	28,4	113	28,3
13,0	11,8	120	26,5	120	27,1	120	27,7	120	28,0	120	28,3	113	26,7		
15,0	13,7	124	26,4	124	27,0	124	27,6	123	27,9	122	27,6	113	25,4		
120	108,00 kW	-19,8	-20,0	56,5	18,6	56,3	20,2	56,0	21,7	55,9	22,5	55,8	23,3	55,6	24,9
		-18,8	-19,0	58,5	19,5	58,3	21,0	58,0	22,5	57,9	23,2	57,8	24,0	57,6	25,5
		-16,7	-17,0	62,5	21,0	62,2	22,4	62,0	23,8	61,9	24,5	61,8	25,2	61,6	26,6
		-13,7	-15,0	66,4	22,3	66,2	23,6	66,0	24,9	65,9	25,5	65,8	26,1	65,6	27,4
		-11,8	-13,0	70,4	23,4	70,2	24,5	70,0	25,7	69,9	26,3	69,8	26,9	69,6	28,1
		-9,8	-11,0	74,4	24,2	74,2	25,3	74,0	26,4	73,9	27,0	73,8	27,6	73,6	28,7
		-9,5	-10,0	76,4	24,6	76,2	25,7	76,0	26,8	75,9	27,3	75,8	27,8	75,6	28,9
		-8,5	-9,1	78,2	24,9	78,0	26,0	77,8	27,0	77,7	27,5	77,6	28,0	77,4	29,1
		-7,0	-7,6	81,2	25,4	81,0	26,4	80,8	27,4	80,7	27,9	80,6	28,4	80,4	29,3
		-5,0	-5,6	85,2	25,9	85,0	26,8	84,8	27,8	84,7	28,2	84,6	28,7	84,4	29,6
		-3,0	-3,7	89,0	26,3	88,8	27,2	88,6	28,1	88,5	28,5	88,4	28,9	88,2	29,8
		0,0	-0,7	95,0	26,8	94,8	27,6	94,6	28,4	94,5	28,8	94,4	29,2	94,1	30,0
		3,0	2,2	100,8	27,1	100,6	27,8	100,4	28,6	100,2	28,9	100,1	29,3	99,9	30,0
		5,0	4,1	104,6	27,2	104,4	27,9	104,1	28,6	104,0	29,0	103,9	29,3	103,7	30,0
		7,0	6,0	108	27,3	108	28,0	108	28,6	108	29,0	108	29,3	105	28,7
		9,0	7,9	112	27,3	112	28,0	112	28,6	112	28,9	112	29,2	105	27,1
		11,0	9,8	116	27,3	116	27,9	116	28,6	115	28,9	112	28,0	105	25,7
13,0	11,8	120	27,3	120	27,9	120	28,5	116	27,5	112	26,4	105	24,3		
15,0	13,7	124	27,2	124	27,8	120	27,2	116	26,1	112	25,1	105	23,1		
110	99,00 kW	-19,8	-20,0	56,2	20,9	56,0	22,3	55,8	23,8	55,7	24,5	55,6	25,2	55,4	26,6
		-18,8	-19,0	58,2	21,7	58,0	23,1	57,8	24,4	57,7	25,1	57,6	25,8	57,4	27,2
		-16,7	-17,0	62,1	23,0	62,0	24,3	61,8	25,6	61,7	26,2	61,6	26,9	61,4	28,1
		-13,7	-15,0	66,1	24,2	65,9	25,3	65,8	26,5	65,7	27,1	65,6	27,7	65,4	28,9
		-11,8	-13,0	70,1	25,1	69,9	26,2	69,7	27,3	69,6	27,8	69,6	28,4	69,4	29,5
		-9,8	-11,0	74,1	25,9	73,9	26,9	73,7	27,9	73,6	28,4	73,5	28,9	73,3	29,9
		-9,5	-10,0	76,1	26,2	75,9	27,2	75,7	28,1	75,6	28,6	75,5	29,1	75,3	30,1
		-8,5	-9,1	77,9	26,4	77,7	27,4	77,5	28,3	77,4	28,8	77,3	29,3	77,1	30,3
		-7,0	-7,6	80,9	26,8	80,7	27,7	80,5	28,6	80,4	29,1	80,3	29,6	80,1	30,5
		-5,0	-5,6	84,9	27,3	84,7	28,1	84,5	29,0	84,4	29,4	84,3	29,8	84,1	30,7
		-3,0	-3,7	88,7	27,6	88,5	28,4	88,3	29,2	88,2	29,6	88,1	30,0	87,9	30,8
		0,0	-0,7	94,7	27,9	94,5	28,7	94,3	29,4	94,2	29,8	94,1	30,2	93,9	30,9
		3,0	2,2	100,5	28,2	100,3	28,8	100,1	29,5	100,0	29,9	99,9	30,2	99,9	29,0
		5,0	4,1	104,3	28,2	104,1	28,9	103,9	29,5	103,8	29,9	102,9	29,8	99,9	27,4
		7,0	6,0	108	28,3	108	28,9	108	29,5	108	29,3	103	28,2	95,9	25,9
		9,0	7,9	112	28,3	112	28,9	110	28,8	106	27,7	103	26,6	95,9	24,5
		11,0	9,8	116	28,2	115	28,8	110	27,8	106	26,2	103	25,2	95,9	23,2
13,0	11,8	120	28,2	117	27,8	110	25,8	106	24,8	103	23,8	95,9	22,0		
15,0	13,7	123	28,1	117	26,4	110	24,5	106	23,6	103	22,7	95,9	20,9		
100	90,00 kW	-19,8	-20,0	55,9	23,2	55,7	24,5	55,5	25,8	55,4	26,5	55,3	27,1	55,1	28,4
		-18,8	-19,0	57,8	23,9	57,7	25,1	57,5	26,4	57,4	27,0	57,3	27,6	57,1	28,9
		-16,7	-17,0	61,8	25,1	61,7	26,2	61,5	27,4	61,4	28,0	61,3	28,5	61,1	29,7
		-13,7	-15,0	65,8	26,0	65,7	27,1	65,5	28,2	65,4	28,7	65,3	29,2	65,1	30,3
		-11,8	-13,0	69,8	26,8	69,6	27,8	69,5	28,8	69,4	29,3	69,3	29,8	69,1	30,8
		-9,8	-11,0	73,8	27,5	73,6	28,4	73,5	29,3	73,4	29,8	73,3	30,2	73,1	31,2
		-9,5	-10,0	75,8	27,7	75,6	28,6	75,5	29,5	75,4	30,0	75,3	30,4	75,1	31,3
		-8,5	-9,1	77,6	28,0	77,4	28,8	77,3	29,7	77,2	30,1	77,1	30,6	76,9	31,4
		-7,0	-7,6	80,6	28,3	80,4	29,1	80,2	29,9	80,2	30,3	80,1	30,8	79,9	31,6
		-5,0	-5,6	84,6	28,6	84,4	29,4	84,2	30,2	84,2	30,6	84,1	30,9	83,9	31,7
		-3,0	-3,7	88,4	28,9	88,2	29,6	88,0	30,3	87,9	30,7	87,9	31,1	87,1	31,5
		0,0	-0,7	94,4	29,1	94,2	29,8	94,0	30,5	93,9	30,8	93,6	31,0	87,1	28,4
		3,0	2,2	100,2	29,2	100,0	29,9	99,8	30,5	99,8	29,4	93,6	28,2	87,1	25,9
		5,0	4,1	104,0	29,3	103,8	29,9	100,0	28,8	96,8	27,7	93,6	26,6	87,1	24,5
		7,0	6,0	108	29,3	106	29,3	100	27,2	96,8	26,2	93,6	25,1	87,1	23,1
		9,0	7,9	112	29,2	106	27,7	100	25,7	96,8	24,8	93,6	23,8	87,1	21,9
		11,0	9,8	113	28,1	106	26,2	100	24,4	96,8	23,5	93,6	22,6	87,1	20,8
13,0	11,8	113	26,6	106	24,8	100	23,1	96,8	22,2	93,6	21,4	87,1	19,7		
15,0	13,7	113	25,2	106	23,6	100	21,9	96,8	21,1	93,6	20,3	87,1	18,7		

**NOTES - ANMERKUNGEN - Σημειώσεις - NOTAS - REMARQUES - NOTE - OPMERKINGEN - Примечания - NOTLAR**

- is shown as reference. When selecting the unit models, avoid the Outdoor air temperature range shown by
- dient als Verweis. Vermeiden Sie bei der Auswahl der Gerätemodelle den als markierten Temperaturbereich der Außenluft
- Η είναι ενδεικτική, κατά την επιλογή των μοντέλων των μονάδων, αποφύγετε το εύρος θερμοκρασίας εξωτερικού αέρα που υποδεικνύεται
- se muestra como referencia. Cuando seleccione los modelos de unidad, evite el intervalo de temperaturas del aire exterior indicado mediante
- est montré comme référence. Lors du choix des modèles d'unités, évitez la plage de températures de l'air extérieur illustré par
- valori riportati unicamente come riferimento. Nel selezionare i modelli delle unità, non considerare i valori di temperatura dell'aria esterna indicati con il colore
- is als referentie getoond. Wanneer modellen van eenheden worden gekozen, vermijd dan het bereik van buitenluchttemperaturen geïllustreerd door
- показан как. При выборе модели устройства избегайте внешнюю температуру

- воздуха, указанную в
- referans olarak gösterilmektedir. Ünite modellerini seçerken, belirtilen Dış hava sıcaklığı aralığından kaçınm

The above table shows the average value of conditions which may occur.  
 Die obige Tabelle zeigt den Durchschnittswert der Bedingungen, die auftreten können.  
 Στον παραπάνω πίνακα αναγράφεται η μέση τιμή για συνθήκες που μπορεί να προκύψουν.  
 La tabla de arriba muestra el valor medio de condiciones que pueden ocurrir.  
 Le tableau ci-dessus donne la valeur moyenne pour des conditions qui peuvent survenir.  
 La tabella in alto mostra il valore delle condizioni medie che si possono riscontrare.  
 De tabel hierboven geeft de gemiddelde waarde aan van situaties die kunnen voorvallen.  
 Таблица расположенная выше показывает среднее значение условий, которые могут наступить.  
 Yukarıdaki tablo meydana gelebilecek koşulların ortalama değerini göstermektedir.

# 5 Capacity tables

## 5 - 2 Heating Capacity Tables

5

RQYQ32PY1

TC: Total Capacity: kW ; PI: Power Input: kW (compressor + outdoor fan motor)

Combination (%)	Capacity index (kW)	Outdoor air temp.		Indoor air temperature: °CDB											
				16.0		18.0		20.0		21.0		22.0		24.0	
				TC	PI	TC	PI	TC	PI	TC	PI	TC	PI	TC	PI
90%	81,00 kW	-19,8	-20,0	55,5	25,5	55,4	26,7	55,2	27,8	55,1	28,4	55,1	29,0	54,9	30,2
		-18,8	-19,0	57,5	26,1	57,4	27,2	57,2	28,3	57,1	28,9	57,1	29,5	56,9	30,6
		-16,7	-17,0	61,5	27,1	61,4	28,1	61,2	29,2	61,1	29,7	61,1	30,2	60,9	31,3
		-13,7	-15,0	65,5	27,9	65,4	28,9	65,2	29,8	65,1	30,3	65,0	30,8	64,9	31,8
		-11,8	-13,0	69,5	28,6	69,4	29,5	69,2	30,4	69,1	30,8	69,0	31,3	68,9	32,1
		-9,8	-11,0	73,5	29,1	73,3	29,9	73,2	30,8	73,1	31,2	73,0	31,6	72,9	32,4
		-9,5	-10,0	75,5	29,3	75,3	30,1	75,2	30,9	75,1	31,3	75,0	31,7	74,9	32,5
		-8,5	-9,1	77,3	29,5	77,1	30,3	77,0	31,0	76,9	31,4	76,8	31,8	76,7	32,6
		-7,0	-7,6	80,3	29,7	80,1	30,5	80,0	31,2	79,9	31,6	79,8	32,0	79,7	31,9
		-5,0	-5,6	84,3	30,0	84,1	30,7	84,0	31,4	83,9	31,7	83,8	32,1	83,7	29,7
		-3,0	-3,7	88,1	30,1	87,9	30,8	87,8	31,5	87,7	31,5	87,6	32,2	87,5	27,7
		0,0	-0,7	94,1	30,3	93,9	30,9	93,8	31,6	93,7	31,6	93,6	32,3	93,5	25,1
		3,0	2,2	99,9	30,3	99,8	31,0	99,7	31,7	99,6	31,7	99,5	32,4	99,4	22,9
		5,0	4,1	101,6	29,4	101,5	29,4	101,4	29,4	101,3	29,4	101,2	29,4	101,1	29,4
		7,0	6,0	102	27,7	101,9	27,7	101,8	27,7	101,7	27,7	101,6	27,7	101,5	27,7
		9,0	7,9	102	26,2	101,9	26,2	101,8	26,2	101,7	26,2	101,6	26,2	101,5	26,2
		11,0	9,8	102	24,8	101,9	24,8	101,8	24,8	101,7	24,8	101,6	24,8	101,5	24,8
		13,0	11,8	102	23,5	101,9	23,5	101,8	23,5	101,7	23,5	101,6	23,5	101,5	23,5
		15,0	13,7	102	22,3	101,9	22,3	101,8	22,3	101,7	22,3	101,6	22,3	101,5	22,3
		80%	72,00 kW	-19,8	-20,0	55,2	27,8	55,1	28,8	55,0	29,9	54,9	30,4	54,8	30,9
-18,8	-19,0			57,2	28,3	57,1	29,3	56,9	30,3	56,9	30,8	56,8	31,3	56,7	32,3
-16,7	-17,0			61,2	29,1	61,1	30,0	60,9	31,0	60,9	31,4	60,8	31,9	60,7	32,8
-13,7	-15,0			65,2	29,8	65,1	30,6	64,9	31,5	64,9	31,9	64,8	32,4	64,6	33,2
-11,8	-13,0			69,2	30,3	69,1	31,1	68,9	31,9	68,9	32,3	68,8	32,7	68,6	33,5
-9,8	-11,0			73,2	30,7	73,1	31,5	72,9	32,2	72,8	32,6	72,8	32,9	72,7	31,6
-9,5	-10,0			75,2	30,9	75,1	31,6	74,9	32,3	74,8	32,7	74,8	33,0	74,7	30,4
-8,5	-9,1			77,0	31,0	76,8	31,7	76,7	32,4	76,6	32,7	76,6	33,1	76,5	29,3
-7,0	-7,6			80,0	31,2	79,8	31,8	79,7	32,5	79,6	32,8	79,5	33,2	79,4	27,7
-5,0	-5,6			84,0	31,3	83,8	32,0	83,7	32,7	83,6	33,0	83,5	33,4	83,4	25,8
-3,0	-3,7			87,8	31,4	87,6	32,1	87,5	32,8	87,4	33,1	87,3	33,5	87,2	24,2
0,0	-0,7			90,3	29,7	90,2	29,7	90,1	29,7	90,0	29,7	89,9	29,7	89,8	29,7
3,0	2,2			90,3	27,0	90,2	27,0	90,1	27,0	90,0	27,0	89,9	27,0	89,8	27,0
5,0	4,1			90,3	25,5	90,2	25,5	90,1	25,5	90,0	25,5	89,9	25,5	89,8	25,5
7,0	6,0			90,3	24,1	90,2	24,1	90,1	24,1	90,0	24,1	89,9	24,1	89,8	24,1
9,0	7,9			90,3	22,8	90,2	22,8	90,1	22,8	90,0	22,8	89,9	22,8	89,8	22,8
11,0	9,8			90,3	21,6	90,2	21,6	90,1	21,6	90,0	21,6	89,9	21,6	89,8	21,6
13,0	11,8			90,3	20,5	90,2	20,5	90,1	20,5	90,0	20,5	89,9	20,5	89,8	20,5
15,0	13,7			90,3	19,5	90,2	19,5	90,1	19,5	90,0	19,5	89,9	19,5	89,8	19,5
70%	63,00 kW			-19,8	-20,0	54,9	30,1	54,8	31,0	54,7	31,9	54,6	32,4	54,6	32,8
		-18,8	-19,0	56,9	30,5	56,8	31,4	56,7	32,2	56,6	32,7	56,6	33,1	56,4	34,0
		-16,7	-17,0	60,9	31,2	60,8	32,0	60,7	32,8	60,6	33,2	60,5	33,6	60,4	34,4
		-13,7	-15,0	64,9	31,7	64,8	32,4	64,7	33,2	64,6	33,5	64,5	33,9	64,4	31,9
		-11,8	-13,0	68,9	32,1	68,8	32,8	68,6	33,4	68,5	33,8	68,4	34,2	68,3	29,2
		-9,8	-11,0	72,9	32,3	72,8	33,0	72,7	33,7	72,6	34,1	72,5	34,5	72,4	27,0
		-9,5	-10,0	74,9	32,4	74,5	32,9	74,0	33,5	73,5	33,9	73,0	34,3	72,5	26,0
		-8,5	-9,1	76,7	32,5	76,5	33,1	76,3	33,7	76,1	34,1	76,0	34,5	75,9	25,1
		-7,0	-7,6	79,0	32,2	78,5	32,7	78,0	33,3	77,5	33,7	77,0	34,1	76,5	23,8
		-5,0	-5,6	79,0	29,9	78,5	29,9	78,0	29,9	77,5	29,9	77,0	29,9	76,5	23,2
		-3,0	-3,7	79,0	28,0	78,5	28,0	78,0	28,0	77,5	28,0	77,0	28,0	76,5	20,8
		0,0	-0,7	79,0	25,3	78,5	25,3	78,0	25,3	77,5	25,3	77,0	25,3	76,5	18,9
		3,0	2,2	79,0	23,1	78,5	23,1	78,0	23,1	77,5	23,1	77,0	23,1	76,5	17,4
		5,0	4,1	79,0	21,9	78,5	21,9	78,0	21,9	77,5	21,9	77,0	21,9	76,5	16,5
		7,0	6,0	79,0	20,7	78,5	20,7	78,0	20,7	77,5	20,7	77,0	20,7	76,5	15,6
		9,0	7,9	79,0	19,6	78,5	19,6	78,0	19,6	77,5	19,6	77,0	19,6	76,5	14,8
		11,0	9,8	79,0	18,6	78,5	18,6	78,0	18,6	77,5	18,6	77,0	18,6	76,5	14,1
		13,0	11,8	79,0	17,7	78,5	17,7	78,0	17,7	77,5	17,7	77,0	17,7	76,5	13,4
		15,0	13,7	79,0	16,8	78,5	16,8	78,0	16,8	77,5	16,8	77,0	16,8	76,5	12,8
		60%	54,00 kW	-19,8	-20,0	54,6	32,4	54,5	33,2	54,4	33,9	54,4	34,3	54,3	34,7
-18,8	-19,0			56,6	32,7	56,5	33,4	56,4	34,2	56,3	34,6	56,1	34,8	52,3	31,9
-16,7	-17,0			60,6	33,2	60,5	33,9	60,4	34,2	60,3	34,6	60,2	34,9	60,1	31,0
-13,7	-15,0			64,6	33,5	64,5	34,2	64,4	34,9	64,3	35,3	64,2	35,6	64,1	26,6
-11,8	-13,0			68,6	33,8	68,5	34,5	68,4	35,2	68,3	35,6	68,2	35,9	68,1	24,5
-9,8	-11,0			72,6	34,0	72,5	34,7	72,4	35,4	72,3	35,8	72,2	36,1	72,1	22,6
-9,5	-10,0			74,6	34,1	74,5	34,8	74,4	35,5	74,3	35,9	74,2	36,2	74,1	21,8
-8,5	-9,1			76,6	34,2	76,5	34,9	76,4	35,6	76,3	36,0	76,2	36,3	76,1	21,1
-7,0	-7,6			79,0	33,9	78,9	34,6	78,8	35,3	78,7	35,7	78,6	36,0	78,5	20,0
-5,0	-5,6			79,0	31,6	78,9	32,3	78,8	33,0	78,7	33,4	78,6	33,7	78,5	18,7
-3,0	-3,7			79,0	29,3	78,9	30,0	78,8	30,7	78,7	31,1	78,6	31,4	78,5	17,6
0,0	-0,7			79,0	27,0	78,9	27,7	78,8	28,4	78,7	28,8	78,6	29,1	78,5	16,1
3,0	2,2			79,0	24,7	78,9	25,4	78,8	26,1	78,7	26,5	78,6	26,8	78,5	14,8
5,0	4,1			79,0	22,4	78,9	23,1	78,8	23,8	78,7	24,2	78,6	24,5	78,5	14,0
7,0	6,0			79,0	20,1	78,9	20,8	78,8	21,5	78,7	21,9	78,6	22,2	78,5	13,3
9,0	7,9			79,0	18,8	78,9	19,5	78,8	20,2	78,7	20,6	78,6	20,9	78,5	12,7
11,0	9,8			79,0	17,5	78,9	18,2	78,8	18,9	78,7	19,3	78,6	19,6	78,5	12,1
13,0	11,8			79,0	16,2	78,9	16,9	78,8	17,6	78,7	18,0	78,6	18,3	78,5	11,5
15,0	13,7			79,0	15,0	78,9	15,7	78,8	16,4	78,7	16,8	78,6	17,1	78,5	11,0
50%	45,00 kW			-19,8	-20,0	54,3	34,7	54,2	34,3	54,0	34,8	54,0	35,6	54,0	36,4
		-18,8	-19,0	56,3	34,9	56,2	35,6	56,0	36,3	56,0	37,1	56,0	37,9	43,6	25,8
		-16,7	-17,0	60,3	35,4	60,2	36,1	60,0	36,8	60,0	37,6	60,0	38,4	43,6	23,6
		-13,7	-15,0	64,3	35,9	64,2	36,6	64,0	37,3	64,0	38,1	64,0	38,9	43,6	21,6
		-11,8	-13,0	68,3	36,4	68,2	37,1	68,0	37,8	68,0	38,6	68,0	39,4	43,6	20,0
		-9,8	-11,0	72,3	36,9	72,2	37,6	72,0	38,3	72,0	39,1	72,0	39,9	43,6	18,5
		-9,5	-10,0	74,3	37,0	74,2	37,7	74,0	38,4	74,0	39,2	74,0	40,0	43,6	17,9
		-8,5	-9,1	76,3	37,1	76,2	37,8	76,0	38,5	76,0	39,3	76,0	40,1	43,6	17,3
		-7,0	-7,6	78,3	37,2	78,2	37,9	78,0	38,6	78,0	39,4	78,0	40,2	43,6	16,5
		-5,0	-5,6	78,3	36,9	78,2	37,6	78,0	38,3	78,0	39,1	78,0	39,9	43,6	15,4
		-3,0	-3,7	78,3	36,6	78,2	37,3	78,0	38,0	78,0	38,8	78,0	39,6	43,6	14,6
		0,0	-0,7	78,3	36,3	78,2	37,0	78,0	37,7	78,0	38,5				

# 5 Capacity tables

## 5 - 2 Heating Capacity Tables

RQYQ34PY1		TC: Total Capacity: kW ; PI: Power Input: kW (compressor + outdoor fan motor)													
Combination (%)	Capacity index (kW)	Outdoor air temp.		Indoor air temperature: °CDB											
				16.0		18.0		20.0		21.0		22.0		24.0	
				TC	PI	TC	PI	TC	PI	TC	PI	TC	PI	TC	PI
130	122,20 kW	-19,8	-20,0	53,8	10,4	53,5	12,1	53,3	13,9	53,1	14,8	53,0	15,7	52,8	17,4
		-18,8	-19,0	56,0	11,7	55,8	13,4	55,6	15,1	55,4	15,9	55,3	16,8	55,1	18,5
		-16,7	-17,0	60,6	14,2	60,4	15,7	60,1	17,2	60,0	18,0	59,9	18,8	59,6	20,3
		-13,7	-15,0	65,2	16,2	65,0	17,6	64,8	19,1	64,6	19,8	64,5	20,5	64,3	21,9
		-11,8	-13,0	69,9	18,0	69,6	19,3	69,4	20,6	69,3	21,3	69,1	22,0	68,9	23,3
		-9,8	-11,0	74,6	19,5	74,3	20,8	74,1	22,0	73,9	22,6	73,8	23,3	73,6	24,5
		-9,5	-10,0	76,9	20,2	76,7	21,4	76,4	22,6	76,3	23,2	76,2	23,8	75,9	25,0
		-8,5	-9,1	79,0	20,8	78,8	22,0	78,5	23,2	78,4	23,8	78,3	24,3	78,0	25,5
		-7,0	-7,6	82,6	21,8	82,3	22,9	82,1	24,0	82,0	24,6	81,8	25,1	81,6	26,2
		-5,0	-5,6	87,3	22,9	87,1	23,9	86,8	25,0	86,7	25,5	86,6	26,0	86,3	27,1
		-3,0	-3,7	91,9	23,9	91,6	24,9	91,4	25,8	91,2	26,3	91,1	26,8	90,9	27,8
		0,0	-0,7	99	25,2	99	26,1	99	27,0	98	27,5	98	28,0	98	28,9
		3,0	2,2	106	26,3	106	27,2	106	28,0	105	28,5	105	28,9	105	29,7
		5,0	4,1	111	27,0	110	27,8	110	28,6	110	29,0	110	29,4	110	30,3
		7,0	6,0	115	27,6	115	28,4	115	29,2	115	29,6	115	29,9	114	30,7
		9,0	7,9	120	28,2	120	28,9	120	29,7	119	30,0	119	30,4	119	31,2
		11,0	9,8	125	28,7	125	29,4	124	30,1	124	30,5	124	30,9	122	31,0
13,0	11,8	130	29,2	130	29,9	129	30,6	129	30,9	129	31,3	122	29,5		
15,0	13,7	135	29,7	134	30,3	134	31,0	134	31,3	131	30,8	122	28,2		
120	112,80 kW	-19,8	-20,0	53,4	12,8	53,2	14,4	53,0	16,0	52,9	16,8	52,7	17,6	52,5	19,2
		-18,8	-19,0	55,7	14,0	55,5	15,6	55,3	17,1	55,1	17,9	55,0	18,7	54,8	20,2
		-16,7	-17,0	60,3	16,2	60,1	17,7	59,8	19,1	59,7	19,8	59,6	20,5	59,4	21,9
		-13,7	-15,0	64,9	18,1	64,7	19,5	64,5	20,8	64,3	21,4	64,2	22,1	64,0	23,4
		-11,8	-13,0	69,6	19,8	69,3	21,0	69,1	22,2	69,0	22,8	68,9	23,5	68,6	24,7
		-9,8	-11,0	74,2	21,2	74,0	22,4	73,8	23,5	73,7	24,1	73,5	24,6	73,3	25,8
		-9,5	-10,0	76,6	21,9	76,3	23,0	76,1	24,1	76,0	24,6	75,9	25,2	75,7	26,3
		-8,5	-9,1	78,7	22,4	78,5	23,5	78,2	24,6	78,1	25,1	78,0	25,6	77,8	26,7
		-7,0	-7,6	82,2	23,3	82,0	24,3	81,8	25,3	81,7	25,8	81,6	26,4	81,3	27,4
		-5,0	-5,6	87,0	24,3	86,8	25,3	86,5	26,3	86,4	26,7	86,3	27,2	86,1	28,2
		-3,0	-3,7	91,5	25,2	91,3	26,1	91,1	27,0	90,9	27,5	90,8	28,0	90,6	28,9
		0,0	-0,7	99	26,4	99	27,3	98	28,1	98	28,6	98	29,0	97,8	29,8
		3,0	2,2	106	27,5	106	28,3	105	29,1	105	29,5	105	29,8	105	30,6
		5,0	4,1	110	28,1	110	28,8	110	29,6	110	30,0	110	30,4	109	31,1
		7,0	6,0	115	28,7	115	29,4	115	30,1	115	30,5	114	30,8	113	31,0
		9,0	7,9	120	29,2	120	29,9	119	30,6	119	30,9	119	31,3	113	29,5
		11,0	9,8	124	29,7	124	30,3	124	31,0	124	31,3	121	30,7	113	28,2
13,0	11,8	129	30,1	129	30,8	129	31,4	129	31,4	125	30,4	121	29,2		
15,0	13,7	134	30,6	134	31,2	130	30,3	125	29,1	121	27,9	113	25,7		
110	103,40 kW	-19,8	-20,0	53,1	15,1	52,9	16,6	52,7	18,1	52,6	18,8	52,5	19,6	52,3	21,1
		-18,8	-19,0	55,4	16,3	55,2	17,7	55,0	19,1	54,9	19,8	54,8	20,5	54,5	22,0
		-16,7	-17,0	60,0	18,3	59,8	19,6	59,5	20,9	59,4	21,6	59,3	22,2	59,1	23,5
		-13,7	-15,0	64,6	20,1	64,4	21,3	64,2	22,5	64,1	23,1	64,0	23,7	63,7	24,9
		-11,8	-13,0	69,2	21,6	69,0	22,7	68,8	23,8	68,7	24,4	68,6	24,9	68,4	26,1
		-9,8	-11,0	73,9	22,9	73,7	23,9	73,5	25,0	73,4	25,5	73,3	26,0	73,1	27,1
		-9,5	-10,0	76,2	23,5	76,0	24,5	75,8	25,5	75,7	26,0	75,6	26,5	75,4	27,5
		-8,5	-9,1	78,4	24,0	78,1	25,0	77,9	26,0	77,8	26,5	77,7	26,9	77,5	27,9
		-7,0	-7,6	81,9	24,8	81,7	25,7	81,5	26,7	81,4	27,1	81,3	27,6	81,1	28,5
		-5,0	-5,6	86,6	25,7	86,4	26,6	86,2	27,5	86,1	27,9	86,0	28,4	85,8	29,3
		-3,0	-3,7	91,2	26,5	91,0	27,4	90,8	28,2	90,7	28,6	90,6	29,1	90,3	29,9
		0,0	-0,7	98	27,7	98	28,5	98	29,2	98	29,6	97,8	30,0	97,6	30,8
		3,0	2,2	105	28,6	105	29,4	105	30,1	105	30,4	105	30,8	104	31,0
		5,0	4,1	110	29,2	110	29,9	110	30,6	110	30,9	109	31,3	104	29,4
		7,0	6,0	115	29,7	115	30,4	114	31,0	114	31,4	111	30,4	104	28,0
		9,0	7,9	119	30,2	119	30,8	119	31,4	115	30,2	111	29,0	104	26,6
		11,0	9,8	124	30,6	124	31,3	119	29,9	115	28,8	111	27,6	104	25,4
13,0	11,8	129	31,1	126	30,7	119	28,5	115	27,4	111	26,4	104	24,3		
15,0	13,7	134	31,5	126	29,4	119	27,3	115	26,3	111	25,2	104	23,3		
100	94,00 kW	-19,8	-20,0	52,8	17,5	52,6	18,9	52,4	20,2	52,3	20,9	52,2	21,6	52,0	22,9
		-18,8	-19,0	55,0	18,6	54,9	19,8	54,7	21,1	54,6	21,8	54,5	22,4	54,3	23,7
		-16,7	-17,0	59,6	20,4	59,4	21,6	59,3	22,8	59,2	23,4	59,1	24,0	58,9	25,2
		-13,7	-15,0	64,2	22,0	64,1	23,1	63,9	24,2	63,8	24,7	63,7	25,3	63,5	26,4
		-11,8	-13,0	68,9	23,4	68,7	24,4	68,5	25,4	68,4	25,9	68,3	26,4	68,1	27,4
		-9,8	-11,0	73,6	24,6	73,4	25,5	73,2	26,5	73,1	26,9	73,0	27,4	72,8	28,4
		-9,5	-10,0	75,9	25,1	75,7	26,0	75,5	26,9	75,4	27,4	75,3	27,9	75,1	28,8
		-8,5	-9,1	78,0	25,6	77,8	26,5	77,6	27,4	77,5	27,8	77,5	28,3	77,3	29,1
		-7,0	-7,6	81,6	26,3	81,4	27,1	81,2	28,0	81,1	28,4	81,0	28,8	80,8	29,7
		-5,0	-5,6	86,3	27,1	86,1	28,0	85,9	28,8	85,8	29,2	85,7	29,6	85,6	30,4
		-3,0	-3,7	90,9	27,9	90,7	28,7	90,5	29,4	90,4	29,8	90,3	30,2	90,1	30,9
		0,0	-0,7	98	28,9	98	29,6	97,7	30,3	97,6	30,7	97,5	31,0	94,1	30,1
		3,0	2,2	105	29,8	105	30,4	105	31,1	105	31,4	101	30,1	94,1	27,7
		5,0	4,1	110	30,3	110	30,9	108	30,9	105	29,8	101	28,6	94,1	26,3
		7,0	6,0	114	30,8	114	31,4	108	29,4	105	28,3	101	27,2	94,1	25,0
		9,0	7,9	119	31,2	115	30,2	108	28,0	105	26,9	101	25,9	94,1	23,9
		11,0	9,8	122	30,8	115	28,8	108	26,7	105	25,7	101	24,7	94,1	22,8
13,0	11,8	122	29,4	115	27,4	108	25,5	105	24,5	101	23,6	94,1	21,8		
15,0	13,7	122	28,1	115	26,2	108	24,4	105	23,5	101	22,6	94,1	20,9		

**NOTES - ANMERKUNGEN - Σημειώσεις - NOTAS - REMARQUES - NOTE - OPMERKINGEN - Примечания - NOTLAR**

is shown as reference. When selecting the unit models, avoid the Outdoor air temperature range shown by **■**  
 dient als Verweis. Vermeiden Sie bei der Auswahl der Gerätemodelle den als **■** markierten Temperaturbereich der Außenluft  
 Η **■** είναι ενδεικτική, κατά την επιλογή των μοντέλων των μονάδων, αποφύγετε το εύρος θερμοκρασίας εξωτερικού αέρα που υποδεικνύεται **■**  
 se muestra como referencia. Cuando seleccione los modelos de unidad, evite el intervalo de temperaturas del aire exterior indicado mediante **■**  
 est montré comme référence. Lors du choix des modèles d'unités, évitez la plage de températures de l'air extérieur illustré par **■**  
 valori riportati unicamente come riferimento. Nel selezionare i modelli delle unità, non considerare i valori di temperatura dell'aria esterna indicati con il colore **■**  
 is als referentie getoond. Wanneer modellen van eenheden worden gekozen, vermijd dan het bereik van buitenluchttemperaturen geïllustreerd door **■**  
 показан как. При выборе модели устройства избегайте внешнюю температуру **■**

воздуха, указанную в **■**  
 referans olarak gösterilmektedir. Ünite modellerini seçerken, belirtilen Dış hava sıcaklığı aralığından kaçının **■**

The above table shows the average value of conditions which may occur.  
 Die obige Tabelle zeigt den Durchschnittswert der Bedingungen, die auftreten können.  
 Στον παραπάνω πίνακα αναγράφεται η μέση τιμή για συνθήκες που μπορεί να προκύψουν.  
 La tabla de arriba muestra el valor medio de condiciones que pueden ocurrir.  
 Le tableau ci-dessus donne la valeur moyenne pour des conditions qui peuvent survenir.  
 La tabella in alto mostra il valore delle condizioni medie che si possono riscontrare.  
 De tabel hierboven geeft de gemiddelde waarde aan van situaties die kunnen voorvallen.  
 Таблица расположенная выше показывает среднее значение условий, которые могут наступить.  
 Yukarıdaki tablo meydana gelebilecek koşulların ortalama değerini göstermektedir.

# 5 Capacity tables

## 5 - 2 Heating Capacity Tables

5

RQYQ34PY1		TC: Total Capacity: kW ; PI: Power Input: kW (compressor + outdoor fan motor)													
Combination (%)	Capacity index (kW)	Outdoor air temp.		Indoor air temperature: °CDB											
				16.0		18.0		20.0		21.0		22.0		24.0	
				TC	PI	TC	PI	TC	PI	TC	PI	TC	PI	TC	PI
		°CDB	°CWB												
90%	84,60 kW	-19,8	-20,0	52,4	19,9	52,3	21,1	52,1	22,3	52,0	22,9	51,9	23,5	51,7	24,7
		-18,8	-19,0	54,7	20,8	54,5	22,0	54,4	23,1	54,3	23,7	54,2	24,3	54,0	25,5
		-16,7	-17,0	59,3	22,5	59,1	23,6	59,0	24,6	58,9	25,2	58,8	25,7	58,6	26,8
		-13,7	-15,0	63,9	23,9	63,7	24,9	63,6	25,9	63,5	26,4	63,4	26,9	63,2	27,9
		-11,8	-13,0	68,6	25,2	68,4	26,1	68,2	27,0	68,1	27,4	68,0	27,9	67,9	28,8
		-9,8	-11,0	73,2	26,2	73,1	27,1	72,9	27,9	72,8	28,4	72,7	28,8	72,5	29,7
		-9,5	-10,0	75,6	26,7	75,4	27,6	75,2	28,4	75,1	28,8	75,1	29,2	74,9	30,0
		-8,5	-9,1	77,7	27,1	77,5	27,9	77,3	28,7	77,3	29,2	77,2	29,6	77,0	30,4
		-7,0	-7,6	81,2	27,8	81,1	28,6	80,9	29,3	80,8	29,7	80,7	30,1	80,5	30,9
		-5,0	-5,6	86,0	28,6	85,8	29,3	85,6	30,0	85,6	30,4	85,5	30,7	84,7	31,1
		-3,0	-3,7	90,5	29,2	90,3	29,9	90,2	30,6	90,1	31,0	90,0	31,3	84,7	29,2
		0,0	-0,7	97,7	30,2	97,6	30,8	97,2	31,3	94,1	30,1	91,0	28,9	84,7	26,6
		3,0	2,2	105	30,9	103	31,0	97,2	28,8	94,1	27,7	91,0	26,6	84,7	24,5
		5,0	4,1	109	31,4	103	29,4	97,2	27,3	94,1	26,3	91,0	25,3	84,7	23,3
		7,0	6,0	110	30,0	103	27,9	97,2	26,0	94,1	25,0	91,0	24,0	84,7	22,2
		9,0	7,9	110	28,5	103	26,6	97,2	24,8	94,1	23,8	91,0	22,9	84,7	21,2
		11,0	9,8	110	27,2	103	25,4	97,2	23,7	94,1	22,8	91,0	21,9	84,7	20,3
		13,0	11,8	110	26,0	103	24,3	97,2	22,6	94,1	21,8	91,0	21,0	84,7	19,4
		15,0	13,7	110	24,9	103	23,2	97,2	21,7	94,1	20,9	91,0	20,1	84,7	18,6
		80%	75,20 kW	-19,8	-20,0	52,1	22,2	51,9	23,3	51,8	24,4	51,7	25,0	51,6	25,5
-18,8	-19,0			54,4	23,1	54,2	24,1	54,1	25,2	54,0	25,7	53,9	26,2	53,8	27,2
-16,7	-17,0			59,0	24,6	58,8	25,5	58,7	26,5	58,6	26,9	58,5	27,4	58,4	28,4
-13,7	-15,0			63,6	25,8	63,4	26,7	63,3	27,6	63,2	28,0	63,1	28,5	63,0	29,4
-11,8	-13,0			68,2	26,9	68,1	27,8	67,9	28,6	67,8	29,0	67,8	29,4	67,6	30,2
-9,8	-11,0			72,9	27,9	72,7	28,7	72,6	29,4	72,5	29,8	72,4	30,2	72,3	31,0
-9,5	-10,0			75,2	28,3	75,1	29,1	74,9	29,8	74,9	30,2	74,8	30,6	74,6	31,3
-8,5	-9,1			77,4	28,7	77,2	29,4	77,1	30,1	77,0	30,5	76,9	30,9	75,3	30,6
-7,0	-7,6			80,9	29,3	80,7	30,0	80,6	30,7	80,5	31,0	80,4	31,3	75,3	29,0
-5,0	-5,6			85,6	30,0	85,5	30,6	85,3	31,3	83,6	30,6	80,8	29,4	75,3	27,0
-3,0	-3,7			90,2	30,6	90,0	31,2	86,4	29,9	83,6	28,8	80,8	27,6	75,3	25,4
0,0	-0,7			97,4	31,4	92,0	29,3	86,4	27,2	83,6	26,2	80,8	25,2	75,3	23,2
3,0	2,2			97,5	28,9	92,0	26,9	86,4	25,1	83,6	24,1	80,8	23,2	75,3	21,4
5,0	4,1			97,5	27,4	92,0	25,6	86,4	23,8	83,6	22,9	80,8	22,1	75,3	20,4
7,0	6,0			97,5	26,1	92,0	24,4	86,4	22,7	83,6	21,9	80,8	21,1	75,3	19,5
9,0	7,9			97,5	24,8	92,0	23,2	86,4	21,7	83,6	20,9	80,8	20,1	75,3	18,6
11,0	9,8			97,5	23,7	92,0	22,2	86,4	20,7	83,6	20,0	80,8	19,3	75,3	17,8
13,0	11,8			97,5	22,7	92,0	21,2	86,4	19,8	83,6	19,1	80,8	18,4	75,3	17,1
15,0	13,7			97,5	21,7	92,0	20,4	86,4	19,0	83,6	18,4	80,8	17,7	75,3	16,4
70%	65,80 kW			-19,8	-20,0	51,8	24,6	51,6	25,6	51,5	26,5	51,4	27,0	51,4	27,5
		-18,8	-19,0	54,0	25,4	53,9	26,3	53,8	27,2	53,7	27,6	53,6	28,1	53,5	29,0
		-16,7	-17,0	58,6	26,7	58,5	27,5	58,4	28,3	58,3	28,7	58,2	29,2	58,1	30,0
		-13,7	-15,0	63,2	27,8	63,1	28,5	63,0	29,3	62,9	29,7	62,8	30,1	62,7	30,8
		-11,8	-13,0	67,9	28,7	67,8	29,4	67,6	30,2	67,6	30,5	67,5	30,9	65,9	30,5
		-9,8	-11,0	72,6	29,6	72,4	30,2	72,3	30,9	72,2	31,2	70,7	30,6	65,9	28,1
		-9,5	-10,0	74,9	30,0	74,8	30,6	74,6	31,2	73,2	30,6	70,7	29,4	65,9	27,1
		-8,5	-9,1	77,0	30,3	76,9	30,9	75,6	30,8	73,2	29,6	70,7	28,4	65,9	26,2
		-7,0	-7,6	80,6	30,8	80,4	31,4	75,6	29,1	73,2	28,0	70,7	26,9	65,9	24,8
		-5,0	-5,6	85,3	31,4	80,5	29,3	75,6	27,2	73,2	26,2	70,7	25,2	65,9	23,2
		-3,0	-3,7	85,3	29,5	80,5	27,5	75,6	25,5	73,2	24,6	70,7	23,7	65,9	21,8
		0,0	-0,7	85,3	26,8	80,5	25,1	75,6	23,3	73,2	22,5	70,7	21,6	65,9	20,0
		3,0	2,2	85,3	24,7	80,5	23,1	75,6	21,5	73,2	20,8	70,7	20,0	65,9	18,5
		5,0	4,1	85,3	23,5	80,5	22,0	75,6	20,5	73,2	19,8	70,7	19,1	65,9	17,7
		7,0	6,0	85,3	22,4	80,5	20,9	75,6	19,6	73,2	18,9	70,7	18,2	65,9	16,9
		9,0	7,9	85,3	21,4	80,5	20,0	75,6	18,7	73,2	18,1	70,7	17,4	65,9	16,2
		11,0	9,8	85,3	20,4	80,5	19,2	75,6	17,9	73,2	17,3	70,7	16,7	65,9	15,5
		13,0	11,8	85,3	19,6	80,5	18,3	75,6	17,2	73,2	16,6	70,7	16,0	65,9	14,9
		15,0	13,7	85,3	18,8	80,5	17,6	75,6	16,5	73,2	16,0	70,7	15,4	65,9	14,3
		60%	56,40 kW	-19,8	-20,0	51,4	27,0	51,3	27,8	51,2	28,6	51,1	29,0	51,1	29,4
-18,8	-19,0			53,7	27,6	53,6	28,4	53,5	29,2	53,4	29,6	53,4	30,0	53,3	30,7
-16,7	-17,0			58,3	28,7	58,2	29,5	58,1	30,2	58,0	30,5	58,0	30,9	56,5	30,4
-13,7	-15,0			62,9	29,7	62,8	30,4	62,7	31,0	62,6	31,3	60,6	30,2	56,5	27,7
-11,8	-13,0			67,6	30,5	67,4	31,1	64,8	29,9	62,7	28,8	60,6	27,6	56,5	25,4
-9,8	-11,0			72,2	31,2	69,0	29,7	64,8	27,6	62,7	26,5	60,6	25,5	56,5	23,5
-9,5	-10,0			73,1	30,6	69,0	28,6	64,8	26,5	62,7	25,5	60,6	24,6	56,5	22,6
-8,5	-9,1			73,1	29,6	69,0	27,6	64,8	25,7	62,7	24,7	60,6	23,8	56,5	21,9
-7,0	-7,6			73,1	28,0	69,0	26,1	64,8	24,3	62,7	23,4	60,6	22,6	56,5	20,8
-5,0	-5,6			73,1	26,1	69,0	24,4	64,8	22,8	62,7	21,9	60,6	21,1	56,5	19,5
-3,0	-3,7			73,1	24,6	69,0	23,0	64,8	21,4	62,7	20,7	60,6	19,9	56,5	18,4
0,0	-0,7			73,1	22,5	69,0	21,0	64,8	19,6	62,7	19,0	60,6	18,3	56,5	17,0
3,0	2,2			73,1	20,8	69,0	19,5	64,8	18,2	62,7	17,6	60,6	17,0	56,5	15,7
5,0	4,1			73,1	19,8	69,0	18,5	64,8	17,4	62,7	16,8	60,6	16,2	56,5	15,0
7,0	6,0			73,1	18,9	69,0	17,7	64,8	16,6	62,7	16,0	60,6	15,5	56,5	14,4
9,0	7,9			73,1	18,0	69,0	17,0	64,8	15,9	62,7	15,4	60,6	14,8	56,5	13,8
11,0	9,8			73,1	17,3	69,0	16,3	64,8	15,3	62,7	14,8	60,6	14,3	56,5	13,3
13,0	11,8			73,1	16,6	69,0	15,6	64,8	14,6	62,7	14,2	60,6	13,7	56,5	12,8
15,0	13,7			73,1	16,0	69,0	15,0	64,8	14,1	62,7	13,7	60,6	13,2	56,5	12,3
50%	47,00 kW			-19,8	-20,0	51,1	29,4	51,0	30,0	50,9	30,7	50,9	31,1	50,5	31,1
		-18,8	-19,0	53,4	29,9	53,3	30,5	53,2	31,2	52,3	30,7	50,5	29,5	47,1	27,1
		-16,7	-17,0	58,0	30,8	57,5	31,1	54,0	28,8	52,3	27,7	50,5	26,7	47,1	24,6
		-13,7	-15,0	60,9	30,3	57,5	28,3	54,0	26,3	52,3	25,3	50,5	24,3	47,1	22,5
		-11,8	-13,0	60,9	27,8	57,5	26,0	54,0	24,2	52,3	23,3	50,5	22,4	47,1	20,7
		-9,8	-11,0	60,9	25,7	57,5	24,0	54,0	22,3	52,3	21,5	50,5	20,7	47,1	19,2
		-9,5	-10,0	60,9	24,7	57,5	23,1	54,0	21,5	52,3	20,8	50,5	20,0	47,1	18,5
		-8,5	-9,1	60,9	23,9	57,5	22,4	54,0	20,9	52,3	20,1	50,5	19,4	47,1	18,0
		-7,0	-7,6	60,9	22,7	57,5	21,2	54,0	19,8	52,3	19,1	50,5	18,4	47,1	17,1
		-5,0	-5,6	60,9	21,2	57,5	19,9	54,0	18,6	52,3	18,0	50,5	17,3	47,1	16,1
		-3,0	-3,7	60,9	20,0	57,5	18,8	54,0	17,6	52,3	17,0	50,5	16,4	47,1	15,2
		0,0	-0,7	60,9	18,4	57,5	17,3	54,0	16,2	52,3	15,6	50,			



# 5 Capacity tables

## 5 - 2 Heating Capacity Tables

**RQYQ36PY1**

TC: Total Capacity: kW ; PI: Power Input: kW (compressor + outdoor fan motor)

Combination (%)	Capacity index (kW)	Outdoor air temp.		Indoor air temperature: °CDB											
				16.0		18.0		20.0		21.0		22.0		24.0	
				TC	PI	TC	PI	TC	PI	TC	PI	TC	PI	TC	PI
130	127,4 kW	-19,8	-20,0	49,8	6,2	49,6	8,3	49,3	10,4	49,2	11,4	49,1	12,5	48,8	14,5
		-18,8	-19,0	52,4	8,1	52,1	10,1	51,8	12,1	51,7	13,1	51,6	14,1	51,3	16,0
		-16,7	-17,0	57,4	11,5	57,2	13,3	56,9	15,0	56,8	15,9	56,7	16,8	56,4	18,6
		-13,7	-15,0	62,6	14,2	62,3	15,9	62,1	17,5	61,9	18,3	61,8	19,1	61,5	20,8
		-11,8	-13,0	67,8	16,6	67,5	18,1	67,3	19,6	67,1	20,3	67,0	21,1	66,7	22,6
		-9,8	-11,0	73,0	18,6	72,8	20,0	72,5	21,4	72,4	22,1	72,2	22,8	72,0	24,1
		-9,5	-10,0	75,7	19,5	75,4	20,9	75,2	22,2	75,0	22,9	74,9	23,5	74,6	24,8
		-8,5	-9,1	78,1	20,3	77,8	21,6	77,5	22,9	77,4	23,5	77,3	24,1	77,0	25,4
		-7,0	-7,6	82,1	21,5	81,8	22,7	81,6	23,9	81,4	24,5	81,3	25,1	81,0	26,3
		-5,0	-5,6	87,5	22,9	87,2	24,0	87,0	25,1	86,8	25,7	86,7	26,3	86,4	27,4
		-3,0	-3,7	92,7	24,0	92,4	25,1	92,1	26,2	92,0	26,7	91,9	27,3	91,6	28,3
		0,0	-0,7	101	25,7	101	26,7	100	27,6	100	28,1	100	28,6	100	29,6
		3,0	2,2	109	27,0	109	27,9	109	28,8	108	29,3	108	29,7	108	30,7
		5,0	4,1	114	27,8	114	28,7	114	29,5	114	30,0	114	30,4	113	31,3
		7,0	6,0	120	28,5	120	29,4	119	30,2	119	30,6	119	31,0	119	31,8
		9,0	7,9	125	29,2	125	30,0	125	30,8	125	31,2	125	31,6	124	32,3
		11,0	9,8	131	29,8	131	30,6	130	31,3	130	31,7	130	32,1	128	32,1
13,0	11,8	137	30,4	137	31,1	136	31,8	136	32,2	136	32,6	128	30,4		
15,0	13,7	142	30,9	142	31,6	142	32,3	142	32,6	137	31,5	128	28,9		
120	117,6 kW	-19,8	-20,0	49,5	9,0	49,2	10,9	49,0	12,9	48,9	13,8	48,8	14,8	48,5	16,7
		-18,8	-19,0	52,0	10,8	51,8	12,6	51,5	14,4	51,4	15,4	51,3	16,3	51,0	18,1
		-16,7	-17,0	57,1	13,9	56,8	15,5	56,6	17,2	56,5	18,0	56,4	18,8	56,1	20,5
		-13,7	-15,0	62,2	16,4	62,0	18,0	61,7	19,5	61,6	20,2	61,5	21,0	61,3	22,5
		-11,8	-13,0	67,4	18,6	67,2	20,0	66,9	21,4	66,8	22,1	66,7	22,8	66,5	24,1
		-9,8	-11,0	72,7	20,5	72,4	21,8	72,2	23,0	72,1	23,7	72,0	24,3	71,7	25,6
		-9,5	-10,0	75,3	21,3	75,1	22,6	74,8	23,8	74,7	24,4	74,6	25,0	74,4	26,2
		-8,5	-9,1	77,7	22,0	77,5	23,2	77,2	24,4	77,1	25,0	77,0	25,6	76,8	26,8
		-7,0	-7,6	81,7	23,1	81,5	24,2	81,2	25,4	81,1	25,9	81,0	26,5	80,8	27,6
		-5,0	-5,6	87,1	24,4	86,9	25,5	86,6	26,5	86,5	27,0	86,4	27,6	86,2	28,6
		-3,0	-3,7	92,3	25,5	92,1	26,5	91,8	27,5	91,7	28,0	91,6	28,5	91,4	29,5
		0,0	-0,7	101	27,0	100	27,9	100	28,8	100	29,3	100	29,7	100	30,6
		3,0	2,2	109	28,3	108	29,1	108	29,9	108	30,3	108	30,8	108	31,6
		5,0	4,1	114	29,0	114	29,8	114	30,6	114	31,0	113	31,4	113	32,2
		7,0	6,0	120	29,6	119	30,4	119	31,2	119	31,5	119	31,9	118	32,5
		9,0	7,9	125	30,3	125	31,0	125	31,7	124	32,1	124	32,4	118	30,7
		11,0	9,8	131	30,8	130	31,5	130	32,2	130	32,6	130	32,9	118	29,2
13,0	11,8	136	31,4	136	32,0	136	32,6	131	31,3	127	30,1	118	27,6		
15,0	13,7	142	31,9	142	32,5	136	31,0	131	29,8	127	28,6	118	26,3		
110	107,8 kW	-19,8	-20,0	49,1	11,8	48,9	13,6	48,7	15,4	48,6	16,2	48,5	17,1	48,3	18,9
		-18,8	-19,0	51,7	13,5	51,4	15,1	51,2	16,8	51,1	17,6	51,0	18,5	50,8	20,2
		-16,7	-17,0	56,7	16,3	56,5	17,8	56,3	19,3	56,2	20,1	56,1	20,8	55,9	22,3
		-13,7	-15,0	61,9	18,7	61,7	20,0	61,4	21,4	61,3	22,1	61,2	22,8	61,0	24,2
		-11,8	-13,0	67,1	20,6	66,9	21,9	66,6	23,2	66,5	23,8	66,4	24,4	66,2	25,7
		-9,8	-11,0	72,3	22,4	72,1	23,5	71,9	24,7	71,8	25,3	71,7	25,9	71,4	27,0
		-9,5	-10,0	75,0	23,1	74,8	24,2	74,5	25,4	74,4	25,9	74,3	26,5	74,1	27,6
		-8,5	-9,1	77,4	23,8	77,1	24,9	76,9	25,9	76,8	26,5	76,7	27,0	76,5	28,1
		-7,0	-7,6	81,4	24,8	81,2	25,8	80,9	26,8	80,8	27,3	80,7	27,9	80,5	28,9
		-5,0	-5,6	86,8	25,9	86,6	26,9	86,3	27,9	86,2	28,4	86,1	28,8	85,9	29,8
		-3,0	-3,7	92,0	27,0	91,7	27,9	91,5	28,8	91,4	29,2	91,3	29,7	91,1	30,6
		0,0	-0,7	100	28,3	100	29,2	100	30,0	100	30,4	100	30,8	99	31,7
		3,0	2,2	108	29,5	108	30,2	108	31,0	108	31,4	108	31,8	107	32,5
		5,0	4,1	114	30,1	114	30,9	113	31,6	113	32,0	113	32,3	108	31,0
		7,0	6,0	119	30,8	119	31,5	119	32,1	119	32,5	116	31,9	108	29,3
		9,0	7,9	125	31,3	124	32,0	124	32,6	120	31,4	116	30,2	108	27,7
		11,0	9,8	130	31,8	130	32,5	124	31,0	120	29,8	116	28,6	108	26,3
13,0	11,8	136	32,3	132	31,6	124	29,3	120	28,2	116	27,1	108	25,0		
15,0	13,7	140	32,3	132	30,1	124	27,9	120	26,9	116	25,9	108	23,9		
100	98,00 kW	-19,8	-20,0	48,8	14,6	48,6	16,3	48,4	17,9	48,3	18,7	48,2	19,5	48,0	21,1
		-18,8	-19,0	51,3	16,1	51,1	17,7	50,9	19,2	50,8	19,9	50,7	20,7	50,5	22,2
		-16,7	-17,0	56,4	18,7	56,2	20,1	56,0	21,5	55,9	22,1	55,8	22,8	55,6	24,2
		-13,7	-15,0	61,5	20,9	61,3	22,1	61,1	23,4	61,0	24,0	60,9	24,6	60,7	25,9
		-11,8	-13,0	66,7	22,7	66,5	23,8	66,3	25,0	66,2	25,5	66,1	26,1	65,9	27,3
		-9,8	-11,0	72,0	24,2	71,8	25,3	71,6	26,3	71,5	26,9	71,4	27,4	71,2	28,5
		-9,5	-10,0	74,6	24,9	74,4	25,9	74,2	27,0	74,1	27,5	74,0	28,0	73,8	29,0
		-8,5	-9,1	77,0	25,5	76,8	26,5	76,6	27,5	76,5	28,0	76,4	28,5	76,2	29,5
		-7,0	-7,6	81,0	26,4	80,8	27,3	80,6	28,3	80,5	28,8	80,4	29,2	80,2	30,2
		-5,0	-5,6	86,4	27,5	86,2	28,4	86,0	29,2	85,9	29,7	85,8	30,1	85,6	31,0
		-3,0	-3,7	91,6	28,4	91,4	29,2	91,2	30,1	91,1	30,5	91,0	30,9	90,8	31,7
		0,0	-0,7	100	29,7	100	30,4	99	31,2	99	31,5	99	31,9	98,5	32,4
		3,0	2,2	108	30,7	108	31,4	108	32,1	108	32,4	106	32,0	98,5	29,4
		5,0	4,1	113	31,3	113	32,0	113	32,6	109	31,4	106	30,1	98,5	27,7
		7,0	6,0	119	31,9	119	32,5	113	30,8	109	29,6	106	28,5	98,5	26,2
		9,0	7,9	124	32,4	120	31,4	113	29,2	109	28,1	106	27,0	98,5	24,8
		11,0	9,8	128	31,9	120	29,8	113	27,7	109	26,6	106	25,6	98,5	23,6
13,0	11,8	128	30,2	120	28,2	113	26,2	109	25,3	106	24,3	98,5	22,5		
15,0	13,7	128	28,8	120	26,9	113	25,0	109	24,1	106	23,2	98,5	21,4		

**NOTES - ANMERKUNGEN - Σημειώσεις - NOTAS - REMARQUES - NOTE - OPMERKINGEN - Примечания - NOTLAR**

- is shown as reference. When selecting the unit models, avoid the Outdoor air temperature range shown by
- dient als Verweis. Vermeiden Sie bei der Auswahl der Gerätemodelle den als markierten Temperaturbereich der Außenluft
- Η είναι ενδεικτική, κατά την επιλογή των μοντέλων των μονάδων, αποφύγετε το εύρος θερμοκρασίας εξωτερικού αέρα που υποδεικνύεται
- se muestra como referencia. Cuando seleccione los modelos de unidad, evite el intervalo de temperaturas del aire exterior indicado mediante
- est montré comme référence. Lors du choix des modèles d'unités, évitez la plage de températures de l'air extérieur illustré par
- valori riportati unicamente come riferimento. Nel selezionare i modelli delle unità, non considerare i valori di temperatura dell'aria esterna indicati con il colore
- is als referentie getoond. Wanneer modellen van eenheden worden gekozen, vermijd dan het bereik van buitenluchttemperaturen geïllustreerd door
- показан как. При выборе модели устройства избегайте внешнюю температуру

воздуха, указанную в  
referans olarak gösterilmektedir. Ünite modellerini seçerken, belirtilen Dış hava sıcaklığı aralığından kaçının

The above table shows the average value of conditions which may occur.  
Die obige Tabelle zeigt den Durchschnittswert der Bedingungen, die auftreten können.  
Στον παραπάνω πίνακα αναγράφεται η μέση τιμή για συνθήκες που μπορεί να προκύψουν.  
La tabla de arriba muestra el valor medio de condiciones que pueden ocurrir.  
Le tableau ci-dessus donne la valeur moyenne pour des conditions qui peuvent survenir.  
La tabella in alto mostra il valore delle condizioni medie che si possono riscontrare.  
De tabel hierboven geeft de gemiddelde waarde aan van situaties die kunnen voorvallen.  
Таблица расположенная выше показывает среднее значение условий, которые могут наступить.  
Yukarıdaki tablo meydana gelebilecek koşulların ortalama değerini göstermektedir.



# 5 Capacity tables

## 5 - 2 Heating Capacity Tables

5

RQYQ36PY1

TC: Total Capacity: kW ; PI: Power Input: kW (compressor + outdoor fan motor)

Combination (%)	Capacity index (kW)	Outdoor air temp.		Indoor air temperature: °CDB											
				16.0		18.0		20.0		21.0		22.0		24.0	
				TC	PI	TC	PI	TC	PI	TC	PI	TC	PI	TC	PI
90%	88,20 kW	-19,8	-20,0	48,4	17,5	48,3	18,9	48,1	20,4	48,0	21,1	47,9	21,8	47,7	23,2
		-18,8	-19,0	51,0	18,8	50,8	20,2	50,6	21,5	50,5	22,2	50,4	22,9	50,2	24,3
		-16,7	-17,0	56,0	21,1	55,9	22,4	55,7	23,6	55,6	24,2	55,5	24,8	55,3	26,1
		-13,7	-15,0	61,2	23,1	61,0	24,2	60,8	25,3	60,7	25,9	60,6	26,4	60,5	27,6
		-11,8	-13,0	66,4	24,7	66,2	25,7	66,0	26,8	65,9	27,3	65,8	27,8	65,7	28,8
		-9,8	-11,0	71,6	26,1	71,4	27,0	71,3	28,0	71,2	28,5	71,1	29,0	70,9	29,9
		-9,5	-10,0	74,3	26,7	74,1	27,6	73,9	28,6	73,8	29,0	73,7	29,5	73,6	30,4
		-8,5	-9,1	76,7	27,2	76,5	28,1	76,3	29,0	76,2	29,5	76,1	29,9	75,9	30,8
		-7,0	-7,6	80,7	28,1	80,5	28,9	80,3	29,7	80,2	30,2	80,1	30,6	80,0	31,4
		-5,0	-5,6	86,1	29,0	85,9	29,8	85,7	30,6	85,6	31,0	85,5	31,4	85,4	32,2
		-3,0	-3,7	91,3	29,9	91,1	30,6	90,9	31,3	90,8	31,7	90,7	32,1	90,6	31,8
		0,0	-0,7	100	31,0	99	31,7	99	32,3	98,4	32,3	95,2	31,1	88,6	28,5
		3,0	2,2	108	31,9	107	32,6	102	30,5	98,4	29,4	95,2	28,2	88,6	26,0
		5,0	4,1	113	32,5	108	31,0	102	28,8	98,4	27,7	95,2	26,6	88,6	24,5
		7,0	6,0	115	31,4	108	29,3	102	27,2	98,4	26,2	95,2	25,2	88,6	23,2
		9,0	7,9	115	29,7	108	27,7	102	25,8	98,4	24,8	95,2	23,9	88,6	22,1
		11,0	9,8	115	28,2	108	26,3	102	24,5	98,4	23,6	95,2	22,7	88,6	21,0
		13,0	11,8	115	26,7	108	25,0	102	23,3	98,4	22,4	95,2	21,6	88,6	20,0
		15,0	13,7	115	25,5	108	23,8	102	22,2	98,4	21,4	95,2	20,7	88,6	19,1
		80%	78,40 kW	-19,8	-20,0	48,1	20,3	47,9	21,6	47,8	22,9	47,7	23,5	47,6	24,1
-18,8	-19,0			50,6	21,5	50,4	22,7	50,3	23,9	50,2	24,5	50,1	25,1	50,0	26,3
-16,7	-17,0			55,7	23,5	55,5	24,6	55,4	25,7	55,3	26,3	55,2	26,8	55,1	27,9
-13,7	-15,0			60,8	25,3	60,7	26,3	60,5	27,3	60,4	27,8	60,4	28,3	60,2	29,3
-11,8	-13,0			66,0	26,7	65,9	27,6	65,7	28,5	65,6	29,0	65,5	29,5	65,4	30,4
-9,8	-11,0			71,3	27,9	71,1	28,8	71,0	29,6	70,9	30,1	70,8	30,5	70,6	31,3
-9,5	-10,0			73,9	28,5	73,8	29,3	73,6	30,1	73,5	30,6	73,4	31,0	73,3	31,8
-8,5	-9,1			76,3	29,0	76,2	29,8	76,0	30,6	75,9	31,0	75,8	31,4	75,7	32,1
-7,0	-7,6			80,3	29,7	80,2	30,5	80,0	31,2	79,9	31,6	79,9	32,0	78,8	32,1
-5,0	-5,6			85,7	30,6	85,6	31,3	85,4	32,0	85,3	32,3	84,6	32,3	78,8	29,6
-3,0	-3,7			90,9	31,3	90,8	32,0	90,4	32,5	87,5	31,3	84,6	30,0	78,8	27,6
0,0	-0,7			99	32,3	96,2	31,5	90,4	29,2	87,5	28,1	84,6	27,0	78,8	24,9
3,0	2,2			102	30,6	96,2	28,6	90,4	26,6	87,5	25,6	84,6	24,6	78,8	22,7
5,0	4,1			102	28,9	96,2	27,0	90,4	25,1	87,5	24,2	84,6	23,3	78,8	21,5
7,0	6,0			102	27,3	96,2	25,5	90,4	23,8	87,5	22,9	84,6	22,1	78,8	20,4
9,0	7,9			102	25,9	96,2	24,2	90,4	22,6	87,5	21,8	84,6	21,0	78,8	19,4
11,0	9,8			102	24,6	96,2	23,0	90,4	21,5	87,5	20,7	84,6	20,0	78,8	18,5
13,0	11,8			102	23,4	96,2	21,9	90,4	20,4	87,5	19,7	84,6	19,0	78,8	17,6
15,0	13,7			102	22,3	96,2	20,9	90,4	19,5	87,5	18,9	84,6	18,2	78,8	16,9
70%	68,60 kW			-19,8	-20,0	47,7	23,1	47,6	24,2	47,5	25,3	47,4	25,9	47,3	26,5
		-18,8	-19,0	50,3	24,1	50,1	25,2	50,0	26,3	49,9	26,8	49,8	27,3	49,7	28,4
		-16,7	-17,0	55,3	25,9	55,2	26,9	55,1	27,9	55,0	28,4	54,9	28,8	54,8	29,8
		-13,7	-15,0	60,5	27,5	60,3	28,3	60,2	29,2	60,1	29,6	60,1	30,1	59,9	31,0
		-11,8	-13,0	65,7	28,7	65,5	29,5	65,4	30,3	65,3	30,7	65,3	31,1	65,1	31,9
		-9,8	-11,0	70,9	29,8	70,8	30,6	70,6	31,3	70,6	31,7	70,5	32,0	68,9	31,8
		-9,5	-10,0	73,6	30,3	73,4	31,0	73,3	31,7	73,2	32,1	73,2	32,5	68,9	30,3
		-8,5	-9,1	76,0	30,7	75,8	31,4	75,7	32,1	75,6	32,4	74,0	31,8	68,9	29,2
		-7,0	-7,6	80,0	31,4	79,8	32,0	79,1	32,3	76,6	31,0	74,0	29,8	68,9	27,4
		-5,0	-5,6	85,4	32,1	84,2	32,1	79,1	29,8	76,6	28,7	74,0	27,5	68,9	25,4
		-3,0	-3,7	89,3	32,0	84,2	29,9	79,1	27,7	76,6	26,7	74,0	25,7	68,9	23,7
		0,0	-0,7	89,3	28,8	84,2	26,9	79,1	25,0	76,6	24,1	74,0	23,2	68,9	21,4
		3,0	2,2	89,3	26,2	84,2	24,5	79,1	22,8	76,6	22,0	74,0	21,2	68,9	19,6
		5,0	4,1	89,3	24,7	84,2	23,2	79,1	21,6	76,6	20,8	74,0	20,1	68,9	18,6
		7,0	6,0	89,3	23,4	84,2	21,9	79,1	20,5	76,6	19,8	74,0	19,1	68,9	17,7
		9,0	7,9	89,3	22,2	84,2	20,9	79,1	19,5	76,6	18,8	74,0	18,2	68,9	16,9
		11,0	9,8	89,3	21,2	84,2	19,9	79,1	18,6	76,6	17,9	74,0	17,3	68,9	16,1
		13,0	11,8	89,3	20,2	84,2	18,9	79,1	17,7	76,6	17,1	74,0	16,5	68,9	15,4
		15,0	13,7	89,3	19,3	84,2	18,1	79,1	17,0	76,6	16,4	74,0	15,8	68,9	14,7
		60%	58,80 kW	-19,8	-20,0	47,4	25,9	47,3	26,9	47,1	27,8	47,1	28,3	47,0	28,8
-18,8	-19,0			49,9	26,8	49,8	27,7	49,7	28,6	49,6	29,1	49,5	29,6	49,4	30,5
-16,7	-17,0			55,0	28,4	54,9	29,2	54,8	30,0	54,7	30,4	54,6	30,8	54,5	31,7
-13,7	-15,0			60,1	29,7	60,0	30,4	59,9	31,2	59,8	31,5	59,8	31,9	59,1	32,2
-11,8	-13,0			65,3	30,7	65,2	31,4	65,1	32,1	65,0	32,5	63,4	31,6	59,1	29,1
-9,8	-11,0			70,6	31,7	70,5	32,3	67,8	31,1	65,6	29,9	63,4	28,8	59,1	26,5
-9,5	-10,0			73,2	32,1	72,2	32,1	67,8	29,8	65,6	28,6	63,4	27,5	59,1	25,3
-8,5	-9,1			75,6	32,5	72,2	30,8	67,8	28,6	65,6	27,5	63,4	26,5	59,1	24,4
-7,0	-7,6			76,5	31,0	72,2	28,9	67,8	26,9	65,6	25,9	63,4	24,9	59,1	23,0
-5,0	-5,6			76,5	28,6	72,2	26,7	67,8	24,9	65,6	24,0	63,4	23,1	59,1	21,3
-3,0	-3,7			76,5	26,7	72,2	24,9	67,8	23,2	65,6	22,4	63,4	21,6	59,1	20,0
0,0	-0,7			76,5	24,1	72,2	22,6	67,8	21,0	65,6	20,3	63,4	19,6	59,1	18,1
3,0	2,2			76,5	22,0	72,2	20,6	67,8	19,3	65,6	18,6	63,4	18,0	59,1	16,7
5,0	4,1			76,5	20,8	72,2	19,5	67,8	18,3	65,6	17,7	63,4	17,0	59,1	15,8
7,0	6,0			76,5	19,8	72,2	18,6	67,8	17,4	65,6	16,8	63,4	16,2	59,1	15,1
9,0	7,9			76,5	18,8	72,2	17,7	67,8	16,6	65,6	16,0	63,4	15,5	59,1	14,4
11,0	9,8			76,5	17,9	72,2	16,9	67,8	15,8	65,6	15,3	63,4	14,8	59,1	13,8
13,0	11,8			76,5	17,1	72,2	16,1	67,8	15,1	65,6	14,6	63,4	14,1	59,1	13,2
15,0	13,7			76,5	16,4	72,2	15,4	67,8	14,5	65,6	14,0	63,4	13,6	59,1	12,7
50%	49,00 kW			-19,8	-20,0	47,0	28,7	46,9	29,5	46,8	30,3	46,8	30,7	46,7	31,1
		-18,8	-19,0	49,6	29,5	49,5	30,2	49,4	31,0	49,3	31,4	49,3	31,8	49,2	32,5
		-16,7	-17,0	54,6	30,8	54,5	31,5	54,4	32,1	54,4	32,5	52,9	31,5	49,2	28,9
		-13,7	-15,0	59,7	31,9	59,7	32,5	56,5	30,5	54,7	29,3	52,9	28,2	49,2	25,9
		-11,8	-13,0	63,8	31,8	60,1	29,7	56,5	27,6	54,7	26,5	52,9	25,5	49,2	23,5
		-9,8	-11,0	63,8	28,9	60,1	27,0	56,5	25,1	54,7	24,2	52,9	23,3	49,2	21,5
		-9,5	-10,0	63,8	27,7	60,1	25,9	56,5	24,1	54,7	23,2	52,9	22,3	49,2	20,7
		-8,5	-9,1	63,8	26,6	60,1	24,9	56,5	23,2	54,7	22,4	52,9	21,5	49,2	19,9
		-7,0	-7,6	63,8	25,1	60,1	23,4	56,5	21,9	54,7	21,1	52,9	20,3	49,2	18,8
		-5,0	-5,6	63,8	23,2	60,1	21,8	56,5	20,3	54,7	19,6	52,9	18,9	49,2	17,5
		-3,0	-3,7	63,8	21,7	60,1	20,4	56,5	19,0	54,7	18,4	52,9	17,7	49,2	16,5
		0,0	-0,7	63,8	19,7	60,1	18,5	56,5	17,3	54,7	16,7	52,9	16,2	49,2	15,0
		3,0	2,2												

# 5 Capacity tables

## 5 - 2 Heating Capacity Tables

RQYQ38PY1		TC: Total Capacity: kW ; PI: Power Input: kW (compressor + outdoor fan motor)													
Combination (%)	Capacity index (kW)	Outdoor air temp.		Indoor air temperature: °CDB											
				16.0		18.0		20.0		21.0		22.0		24.0	
				TC	PI	TC	PI	TC	PI	TC	PI	TC	PI	TC	PI
130	136,50 kW	-19,8	-20,0	50,5	4,8	50,3	7,0	50,0	9,3	49,9	10,4	49,7	11,6	49,5	13,8
		-18,8	-19,0	53,3	7,0	53,0	9,2	52,7	11,3	52,6	12,4	52,5	13,4	52,2	15,6
		-16,7	-17,0	58,8	10,8	58,5	12,8	58,2	14,7	58,1	15,6	57,9	16,6	57,7	18,5
		-13,7	-15,0	64,3	14,0	64,0	15,7	63,7	17,5	63,6	18,3	63,5	19,2	63,2	20,9
		-11,8	-13,0	69,9	16,6	69,6	18,2	69,3	19,8	69,2	20,6	69,0	21,4	68,8	23,0
		-9,8	-11,0	75,5	18,8	75,2	20,3	74,9	21,8	74,8	22,5	74,7	23,2	74,4	24,7
		-9,5	-10,0	78,3	19,8	78,0	21,2	77,8	22,6	77,6	23,3	77,5	24,1	77,2	25,5
		-8,5	-9,1	80,9	20,7	80,6	22,0	80,3	23,4	80,2	24,1	80,0	24,7	79,8	26,1
		-7,0	-7,6	85,1	21,9	84,9	23,2	84,6	24,5	84,5	25,2	84,3	25,8	84,0	27,1
		-5,0	-5,6	90,9	23,5	90,6	24,7	90,3	25,9	90,2	26,5	90,1	27,1	89,8	28,3
		-3,0	-3,7	96	24,7	96	25,9	96	27,0	96	27,6	96	28,1	95	29,3
		0,0	-0,7	105	26,5	105	27,5	105	28,5	104	29,1	104	29,6	104	30,6
		3,0	2,2	114	27,9	113	28,9	113	29,8	113	30,3	113	30,8	113	31,7
		5,0	4,1	119	28,8	119	29,7	119	30,6	119	31,0	119	31,5	118	32,4
		7,0	6,0	125	29,5	125	30,4	125	31,2	124	31,7	124	32,1	124	33,0
		9,0	7,9	131	30,2	131	31,0	130	31,9	130	32,3	130	32,7	130	33,5
		11,0	9,8	137	30,9	136	31,6	136	32,4	136	32,8	136	33,2	135	33,7
13,0	11,8	143	31,5	142	32,2	142	33,0	142	33,4	142	33,7	142	34,1		
15,0	13,7	149	32,0	148	32,8	148	33,5	148	33,8	145	33,1	135	30,4		
120	126,00 kW	-19,8	-20,0	50,2	7,8	49,9	9,9	49,7	12,0	49,5	13,1	49,4	14,1	49,2	16,2
		-18,8	-19,0	52,9	9,9	52,7	11,9	52,4	13,8	52,3	14,8	52,1	15,8	51,9	17,8
		-16,7	-17,0	58,4	13,4	58,1	15,2	57,9	17,0	57,8	17,9	57,6	18,7	57,4	20,5
		-13,7	-15,0	63,9	16,3	63,7	17,9	63,4	19,5	63,3	20,3	63,2	21,2	62,9	22,8
		-11,8	-13,0	69,5	18,7	69,2	20,2	69,0	21,7	68,9	22,4	68,7	23,2	68,5	24,6
		-9,8	-11,0	75,1	20,8	74,9	22,2	74,6	23,5	74,5	24,2	74,4	24,9	74,1	26,2
		-9,5	-10,0	77,9	21,7	77,7	23,0	77,4	24,3	77,3	25,0	77,2	25,6	76,9	26,9
		-8,5	-9,1	80,5	22,5	80,2	23,8	80,0	25,0	79,9	25,6	79,7	26,3	79,5	27,5
		-7,0	-7,6	84,8	23,7	84,5	24,9	84,3	26,1	84,1	26,7	84,0	27,3	83,8	28,4
		-5,0	-5,6	90,5	25,1	90,3	26,2	90,0	27,3	89,9	27,9	89,8	28,4	89,5	29,5
		-3,0	-3,7	96	26,3	96	27,3	96	28,4	96	28,9	96	29,4	95	30,4
		0,0	-0,7	105	27,9	105	28,8	104	29,8	104	30,3	104	30,7	104	31,7
		3,0	2,2	113	29,2	113	30,1	113	31,0	113	31,4	113	31,8	112	32,7
		5,0	4,1	119	30,0	119	30,8	119	31,7	118	32,1	118	32,5	118	33,3
		7,0	6,0	125	30,7	124	31,5	124	32,3	124	32,7	124	33,1	124	33,9
		9,0	7,9	130	31,3	130	32,1	130	32,9	130	33,2	130	33,6	124	32,3
		11,0	9,8	136	31,9	136	32,7	136	33,4	136	33,7	134	33,4	124	30,7
13,0	11,8	142	32,5	142	33,2	142	33,9	138	32,9	134	31,6	124	29,1		
15,0	13,7	148	33,0	148	33,7	143	32,6	138	31,3	134	30,1	124	27,7		
110	115,50 kW	-19,8	-20,0	49,8	10,9	49,6	12,8	49,3	14,7	49,2	15,7	49,1	16,6	48,9	18,6
		-18,8	-19,0	52,5	12,8	52,3	14,6	52,1	16,4	52,0	17,3	51,8	18,2	51,6	20,0
		-16,7	-17,0	58,0	16,0	57,8	17,6	57,6	19,3	57,4	20,1	57,3	20,9	57,1	22,5
		-13,7	-15,0	63,5	18,7	63,3	20,2	63,1	21,6	63,0	22,4	62,9	23,1	62,6	24,6
		-11,8	-13,0	69,1	20,9	68,9	22,3	68,7	23,6	68,5	24,3	68,4	24,9	68,2	26,3
		-9,8	-11,0	74,7	22,8	74,5	24,0	74,3	25,3	74,2	25,9	74,1	26,5	73,8	27,8
		-9,5	-10,0	77,6	23,6	77,3	24,8	77,1	26,0	77,0	26,6	76,9	27,2	76,6	28,4
		-8,5	-9,1	80,1	24,3	79,9	25,5	79,7	26,6	79,5	27,2	79,4	27,8	79,2	29,0
		-7,0	-7,6	84,4	25,4	84,2	26,5	83,9	27,6	83,8	28,2	83,7	28,7	83,5	29,8
		-5,0	-5,6	90,1	26,7	89,9	27,7	89,7	28,8	89,6	29,3	89,5	29,8	89,2	30,8
		-3,0	-3,7	96	27,8	96	28,8	96	29,7	96	30,2	96	30,7	95	31,6
		0,0	-0,7	104	29,3	104	30,2	104	31,0	104	31,5	104	31,9	103	32,8
		3,0	2,2	113	30,5	113	31,3	113	32,1	112	32,5	112	32,9	112	33,7
		5,0	4,1	119	31,2	118	32,0	118	32,7	118	33,1	118	33,5	114	32,6
		7,0	6,0	124	31,9	124	32,6	124	33,3	124	33,7	122	33,5	114	30,8
		9,0	7,9	130	32,4	130	33,1	130	33,8	127	33,0	122	31,7	114	29,2
		11,0	9,8	136	33,0	136	33,7	131	32,6	127	31,3	122	30,1	114	27,7
13,0	11,8	142	33,5	139	33,2	131	30,9	127	29,7	122	28,5	114	26,3		
15,0	13,7	148	33,9	139	31,6	131	29,4	127	28,3	122	27,2	114	25,1		
100	105,00 kW	-19,8	-20,0	49,4	14,0	49,2	15,7	49,0	17,4	48,9	18,3	48,8	19,2	48,6	20,9
		-18,8	-19,0	52,2	15,7	52,0	17,3	51,7	19,0	51,6	19,8	51,5	20,6	51,3	22,3
		-16,7	-17,0	57,6	18,6	57,4	20,1	57,2	21,6	57,1	22,3	57,0	23,0	56,8	24,5
		-13,7	-15,0	63,2	21,0	63,0	22,4	62,8	23,7	62,7	24,4	62,6	25,1	62,3	26,4
		-11,8	-13,0	68,8	23,1	68,5	24,3	68,3	25,5	68,2	26,1	68,1	26,7	67,9	28,0
		-9,8	-11,0	74,4	24,8	74,2	25,9	74,0	27,0	73,9	27,6	73,7	28,2	73,5	29,3
		-9,5	-10,0	77,2	25,5	77,0	26,6	76,8	27,7	76,7	28,3	76,6	28,8	76,4	29,9
		-8,5	-9,1	79,8	26,2	79,5	27,2	79,3	28,3	79,2	28,8	79,1	29,3	78,9	30,4
		-7,0	-7,6	84,0	27,2	83,8	28,2	83,6	29,2	83,5	29,7	83,4	30,1	83,2	31,1
		-5,0	-5,6	89,8	28,3	89,6	29,3	89,4	30,2	89,3	30,7	89,1	31,1	88,9	32,1
		-3,0	-3,7	95	29,3	95	30,2	95	31,1	95	31,5	95	31,9	94	32,8
		0,0	-0,7	104	30,7	104	31,5	104	32,3	104	32,7	103	33,1	103	33,9
		3,0	2,2	113	31,8	112	32,5	112	33,3	112	33,6	111	33,7	104	30,9
		5,0	4,1	118	32,4	118	33,1	118	33,8	115	33,0	111	31,7	104	29,2
		7,0	6,0	124	33,0	124	33,7	119	32,4	115	31,2	111	29,9	104	27,6
		9,0	7,9	130	33,6	127	33,0	119	30,7	115	29,5	111	28,4	104	26,1
		11,0	9,8	134	33,6	127	31,3	119	29,1	115	28,0	111	26,9	104	24,8
13,0	11,8	134	31,8	127	29,7	119	27,6	115	26,6	111	25,6	104	23,6		
15,0	13,7	134	30,3	127	28,3	119	26,3	115	25,4	111	24,4	104	22,5		

**NOTES - ANMERKUNGEN - Σημειώσεις - NOTAS - REMARQUES - NOTE - OPMERKINGEN - Примечания - NOTLAR**

is shown as reference. When selecting the unit models, avoid the Outdoor air temperature range shown by **■**  
 dient als Verweis. Vermeiden Sie bei der Auswahl der Gerätemodelle den als **■** markierten Temperaturbereich der Außenluft  
 Η **■** είναι ενδεικτική, κατά την επιλογή των μοντέλων των μονάδων, αποφύγετε το εύρος θερμοκρασίας εξωτερικού αέρα που υποδεικνύεται **■**  
 se muestra como referencia. Cuando seleccione los modelos de unidad, evite el intervalo de temperaturas del aire exterior indicado mediante **■**  
 est montré comme référence. Lors du choix des modèles d'unités, évitez la plage de températures de l'air extérieur illustré par **■**  
 valori riportati unicamente come riferimento. Nel selezionare i modelli delle unità, non considerare i valori di temperatura dell'aria esterna indicati con il colore **■**  
 is als referentie getoond. Wanneer modellen van eenheden worden gekozen, vermijd dan het bereik van buitenluchttemperaturen geïllustreerd door **■**  
 показан как. При выборе модели устройства избегайте внешнюю температуру **■**

воздуха, указанную в **■**  
 referans olarak gösterilmektedir. Ünite modellerini seçerken, belirtilen Dış hava sıcaklığı aralığından kaçının **■**

The above table shows the average value of conditions which may occur.  
 Die obige Tabelle zeigt den Durchschnittswert der Bedingungen, die auftreten können.  
 Στον παραπάνω πίνακα αναγράφεται η μέση τιμή για συνθήκες που μπορεί να προκύψουν.  
 La tabla de arriba muestra el valor medio de condiciones que pueden ocurrir.  
 Le tableau ci-dessus donne la valeur moyenne pour des conditions qui peuvent survenir.  
 La tabella in alto mostra il valore delle condizioni medie che si possono riscontrare.  
 De tabel hierboven geeft de gemiddelde waarde aan van situaties die kunnen voorvallen.  
 Таблица расположенная выше показывает среднее значение условий, которые могут наступить.  
 Yukarıdaki tablo meydana gelebilecek koşulların ortalama değerini göstermektedir.

# 5 Capacity tables

## 5 - 2 Heating Capacity Tables

5

RQYQ38PY1

TC: Total Capacity: kW ; PI: Power Input: kW (compressor + outdoor fan motor)

Combination (%)	Capacity index (kW)	Outdoor air temp.		Indoor air temperature: °CDB											
				16.0		18.0		20.0		21.0		22.0		24.0	
				TC	PI	TC	PI	TC	PI	TC	PI	TC	PI	TC	PI
90%	94,50 kW	-19,8	-20,0	49,1	17,0	48,9	18,6	48,7	20,2	48,6	20,9	48,5	21,7	48,3	23,3
		-18,8	-19,0	51,8	18,6	51,6	20,0	51,4	21,5	51,3	22,3	51,2	23,0	51,0	24,5
		-16,7	-17,0	57,3	21,2	57,1	22,5	56,9	23,9	56,8	24,5	56,7	25,2	56,5	26,5
		-13,7	-15,0	62,8	23,4	62,6	24,6	62,4	25,8	62,3	26,4	62,2	27,0	62,1	28,2
		-11,8	-13,0	68,4	25,2	68,2	26,3	68,0	27,4	67,9	28,0	67,8	28,5	67,6	29,6
		-9,8	-11,0	74,0	26,8	73,8	27,8	73,6	28,8	73,5	29,3	73,4	29,8	73,3	30,8
		-9,5	-10,0	76,8	27,4	76,6	28,4	76,5	29,4	76,4	29,9	76,3	30,4	76,1	31,4
		-8,5	-9,1	79,4	28,0	79,2	29,0	79,0	29,9	78,9	30,4	78,8	30,9	78,6	31,8
		-7,0	-7,6	83,7	28,9	83,5	29,8	83,3	30,7	83,2	31,1	83,1	31,6	82,9	32,5
		-5,0	-5,6	89,4	30,0	89,2	30,8	89,0	31,6	88,9	32,1	88,8	32,5	88,7	33,3
		-3,0	-3,7	95	30,9	95	31,6	95	32,4	94	32,8	94	33,2	93,3	33,5
		0,0	-0,7	104	32,1	103	32,8	103	33,5	103	33,9	100	32,7	93,3	30,1
		3,0	2,2	112	33,1	112	33,7	107	32,2	104	30,9	100	29,7	93,3	27,4
		5,0	4,1	118	33,7	114	32,6	107	30,3	104	29,1	100	28,0	93,3	25,8
		7,0	6,0	121	33,0	114	30,8	107	28,6	104	27,6	100	26,5	93,3	24,4
		9,0	7,9	121	31,2	114	29,1	107	27,1	104	26,1	100	25,1	93,3	23,2
		11,0	9,8	121	29,6	114	27,7	107	25,8	104	24,8	100	23,9	93,3	22,1
		13,0	11,8	121	28,1	114	26,3	107	24,5	104	23,6	100	22,7	93,3	21,0
		15,0	13,7	121	26,8	114	25,1	107	23,4	104	22,5	100	21,7	93,3	20,1
		80%	84,00 kW	-19,8	-20,0	48,7	20,1	48,5	21,5	48,4	22,9	48,3	23,6	48,2	24,3
-18,8	-19,0			51,4	21,5	51,3	22,8	51,1	24,1	51,0	24,7	50,9	25,4	50,8	26,7
-16,7	-17,0			56,9	23,8	56,7	25,0	56,6	26,2	56,5	26,8	56,4	27,4	56,2	28,5
-13,7	-15,0			62,4	25,7	62,3	26,8	62,1	27,9	62,0	28,4	61,9	29,0	61,8	30,0
-11,8	-13,0			68,0	27,4	67,9	28,3	67,7	29,3	67,6	29,8	67,5	30,3	67,3	31,3
-9,8	-11,0			73,6	28,7	73,5	29,6	73,3	30,5	73,2	31,0	73,1	31,4	73,0	32,4
-9,5	-10,0			76,5	29,4	76,3	30,2	76,1	31,1	76,0	31,5	76,0	32,0	75,8	32,8
-8,5	-9,1			79,0	29,9	78,9	30,7	78,7	31,5	78,6	32,0	78,5	32,4	78,3	33,2
-7,0	-7,6			83,3	30,7	83,1	31,5	83,0	32,2	82,9	32,6	82,8	33,0	82,6	33,8
-5,0	-5,6			89,0	31,6	88,9	32,3	88,7	33,1	88,6	33,5	88,5	33,8	83,0	31,4
-3,0	-3,7			95	32,4	94	33,1	94,2	33,8	92,1	33,0	89,1	31,7	83,0	29,2
0,0	-0,7			103	33,5	101	33,2	95,2	30,8	92,1	29,6	89,1	28,5	83,0	26,2
3,0	2,2			107	32,3	101	30,1	95,2	28,0	92,1	27,0	89,1	25,9	83,0	23,9
5,0	4,1			107	30,4	101	28,4	95,2	26,4	92,1	25,4	89,1	24,5	83,0	22,6
7,0	6,0			107	28,7	101	26,8	95,2	25,0	92,1	24,1	89,1	23,2	83,0	21,5
9,0	7,9			107	27,2	101	25,4	95,2	23,7	92,1	22,9	89,1	22,0	83,0	20,4
11,0	9,8			107	25,9	101	24,2	95,2	22,6	92,1	21,8	89,1	21,0	83,0	19,5
13,0	11,8			107	24,6	101	23,0	95,2	21,5	92,1	20,7	89,1	20,0	83,0	18,5
15,0	13,7			107	23,4	101	22,0	95,2	20,5	92,1	19,8	89,1	19,1	83,0	17,8
70%	73,50 kW			-19,8	-20,0	48,3	23,1	48,2	24,4	48,0	25,6	48,0	26,2	47,9	26,8
		-18,8	-19,0	51,1	24,3	50,9	25,5	50,8	26,6	50,7	27,2	50,6	27,8	50,5	28,9
		-16,7	-17,0	56,5	26,4	56,4	27,4	56,3	28,5	56,2	29,0	56,1	29,5	56,0	30,5
		-13,7	-15,0	62,1	28,1	61,9	29,0	61,8	30,0	61,7	30,4	61,6	30,9	61,5	31,9
		-11,8	-13,0	67,7	29,5	67,5	30,4	67,4	31,2	67,3	31,7	67,2	32,1	67,1	32,9
		-9,8	-11,0	73,3	30,7	73,1	31,5	73,0	32,3	72,9	32,7	72,8	33,1	72,6	33,8
		-9,5	-10,0	76,1	31,3	76,0	32,0	75,8	32,8	75,7	33,2	75,7	33,5	72,6	32,3
		-8,5	-9,1	78,7	31,7	78,5	32,4	78,4	33,2	78,3	33,5	77,9	33,7	72,6	31,0
		-7,0	-7,6	82,9	32,4	82,8	33,1	82,6	33,8	80,6	32,9	77,9	31,6	72,6	29,1
		-5,0	-5,6	88,7	33,2	88,5	33,9	88,3	34,5	80,6	30,3	77,9	29,1	72,6	26,8
		-3,0	-3,7	94,0	33,8	88,7	31,5	83,3	29,3	80,6	28,2	77,9	27,1	72,6	25,0
		0,0	-0,7	94,0	30,3	88,7	28,3	83,3	26,4	80,6	25,4	77,9	24,5	72,6	22,6
		3,0	2,2	94,0	27,6	88,7	25,8	83,3	24,0	80,6	23,2	77,9	22,3	72,6	20,7
		5,0	4,1	94,0	26,0	88,7	24,4	83,3	22,7	80,6	21,9	77,9	21,1	72,6	19,6
		7,0	6,0	94,0	24,6	88,7	23,1	83,3	21,6	80,6	20,8	77,9	20,1	72,6	18,6
		9,0	7,9	94,0	23,4	88,7	21,9	83,3	20,5	80,6	19,8	77,9	19,1	72,6	17,7
		11,0	9,8	94,0	22,3	88,7	20,9	83,3	19,5	80,6	18,9	77,9	18,2	72,6	16,9
		13,0	11,8	94,0	21,2	88,7	19,9	83,3	18,6	80,6	18,0	77,9	17,4	72,6	16,2
		15,0	13,7	94,0	20,3	88,7	19,0	83,3	17,8	80,6	17,2	77,9	16,7	72,6	15,5
		60%	63,00 kW	-19,8	-20,0	48,0	26,2	47,8	27,2	47,7	28,3	47,7	28,8	47,6	29,3
-18,8	-19,0			50,7	27,2	50,6	28,2	50,4	29,2	50,4	29,7	50,3	30,2	50,2	31,2
-16,7	-17,0			56,2	29,0	56,1	29,9	55,9	30,8	55,9	31,2	55,8	31,7	55,7	32,5
-13,7	-15,0			61,7	30,5	61,6	31,3	61,5	32,1	61,4	32,5	61,3	32,9	61,2	33,7
-11,8	-13,0			67,3	31,7	67,2	32,4	67,0	33,1	67,0	33,5	66,8	33,8	62,2	31,0
-9,8	-11,0			72,9	32,7	72,8	33,4	71,4	33,1	69,1	31,9	66,8	30,6	62,2	28,2
-9,5	-10,0			75,7	33,2	75,6	33,8	71,4	31,6	69,1	30,4	66,8	29,3	62,2	26,9
-8,5	-9,1			78,3	33,6	76,0	32,7	71,4	30,4	69,1	29,2	66,8	28,1	62,2	25,9
-7,0	-7,6			80,6	32,9	76,0	30,7	71,4	28,5	69,1	27,4	66,8	26,4	62,2	24,4
-5,0	-5,6			80,6	30,3	76,0	28,3	71,4	26,3	69,1	25,4	66,8	24,4	62,2	22,6
-3,0	-3,7			80,6	28,2	76,0	26,3	71,4	24,5	69,1	23,7	66,8	22,8	62,2	21,1
0,0	-0,7			80,6	25,4	76,0	23,8	71,4	22,2	69,1	21,4	66,8	20,6	62,2	19,1
3,0	2,2			80,6	23,2	76,0	21,7	71,4	20,3	69,1	19,6	66,8	18,9	62,2	17,6
5,0	4,1			80,6	21,9	76,0	20,6	71,4	19,2	69,1	18,6	66,8	17,9	62,2	16,7
7,0	6,0			80,6	20,8	76,0	19,5	71,4	18,3	69,1	17,7	66,8	17,1	62,2	15,9
9,0	7,9			80,6	19,8	76,0	18,6	71,4	17,4	69,1	16,8	66,8	16,3	62,2	15,2
11,0	9,8			80,6	18,9	76,0	17,7	71,4	16,6	69,1	16,1	66,8	15,6	62,2	14,5
13,0	11,8			80,6	18,0	76,0	16,9	71,4	15,9	69,1	15,4	66,8	14,9	62,2	13,9
15,0	13,7			80,6	17,2	76,0	16,2	71,4	15,2	69,1	14,8	66,8	14,3	62,2	13,3
50%	52,50 kW			-19,8	-20,0	47,6	29,3	47,5	30,1	47,4	31,0	47,3	31,4	47,3	31,9
		-18,8	-19,0	50,3	30,1	50,2	30,9	50,1	31,8	50,1	32,2	50,0	32,6	49,9	33,4
		-16,7	-17,0	55,8	31,6	55,7	32,3	55,6	33,1	55,5	33,4	55,5	33,8	51,9	31,2
		-13,7	-15,0	61,3	32,8	61,2	33,5	59,5	32,7	57,6	31,5	55,7	30,3	51,9	27,8
		-11,8	-13,0	66,9	33,8	63,3	31,7	59,5	29,5	57,6	28,4	55,7	27,3	51,9	25,1
		-9,8	-11,0	67,1	30,8	63,3	28,8	59,5	26,8	57,6	25,8	55,7	24,8	51,9	22,9
		-9,5	-10,0	67,1	29,4	63,3	27,5	59,5	25,6	57,6	24,7	55,7	23,7	51,9	22,0
		-8,5	-9,1	67,1	28,3	63,3	26,4	59,5	24,6	57,6	23,7	55,7	22,9	51,9	21,2
		-7,0	-7,6	67,1	26,6	63,3	24,8	59,5	23,2	57,6	22,3	55,7	21,5	51,9	19,9
		-5,0	-5,6	67,1	24,6	63,3	23,0	59,5	21,5	57,6	20,7	55,7	20,0	51,9	18,5
		-3,0	-3,7	67,1	22,9	63,3	21,5	59,5	20,1	57,6	19,4	55,7	18,7	51,9	17,4
		0,0	-0,7	67,1	20,8	63,3	19,5	59,5	18,2	57,6	17,6	55,7	17,0	51,9	15,8
		3,0	2,2	67,1	19,0	63,3	17,9								

# 5 Capacity tables

## 5 - 2 Heating Capacity Tables

**RQYQ40PY1**

TC: Total Capacity: kW ; PI: Power Input: kW (compressor + outdoor fan motor)

Combination (%)	Capacity index (kW)	Outdoor air temp.		Indoor air temperature: °CDB											
				16.0		18.0		20.0		21.0		22.0		24.0	
				TC	PI	TC	PI	TC	PI	TC	PI	TC	PI	TC	PI
130	146,12 kW	-19,8	-20,0	63,9	12,5	63,6	14,4	63,4	16,4	63,2	17,3	63,1	18,3	62,8	20,2
		-18,8	-19,0	66,5	13,9	66,2	15,8	65,9	17,6	65,8	18,5	65,6	19,4	65,3	21,3
		-16,7	-17,0	71,6	16,4	71,3	18,1	71,0	19,8	70,9	20,7	70,7	21,5	70,4	23,2
		-13,7	-15,0	76,7	18,5	76,4	20,1	76,1	21,7	76,0	22,5	75,8	23,3	75,5	24,9
		-11,8	-13,0	81,8	20,4	81,5	21,9	81,2	23,3	81,1	24,1	80,9	24,8	80,6	26,3
		-9,8	-11,0	86,9	22,0	86,6	23,4	86,3	24,8	86,2	25,5	86,0	26,2	85,8	27,6
		-9,5	-10,0	89,5	22,8	89,2	24,1	88,9	25,4	88,7	26,1	88,6	26,8	88,3	28,1
		-8,5	-9,1	91,7	23,4	91,5	24,7	91,2	26,0	91,0	26,6	90,9	27,3	90,6	28,6
		-7,0	-7,6	95,6	24,4	95,3	25,6	95,0	26,9	94,9	27,5	94,7	28,1	94,4	29,4
		-5,0	-5,6	101	25,5	100	26,7	100	27,9	100	28,5	100	29,1	100	30,3
		-3,0	-3,7	106	26,5	105	27,7	105	28,8	105	29,4	105	29,9	104	31,1
		0,0	-0,7	113	28,0	113	29,0	113	30,1	112	30,6	112	31,1	112	32,2
		3,0	2,2	121	29,2	120	30,1	120	31,1	120	31,6	120	32,1	119	33,1
		5,0	4,1	125	29,9	125	30,8	125	31,7	125	32,2	125	32,7	124	33,6
		7,0	6,0	130	30,5	130	31,4	130	32,3	130	32,8	129	33,2	129	34,1
		9,0	7,9	135	31,1	135	32,0	135	32,8	134	33,3	134	33,7	134	34,6
		11,0	9,8	140	31,7	140	32,5	139	33,3	139	33,8	139	34,2	139	35,0
13,0	11,8	145	32,2	145	33,0	145	33,8	144	34,2	144	34,6	142	34,6		
15,0	13,7	150	32,7	150	33,5	149	34,3	149	34,7	149	35,0	142	33,2		
120	134,88 kW	-19,8	-20,0	63,5	15,1	63,3	16,9	63,0	18,7	62,9	19,5	62,7	20,4	62,5	22,2
		-18,8	-19,0	66,1	16,4	65,8	18,1	65,6	19,8	65,4	20,7	65,3	21,5	65,0	23,2
		-16,7	-17,0	71,2	18,7	70,9	20,3	70,7	21,8	70,5	22,6	70,4	23,4	70,1	25,0
		-13,7	-15,0	76,3	20,7	76,0	22,1	75,8	23,6	75,6	24,3	75,5	25,1	75,2	26,5
		-11,8	-13,0	81,4	22,4	81,1	23,7	80,9	25,1	80,7	25,8	80,6	26,5	80,4	27,8
		-9,8	-11,0	86,5	23,9	86,2	25,2	86,0	26,4	85,9	27,1	85,7	27,7	85,5	29,0
		-9,5	-10,0	89,1	24,6	88,8	25,8	88,5	27,0	88,4	27,7	88,3	28,3	88,0	29,5
		-8,5	-9,1	91,4	25,1	91,1	26,4	90,8	27,6	90,7	28,2	90,6	28,8	90,3	30,0
		-7,0	-7,6	95,2	26,0	94,9	27,2	94,7	28,4	94,5	28,9	94,4	29,5	94,1	30,7
		-5,0	-5,6	100	27,1	100	28,2	100	29,3	100	29,9	100	30,4	99	31,5
		-3,0	-3,7	105	28,1	105	29,1	105	30,2	104	30,7	104	31,2	104	32,2
		0,0	-0,7	113	29,4	113	30,3	112	31,3	112	31,8	112	32,3	112	33,3
		3,0	2,2	120	30,5	120	31,4	120	32,3	120	32,7	119	33,2	119	34,1
		5,0	4,1	125	31,1	125	32,0	125	32,9	124	33,3	124	33,7	124	34,6
		7,0	6,0	130	31,7	130	32,6	129	33,4	129	33,8	129	34,2	129	35,1
		9,0	7,9	135	32,3	134	33,1	134	33,9	134	34,3	134	34,7	131	34,3
		11,0	9,8	140	32,8	139	33,6	139	34,4	139	34,7	139	35,1	131	32,8
13,0	11,8	145	33,3	144	34,1	144	34,8	144	35,2	140	34,2	131	31,4		
15,0	13,7	150	33,8	149	34,5	149	35,2	145	34,2	140	32,8	131	30,2		
110	123,64 kW	-19,8	-20,0	63,2	17,7	62,9	19,3	62,7	21,0	62,5	21,8	62,4	22,6	62,2	24,2
		-18,8	-19,0	65,7	18,9	65,5	20,5	65,2	22,0	65,1	22,8	65,0	23,6	64,7	25,1
		-16,7	-17,0	70,8	21,0	70,6	22,4	70,3	23,9	70,2	24,6	70,1	25,3	69,8	26,8
		-13,7	-15,0	75,9	22,8	75,7	24,1	75,4	25,5	75,3	26,2	75,2	26,8	74,9	28,2
		-11,8	-13,0	81,0	24,4	80,8	25,6	80,5	26,9	80,4	27,5	80,3	28,1	80,1	29,4
		-9,8	-11,0	86,1	25,8	85,9	26,9	85,6	28,1	85,5	28,7	85,4	29,3	85,2	30,4
		-9,5	-10,0	88,7	26,4	88,4	27,5	88,2	28,7	88,1	29,2	88,0	29,8	87,7	30,9
		-8,5	-9,1	91,0	26,9	90,7	28,0	90,5	29,1	90,4	29,7	90,3	30,2	90,0	31,3
		-7,0	-7,6	94,8	27,7	94,6	28,8	94,3	29,9	94,2	30,4	94,1	30,9	93,8	32,0
		-5,0	-5,6	100	28,7	100	29,7	99	30,7	99	31,2	99	31,7	99	32,8
		-3,0	-3,7	105	29,6	105	30,6	104	31,5	104	32,0	104	32,5	104	33,4
		0,0	-0,7	112	30,8	112	31,7	112	32,6	112	33,0	112	33,5	111	34,3
		3,0	2,2	120	31,8	120	32,6	119	33,5	119	33,9	119	34,3	119	35,1
		5,0	4,1	125	32,4	124	33,2	124	34,0	124	34,4	124	34,8	120	33,9
		7,0	6,0	130	33,0	129	33,7	129	34,5	129	34,9	129	35,2	120	32,3
		9,0	7,9	134	33,5	134	34,2	134	34,9	133	35,0	129	33,6	120	30,9
		11,0	9,8	139	33,9	139	34,6	138	34,9	133	33,5	129	32,2	120	29,6
13,0	11,8	144	34,4	144	35,1	138	33,4	133	32,1	129	30,8	120	28,4		
15,0	13,7	149	34,8	146	34,5	138	32,1	133	30,8	129	29,7	120	27,3		
100	112,40 kW	-19,8	-20,0	62,8	20,3	62,5	21,8	62,3	23,3	62,2	24,0	62,1	24,7	61,9	26,2
		-18,8	-19,0	65,3	21,4	65,1	22,8	64,9	24,2	64,8	24,9	64,7	25,6	64,4	27,1
		-16,7	-17,0	70,4	23,3	70,2	24,6	70,0	25,9	69,9	26,6	69,8	27,2	69,5	28,5
		-13,7	-15,0	75,5	24,9	75,3	26,2	75,1	27,4	75,0	28,0	74,9	28,6	74,6	29,8
		-11,8	-13,0	80,6	26,4	80,4	27,5	80,2	28,6	80,1	29,2	80,0	29,8	79,8	30,9
		-9,8	-11,0	85,7	27,6	85,5	28,7	85,3	29,8	85,2	30,3	85,1	30,8	84,9	31,9
		-9,5	-10,0	88,3	28,2	88,1	29,2	87,9	30,3	87,7	30,8	87,6	31,3	87,4	32,3
		-8,5	-9,1	90,6	28,7	90,4	29,7	90,2	30,7	90,0	31,2	89,9	31,7	89,7	32,7
		-7,0	-7,6	94,4	29,4	94,2	30,4	94,0	31,4	93,9	31,8	93,8	32,3	93,5	33,3
		-5,0	-5,6	100	30,3	99	31,3	99	32,2	99	32,6	99	33,1	99	34,0
		-3,0	-3,7	104	31,1	104	32,0	104	32,9	104	33,3	104	33,7	103	34,6
		0,0	-0,7	112	32,2	112	33,0	112	33,8	111	34,2	111	34,6	109	34,3
		3,0	2,2	119	33,1	119	33,9	119	34,6	119	35,0	117	34,6	109	31,8
		5,0	4,1	124	33,7	124	34,4	124	35,1	121	34,3	117	32,9	109	30,3
		7,0	6,0	129	34,2	129	34,9	125	34,0	121	32,7	117	31,4	109	28,9
		9,0	7,9	134	34,6	133	35,0	125	32,5	121	31,3	117	30,1	109	27,7
		11,0	9,8	139	35,1	133	33,5	125	31,1	121	30,0	117	28,8	109	26,6
13,0	11,8	141	34,4	133	32,1	125	29,8	121	28,7	117	27,6	109	25,5		
15,0	13,7	141	33,0	133	30,8	125	28,7	121	27,6	117	26,6	109	24,5		

**NOTES - ANMERKUNGEN - Σημειώσεις - NOTAS - REMARQUES - NOTE - OPMERKINGEN - Примечания - NOTLAR**

- is shown as reference. When selecting the unit models, avoid the Outdoor air temperature range shown by
- dient als Verweis. Vermeiden Sie bei der Auswahl der Gerätemodelle den als markierten Temperaturbereich der Außenluft
- Η είναι ενδεικτική, κατά την επιλογή των μοντέλων των μονάδων, αποφύγετε το εύρος θερμοκρασίας εξωτερικού αέρα που υποδεικνύεται
- se muestra como referencia. Cuando seleccione los modelos de unidad, evite el intervalo de temperaturas del aire exterior indicado mediante
- est montré comme référence. Lors du choix des modèles d'unités, évitez la plage de températures de l'air extérieur illustré par
- valori riportati unicamente come riferimento. Nel selezionare i modelli delle unità, non considerare i valori di temperatura dell'aria esterna indicati con il colore
- is als referentie getoond. Wanneer modellen van eenheden worden gekozen, vermijd dan het bereik van buitenluchttemperaturen geïllustreerd door
- показан как. При выборе модели устройства избегайте внешнюю температуру

воздуха, указанную в  
referans olarak gösterilmektedir. Ünite modellerini seçerken, belirtilen Dış hava sıcaklığı aralığından kaçınınız

The above table shows the average value of conditions which may occur.  
Die obige Tabelle zeigt den Durchschnittswert der Bedingungen, die auftreten können.  
Στον παραπάνω πίνακα αναγράφεται η μέση τιμή για συνθήκες που μπορεί να προκύψουν.  
La tabla de arriba muestra el valor medio de condiciones que pueden ocurrir.  
Le tableau ci-dessus donne la valeur moyenne pour des conditions qui peuvent survenir.  
La tabella in alto mostra il valore delle condizioni medie che si possono riscontrare.  
De tabel hierboven geeft de gemiddelde waarde aan van situaties die kunnen voorvallen.  
Таблица расположенная выше показывает среднее значение условий, которые могут наступить.  
Yukarıdaki tablo meydana gelebilecek koşulların ortalama değerini göstermektedir.



# 5 Capacity tables

## 5 - 2 Heating Capacity Tables

5

RQYQ40PY1		TC: Total Capacity: kW ; PI: Power Input: kW (compressor + outdoor fan motor)													
Combination (%)	Capacity index (kW)	Outdoor air temp.		Indoor air temperature: °CDB											
				16.0		18.0		20.0		21.0		22.0		24.0	
				TC	PI	TC	PI	TC	PI	TC	PI	TC	PI	TC	PI
		°CDB	°CWB												
90%	101,16 kW	-19,8	-20,0	62,4	22,9	62,2	24,2	62,0	25,6	61,9	26,2	61,8	26,9	61,6	28,2
		-18,8	-19,0	64,9	23,9	64,7	25,2	64,5	26,4	64,4	27,1	64,3	27,7	64,1	29,0
		-16,7	-17,0	70,0	25,6	69,8	26,8	69,6	28,0	69,5	28,5	69,4	29,1	69,2	30,3
		-13,7	-15,0	75,1	27,1	74,9	28,2	74,7	29,3	74,6	29,8	74,5	30,4	74,4	31,5
		-11,8	-13,0	80,2	28,4	80,1	29,4	79,9	30,4	79,8	30,9	79,7	31,4	79,5	32,5
		-9,8	-11,0	85,4	29,5	85,2	30,5	85,0	31,4	84,9	31,9	84,8	32,4	84,6	33,3
		-9,5	-10,0	87,9	30,0	87,7	30,9	87,5	31,9	87,4	32,3	87,3	32,8	87,1	33,7
		-8,5	-9,1	90,2	30,4	90,0	31,3	89,8	32,3	89,7	32,7	89,6	33,2	89,4	34,1
		-7,0	-7,6	94,0	31,1	93,8	32,0	93,6	32,9	93,5	33,3	93,4	33,7	93,2	34,6
		-5,0	-5,6	99	31,9	99	32,8	99	33,6	99	34,0	99	34,4	98,0	35,1
		-3,0	-3,7	104	32,6	104	33,4	104	34,2	103	34,6	103	35,0	98,0	33,1
		0,0	-0,7	112	33,6	111	34,4	111	35,1	109	34,3	105	33,0	98,0	30,3
		3,0	2,2	119	34,5	119	35,1	113	33,0	109	31,7	105	30,5	98,0	28,1
		5,0	4,1	124	34,9	120	33,8	113	31,4	109	30,3	105	29,1	98,0	26,8
		7,0	6,0	127	34,6	120	32,3	113	30,0	109	28,9	105	27,8	98,0	25,7
		9,0	7,9	127	33,1	120	30,9	113	28,7	109	27,7	105	26,6	98,0	24,6
		11,0	9,8	127	31,7	120	29,6	113	27,6	109	26,6	105	25,6	98,0	23,6
		13,0	11,8	127	30,4	120	28,4	113	26,4	109	25,5	105	24,5	98,0	22,7
		15,0	13,7	127	29,2	120	27,3	113	25,4	109	24,5	105	23,6	98,0	21,9
		80%	89,92 kW	-19,8	-20,0	62,0	25,5	61,8	26,7	61,6	27,9	61,6	28,5	61,5	29,1
-18,8	-19,0			64,5	26,4	64,4	27,5	64,2	28,6	64,1	29,2	64,0	29,8	63,8	30,9
-16,7	-17,0			69,7	27,9	69,5	28,9	69,3	30,0	69,2	30,5	69,1	31,0	68,9	32,1
-13,7	-15,0			74,8	29,2	74,6	30,2	74,4	31,2	74,3	31,7	74,2	32,1	74,1	33,1
-11,8	-13,0			79,9	30,4	79,7	31,3	79,5	32,2	79,4	32,6	79,3	33,1	79,2	34,0
-9,8	-11,0			85,0	31,4	84,8	32,2	84,6	33,1	84,5	33,5	84,4	33,9	84,3	34,8
-9,5	-10,0			87,5	31,8	87,3	32,6	87,2	33,5	87,1	33,9	87,0	34,3	86,8	35,1
-8,5	-9,1			89,8	32,2	89,6	33,0	89,5	33,8	89,4	34,2	89,3	34,6	89,1	34,2
-7,0	-7,6			93,6	32,8	93,5	33,6	93,3	34,4	93,2	34,7	93,1	35,1	92,9	32,5
-5,0	-5,6			99	33,5	99	34,3	98	35,0	96,8	34,5	93,6	33,2	87,1	30,5
-3,0	-3,7			104	34,2	103	34,9	100	33,8	96,8	32,6	93,6	31,3	87,1	28,8
0,0	-0,7			111	35,0	106	33,4	100	31,0	96,8	29,9	93,6	28,7	87,1	26,5
3,0	2,2			113	33,1	106	30,9	100	28,7	96,8	27,7	93,6	26,6	87,1	24,6
5,0	4,1			113	31,6	106	29,5	100	27,4	96,8	26,4	93,6	25,4	87,1	23,5
7,0	6,0			113	30,1	106	28,2	100	26,2	96,8	25,3	93,6	24,4	87,1	22,5
9,0	7,9			113	28,8	106	27,0	100	25,1	96,8	24,2	93,6	23,4	87,1	21,6
11,0	9,8			113	27,7	106	25,9	100	24,1	96,8	23,3	93,6	22,4	87,1	20,8
13,0	11,8			113	26,5	106	24,8	100	23,2	96,8	22,4	93,6	21,6	87,1	20,0
15,0	13,7			113	25,5	106	23,9	100	22,3	96,8	21,6	93,6	20,8	87,1	19,3
70%	78,68 kW			-19,8	-20,0	61,6	28,1	61,5	29,1	61,3	30,2	61,2	30,7	61,1	31,2
		-18,8	-19,0	64,2	28,9	64,0	29,8	63,9	30,8	63,8	31,3	63,7	31,8	63,5	32,8
		-16,7	-17,0	69,3	30,2	69,1	31,1	69,0	32,0	68,9	32,5	68,8	33,0	68,6	33,9
		-13,7	-15,0	74,4	31,4	74,2	32,2	74,1	33,1	74,0	33,5	73,9	33,9	73,8	34,8
		-11,8	-13,0	79,5	32,4	79,3	33,2	79,2	33,9	79,1	34,3	79,0	34,7	78,9	35,7
		-9,8	-11,0	84,6	33,2	84,4	34,0	84,3	34,7	84,2	35,1	84,1	35,4	84,0	36,3
		-9,5	-10,0	87,1	33,6	87,0	34,4	86,8	35,1	86,7	35,4	86,6	35,7	86,5	36,6
		-8,5	-9,1	89,4	34,0	89,3	34,7	89,2	35,4	89,1	35,7	89,0	36,0	88,9	36,9
		-7,0	-7,6	93,3	34,5	93,1	35,2	92,9	35,9	92,8	36,2	92,7	36,5	92,6	37,4
		-5,0	-5,6	98	35,1	97,8	35,8	97,6	36,5	97,5	36,8	97,4	37,1	97,3	38,0
		-3,0	-3,7	99	33,3	93,1	31,1	87,5	28,9	84,7	27,9	81,9	26,8	79,3	24,7
		0,0	-0,7	99	30,6	93,1	28,6	87,5	26,6	84,7	25,6	81,9	24,7	79,3	22,8
		3,0	2,2	99	28,3	93,1	26,5	87,5	24,7	84,7	23,8	81,9	23,0	79,3	21,3
		5,0	4,1	99	27,0	93,1	25,3	87,5	23,6	84,7	22,8	81,9	22,0	79,3	20,3
		7,0	6,0	99	25,9	93,1	24,2	87,5	22,6	84,7	21,8	81,9	21,1	79,3	19,5
		9,0	7,9	99	24,8	93,1	23,2	87,5	21,7	84,7	21,0	81,9	20,2	79,3	18,8
		11,0	9,8	99	23,8	93,1	22,3	87,5	20,9	84,7	20,2	81,9	19,5	79,3	18,1
		13,0	11,8	99	22,9	93,1	21,5	87,5	20,1	84,7	19,4	81,9	18,7	79,3	17,4
		15,0	13,7	99	22,0	93,1	20,7	87,5	19,4	84,7	18,7	81,9	18,1	79,3	16,8
		60%	67,44 kW	-19,8	-20,0	61,2	30,7	61,1	31,6	61,0	32,5	60,9	32,9	60,8	33,4
-18,8	-19,0			63,8	31,3	63,6	32,2	63,5	33,0	63,4	33,5	63,4	33,9	63,2	34,7
-16,7	-17,0			68,9	32,5	68,7	33,3	68,6	34,1	68,5	34,5	68,5	34,9	68,4	35,3
-13,7	-15,0			74,0	33,5	73,9	34,2	73,7	35,0	73,6	35,4	73,5	35,8	73,4	36,2
-11,8	-13,0			79,1	34,4	79,0	35,0	78,9	35,7	78,8	36,1	78,7	36,5	78,6	36,9
-9,8	-11,0			84,2	35,1	84,1	35,8	84,0	36,5	83,9	36,9	83,8	37,3	83,7	37,7
-9,5	-10,0			86,6	34,1	86,5	34,8	86,4	35,5	86,3	36,2	86,2	36,9	86,1	37,6
-8,5	-9,1			89,0	33,0	88,9	33,7	88,8	34,4	88,7	35,1	88,6	35,8	88,5	36,5
-7,0	-7,6			93,4	31,4	93,3	30,8	93,2	30,1	93,1	29,4	93,0	28,7	92,9	28,0
-5,0	-5,6			98,6	29,5	98,5	28,8	98,4	28,1	98,3	27,4	98,2	26,7	98,1	26,0
-3,0	-3,7			104,6	27,8	104,5	27,1	104,4	26,4	104,3	25,7	104,2	25,0	104,1	24,3
0,0	-0,7			111,6	25,6	111,5	24,9	111,4	24,2	111,3	23,5	111,2	22,8	111,1	22,1
3,0	2,2			118,6	23,8	118,5	23,1	118,4	22,4	118,3	21,7	118,2	21,0	118,1	20,3
5,0	4,1			125,6	22,8	125,5	22,1	125,4	21,4	125,3	20,7	125,2	20,0	125,1	19,3
7,0	6,0			132,6	21,8	132,5	21,1	132,4	20,4	132,3	19,7	132,2	19,0	132,1	18,3
9,0	7,9			139,6	20,9	139,5	20,2	139,4	19,5	139,3	18,8	139,2	18,1	139,1	17,4
11,0	9,8			146,6	20,2	146,5	19,5	146,4	18,8	146,3	18,1	146,2	17,4	146,1	16,7
13,0	11,8			153,6	19,4	153,5	18,7	153,4	18,0	153,3	17,3	153,2	16,6	153,1	15,9
15,0	13,7			160,6	18,7	160,5	18,0	160,4	17,3	160,3	16,6	160,2	15,9	160,1	15,2
50%	56,20 kW			-19,8	-20,0	60,8	33,3	60,7	34,0	60,6	34,8	60,5	35,1	60,4	35,8
		-18,8	-19,0	63,4	33,8	63,3	34,5	63,2	35,3	63,1	35,6	63,0	36,3	62,9	37,0
		-16,7	-17,0	68,5	34,8	68,4	35,5	68,3	36,2	68,2	36,5	68,1	37,2	68,0	37,9
		-13,7	-15,0	73,6	36,4	73,5	37,1	73,4	37,8	73,3	38,1	73,2	38,8	73,1	39,5
		-11,8	-13,0	78,7	37,8	78,6	38,5	78,5	39,2	78,4	39,5	78,3	40,2	78,2	40,9
		-9,8	-11,0	83,8	39,2	83,7	40,0	83,6	40,7	83,5	41,0	83,4	41,7	83,3	42,4
		-9,5	-10,0	86,4	38,1	86,3	38,8	86,2	39,5	86,1	40,2	86,0	40,9	85,9	41,6
		-8,5	-9,1	89,0	37,0	88,9	37,7	88,8	38,4	88,7	39,1	88,6	39,8	88,5	40,5
		-7,0	-7,6	93,4	35,4	93,3	36,1	93,2	36,8	93,1	37,5	93,0	38,2	92,9	38,9
		-5,0	-5,6	98,8	33,8	98,7	34,5	98,6	35,2	98,5	36,6	98,4	37,9	98,3	38,6
		-3,0	-3,7	104,2	32,2	104,1	32,9	104,0	33,6	103,9	34,9	103,8	36,2	103,7	36,9
		0,0	-0,7	110,2	30,6	110,1	31,3	110,0	32,0	109,9	33,3	109,8	34,6	109,7	35,



# 5 Capacity tables

## 5 - 2 Heating Capacity Tables

RQYQ42PY1		TC: Total Capacity: kW ; PI: Power Input: kW (compressor + outdoor fan motor)													
Combination (%)	Capacity index (kW)	Outdoor air temp.		Indoor air temperature: °CDB											
				16.0		18.0		20.0		21.0		22.0		24.0	
				TC	PI	TC	PI	TC	PI	TC	PI	TC	PI	TC	PI
130	151,32 kW	-19,8	-20,0	63,0	11,0	62,7	13,2	62,4	15,4	62,3	16,6	62,1	17,7	61,8	19,94
		-18,8	-19,0	66,0	12,9	65,7	15,0	65,4	17,1	65,2	18,2	65,1	19,3	64,8	21,41
		-16,7	-17,0	71,8	16,2	71,5	18,1	71,2	20,1	71,1	21,1	70,9	22,0	70,6	23,98
		-13,7	-15,0	77,7	19,0	77,4	20,8	77,1	22,6	77,0	23,5	76,8	24,3	76,5	26,1
		-11,8	-13,0	83,7	21,4	83,4	23,0	83,1	24,7	82,9	25,5	82,8	26,3	82,5	28,0
		-9,8	-11,0	89,6	23,4	89,3	25,0	89,0	26,5	88,9	27,3	88,7	28,0	88,4	29,6
		-9,5	-10,0	92,6	24,4	92,3	25,8	92,0	27,3	91,9	28,1	91,7	28,8	91,4	30,3
		-8,5	-9,1	95,3	25,1	95,0	26,6	94,7	28,0	94,6	28,7	94,4	29,5	94,1	30,9
		-7,0	-7,6	100	26,4	100	27,7	99	29,1	99	29,8	99	30,5	99	31,8
		-5,0	-5,6	106	27,8	106	29,1	105	30,4	105	31,0	105	31,7	105	33,0
		-3,0	-3,7	112	29,0	111	30,3	111	31,5	111	32,1	111	32,7	111	33,9
		0,0	-0,7	121	30,8	120	31,9	120	33,0	120	33,6	120	34,1	120	35,3
		3,0	2,2	130	32,2	129	33,2	129	34,3	129	34,8	129	35,3	129	36,4
		5,0	4,1	136	33,0	135	34,0	135	35,0	135	35,5	135	36,0	134	37,0
		7,0	6,0	141	33,8	141	34,7	141	35,7	141	36,2	141	36,6	140	37,6
		9,0	7,9	147	34,5	147	35,4	147	36,3	147	36,8	146	37,2	146	38,1
		11,0	9,8	153	35,1	153	36,0	153	36,9	153	37,3	152	37,8	150	37,6
13,0	11,8	160	35,8	159	36,6	159	37,5	159	37,9	159	38,3	150	35,8		
15,0	13,7	166	36,3	165	37,2	165	38,0	165	38,4	161	37,3	150	34,2		
120	139,68 kW	-19,8	-20,0	62,6	14,0	62,3	16,1	62,1	18,1	61,9	19,2	61,8	20,2	61,5	22,3
		-18,8	-19,0	65,6	15,7	65,3	17,7	65,0	19,7	64,9	20,7	64,7	21,7	64,4	23,6
		-16,7	-17,0	71,4	18,8	71,2	20,6	70,9	22,4	70,7	23,3	70,6	24,2	70,3	26,0
		-13,7	-15,0	77,3	21,4	77,1	23,0	76,8	24,7	76,6	25,5	76,5	26,4	76,2	28,0
		-11,8	-13,0	83,3	23,6	83,0	25,1	82,7	26,7	82,6	27,4	82,4	28,2	82,2	29,7
		-9,8	-11,0	89,2	25,5	89,0	26,9	88,7	28,3	88,5	29,1	88,4	29,8	88,1	31,2
		-9,5	-10,0	92,2	26,4	92,0	27,7	91,7	29,1	91,5	29,8	91,4	30,5	91,1	31,8
		-8,5	-9,1	94,9	27,1	94,6	28,4	94,4	29,7	94,2	30,4	94,1	31,1	93,8	32,4
		-7,0	-7,6	99	28,2	99	29,5	99	30,7	99	31,4	99	32,0	98	33,3
		-5,0	-5,6	105	29,6	105	30,7	105	31,9	105	32,5	105	33,1	104	34,3
		-3,0	-3,7	111	30,7	111	31,8	111	32,9	111	33,5	110	34,1	110	35,2
		0,0	-0,7	120	32,3	120	33,3	120	34,3	120	34,9	120	35,4	119	36,4
		3,0	2,2	129	33,6	129	34,6	129	35,5	129	36,0	128	36,5	128	37,4
		5,0	4,1	135	34,4	135	35,3	135	36,2	134	36,7	134	37,1	134	38,0
		7,0	6,0	141	35,1	141	36,0	141	36,8	140	37,3	140	37,7	138	37,8
		9,0	7,9	147	35,7	147	36,6	146	37,4	146	37,8	146	38,3	138	35,9
		11,0	9,8	153	36,3	153	37,1	152	37,9	152	38,4	148	37,2	138	34,2
13,0	11,8	159	36,9	159	37,7	158	38,4	153	36,9	148	35,4	138	32,6		
15,0	13,7	165	37,4	165	38,2	158	36,7	153	35,3	148	33,9	138	31,2		
110	128,04 kW	-19,8	-20,0	62,2	17,0	62,0	18,9	61,7	20,8	61,6	21,8	61,4	22,7	61,2	24,6
		-18,8	-19,0	65,1	18,6	64,9	20,4	64,6	22,3	64,5	23,2	64,4	24,1	64,1	25,9
		-16,7	-17,0	71,0	21,4	70,8	23,1	70,5	24,7	70,4	25,6	70,3	26,4	70,0	28,0
		-13,7	-15,0	76,9	23,8	76,7	25,3	76,4	26,8	76,3	27,6	76,2	28,4	75,9	29,9
		-11,8	-13,0	82,9	25,8	82,6	27,2	82,4	28,6	82,2	29,3	82,1	30,0	81,8	31,4
		-9,8	-11,0	88,8	27,6	88,6	28,9	88,3	30,2	88,2	30,8	88,1	31,5	87,8	32,8
		-9,5	-10,0	91,8	28,4	91,6	29,6	91,3	30,9	91,2	31,5	91,1	32,1	90,8	33,4
		-8,5	-9,1	94,5	29,0	94,3	30,3	94,0	31,5	93,9	32,1	93,8	32,7	93,5	33,9
		-7,0	-7,6	99	30,1	99	31,2	99	32,4	98	33,0	98	33,5	98	34,7
		-5,0	-5,6	105	31,3	105	32,4	105	33,5	104	34,0	104	34,6	104	35,7
		-3,0	-3,7	111	32,3	111	33,4	110	34,4	110	34,9	110	35,4	110	36,5
		0,0	-0,7	120	33,8	120	34,7	119	35,7	119	36,2	119	36,7	119	37,6
		3,0	2,2	129	35,0	129	35,9	128	36,8	128	37,2	128	37,7	127	37,9
		5,0	4,1	135	35,7	135	36,6	134	37,4	134	37,8	134	38,2	127	35,9
		7,0	6,0	141	36,4	140	37,2	140	38,0	140	38,4	136	37,1	127	34,0
		9,0	7,9	147	37,0	146	37,7	145	38,2	141	36,7	136	35,2	127	32,4
		11,0	9,8	153	37,5	152	38,3	145	36,3	141	34,9	136	33,6	127	30,9
13,0	11,8	159	38,1	155	37,2	145	34,6	141	33,3	136	32,0	127	29,5		
15,0	13,7	164	38,2	155	35,6	145	33,1	141	31,8	136	30,6	127	28,2		
100	116,40 kW	-19,8	-20,0	61,8	20,1	61,6	21,8	61,3	23,5	61,2	24,4	61,1	25,2	60,9	27,0
		-18,8	-19,0	64,7	21,5	64,5	23,2	64,3	24,8	64,2	25,6	64,0	26,5	63,8	28,1
		-16,7	-17,0	70,6	24,1	70,4	25,6	70,2	27,1	70,0	27,8	69,9	28,6	69,7	30,1
		-13,7	-15,0	76,5	26,2	76,3	27,6	76,1	29,0	75,9	29,7	75,8	30,4	75,6	31,7
		-11,8	-13,0	82,5	28,1	82,2	29,3	82,0	30,6	81,9	31,3	81,8	31,9	81,5	33,2
		-9,8	-11,0	88,4	29,7	88,2	30,8	88,0	32,0	87,8	32,6	87,7	33,2	87,5	34,4
		-9,5	-10,0	91,4	30,4	91,2	31,5	90,9	32,7	90,8	33,2	90,7	33,8	90,5	34,9
		-8,5	-9,1	94,1	31,0	93,9	32,1	93,6	33,2	93,5	33,8	93,4	34,3	93,2	35,4
		-7,0	-7,6	99	31,9	98	33,0	98	34,0	98	34,6	97,9	35,1	97,7	36,1
		-5,0	-5,6	105	33,0	104	34,0	104	35,0	104	35,5	104	36,0	104	37,0
		-3,0	-3,7	110	34,0	110	34,9	110	35,9	110	36,3	110	36,8	109	37,7
		0,0	-0,7	120	35,3	119	36,2	119	37,0	119	37,5	119	37,9	115	36,9
		3,0	2,2	128	36,4	128	37,2	128	38,0	128	38,4	124	36,8	115	33,8
		5,0	4,1	134	37,1	134	37,8	132	37,7	128	36,3	124	34,9	115	32,1
		7,0	6,0	140	37,6	140	38,4	132	35,8	128	34,4	124	33,1	115	30,5
		9,0	7,9	146	38,2	140	36,7	132	34,0	128	32,8	124	31,5	115	29,0
		11,0	9,8	149	37,5	140	34,9	132	32,4	128	31,2	124	30,0	115	27,7
13,0	11,8	149	35,6	140	33,3	132	30,9	128	29,8	124	28,7	115	26,4		
15,0	13,7	149	34,1	140	31,8	132	29,6	128	28,5	124	27,4	115	25,3		

**NOTES - ANMERKUNGEN - Σημειώσεις - NOTAS - REMARQUES - NOTE - OPMERKINGEN - Примечания - NOTLAR**

- is shown as reference. When selecting the unit models, avoid the Outdoor air temperature range shown by
- dient als Verweis. Vermeiden Sie bei der Auswahl der Gerätemodelle den als markierten Temperaturbereich der Außenluft
- Η είναι ενδεικτική, κατά την επιλογή των μοντέλων των μονάδων, αποφύγετε το εύρος θερμοκρασίας εξωτερικού αέρα που υποδεικνύεται
- se muestra como referencia. Cuando seleccione los modelos de unidad, evite el intervalo de temperaturas del aire exterior indicado mediante
- est montré comme référence. Lors du choix des modèles d'unités, évitez la plage de températures de l'air extérieur illustré par
- valori riportati unicamente come riferimento. Nel selezionare i modelli delle unità, non considerare i valori di temperatura dell'aria esterna indicati con il colore
- is als referentie getoond. Wanneer modellen van eenheden worden gekozen, vermijd dan het bereik van buitenluchttemperaturen geïllustreerd door
- показан как. При выборе модели устройства избегайте внешнюю температуру

воздуха, указанную в  
referans olarak gösterilmektedir. Ünite modellerini seçerken, belirtilen Dış hava sıcaklığı aralığından kaçının

The above table shows the average value of conditions which may occur.  
Die obige Tabelle zeigt den Durchschnittswert der Bedingungen, die auftreten können.  
Στον παραπάνω πίνακα αναγράφεται η μέση τιμή για συνθήκες που μπορεί να προκύψουν.  
La tabla de arriba muestra el valor medio de condiciones que pueden ocurrir.  
Le tableau ci-dessus donne la valeur moyenne pour des conditions qui peuvent survenir.  
La tabella in alto mostra il valore delle condizioni medie che si possono riscontrare.  
De tabel hierboven geeft de gemiddelde waarde aan van situaties die kunnen voorvallen.  
Таблица расположенная выше показывает среднее значение условий, которые могут наступить.  
Yukarıdaki tablo meydana gelebilecek koşulların ortalama değerini göstermektedir.

# 5 Capacity tables

## 5 - 2 Heating Capacity Tables

5

RQYQ42PY1		TC: Total Capacity: kW ; PI: Power Input: kW (compressor + outdoor fan motor)													
Combination (%)	Capacity index (kW)	Outdoor air temp.		Indoor air temperature: °CDB											
				16.0		18.0		20.0		21.0		22.0		24.0	
				TC	PI	TC	PI	TC	PI	TC	PI	TC	PI	TC	PI
		°CDB	°CWB												
90%	104,76 kW	-19,8	-20,0	61,4	23,1	61,2	24,6	61,0	26,2	60,9	27,0	60,8	27,8	60,6	29,3
		-18,8	-19,0	64,3	24,4	64,1	25,9	63,9	27,4	63,8	28,1	63,7	28,8	63,5	30,3
		-16,7	-17,0	70,2	26,7	70,0	28,1	69,8	29,4	69,7	30,1	69,6	30,8	69,4	32,1
		-13,7	-15,0	76,1	28,7	75,9	29,9	75,7	31,1	75,6	31,8	75,5	32,4	75,3	33,6
		-11,8	-13,0	82,1	30,3	81,8	31,5	81,6	32,6	81,5	33,2	81,4	33,7	81,2	34,9
		-9,8	-11,0	88,0	31,7	87,8	32,8	87,6	33,9	87,5	34,4	87,4	34,9	87,2	36,0
		-9,5	-10,0	91,0	32,4	90,8	33,4	90,6	34,4	90,5	35,0	90,4	35,5	90,2	36,5
		-8,5	-9,1	93,7	32,9	93,5	33,9	93,3	34,9	93,2	35,4	93,1	35,9	92,9	36,9
		-7,0	-7,6	98	33,8	98	34,7	97,8	35,7	97,7	36,1	97,6	36,6	97,4	37,6
		-5,0	-5,6	104	34,8	104	35,7	104	36,6	104	37,0	104	37,5	103	38,4
		-3,0	-3,7	110	35,6	110	36,5	110	37,3	109	37,8	109	38,2	104	35,9
		0,0	-0,7	119	36,8	119	37,6	119	38,4	115	36,9	111	35,5	104	32,6
		3,0	2,2	128	37,8	126	37,9	119	35,1	115	33,8	111	32,5	104	29,9
		5,0	4,1	134	38,4	126	35,8	119	33,3	115	32,0	111	30,8	104	28,4
		7,0	6,0	134	36,5	126	34,0	119	31,6	115	30,4	111	29,3	104	27,0
		9,0	7,9	134	34,7	126	32,4	119	30,1	115	29,0	111	27,9	104	25,8
		11,0	9,8	134	33,0	126	30,9	119	28,7	115	27,7	111	26,7	104	24,6
		13,0	11,8	134	31,5	126	29,4	119	27,4	115	26,4	111	25,5	104	23,5
		15,0	13,7	134	30,1	126	28,2	119	26,3	115	25,3	111	24,4	104	22,6
		80%	93,12 kW	-19,8	-20,0	61,0	26,1	60,8	27,5	60,6	28,9	60,5	29,6	60,4	30,3
-18,8	-19,0			63,9	27,3	63,7	28,6	63,5	29,9	63,5	30,6	63,4	31,2	63,2	32,6
-16,7	-17,0			69,8	29,3	69,6	30,5	69,4	31,7	69,3	32,3	69,2	32,9	69,1	34,1
-13,7	-15,0			75,7	31,1	75,5	32,2	75,3	33,3	75,2	33,8	75,2	34,4	75,0	35,5
-11,8	-13,0			81,6	32,5	81,5	33,6	81,3	34,6	81,2	35,1	81,1	35,6	80,9	36,6
-9,8	-11,0			87,6	33,8	87,4	34,8	87,2	35,7	87,1	36,2	87,0	36,7	86,9	37,6
-9,5	-10,0			90,6	34,4	90,4	35,3	90,2	36,2	90,1	36,7	90,0	37,1	89,9	38,0
-8,5	-9,1			93,3	34,9	93,1	35,8	92,9	36,7	92,8	37,1	92,7	37,5	92,0	38,1
-7,0	-7,6			97,8	35,6	97,6	36,5	97,4	37,3	97,3	37,7	97,3	38,2	92,0	35,9
-5,0	-5,6			104	36,5	104	37,3	103	38,1	102	37,8	98,8	36,3	92,0	33,4
-3,0	-3,7			110	37,3	109	38,0	106	36,8	102	35,4	98,8	34,0	92,0	31,3
0,0	-0,7			119	38,4	112	35,9	106	33,4	102	32,1	98,8	30,9	92,0	28,5
3,0	2,2			119	35,3	112	32,9	106	30,6	102	29,5	98,8	28,4	92,0	26,2
5,0	4,1			119	33,4	112	31,2	106	29,0	102	28,0	98,8	26,9	92,0	24,9
7,0	6,0			119	31,7	112	29,7	106	27,6	102	26,6	98,8	25,6	92,0	23,7
9,0	7,9			119	30,2	112	28,3	106	26,3	102	25,4	98,8	24,5	92,0	22,6
11,0	9,8			119	28,8	112	27,0	106	25,2	102	24,3	98,8	23,4	92,0	21,7
13,0	11,8			119	27,5	112	25,8	106	24,1	102	23,2	98,8	22,4	92,0	20,8
15,0	13,7			119	26,4	112	24,7	106	23,1	102	22,3	98,8	21,5	92,0	19,9
70%	81,48 kW			-19,8	-20,0	60,6	29,2	60,4	30,4	60,3	31,6	60,2	32,2	60,1	32,8
		-18,8	-19,0	63,5	30,2	63,4	31,3	63,2	32,5	63,1	33,1	63,0	33,6	62,9	34,8
		-16,7	-17,0	69,4	32,0	69,2	33,0	69,1	34,1	69,0	34,6	68,9	35,1	68,7	36,2
		-13,7	-15,0	75,3	33,5	75,1	34,5	75,0	35,4	74,9	35,9	74,8	36,4	74,6	37,3
		-11,8	-13,0	81,2	34,8	81,1	35,7	80,9	36,6	80,8	37,0	80,7	37,5	80,5	38,3
		-9,8	-11,0	87,2	35,9	87,0	36,7	86,9	37,6	86,8	38,0	86,5	38,2	86,5	35,1
		-9,5	-10,0	90,2	36,4	90,0	37,2	89,9	38,0	89,4	38,2	86,5	36,6	80,5	33,7
		-8,5	-9,1	92,9	36,8	92,7	37,6	92,4	38,3	89,4	36,8	86,5	35,3	80,5	32,5
		-7,0	-7,6	97,4	37,5	97,2	38,2	92,4	36,1	89,4	34,7	86,5	33,4	80,5	30,7
		-5,0	-5,6	103	38,3	98,3	36,1	92,4	33,5	89,4	32,3	86,5	31,0	80,5	28,6
		-3,0	-3,7	104	36,2	98,3	33,8	92,4	31,4	89,4	30,3	86,5	29,1	80,5	26,9
		0,0	-0,7	104	32,9	98,3	30,7	92,4	28,6	89,4	27,5	86,5	26,5	80,5	24,5
		3,0	2,2	104	30,2	98,3	28,2	92,4	26,3	89,4	25,4	86,5	24,4	80,5	22,6
		5,0	4,1	104	28,6	98,3	26,8	92,4	25,0	89,4	24,1	86,5	23,2	80,5	21,5
		7,0	6,0	104	27,2	98,3	25,5	92,4	23,8	89,4	23,0	86,5	22,2	80,5	20,6
		9,0	7,9	104	26,0	98,3	24,3	92,4	22,7	89,4	22,0	86,5	21,2	80,5	19,7
		11,0	9,8	104	24,8	98,3	23,3	92,4	21,8	89,4	21,0	86,5	20,3	80,5	18,9
		13,0	11,8	104	23,7	98,3	22,3	92,4	20,8	89,4	20,1	86,5	19,4	80,5	18,1
		15,0	13,7	104	22,8	98,3	21,4	92,4	20,0	89,4	19,4	86,5	18,7	80,5	17,4
		60%	69,84 kW	-19,8	-20,0	60,2	32,2	60,0	33,2	59,9	34,3	59,8	34,8	59,8	35,3
-18,8	-19,0			63,1	33,1	63,0	34,1	62,8	35,0	62,8	35,5	62,7	36,0	62,5	37,0
-16,7	-17,0			69,0	34,6	68,8	35,5	68,7	36,4	68,6	36,9	68,6	37,3	68,4	38,2
-13,7	-15,0			74,9	35,9	74,8	36,7	74,6	37,6	74,5	38,0	74,1	38,1	69,0	35,0
-11,8	-13,0			80,8	37,0	80,7	37,8	79,2	37,5	76,7	36,1	74,1	34,7	69,0	31,9
-9,8	-11,0			86,8	38,0	84,3	37,1	79,2	34,4	76,7	33,1	74,1	31,8	69,0	29,3
-9,5	-10,0			89,4	38,1	84,3	35,5	79,2	33,0	76,7	31,8	74,1	30,6	69,0	28,2
-8,5	-9,1			89,4	36,8	84,3	34,3	79,2	31,9	76,7	30,7	74,1	29,5	69,0	27,2
-7,0	-7,6			89,4	34,7	84,3	32,4	79,2	30,1	76,7	29,0	74,1	27,9	69,0	25,8
-5,0	-5,6			89,4	32,3	84,3	30,1	79,2	28,1	76,7	27,0	74,1	26,0	69,0	24,1
-3,0	-3,7			89,4	30,2	84,3	28,3	79,2	26,4	76,7	25,4	74,1	24,5	69,0	22,7
0,0	-0,7			89,4	27,5	84,3	25,8	79,2	24,1	76,7	23,2	74,1	22,4	69,0	20,8
3,0	2,2			89,4	25,3	84,3	23,8	79,2	22,2	76,7	21,5	74,1	20,7	69,0	19,2
5,0	4,1			89,4	24,1	84,3	22,6	79,2	21,2	76,7	20,4	74,1	19,7	69,0	18,3
7,0	6,0			89,4	23,0	84,3	21,6	79,2	20,2	76,7	19,5	74,1	18,9	69,0	17,5
9,0	7,9			89,4	22,0	84,3	20,6	79,2	19,3	76,7	18,7	74,1	18,1	69,0	16,8
11,0	9,8			89,4	21,0	84,3	19,8	79,2	18,5	76,7	17,9	74,1	17,3	69,0	16,2
13,0	11,8			89,4	20,1	84,3	18,9	79,2	17,8	76,7	17,2	74,1	16,6	69,0	15,5
15,0	13,7			89,4	19,3	84,3	18,2	79,2	17,1	76,7	16,6	74,1	16,0	69,0	15,0
50%	58,20 kW			-19,8	-20,0	59,8	35,2	59,7	36,1	59,5	36,9	59,5	37,4	59,4	37,8
		-18,8	-19,0	62,7	36,0	62,6	36,8	62,5	37,6	62,4	38,0	61,8	37,9	57,5	34,8
		-16,7	-17,0	68,6	37,2	68,5	38,0	66,0	36,7	63,9	35,3	61,8	33,9	57,5	31,2
		-13,7	-15,0	74,5	38,3	70,2	35,7	66,0	33,2	63,9	31,9	61,8	30,7	57,5	28,3
		-11,8	-13,0	74,5	34,9	70,2	32,5	66,0	30,3	63,9	29,2	61,8	28,1	57,5	25,9
		-9,8	-11,0	74,5	32,0	70,2	29,9	66,0	27,8	63,9	26,8	61,8	25,8	57,5	23,9
		-9,5	-10,0	74,5	30,7	70,2	28,7	66,0	26,8	63,9	25,8	61,8	24,9	57,5	23,0
		-8,5	-9,1	74,5	29,7	70,2	27,8	66,0	25,9	63,9	25,0	61,8	24,1	57,5	22,3
		-7,0	-7,6	74,5	28,1	70,2	26,3	66,0	24,5	63,9	23,7	61,8	22,8	57,5	21,1
		-5,0	-5,6	74,5	26,2	70,2	24,5	66,0	22,9	63,9	22,1	61,8	21,4	57,5	19,8
		-3,0	-3,7	74,5	24,6	70,2	23,1	66,0	21,6	63,9	20,9	61,8	20,1	57,5	18,7
		0,0	-0,7	74,5	22,5	70,2	21,2	66,0	19,8	63,9	19,2	61,8	18,5	57,5	17,2
		3,0	2,2	74,5	20,8	70,2	19,6	66,0							

# 5 Capacity tables

## 5 - 2 Heating Capacity Tables

**RQYQ44PY1**

TC: Total Capacity: kW ; PI: Power Input: kW (compressor + outdoor fan motor)

Combination (%)	Capacity index (kW)	Outdoor air temp.		Indoor air temperature: °CDB													
				16.0		18.0		20.0		21.0		22.0		24.0			
				TC	PI	TC	PI	TC	PI	TC	PI	TC	PI	TC	PI		
		°CDB	°CWB	kW	kW	kW	kW	kW	kW	kW	kW	kW	kW	kW	kW	kW	
130	156,52 kW	-19,8	-20,0	57,5	4,1	57,2	6,6	56,9	9,1	56,7	10,3	56,5	11,6	56,2	14,1	56,2	14,1
		-18,8	-19,0	60,6	6,5	60,2	8,9	59,9	11,2	59,8	12,4	59,6	13,6	59,3	16,0	59,3	16,0
		-16,7	-17,0	66,7	10,7	66,4	12,8	66,1	15,0	65,9	16,0	65,8	17,1	65,5	19,2	65,5	19,2
		-13,7	-15,0	73,0	14,2	72,6	16,1	72,3	18,0	72,2	19,0	72,0	19,9	71,7	21,9	71,7	21,9
		-11,8	-13,0	79,2	17,0	78,9	18,8	78,6	20,6	78,4	21,5	78,3	22,3	78,0	24,1	78,0	24,1
		-9,8	-11,0	85,6	19,5	85,2	21,1	84,9	22,8	84,8	23,6	84,6	24,4	84,3	26,0	84,3	26,0
		-9,5	-10,0	89	20,6	88	22,2	88	23,7	88	24,5	87,8	25,3	87,5	26,9	87,5	26,9
		-8,5	-9,1	92	21,5	91	23,0	91	24,6	91	25,3	91	26,1	90	27,6	90	27,6
		-7,0	-7,6	96	22,9	96	24,4	96	25,8	96	26,5	95	27,2	95	28,7	95	28,7
		-5,0	-5,6	103	24,6	103	26,0	102	27,3	102	28,0	102	28,6	102	30,0	102	30,0
		-3,0	-3,7	109	26,0	109	27,3	108	28,6	108	29,2	108	29,8	108	31,1	108	31,1
		0,0	-0,7	119	28,0	119	29,1	118	30,3	118	30,8	118	31,4	118	32,6	118	32,6
		3,0	2,2	129	29,6	128	30,6	128	31,7	128	32,2	128	32,7	127	33,8	127	33,8
		5,0	4,1	135	30,5	135	31,5	134	32,5	134	33,0	134	33,5	134	34,5	134	34,5
		7,0	6,0	142	31,3	141	32,3	141	33,3	141	33,7	141	34,2	140	35,2	140	35,2
		9,0	7,9	148	32,1	148	33,0	147	34,0	147	34,4	147	34,9	147	35,8	147	35,8
		11,0	9,8	155	32,8	154	33,7	154	34,6	154	35,0	154	35,5	153	36,3	153	36,3
13,0	11,8	161	33,5	161	34,4	161	35,2	161	35,6	161	36,0	156	35,5	156	35,5		
15,0	13,7	168	34,1	168	34,9	167	35,7	167	36,1	167	36,5	156	33,8	156	33,8		
120	144,48 kW	-19,8	-20,0	57,1	7,4	56,8	9,8	56,5	12,1	56,3	13,2	56,2	14,4	55,9	16,7	55,9	16,7
		-18,8	-19,0	60,1	9,7	59,8	11,9	59,5	14,1	59,4	15,2	59,3	16,3	59,0	18,4	59,0	18,4
		-16,7	-17,0	66,3	13,6	66,0	15,5	65,7	17,5	65,6	18,5	65,4	19,5	65,1	21,4	65,1	21,4
		-13,7	-15,0	72,5	16,8	72,2	18,5	71,9	20,3	71,8	21,2	71,6	22,1	71,4	23,9	71,4	23,9
		-11,8	-13,0	78,8	19,4	78,5	21,1	78,2	22,7	78,1	23,5	77,9	24,3	77,6	26,0	77,6	26,0
		-9,8	-11,0	85,1	21,7	84,8	23,2	84,5	24,7	84,4	25,5	84,3	26,2	84,0	27,7	84,0	27,7
		-9,5	-10,0	88	22,7	88	24,2	87,7	25,6	87,6	26,3	87,4	27,1	87,1	28,5	87,1	28,5
		-8,5	-9,1	91	23,6	91	25,0	91	26,4	91	27,1	90	27,8	90	29,2	90	29,2
		-7,0	-7,6	96	24,9	96	26,2	95	27,5	95	28,2	95	28,8	95	30,2	95	30,2
		-5,0	-5,6	102	26,4	102	27,7	102	28,9	102	29,5	102	30,1	101	31,4	101	31,4
		-3,0	-3,7	109	27,7	108	28,9	108	30,1	108	30,6	108	31,2	108	32,4	108	32,4
		0,0	-0,7	119	29,5	118	30,6	118	31,6	118	32,2	118	32,7	117	33,8	117	33,8
		3,0	2,2	128	31,0	128	32,0	128	33,0	128	33,4	127	33,9	127	34,9	127	34,9
		5,0	4,1	135	31,9	134	32,8	134	33,7	134	34,2	134	34,6	133	35,6	133	35,6
		7,0	6,0	141	32,6	141	33,5	141	34,4	140	34,9	140	35,3	140	36,2	140	36,2
		9,0	7,9	148	33,4	147	34,2	147	35,0	147	35,5	147	35,9	144	35,9	144	35,9
		11,0	9,8	154	34,0	154	34,8	154	35,6	153	36,0	153	36,4	144	34,1	144	34,1
13,0	11,8	161	34,7	161	35,4	160	36,2	160	36,6	155	35,1	144	32,3	144	32,3		
15,0	13,7	168	35,2	167	36,0	166	36,2	160	34,8	155	33,4	144	30,8	144	30,8		
110	132,44 kW	-19,8	-20,0	56,6	10,8	56,4	12,9	56,1	15,1	56,0	16,1	55,8	17,2	55,6	19,3	55,6	19,3
		-18,8	-19,0	59,7	12,9	59,4	14,9	59,2	16,9	59,0	17,9	58,9	18,9	58,6	20,9	58,6	20,9
		-16,7	-17,0	65,9	16,4	65,6	18,2	65,3	20,0	65,2	20,9	65,1	21,8	64,8	23,6	64,8	23,6
		-13,7	-15,0	72,1	19,4	71,8	21,0	71,6	22,6	71,4	23,5	71,3	24,3	71,0	25,9	71,0	25,9
		-11,8	-13,0	78,4	21,8	78,1	23,3	77,8	24,8	77,7	25,6	77,6	26,3	77,3	27,8	77,3	27,8
		-9,8	-11,0	84,7	23,9	84,4	25,3	84,2	26,7	84,0	27,4	83,9	28,0	83,6	29,4	83,6	29,4
		-9,5	-10,0	87,9	24,8	87,6	26,2	87,4	27,5	87,2	28,1	87,1	28,8	86,8	30,1	86,8	30,1
		-8,5	-9,1	91	25,6	90	26,9	90	28,2	90	28,8	90	29,5	90	30,7	90	30,7
		-7,0	-7,6	96	26,8	95	28,0	95	29,2	95	29,8	95	30,5	95	31,7	95	31,7
		-5,0	-5,6	102	28,2	102	29,4	102	30,5	101	31,1	101	31,6	101	32,8	101	32,8
		-3,0	-3,7	108	29,4	108	30,5	108	31,6	108	32,1	107	32,6	107	33,7	107	33,7
		0,0	-0,7	118	31,1	118	32,1	118	33,0	117	33,5	117	34,0	117	35,0	117	35,0
		3,0	2,2	128	32,4	128	33,3	127	34,2	127	34,7	127	35,1	127	36,0	127	36,0
		5,0	4,1	134	33,2	134	34,1	134	34,9	134	35,3	133	35,8	132	36,3	132	36,3
		7,0	6,0	141	33,9	140	34,7	140	35,6	140	36,0	140	36,4	132	34,2	132	34,2
		9,0	7,9	147	34,6	147	35,4	147	36,1	146	36,5	142	35,3	132	32,4	132	32,4
		11,0	9,8	154	35,2	153	35,9	152	36,2	147	34,8	142	33,4	132	30,8	132	30,8
13,0	11,8	161	35,8	160	36,5	152	34,3	147	33,0	142	31,7	132	29,2	132	29,2		
15,0	13,7	167	36,3	162	35,1	152	32,6	147	31,4	142	30,2	132	27,9	132	27,9		
100	120,40 kW	-19,8	-20,0	56,2	14,2	56,0	16,1	55,7	18,1	55,6	19,0	55,5	20,0	55,2	21,9	55,2	21,9
		-18,8	-19,0	59,3	16,1	59,0	17,9	58,8	19,7	58,7	20,6	58,6	21,6	58,3	23,4	58,3	23,4
		-16,7	-17,0	65,4	19,3	65,2	21,0	65,0	22,6	64,8	23,4	64,7	24,2	64,5	25,9	64,5	25,9
		-13,7	-15,0	71,7	22,0	71,4	23,5	71,2	25,0	71,1	25,7	70,9	26,4	70,7	27,9	70,7	27,9
		-11,8	-13,0	77,9	24,2	77,7	25,6	77,5	26,9	77,3	27,6	77,2	28,3	77,0	29,6	77,0	29,6
		-9,8	-11,0	84,3	26,1	84,0	27,4	83,8	28,6	83,7	29,2	83,5	29,9	83,3	31,1	83,3	31,1
		-9,5	-10,0	87,5	27,0	87,2	28,2	87,0	29,4	86,9	30,0	86,7	30,6	86,5	31,8	86,5	31,8
		-8,5	-9,1	90	27,7	90	28,8	90	30,0	90	30,6	90	31,2	89	32,3	89	32,3
		-7,0	-7,6	95	28,8	95	29,9	95	31,0	95	31,5	94	32,1	94	33,2	94	33,2
		-5,0	-5,6	102	30,0	101	31,1	101	32,1	101	32,6	101	33,1	101	34,2	101	34,2
		-3,0	-3,7	108	31,1	108	32,1	107	33,1	107	33,6	107	34,0	107	35,0	107	35,0
		0,0	-0,7	118	32,6	117	33,5	117	34,4	117	34,8	117	35,3	117	36,2	117	36,2
		3,0	2,2	127	33,9	127	34,7	127	35,5	127	35,9	127	36,3	120	34,4	120	34,4
		5,0	4,1	134	34,6	134	35,4	133	36,1	133	36,5	129	35,2	120	32,4	120	32,4
		7,0	6,0	140	35,2	140	36,0	138	36,0	134	34,6	129	33,3	120	30,6	120	30,6
		9,0	7,9	147	35,8	146	36,5	138	3								

# 5 Capacity tables

## 5 - 2 Heating Capacity Tables

5

RQYQ44PY1

TC: Total Capacity: kW ; PI: Power Input: kW (compressor + outdoor fan motor)

Combination (%)	Capacity index (kW)	Outdoor air temp.		Indoor air temperature: °CDB											
				16.0		18.0		20.0		21.0		22.0		24.0	
				TC	PI	TC	PI	TC	PI	TC	PI	TC	PI	TC	PI
90%	108,36 kW	-19,8	-20,0	55,8	17,6	55,6	19,3	55,4	21,1	55,2	21,9	55,1	22,8	54,9	24,5
		-18,8	-19,0	58,9	19,3	58,6	20,9	58,4	22,6	58,3	23,4	58,2	24,2	58,0	25,8
		-16,7	-17,0	65,0	22,2	64,8	23,7	64,6	25,1	64,5	25,9	64,4	26,6	64,1	28,1
		-13,7	-15,0	71,2	24,6	71,0	25,9	70,8	27,3	70,7	27,9	70,6	28,6	70,4	29,9
		-11,8	-13,0	77,5	26,6	77,3	27,8	77,1	29,0	77,0	29,7	76,9	30,3	76,6	31,5
		-9,8	-11,0	83,9	28,3	83,6	29,4	83,4	30,6	83,3	31,1	83,2	31,7	83,0	32,8
		-9,5	-10,0	87,0	29,1	86,8	30,2	86,6	31,2	86,5	31,8	86,4	32,3	86,2	33,4
		-8,5	-9,1	90	29,7	90	30,8	89	31,8	89	32,3	89	32,9	89	33,9
		-7,0	-7,6	95	30,7	95	31,7	94	32,7	94	33,2	94	33,7	94	34,7
		-5,0	-5,6	101	31,9	101	32,8	101	33,7	101	34,2	101	34,6	100	35,6
		-3,0	-3,7	107	32,8	107	33,7	107	34,6	107	35,0	107	35,5	107	36,3
		0,0	-0,7	117	34,2	117	35,0	117	35,8	117	36,2	116	36,4	108	33,4
		3,0	2,2	127	35,3	127	36,0	124	35,7	120	34,4	116	33,0	108	30,4
		5,0	4,1	133	35,9	132	36,2	124	33,6	120	32,4	116	31,1	108	28,7
		7,0	6,0	140	36,5	132	34,2	124	31,8	120	30,6	116	29,4	108	27,2
		9,0	7,9	140	34,7	132	32,4	124	30,1	120	29,0	116	27,9	108	25,8
		11,0	9,8	140	32,9	132	30,7	124	28,6	120	27,6	116	26,6	108	24,5
		13,0	11,8	140	31,2	132	29,2	124	27,2	120	26,2	116	25,3	108	23,4
		15,0	13,7	140	29,8	132	27,8	124	26,0	120	25,0	116	24,1	108	22,3
		80%	96,32 kW	-19,8	-20,0	55,4	21,0	55,2	22,5	55,0	24,1	54,9	24,8	54,8	25,6
-18,8	-19,0			58,4	22,5	58,2	23,9	58,0	25,4	57,9	26,1	57,8	26,9	57,6	28,3
-16,7	-17,0			64,6	25,1	64,4	26,4	64,2	27,7	64,1	28,3	64,0	29,0	63,8	30,3
-13,7	-15,0			70,8	27,2	70,6	28,4	70,4	29,6	70,3	30,2	70,2	30,8	70,0	32,0
-11,8	-13,0			77,1	29,0	76,9	30,1	76,7	31,2	76,6	31,7	76,5	32,3	76,3	33,3
-9,8	-11,0			83,4	30,5	83,2	31,5	83,0	32,5	82,9	33,0	82,8	33,5	82,6	34,5
-9,5	-10,0			86,6	31,2	86,4	32,1	86,2	33,1	86,1	33,6	86,0	34,1	85,8	35,0
-8,5	-9,1			89	31,8	89	32,7	89	33,6	89	34,1	89	34,5	88,7	35,5
-7,0	-7,6			94	32,6	94	33,5	94	34,4	94	34,8	94	35,3	93,5	36,2
-5,0	-5,6			101	33,7	101	34,5	100	35,3	100	35,7	100	36,1	96,2	34,8
-3,0	-3,7			107	34,5	107	35,3	107	36,1	106	36,5	103	35,2	96,2	32,4
0,0	-0,7			117	35,7	117	36,4	110	34,2	107	32,9	103	31,6	96,2	29,2
3,0	2,2			125	35,9	117	33,4	110	31,1	107	29,9	103	28,8	96,2	26,6
5,0	4,1			125	33,8	117	31,5	110	29,3	107	28,3	103	27,2	96,2	25,1
7,0	6,0			125	31,9	117	29,8	110	27,8	107	26,8	103	25,8	96,2	23,8
9,0	7,9			125	30,2	117	28,3	110	26,4	107	25,4	103	24,5	96,2	22,7
11,0	9,8			125	28,7	117	26,9	110	25,1	107	24,2	103	23,3	96,2	21,6
13,0	11,8			125	27,3	117	25,6	110	23,9	107	23,0	103	22,2	96,2	20,6
15,0	13,7			125	26,1	117	24,4	110	22,8	107	22,0	103	21,3	96,2	19,7
70%	84,28 kW			-19,8	-20,0	54,9	24,4	54,8	25,7	54,6	27,1	54,5	27,7	54,4	28,4
		-18,8	-19,0	58,0	25,7	57,8	27,0	57,7	28,2	57,6	28,9	57,5	29,5	57,3	30,8
		-16,7	-17,0	64,2	27,9	64,0	29,1	63,8	30,2	63,7	30,8	63,7	31,4	63,5	32,5
		-13,7	-15,0	70,4	29,8	70,2	30,9	70,1	31,9	70,0	32,4	69,9	32,9	69,7	34,0
		-11,8	-13,0	76,7	31,4	76,5	32,3	76,3	33,3	76,2	33,8	76,2	34,2	76,0	35,2
		-9,8	-11,0	83,0	32,7	82,8	33,6	82,7	34,5	82,6	34,9	82,5	35,3	82,3	36,2
		-9,5	-10,0	86,2	33,3	86,0	34,1	85,8	35,0	85,8	35,4	85,7	35,8	84,2	35,8
		-8,5	-9,1	89	33,8	89	34,6	88,7	35,4	88,6	35,8	88,5	36,2	84,2	34,4
		-7,0	-7,6	94	34,6	94	35,3	93,5	36,1	93,5	36,5	90,4	35,1	84,2	32,3
		-5,0	-5,6	100	35,5	100	36,2	96,6	35,0	93,5	33,7	90,4	32,4	84,2	29,8
		-3,0	-3,7	107	36,2	103	35,0	96,6	32,5	93,5	31,3	90,4	30,1	84,2	27,8
		0,0	-0,7	109	33,7	103	31,5	96,6	29,3	93,5	28,2	90,4	27,2	84,2	25,1
		3,0	2,2	109	30,6	103	28,7	96,6	26,7	93,5	25,8	90,4	24,8	84,2	23,0
		5,0	4,1	109	28,9	103	27,1	96,6	25,3	93,5	24,4	90,4	23,5	84,2	21,8
		7,0	6,0	109	27,4	103	25,6	96,6	23,9	93,5	23,1	90,4	22,3	84,2	20,7
		9,0	7,9	109	26,0	103	24,4	96,6	22,8	93,5	22,0	90,4	21,2	84,2	19,7
		11,0	9,8	109	24,7	103	23,2	96,6	21,7	93,5	21,0	90,4	20,2	84,2	18,8
		13,0	11,8	109	23,5	103	22,1	96,6	20,7	93,5	20,0	90,4	19,3	84,2	18,0
		15,0	13,7	109	22,5	103	21,2	96,6	19,8	93,5	19,2	90,4	18,5	84,2	17,2
		60%	72,24 kW	-19,8	-20,0	54,5	27,7	54,4	28,9	54,2	30,1	54,1	30,6	54,1	31,2
-18,8	-19,0			57,6	28,9	57,4	30,0	57,3	31,1	57,2	31,6	57,1	32,2	57,0	33,2
-16,7	-17,0			63,7	30,8	63,6	31,8	63,5	32,8	63,4	33,3	63,3	33,8	63,2	34,7
-13,7	-15,0			70,0	32,4	69,8	33,3	69,7	34,2	69,6	34,7	69,5	35,1	69,4	36,0
-11,8	-13,0			76,2	33,8	76,1	34,6	76,0	35,4	75,9	35,8	75,8	36,2	72,2	34,4
-9,8	-11,0			82,6	34,9	82,4	35,7	82,3	36,4	80,1	35,4	77,5	34,0	72,2	31,3
-9,5	-10,0			85,8	35,4	85,6	36,1	82,8	35,1	80,1	33,8	77,5	32,5	72,2	29,9
-8,5	-9,1			88,6	35,8	88,1	36,3	82,8	33,7	80,1	32,4	77,5	31,2	72,2	28,7
-7,0	-7,6			93,4	36,5	88,1	34,0	82,8	31,6	80,1	30,5	77,5	29,3	72,2	27,0
-5,0	-5,6			93,4	33,6	88,1	31,4	82,8	29,2	80,1	28,2	77,5	27,1	72,2	25,0
-3,0	-3,7			93,4	31,3	88,1	29,3	82,8	27,3	80,1	26,3	77,5	25,3	72,2	23,4
0,0	-0,7			93,4	28,2	88,1	26,4	82,8	24,6	80,1	23,8	77,5	22,9	72,2	21,2
3,0	2,2			93,4	25,7	88,1	24,1	82,8	22,6	80,1	21,8	77,5	21,0	72,2	19,5
5,0	4,1			93,4	24,3	88,1	22,8	82,8	21,4	80,1	20,7	77,5	19,9	72,2	18,5
7,0	6,0			93,4	23,1	88,1	21,7	82,8	20,3	80,1	19,6	77,5	19,0	72,2	17,6
9,0	7,9			93,4	22,0	88,1	20,7	82,8	19,4	80,1	18,7	77,5	18,1	72,2	16,8
11,0	9,8			93,4	21,0	88,1	19,7	82,8	18,5	80,1	17,9	77,5	17,3	72,2	16,1
13,0	11,8			93,4	20,0	88,1	18,8	82,8	17,7	80,1	17,1	77,5	16,5	72,2	15,4
15,0	13,7			93,4	19,1	88,1	18,0	82,8	16,9	80,1	16,4	77,5	15,9	72,2	14,8
50%	60,20 kW			-19,8	-20,0	54,1	31,1	54,0	32,1	53,8	33,1	53,8	33,5	53,7	34,0
		-18,8	-19,0	57,1	32,1	57,0	33,0	56,9	33,9	56,8	34,4	56,8	34,8	56,7	35,7
		-16,7	-17,0	63,3	33,7	63,2	34,5	63,1	35,3	63,0	35,7	63,0	36,2	60,1	34,5
		-13,7	-15,0	69,5	35,0	69,4	35,8	69,0	36,3	66,8	34,9	64,6	33,5	60,1	30,9
		-11,8	-13,0	75,8	36,2	73,4	35,1	69,0	32,7	66,8	31,4	64,6	30,2	60,1	27,9
		-9,8	-11,0	77,9	34,2	73,4	31,9	69,0	29,7	66,8	28,6	64,6	27,5	60,1	25,4
		-9,5	-10,0	77,9	32,6	73,4	30,5	69,0	28,4	66,8	27,4	64,6	26,3	60,1	24,4
		-8,5	-9,1	77,9	31,4	73,4	29,3	69,0	27,3	66,8	26,3	64,6	25,4	60,1	23,5
		-7,0	-7,6	77,9	29,5	73,4	27,6	69,0	25,7	66,8	24,8	64,6	23,9	60,1	22,1
		-5,0	-5,6	77,9	27,3	73,4	25,5	69,0	23,8	66,8	23,0	64,6	22,2	60,1	20,6
		-3,0	-3,7	77,9	25,5	73,4	23,9	69,0	22,3	66,8	21,6	64,6	20,8	60,1	19,3
		0,0	-0,7	77,9	23,0	73,4	21,6	69,0	20,3	66,8	19,6	64,6	18,9	60,1	17,6
		3,0	2,2	77,9	21,1	73,4	19,9	69,0	18,6	66,8	18,0	64,6	17,4	60,1	16,2
		5,0	4,1	77,9	20,										



# 5 Capacity tables

## 5 - 2 Heating Capacity Tables

RQYQ46PY1		TC: Total Capacity: kW ; PI: Power Input: kW (compressor + outdoor fan motor)													
Combination (%)	Capacity index (kW)	Outdoor air temp.		Indoor air temperature: °CDB											
				16.0		18.0		20.0		21.0		22.0		24.0	
				TC	PI	TC	PI	TC	PI	TC	PI	TC	PI	TC	PI
130	163,80 kW	-19,8	-20,0	71,0	13,7	70,7	16,1	70,3	18,6	70,2	19,8	70,0	21,1	69,7	23,5
		-18,8	-19,0	74,2	15,7	73,8	18,0	73,5	20,4	73,3	21,6	73,2	22,7	72,9	25,1
		-16,7	-17,0	80,6	19,2	80,3	21,4	79,9	23,5	79,8	24,6	79,6	25,7	79,3	27,8
		-13,7	-15,0	87,1	22,2	86,7	24,2	86,4	26,2	86,2	27,2	86,1	28,2	85,7	30,1
		-11,8	-13,0	93,6	24,8	93,3	26,6	92,9	28,5	92,8	29,4	92,6	30,3	92,3	32,1
		-9,8	-11,0	100	27,1	100	28,8	100	30,5	99	31,3	99	32,2	99	33,9
		-9,5	-10,0	104	28,1	103	29,7	103	31,4	103	32,2	103	33,0	102	34,6
		-8,5	-9,1	107	28,9	106	30,5	106	32,1	106	32,9	106	33,7	105	35,3
		-7,0	-7,6	112	30,3	111	31,8	111	33,3	111	34,1	111	34,8	110	36,3
		-5,0	-5,6	118	31,9	118	33,3	118	34,7	117	35,4	117	36,2	117	37,6
		-3,0	-3,7	125	33,2	124	34,6	124	35,9	124	36,6	124	37,3	123	38,6
		0,0	-0,7	135	35,1	135	36,4	134	37,6	134	38,2	134	38,9	134	40,1
		3,0	2,2	145	36,7	145	37,9	144	39,0	144	39,6	144	40,2	144	41,3
		5,0	4,1	152	37,7	151	38,8	151	39,9	151	40,4	151	41,0	150	42,1
		7,0	6,0	159	38,5	158	39,6	158	40,6	158	41,2	158	41,7	157	42,7
		9,0	7,9	165	39,3	165	40,3	165	41,3	164	41,8	164	42,3	164	43,3
		11,0	9,8	172	40,1	172	41,0	171	42,0	171	42,5	171	43,0	171	43,3
13,0	11,8	179	40,8	179	41,7	179	42,6	179	43,1	176	42,8	176	39,3		
15,0	13,7	186	41,4	186	42,3	186	43,2	182	42,5	176	40,8	164	37,5		
120	151,20 kW	-19,8	-20,0	70,5	17,0	70,2	19,3	69,9	21,5	69,8	22,7	69,6	23,8	69,3	26,1
		-18,8	-19,0	73,7	18,9	73,4	21,0	73,1	23,2	73,0	24,3	72,8	25,3	72,5	27,5
		-16,7	-17,0	80,1	22,1	79,8	24,1	79,5	26,1	79,4	27,1	79,2	28,1	78,9	30,0
		-13,7	-15,0	86,6	24,9	86,3	26,7	86,0	28,5	85,9	29,4	85,7	30,4	85,4	32,2
		-11,8	-13,0	93,2	27,3	92,9	29,0	92,5	30,7	92,4	31,5	92,2	32,3	91,9	34,0
		-9,8	-11,0	100	29,4	99	30,9	99	32,5	99	33,3	99	34,1	99	35,6
		-9,5	-10,0	103	30,3	103	31,8	102	33,3	102	34,1	102	34,8	102	36,3
		-8,5	-9,1	106	31,1	106	32,6	105	34,0	105	34,8	105	35,5	105	37,0
		-7,0	-7,6	111	32,3	111	33,7	110	35,1	110	35,8	110	36,5	110	37,9
		-5,0	-5,6	118	33,8	118	35,1	117	36,4	117	37,1	117	37,7	117	39,1
		-3,0	-3,7	124	35,1	124	36,3	124	37,6	124	38,2	123	38,8	123	40,0
		0,0	-0,7	135	36,8	134	38,0	134	39,1	134	39,7	134	40,3	133	41,4
		3,0	2,2	145	38,3	144	39,4	144	40,4	144	41,0	144	41,5	143	42,5
		5,0	4,1	151	39,2	151	40,2	151	41,2	151	41,7	150	42,2	150	43,2
		7,0	6,0	158	39,9	158	40,9	157	41,9	157	42,4	157	42,9	157	41,6
		9,0	7,9	165	40,7	165	41,6	164	42,5	164	43,0	163	43,0	163	39,5
		11,0	9,8	172	41,4	171	42,3	171	43,1	168	42,6	163	40,9	152	37,6
13,0	11,8	179	42,0	179	42,9	174	42,1	168	40,5	163	38,9	152	35,7		
15,0	13,7	186	42,6	185	43,3	174	40,2	168	38,6	163	37,1	152	34,1		
110	138,60 kW	-19,8	-20,0	70,1	20,3	69,8	22,4	69,5	24,5	69,4	25,5	69,3	26,6	69,0	28,6
		-18,8	-19,0	73,3	22,0	73,0	24,0	72,7	26,0	72,6	27,0	72,4	28,0	72,2	30,0
		-16,7	-17,0	79,7	25,0	79,4	26,8	79,1	28,6	79,0	29,5	78,9	30,5	78,6	32,3
		-13,7	-15,0	86,2	27,6	85,9	29,2	85,6	30,9	85,5	31,7	85,3	32,6	85,1	34,2
		-11,8	-13,0	92,7	29,7	92,4	31,3	92,1	32,8	92,0	33,6	91,9	34,4	91,6	35,9
		-9,8	-11,0	99	31,7	99	33,1	99	34,5	99	35,2	98	36,0	98	37,4
		-9,5	-10,0	103	32,5	102	33,9	102	35,3	102	36,0	102	36,7	101	38,1
		-8,5	-9,1	106	33,2	105	34,6	105	35,9	105	36,6	105	37,3	104	38,6
		-7,0	-7,6	111	34,4	110	35,7	110	36,9	110	37,6	110	38,2	110	39,5
		-5,0	-5,6	117	35,7	117	36,9	117	38,1	117	38,7	117	39,3	116	40,6
		-3,0	-3,7	124	36,9	124	38,0	123	39,2	123	39,7	123	40,3	123	41,5
		0,0	-0,7	134	38,5	134	39,5	134	40,6	133	41,1	133	41,6	133	42,7
		3,0	2,2	144	39,8	144	40,8	144	41,8	144	42,3	143	42,8	139	41,8
		5,0	4,1	151	40,6	151	41,6	150	42,5	150	43,0	149	43,1	139	39,5
		7,0	6,0	158	41,4	157	42,3	157	43,1	154	42,5	149	40,8	139	37,5
		9,0	7,9	164	42,0	164	42,9	160	41,9	154	40,3	149	38,7	139	35,6
		11,0	9,8	171	42,7	170	43,0	160	39,9	154	38,4	149	36,9	139	33,9
13,0	11,8	178	43,3	170	40,9	160	37,9	154	36,5	149	35,1	139	32,3		
15,0	13,7	180	41,8	170	39,0	160	36,2	154	34,9	149	33,5	139	30,9		
100	126,00 kW	-19,8	-20,0	69,6	23,6	69,4	25,5	69,1	27,4	69,0	28,4	68,9	29,3	68,6	31,2
		-18,8	-19,0	72,8	25,2	72,6	27,0	72,3	28,8	72,2	29,7	72,1	30,6	71,8	32,4
		-16,7	-17,0	79,3	27,9	79,0	29,6	78,7	31,2	78,6	32,0	78,5	32,9	78,2	34,5
		-13,7	-15,0	85,7	30,2	85,5	31,7	85,2	33,3	85,1	34,0	85,0	34,8	84,7	36,3
		-11,8	-13,0	92,3	32,2	92,0	33,6	91,8	35,0	91,6	35,7	91,5	36,4	91,2	37,8
		-9,8	-11,0	99	33,9	99	35,2	98	36,6	98	37,2	98	37,9	98	39,2
		-9,5	-10,0	102	34,7	102	36,0	102	37,2	102	37,9	101	38,5	101	39,8
		-8,5	-9,1	105	35,4	105	36,6	105	37,8	105	38,4	104	39,1	104	40,3
		-7,0	-7,6	110	36,4	110	37,6	110	38,7	110	39,3	109	39,9	109	41,1
		-5,0	-5,6	117	37,7	117	38,7	116	39,8	116	40,4	116	40,9	116	42,0
		-3,0	-3,7	123	38,7	123	39,7	123	40,8	123	41,3	123	41,8	122	42,9
		0,0	-0,7	134	40,2	133	41,1	133	42,1	133	42,6	133	43,0	126	40,8
		3,0	2,2	144	41,4	144	42,3	143	43,2	140	42,3	136	40,6	126	37,3
		5,0	4,1	150	42,1	150	43,0	145	41,6	140	40,1	136	38,4	126	35,3
		7,0	6,0	157	42,8	154	42,5	145	39,4	140	37,9	136	36,4	126	33,5
		9,0	7,9	164	43,3	154	40,3	145	37,4	140	36,0	136	34,6	126	31,9
		11,0	9,8	164	41,1	154	38,3	145	35,6	140	34,3	136	33,0	126	30,4
13,0	11,8	164	39,1	154	36,5	145	33,9	140	32,7	136	31,4	126	29,0		
15,0	13,7	164	37,3	154	34,8	145	32,4	140	31,2	136	30,1	126	27,8		

**NOTES - ANMERKUNGEN - Σημειώσεις - NOTAS - REMARQUES - NOTE - OPMERKINGEN - Примечания - NOTLAR**

- is shown as reference. When selecting the unit models, avoid the Outdoor air temperature range shown by
- dient als Verweis. Vermeiden Sie bei der Auswahl der Gerätemodelle den als markierten Temperaturbereich der Außenluft
- Η είναι ενδεικτική, κατά την επιλογή των μοντέλων των μονάδων, αποφύγετε το εύρος θερμοκρασίας εξωτερικού αέρα που υποδεικνύεται
- se muestra como referencia. Cuando seleccione los modelos de unidad, evite el intervalo de temperaturas del aire exterior indicado mediante
- est montré comme référence. Lors du choix des modèles d'unités, évitez la plage de températures de l'air extérieur illustré par
- valori riportati unicamente come riferimento. Nel selezionare i modelli delle unità, non considerare i valori di temperatura dell'aria esterna indicati con il colore
- is als referentie getoond. Wanneer modellen van eenheden worden gekozen, vermijd dan het bereik van buitenluchttemperaturen geïllustreerd door
- показан как. При выборе модели устройства избегайте внешнюю температуру

воздуха, указанную в  
referans olarak gösterilmektedir. Ünite modellerini seçerken, belirtilen Dış hava sıcaklığı aralığından kaçınm

The above table shows the average value of conditions which may occur.  
Die obige Tabelle zeigt den Durchschnittswert der Bedingungen, die auftreten können.  
Στον παραπάνω πίνακα αναγράφεται η μέση τιμή για συνθήκες που μπορεί να προκύψουν.  
La tabla de arriba muestra el valor medio de condiciones que pueden ocurrir.  
Le tableau ci-dessus donne la valeur moyenne pour des conditions qui peuvent survenir.  
La tabella in alto mostra il valore delle condizioni medie che si possono riscontrare.  
De tabel hierboven geeft de gemiddelde waarde aan van situaties die kunnen voorvallen.  
Таблица расположенная выше показывает среднее значение условий, которые могут наступить.  
Yukarıdaki tablo meydana gelebilecek koşulların ortalama değerini göstermektedir.



# 5 Capacity tables

## 5 - 2 Heating Capacity Tables

5

RQYQ46PY1		TC: Total Capacity: kW ; PI: Power Input: kW (compressor + outdoor fan motor)													
Combination (%)	Capacity index (kW)	Outdoor air temp.		Indoor air temperature: °CDB											
				16.0		18.0		20.0		21.0		22.0		24.0	
				TC	PI	TC	PI	TC	PI	TC	PI	TC	PI	TC	PI
		°CDB	°CWB												
90%	113,40 kW	-19,8	-20,0	69,2	27,0	69,0	28,7	68,7	30,4	68,6	31,2	68,5	32,1	68,3	33,8
		-18,8	-19,0	72,4	28,4	72,2	30,0	71,9	31,6	71,8	32,4	71,7	33,2	71,5	34,8
		-16,7	-17,0	78,8	30,8	78,6	32,3	78,3	33,8	78,2	34,5	78,1	35,2	77,9	36,7
		-13,7	-15,0	85,3	32,9	85,1	34,3	84,8	35,6	84,7	36,3	84,6	37,0	84,4	38,3
		-11,8	-13,0	91,8	34,7	91,6	35,9	91,4	37,2	91,2	37,8	91,1	38,5	90,9	39,7
		-9,8	-11,0	98	36,2	98	37,4	98	38,6	98	39,2	98	39,8	97	40,9
		-9,5	-10,0	102	36,9	101	38,1	101	39,2	101	39,8	101	40,3	101	41,5
		-8,5	-9,1	105	37,5	104	38,6	104	39,7	104	40,3	104	40,8	104	41,9
		-7,0	-7,6	110	38,5	110	39,5	109	40,6	109	41,1	109	41,6	109	42,7
		-5,0	-5,6	116	39,6	116	40,6	116	41,6	116	42,0	116	42,5	114	42,4
		-3,0	-3,7	123	40,5	123	41,5	122	42,4	122	42,9	122	43,3	114	39,7
		0,0	-0,7	133	41,9	133	42,7	131	42,4	126	40,8	122	39,1	114	36,0
		3,0	2,2	143	43,0	139	41,8	131	38,7	126	37,3	122	35,8	114	33,0
		5,0	4,1	147	42,4	139	39,5	131	36,7	126	35,3	122	33,9	114	31,3
		7,0	6,0	147	40,1	139	37,4	131	34,8	126	33,5	122	32,2	114	29,7
		9,0	7,9	147	38,1	139	35,6	131	33,1	126	31,9	122	30,7	114	28,3
		11,0	9,8	147	36,3	139	33,9	131	31,6	126	30,4	122	29,3	114	27,1
		13,0	11,8	147	34,5	139	32,3	131	30,1	126	29,0	122	27,9	114	25,8
		15,0	13,7	147	33,0	139	30,9	131	28,8	126	27,8	122	26,8	114	24,8
		80%	100,80 kW	-19,8	-20,0	68,8	30,3	68,5	31,8	68,3	33,3	68,2	34,1	68,1	34,8
-18,8	-19,0			71,9	31,5	71,7	33,0	71,5	34,4	71,4	35,1	71,3	35,8	71,1	37,3
-16,7	-17,0			78,4	33,7	78,2	35,0	77,9	36,3	77,8	37,0	77,7	37,6	77,5	39,0
-13,7	-15,0			84,8	35,5	84,6	36,8	84,4	38,0	84,3	38,6	84,2	39,2	84,0	40,4
-11,8	-13,0			91,4	37,1	91,2	38,3	91,0	39,4	90,9	39,9	90,8	40,5	90,5	41,6
-9,8	-11,0			98	38,5	98	39,6	98	40,6	97	41,1	97	41,7	97	42,7
-9,5	-10,0			101	39,2	101	40,2	101	41,2	101	41,7	101	42,2	100	43,2
-8,5	-9,1			104	39,7	104	40,7	104	41,6	104	42,1	104	42,6	101	42,1
-7,0	-7,6			109	40,5	109	41,4	109	42,4	109	42,8	109	43,2	101	39,7
-5,0	-5,6			116	41,5	116	42,4	116	43,3	112	41,8	109	40,1	101	36,9
-3,0	-3,7			122	42,4	122	43,2	116	40,6	112	39,1	109	37,5	101	34,5
0,0	-0,7			131	42,6	123	39,7	116	36,8	112	35,4	109	34,1	101	31,4
3,0	2,2			131	38,9	123	36,3	116	33,7	112	32,5	109	31,3	101	28,9
5,0	4,1			131	36,8	123	34,4	116	32,0	112	30,8	109	29,7	101	27,4
7,0	6,0			131	34,9	123	32,6	116	30,4	112	29,3	109	28,2	101	26,1
9,0	7,9			131	33,2	123	31,1	116	29,0	112	27,9	109	26,9	101	24,9
11,0	9,8			131	31,7	123	29,6	116	27,6	112	26,7	109	25,7	101	23,8
13,0	11,8			131	30,2	123	28,3	116	26,4	112	25,5	109	24,6	101	22,8
15,0	13,7			131	28,9	123	27,1	116	25,3	112	24,4	109	23,6	101	21,9
70%	88,20 kW			-19,8	-20,0	68,3	33,6	68,1	34,9	67,9	36,2	67,9	36,9	67,8	37,6
		-18,8	-19,0	71,5	34,7	71,3	35,9	71,1	37,2	71,0	37,8	71,0	38,5	70,8	39,7
		-16,7	-17,0	77,9	36,6	77,7	37,7	77,6	38,9	77,5	39,5	77,4	40,0	77,2	41,2
		-13,7	-15,0	84,4	38,2	84,2	39,3	84,0	40,3	83,9	40,9	83,8	41,4	83,7	42,5
		-11,8	-13,0	90,9	39,6	90,7	40,6	90,6	41,6	90,5	42,1	90,4	42,6	88,5	42,2
		-9,8	-11,0	98	40,8	97	41,7	97	42,6	97,1	43,1	95,0	42,2	88,5	38,7
		-9,5	-10,0	101	41,4	101	42,3	100	43,1	98,2	42,1	95,0	40,4	88,5	37,2
		-8,5	-9,1	104	41,8	104	42,7	102	42,3	98,2	40,6	95,0	39,0	88,5	35,9
		-7,0	-7,6	109	42,6	108	43,0	102	39,9	98,2	38,3	95,0	36,8	88,5	33,9
		-5,0	-5,6	115	42,8	108	39,9	102	37,0	98,2	35,6	95,0	34,3	88,5	31,6
		-3,0	-3,7	115	40,0	108	37,3	102	34,7	98,2	33,4	95,0	32,1	88,5	29,7
		0,0	-0,7	115	36,3	108	33,9	102	31,5	98,2	30,4	95,0	29,3	88,5	27,0
		3,0	2,2	115	33,3	108	31,1	102	29,0	98,2	28,0	95,0	26,9	88,5	24,9
		5,0	4,1	115	31,5	108	29,5	102	27,5	98,2	26,6	95,0	25,6	88,5	23,7
		7,0	6,0	115	30,0	108	28,1	102	26,2	98,2	25,3	95,0	24,4	88,5	22,6
		9,0	7,9	115	28,6	108	26,8	102	25,0	98,2	24,2	95,0	23,3	88,5	21,6
		11,0	9,8	115	27,3	108	25,6	102	23,9	98,2	23,1	95,0	22,3	88,5	20,7
		13,0	11,8	115	26,0	108	24,4	102	22,9	98,2	22,1	95,0	21,3	88,5	19,8
		15,0	13,7	115	25,0	108	23,4	102	22,0	98,2	21,2	95,0	20,5	88,5	19,1
		60%	75,60 kW	-19,8	-20,0	67,9	36,9	67,7	38,0	67,5	39,2	67,5	39,7	67,4	40,3
-18,8	-19,0			71,0	37,8	70,9	38,9	70,7	40,0	70,7	40,5	70,6	41,1	70,4	42,2
-16,7	-17,0			77,5	39,5	77,3	40,5	77,2	41,5	77,1	41,9	77,0	42,4	75,8	42,5
-13,7	-15,0			83,9	40,9	83,8	41,8	83,6	42,7	83,6	43,1	81,4	41,9	75,8	38,5
-11,8	-13,0			90,5	42,1	90,3	42,9	90,2	43,8	90,1	44,2	88,2	43,2	75,8	35,1
-9,8	-11,0			97,1	43,1	92,6	40,9	87,0	38,0	84,2	36,5	81,4	35,1	75,8	32,3
-9,5	-10,0			98,2	42,1	92,6	39,2	87,0	36,4	84,2	35,1	81,4	33,7	75,8	31,1
-8,5	-9,1			98,2	40,6	92,6	37,9	87,0	35,2	84,2	33,9	81,4	32,6	75,8	30,0
-7,0	-7,6			98,2	38,3	92,6	35,8	87,0	33,3	84,2	32,0	81,4	30,8	75,8	28,5
-5,0	-5,6			98,2	35,6	92,6	33,3	87,0	31,0	84,2	29,9	81,4	28,8	75,8	26,6
-3,0	-3,7			98,2	33,4	92,6	31,2	87,0	29,1	84,2	28,1	81,4	27,0	75,8	25,0
0,0	-0,7			98,2	30,4	92,6	28,4	87,0	26,6	84,2	25,6	81,4	24,7	75,8	22,9
3,0	2,2			98,2	27,9	92,6	26,2	87,0	24,5	84,2	23,7	81,4	22,8	75,8	21,2
5,0	4,1			98,2	26,5	92,6	24,9	87,0	23,3	84,2	22,5	81,4	21,7	75,8	20,2
7,0	6,0			98,2	25,3	92,6	23,7	87,0	22,2	84,2	21,5	81,4	20,8	75,8	19,3
9,0	7,9			98,2	24,1	92,6	22,7	87,0	21,3	84,2	20,6	81,4	19,9	75,8	18,5
11,0	9,8			98,2	23,1	92,6	21,7	87,0	20,4	84,2	19,7	81,4	19,0	75,8	17,7
13,0	11,8			98,2	22,1	92,6	20,8	87,0	19,5	84,2	18,9	81,4	18,3	75,8	17,0
15,0	13,7			98,2	21,2	92,6	20,0	87,0	18,8	84,2	18,2	81,4	17,6	75,8	16,4
50%	63,00 kW			-19,8	-20,0	67,4	40,2	67,3	41,2	67,2	42,1	67,1	42,6	67,0	43,1
		-18,8	-19,0	70,6	41,0	70,5	41,9	70,3	42,8	70,2	43,2	67,8	41,4	63,2	38,0
		-16,7	-17,0	77,0	42,4	76,9	43,2	72,5	40,3	70,2	38,7	67,8	37,2	63,2	34,2
		-13,7	-15,0	81,8	42,2	77,2	39,3	72,5	36,5	70,2	35,1	67,8	33,8	63,2	31,1
		-11,8	-13,0	81,8	38,4	77,2	35,9	72,5	33,4	70,2	32,1	67,8	30,9	63,2	28,5
		-9,8	-11,0	81,8	35,3	77,2	33,0	72,5	30,7	70,2	29,6	67,8	28,5	63,2	26,4
		-9,5	-10,0	81,8	33,9	77,2	31,7	72,5	29,6	70,2	28,5	67,8	27,4	63,2	25,4
		-8,5	-9,1	81,8	32,8	77,2	30,6	72,5	28,6	70,2	27,6	67,8	26,6	63,2	24,6
		-7,0	-7,6	81,8	31,0	77,2	29,0	72,5	27,1	70,2	26,1	67,8	25,2	63,2	23,3
		-5,0	-5,6	81,8	28,9	77,2	27,1	72,5	25,3	70,2	24,4	67,8	23,6	63,2	21,9
		-3,0	-3,7	81,8	27,2	77,2	25,5	72,5	23,9	70,2	23,0	67,8	22,2	63,2	20,7
		0,0	-0,7	81,8	24,8	77,2	23,3	72,5	21,9	70,2	21,1	67,8	20,4	63,2	19,0
		3,0	2,2	81,8	22,9	77,2	21,6	72,5	20,2	70,2	19,6	67,8	18,9	63,2	17,6
		5,0	4,1	81,8	21,9	77									

# 5 Capacity tables

## 5 - 2 Heating Capacity Tables

### RQYQ48PY1

TC: Total Capacity: kW ; PI: Power Input: kW (compressor + outdoor fan motor)

Combination (%)	Capacity index (kW)	Outdoor air temp.		Indoor air temperature: °CDB											
				16.0		18.0		20.0		21.0		22.0		24.0	
				TC	PI	TC	PI	TC	PI	TC	PI	TC	PI	TC	PI
130	170,95 kW	-19,8	-20,0	67,7	9,9	67,3	12,6	67,0	15,4	66,8	16,8	66,6	18,2	66,3	20,9
		-18,8	-19,0	71,1	12,4	70,7	15,0	70,4	17,7	70,2	19,0	70,1	20,3	69,7	22,9
		-16,7	-17,0	78,0	16,9	77,7	19,2	77,3	21,6	77,2	22,8	77,0	24,0	76,6	26,3
		-13,7	-15,0	85,0	20,5	84,7	22,7	84,3	24,9	84,1	25,9	84,0	27,0	83,6	29,2
		-11,8	-13,0	92,1	23,7	91,7	25,6	91,4	27,6	91,2	28,6	91,0	29,6	90,7	31,6
		-9,8	-11,0	99	26,3	99	28,2	99	30,0	98	30,9	98	31,8	98	33,7
		-9,5	-10,0	103	27,5	102	29,3	102	31,1	102	31,9	102	32,8	101	34,6
		-8,5	-9,1	106	28,5	106	30,2	105	32,0	105	32,8	105	33,7	105	35,4
		-7,0	-7,6	112	30,1	111	31,7	111	33,3	111	34,1	111	34,9	110	36,6
		-5,0	-5,6	119	32,0	119	33,5	118	35,0	118	35,7	118	36,5	118	38,0
		-3,0	-3,7	126	33,5	126	34,9	125	36,4	125	37,1	125	37,8	125	39,2
		0,0	-0,7	137	35,7	137	37,0	137	38,3	136	38,9	136	39,6	136	40,9
		3,0	2,2	148	37,5	148	38,7	148	39,9	147	40,5	147	41,1	147	42,3
		5,0	4,1	156	38,5	155	39,7	155	40,8	155	41,4	155	41,9	154	43,1
		7,0	6,0	163	39,5	163	40,6	162	41,6	162	42,2	162	42,7	162	43,8
		9,0	7,9	170	40,3	170	41,4	170	42,4	170	42,9	169	43,5	169	44,5
		11,0	9,8	178	41,2	178	42,1	177	43,1	177	43,6	177	44,1	170	42,5
13,0	11,8	186	41,9	186	42,9	185	43,8	185	44,3	182	43,8	170	40,2		
15,0	13,7	194	42,6	193	43,5	193	44,5	189	43,4	182	41,7	170	38,3		
120	157,80 kW	-19,8	-20,0	67,2	13,6	66,9	16,2	66,6	18,7	66,4	20,0	66,2	21,3	65,9	23,8
		-18,8	-19,0	70,6	16,0	70,3	18,4	70,0	20,8	69,8	22,0	69,7	23,2	69,4	25,6
		-16,7	-17,0	77,5	20,1	77,2	22,2	76,9	24,4	76,8	25,5	76,6	26,6	76,3	28,8
		-13,7	-15,0	84,5	23,5	84,2	25,4	83,9	27,4	83,7	28,4	83,6	29,4	83,3	31,4
		-11,8	-13,0	91,6	26,3	91,3	28,2	91,0	30,0	90,8	30,9	90,7	31,8	90,3	33,6
		-9,8	-11,0	99	28,8	98	30,5	98	32,2	98	33,0	98	33,9	97	35,6
		-9,5	-10,0	102	29,9	102	31,5	102	33,2	102	34,0	101	34,8	101	36,4
		-8,5	-9,1	106	30,8	105	32,4	105	34,0	105	34,8	105	35,6	104	37,1
		-7,0	-7,6	111	32,3	111	33,8	110	35,3	110	36,0	110	36,8	110	38,2
		-5,0	-5,6	118	34,0	118	35,4	118	36,8	118	37,5	117	38,2	117	39,6
		-3,0	-3,7	125	35,4	125	36,8	125	38,1	125	38,7	125	39,4	124	40,7
		0,0	-0,7	137	37,4	136	38,6	136	39,8	136	40,4	136	41,0	135	42,2
		3,0	2,2	148	39,1	147	40,2	147	41,3	147	41,9	147	42,4	147	43,5
		5,0	4,1	155	40,1	155	41,1	155	42,2	154	42,7	154	43,2	154	44,3
		7,0	6,0	163	40,9	162	41,9	162	42,9	162	43,5	162	44,0	157	43,1
		9,0	7,9	170	41,8	170	42,7	169	43,7	169	44,1	168	44,4	157	40,7
		11,0	9,8	178	42,5	177	43,4	177	44,3	174	43,8	168	42,0	157	38,6
13,0	11,8	186	43,2	185	44,1	180	43,1	174	41,5	168	39,8	157	36,6		
15,0	13,7	193	43,9	192	44,2	180	41,0	174	39,5	168	37,9	157	34,9		
110	144,65 kW	-19,8	-20,0	66,7	17,3	66,4	19,7	66,2	22,0	66,0	23,2	65,9	24,3	65,6	26,7
		-18,8	-19,0	70,2	19,5	69,9	21,7	69,6	23,9	69,4	25,0	69,3	26,1	69,0	28,4
		-16,7	-17,0	77,1	23,2	76,8	25,3	76,5	27,3	76,4	28,3	76,2	29,3	75,9	31,3
		-13,7	-15,0	84,1	26,4	83,8	28,2	83,5	30,0	83,4	30,9	83,2	31,8	82,9	33,7
		-11,8	-13,0	91,1	29,0	90,9	30,7	90,6	32,4	90,4	33,2	90,3	34,0	90,0	35,7
		-9,8	-11,0	98	31,3	98	32,8	98	34,4	98	35,1	97	35,9	97	37,5
		-9,5	-10,0	102	32,3	102	33,8	101	35,3	101	36,0	101	36,8	101	38,3
		-8,5	-9,1	105	33,1	105	34,6	105	36,0	104	36,8	104	37,5	104	38,9
		-7,0	-7,6	111	34,5	110	35,8	110	37,2	110	37,9	110	38,6	109	39,9
		-5,0	-5,6	118	36,0	118	37,3	117	38,6	117	39,2	117	39,9	117	41,2
		-3,0	-3,7	125	37,4	125	38,6	124	39,8	124	40,4	124	41,0	124	42,2
		0,0	-0,7	136	39,2	136	40,3	136	41,4	136	42,0	135	42,5	135	43,6
		3,0	2,2	147	40,7	147	41,7	147	42,7	147	43,3	146	43,8	144	43,6
		5,0	4,1	155	41,6	154	42,6	154	43,5	154	44,0	154	44,5	144	41,1
		7,0	6,0	162	42,4	162	43,3	161	44,3	160	44,0	154	42,2	144	38,8
		9,0	7,9	170	43,2	169	44,0	165	43,3	160	41,6	154	40,0	144	36,7
		11,0	9,8	177	43,8	176	44,2	165	41,0	160	39,5	154	37,9	144	34,9
13,0	11,8	185	44,5	176	41,9	165	38,9	160	37,4	154	36,0	144	33,1		
15,0	13,7	186	42,7	176	39,8	165	37,0	160	35,6	154	34,3	144	31,6		
100	131,50 kW	-19,8	-20,0	66,3	21,1	66,0	23,2	65,7	25,3	65,6	26,4	65,5	27,4	65,2	29,6
		-18,8	-19,0	69,7	23,0	69,4	25,1	69,2	27,1	69,0	28,1	68,9	29,1	68,6	31,1
		-16,7	-17,0	76,6	26,4	76,4	28,3	76,1	30,1	76,0	31,0	75,8	31,9	75,6	33,7
		-13,7	-15,0	83,6	29,3	83,4	30,9	83,1	32,6	83,0	33,4	82,8	34,3	82,6	35,9
		-11,8	-13,0	90,7	31,7	90,4	33,2	90,2	34,7	90,0	35,5	89,9	36,3	89,6	37,8
		-9,8	-11,0	98	33,7	98	35,2	97	36,6	97	37,3	97	38,0	97	39,4
		-9,5	-10,0	101	34,7	101	36,0	101	37,4	101	38,1	101	38,7	100	40,1
		-8,5	-9,1	105	35,4	104	36,8	104	38,1	104	38,7	104	39,4	104	40,7
		-7,0	-7,6	110	36,6	110	37,9	110	39,1	109	39,8	109	40,4	109	41,6
		-5,0	-5,6	118	38,1	117	39,2	117	40,4	117	41,0	117	41,6	116	42,7
		-3,0	-3,7	125	39,3	124	40,4	124	41,5	124	42,0	124	42,6	123	43,7
		0,0	-0,7	136	41,0	136	42,0	135	43,0	135	43,5	135	44,0	131	42,9
		3,0	2,2	147	42,3	147	43,3	146	44,2	145	44,1	140	42,4	131	38,9
		5,0	4,1	154	43,1	154	44,0	150	43,2	145	41,6	140	39,9	131	36,7
		7,0	6,0	162	43,9	160	44,0	150	40,8	145	39,2	140	37,7	131	34,7
		9,0	7,9	169	44,6	160	41,6	150	38,6	145	37,2	140	35,7	131	32,9
		11,0	9,8	169	42,3	160	39,4	150	36,6	145	35,3	140	33,9	131	31,3
13,0	11,8	169	40,1	160	37,4	150	34,8	145	33,5	140	32,2	131	29,7		
15,0	13,7	169	38,1	160	35,6	150	33,1	145	31,9	140	30,7	131	28,4		

### NOTES - ANMERKUNGEN - Σημειώσεις - NOTAS - REMARQUES - NOTE - OPMERKINGEN - Примечания - NOTLAR

- is shown as reference. When selecting the unit models, avoid the Outdoor air temperature range shown by
- dient als Verweis. Vermeiden Sie bei der Auswahl der Gerätemodelle den als markierten Temperaturbereich der Außenluft
- Η είναι ενδεικτική, κατά την επιλογή των μοντέλων των μονάδων, αποφύγετε το εύρος θερμοκρασίας εξωτερικού αέρα που υποδεικνύεται
- se muestra como referencia. Cuando seleccione los modelos de unidad, evite el intervalo de temperaturas del aire exterior indicado mediante
- est montré comme référence. Lors du choix des modèles d'unités, évitez la plage de températures de l'air extérieur illustré par
- valori riportati unicamente come riferimento. Nel selezionare i modelli delle unità, non considerare i valori di temperatura dell'aria esterna indicati con il colore
- is als referentie getoond. Wanneer modellen van eenheden worden gekozen, vermijd dan het bereik van buitenluchttemperaturen geïllustreerd door
- показан как. При выборе модели устройства избегайте внешнюю температуру

воздуха, указанную в  
referans olarak gösterilmektedir. Ünite modellerini seçerken, belirtilen Dış hava sıcaklığı aralığından kaçınm

The above table shows the average value of conditions which may occur.  
Die obige Tabelle zeigt den Durchschnittswert der Bedingungen, die auftreten können.  
Στον παραπάνω πίνακα αναγράφεται η μέση τιμή για συνθήκες που μπορεί να προκύψουν.  
La tabla de arriba muestra el valor medio de condiciones que pueden ocurrir.  
Le tableau ci-dessus donne la valeur moyenne pour des conditions qui peuvent survenir.  
La tabella in alto mostra il valore delle condizioni medie che si possono riscontrare.  
De tabel hierboven geeft de gemiddelde waarde aan van situaties die kunnen voorvallen.  
Таблица расположенная выше показывает среднее значение условий, которые могут наступить.  
Yukarıdaki tablo meydana gelebilecek koşulların ortalama değerini göstermektedir.

# 5 Capacity tables

## 5 - 2 Heating Capacity Tables

5

RQYQ48PY1															
TC: Total Capacity: kW ; PI: Power Input: kW (compressor + outdoor fan motor)															
Combination (%)	Capacity index (kW)	Outdoor air temp.		Indoor air temperature: °CDB											
				16.0		18.0		20.0		21.0		22.0		24.0	
				TC	PI	TC	PI	TC	PI	TC	PI	TC	PI	TC	PI
		°CDB	°CWB												
90%	118,35 kW	-19,8	-20,0	65,8	24,8	65,6	26,7	65,3	28,6	65,2	29,6	65,1	30,5	64,9	32,5
		-18,8	-19,0	69,2	26,6	69,0	28,4	68,8	30,2	68,6	31,1	68,5	32,0	68,3	33,8
		-16,7	-17,0	76,2	29,6	75,9	31,3	75,7	32,9	75,6	33,7	75,4	34,6	75,2	36,2
		-13,7	-15,0	83,2	32,2	82,9	33,7	82,7	35,2	82,6	35,9	82,4	36,7	82,2	38,2
		-11,8	-13,0	90,2	34,4	90,0	35,7	89,7	37,1	89,6	37,8	89,5	38,5	89,3	39,8
		-9,8	-11,0	97	36,2	97	37,5	97	38,8	97	39,4	97	40,0	96	41,3
		-9,5	-10,0	101	37,1	101	38,3	100	39,5	100	40,1	100	40,7	100	41,9
		-8,5	-9,1	104	37,8	104	38,9	104	40,1	104	40,7	104	41,3	103	42,5
		-7,0	-7,6	110	38,8	109	40,0	109	41,1	109	41,6	109	42,2	109	43,3
		-5,0	-5,6	117	40,1	117	41,2	117	42,2	116	42,7	116	43,3	116	44,3
		-3,0	-3,7	124	41,2	124	42,2	124	43,2	123	43,7	123	44,2	118	42,1
		0,0	-0,7	135	42,7	135	43,6	135	44,5	131	42,8	126	41,1	118	37,8
		3,0	2,2	146	44,0	144	43,6	135	40,4	131	38,9	126	37,4	118	34,4
		5,0	4,1	152	44,0	144	41,0	135	38,1	131	36,7	126	35,3	118	32,5
		7,0	6,0	152	41,6	144	38,8	135	36,0	131	34,7	126	33,4	118	30,8
		9,0	7,9	152	39,3	144	36,7	135	34,2	131	32,9	126	31,7	118	29,2
		11,0	9,8	152	37,3	144	34,9	135	32,5	131	31,3	126	30,1	118	27,8
		13,0	11,8	152	35,4	144	33,1	135	30,8	131	29,7	126	28,6	118	26,5
		15,0	13,7	152	33,7	144	31,6	135	29,4	131	28,4	126	27,4	118	25,3
		80%	105,20 kW	-19,8	-20,0	65,3	28,5	65,1	30,2	64,9	31,9	64,8	32,8	64,7	33,6
-18,8	-19,0			68,8	30,1	68,6	31,7	68,4	33,3	68,2	34,1	68,1	34,9	67,9	36,6
-16,7	-17,0			75,7	32,8	75,5	34,3	75,3	35,8	75,2	36,5	75,1	37,2	74,8	38,7
-13,7	-15,0			82,7	35,1	82,5	36,4	82,3	37,8	82,2	38,4	82,1	39,1	81,8	40,4
-11,8	-13,0			89,8	37,0	89,5	38,3	89,3	39,5	89,2	40,1	89,1	40,7	88,9	41,9
-9,8	-11,0			97	38,7	97	39,8	96	40,9	96	41,5	96	42,1	96	43,2
-9,5	-10,0			101	39,4	100	40,5	100	41,6	100	42,1	100	42,7	100	43,8
-8,5	-9,1			104	40,1	104	41,1	103	42,2	103	42,7	103	43,2	103	44,3
-7,0	-7,6			109	41,0	109	42,0	109	43,0	109	43,5	109	44,0	105	42,6
-5,0	-5,6			117	42,2	116	43,1	116	44,0	116	44,5	112	42,8	105	39,3
-3,0	-3,7			124	43,1	123	44,0	120	43,1	116	41,4	112	39,8	105	36,6
0,0	-0,7			135	44,5	128	41,7	120	38,7	116	37,2	112	35,8	105	33,0
3,0	2,2			135	40,6	128	37,9	120	35,2	116	33,9	112	32,6	105	30,1
5,0	4,1			135	38,3	128	35,7	120	33,2	116	32,0	112	30,8	105	28,5
7,0	6,0			135	36,2	128	33,8	120	31,5	116	30,3	112	29,2	105	27,0
9,0	7,9			135	34,3	128	32,1	120	29,9	116	28,8	112	27,8	105	25,7
11,0	9,8			135	32,6	128	30,5	120	28,4	116	27,4	112	26,5	105	24,5
13,0	11,8			135	30,9	128	29,0	120	27,1	116	26,1	112	25,2	105	23,4
15,0	13,7			135	29,5	128	27,7	120	25,9	116	25,0	112	24,1	105	22,4
70%	92,05 kW			-19,8	-20,0	64,9	32,3	64,7	33,8	64,5	35,2	64,4	36,0	64,3	36,7
		-18,8	-19,0	68,3	33,6	68,1	35,1	67,9	36,5	67,8	37,2	67,8	37,9	67,6	39,3
		-16,7	-17,0	75,2	36,0	75,0	37,3	74,9	38,6	74,8	39,2	74,7	39,9	74,5	41,1
		-13,7	-15,0	82,2	38,0	82,0	39,2	81,9	40,4	81,8	40,9	81,7	41,5	81,5	42,7
		-11,8	-13,0	89,3	39,7	89,1	40,8	88,9	41,8	88,8	42,4	88,7	42,9	88,6	44,0
		-9,8	-11,0	96	41,2	96	42,1	96	43,1	96	43,6	95,9	44,1	91,5	42,1
		-9,5	-10,0	100	41,8	100	42,8	100	43,7	100	44,2	98,3	43,8	91,5	40,2
		-8,5	-9,1	103	42,4	103	43,3	103	44,2	102	43,8	98,3	42,1	91,5	38,7
		-7,0	-7,6	109	43,2	109	44,1	105	42,8	102	41,1	98,3	39,5	91,5	36,3
		-5,0	-5,6	116	44,2	112	42,5	105	39,5	102	38,0	98,3	36,5	91,5	33,6
		-3,0	-3,7	118	42,4	112	39,6	105	36,8	102	35,4	98,3	34,0	91,5	31,4
		0,0	-0,7	118	38,1	112	35,6	105	33,1	102	31,9	98,3	30,7	91,5	28,4
		3,0	2,2	118	34,7	112	32,5	105	30,3	102	29,2	98,3	28,1	91,5	26,0
		5,0	4,1	118	32,8	112	30,7	105	28,6	102	27,6	98,3	26,6	91,5	24,6
		7,0	6,0	118	31,0	112	29,1	105	27,1	102	26,2	98,3	25,3	91,5	23,4
		9,0	7,9	118	29,5	112	27,6	105	25,8	102	24,9	98,3	24,0	91,5	22,3
		11,0	9,8	118	28,1	112	26,3	105	24,6	102	23,8	98,3	22,9	91,5	21,3
		13,0	11,8	118	26,7	112	25,1	105	23,5	102	22,7	98,3	21,9	91,5	20,4
		15,0	13,7	118	25,5	112	24,0	105	22,5	102	21,7	98,3	21,0	91,5	19,5
		60%	78,90 kW	-19,8	-20,0	64,4	36,0	64,3	37,3	64,1	38,6	64,0	39,2	63,9	39,8
-18,8	-19,0			67,8	37,2	67,7	38,4	67,5	39,6	67,4	40,2	67,4	40,8	67,2	42,0
-16,7	-17,0			74,8	39,2	74,6	40,3	74,4	41,4	74,4	42,0	74,3	42,5	74,1	43,6
-13,7	-15,0			81,8	40,9	81,6	41,9	81,4	42,9	81,4	43,4	81,3	43,9	78,4	42,6
-11,8	-13,0			88,8	42,4	88,7	43,3	88,5	44,2	87,1	43,6	84,2	41,9	78,4	38,5
-9,8	-11,0			96	43,6	95,8	44,5	90,0	41,2	87,1	39,7	84,2	38,1	78,4	35,1
-9,5	-10,0			100	44,2	95,8	42,5	90,0	39,4	87,1	37,9	84,2	36,5	78,4	33,6
-8,5	-9,1			102	43,8	95,8	40,8	90,0	37,9	87,1	36,5	84,2	35,1	78,4	32,3
-7,0	-7,6			102	41,1	95,8	38,3	90,0	35,6	87,1	34,3	84,2	33,0	78,4	30,5
-5,0	-5,6			102	37,9	95,8	35,4	90,0	33,0	87,1	31,8	84,2	30,6	78,4	28,3
-3,0	-3,7			102	35,4	95,8	33,0	90,0	30,8	87,1	29,7	84,2	28,6	78,4	26,5
0,0	-0,7			102	31,9	95,8	29,9	90,0	27,9	87,1	26,9	84,2	25,9	78,4	24,0
3,0	2,2			102	29,2	95,8	27,3	90,0	25,5	87,1	24,7	84,2	23,8	78,4	22,1
5,0	4,1			102	27,6	95,8	25,9	90,0	24,2	87,1	23,4	84,2	22,6	78,4	21,0
7,0	6,0			102	26,2	95,8	24,6	90,0	23,0	87,1	22,3	84,2	21,5	78,4	20,0
9,0	7,9			102	24,9	95,8	23,4	90,0	21,9	87,1	21,2	84,2	20,5	78,4	19,1
11,0	9,8			102	23,8	95,8	22,3	90,0	21,0	87,1	20,3	84,2	19,6	78,4	18,3
13,0	11,8			102	22,7	95,8	21,3	90,0	20,0	87,1	19,4	84,2	18,7	78,4	17,5
15,0	13,7			102	21,7	95,8	20,4	90,0	19,2	87,1	18,6	84,2	18,0	78,4	16,8
50%	65,75 kW			-19,8	-20,0	64,0	39,7	63,8	40,8	63,7	41,9	63,6	42,4	63,6	42,9
		-18,8	-19,0	67,4	40,7	67,3	41,7	67,1	42,7	67,1	43,2	67,0	43,7	65,4	43,2
		-16,7	-17,0	74,3	42,4	74,2	43,3	74,0	44,3	72,6	43,4	70,2	41,7	65,4	38,3
		-13,7	-15,0	81,3	43,9	79,8	43,5	75,0	40,4	72,6	38,9	70,2	37,3	65,4	34,4
		-11,8	-13,0	84,6	42,1	79,8	39,3	75,0	36,5	72,6	35,2	70,2	33,8	65,4	31,2
		-9,8	-11,0	84,6	38,3	79,8	35,8	75,0	33,3	72,6	32,1	70,2	30,9	65,4	28,5
		-9,5	-10,0	84,6	36,7	79,8	34,3	75,0	31,9	72,6	30,7	70,2	29,6	65,4	27,4
		-8,5	-9,1	84,6	35,3	79,8	33,0	75,0	30,7	72,6	29,6	70,2	28,5	65,4	26,4
		-7,0	-7,6	84,6	33,2	79,8	31,1	75,0	29,0	72,6	27,9	70,2	26,9	65,4	24,9
		-5,0	-5,6	84,6	30,8	79,8	28,8	75,0	26,9	72,6	26,0	70,2	25,1	65,4	23,2
		-3,0	-3,7	84,6	28,8	79,8	27,0	75,0	25,2	72,6	24,3	70,2	23,5	65,4	21,8
		0,0	-0,7	84,6	26,1	79,8	24,5	75,0	22,9	72,6	22,2	70,2	21,4	65,4	19,9
		3,0	2,2	84,6	23,9	79,8	22,5	75,0	21,1	72,6	20,4	70,2	19,7	65,4	18,4
		5,0	4,1	84,6	22,7	79,8	21,4								

# 5 Capacity tables

## 5 - 3 Capacity Correction Factor

### RQYQ140P

1. Rate of change in cooling capacity

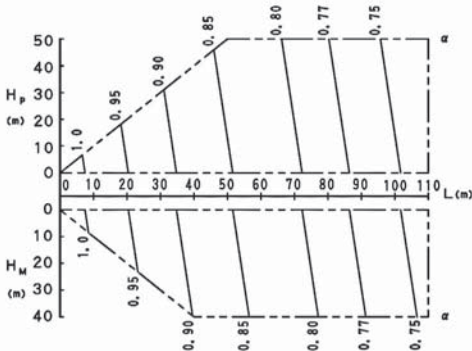

2. Rate of change in heating capacity

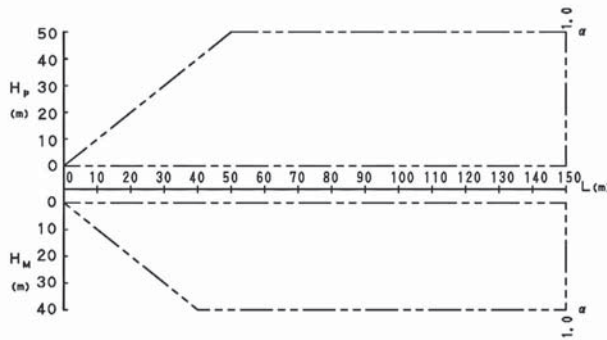

[ Diameter of the main pipes (standard size) ]

Model	Gas	Liquid
RQYQ140P	ø 15.9	ø 9.5

[ Explanation of symbols ]

- Hp: Level difference (m) between indoor and outdoor units where indoor unit in inferior position
- Hm: Level difference (m) between indoor and outdoor units where indoor unit in superior position
- L: Equivalent pipe length (m)
- α: Rate of change in cooling/heating capacity

3D066843

### NOTES

1. These figures illustrate the rate of change in capacity of a standard indoor unit system at maximum load (with the thermostat set to maximum) under standard conditions. Moreover, under partial load conditions there is only a minor deviation from the rate of change in capacity shown in the above figures.
2. Method of calculating A/C (cooling/heating) capacity:  
The maximum A/C capacity of the system will be either the total A/C capacity of the indoor units obtained from capacity characteristic table or the maximum A/C capacity of outdoor units as mentioned below, whichever smaller.

Calculating A/C capacity of outdoor units.

- Condition: Indoor unit combination ratio does not exceed 100%.

$$\text{Maximum A/C capacity of outdoor units} = \left[ \text{A/C capacity of outdoor units obtained from capacity characteristic table at the 100\% combination} \right] \times \left[ \text{Capacity change rate due to piping length to the farthest indoor unit} \right]$$

- Condition: Indoor unit combination ratio exceeds 100%.

$$\text{Maximum A/C capacity of outdoor units} = \left[ \text{A/C capacity of outdoor units obtained from capacity characteristic table at the combination} \right] \times \left[ \text{Capacity change rate due to piping length to the farthest indoor unit} \right]$$

3. When overall equivalent pipe length is 90m or more, the diameter of the main gas pipes (outdoor unit-branch sections) must be increased.  
[ Diameter of above case ]

Model	Gas	Liquid
RQYQ140P	ø 19.1	Not increased

4. Read cooling/heating capacity rate of change in the above figures based on the following equivalent length.

$$\text{Overall equivalent length} = (\text{Equivalent length to main pipe}) \times \text{Correction factor} + (\text{Equivalent length after branching})$$

Choose a correction factor from the following table. [When cooling capacity is calculated: gas pipe size  
When heating capacity is calculated: liquid pipe size]

Rate of change (object piping)	Correction factor	
	Standard size	Size increase
Cooling (gas pipe)	1.0	0.5
Heating (liquid pipe)	1.0	1.0

(example)

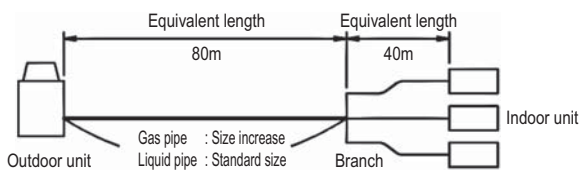

In the above case (Cooling) Overall equivalent length = 80m x 0.5 + 40m = 80m  
(Heating) Overall equivalent length = 80m x 1.0 + 40m = 120m  
The rate of change in cooling capacity when Hp = 0m is thus approximately 0.78  
heating capacity when Hp = 0m is thus approximately 1.00

# 5 Capacity tables

## 5 - 3 Capacity Correction Factor

5

RQYQ8P

1. Rate of change in cooling capacity

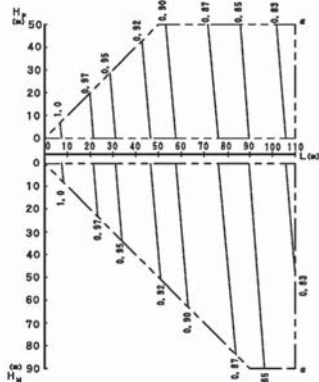

[ Diameter of the main pipes (standard size) ]

Model	Gas	Liquid
RQYQ8P	ø 19.1	ø 9.5

2. Rate of change in heating capacity

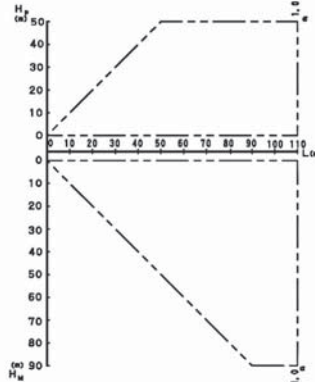

[ Explanation of symbols ]

- Hp: Level difference (m) between indoor and outdoor units where indoor unit in inferior position
- Hm: Level difference (m) between indoor and outdoor units where indoor unit in superior position
- L: Equivalent pipe length (m)
- α: Rate of change in cooling/heating capacity

[ Temper grade and Thickness ]

Temper grade	O Type		1/2 H Type	
Outer diameter	ø 9.5	ø 12.7	ø 19.1	ø 22.2
Minimum Wall Thickness	0.80	0.80	0.80	0.88

3D053164K

### NOTES

- These figures illustrate the rate of change in capacity of a standard indoor unit system at maximum load (with the thermostat set to maximum) under standard conditions. Moreover, under partial load conditions there is only a minor deviation from the rate of change in capacity shown in the above figures.
- With this outdoor unit, evaporating pressure constant control when cooling and condensing pressure constant control when heating is carried out.
- Method of calculating A/C (cooling/heating) capacity:  
The maximum A/C capacity of the system will be either the total A/C capacity of the indoor units obtained from capacity characteristic table or the maximum A/C capacity of outdoor units as mentioned below, whichever smaller.

Calculating A/C capacity of outdoor units.

- Condition: Indoor unit combination ratio does not exceed 100%.

$$\text{Maximum A/C capacity of outdoor units} = \left[ \text{A/C capacity of outdoor units obtained from capacity characteristic table at the 100\% combination} \right] \times \left[ \text{Capacity change rate due to piping length to the farthest indoor unit} \right]$$

- Condition: Indoor unit combination ratio exceeds 100%.

$$\text{Maximum A/C capacity of outdoor units} = \left[ \text{A/C capacity of outdoor units obtained from capacity characteristic table at the combination} \right] \times \left[ \text{Capacity change rate due to piping length to the farthest indoor unit} \right]$$

- When overall equivalent pipe length is 90m or more, the diameter of the main gas and liquid pipes (outdoor unit-branch sections) must be increased. When level difference is 50m or more, the diameter of the main liquid pipe (outdoor unit-branch sections) must be increased.

[ Diameter of above case ]

Model	Gas	Liquid
RQYQ8P	ø 22.2	ø 12.7

- Read cooling/heating capacity rate of change in the above figures based on the following equivalent length.

$$\text{Overall equivalent length} = (\text{Equivalent length to main pipe}) \times \text{Correction factor} + (\text{Equivalent length after branching})$$

Choose a correction factor from the following table.

- When cooling capacity is calculated: gas pipe size
- When heating capacity is calculated: liquid pipe size

Rate of change (object piping)	Correction factor	
	Standard size	Size increase
Cooling (gas pipe)	1.0	0.5
Heating (liquid pipe)	1.0	0.2

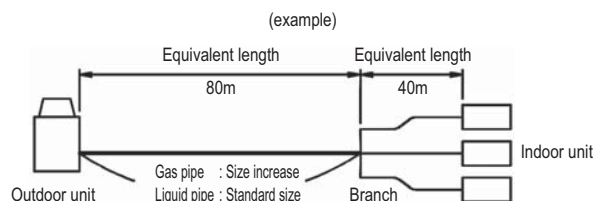

In the above case (Cooling) Overall equivalent length = 80m x 0.5 + 40m = 80m  
 (Heating) Overall equivalent length = 80m x 0.2 + 40m = 56m  
 The rate of change in cooling capacity when Hp = 0m is thus approximately 0.86  
 heating capacity when Hp = 0m is thus approximately 1.00



# 5 Capacity tables

## 5 - 3 Capacity Correction Factor

### RQYQ10P

1. Rate of change in cooling capacity

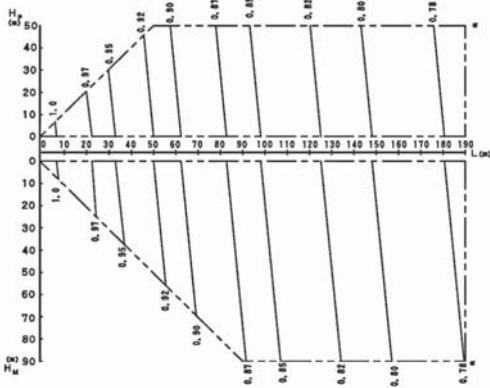

[ Diameter of the main pipes (standard size) ]

Model	Gas	Liquid
RXYQ10P	ø 22.2	ø 9.5

2. Rate of change in heating capacity

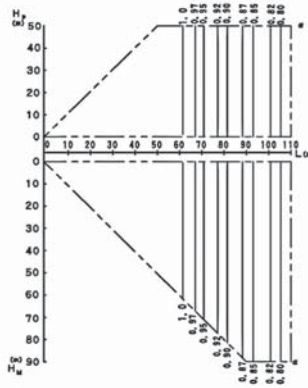

[ Explanation of symbols ]

- Hp: Level difference (m) between indoor and outdoor units where indoor unit in inferior position
- Hm: Level difference (m) between indoor and outdoor units where indoor unit in superior position
- L: Equivalent pipe length (m)
- α: Rate of change in cooling/heating capacity

[ Temper grade and Thickness ]

Temper grade	O Type		1/2 H Type	
Outer diameter	ø 9.5	ø 12.7	ø 22.2	ø 25.4
Minimum Wall Thickness	0.80	0.80	0.80	0.88

3D053165K

### NOTES

- These figures illustrate the rate of change in capacity of a standard indoor unit system at maximum load (with the thermostat set to maximum) under standard conditions. Moreover, under partial load conditions there is only a minor deviation from the rate of change in capacity shown in the above figures.
- With this outdoor unit, evaporating pressure constant control when cooling and condensing pressure constant control when heating is carried out.
- Method of calculating A/C (cooling/heating) capacity:  
The maximum A/C capacity of the system will be either the total A/C capacity of the indoor units obtained from capacity characteristic table or the maximum A/C capacity of outdoor units as mentioned below, whichever smaller.

Calculating A/C capacity of outdoor units.

- Condition: Indoor unit combination ratio does not exceed 100%.

$$\text{Maximum A/C capacity of outdoor units} = \left[ \text{A/C capacity of outdoor units obtained from capacity characteristic table at the 100\% combination} \right] \times \left[ \text{Capacity change rate due to piping length to the farthest indoor unit} \right]$$

- Condition: Indoor unit combination ratio exceeds 100%.

$$\text{Maximum A/C capacity of outdoor units} = \left[ \text{A/C capacity of outdoor units obtained from capacity characteristic table at the combination} \right] \times \left[ \text{Capacity change rate due to piping length to the farthest indoor unit} \right]$$

- When overall equivalent pipe length is 90m or more, the diameter of the main gas and liquid pipes (outdoor unit-branch sections) must be increased. When level difference is 50m or more, the diameter of the main liquid pipe (outdoor unit-branch sections) must be increased.

[ Diameter of above case ]

Model	Gas	Liquid
RQYQ10P	ø 25.4 *	ø 12.7

\* If available on the site, use this size. Otherwise, not increased

- Read cooling/heating capacity rate of change in the above figures based on the following equivalent length.

$$\text{Overall equivalent length} = (\text{Equivalent length to main pipe}) \times \text{Correction factor} + (\text{Equivalent length after branching})$$

Choose a correction factor from the following table.

- [ When cooling capacity is calculated: gas pipe size
- [ When heating capacity is calculated: liquid pipe size

Rate of change (object piping)	Correction factor	
	Standard size	Size increase
Cooling (gas pipe)	1.0	0.5
Heating (liquid pipe)	1.0	0.2

(example)

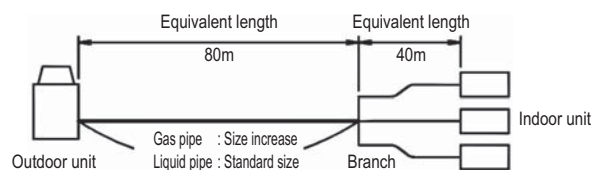

In the above case (Cooling) Overall equivalent length = 80m x 0.5 + 40m = 80m  
 (Heating) Overall equivalent length = 80m x 0.2 + 40m = 56m  
 The rate of change in cooling capacity when Hp = 0m is thus approximately 0.87  
 heating capacity when Hp = 0m is thus approximately 1.00

# 5 Capacity tables

## 5 - 3 Capacity Correction Factor

5

### RQYQ12,14,24,36P

#### 1. Rate of change in cooling capacity

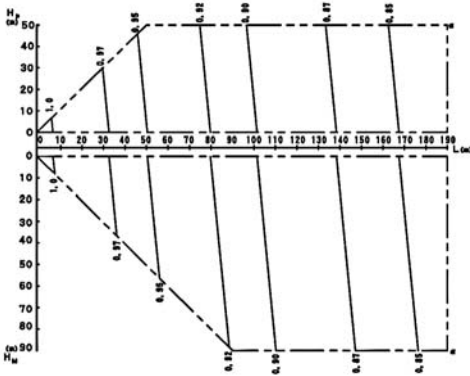

[ Diameter of the main pipes (standard size) ]

Model	Gas	Liquid
RQYQ12-14P	ø 28.6	ø 12.7

#### 2. Rate of change in heating capacity

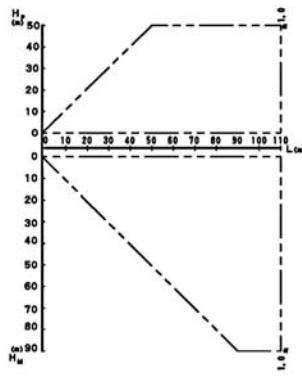

[ Explanation of symbols ]

- Hp: Level difference (m) between indoor and outdoor units where indoor unit in inferior position
- Hm: Level difference (m) between indoor and outdoor units where indoor unit in superior position
- L: Equivalent pipe length (m)
- α: Rate of change in cooling/heating capacity

[ Temper grade and thickness ]

Temper grade	O Type		1/2 H Type				
	Outer diameter	Minimum wall thickness	Outer diameter	Minimum wall thickness	Outer diameter	Minimum wall thickness	
Outer diameter	ø 12.7	ø 15.9	ø 19.1	ø 22.2	ø 28.6	ø 34.9	ø 41.3
Minimum wall thickness	0.80	0.99	0.80	0.80	0.99	1.21	1.43

3D053166L

### NOTES

- These figures illustrate the rate of change in capacity of a standard indoor unit system at maximum load (with the thermostat set to maximum) under standard conditions. Moreover, under partial load conditions there is only a minor deviation from the rate of change in capacity shown in the above figures.
- With this outdoor unit, evaporating pressure constant control when cooling and condensing pressure constant control when heating is carried out.
- Method of calculating A/C (cooling/heating) capacity:  
The maximum A/C capacity of the system will be either the total A/C capacity of the indoor units obtained from capacity characteristic table or the maximum A/C capacity of outdoor units as mentioned below, whichever smaller.  
Calculating A/C capacity of outdoor units.

- Condition: Indoor unit combination ratio does not exceed 100%.

$$\text{Maximum A/C capacity of outdoor units} = \left[ \text{A/C capacity of outdoor units obtained from capacity characteristic table at the 100\% combination} \right] \times \left[ \text{Capacity change rate due to piping length to the farthest indoor unit} \right]$$

- Condition: Indoor unit combination ratio exceeds 100%.

$$\text{Maximum A/C capacity of outdoor units} = \left[ \text{A/C capacity of outdoor units obtained from capacity characteristic table at the combination} \right] \times \left[ \text{Capacity change rate due to piping length to the farthest indoor unit} \right]$$

- When overall equivalent pipe length is 90m or more, the diameter of the main gas and liquid pipes (outdoor unit-branch sections) must be increased. When level difference is 50m or more, the diameter of the main liquid pipe (outdoor unit-branch sections) must be increased.

[ Diameter of above case ]

Model	Gas	Liquid
RQYQ12-14P	Not increased	ø 15.9

\* If available on the site, use this size. Otherwise, not increased

- Read cooling/heating capacity rate of change in the above figures based on the following equivalent length.

$$\text{Overall equivalent length} = (\text{Equivalent length to main pipe}) \times \text{Correction factor} + (\text{Equivalent length after branching})$$

Choose a correction factor from the following table.

- When cooling capacity is calculated: gas pipe size
- When heating capacity is calculated: liquid pipe size

Rate of change (object piping)	Correction factor		
	Standard size	Size increase	
		12-14HP	24-36HP
Cooling (gas pipe)	1.0	0.3	0.4
Heating (liquid pipe)	1.0	0.3	0.4

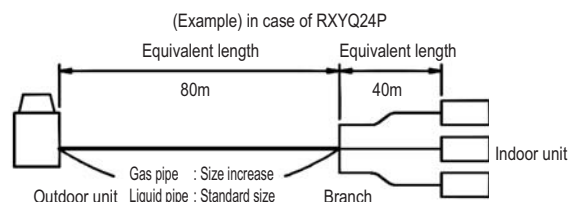

In the above case (Cooling) Overall equivalent length = 80m x 1.0 + 40m = 120m  
(Heating) Overall equivalent length = 80m x 0.4 + 40m = 72m  
The rate of change in cooling capacity when Hp = 0m is thus approximately 0.88  
heating capacity when Hp = 0m is thus approximately 1.00

# 5 Capacity tables

## 5 - 3 Capacity Correction Factor

RQYQ16P

1. Rate of change in cooling capacity

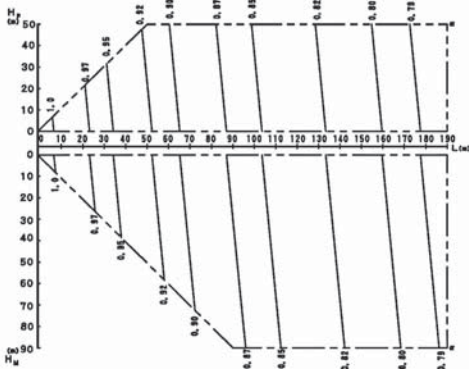

[ Diameter of the main pipes (standard size) ]

Model	Gas	Liquid
RQYQ16P	ø 28.6	ø 12.7

2. Rate of change in heating capacity

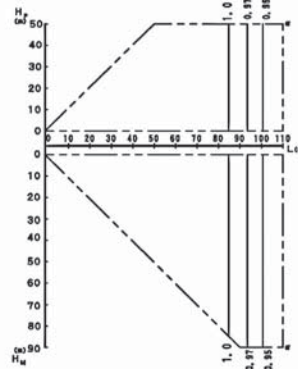

[ Explanation of symbols ]

- Hp: Level difference (m) between indoor and outdoor units where indoor unit in inferior position
- Hm: Level difference (m) between indoor and outdoor units where indoor unit in superior position
- L: Equivalent pipe length (m)
- α: Rate of change in cooling/heating capacity

[ Temper grade and Thickness ]

Temper grade	O Type		1/2 H Type	
Outer diameter	ø 12.7	ø 15.9	ø 28.6	ø 31.8
Minimum Wall Thickness	0.80	0.99	0.99	1.10

3D053167M

### NOTES

- These figures illustrate the rate of change in capacity of a standard indoor unit system at maximum load (with the thermostat set to maximum) under standard conditions. Moreover, under partial load conditions there is only a minor deviation from the rate of change in capacity shown in the above figures.
- With this outdoor unit, evaporating pressure constant control when cooling and condensing pressure constant control when heating is carried out.
- Method of calculating A/C (cooling/heating) capacity:  
The maximum A/C capacity of the system will be either the total A/C capacity of the indoor units obtained from capacity characteristic table or the maximum A/C capacity of outdoor units as mentioned below, whichever smaller.

Calculating A/C capacity of outdoor units.

- Condition: Indoor unit combination ratio does not exceed 100%.

$$\text{Maximum A/C capacity of outdoor units} = \left[ \text{A/C capacity of outdoor units obtained from capacity characteristic table at the 100\% combination} \right] \times \left[ \text{Capacity change rate due to piping length to the farthest indoor unit} \right]$$

- Condition: Indoor unit combination ratio exceeds 100%.

$$\text{Maximum A/C capacity of outdoor units} = \left[ \text{A/C capacity of outdoor units obtained from capacity characteristic table at the combination} \right] \times \left[ \text{Capacity change rate due to piping length to the farthest indoor unit} \right]$$

- When overall equivalent pipe length is 90m or more, the diameter of the main gas and liquid pipes (outdoor unit-branch sections) must be increased. When level difference is 50m or more, the diameter of the main liquid pipe (outdoor unit-branch sections) must be increased.

[ Diameter of above case ]

Model	Gas	Liquid
RQYQ16P	ø 31.8 *	ø 15.9

\* If available on the site, use this size. Otherwise, not increased

- Read cooling/heating capacity rate of change in the above figures based on the following equivalent length.

$$\text{Overall equivalent length} = (\text{Equivalent length to main pipe}) \times \text{Correction factor} + (\text{Equivalent length after branching})$$

Choose a correction factor from the following table.

- [ When cooling capacity is calculated: gas pipe size
- [ When heating capacity is calculated: liquid pipe size

Rate of change (object piping)	Correction factor	
	Standard size	Size increase
Cooling (gas pipe)	1.0	0.5
Heating (liquid pipe)	1.0	0.3

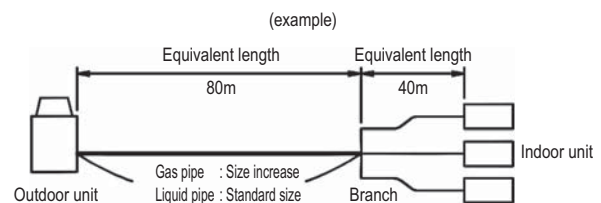

In the above case (Cooling) Overall equivalent length = 80m x 0.5 + 40m = 80m  
 (Heating) Overall equivalent length = 80m x 0.3 + 40m = 64m  
 The rate of change in cooling capacity when Hp = 0m is thus approximately 0.88  
 heating capacity when Hp = 0m is thus approximately 1.00

# 5 Capacity tables

## 5 - 3 Capacity Correction Factor

5

### RQYQ18,26-30,38-44P

#### 1. Rate of change in cooling capacity

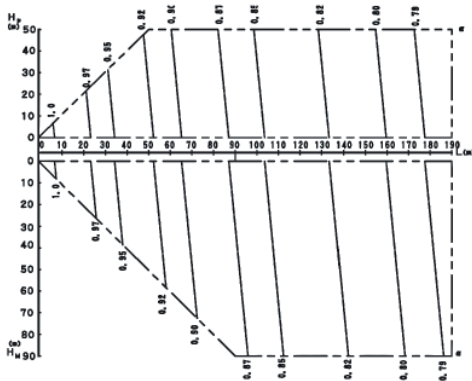

#### 2. Rate of change in heating capacity

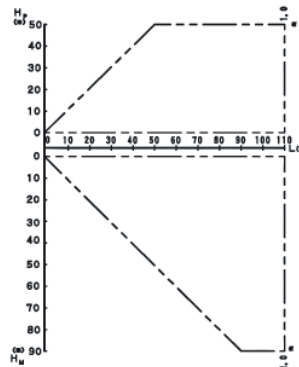

[ Diameter of the main pipes (standard size) ]

Model	Gas	Liquid
RQYQ18P	ø 28.6	ø 15.9
RQYQ26, 28, 30P	ø 34.9	ø 19.1
RQYQ38, 40, 42, 44P	ø 41.3	ø 19.1

[ Explanation of symbols ]

- Hp: Level difference (m) between indoor and outdoor units where indoor unit in inferior position
- Hm: Level difference (m) between indoor and outdoor units where indoor unit in superior position
- L: Equivalent pipe length (m)
- α: Rate of change in cooling/heating capacity

[ Temper grade and thickness ]

Temper grade	O Type		1/2 H Type					
	ø 15.9	ø 19.1	ø 22.2	ø 28.6	ø 31.8	ø 34.9	ø 38.1	ø 41.3
Outer diameter								
Minimum wall thickness	0.99	0.80	0.80	0.99	1.10	1.21	1.32	1.43

3D053168J

### NOTES

- These figures illustrate the rate of change in capacity of a standard indoor unit system at maximum load (with the thermostat set to maximum) under standard conditions. Moreover, under partial load conditions there is only a minor deviation from the rate of change in capacity shown in the above figures.
- With this outdoor unit, evaporating pressure constant control when cooling and condensing pressure constant control when heating is carried out.
- Method of calculating A/C (cooling/heating) capacity:  
The maximum A/C capacity of the system will be either the total A/C capacity of the indoor units obtained from capacity characteristic table or the maximum A/C capacity of outdoor units as mentioned below, whichever smaller.

#### Calculating A/C capacity of outdoor units.

- Condition: Indoor unit combination ratio does not exceed 100%.

$$\text{Maximum A/C capacity of outdoor units} = \left[ \text{A/C capacity of outdoor units obtained from capacity characteristic table at the 100\% combination} \right] \times \left[ \text{Capacity change rate due to piping length to the farthest indoor unit} \right]$$

- Condition: Indoor unit combination ratio exceeds 100%.

$$\text{Maximum A/C capacity of outdoor units} = \left[ \text{A/C capacity of outdoor units obtained from capacity characteristic table at the combination} \right] \times \left[ \text{Capacity change rate due to piping length to the farthest indoor unit} \right]$$

- When overall equivalent pipe length is 90m or more, the diameter of the main gas and liquid pipes (outdoor unit-branch sections) must be increased. When level difference is 50m or more, the diameter of the main liquid pipe (outdoor unit-branch sections) must be increased.

[ Diameter of above case ]

Model	Gas	Liquid
RQYQ18P	ø 31.8*	ø 19.1
RQYQ26, 28, 30P	ø 38.1*	ø 22.2
RQYQ38, 40, 42, 44P	Not increased	ø 22.2

\* If available on the site, use this size. Otherwise, not increased

- Read cooling/heating capacity rate of change in the above figures based on the following equivalent length.

$$\text{Overall equivalent length} = (\text{Equivalent length to main pipe}) \times \text{Correction factor} + (\text{Equivalent length after branching})$$

Choose a correction factor from the following table.

- [ When cooling capacity is calculated: gas pipe size
- [ When heating capacity is calculated: liquid pipe size

Rate of change (object piping)	Correction factor	
	Standard size	Size increase
Cooling (gas pipe)	1.0	0.5
Heating (liquid pipe)	1.0	0.4

(example)

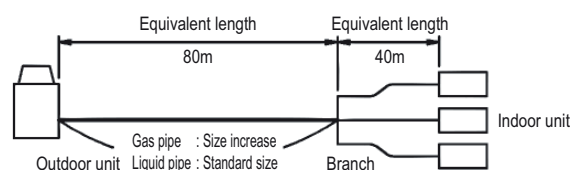

In the above case (Cooling) Overall equivalent length = 80m x 1.0 + 40m = 120m  
(Heating) Overall equivalent length = 80m x 0.4 + 40m = 72m  
The rate of change in cooling capacity when Hp = 0m is thus approximately 0.83  
heating capacity when Hp = 0m is thus approximately 1.00

# 5 Capacity tables

## 5 - 3 Capacity Correction Factor

### RQYQ20,32,34P

#### 1. Rate of change in cooling capacity

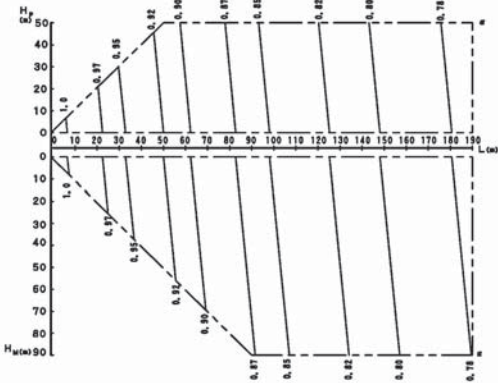

#### 2. Rate of change in heating capacity

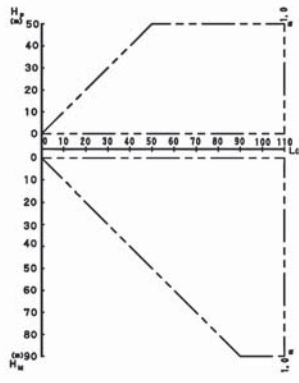

[ Diameter of the main pipes (standard size) ]

Model	Gas	Liquid
RQYQ20P	ø 28.6	ø 15.9
RQYQ32, 34P	ø 34.9	ø 19.1

[ Explanation of symbols ]

- Hp: Level difference (m) between indoor and outdoor units where indoor unit in inferior position
- Hm: Level difference (m) between indoor and outdoor units where indoor unit in superior position
- L: Equivalent pipe length (m)
- α: Rate of change in cooling/heating capacity

[ Temper grade and thickness ]

Temper grade	1/2 H Type						
	O Type						
Outer diameter	ø 15.9	ø 19.1	ø 22.2	ø 28.6	ø 31.8	ø 34.9	ø 38.1
Minimum wall thickness	0.99	0.80	0.80	0.99	1.10	1.21	1.32

3D053170H

### NOTES

- These figures illustrate the rate of change in capacity of a standard indoor unit system at maximum load (with the thermostat set to maximum) under standard conditions. Moreover, under partial load conditions there is only a minor deviation from the rate of change in capacity shown in the above figures.
- With this outdoor unit, evaporating pressure constant control when cooling and condensing pressure constant control when heating is carried out.
- Method of calculating A/C (cooling/heating) capacity:  
The maximum A/C capacity of the system will be either the total A/C capacity of the indoor units obtained from capacity characteristic table or the maximum A/C capacity of outdoor units as mentioned below, whichever smaller.

#### Calculating A/C capacity of outdoor units.

- Condition: Indoor unit combination ratio does not exceed 100%.

$$\text{Maximum A/C capacity of outdoor units} = \left[ \text{A/C capacity of outdoor units obtained from capacity characteristic table at the 100\% combination} \right] \times \left[ \text{Capacity change rate due to piping length to the farthest indoor unit} \right]$$

- Condition: Indoor unit combination ratio exceeds 100%.

$$\text{Maximum A/C capacity of outdoor units} = \left[ \text{A/C capacity of outdoor units obtained from capacity characteristic table at the combination} \right] \times \left[ \text{Capacity change rate due to piping length to the farthest indoor unit} \right]$$

- When overall equivalent pipe length is 90m or more, the diameter of the main gas and liquid pipes (outdoor unit-branch sections) must be increased. When level difference is 50m or more, the diameter of the main liquid pipe (outdoor unit-branch sections) must be increased.

[ Diameter of above case ]

Model	Gas	Liquid
RQYQ20P	ø 31.8*	ø 19.1
RQYQ32, 34P	ø 38.1*	ø 22.2

\* If available on the site, use this size. Otherwise, not increased

- Read cooling/heating capacity rate of change in the above figures based on the following equivalent length.

$$\text{Overall equivalent length} = (\text{Equivalent length to main pipe}) \times \text{Correction factor} + (\text{Equivalent length after branching})$$

Choose a correction factor from the following table.

- When cooling capacity is calculated: gas pipe size
- When heating capacity is calculated: liquid pipe size

Rate of change (object piping)	Correction factor	
	Standard size	Size increase
Cooling (gas pipe)	1.0	0.5
Heating (liquid pipe)	1.0	0.4

(example) In case of RXYQ32P

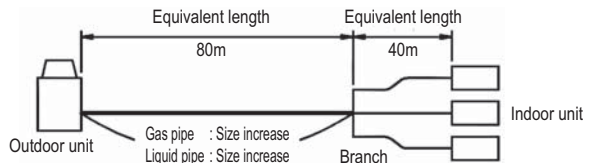

In the above case  
 (Cooling) Overall equivalent length = 80m x 0.5 + 40m = 80m  
 (Heating) Overall equivalent length = 80m x 0.4 + 40m = 72m  
 The rate of change in cooling capacity when Hp = 0m is thus approximately 0.87  
 heating capacity when Hp = 0m is thus approximately 1.00



# 5 Capacity tables

## 5 - 3 Capacity Correction Factor

5

RQYQ22P

1. Rate of change in cooling capacity

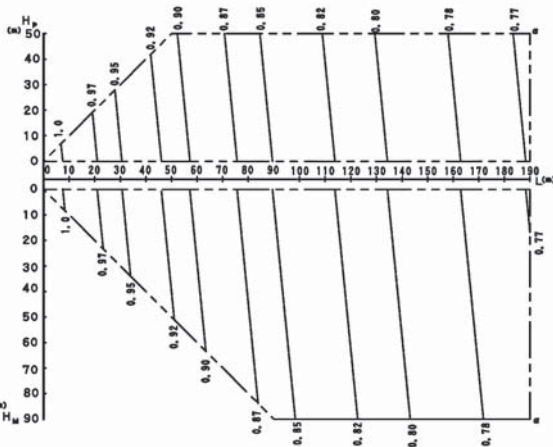

2. Rate of change in heating capacity

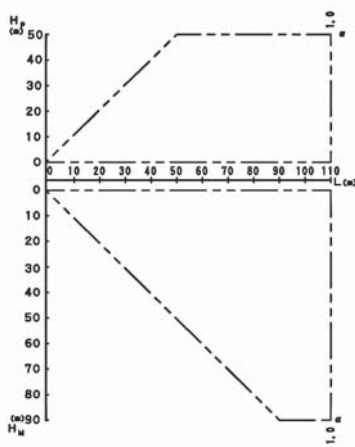

[ Explanation of symbols ]

- Hp: Level difference (m) between indoor and outdoor units where indoor unit in inferior position
- Hm: Level difference (m) between indoor and outdoor units where indoor unit in superior position
- L: Equivalent pipe length (m)
- α: Rate of change in cooling/heating capacity

[ Diameter of the main pipes (standard size) ]

Model	Gas	Liquid
RQYQ22P	ø 28.6	ø 15.9

[ Temper grade and Thickness ]

Temper grade	O Type	1/2H Type	
Outer diameter	ø 15.9	ø 19.1	ø 28.6   ø 31.8
Minimum Wall Thickness	0.99	0.80	0.99   1.10

3D053169H

### NOTES

- These figures illustrate the rate of change in capacity of a standard indoor unit system at maximum load (with the thermostat set to maximum) under standard conditions. Moreover, under partial load conditions there is only a minor deviation from the rate of change in capacity shown in the above figures.
- With this outdoor unit, evaporating pressure constant control when cooling, and condensing pressure constant control when heating is carried out.
- Method of calculating A/C (cooling/heating) capacity:  
The maximum A/C capacity of the system will be either the total A/C capacity of the indoor units obtained from capacity characteristic table or the maximum A/C capacity of outdoor units as mentioned below, whichever smaller.

Calculating A/C capacity of outdoor units.

- Condition: Indoor unit combination ratio does not exceed 100%.

$$\text{Maximum A/C capacity of outdoor units} = \left[ \text{A/C capacity of outdoor units obtained from capacity characteristic table at the 100\% combination} \right] \times \left[ \text{Capacity change rate due to piping length to the farthest indoor unit} \right]$$

- Condition: Indoor unit combination ratio exceeds 100%.

$$\text{Maximum A/C capacity of outdoor units} = \left[ \text{A/C capacity of outdoor units obtained from capacity characteristic table at the combination} \right] \times \left[ \text{Capacity change rate due to piping length to the farthest indoor unit} \right]$$

- When overall equivalent pipe length is 90m or more, the diameter of the main gas and liquid pipes (outdoor unit-branch sections) must be increased. When level difference is 50m or more, the diameter of the main liquid pipe (outdoor unit-branch sections) must be increased.

[ Diameter of above case ]

Model	Gas	Liquid
RQYQ22P	ø 31.8*	ø 19.1

\* If available on the site, use this size. Otherwise, not increased.

- Read cooling/heating capacity rate of change in the above figures based on the following equivalent length.

$$\text{Overall equivalent length} = (\text{Equivalent length to main pipe}) \times \text{Correction factor} + (\text{Equivalent length after branching})$$

Choose a correction factor from the following table. [When cooling capacity is calculated: gas pipe size  
When heating capacity is calculated: liquid pipe size

Rate of change (object piping)	Correction factor	
	Standard size	Size increase
Cooling (gas pipe)	1.0	0.5
Heating (liquid pipe)	1.0	0.4

(example)

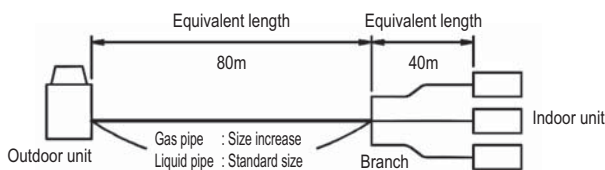

In the above case (Cooling) Overall equivalent length = 80m x 0.5 + 40m = 80m  
(Heating) Overall equivalent length = 80m x 0.4 + 40m = 72m  
The rete of change in cooling capacity when Hp = 0m is thus approximately 0.86  
heating capacity when Hp = 0m is thus approximately 1.0

# 5 Capacity tables

## 5 - 3 Capacity Correction Factor

### RQYQ46P

#### 1. Rate of change in cooling capacity

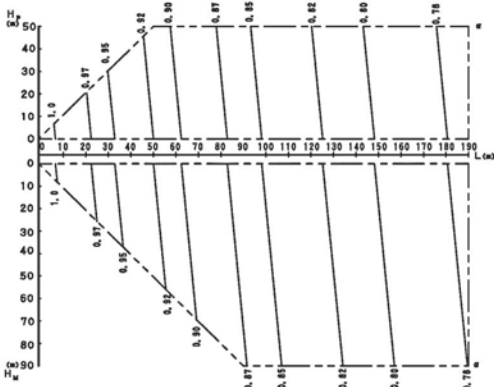

#### 2. Rate of change in heating capacity

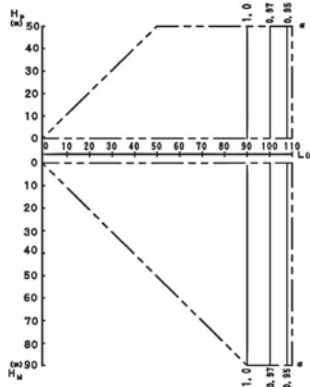

[ Diameter of the main pipes (standard size) ]

Model	Gas	Liquid
RQYQ46P	ø 41.3	ø 19.1

[ Explanation of symbols ]

- Hp: Level difference (m) between indoor and outdoor units where indoor unit in inferior position
- Hm: Level difference (m) between indoor and outdoor units where indoor unit in superior position
- L: Equivalent pipe length (m)
- α: Rate of change in cooling/heating capacity

[ Temper grade and thickness ]

Temper grade	1/2 H Type		
Outer diameter	ø 19.1	ø 22.2	ø 41.3
Minimum wall thickness	0.80	0.80	1.43

3D053171H

### NOTES

- These figures illustrate the rate of change in capacity of a standard indoor unit system at maximum load (with the thermostat set to maximum) under standard conditions. Moreover, under partial load conditions there is only a minor deviation from the rate of change in capacity shown in the above figures.
- With this outdoor unit, evaporating pressure constant control when cooling and condensing pressure constant control when heating is carried out.
- Method of calculating A/C (cooling/heating) capacity:  
The maximum A/C capacity of the system will be either the total A/C capacity of the indoor units obtained from capacity characteristic table or the maximum A/C capacity of outdoor units as mentioned below, whichever smaller.

Calculating A/C capacity of outdoor units.

- Condition: Indoor unit combination ratio does not exceed 100%.

$$\text{Maximum A/C capacity of outdoor units} = \text{A/C capacity of outdoor units obtained from capacity characteristic table at the 100\% combination} \times \text{Capacity change rate due to piping length to the farthest indoor unit}$$

- Condition: Indoor unit combination ratio exceeds 100%.

$$\text{Maximum A/C capacity of outdoor units} = \text{A/C capacity of outdoor units obtained from capacity characteristic table at the combination} \times \text{Capacity change rate due to piping length to the farthest indoor unit}$$

- When overall equivalent pipe length is 90m or more, the diameter of the main gas and liquid pipes (outdoor unit-branch sections) must be increased. When level difference is 50m or more, the diameter of the main liquid pipe (outdoor unit-branch sections) must be increased.

[ Diameter of above case ]

Model	Gas	Liquid
RQYQ46P	Not increased	ø 22.2

- Read cooling/heating capacity rate of change in the above figures based on the following equivalent length.

$$\text{Overall equivalent length} = (\text{Equivalent length to main pipe}) \times \text{Correction factor} + (\text{Equivalent length after branching})$$

Choose a correction factor from the following table.

- When cooling capacity is calculated: gas pipe size
- When heating capacity is calculated: liquid pipe size

Rate of change (object piping)	Correction factor	
	Standard size	Size increase
Cooling (gas pipe)	1.0	0.4
Heating (liquid pipe)	1.0	

(example) In case of RXYQ32P

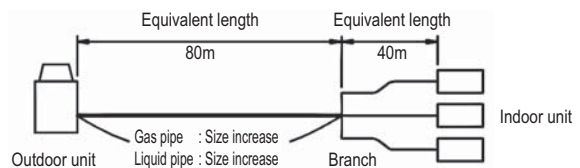

In the above case  
 (Cooling) Overall equivalent length = 80m x 1.0 + 40m = 120m  
 (Heating) Overall equivalent length = 80m x 0.4 + 40m = 72m  
 The rate of change in cooling capacity when Hp = 0m is thus approximately 0.82  
 heating capacity when Hp = 0m is thus approximately 1.0

# 5 Capacity tables

## 5 - 3 Capacity Correction Factor

5

### RQYQ48P

1. Rate of change in cooling capacity

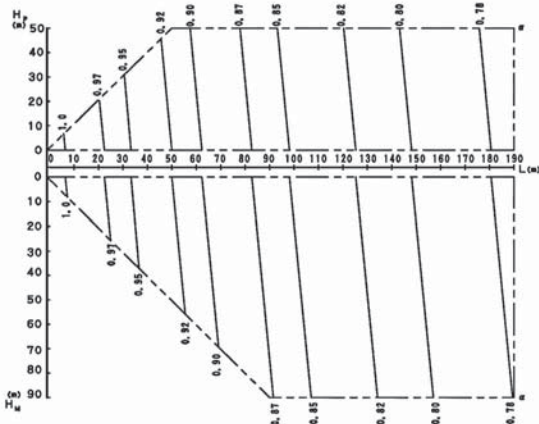

[ Diameter of the main pipes (standard size) ]

Model	Gas	Liquid
RQYQ48P	ø 41.3	ø 19.1

2. Rate of change in heating capacity

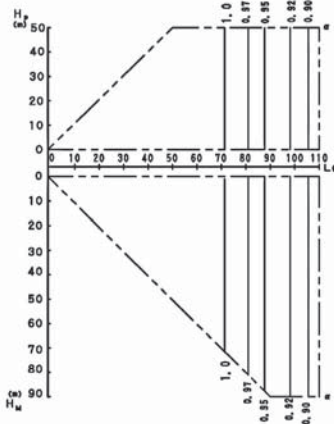

[ Explanation of symbols ]

- Hp: Level difference (m) between indoor and outdoor units where indoor unit in inferior position
- Hm: Level difference (m) between indoor and outdoor units where indoor unit in superior position
- L: Equivalent pipe length (m)
- α: Rate of change in cooling/heating capacity

[ Temper grade and thickness ]

Temper grade	1/2 H Type		
	ø 19.1	ø 22.2	ø 41.3
Outer diameter	ø 19.1	ø 22.2	ø 41.3
Minimum wall thickness	0.80	0.80	1.43

3D053172H

### NOTES

- These figures illustrate the rate of change in capacity of a standard indoor unit system at maximum load (with the thermostat set to maximum) under standard conditions. Moreover, under partial load conditions there is only a minor deviation from the rate of change in capacity shown in the above figures.
- With this outdoor unit, evaporating pressure constant control when cooling and condensing pressure constant control when heating is carried out.
- Method of calculating A/C (cooling/heating) capacity:  
The maximum A/C capacity of the system will be either the total A/C capacity of the indoor units obtained from capacity characteristic table or the maximum A/C capacity of outdoor units as mentioned below, whichever smaller.

Calculating A/C capacity of outdoor units.

- Condition: Indoor unit combination ratio does not exceed 100%.

$$\text{Maximum A/C capacity of outdoor units} = \text{A/C capacity of outdoor units obtained from capacity characteristic table at the 100\% combination} \times \text{Capacity change rate due to piping length to the farthest indoor unit}$$

- Condition: Indoor unit combination ratio exceeds 100%.

$$\text{Maximum A/C capacity of outdoor units} = \text{A/C capacity of outdoor units obtained from capacity characteristic table at the combination} \times \text{Capacity change rate due to piping length to the farthest indoor unit}$$

- When overall equivalent pipe length is 90m or more, the diameter of the main gas and liquid pipes (outdoor unit-branch sections) must be increased. When level difference is 50m or more, the diameter of the main liquid pipe (outdoor unit-branch sections) must be increased.

[ Diameter of above case ]

Model	Gas	Liquid
RQYQ48P	Not increased	ø 22.2

- Read cooling/heating capacity rate of change in the above figures based on the following equivalent length.

$$\text{Overall equivalent length} = (\text{Equivalent length to main pipe}) \times \text{Correction factor} + (\text{Equivalent length after branching})$$

Choose a correction factor from the following table.

[ When cooling capacity is calculated: gas pipe size  
When heating capacity is calculated: liquid pipe size ]

Rate of change (object piping)	Correction factor	
	Standard size	Size increase
Cooling (gas pipe)	1.0	0.4
Heating (liquid pipe)	1.0	

(example)

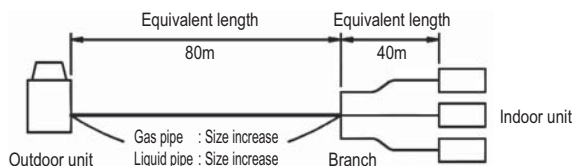

In the above case (Cooling) Overall equivalent length = 80m x 1.0 + 40m = 120m  
(Heating) Overall equivalent length = 80m x 0.4 + 40m = 72m  
The rate of change in cooling capacity when Hp = 0m is thus approximately 0.82  
heating capacity when Hp = 0m is thus approximately 0.99

# 6 Dimensional drawings

## 6 - 1 Dimensional Drawings

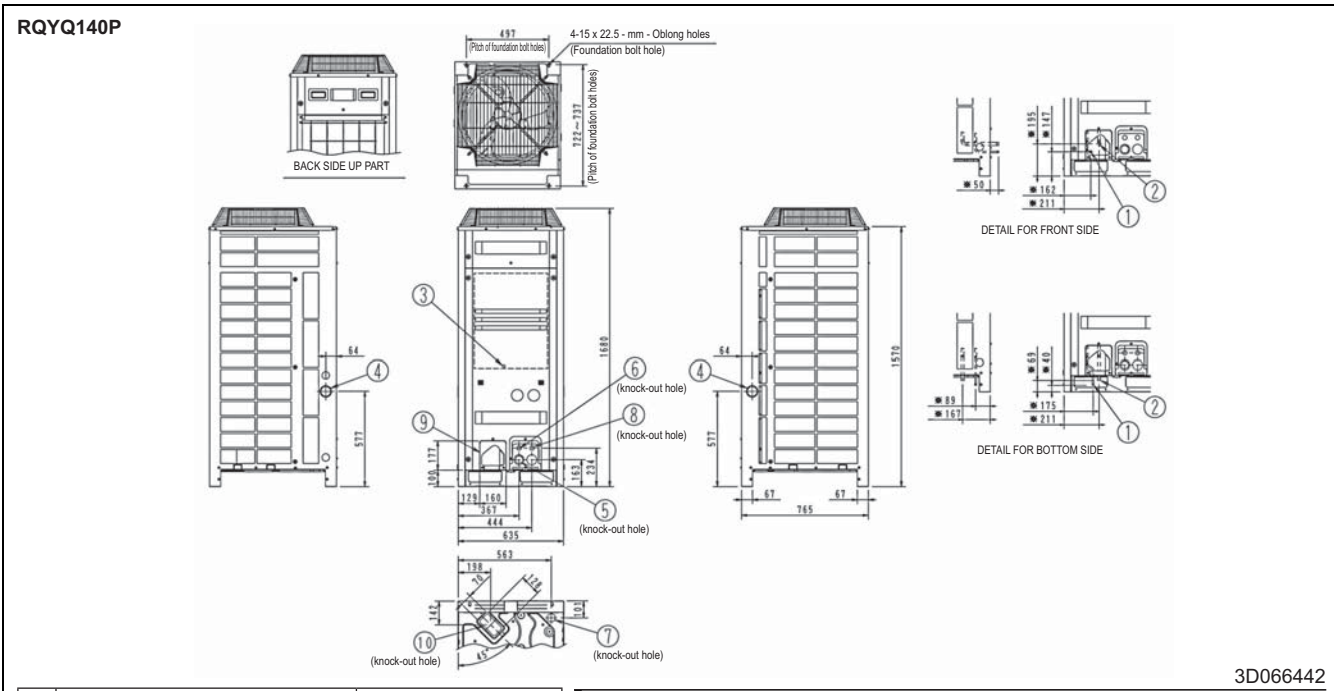

3D066442

No.	Parts name	Remarks
1	Liquid pipe connection port	ø9.5 Brazing connection
2	Gas pipe connection port	See note 3.
3	Grounding terminal	Inside of switch box (M8)
4	Power cord routing hole (side)	ø62
5	Power cord routing hole (front)	ø45
6	Power cord routing hole (front)	ø27
7	Power cord routing hole (bottom)	ø50
8	Wire routing hole (front)	ø27
9	Pipe routing hole (front)	See note 2.
10	Pipe routing hole (bottom)	See note 2.

- NOTES**
- ✳ shows the dimensions after fixing the accessory pipes.
  - For piping connection method (front and bottom sides) see the installation manual.
  - Gas pipe  
ø15.9 Brazing connection: RQYQ140P

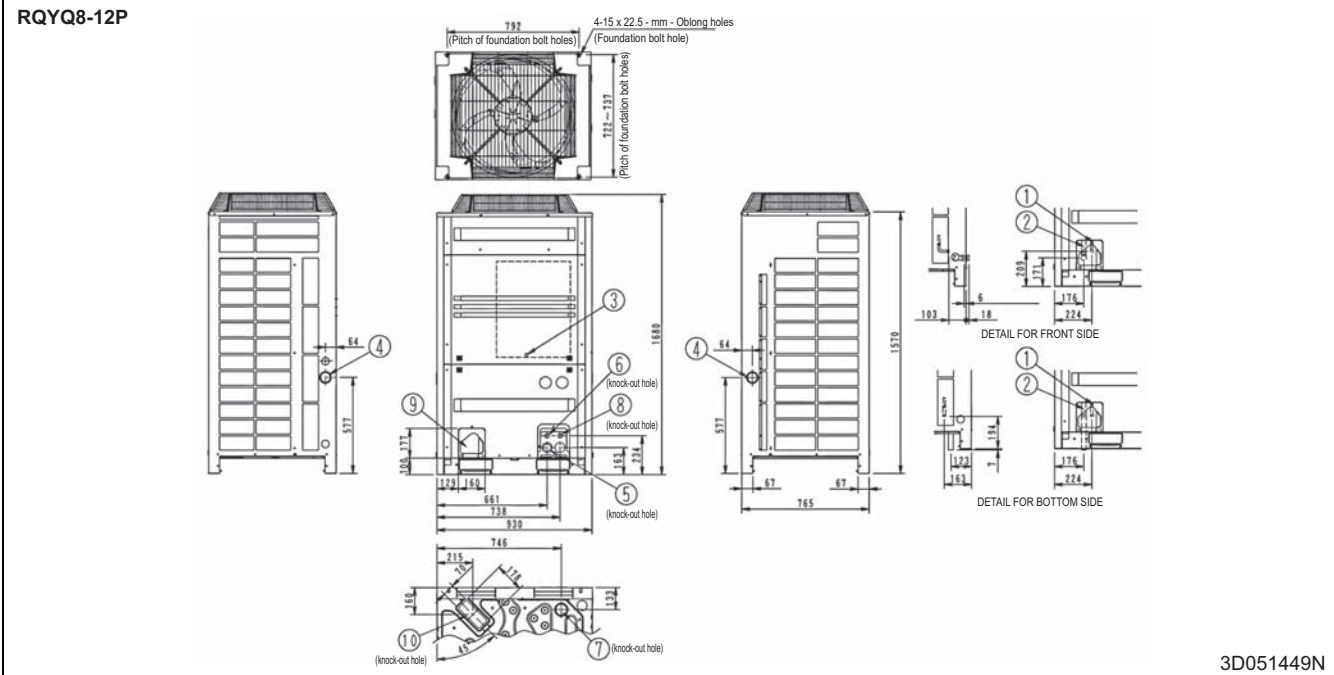

3D051449N

No.	Parts name	Remarks
1	Liquid pipe connection port	See note 3
2	Gas pipe connection port	See note 2
3	Grounding terminal	Inside of switch box (M8)
4	Power cord routing hole (side)	ø62
5	Power cord routing hole (front)	ø45
6	Power cord routing hole (front)	ø27
7	Power cord routing hole (bottom)	ø65.5
8	Wire routing hole (front)	ø27
9	Pipe routing hole (front)	
10	Pipe routing hole (bottom)	

- NOTES**
- Detail for front side and detail for bottom side indicate the dimensions after fixing the attached piping.
  - Gas pipe (Heat pump type)  
ø19.1 Brazing connection: RQYQ8P  
ø22.2 Brazing connection: RQYQ10P  
ø28.6 Brazing connection: RQYQ12P
  - Liquid pipe (Heat pump type)  
ø9.5 Brazing connection: RQYQ8-10P  
ø12.7 Brazing connection: RQYQ12P

# 6 Dimensional drawings

## 6 - 1 Dimensional Drawings

6

**RQYQ14-16P**

1102 (Pitch of foundation bolt holes)  
4-15 x 22.5 - mm - Oblong holes (Foundation bolt hole)  
Pitch of foundation bolt holes  
Pitch of foundation bolt holes  
131 - 131  
64  
577  
100, 131  
172, 160, 932, 1849, 1240  
162, 234  
1860  
67, 765, 67  
1570  
64  
4  
6  
8  
5  
3  
9  
10  
7  
1056  
213  
15  
134  
15  
132  
10  
7  
DETAIL FOR FRONT SIDE  
DETAIL FOR BOTTOM SIDE

No.	Parts name	Remarks
1	Liquid pipe connection port	See note 3.
2	Gas pipe connection port	See note 2.
3	Grounding terminal	Inside of switch box (M8)
4	Power cord routing hole (side)	ø62
5	Power cord routing hole (front)	ø45
6	Power cord routing hole (front)	ø27
7	Power cord routing hole (bottom)	ø65.5
8	Wire routing hole (front)	ø27
9	Pipe routing hole (front)	
10	Pipe routing hole (bottom)	

**NOTES**

- Detail for front side and detail for bottom side indicate the dimensions after fixing the attached piping.
- Gas pipe (Heat pump type)  
ø28.6 Brazing connection: RQYQ14-16P
- Liquid pipe (Heat pump type)  
ø12.7 Brazing connection: RQYQ14-16P

AA	Model name	AB	Model name	AC	Model name
83	RQYQ14-16P	211	RQYQ14-16P	179	RQYQ14-16P

3D051450P



## 6 Dimensional drawings

### 6 - 2 Dimensional Drawings with Accessories

RQYQ8-12P

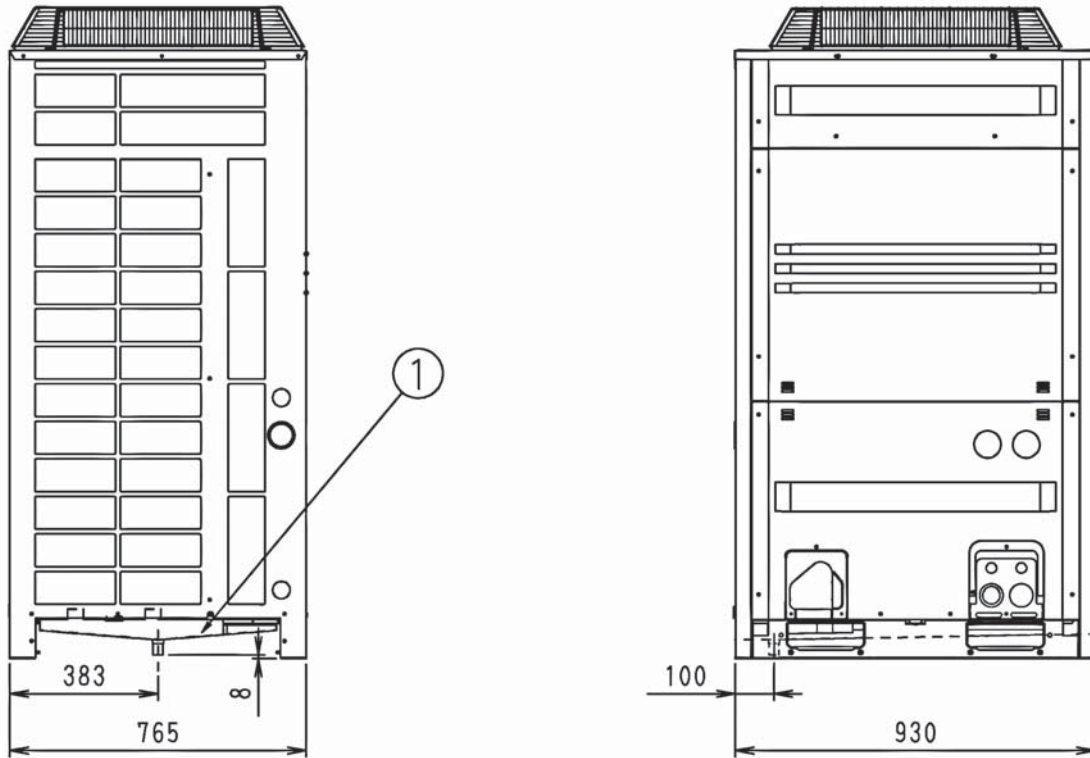

3D052254P

RQYQ14-16P

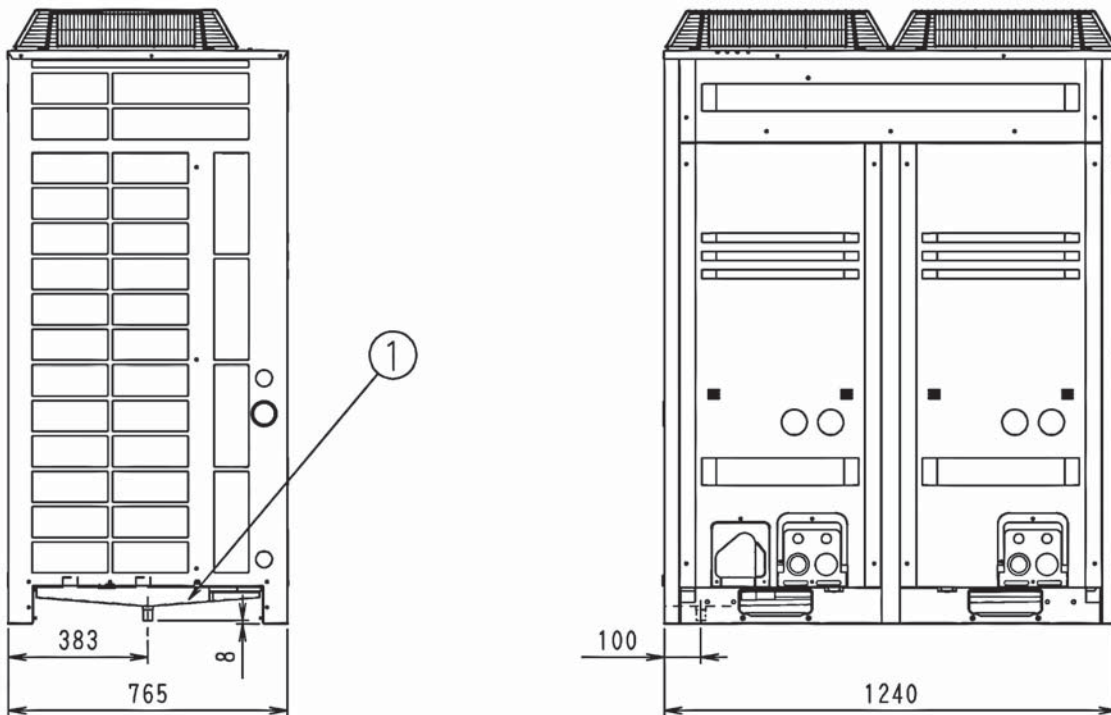

3D052255P

# 7 Centre of gravity

## 7 - 1 Centre of Gravity

7

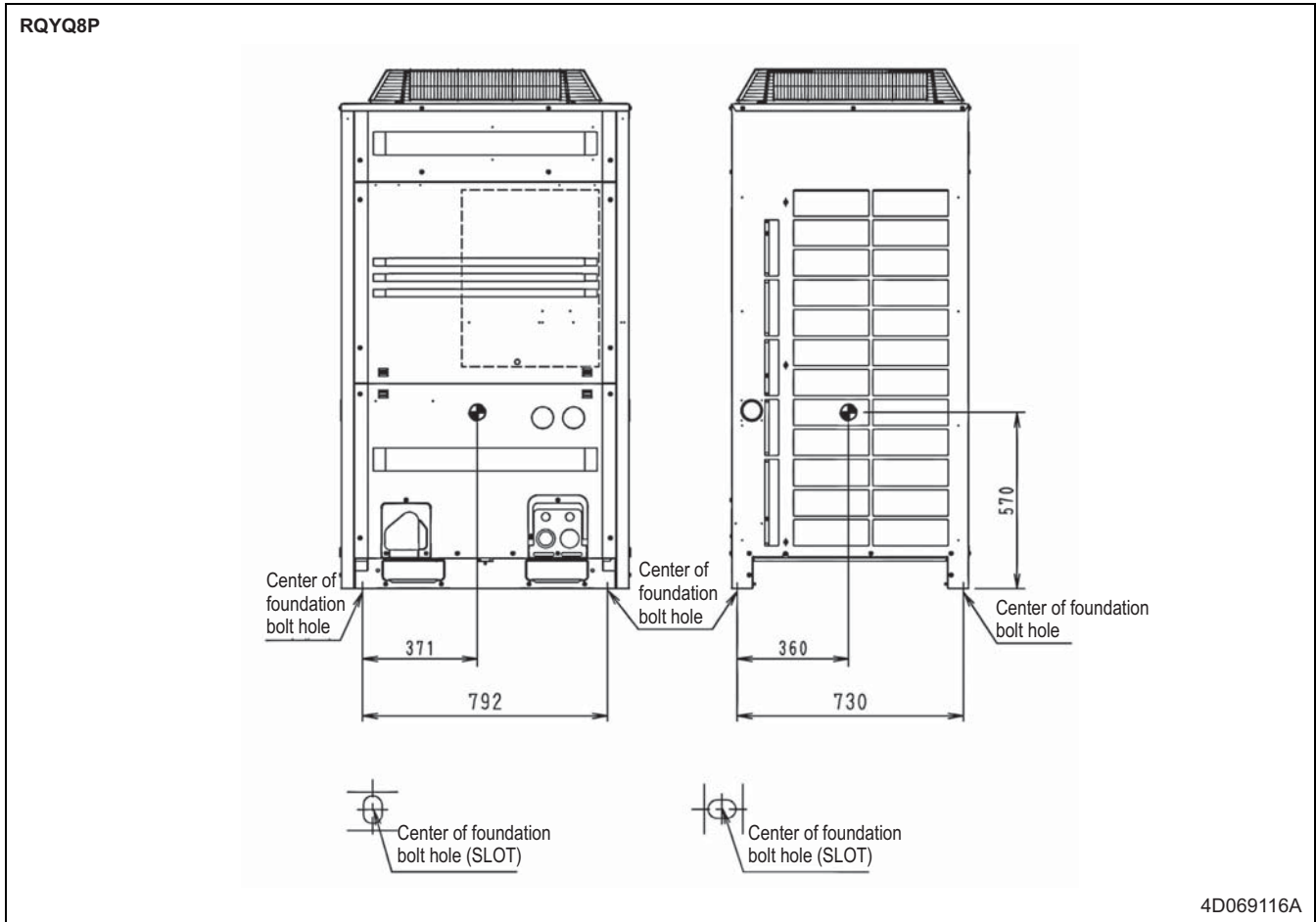
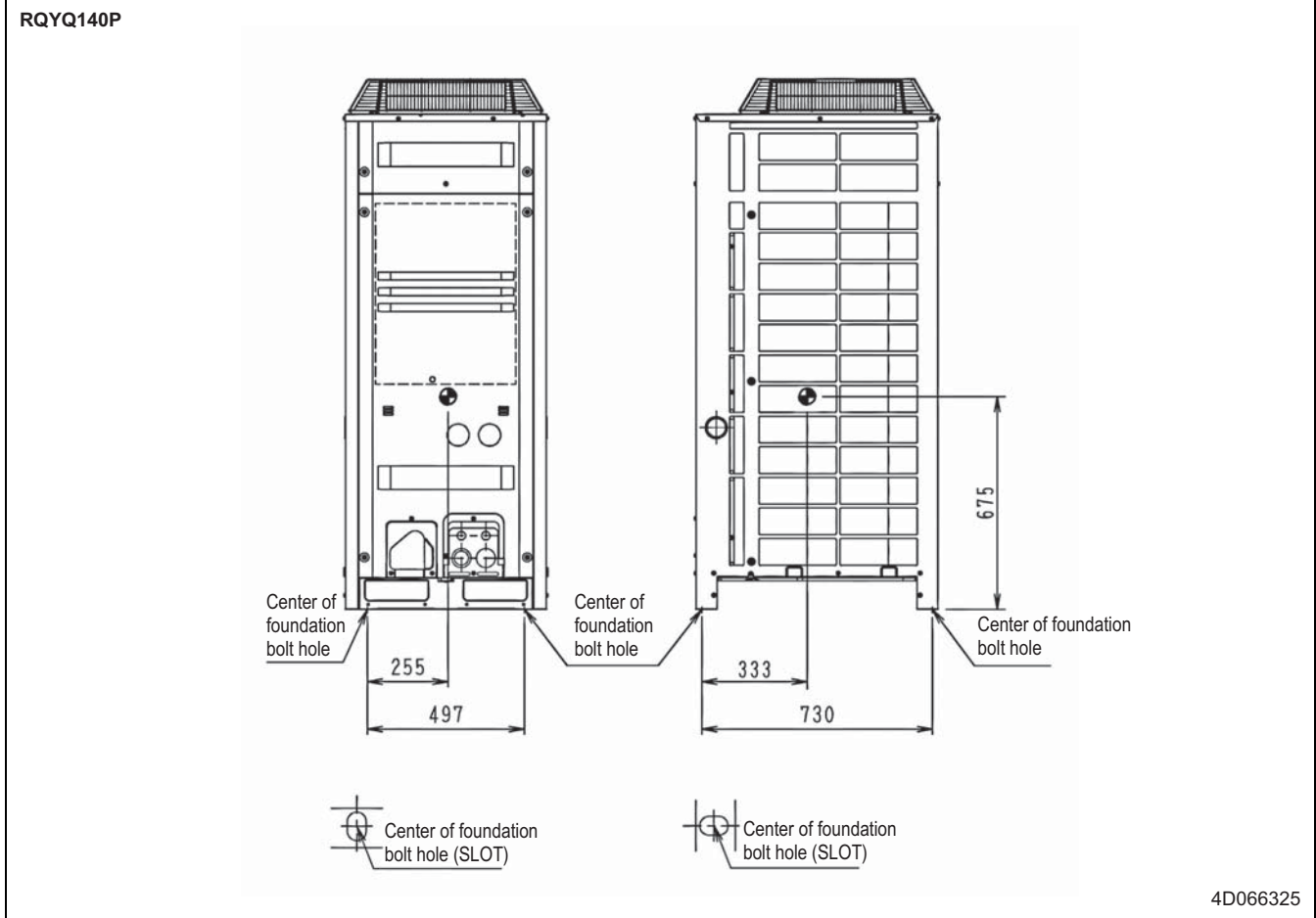

# 7 Centre of gravity

## 7 - 1 Centre of Gravity

RQYQ10-12P

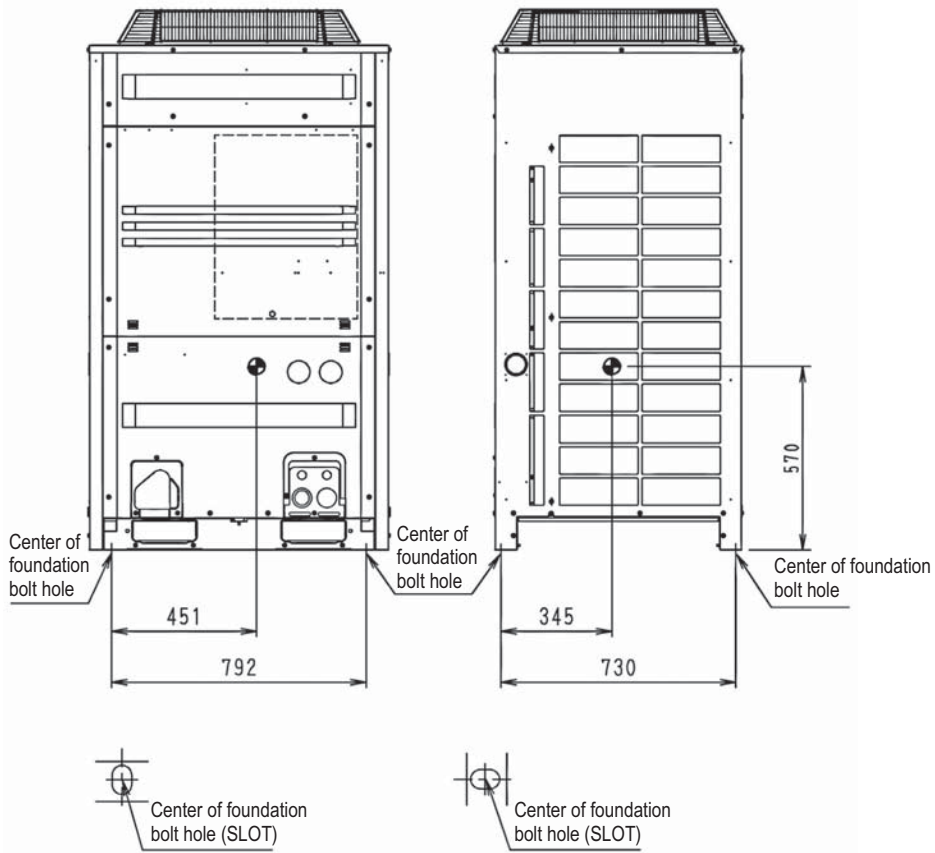

4D069111A

RQYQ14-16P

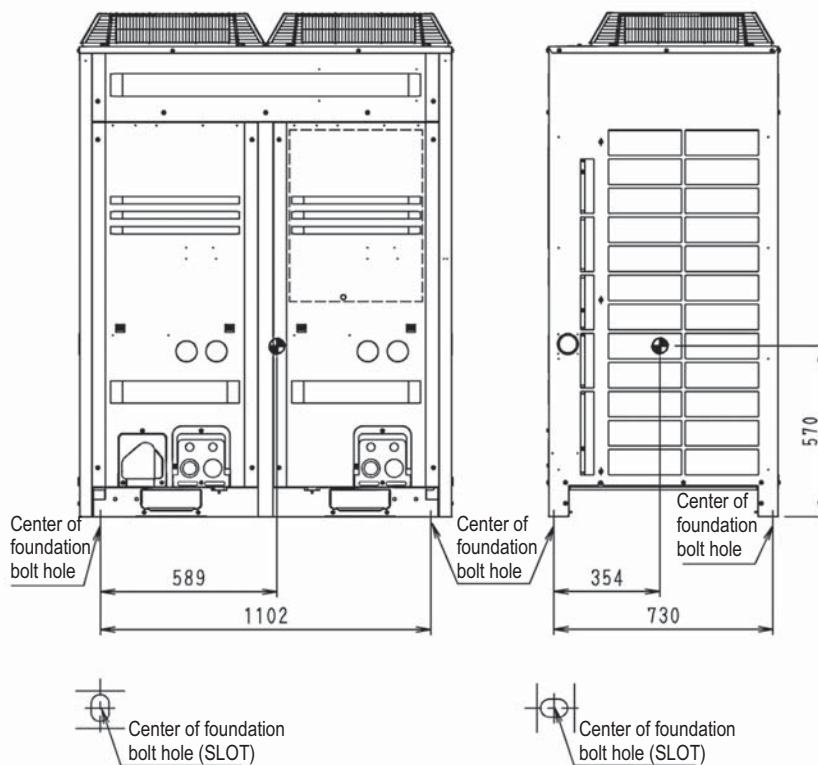

4D069112A

# 8 Piping diagrams

## 8 - 1 Piping Diagrams

8

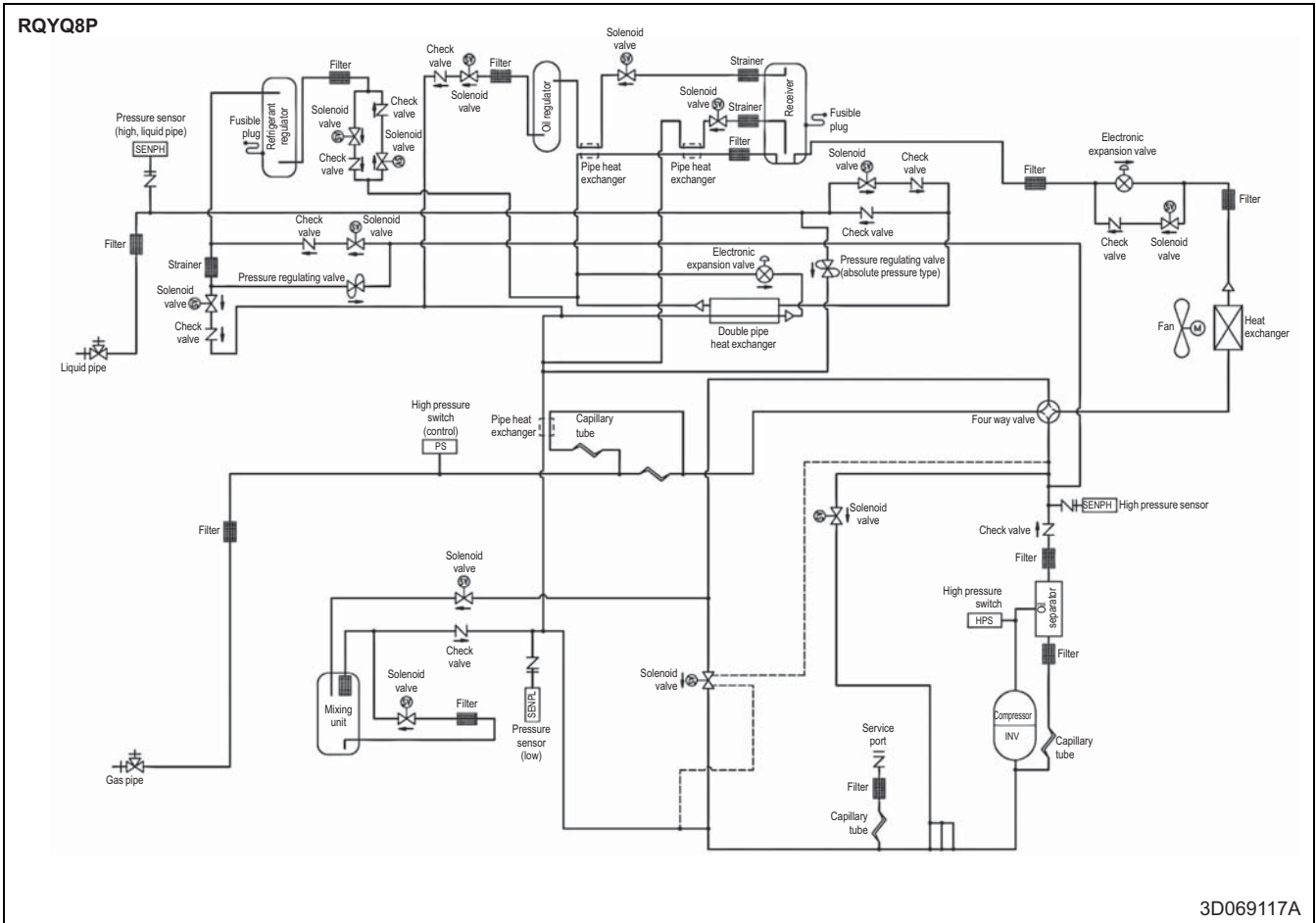
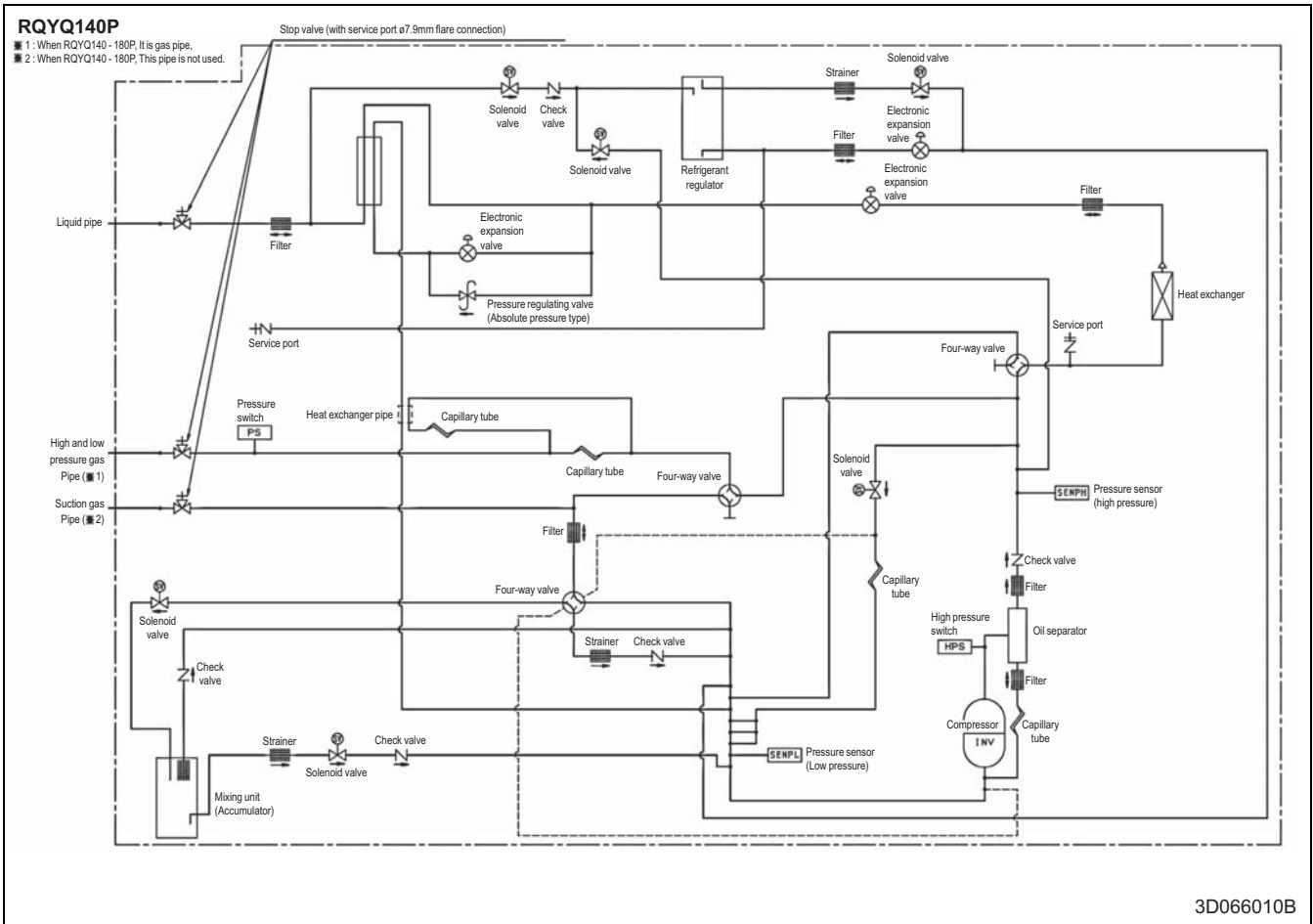

# 8 Piping diagrams

## 8 - 1 Piping Diagrams

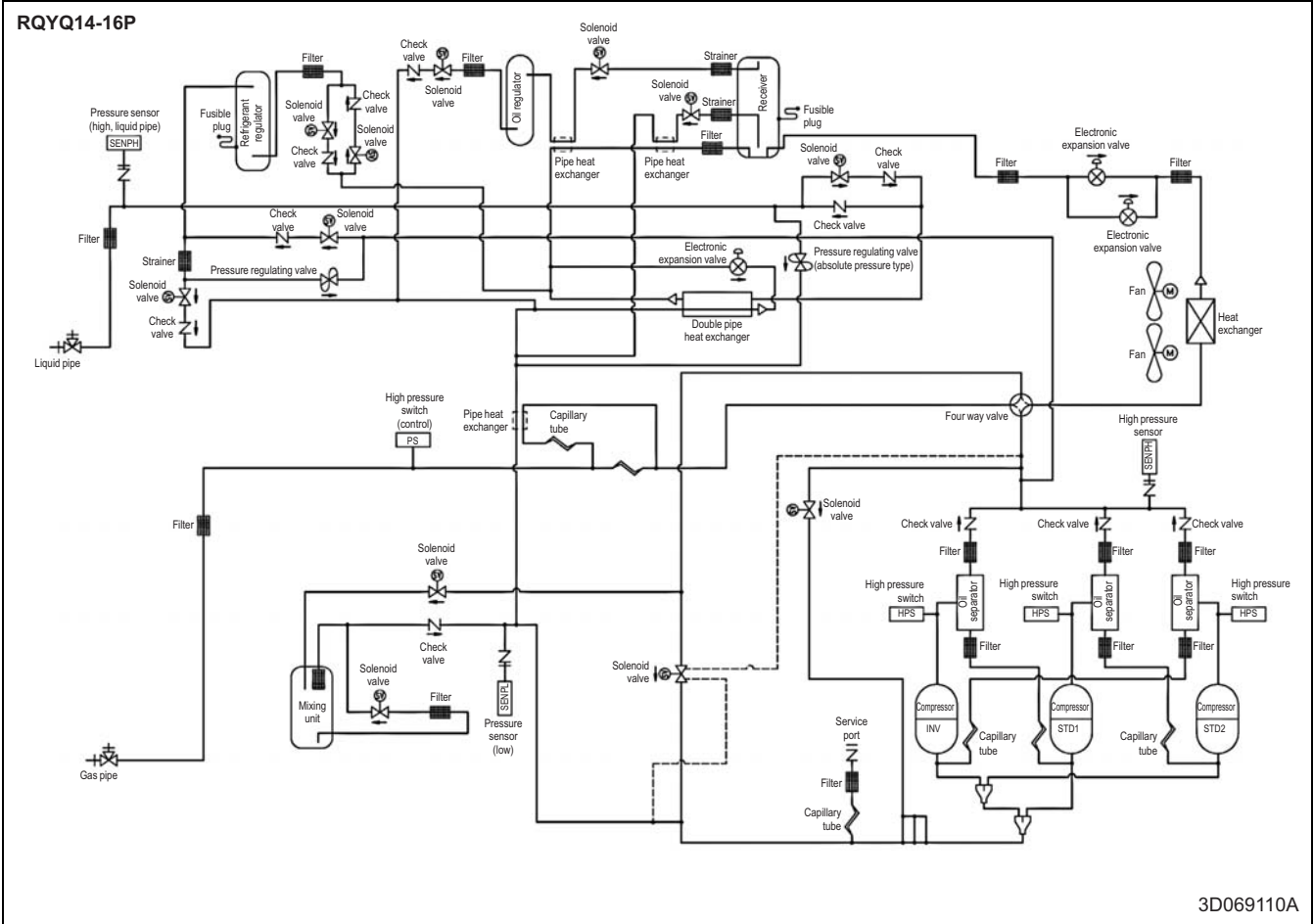
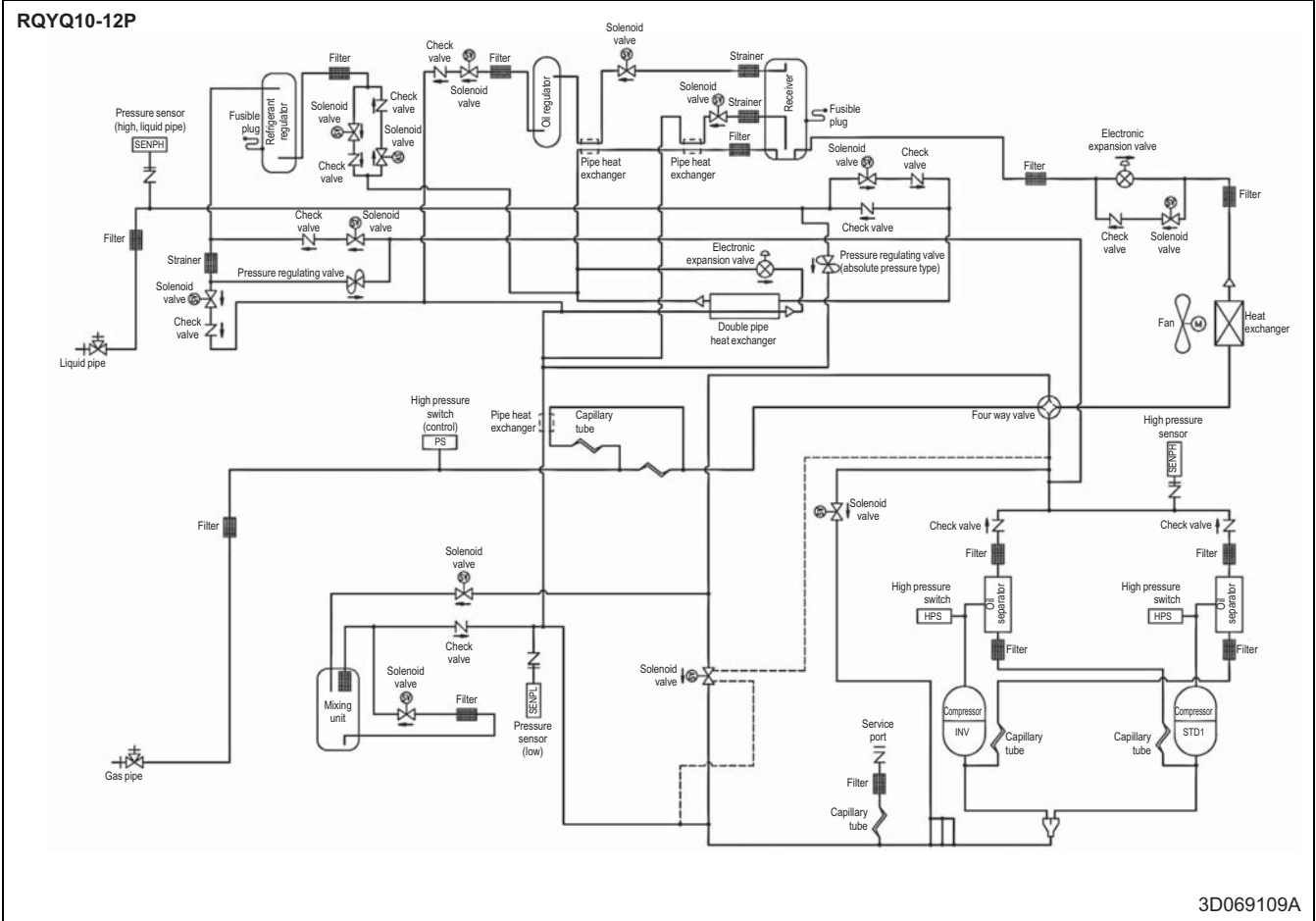



# 9 Wiring diagrams

## 9 - 1 Wiring Diagrams - Three Phase

RQYQ140P

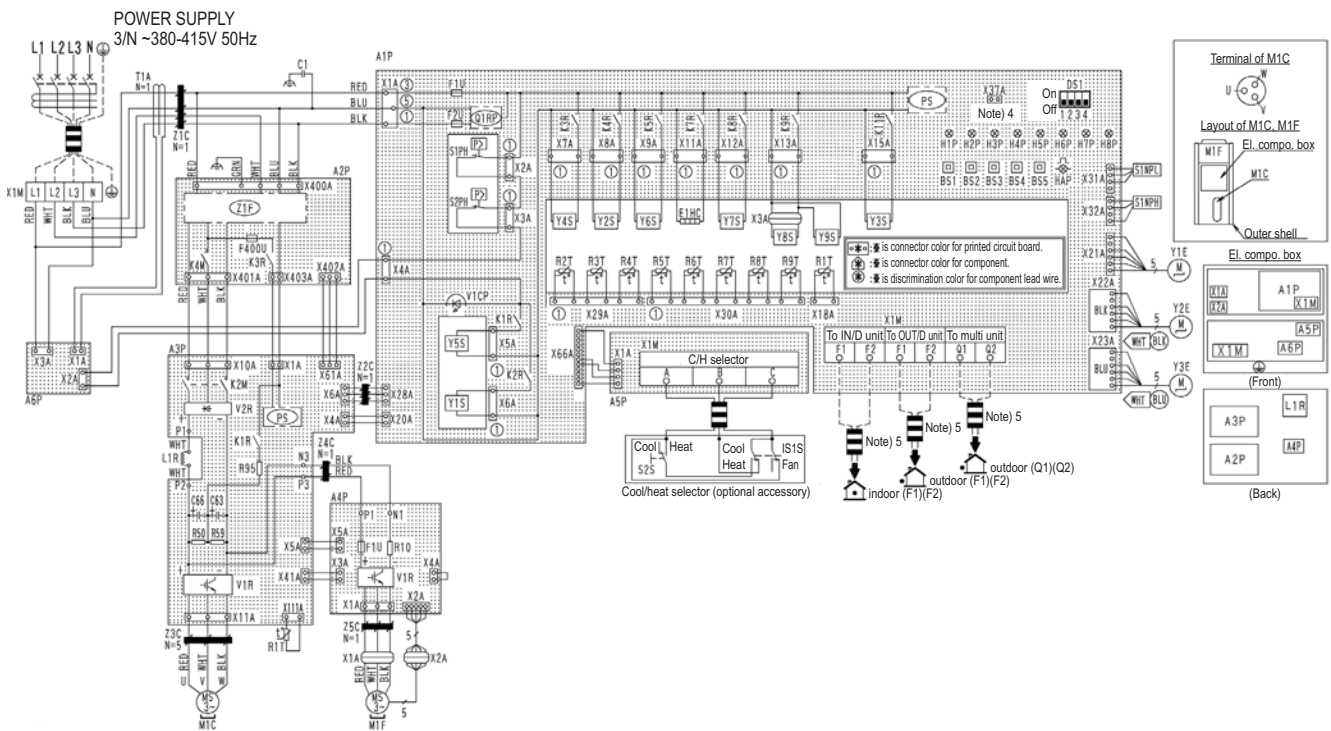

A1P	Printed circuit board (main)	K5R	Magnetic relay (Y6S)	T1A	Current sensor (A6P)
A2P	Printed circuit board (noise filter)	K7R	Magnetic relay (E1HC)	V1CP	Safety devices input
A3P	Printed circuit board (INV)	K8R	Magnetic relay (Y7S)	V1R	Power module (A3P, A4P)
A4P	Printed circuit board (fan)	K9R	Magnetic relay (Y8S, Y9S)	V2R	Diode bridge (A3P)
A5P	Printed circuit board (ABC I/P)	K11R	Magnetic relay (Y3S)	X1A, X2A	Connector (M1F)
A6P	Printed circuit board (sub)	L1R	Reactor	X3A	Relaying connector (Y8S)
BS1~5	Push button switch (mode, set, return, test, reset)	M1C	Motor (compressor)	X1M	Terminal strip (power supply)
		M1F	Motor (fan)	X1M	Terminal strip (control) (A1P)
C1	Capacitor	PS	Switching power supply (A1P, A3P)	X1M	Terminal strip (ABC I/P) (A5P)
C63, C66	Capacitor	Q1RP	Phase reversal detect circuit (A1P)	Y1E	Electronic expansion valve (main)
DS1	Dip switch	R10	Resistor (current sensor) (A4P)	Y2E	Electronic expansion valve (charge)
E1HC	Crankcase heater	R50, R59	Resistor (A3P)	Y3E	Electronic expansion valve (subcool)
F1U	Fuse (8A, DC650V) (A4P)	R95	Resistor (current limiting) (A3P)	Y1S	Solenoid valve (refrigerant regulator hot gas)
F1U, F2U	Fuse (T, 3, 15A, 250V) (A1P)	R1T	Thermistor (air) (A1P)	Y2S	Solenoid valve (refrigerant regulator liquid pipe)
F400U	Fuse (T, 6, 3A, 250V) (A2P)	R1T	Thermistor (fin) (A3P)	Y3S	Solenoid valve (refrigerant regulator gas purge pipe)
H1P~8P	Pilotlamp (service monitor-orange) [H2P] prepare, test ----- flickering malfunction detection ----- light up	R2T	Thermistor (M1C discharge)	Y4S	Solenoid valve (hot gas)
		R3T	Thermistor (heat exc. liquid)	Y5S	Solenoid valve (oil)
		R4T	Thermistor (heat exc. gas pipe)	Y6S	Solenoid valve (4 way valve - heat exc.)
HAP	Pilotlamp (service monitor-green)	R5T	Thermistor (suction)	Y7S	Solenoid valve (4 way valve - piping)
K1R	Magnetic relay (A3P)	R6T	Thermistor (heat exc. deicer)	Y8S	Solenoid valve (4 way valve - mix)
K3R	Magnetic relay (A2P)	R7T	Thermistor (subcooling gas)	Y9S	Solenoid valve (mix in)
K2M	Magnetic contactor (M1C) (A3P)	R8T	Thermistor (subcooling liquid)	Z1C~5C	Noise filter (ferrite core)
K4M	Magnetic contactor (M1C) (A2P)	R9T	Thermistor (liquid)	Z1F	Noise filter (with surge absorber)
K1R	Magnetic relay (Y5S)	S1NPH	Pressure sensor (high)		
K2R	Magnetic relay (Y1S)	S1NPL	Pressure sensor (low)		Cool/heat selector
K3R	Magnetic relay (Y4S)	S1PH	Pressure switch (high)	S1S	Selector switch (fan/cool + heat)
K4R	Magnetic relay (Y2S)	S2PH	Pressure switch (high)	S2S	Selector switch (cool/heat)

3D066011D

### NOTES

- This wiring diagram is applied only to the outdoor unit.
- : field wiring
- : terminal strip, : connector, : terminal, : protective earth (screw)
- When using the optional adapter, refer to the installation manual of the optional adapter.
- For connection wiring to indoor-outdoor transmission F1 - F2, outdoor-outdoor transmission F1 - F2, refer to the installation manual.
- How to use BS1~5 and DS1 switch, refer to "service precaution" label on el. compo. box cover.
- When operating, don't shortcircuit the protection device (S1PH, S2PH).
- Colors BLK: black RED: red BLU: blue WHT: white PNK: pink YLW: yellow BRN: brown GRY: gray GRN: green ORG: orange.

# 9 Wiring diagrams

## 9 - 1 Wiring Diagrams - Three Phase

RQYQ8P

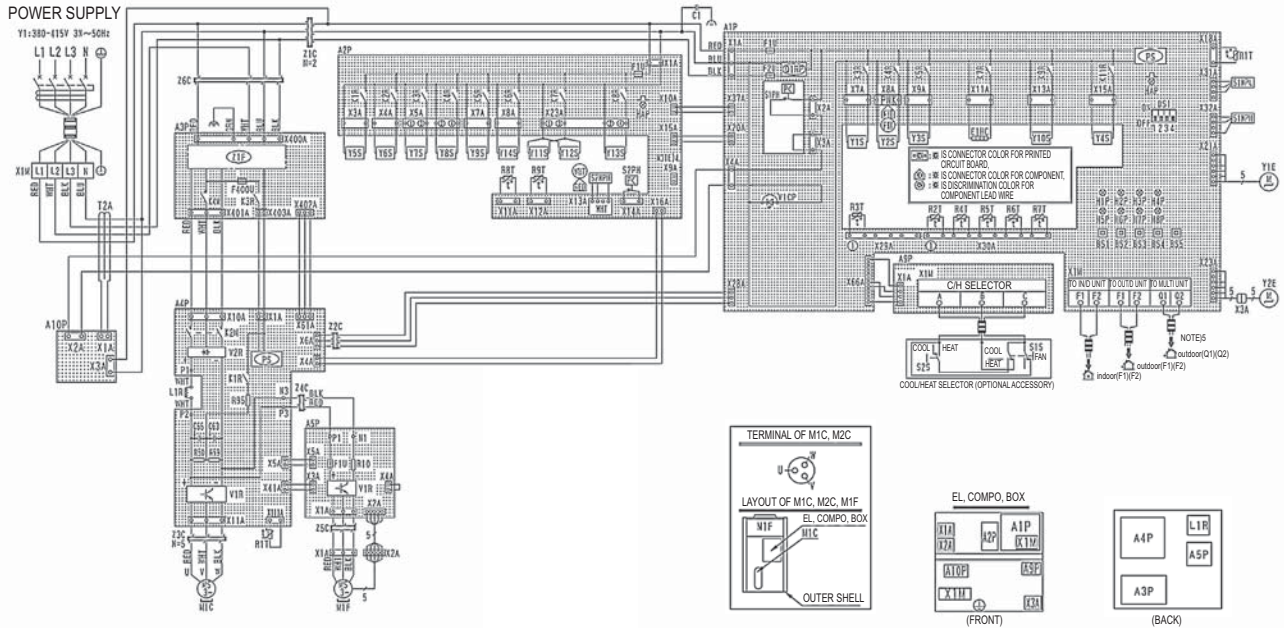

L1-RED	L2-WHT	L3-BLK	N-BLU			
A1P	Printed circuit board (main)					
A2P	Printed circuit board (sub)			K5R	Magnetic relay (Y9S) (A2P)	V1CP
A3P	Printed circuit board (noise filter)			K6R	Magnetic relay (4S) (A2P)	V1R
A4P	Printed circuit board (inv)			K7R	Magnetic relay (E1HC) (A1P)	V2R
A5P	Printed circuit board (fan)			K7R	Magnetic relay (1S, 2S) (A2P)	X1A, X2A
A9P	Printed circuit board (abc I/P)			K8R	Magnetic relay (3S) (A2P)	X3A
A10P	Printed circuit board (sub)			K9R	Magnetic relay (0S) (A1P)	X1M
BS1~5	Push button switch (mode, set, return, test, reset)			K11R	Magnetic relay (Y4S) (A1P)	X1M
C1	Capacitor			L1R	Reactor	X1M
C63, C66	Capacitor			M1C	Motor (compressor)	E
DS1	Dip switch			M1F	Motor (fan)	E
E1HC	Crankcase heater			PS	Switching power supply (A1P, A4P)	S
F1U	Fuse (T, 3, 15A, 250V) (A2P)			Q1RP	Phase reversal detect circuit	Y2S
F1U	Fuse (8A, DC650V) (A5P)			R10	Resistor (current sensor) (A5P)	Y3S
F1U, F2U	Fuse (T, 3, 15A, 250V) (A1P)			R50, R59	Resistor	Y4S
F400U	Fuse (T, 6, 3A, 250V) (A3P)			R95	Resistor (current limiting)	Y5S
H1P~8P	Pilotlamp (service monitor-orange) [H2P] Prepare, test ----- flickering Malfunction detection ----- light up			R1T	Thermistor (air) (A1P)	Y6S
HAP	Pilotlamp (service monitor-green)			R1T	Thermistor (fin) (A4P)	Y7S
K2M	Magnetic contactor (M1C) (A4P)			R2T	Thermistor (receiver)	Y8S
K4M	Magnetic contactor (M1C) (A3P)			R3T	Thermistor (M1C discharge)	Y9S
K1R	Magnetic relay (Y5S) (A2P)			R4T	Thermistor (ref, liq)	0S
K1R	Magnetic relay (A4P)			R5T	Thermistor (heat exc, outlet)	1S
K2R	Magnetic contactor (Y6S) (A2P)			R6T	Thermistor (liq, pipe)	2S
K3R	Magnetic relay (S) (A1P)			R7T	Thermistor (ref, gas out)	3S
K3R	Magnetic relay (Y7S) (A2P)			R8T	Thermistor (suction)	4S
K3R	Magnetic relay (A3P)			R9T	Thermistor (heat exc, deicer)	Z1C~6C
K4R	Magnetic relay (Y2S) (A1P)			S1NPH	Pressure sensor (high)	Z1F
K4R	Magnetic relay (Y8S) (A2P)			S1NPL	Pressure sensor (low)	Connector for optional parts
K5R	Magnetic relay (Y3S) (A1P)			S2NPH	Pressure sensor (high liq)	X9A
				S1PH	Pressure switch (high)	Cool/heat selector
				S2PH	Pressure switch (control)	S1S
				T2A	Current sensor (A10P)	S2S
						Selector switch (cool/heat)

3D070293B

**NOTES**

- This wiring diagram is applied only to the outdoor unit.
- Field wiring: Terminal strip: Connector: Terminal: Protective earth (screw):
- When using the optional adapter, refer to the installation manual of the optional adapter.
- For connection wiring to indoor-outdoor transmission F1 • F2, outdoor-outdoor transmission F1 • F2, outdoor-multi transmission Q1 • Q2, refer to the installation manual.
- How to use BS1~5 and DS1 switch, refer to "service precaution" label on el. compo. box, lid.
- When operating, don't shortcircuit the protection device (S1PH).
- Colors BLK: black RED: red BLU: blue WHT: white PNK: pink YLW: Yellow BRN: brown GRY: gray GRN: green ORG: orange

# 9 Wiring diagrams

## 9 - 1 Wiring Diagrams - Three Phase

### RQYQ10-12P

#### POWER SUPPLY

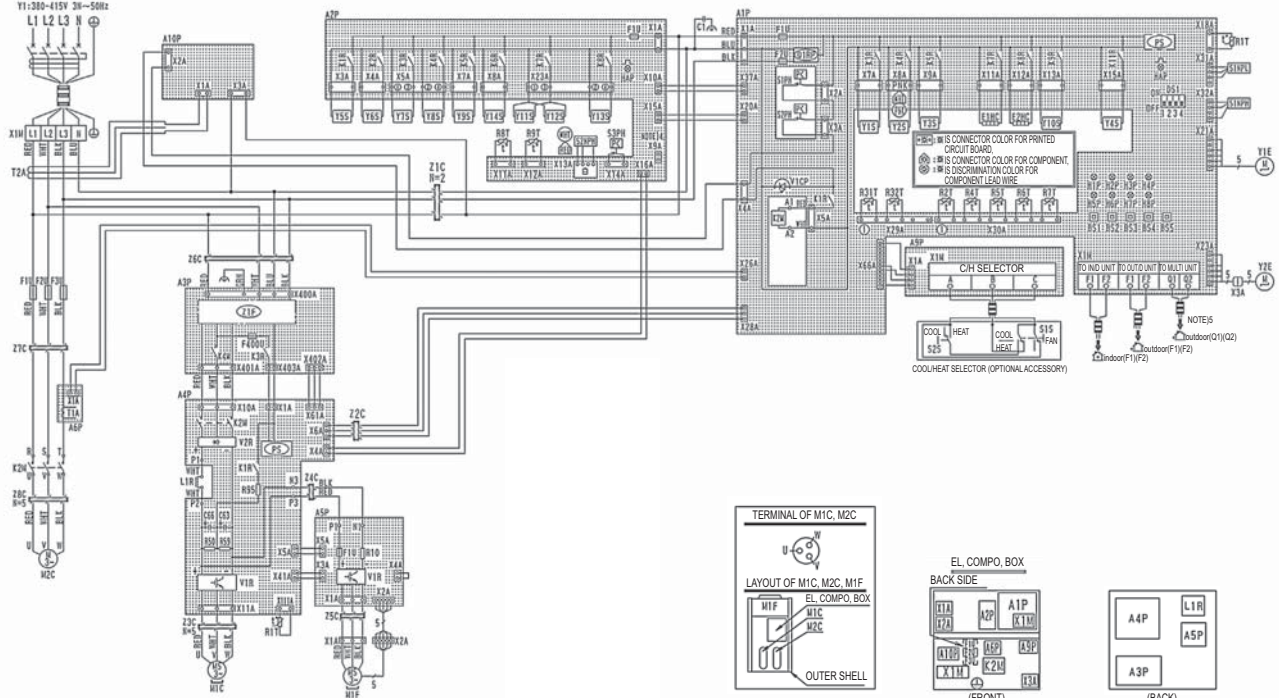

L1-RED	L2-WHT	L3-BLK	N-BLU				
A1P	Printed circuit board (main)						
A2P	Printed circuit board (sub)			K4R	Magnetic relay (Y8S) (A2P)	T1A	Current sensor (A6P)
A3P	Printed circuit board (noise filter)			K5R	Magnetic relay (Y3S) (A1P)	T2A	Current sensor (A10P)
A4P	Printed circuit board (inv)			K5R	Magnetic relay (Y9S) (A2P)	V1CP	Safety devices input (A1P)
A5P	Printed circuit board (fan)			K6R	Magnetic relay (4S) (A2P)	V1R	Power module (A4P, A5P)
A6P	Printed circuit board (current sensor)			K7R	Magnetic relay (E1HC) (A1P)	V2R	Diode bridge (A4P)
A9P	Printed circuit board (abc I/P)			K7R	Magnetic relay (1S, 2S) (A2P)	X1A, X2A	Connector (M1F)
A10P	Printed circuit board (sub)			K8R	Magnetic relay (E2HC) (A1P)	X3A	Relaying connector (Y2E)
BS1-5	Push button switch (mode, set, return, test, reset)			K8R	Magnetic relay (3S) (A2P)	X1M	Terminal strip (power supply)
C1	Capacitor			K9R	Magnetic relay (0S) (A1P)	X1M	Terminal strip (control) (A1P)
C63, C66	Capacitor			K11R	Magnetic relay (Y4S) (A1P)	X1M	Terminal strip (abc I/P) (A9P)
DS1	Dip switch			L1R	Reactor	E	Electronic expansion valve (main)
E1HC, E2HC	Crankcase heater			M1C	Motor (compressor)	Y2E	Electronic expansion valve (subcool)
F1U	Fuse (T, 3, 15A, 250V) (A2P)			M1F	Motor (fan)	S	Solenoid valve (hot gas)
F1U	Fuse (8A, DC650V) (A5P)			PS	Switching power supply (A1P, A4P)	Y2S	Solenoid valve (oil)
F1U, F2U	Fuse (T, 3, 15A, 250V) (A1P)			Q1RP	Phase reversal detect circuit	Y3S	Solenoid valve (4 way valve)
F1U-F3U	Fuse			R10	Resistor (current sensor) (A5P)	Y4S	Solenoid valve (mix in)
F400U	Fuse (T, 6, 3A, 250V) (A3P)			R50, R59	Resistor	Y5S	Solenoid valve (return oil)
H1P-BP	Pilotlamp (service monitor-orange) [H2P] Prepare, test ----- flickering Malfunction detection ----- light up			R95	Resistor (current limiting)	Y6S	Solenoid valve (liq, close)
HAP	Pilotlamp (service monitor-green)			R1T	Thermistor (air) (A1P)	Y7S	Solenoid valve (receiver liq)
K2M	Magnetic contactor (M1C) (A4P)			R1T	Thermistor (fin) (A4P)	Y8S	Solenoid valve (receiver gas)
K2M	Magnetic contactor (M2C)			R2T	Thermistor (receiver)	Y9S	Solenoid valve (oil out)
K4M	Magnetic contactor (M1C) (A3P)			R31T, R32T	Thermistor (M1C, M2C, discharge)	0S	Solenoid valve (main bypass)
K1R	Magnetic relay (K2M) (A1P)			R4T	Thermistor (ref, liq)	1S	Solenoid valve (ref, gas out)
K1R	Magnetic relay (Y5S) (A2P)			R5T	Thermistor (heat exc, outlet)	2S	Solenoid valve (ref, liq, in)
K1R	Magnetic relay (A4P)			R6T	Thermistor (liq, pipe)	3S	Solenoid valve (ref, gas in)
K2R	Magnetic relay (Y6S) (A2P)			R7T	Thermistor (ref, gas out)	4S	Solenoid valve (ref, liq out)
K3R	Magnetic relay (S) (A1P)			R8T	Thermistor (suction)	Z1C-6C	Noise filter (ferrite core)
K3R	Magnetic relay (Y7S) (A2P)			R9T	Thermistor (heat exc, deicer)	Z1F	Noise filter (with surge absorber)
K3R	Magnetic relay (A3P)			S1NPH	Pressure sensor (high)		Connector for optional parts
K4R	Magnetic relay (Y2S) (A1P)			S1NPL	Pressure sensor (low)	X9A	Power supply (Adapter) (A2P)
				S2NPH	Pressure sensor (high liq)		Cool/heat selector
				S1PH, S2PH	Pressure switch (high)	S1S	Selector switch (fan/cool + heat)
				S3PH	Pressure switch (control)	S2S	Selector switch (cool/heat)

3D070294A

#### NOTES

- This wiring diagram is applied only to the outdoor unit.
- Field wiring: Terminal strip: Connector: Terminal: Protective earth (screw):
- When using the optional adapter, refer to the installation manual of the optional adapter.
- For connection wiring to indoor-outdoor transmission F1 • F2, outdoor-outdoor transmission F1 • F2, outdoor-multi transmission Q1 • Q2, refer to the installation manual.
- How to use BS1-5 and DS1 switch, refer to "service precaution" label on el, compo, box, lid.
- When operating, don't shortcircuit the protection device (S1PH, S2PH).
- Colors BLK: black RED: red BLU: blue WHT: white PNK: pink YLW: Yellow BRN: brown GRY: gray GRN: green ORG: orange



# 9 Wiring diagrams

## 9 - 1 Wiring Diagrams - Three Phase

RQYQ14-16P

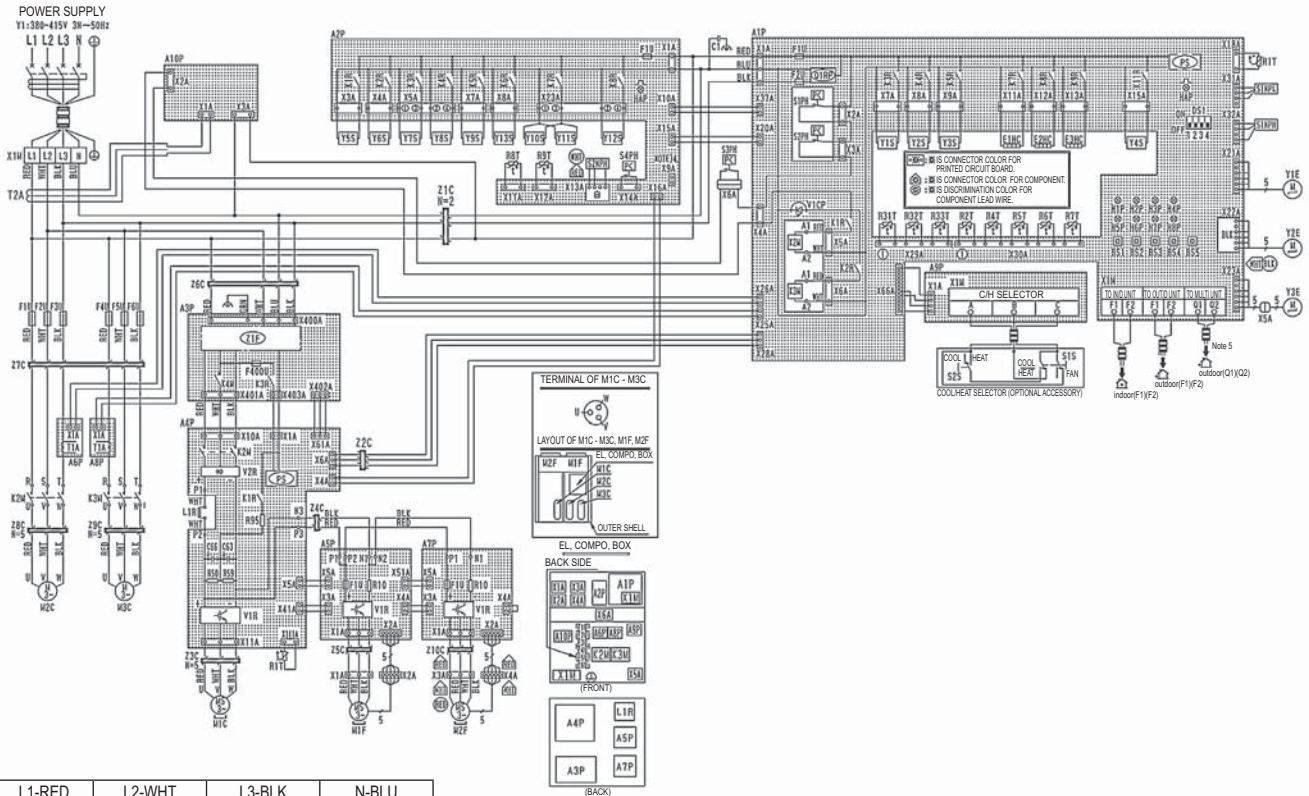

L1-RED	L2-WHT	L3-BLK	N-BLU				
A1P	Printed circuit board (main)						
A2P	Printed circuit board (sub)			K5R	Magnetic relay (Y3S) (A1P)	V1CP	Safety devices input (A1P)
A3P	Printed circuit board (noise filter)			K5R	Magnetic relay (Y9S) (A2P)	V1R	Power module (A4P, A5P, A7P)
A4P	Printed circuit board (inv)			K6R	Magnetic relay (3S) (A2P)	V2R	Diode bridge (A4P)
A5P, A7P	Printed circuit board (fan)			K7R	Magnetic relay (E1HC) (A1P)	X1A~4A	Connector (M1F, M2F)
A6P, A8P	Printed circuit board (current sensor)			K7R	Magnetic relay (0S, 1S) (A2P)	X5A	Connector (Y3E)
A9P	Printed circuit board (abc I/P)			K8R	Magnetic relay (E2HC) (A1P)	X6A	Connector (S3PH)
A10P	Printed circuit board (sub)			K8R	Magnetic relay (2S) (A2P)	X1M	Terminal strip (power supply)
BS1~5	Push button switch (mode, set, return, test, reset)			K9R	Magnetic relay (E3HC) (A1P)	X1M	Terminal strip (control) (A1P)
C1	Capacitor			K11R	Magnetic relay (Y4S) (A1P)	X1M	Terminal strip (ABC 1/P) (A9P)
C63, C66	Capacitor			L1R	Reactor	E	Electronic expansion valve (main)
DS1	Dip switch			M1C, M2F	Motor (compressor)	Y2E	Electronic expansion valve (main 2)
E1HC~3HC	Crankcase heater			M1F, M2F	Motor (fan)	Y3E	Electronic expansion valve (subcool)
F1U	Fuse (T, 3, 15A, 250V) (A2P)			PS	Switching power supply (A1P, A2P)	S	Solenoid valve (hot gas)
F1U	Fuse (8A, DC650V) (A5P, A7P)			Q1RP	Phase reversal detect circuit	Y2S	Solenoid valve (bypass)
F1U, F2U	Fuse (T, 3, 15A, 250V) (A1P)			R10	Resistor (current sensor) (A5P, A7P)	Y3S	Solenoid valve (4 way valve)
F1U~6U>	Fuse			R50, R59	Resistor	Y4S	Solenoid valve (mix in)
F400U	Fuse (T, 6, 3A, 250V) (A3P)			R95	Resistor (current limiting)	Y5S	Solenoid valve (return oil)
H1P~8P	Pilot lamp (service monitor-orange) [H2P] Prepare, test ----- flickering Malfunction detection ----- light up			R1T	Thermistor (AIR) (A1P)	Y6S	Solenoid valve (liq. close)
HAP	Pilot lamp (service monitor-green)			R1T	Thermistor (FIN) (A4P)	Y7S	Solenoid valve (receiver liq.)
K2M	Magnetic contactor (M1C) (A4P)			R2T	Thermistor (receiver)	Y8S	Solenoid valve (receiver gas)
K2M, K3M	Magnetic contactor (M2C, M3C)			R31~33T	Thermistor (M1C~3C discharge)	Y9S	Solenoid valve (oil out)
K4M	Magnetic contactor (M1C) (A3P)			R4T	Thermistor (receiver liq.)	0S	Solenoid valve (ref. gas out)
K1R, K2R	Magnetic relay (K2M, K3M) (A1P)			R5T	Thermistor (heat exc. outlet)	1S	Solenoid valve (ref. liq. in)
K1R	Magnetic relay (Y5S) (A2P)			R6T	Thermistor (liq. pipe)	2S	Solenoid valve (ref. gas in)
K1R	Magnetic relay (A4P)			R7T	Thermistor (receiver outlet)	3S	Solenoid valve (ref. liq. out)
K2R	Magnetic relay (Y6S) (A2P)			R8T	Thermistor (suction)	Z1C~10C	Noise filter (ferrite core)
K3R	Magnetic relay (S) (A1P)			R9T	Thermistor (heat exc. deicer)	Z1F	Noise filter (with surge absorber)
K3R	Magnetic relay (Y7S) (A2P)			S1NPH	Pressure sensor (high)		
K3R	Magnetic relay (A3P)			S1NPL	Pressure sensor (low)		
K4R	Magnetic relay (Y2S) (A1P)			S2NPH	Pressure sensor (high liq.)		Connector for optional parts
K4R	Magnetic relay (Y8S) (A2P)			S1PH~3PH	Pressure switch (high)	X9A	Power supply (adapter) (A2P)
				S4PH	Pressure switch (control)		Cool/Heat selector
				T1A	Current sensor (A6P, A8P)	S1S	Selector switch (fan/cool-heat)
				T2A	Current sensor (A10P)	S2S	Selector switch (cool/heat)

3D070295A

**NOTES**

- This wiring diagram is applied only to the outdoor unit.
- Field wiring: Terminal strip: Connector: Terminal: Protective earth (screw):
- When using the optional adapter, refer to the installation manual of the optional adapter.
- For connection wiring to indoor-outdoor transmission F1 • F2, outdoor-outdoor transmission F1 • F2, outdoor-multi transmission Q1 • Q2, refer to the installation manual.
- How to use BS1~5 and DS1 switch, refer to "service precaution" label on el. compo. box, LID.
- When operating, don't shortcircuit the protection device (S1PH ~ S3PH).
- Colors BLK: black RED: red BLU: blue WHT: white PNK: pink YLW: Yellow BRN: brown GRY: gray GRN: green ORG: orange

# 10 External connection diagrams

## 10 - 1 External Connection Diagrams

RQYQ140,8-16P

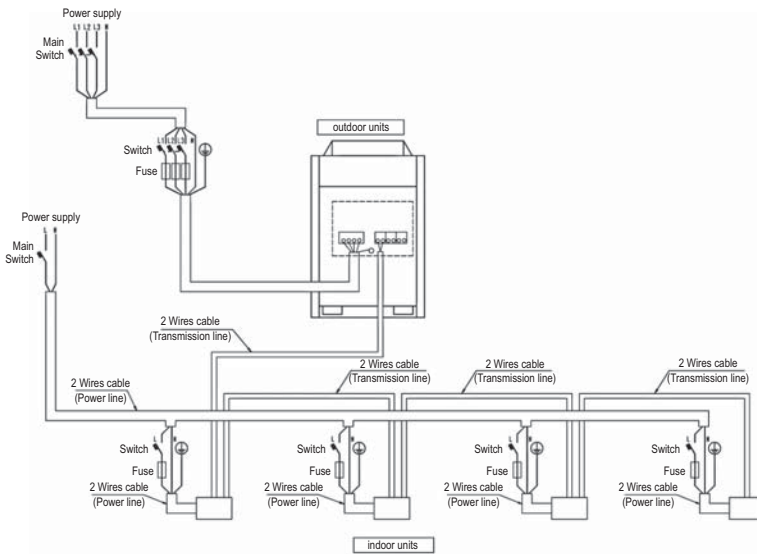

3D051452W

**NOTES**

1. All wiring, components and materials to be procured on the site must comply with the applicable local and national codes.
2. Use copper conductors only.
3. As for details, see wiring diagram.
4. Install circuit breaker for safety.
5. All field wiring and components must be provided by licensed electrician.
6. Unit shall be grounded in compliance with the applicable local and national codes.
7. Wiring shown are general points-of-connection guides only and are not intended for or to include all details for a specific installation.
8. Be sure to install the switch and the fuse to the power line of each equipment.
9. Install the main switch that can interrupt all the power sources in an integrated manner because this system consists of the equipment utilizing the multiple power sources.
10. If there exists the possibility of reversed phase, lose phase, momentary blackout or the power goes on and off while the product is operating, attach a reversed phase protection circuit locally. Running the product in reversed phase may break the compressor and other parts.
11. Must install earth leakage circuit breaker.

RQYQ18-32P

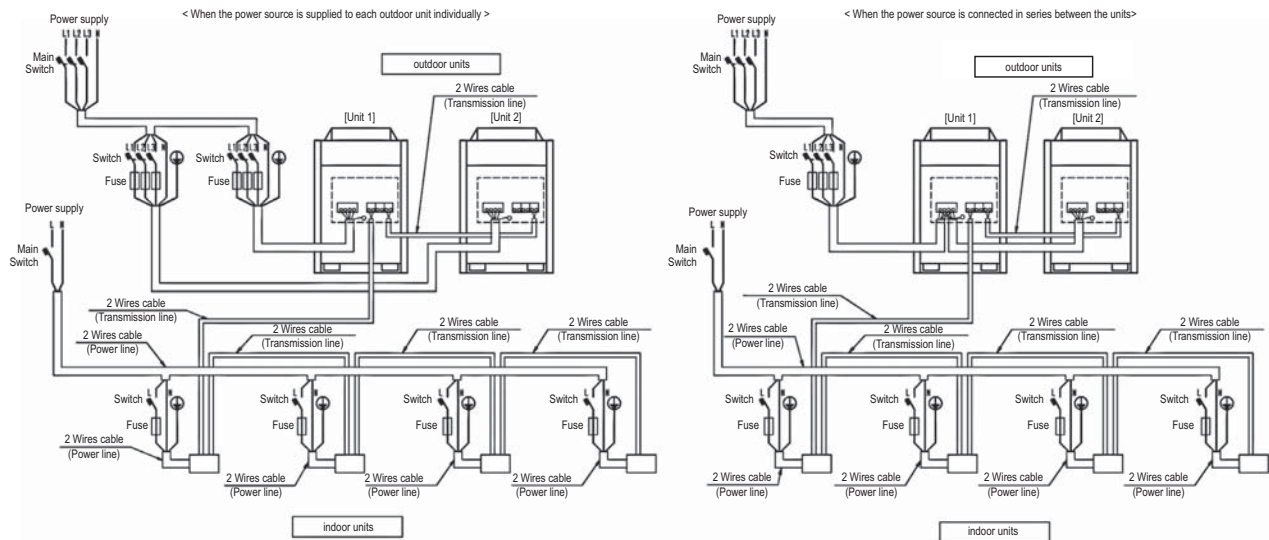

3D052261L

**NOTES**

1. All wiring, components and materials to be procured on the site must comply with the applicable local and national codes.
2. Use copper conductors only.
3. As for details, see wiring diagram.
4. Install circuit breaker for safety.
5. All field wiring and components must be provided by licensed electrician.
6. Unit shall be grounded in compliance with the applicable local and national codes.
7. Wiring shown are general points-of-connection guides only and are not intended for or to include all details for a specific installation.
8. Be sure to install the switch and the fuse to the power line of each equipment.
9. Install the main switch that can interrupt all the power sources in an integrated manner because this system consists of the equipment utilizing the multiple power sources.
10. The capacity of UNIT1 must be larger than UNIT2 when the power source is connected in series between the units.
11. If there exists the possibility of reversed phase, lose phase, momentary blackout or the power goes on and off while the product is operating, attach a reversed phase protection circuit locally. Running the product in reversed phase may break the compressor and other parts.
12. Must install earth leakage circuit breaker.



# 10 External connection diagrams

## 10 - 1 External Connection Diagrams

RQYQ34-48P

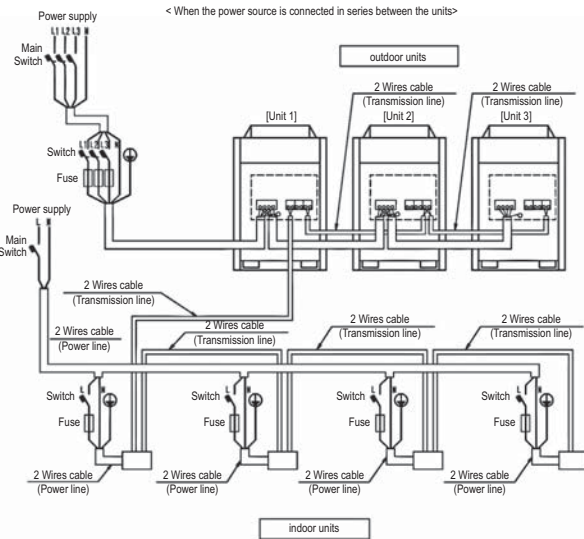
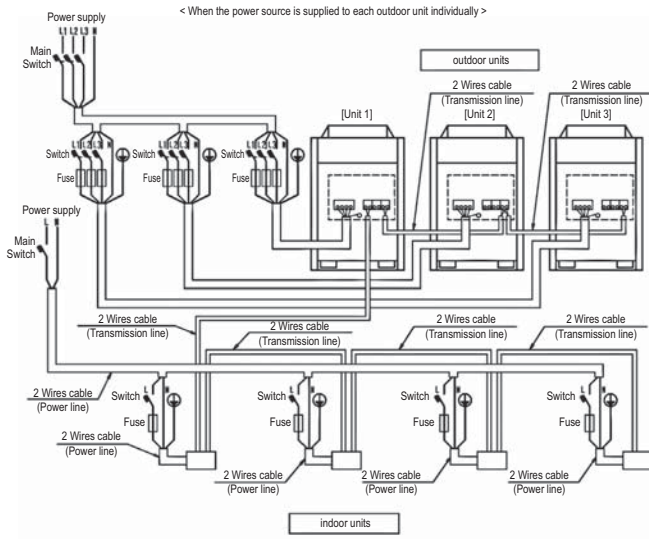

3D052262L

### NOTES

1. All wiring, components and materials to be procured on the site must comply with the applicable local and national codes.
2. Use copper conductors only.
3. As for details, see wiring diagram.
4. Install circuit breaker for safety.
5. All field wiring and components must be provided by licensed electrician.
6. Unit shall be grounded in compliance with the applicable local and national codes.
7. Wiring shown are general points-of-connection guides only and are not intended for or to include all details for a specific installation.
8. Be sure to install the switch and the fuse to the power line of each equipment.
9. Install the main switch that can interrupt all the power sources in an integrated manner because this system consists of the equipment utilizing the multiple power sources.
10. The capacity of UNIT1 must be larger than UNIT2 when the power source is connected in series between the units.
11. If there exists the possibility of reversed phase, lose phase, momentary blackout or the power goes on and off while the product is operating, attach a reversed phase protection circuit locally. Running the product in reversed phase may break the compressor and other parts.
12. Must install earth leakage circuit breaker.

# 11 Sound data

## 11 - 1 Sound Pressure Spectrum

### RQYQ140P

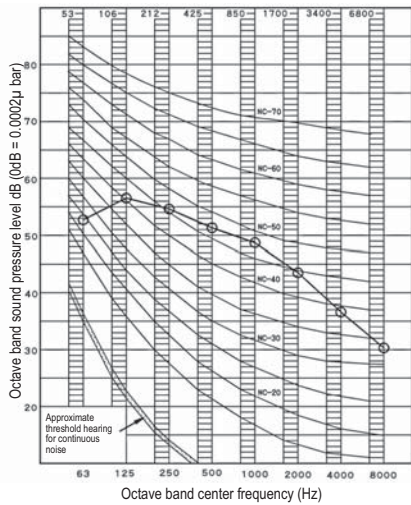

4D066849

#### NOTES

- Over All (dB): (B,G,N is already rectified)
- Operating conditions:  
Power source: 380-415V 50Hz  
JIS standard
- Measuring place: Anechoic chamber (conversion value)
- The operating sound is measured in anechoic chamber, if it is measured under the actual installation conditions, it is normally over the set value due to environmental noise and sound reflection.
- Location of microphone.

Scale	50 Hz
A	54
C	60

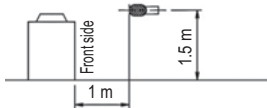

### RQYQ8P

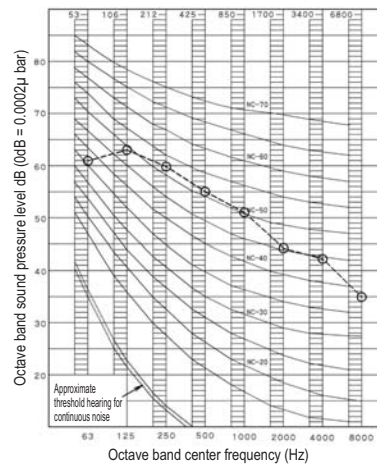

4D052395K

#### NOTES

- Over All (dB): (B,G,N is already rectified)
- Operating conditions:  
Power source: Y1: 380-415V 50Hz  
JIS Standard
- Measuring place: Anechoic chamber (conversion value)
- The operating sound is measured in anechoic chamber, if it is measured under the actual installation conditions, it is normally over the set value due to environmental noise and sound reflection.
- Location of microphone.

Scale	50Hz
A	57.0
C	66.5

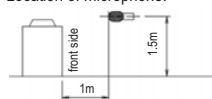

### RQYQ10P

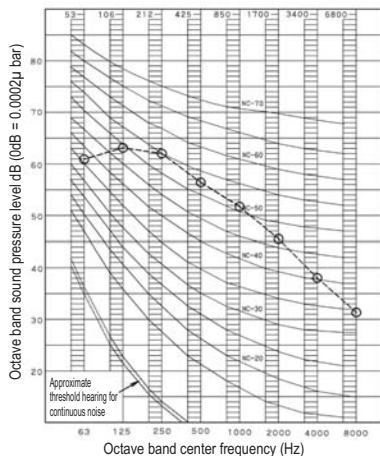

4D052396K

#### NOTES

- Over All (dB): (B,G,N is already rectified)
- Operating conditions:  
Power source: Y1: 380-415V 50Hz  
JIS Standard
- Measuring place: Anechoic chamber (conversion value)
- The operating sound is measured in anechoic chamber, if it is measured under the actual installation conditions, it is normally over the set value due to environmental noise and sound reflection.
- Location of microphone.

Scale	50Hz
A	58.0
C	67.0

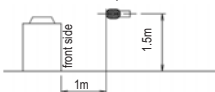

### RQYQ12-16P

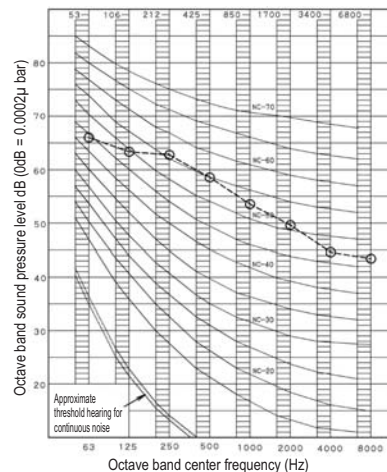

4D052397M

#### NOTES

- Over All (dB): (B,G,N is already rectified)
- Operating conditions:  
Power source: Y1: 380-415V 50Hz  
JIS Standard
- Measuring place: Anechoic chamber (conversion value)
- The operating sound is measured in anechoic chamber, if it is measured under the actual installation conditions, it is normally over the set value due to environmental noise and sound reflection.
- Location of microphone.

Scale	50Hz
A	60.0
C	69.0

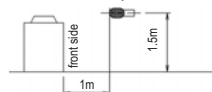

# 12 Installation

## 12 - 1 Installation Method

### RQYQ140P

For single unit installation

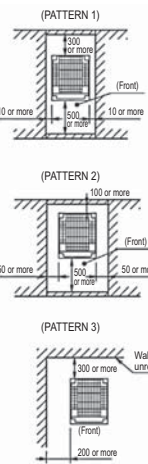

(Unit : mm)

For installation in rows

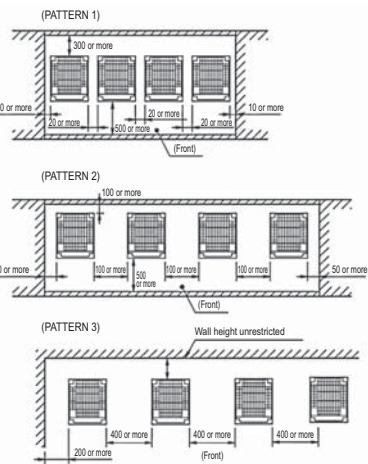

(Unit : mm)

For centralized group layout

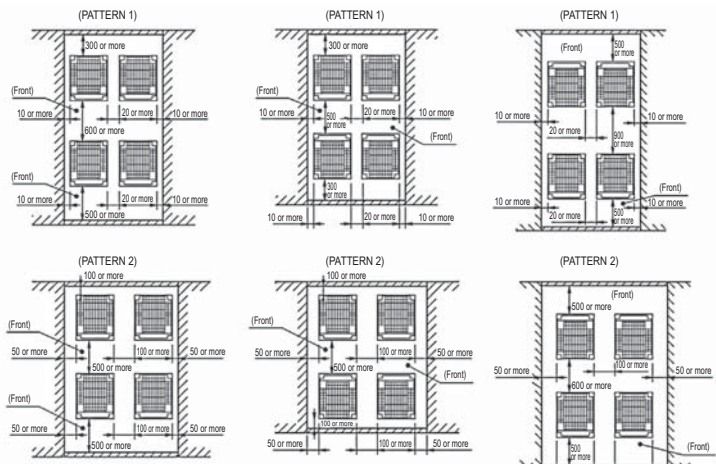

(Unit : mm)

3D066327

#### NOTES

- Heights of walls in case of patterns 1 and 2: Front: 1500mm. Suction side: 500 mm. Side: Height unrestricted. Installation space to be shown in this drawing is based on the cooling operation at 35 degrees outdoor air temperature. When the design outdoor air temperature exceeds 35 degrees or the load exceeds maximum ability because of much generation load heat in all outdoor unit, take the suction side space more broadly than the space to be shown in this drawing.
- If the above wall heights are exceeded then h2/2 and h1/2 should be added to the front and suction side service spaces respectively as shown in the figure on the right.
- When installing the units the most appropriate pattern should be selected from those shown above in order to obtain the best fit in the space available always bearing in mind the need to leave enough room for a person to pass between units and wall and for the air to circulate freely. (If more units are to be installed than are catered for in the above patterns your layouts should take account of the possibility of short circuits.)
- The units should be installed to leave sufficient space at the front for the on site refrigerant piping work to be carried out comfortably.

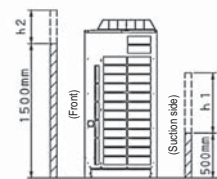

### RQYQ8-16P

For single unit installation

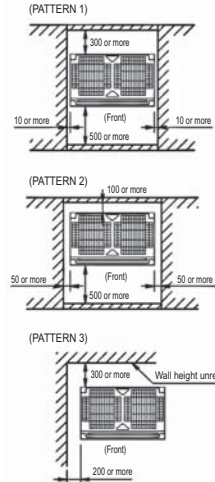

For installation in rows

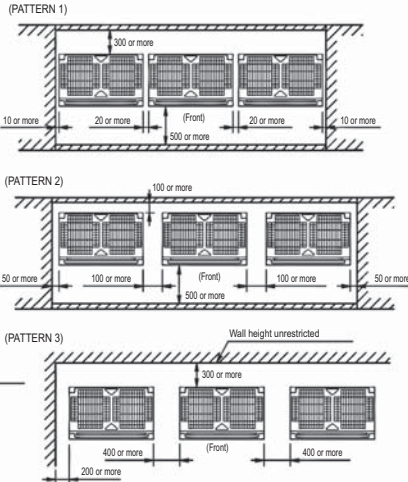

For centralized group layout

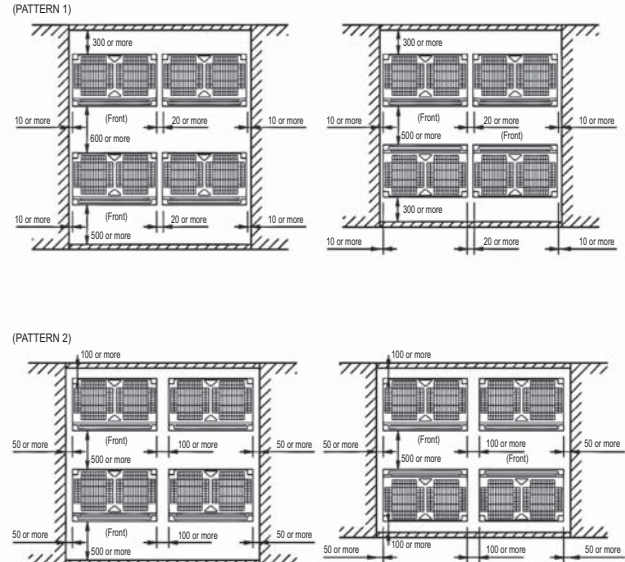

3D051451U

#### NOTES

- Heights of walls in case of patterns 1 and 2: Front: 1500mm. Suction side: 500 mm. Side: Height unrestricted. Installation space to be shown in this drawing is based on the cooling operation at 35 degrees outdoor air temperature. When the design outdoor air temperature exceeds 35 degrees or the load exceeds maximum ability because of much generation load heat in all outdoor unit, take the suction side space more broadly than the space to be shown in this drawing.
- If the above wall heights are exceeded then h2/2 and h1/2 should be added to the front and suction side service spaces respectively as shown in the figure on the right.
- When installing the units the most appropriate pattern should be selected from those shown above in order to obtain the best fit in the space available always bearing in mind the need to leave enough room for a person to pass between units and wall and for the air to circulate freely. (If more units are to be installed than are catered for in the above patterns your layouts should take account of the possibility of short circuits.)
- The units should be installed to leave sufficient space at the front for the on site refrigerant piping work to be carried out comfortably.

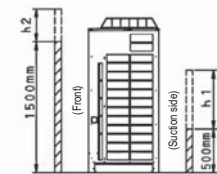

# 12 Installation

## 12 - 2 Fixation and Foundation of Units

12

RQYQ-P

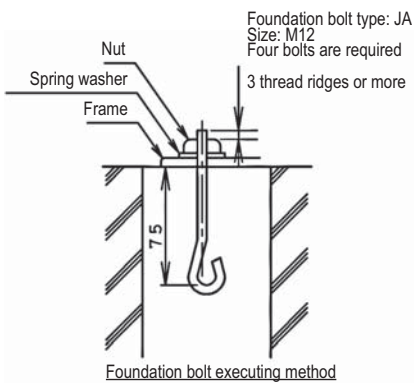
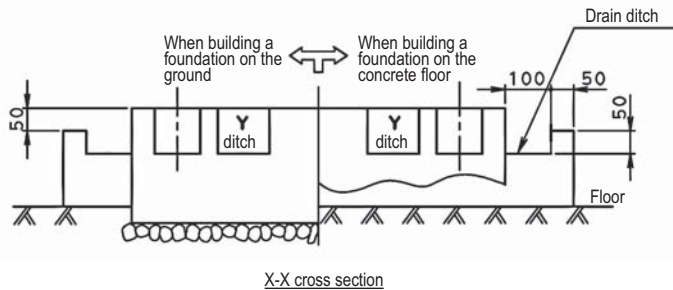
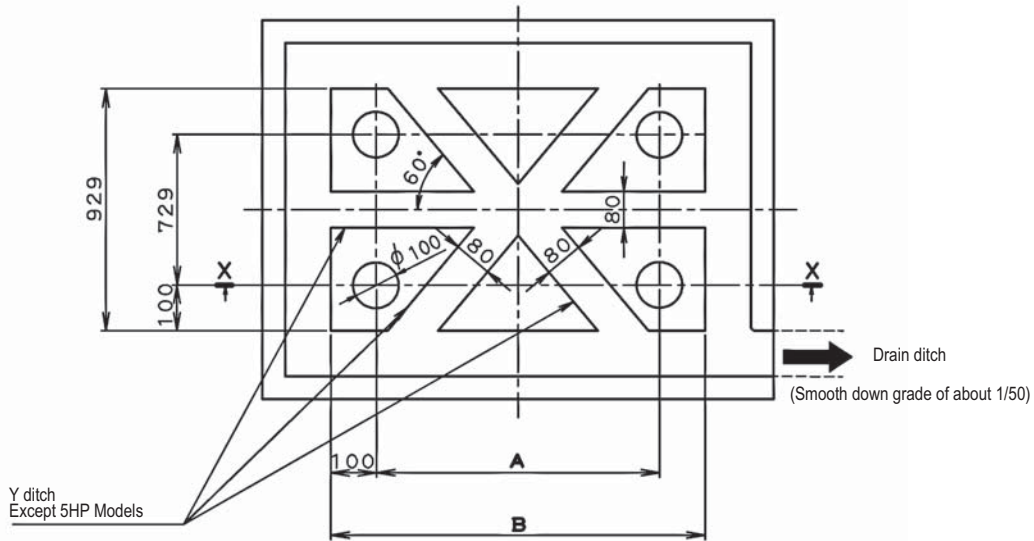

Model	A	B
RQYQ140P	497	697
RQYQ8 • 10 • 12P	792	992
RQYQ14 • 16P	1102	1302

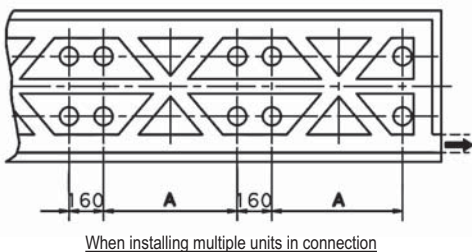

3D065400G

### NOTES

1. The proportions of cement: sand: gravel for the concrete shall be 1:2:4, and the reinforcement bars that their diameter are 10mm, (approx. 300 mm intervals) shall be placed.
2. The surface shall be finished with mortar. The corner edges shall be chamfered.
3. When the foundation is built on a concrete floor, rubble is not necessary. However, the surface of the section on which the foundation is built shall have rough finish.
4. A drain ditch shall be made around the foundation to thoroughly drain water from the equipment installation area.
5. When installing the equipment on a roof, the floor strength shall be checked and water-proofing measures shall be taken.
6. Y ditch is not necessary for 5HP Models.



# 13 Operation range

## 13 - 1 Operation Range

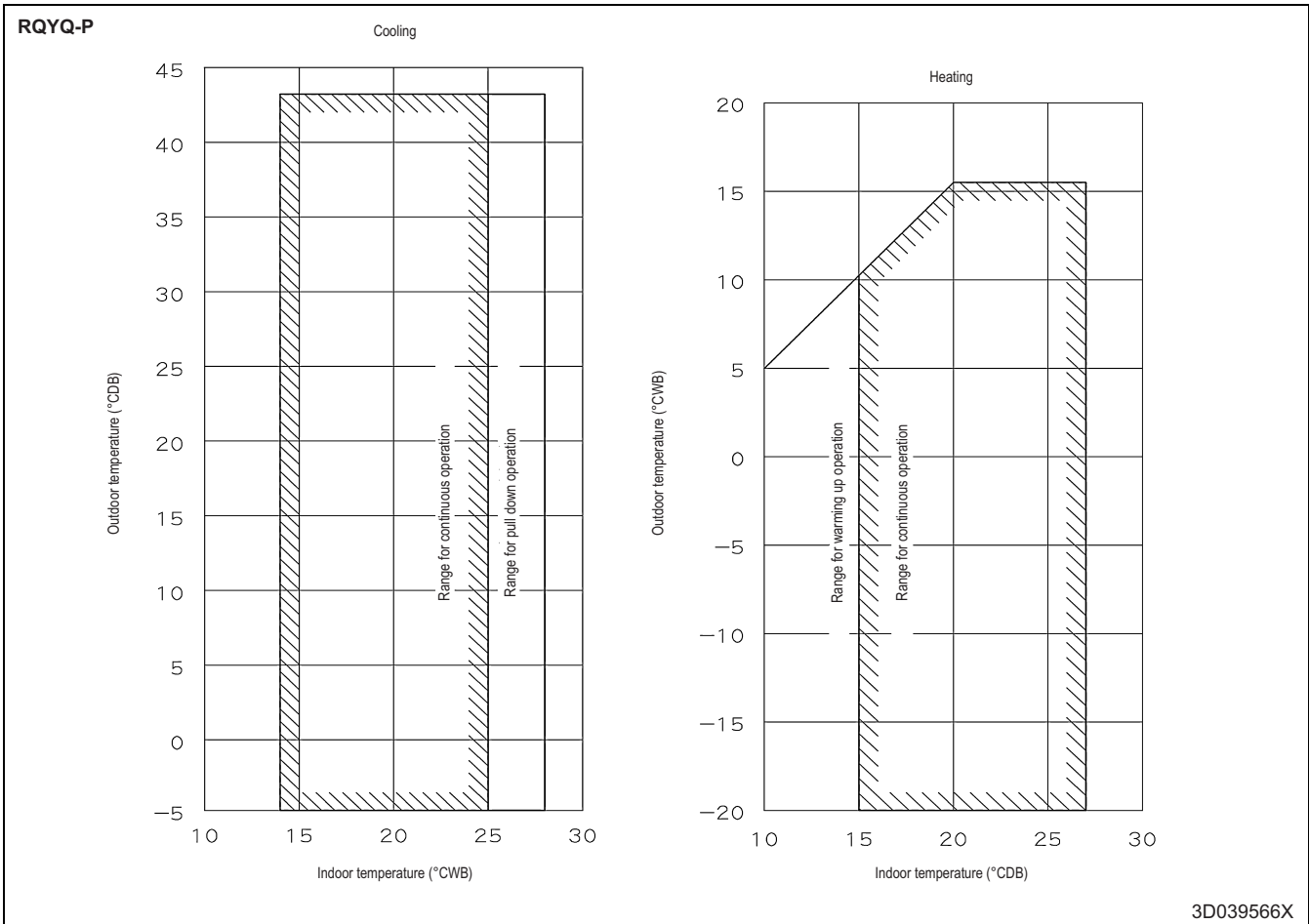







Daikin's unique position as a manufacturer of air conditioning equipment, compressors and refrigerants has led to its close involvement in environmental issues. For several years Daikin has had the intention to become a leader in the provision of products that have limited impact on the environment. This challenge demands the eco design and development of a wide range of products and an energy management system, resulting in energy conservation and a reduction of waste.



These products are not within the scope of the Eurovent certification program

Daikin Europe N.V. participates in the Eurovent Certification programme for Air conditioners (AC), Liquid Chilling Packages (LCP) and Fan coil units (FCU). Check on-going validity of certificate online: [www.eurovent-certification.com](http://www.eurovent-certification.com) or using: [www.certiflash.com](http://www.certiflash.com)

The present leaflet is drawn up by way of information only and does not constitute an offer binding upon Daikin Europe N.V.. Daikin Europe N.V. has compiled the content of this leaflet to the best of its knowledge. No express or implied warranty is given for the completeness, accuracy, reliability or fitness for particular purpose of its content and the products and services presented therein. Specifications are subject to change without prior notice. Daikin Europe N.V. explicitly rejects any liability for any direct or indirect damage, in the broadest sense, arising from or related to the use and/or interpretation of this leaflet. All content is copyrighted by Daikin Europe N.V.

BARCODE

Daikin products are distributed by:

