



Fan Coil Units

Technical Data



ECDEN10-400

TABLE OF CONTENTS

FWV-D

1	Features	4
2	Specifications	5
	Technical Specifications - 2-pipe	5
	Technical Specifications - 4-pipe	6
	Electrical Specifications - 2-pipe and 4-pipe	7
3	Options	8
	Options	8
4	Control systems	9
	Control Systems	9
5	Capacity tables	10
	Cooling Capacity Tables - 2 pipe	10
	Cooling Capacity Tables - 4-pipe	14
	Capacity Correction Factor	18
	Heating Capacity Tables - 2-pipe	20
	Heating Capacity Tables - 4-pipe	22
	Power consumption - 2-pipe	24
	Power consumption - 4-pipe	28
6	Dimensional drawings	32
	Dimensional Drawings	32
7	Wiring diagrams	33
	Wiring Diagrams - Single Phase	33
8	Sound data	34
	Sound Level Data - 2-pipe	34
	Sound Level Data - 4-pipe	35
9	Installation	36
	Installation Method	36
10	Operation range	38
	Operation Range	38
11	Hydraulic performance	39
	Water Pressure Drop Curve Evaporator - Cooling 2-pipe	39
	Water Pressure Drop Curve Evaporator - Heating 2-pipe	39
	Water Pressure Drop Curve Evaporator - Heating 4-pipe	40

1 Features

- Quick fixing system for wall mounted installation
- Pre-assembled 3-way/4-port on/off valves are available
- Valve packages are insulated, no extra drain pan required
- Valve packages contain balancing valves and sensor pocket
- Fast-on connections for electrical options: no tools needed
- The air filter can easily be removed for cleaning



2 Specifications

2-1 Technical Specifications - 2-pipe				FWV01DATN 6V3/TV6V3	FWV02DATN 6V3/TV6V3	FWV03DATN 6V3/TV6V3	FWV04DATN 6V3/TV6V3	FWV06DATN 6V3/TV6V3	FWV08DATN 6V3/TV6V3	FWV10DATN 6V3/TV6V3
Cooling capacity	Total capacity	High	kW	1.54 (1)	2.09 (1)	2.93 (1)	4.33 (1)	4.77 (1)	6.71 (1)	8.02 (1)
		Nom.	kW	1.24 (1)	1.81 (1)	2.38 (1)	3.27 (1)	3.87 (1)	5.27 (1)	6.24 (1)
		Low	kW	1.04 (1)	1.45 (1)	1.76 (1)	2.51 (1)	3.17 (1)	3.97 (1)	4.11 (1)
	Sensible capacity	High	kW	1.20 (1)	1.51 (1)	2.11 (1)	3.15 (1)	3.65 (1)	4.91 (1)	5.96 (1)
		Nom.	kW	0.97 (1)	1.31 (1)	1.70 (1)	2.45 (1)	2.92 (1)	3.83 (1)	4.63 (1)
		Low	kW	0.79 (1)	1.05 (1)	1.26 (1)	1.80 (1)	2.32 (1)	2.84 (1)	3.05 (1)
Heating capacity	2-Pipe	High	kW	2.14 (2)	2.57 (2)	3.81 (2)	5.63 (2)	6.36 (2)	7.83 (2)	10.03 (2)
		Medium	kW	1.73 (2)	2.18 (2)	3.08 (2)	4.30 (2)	5.21 (2)	6.23 (2)	7.80 (2)
		Low	kW	1.43 (2)	1.79 (2)	2.28 (2)	3.29 (2)	4.24 (2)	4.77 (2)	5.24 (2)
Power input	High		W	37	53	56	98		137	175
	Nom.		W	28	36	43	61	68	104	130
	Low		W	21	24	29	38	47	76	90
Dimensions	Unit	Height	mm	564						
		Width	mm	774		984	1,194		1,404	
		Depth	mm	226						251
Weight	Unit		kg	19	20	25	30	31	41	
	Operation weight		kg	-						
Casing	Colour	Plastic and metal RAL9010								
	Material	Plastic + sheet metal								
Heat exchanger	Rows	Quantity	2		3					
	Stages	Quantity	10						12	
	Fin pitch	mm	1.8	1.6		1.8	1.6		2.1	
	Face area	m ²	0.086		0.138	0.191		0.292		
	Water volume	l	0.5	0.7	1	1.4		2.1		
	Fan	Type	Centrifugal multi-blade, double suction							
Quantity		1			2					
Air flow rate		High	m ³ /h	319	344	442	706	785	1,011	1,393
		Medium	m ³ /h	233	271	341	497	605	771	1,022
		Low	m ³ /h	178	211	241	361	470	570	642
Available pressure		High	Pa	-						
Fan motor	Speed	Steps	3 (high, medium, low)							
	Model	Closed induction, B class insulation, winding thermal cut-out								
Sound power level	High	dBA	45	50	47	52	56	58	64	
	Nom.	dBA	39	44	41	43	49	51	57	
	Low	dBA	33	38	33	35	43	44	48	
Water flow	Cooling	l/h	265	359	504	745	820	1,154	1,343	
	Heating	l/h	265	359	504	745	820	1,154	1,343	
Water pressure drop	Cooling	kPa	13		11	12	14	12	19	
	Heating	kPa	9	11	9		10	9	16	
Air filter	Plastic									
Insulation material	Class 1 self-extinguishing									
Vibration insulation	Rubber ring for fan motor									
Water connections	Std. heat exchanger	inch	1/2						3/4	
Piping connections	Drain	OD	mm							
Notes	Cooling capacity is based on room temperature 27° CDB, 19° CWB and entering water temperature 7°C, water temperature rise 5K.									
	Heating capacity is based on: room temperature 20° CDB and entering water temperature 50° C, water flow rate as during cooling.									
	Air flow at 0 Pa ESP									

2 Specifications

2-2 Technical Specifications - 4-pipe				FWV01DAFN 6V3/FV6V3	FWV02DAFN 6V3/FV6V3	FWV03DAFN 6V3/FV6V3	FWV04DAFN 6V3/FV6V3	FWV06DAFN 6V3/FV6V3	FWV08DAFN 6V3/FV6V3	FWV10DAFN 6V3/FV6V3	
Cooling capacity	Total capacity	High	kW	1.46 (1)	1.90 (1)	2.87 (1)	4.33 (1)	4.67 (1)	6.64 (1)	7.88 (1)	
		Nom.	kW	1.24 (1)	1.62 (1)	2.33 (1)	3.27 (1)	3.81 (1)	5.23 (1)	6.16 (1)	
		Low	kW	0.99 (1)	1.35 (1)	1.73 (1)	2.48 (1)	3.11 (1)	3.93 (1)	4.07 (1)	
	Sensible capacity	High	kW	1.14 (1)	1.51 (1)	2.07 (1)	3.15 (1)	3.57 (1)	4.85 (1)	5.85 (1)	
		Nom.	kW	0.97 (1)	1.25 (1)	1.66 (1)	2.45 (1)	2.87 (1)	3.80 (1)	4.57 (1)	
		Low	kW	0.75 (1)	1.10 (1)	1.24 (1)	1.78 (1)	2.28 (1)	2.82 (1)	3.02 (1)	
Heating capacity	4-Pipe	High	kW	1.90 (2)	2.10 (2)	3.08 (2)	5.05 (2)	5.30 (2)	7.91 (2)	9.30 (2)	
		Medium	kW	1.70 (2)	1.78 (2)	2.68 (2)	4.25 (2)	4.65 (2)	6.83 (2)	7.95 (2)	
		Low	kW	1.50 (2)	1.56 (2)	2.18 (2)	3.60 (2)	4.04 (2)	5.69 (2)	6.12 (2)	
Power input	High	W	37	53	56	98		137	175		
	Nom.	W	28	36	43	61	68	104	130		
	Low	W	21	24	29	38	47	76	90		
Dimensions	Unit	Height	mm	564							
		Width	mm	774		984	1,194		1,404		
		Depth	mm	226						251	
Weight	Unit	kg	20	21	26	32	33	44			
	Operation weight	kg	-								
Casing	Colour	Plastic and metal RAL9010									
	Material	Plastic + sheet metal									
Heat exchanger	Rows	Quantity	2	3							
	Stages	Quantity	10						12		
	Fin pitch	mm	1.8	1.6		1.8	1.6		2.1		
	Face area	m ²	0.086		0.138	0.191		0.292			
	Water volume	l	0.5	0.7	1	1.4		2.1			
Additional heat exchanger	Rows	Quantity	1								
	Stages	Quantity	8						10		
	Fin pitch	mm	1.6								
	Face area	m ²	0.068		0.11	0.152		0.243			
	Water volume	l	0.2		0.3	0.4		0.6			
Fan	Type	Centrifugal multi-blade, double suction									
	Quantity	1			2						
	Air flow rate	High	m ³ /h	307	327	431	690	763	998	1,362	
		Medium	m ³ /h	225	261	332	490	593	765	1,007	
		Low	m ³ /h	174	205	238	356	460	565	636	
Available pressure	High	Pa	-								
Fan motor	Speed	Steps	3 (high, medium, low)								
	Model	Closed induction, B class insulation, winding thermal cut-out									
Sound power level	High	dBA	45	50	47	52	56	58	64		
	Nom.	dBA	39	44	41	43	49	51	57		
	Low	dBA	33	38	33	35	43	44	48		
Water flow	Cooling	l/h	251	327	494	745	803	1,142	1,355		
	Heating	l/h	196	182	286	396	465	694	816		
Water pressure drop	Cooling	kPa	13		11	12	14	12	19		
	Heating	kPa	7	8	5	10		8	9		
Air filter	Plastic										
Insulation material	Class 1 self-extinguishing										
Vibration insulation	Rubber ring for fan motor										
Water connections	Std. heat exchanger	inch	1/2						3/4		
Piping connections	Drain	OD	mm								
Notes	Cooling capacity is based on room temperature 27° CDB, 19° CWB and entering water temperature 7°C, water temperature rise 5K.										
	Heating capacity is based on: room temperature 20° CDB and entering water temperature 50° C, water flow rate as during cooling.										
	Air flow at 0 Pa ESP										

2 Specifications

2-3 Electrical Specifications - 2-pipe and 4-pipe			FWV01DATN 6V3/TV6V3	FWV02DATN 6V3/TV6V3	FWV03DATN 6V3/TV6V3	FWV04DATN 6V3/TV6V3	FWV06DATN 6V3/TV6V3	FWV08DATN 6V3/TV6V3	FWV10DATN 6V3/TV6V3	
Power supply	Phase		1							
	Frequency	Hz	50							
	Voltage	V	230							
Required fuses	A	0.5					1	2		
Current input	High	A	0.17	0.24	0.25	0.44	0.43	0.60	0.76	
	Medium	A	0.13	0.16	0.20	0.29	0.31	0.46	0.58	
	Low	A	0.10	0.11	0.14	0.19	0.22	0.34	0.41	
Required wire section	mm	1								
Note	The power consumption for the valve motor is 5W (peak) only during opening.									

3 Options

3 - 1 Options

FWV-FWL-FWM												
Description	Daikin	F2	F4	F6	F8	F9	F10	F11	FWV	FWL	FWM	Notes/remarks
FCU unit	FWV+FWL+FWM	1	2	3	4	6	8	10				
Additional single row heat exchanger	ESRH..A6	ESRH02A6		ESRH03A6	ESRH06A6	ESRH10A6			X	X	X	Can not be used in combination with electric heater
Electric heater	EEH..A6	EEH01A6	EEH02A6	EEH03A6	EEH06A6	EEH10A6			X	X	X	Can not be used in combination with additional H/E requires electronic Controller
2-pipe ON-OFF 3 way motor driven valve complete with mounting kit	E2MV..A6	E2MV03A6			E2MV06A6	E2MV10A6			X	X	X	requires electronic Controller or electro-mechanical Control
4-pipe ON-OFF 3 way motor driven valve complete with mounting kit	E4MV..A6	E4MV03A6			E4MV06A6	E4MV10A6			X	X	X	requires electronic Controller
Fan stop thermostat	YFSTA6	YFSTA6							X	X	X	
Air intake & discharge grill + front Filter fixing kit for concealed models	EAIDF..A6	EAIDF02A6	EAID-F03A6	EAIDF06A6	EAIDF10A6						X	
Supporting feet (=supporting brackets + covers)	ESFV..A6	ESFV06A6				ESFV10A6			X		X	Covers can not be used for FWM
Supporting feet + grill	ESFVG..A6	ESFVG02A6	ESFV-G03A6	ESFVG06A6	ESFVG10A6			X				
Fresh air intake louvers (manual)	EFA..A6	EFA02A6	EFA3A6	EFA6A6	EFA10A6			X				
Rear panel for Vertical mounted models	ERPV..A6	ERPV2A6	ERPV03A6	ERPV06A6	ERPV10A6			X	X			Only for vertical mounted units
Controller Electro mechanical built in	ECFWMB6	ECFWMB6							X	X	X	
Power interface for connection of up to 4 FCU to a single control panel	EPIMSB6	EPIMSB6							X	X	X	
Vertical Drain Pan	EDPVA6	EDPVA6							X	X	X	
Horizontal Drain Pan	EDPHA6	EDPHA6								X	X	
Fcu Controller - Standard version	FWEC1A	FWEC1A							X	X	X	water probe included
Fcu Controller - Advanced version	FWEC2A	FWEC2A							X	X	X	water probe included
Fcu Controller - Advanced plus version	FWEC3A	FWEC3A							X	X	X	water probe included
Fcu temperature sensor kit	FWTSKA	FWTSKA							X	X	X	
Fcu relative humidity sensor kit	FWHSKA	FWHSKA							X	X	X	
On board fcu Controller installation kit	FWECKA	FWECKA							X	X		











4TW60019-2B (1/2)

FWV-FWL-FWM																					
Description	ESRH..A6	EEH..A6	E2MV..A6	E4MV..A6	YFSTA6	EAIDF..A6	ESFV..A6	ESFVG..A6	EFA..A6	ERPV..A6	ECFWMB6	EPIMSB6	EDPVA6	EDPHA6	FWEC1A	FWEC2A	FWEC3A	FWTSKA	FWHSKA	FWECKA	
Additional single row heat exchanger	X			X		X	X	X	X	X	X	X	X	X	X	X	X	X	X	X	X
Electric heater		X				X	X	X	X	X	X	X	X	X	X	X	X	X	X	X	X
2-pipe ON-OFF 3 way motor driven valve complete with mounting kit		X				X	X	X	X	X	X	X	X	X	X	X	X	X	X	X	X
4-pipe ON-OFF 3 way motor driven valve complete with mounting kit	X					X	X	X	X	X	X	X	X	X	X	X	X	X	X	X	X
Fan stop thermostat					X	X	X	X	X	X	X	X	X	X	X	X	X	X	X	X	X
Air intake & discharge grill + front Filter fixing kit for concealed models	X	X	X	X	X	X	X	X	X	X	X	X	X	X	X	X	X	X	X	X	X
Supporting feet (=supporting brackets + covers)	X	X	X	X	X	X	X	X	X	X	X	X	X	X	X	X	X	X	X	X	X
Supporting feet + grill	X	X	X	X	X	X	X	X	X	X	X	X	X	X	X	X	X	X	X	X	X
Fresh air intake louvers (manual)	X	X	X	X	X	X	X	X	X	X	X	X	X	X	X	X	X	X	X	X	X
Rear panel for Vertical mounted models	X	X	X	X	X	X	X	X	X	X	X	X	X	X	X	X	X	X	X	X	X
Controller Electro mechanical built in			X		X		X	X	X	X	X	X	X	X	X	X	X	X	X	X	X
Power interface for connection of up to 4 FCU to a single control panel	X	X	X	X	X	X	X	X	X	X	X	X	X	X	X	X	X	X	X	X	X
Vertical Drain Pan	X	X	X	X	X	X	X	X	X	X	X	X	X	X	X	X	X	X	X	X	X
Horizontal Drain Pan	X	X	X	X	X	X	X	X	X	X	X	X	X	X	X	X	X	X	X	X	X
Fcu Controller - Standard version	X	X	X	X	X	X	X	X	X	X	X	X	X	X	X	X	X	X	X	X	X
Fcu Controller - Advanced version	X	X	X	X	X	X	X	X	X	X	X	X	X	X	X	X	X	X	X	X	X
Fcu Controller - Advanced plus version	X	X	X	X	X	X	X	X	X	X	X	X	X	X	X	X	X	X	X	X	X
Fcu temperature sensor kit	X	X	X	X	X	X	X	X	X	X	X	X	X	X	X	X	X	X	X	X	X
Fcu relative humidity sensor kit	X	X	X	X	X	X	X	X	X	X	X	X	X	X	X	X	X	X	X	X	X
On board fcu Controller installation kit	X	X	X	X	X	X	X	X	X	X	X	X	X	X	X	X	X	X	X	X	X

4TW60019-2B (2/2)

4 Control systems

4 - 1 Control Systems

	Cool/heat changeover			Options		Basic control functions		Control features		
										
2-pipe	✓					✓	✓	✓	✓	
	✓			✓		✓	✓	✓	✓	
	✓				✓	✓	✓	✓	✓	
	✓			✓	✓	✓	✓	✓	✓	
		✓				✓	✓	✓	✓	
		✓			✓		✓	✓		
				✓	✓	✓	✓	✓	✓	✓
4-pipe	✓			✓		✓	✓	✓	✓	
	✓					✓	✓	✓	✓	
			✓			✓	✓	✓		✓
			✓	✓		✓	✓		✓	✓



Manual cool/heat changeover.



Automatic cool/heat changeover based on water temperature.



Automatic cool/heat changeover based on air temperature.



Control of the 3-way/4pipe ON/OFF valve. The water valve shut-off once the desired temperature is reached.



The controller controls the electric heater as integration or replacement of the hot water heating system. When the operating mode selector switch is turned on "electric heater" and the electric heater is turned on, the fan runs continuously at medium speed.



The fan speed can be set at one of the 3 speeds (low, medium or maximum) by turning the operation mode selector.



The fan speed is switched automatically based on the difference between the temperature set on the thermostat and the room temperature.



Optimised comfort cooling. When the fan coil has reached the desired setpoint, the fan will operate at medium speed and at regular intervals to ensure constant room temperature and lower sound.



The controller prevents the fan coil unit from operating in one mode, if the required water temperature is not achieved to operate in the selected mode.



The dead zone is a temperature interval close to the set temperature. When the air is warmer/cooler than the top/lower limit of the neutral zone, the cooling/heating mode is selected.

5 Capacity tables

5 - 1 Cooling Capacity Tables - 2 pipe

Air temperature (°C DB - °C WB) Water temperature (Entering °C - leaving °C) Model	22 - 16																
	6 - 11				7 - 12				8 - 13				9 - 14				
	Total cooling capacity W	Seizable cooling capacity W	Water flow ℓ/h	Water pressure drop kPa	Total cooling capacity W	Seizable cooling capacity W	Water flow ℓ/h	Water pressure drop kPa	Total cooling capacity W	Seizable cooling capacity W	Water flow ℓ/h	Water pressure drop kPa	Total cooling capacity W	Seizable cooling capacity W	Water flow ℓ/h	Water pressure drop kPa	
FW 01 TIV/V	Max.	880	840	152	5	820	820	140	4	730	730	125	4	650	650	111	3
	Med.	720	720	124	4	660	660	114	3	610	610	104	3	550	550	95	2
	Min.	640	570	110	3	580	580	100	2	540	540	92	2	490	490	84	2
FW 02 TIV/V	Max.	1290	1070	221	6	1090	1090	187	4	980	980	169	4	880	880	151	3
	Med.	1120	930	192	5	880	830	151	3	860	860	148	3	790	790	135	2
	Min.	910	750	157	3	780	700	133	2	730	730	125	2	670	670	114	2
FW 03 TIV/V	Max.	1730	1470	296	5	1480	1480	255	3	1370	1370	235	3	1260	1260	216	3
	Med.	1450	1200	249	3	1260	1120	216	3	1180	1180	203	2	1080	1080	186	2
	Min.	1240	960	213	3	1090	890	186	2	920	820	158	1	860	860	149	1
FW 04 TIV/V	Max.	2480	2170	425	5	2140	2140	368	4	1970	1970	339	4	1810	1810	310	3
	Med.	1990	1740	341	3	1720	1630	295	2	1620	1620	279	2	1490	1490	256	2
	Min.	1750	1360	300	3	1520	1270	261	2	1290	1170	221	1	1230	1230	212	1
FW 06 TIV/V	Max.	2820	2570	484	6	2390	2390	410	4	2120	2120	363	3	1930	1930	331	3
	Med.	2150	1990	369	4	1980	1980	340	3	1830	1830	314	3	1670	1670	287	2
	Min.	1960	1650	336	3	1700	1550	292	2	1590	1590	272	2	1460	1460	250	2
FW 08 TIV/V	Max.	3850	3380	661	5	3290	3290	565	4	3040	3040	522	3	2780	2780	478	3
	Med.	3140	2680	539	3	2720	2510	467	3	2570	2570	441	2	2360	2360	405	2
	Min.	2730	2130	469	3	2380	1990	409	2	2010	1840	346	1	1940	1940	333	1
FW 10 TIV/V	Max.	4790	4200	822	8	4000	4000	687	6	3550	3550	610	5	3120	3120	536	4
	Med.	3380	3120	579	4	3130	3130	538	4	2890	2890	496	3	2650	2650	455	3
	Min.	2770	2270	474	3	2400	2120	412	2	2170	2170	373	2	1990	1990	342	2

4TW60012-1A (Sheet 1/13)

5 Capacity tables

5 - 1 Cooling Capacity Tables - 2 pipe

Air temperature (°C DB - °C WB) Water temperature (Entering °C - leaving °C) Model	25 - 18						9 - 14						
	6 - 11		7 - 12		8 - 13		6 - 11		7 - 12		8 - 13		
	Total cooling capacity W	sensible cooling capacity W	latent flow ℓ/h	Water pressure drop kPa	Total cooling capacity W	sensible cooling capacity W	latent flow ℓ/h	Water pressure drop kPa	Total cooling capacity W	sensible cooling capacity W	latent flow ℓ/h	Water pressure drop kPa	
FW 01 T1/TV	Max.	1480	1110	254	13	1260	1030	217	9	1020	940	175	6
	Med.	1190	900	205	9	1010	830	174	6	810	750	139	4
	Min.	1000	740	172	6	850	670	145	5	680	610	117	3
	Max.	2020	1410	346	13	1750	1300	300	10	1450	1190	250	7
FW 02 T1/TV	Med.	1750	1230	300	10	1520	1130	260	8	1260	1030	217	6
	Min.	1400	980	240	7	1210	910	208	5	1000	820	172	4
	Max.	2820	1970	484	11	2440	1820	419	8	2010	1640	345	6
	Med.	2290	1590	393	7	1970	1460	338	6	1590	1310	273	4
FW 03 T1/TV	Min.	1690	1180	290	4	1460	1080	251	3	1300	1020	224	3
	Max.	4170	2940	715	12	3590	2710	617	9	2940	2450	504	6
	Med.	3140	2280	538	7	2670	2090	458	5	2080	1860	357	3
	Min.	2390	1670	410	4	2060	1540	354	3	1830	1440	315	3
FW 06 T1/TV	Max.	4600	3400	788	14	3970	3150	682	10	3280	2880	562	7
	Med.	3720	2720	639	9	3200	2510	549	7	2580	2270	443	5
	Min.	3040	2160	522	7	2580	1970	444	5	2050	1760	352	3
	Max.	6470	4590	1109	11	5590	4230	960	9	4590	3830	788	6
FW 08 T1/TV	Med.	5060	3580	868	7	4320	3270	741	6	3360	2890	578	4
	Min.	3780	2640	649	4	3230	2410	554	3	2870	2270	492	3
	Max.	7730	5560	1325	19	6690	5150	1148	15	5540	4700	951	10
	Med.	6000	4320	1030	12	5150	3980	885	9	4160	3590	714	6
FW 10 T1/TV	Min.	3920	2830	672	6	3270	2570	561	4	2900	2420	498	3

4TW60012-1A (Sheet 3/13)

5 Capacity tables

5 - 1 Cooling Capacity Tables - 2 pipe

Air temperature (°C DB - °C WB) Water temperature (Entering °C - leaving °C) Model	27 - 19																
	6 - 11				7 - 12				8 - 13				9 - 14				
	Total cooling capacity W	sensible cooling capacity W	Water flow ℓ/h	Water pressure drop kPa	Total cooling capacity W	sensible cooling capacity W	Water flow ℓ/h	Water pressure drop kPa	Total cooling capacity W	sensible cooling capacity W	Water flow ℓ/h	Water pressure drop kPa	Total cooling capacity W	sensible cooling capacity W	Water flow ℓ/h	Water pressure drop kPa	
FW 01 T1/TV	Max.	1750	1280	301	17	1540	1200	264	13	1310	1120	226	10	1090	1090	188	7
	Med.	1410	1040	242	12	1240	970	213	9	1060	900	181	7	880	880	151	5
	Min.	1180	850	203	9	1040	790	179	7	890	730	152	5	710	670	122	3
FW 02 T1/TV	Max.	2350	1610	403	16	2090	1510	359	13	1810	1400	311	10	1510	1290	260	8
	Med.	2030	1400	348	13	1810	1310	311	10	1570	1220	270	8	1320	1120	226	6
	Min.	1630	1120	279	9	1450	1050	249	7	1260	970	216	5	1050	890	180	4
FW 03 T1/TV	Max.	3290	2260	564	14	2930	2110	503	11	2540	1950	436	9	2110	1790	362	6
	Med.	2670	1820	459	10	2380	1700	408	8	2060	1570	353	6	1680	1420	289	4
	Min.	1990	1360	341	6	1760	1260	302	5	1500	1150	258	4	1320	1080	227	3
FW 04 T1/TV	Max.	4870	3370	835	15	4330	3150	743	12	3750	2920	643	10	3090	2670	530	7
	Med.	3690	2620	632	9	3270	2450	561	8	2800	2260	481	6	2230	2050	388	4
	Min.	2850	1950	489	6	2510	1800	431	5	2100	1640	361	3	1860	1540	319	3
FW 06 T1/TV	Max.	5360	3890	919	18	4770	3650	818	14	4140	3400	710	11	3430	3140	589	8
	Med.	4350	3120	747	12	3870	2920	664	10	3340	2710	574	8	2730	2480	469	5
	Min.	3570	2490	613	9	3170	2320	544	7	2710	2140	466	5	2150	1920	370	4
FW 08 T1/TV	Max.	7520	5250	1289	15	6710	4910	1152	12	5830	4560	1001	9	4830	4170	829	7
	Med.	5930	4110	1016	10	5270	3830	904	8	4530	3530	778	6	3630	3190	624	4
	Min.	4510	3070	774	6	3970	2840	681	5	3310	2570	569	4	2910	2420	500	3
FW 10 T1/TV	Max.	9000	6350	1544	25	8020	5960	1376	20	6960	5560	1196	16	5800	5120	995	11
	Med.	7020	4950	1204	16	6240	4630	1071	13	5390	4300	924	10	4400	3930	756	7
	Min.	4690	3290	804	8	4110	3050	706	6	3430	2780	588	5	2940	2600	505	3

4TW60012-1A (Sheet 5/13)

5 Capacity tables

5 - 1 Cooling Capacity Tables - 2 pipe

Air temperature (°C DB - °C WB) Water temperature (Entering °C - leaving °C) Model	6 - 11						7 - 12						30 - 22						8 - 13						9 - 14					
	Total cooling capacity W	sensible cooling capacity W	Water flow ℓ/h	Water pressure drop kPa	Total cooling capacity W	sensible cooling capacity W	Water flow ℓ/h	Water pressure drop kPa	Total cooling capacity W	sensible cooling capacity W	Water flow ℓ/h	Water pressure drop kPa	Total cooling capacity W	sensible cooling capacity W	Water flow ℓ/h	Water pressure drop kPa	Total cooling capacity W	sensible cooling capacity W	Water flow ℓ/h	Water pressure drop kPa	Total cooling capacity W	sensible cooling capacity W	Water flow ℓ/h	Water pressure drop kPa	Total cooling capacity W	sensible cooling capacity W	Water flow ℓ/h	Water pressure drop kPa		
FW 01 T1V1V	Max.	1520	1450	419	30	2240	2240	30	2240	1370	384	26	2020	1290	347	21	2020	1290	347	21	2020	1290	347	21	2020	1290	347	21		
	Med.	2120	1230	364	24	1960	1170	337	21	1800	1110	309	18	1630	1050	279	15	1630	1050	279	15	1630	1050	279	15	1630	1050	279		
	Min.	1770	1020	304	17	1640	960	282	15	1510	910	259	13	1360	860	234	11	1360	860	234	11	1360	860	234	11	1360	860	234		
FW 02 T1V1V	Max.	3430	1920	589	32	3190	1820	548	28	2940	1730	24	2680	1630	460	20	2680	1630	460	20	2680	1630	460	20	2680	1630	460	20		
	Med.	2940	1660	505	25	2740	1580	471	22	2530	1500	435	19	2310	1410	397	16	2310	1410	397	16	2310	1410	397	16	2310	1410	397		
	Min.	2360	1340	404	17	2200	1270	377	15	2030	1200	349	13	1860	1130	319	11	1860	1130	319	11	1860	1130	319	11	1860	1130	319		
FW 03 T1V1V	Max.	4770	2690	818	27	4450	2550	764	24	4110	2410	20	3760	2280	645	17	3760	2280	645	17	3760	2280	645	17	3760	2280	645	17		
	Med.	3880	2180	665	19	3620	2070	621	16	3350	1960	575	14	3060	1840	526	12	3060	1840	526	12	3060	1840	526	12	3060	1840	526		
	Min.	2890	1630	495	11	2700	1550	463	10	2500	1460	429	9	2290	1370	393	7	2290	1370	393	7	2290	1370	393	7	2290	1370	393		
FW 04 T1V1V	Max.	7110	4000	1220	30	6630	3800	1137	26	6120	3600	1050	22	5580	3400	958	19	5580	3400	958	19	5580	3400	958	19	5580	3400	958		
	Med.	5400	3120	926	18	5030	2960	864	16	4650	2810	798	14	4240	2650	729	12	4240	2650	729	12	4240	2650	729	12	4240	2650	729		
	Min.	4190	2350	719	12	3910	2230	671	10	3620	2110	621	9	3300	1980	567	8	3300	1980	567	8	3300	1980	567	8	3300	1980	567		
FW 06 T1V1V	Max.	7810	4570	1340	34	7280	4350	1249	30	6720	4130	26	6130	3910	1053	22	6130	3910	1053	22	6130	3910	1053	22	6130	3910	1053	22		
	Med.	6350	3690	1090	24	5920	3510	1016	21	5470	3330	939	18	4990	3140	857	15	4990	3140	857	15	4990	3140	857	15	4990	3140	857		
	Min.	5220	2970	895	17	4870	2820	836	15	4500	2670	773	13	4110	2520	706	11	4110	2520	706	11	4110	2520	706	11	4110	2520	706		
FW 08 T1V1V	Max.	10880	6210	1867	29	10160	5900	1743	25	9400	5600	1613	22	8600	5280	1476	19	8600	5280	1476	19	8600	5280	1476	19	8600	5280	1476		
	Med.	8610	4890	1478	19	8040	4650	1381	17	7440	4400	1278	15	6810	4150	1169	12	6810	4150	1169	12	6810	4150	1169	12	6810	4150	1169		
	Min.	6630	3710	1137	12	6190	3520	1062	11	5730	3320	983	9	5230	3120	898	8	5230	3120	898	8	5230	3120	898	8	5230	3120	898		
FW 10 T1V1V	Max.	13100	7470	2246	48	12230	7120	2098	42	11280	6760	1937	36	11110	6840	1909	29	11110	6840	1909	29	11110	6840	1909	29	11110	6840	1909		
	Med.	10270	5860	1762	31	9570	5580	1642	27	8840	5290	1517	24	8680	5370	1491	19	8680	5370	1491	19	8680	5370	1491	19	8680	5370	1491		
	Min.	6950	3950	1193	16	6480	3750	1112	14	5980	3550	1026	12	5850	3540	1004	9	5850	3540	1004	9	5850	3540	1004	9	5850	3540	1004		

4TW60012-1A (Sheet 7/13)

5 Capacity tables

5 - 2 Cooling Capacity Tables - 4-pipe

Air temperature (°C DB - °C WB) Water temperature (Entering °C - leaving °C) Model	22 - 16																
	6 - 11				7 - 12				8 - 13				9 - 14				
	Total cooling capacity W	Seizable cooling capacity W	Water flow ℓ/h	Water pressure drop kPa	Total cooling capacity W	Seizable cooling capacity W	Water flow ℓ/h	Water pressure drop kPa	Total cooling capacity W	Seizable cooling capacity W	Water flow ℓ/h	Water pressure drop kPa	Total cooling capacity W	Seizable cooling capacity W	Water flow ℓ/h	Water pressure drop kPa	
FW 01 FNFV	Max.	850	850	146	5	770	770	132	4	690	690	118	3	620	620	107	3
	Med.	670	640	116	3	620	570	107	3	570	570	98	2	520	520	90	2
	Min.	620	550	107	3	560	560	96	2	520	520	89	2	470	470	81	2
FW 02 FNFV	Max.	1160	1080	199	6	990	990	170	5	900	900	154	4	810	810	140	3
	Med.	980	890	167	5	860	860	148	4	790	790	136	3	720	720	124	3
	Min.	870	740	149	4	740	690	127	3	690	690	118	2	630	630	108	2
FW 03 FNFV	Max.	1680	1430	289	4	1460	1460	251	3	1350	1350	232	3	1240	1240	213	2
	Med.	1440	1180	246	3	1250	1100	214	3	1160	1160	199	2	1070	1070	183	2
	Min.	1230	950	211	3	1080	880	185	2	910	810	157	1	850	850	147	1
FW 04 FNFV	Max.	2420	2120	415	4	2110	2110	363	4	1950	1950	335	3	1790	1790	307	3
	Med.	1980	1720	339	3	1710	1610	294	2	1610	1610	276	2	1480	1480	254	2
	Min.	1740	1350	298	3	1510	1260	260	2	1280	1160	220	1	1220	1220	210	1
FW 06 FNFV	Max.	2750	2500	471	5	2330	2330	400	4	2070	2070	356	3	1900	1900	326	3
	Med.	2140	1960	367	4	1960	1960	336	3	1810	1810	310	3	1660	1660	284	2
	Min.	1940	1630	334	3	1690	1520	289	2	1570	1570	269	2	1440	1440	247	2
FW 08 FNFV	Max.	3790	3330	650	5	3270	3270	561	3	3020	3020	518	3	2760	2760	475	3
	Med.	3130	2660	537	3	2710	2490	465	2	2560	2560	439	2	2350	2350	403	2
	Min.	2720	2120	467	3	2370	1970	407	2	2010	1820	344	1	1930	1930	331	1
FW 10 TN/TV	Max.	4690	4120	803	7	3930	3930	674	5	3480	3480	597	4	3090	3090	530	3
	Med.	3360	3090	576	4	3110	3110	533	3	2870	2870	492	3	2630	2630	451	2
	Min.	2750	2260	472	3	2390	2110	410	2	2160	2160	370	2	1980	1980	340	1

4TW60012-1A (Sheet 2/13)

5 Capacity tables

5 - 2 Cooling Capacity Tables - 4-pipe

Air temperature (°C DB - °C WB) Water temperature (Entering °C - leaving °C)	25 - 18						9 - 14					
	6 - 11		7 - 12		8 - 13		9 - 14		9 - 14		9 - 14	
Model	Total cooling capacity W	Sensible cooling capacity W	Water flow ℓ/h	Water pressure drop kPa	Total cooling capacity W	Sensible cooling capacity W	Water flow ℓ/h	Water pressure drop kPa	Total cooling capacity W	Sensible cooling capacity W	Water flow ℓ/h	Water pressure drop kPa
FW 01 FNFV	Max.	1400	1060	241	11	1190	980	205	9	960	890	6
	Med.	1100	840	188	7	930	770	159	6	740	700	4
	Min.	950	700	163	6	800	640	138	4	660	590	3
FW 02 FNFV	Max.	1830	1400	315	14	1590	1300	272	11	1310	1200	8
	Med.	1560	1160	268	10	1350	1080	231	8	1110	990	6
	Min.	1300	950	223	8	1120	870	192	6	920	790	4
FW 03 FNFV	Max.	2770	1930	474	10	2390	1780	410	8	1970	1610	6
	Med.	2240	1560	384	7	1930	1420	330	5	1550	1270	4
	Min.	1660	1160	285	4	1450	1070	249	3	1290	1000	2
FW 04 FNFV	Max.	4100	2890	703	11	3530	2660	606	9	2880	2410	6
	Med.	3100	2250	532	7	2630	2060	452	5	2070	1840	3
	Min.	2360	1650	405	4	2050	1520	351	3	1820	1430	2
FW 06 FNFV	Max.	4500	3320	772	13	3890	3080	668	10	3200	2810	7
	Med.	3660	2670	628	9	3150	2460	540	7	2530	2220	5
	Min.	2990	2120	513	6	2530	1940	435	5	2040	1740	3
FW 08 FNFV	Max.	6390	4540	1097	11	5530	4180	949	9	4530	3780	6
	Med.	5020	3550	862	7	4290	3240	735	6	3330	2860	4
	Min.	3740	2620	642	4	3210	2390	551	3	2860	2250	3
FW 10 TNFV	Max.	7590	5460	1301	15	6570	5050	1128	12	5430	4610	8
	Med.	5930	4260	1016	10	5090	3930	873	7	4090	3540	5
	Min.	3880	2800	665	5	3260	2550	559	3	2890	2410	3

4TW60012-1A (Sheet 4/13)

5 Capacity tables

5 - 2 Cooling Capacity Tables - 4-pipe

Air temperature (°C DB - °C WB) Water temperature (Entering °C - leaving °C) Model	27 - 19						8 - 13						9 - 14								
	6 - 11		7 - 12		8 - 13		7 - 12		8 - 13		9 - 14		6 - 11		7 - 12		8 - 13		9 - 14		
	Total cooling capacity W	Single cooling capacity W	Water flow ℓ/h	Water pressure drop kPa	Total cooling capacity W	Single cooling capacity W	Water flow ℓ/h	Water pressure drop kPa	Total cooling capacity W	Single cooling capacity W	Water flow ℓ/h	Water pressure drop kPa	Total cooling capacity W	Single cooling capacity W	Water flow ℓ/h	Water pressure drop kPa	Total cooling capacity W	Single cooling capacity W	Water flow ℓ/h	Water pressure drop kPa	
FW 01 FNFV	Max.	1660	1220	285	15	1460	1140	250	12	1240	1060	213	9	1040	1040	178	7	1040	1040	178	7
	Med.	1300	970	223	10	1140	900	196	8	970	840	166	6	810	810	139	4	810	810	139	4
	Min.	1130	810	193	8	990	750	169	6	840	700	144	5	670	640	115	3	670	640	115	3
FW 02 FNFV	Max.	2140	1600	367	18	1900	1510	326	15	1650	1410	283	11	1300	1300	224	7	1300	1300	224	7
	Med.	1820	1330	312	14	1620	1250	278	11	1400	1160	240	9	1160	1070	199	6	1160	1070	199	6
	Min.	1510	1080	260	10	1350	1010	231	8	1170	940	200	6	960	860	165	4	960	860	165	4
FW 03 FNFV	Max.	3220	2210	552	13	2870	2070	493	11	2490	1910	427	8	2060	1750	354	6	2060	1750	354	6
	Med.	2610	1780	449	9	2330	1660	400	8	2010	1530	345	6	1640	1390	282	4	1640	1390	282	4
	Min.	1960	1340	336	6	1730	1240	297	5	1470	1130	253	3	1310	1070	225	3	1310	1070	225	3
FW 04 FNFV	Max.	4780	3310	821	15	4260	3090	730	12	3680	2870	632	9	3030	2620	520	7	3030	2620	520	7
	Med.	3640	2590	625	9	3230	2420	554	7	2760	2230	474	6	2200	2010	377	4	2200	2010	377	4
	Min.	2820	1920	483	6	2480	1780	425	5	2080	1620	357	3	1850	1530	317	3	1850	1530	317	3
FW 06 FNFV	Max.	5250	3800	900	17	4670	3570	802	14	4050	3320	696	11	3360	3060	577	8	3360	3060	577	8
	Med.	4280	3060	735	12	3810	2870	653	10	3290	2660	564	7	2680	2430	461	5	2680	2430	461	5
	Min.	3510	2440	603	8	3110	2280	534	7	2660	2100	457	5	2100	1880	361	3	2100	1880	361	3
FW 08 FNFV	Max.	7430	5190	1275	15	6640	4850	1138	12	5760	4500	990	9	4770	4120	819	7	4770	4120	819	7
	Med.	5880	4080	1010	10	5230	3800	898	8	4500	3510	772	6	3600	3160	618	4	3600	3160	618	4
	Min.	4470	3050	767	6	3930	2820	675	5	3270	2550	562	3	2900	2400	497	3	2900	2400	497	3
FW 10 TN/V	Max.	8840	6240	1516	20	7880	5850	1352	16	6840	5450	1173	12	5690	5020	977	9	5690	5020	977	9
	Med.	6930	4890	1190	13	6160	4570	1057	10	5320	4240	912	8	4340	3880	745	6	4340	3880	745	6
	Min.	4650	3260	797	6	4070	3020	699	5	3390	2750	581	4	2930	2580	503	3	2930	2580	503	3

4TW60012-1A (Sheet 6/13)

5 Capacity tables

5 - 2 Cooling Capacity Tables - 4-pipe

Air temperature (°C DB - °C WB) Water temperature (Entering °C - leaving °C) Model	30 - 22					7 - 12					6 - 11					8 - 13					9 - 14					
	Total cooling capacity W	sensible cooling capacity W	latent heat ℓ/h	Water pressure drop kPa	Water flow ℓ/h	Total cooling capacity W	sensible cooling capacity W	latent heat ℓ/h	Water pressure drop kPa	Water flow ℓ/h	Total cooling capacity W	sensible cooling capacity W	latent heat ℓ/h	Water pressure drop kPa	Water flow ℓ/h	Total cooling capacity W	sensible cooling capacity W	latent heat ℓ/h	Water pressure drop kPa	Water flow ℓ/h	Total cooling capacity W	sensible cooling capacity W	latent heat ℓ/h	Water pressure drop kPa	Water flow ℓ/h	
FW 01 FNVFV	Max.	2510	1440	430	32	2370	1370	398	27	2120	1300	364	23	1910	1230	329	19									
	Med.	1970	1150	337	21	1820	1090	312	18	1670	1030	286	15	1500	980	258	13									
	Min.	1690	970	290	16	1570	920	269	14	1440	870	246	12	1300	820	223	10									
FW 02 FNVFV	Max.	3150	1880	540	35	2920	1790	502	31	2690	1700	462	27	2450	1610	421	23									
	Med.	2660	1570	457	27	2480	1490	425	23	2280	1420	392	20	2080	1340	357	17									
	Min.	2210	1280	379	19	2060	1220	353	17	1900	1150	326	15	1730	1090	297	12									
FW 03 FNVFV	Max.	4670	2630	802	26	4360	2500	748	23	4030	2370	692	20	3680	2230	632	17									
	Med.	3790	2130	650	18	3540	2020	607	16	3280	1910	562	14	2990	1800	514	12									
	Min.	2840	1600	487	11	2660	1520	456	10	2460	1440	422	8	2250	1350	387	7									
FW 04 FNVFV	Max.	6990	3930	1199	29	6510	3740	1117	25	6010	3540	1032	22	5480	3340	941	18									
	Med.	5330	3080	915	18	4970	2930	853	16	4590	2770	789	14	4190	2610	720	12									
	Min.	4140	2320	710	11	3860	2200	663	10	3570	2080	613	9	3260	1950	560	7									
FW 06 FNVFV	Max.	7650	4470	1312	33	7130	4260	1224	29	6580	4040	1130	25	6000	3820	1031	21									
	Med.	6250	3630	1073	23	5830	3450	1001	20	5380	3270	925	18	4920	3090	844	15									
	Min.	5130	2920	880	16	4790	2770	822	14	4430	2620	760	13	4040	2470	694	11									
FW 08 FNVFV	Max.	10760	6140	1846	28	10050	5840	1724	25	9290	5530	1596	21	8500	5220	1460	18									
	Med.	8550	4860	1467	19	7990	4620	1371	17	7390	4370	1269	14	6760	4120	1161	12									
	Min.	6580	3680	1127	12	6140	3490	1054	10	5680	3300	975	9	5180	3100	891	8									
FW 10 TNVTV	Max.	12880	7340	2208	38	12010	7000	2061	34	11090	6640	1904	29	10110	6280	1737	25									
	Med.	10140	5790	1740	25	9450	5510	1622	22	8730	5220	1498	19	7960	4930	1367	16									
	Min.	6900	3920	1183	13	6430	3720	1103	11	5930	3520	1018	10	5400	3310	927	8									

4TW60012-1A (Sheet 8/13)

5 Capacity tables

5 - 3 Capacity Correction Factor

FWV - FWL - FWM	ESP Fan speed	10		20		30		40		50		60	
		F1	F2	F1	F2	F1	F2	F1	F2	F1	F2	F1	F2
FW.01	Max.	0.86	0.91	0.72	0.8	0.56	0.67	-	-	-	-	-	-
	Med.	0.78	0.84	0.56	0.65	0.33	0.41	-	-	-	-	-	-
	Min.	0.71	0.77	0.35	0.4	-	-	-	-	-	-	-	-
FW.02	Max.	0.85	0.89	0.73	0.78	0.61	0.67	0.5	0.57	0.4	0.47	0.31	0.36
	Med.	0.82	0.85	0.63	0.68	0.45	0.5	0.27	0.3	-	-	-	-
	Min.	0.78	0.8	0.55	0.59	0.35	0.37	-	-	-	-	-	-
FW.03	Max.	0.89	0.91	0.77	0.81	0.64	0.69	0.51	0.56	0.36	0.4	0.18	0.21
	Med.	0.82	0.84	0.64	0.67	0.47	0.5	0.29	0.32	-	-	-	-
	Min.	0.75	0.77	0.48	0.5	-	-	-	-	-	-	-	-
FW.04	Max.	0.93	0.95	0.85	0.89	0.77	0.82	0.67	0.73	0.56	0.63	0.42	0.5
	Med.	0.91	0.93	0.81	0.84	0.71	0.75	0.59	0.64	0.46	0.51	0.31	0.35
	Min.	0.84	0.86	0.68	0.71	0.52	0.55	0.34	0.36	-	-	-	-
FW.06	Max.	0.93	0.95	0.85	0.89	0.77	0.81	0.67	0.73	0.56	0.62	0.41	0.47
	Med.	0.92	0.93	0.82	0.86	0.73	0.77	0.61	0.66	0.48	0.53	0.31	0.36
	Min.	0.86	0.88	0.71	0.74	0.56	0.59	0.4	0.43	0.23	0.25	-	-
FW.08	Max.	0.96	0.96	0.91	0.92	0.86	0.88	0.8	0.83	0.74	0.78	0.67	0.71
	Med.	0.95	0.96	0.9	0.92	0.85	0.87	0.79	0.81	0.73	0.76	0.65	0.69
	Min.	0.91	0.92	0.81	0.82	0.71	0.73	0.6	0.62	0.49	0.51	0.37	0.39
FW.10	Max.	0.96	0.97	0.92	0.93	0.87	0.89	0.82	0.85	0.77	0.81	0.72	0.76
	Med.	0.95	0.96	0.9	0.91	0.84	0.86	0.78	0.81	0.71	0.75	0.64	0.68
	Min.	0.92	0.93	0.84	0.86	0.76	0.78	0.67	0.69	0.57	0.6	0.47	0.5

	FW.01		FW.02		FW.03		FW.04		FW.06		FW.08		FW.10	
	medium	low	medium	low	medium	low	medium	low	medium	low	medium	low	medium	low
Total cooling capacity	TCC	0.81	0.68	0.87	0.69	0.81	0.60	0.76	0.58	0.81	0.66	0.79	0.59	0.52
Sensible cooling capacity	SCC	0.81	0.66	0.87	0.70	0.81	0.60	0.78	0.57	0.80	0.64	0.78	0.58	0.51
Heating capacity - 2 pipe	HC2P	0.81	0.66	0.83	0.68	0.81	0.59	0.76	0.58	0.66	0.66	0.79	0.61	0.52
Heating capacity - 4 pipe	HC40	0.85	0.73	0.89	0.78	0.87	0.71	0.83	0.69	0.76	0.86	0.72	0.85	0.66

4TW60018-1

Conditions

Cooling Air: 27°C DB - 19°C WB - Water: entering 7°C - leaving 12°C
 Heating 2-pipe Air: 20°C Water: entering 50°C water flow as for cooling
 Heating 4-pipe Air: 20°C Water: entering 70°C - leaving 60°C

F1 = correction factor for air flow
 F2 = correction factor for capacities

Correction factors are based on an average value. This can cause deviation depending on conditions used. The Fan Coil Selection software will provide an accurate result at all conditions.

5 Capacity tables

5 - 3 Capacity Correction Factor

Cooling mode

Glycol percentage in weight	Freezing temperature (°C)	Capacity correction factor	Pressure drop correction factor
0	0	1	1.00
10	-4	0.93	1.09
20	-10	0.84	1.18
30	-16	0.76	1.27
40	-24	0.76	1.36

Heating mode

Glycol percentage in weight	Freezing temperature (°C)	Capacity correction factor	Pressure drop correction factor
0	0	1	1.00
10	-4	0.98	1.08
20	-10	0.97	1.11
30	-16	0.94	1.22
40	-24	0.91	1.33

4TW60228-1B

Correction factors are based on an average value (at rated water flow rate). This can cause deviation depending on conditions used. The Fan Coil Selection software will provide an accurate result at all conditions.

5 Capacity tables

5 - 4 Heating Capacity Tables - 2-pipe

Air temperature (°C) Water temperature (Entering °C - leaving °C)		20															
		45 - 40				60 - 50				70 - 60				90 - 70			
		Heating capacity W	Water flow ℓ/h	Water pressure drop kPa	Water pressure drop	Heating capacity W	Water flow ℓ/h	Water pressure drop kPa	Water pressure drop	Heating capacity W	Water flow ℓ/h	Water pressure drop kPa	Water pressure drop	Heating capacity W	Water flow ℓ/h	Water pressure drop kPa	Water pressure drop
FW 01 TIV/V	Max.	1820	317	15	2840	249	10	3710	325	15	4940	218	7				
	Med.	1480	256	11	2310	201	7	2990	263	10	4010	177	5				
	Min.	1210	211	8	1900	166	5	2470	216	7	3320	147	3				
FW 02 TIV/V	Max.	2150	373	12	3360	293	7	4350	382	11	5880	257	5				
	Med.	1810	315	9	2840	248	6	3670	322	8	4940	218	4				
	Min.	1500	260	6	2350	206	4	3040	267	6	4110	181	3				
FW 03 TIV/V	Max.	3200	556	11	5030	439	7	6460	567	11	8760	386	5				
	Med.	2580	449	8	4070	356	5	5220	458	7	7110	314	4				
	Min.	1910	332	5	3020	264	3	3860	339	4	5290	233	2				
FW 04 TIV/V	Max.	4730	823	12	7420	648	8	9570	840	12	12890	569	6				
	Med.	3610	628	8	5690	497	5	7300	641	7	9910	437	4				
	Min.	2760	480	5	4360	381	3	5590	490	5	7620	336	2				
FW 06 TIV/V	Max.	5360	932	15	8410	735	9	10850	952	14	14620	645	7				
	Med.	4390	763	11	6900	603	7	8860	778	10	12020	530	5				
	Min.	3570	620	7	5630	491	5	7200	632	7	9810	433	3				
FW 08 TIV/V	Max.	6490	1129	10	10170	889	6	13130	1152	9	17650	779	4				
	Med.	5170	898	7	8100	708	4	10460	918	6	14100	623	3				
	Min.	3970	690	4	6230	544	3	8060	707	4	10880	480	2				
FW 10 TIV/V	Max.	8400	1460	19	13130	1147	12	17000	1492	18	22760	1005	8				
	Med.	6530	1135	12	10220	893	7	13200	1158	11	17740	783	5				
	Min.	4930	764	6	6890	602	4	8910	782	6	12020	531	3				

4TW60012-1A (Sheet 9/13)

5 Capacity tables

5 - 4 Heating Capacity Tables - 2-pipe

Air temperature (°C) Water temperature (Entering °C - leaving °C)		22															
		45 - 40				60 - 50				70 - 60				90 - 70			
		Heating capacity W	Water flow ℓ/h	Water pressure drop kPa	Water pressure drop	Heating capacity W	Water flow ℓ/h	Water pressure drop kPa	Water pressure drop	Heating capacity W	Water flow ℓ/h	Water pressure drop kPa	Water pressure drop	Heating capacity W	Water flow ℓ/h	Water pressure drop kPa	Water pressure drop
FW 01 TIV	Max.	1650	287	13	2670	233	9	3530	310	13	4750	210	7				
	Med.	1330	232	9	2160	189	6	2850	250	9	3860	170	5				
	Min.	1100	191	6	1780	156	4	2350	206	7	3190	141	3				
FW 02 TIV	Max.	1950	338	10	3150	275	7	4140	363	10	5610	248	5				
	Med.	1640	285	7	2660	233	5	3500	307	8	4760	210	4				
	Min.	1360	236	5	2210	193	4	2890	254	6	3950	174	3				
FW 03 TIV	Max.	2900	505	10	4730	413	6	6150	540	10	8430	372	5				
	Med.	2340	407	7	3820	334	4	4970	436	7	6840	302	3				
	Min.	1730	302	4	2840	248	3	3670	322	4	5090	225	2				
FW 04 TIV	Max.	4290	746	10	6970	609	7	9110	799	11	12410	548	5				
	Med.	3280	570	6	5340	466	4	6960	610	7	9540	421	3				
	Min.	2500	436	4	4090	357	3	5320	467	4	7330	324	2				
FW 06 TIV	Max.	4860	846	13	7900	690	8	10330	906	13	14080	622	6				
	Med.	3980	693	9	6490	567	6	8440	740	9	11570	511	5				
	Min.	3240	562	6	5280	461	4	6850	601	6	9450	417	3				
FW 08 TIV	Max.	5890	1024	8	9550	834	5	12500	1097	9	17000	750	4				
	Med.	4680	813	6	7600	664	4	9960	874	6	13580	600	3				
	Min.	3590	625	3	5840	510	2	7670	673	4	10460	462	2				
FW 10 TIV	Max.	7610	1323	16	12320	1077	10	16190	1420	16	21920	968	8				
	Med.	5920	1029	10	9600	839	7	12570	1102	10	17080	754	5				
	Min.	3980	692	5	6460	565	3	8490	744	5	11570	511	3				

4TW60012-1A (Sheet 10/13)

5 Capacity tables

5 - 5 Heating Capacity Tables - 4-pipe

Air temperature (°C) Water temperature (Entering °C - leaving °C)		20											
		45 - 40			60 - 50			70 - 60			90 - 70		
Model	Air flow m ³ /h	Heating capacity W	Water flow ℓ/h	Water pressure drop kPa	Heating capacity W	Water flow ℓ/h	Water pressure drop kPa	Heating capacity W	Water flow ℓ/h	Water pressure drop kPa	Heating capacity W	Water flow ℓ/h	Water pressure drop kPa
FW 01 FNVFV	Max.	920	161	6	1420	124	3	1900	167	6	2470	109	3
	Med.	820	143	5	1270	111	3	1700	149	5	2220	98	2
	Min.	720	126	4	1110	97	2	1500	132	4	1950	86	2
FW 02 FNVFV	Max.	980	170	8	1500	131	5	2010	176	7	2600	115	3
	Med.	860	150	6	1330	116	4	1780	156	6	2310	102	3
	Min.	750	131	5	1160	101	3	1560	137	5	2020	89	2
FW 03 FNVFV	Max.	1470	255	5	2240	196	3	3080	270	5	3960	175	2
	Med.	1260	220	4	1930	169	2	2680	235	4	3420	151	2
	Min.	1030	179	3	1570	137	2	2180	191	3	2780	123	1
FW 04 FNVFV	Max.	2460	427	13	3790	331	8	5050	443	12	6580	290	6
	Med.	2070	360	9	3200	280	6	4250	373	9	5560	245	4
	Min.	1750	304	7	2710	237	4	3600	316	7	4730	209	3
FW 06 FNVFV	Max.	2580	448	10	3970	347	6	5300	465	10	6890	304	5
	Med.	2260	393	8	3490	305	5	4650	408	8	6060	268	4
	Min.	1970	343	6	3050	266	4	4040	355	6	5290	234	3
FW 08 FNVFV	Max.	3890	675	31	6020	526	19	7910	694	30	10410	460	14
	Med.	3360	584	24	5210	456	15	6830	600	23	9020	398	11
	Min.	2800	486	18	4350	380	11	5690	499	17	7540	333	8
FW 10 TNVTV	Max.	4560	793	37	7060	617	23	9300	816	36	12210	539	17
	Med.	3910	679	28	6050	529	17	7950	698	27	10470	462	13
	Min.	3010	523	18	4680	409	11	6120	537	17	8100	358	8

4TW60012-1A (Sheet 11/13)

5 Capacity tables

5 - 5 Heating Capacity Tables - 4-pipe

Air temperature (°C) Water temperature (Entering °C - leaving °C)		22						70 - 60						90 - 70					
		45 - 40		60 - 50		70 - 60		90 - 70		45 - 40		60 - 50		70 - 60		90 - 70			
Model	Heating capacity W	Water flow ℓ/h	Water pressure drop kPa	Heating capacity W	Water flow ℓ/h	Water pressure drop kPa	Heating capacity W	Water flow ℓ/h	Water pressure drop kPa	Heating capacity W	Water flow ℓ/h	Water pressure drop kPa	Heating capacity W	Water flow ℓ/h	Water pressure drop kPa	Heating capacity W	Water flow ℓ/h	Water pressure drop kPa	
FW 01 FNFV	Max.	830	5	1320	115	3	1810	159	5	2370	105	2							
	Med.	740	4	1180	103	2	1620	142	4	2130	94	2							
	Min.	650	113	1040	91	2	1430	125	3	1870	83	2							
FW 02 FNFV	Max.	870	152	1400	122	4	1910	167	7	2500	110	3							
	Med.	770	134	1230	108	3	1690	148	6	2220	98	3							
	Min.	670	117	1080	94	3	1480	130	4	1940	86	2							
FW 03 FNFV	Max.	1300	227	2080	181	3	2930	257	5	3790	167	2							
	Med.	1120	195	1790	156	2	2530	222	4	3270	144	2							
	Min.	910	158	1450	127	1	2060	181	3	2660	118	1							
FW 04 FNFV	Max.	2210	385	3540	310	7	4800	421	11	6320	279	5							
	Med.	1860	324	2990	261	5	4040	354	8	5340	236	4							
	Min.	1570	273	2520	220	4	3420	300	6	4550	201	3							
FW 06 FNFV	Max.	2320	403	3710	324	6	5040	442	9	6630	292	4							
	Med.	2040	354	3260	285	4	4420	387	7	5830	257	3							
	Min.	1770	308	2840	248	3	3840	337	6	5090	225	3							
FW 08 FNFV	Max.	3510	610	5640	493	17	7530	660	27	10020	443	13							
	Med.	3040	528	4890	427	13	6500	570	21	8680	383	10							
	Min.	2530	440	4080	356	10	5410	475	15	7260	320	7							
FW 10 TNVTV	Max.	4120	717	6610	578	20	8850	777	33	11750	519	16							
	Med.	3530	614	5670	495	16	7570	664	25	10080	445	12							
	Min.	2720	473	4380	383	10	5820	511	16	7800	344	8							

4TW60012-1A (Sheet 12/13)

5 Capacity tables

5 - 6 Power consumption - 2-pipe

FWV-FWL-FWM

FW01	MAX		MED		MIN	
	Power input (W)	Current (A)	Power input (W)	Current (A)	Power input (W)	Current (A)
0	37	0.170	28	0.130	21	0.100
10	37	0.160	26	0.120	21	0.090
20	35	0.150	25	0.110	20	0.088
30	35	0.150	24	0.110		
45	34	0.140				
50	33	0.140				

4TW60011-2B (1/14)

FWV-FWL-FWM

FW02	MAX		MED		MIN	
	Power input (W)	Current (A)	Power input (W)	Current (A)	Power input (W)	Current (A)
0	53	0.240	36	0.160	24	0.110
10	52	0.235	32	0.142	21	0.096
20	48	0.217	31	0.138	21	0.096
30	46	0.208	31	0.138	20	0.092
40	46	0.208	30	0.133		

4TW60011-2B (2/14)

5 Capacity tables

5 - 6 Power consumption - 2-pipe

FWV-FWL-FWM

FW03 AP (Pa)	MAX		MED		MIN	
	Power input (W)	Current (A)	Power input (W)	Current (A)	Power input (W)	Current (A)
0	56	0.252	43	0.200	29	0.138
10	55	0.248	42	0.195	29	0.134
20	53	0.239	41	0.191	29	0.131
30	53	0.239	41	0.191	28	0.130
40	52	0.234	40	0.186		
50	51	0.230				

4TW60011-2B (3/14)

FWV-FWL-FWM

FW04 AP (Pa)	MAX		MED		MIN	
	Power input (W)	Current (A)	Power input (W)	Current (A)	Power input (W)	Current (A)
0	98	0.440	61	0.287	38	0.192
10	94	0.422	59	0.276	37	0.187
20	92	0.413	57	0.259	36	0.182
30	90	0.404	55	0.254	34	0.172
40	88	0.395	53	0.242	31	0.157
50	85	0.382	50	0.228		
60	81	0.364	45	0.211		
70	76	0.341				
75	74	0.332				

4TW60011-2B (4/14)

5 Capacity tables

5 - 6 Power consumption - 2-pipe

FWV-FWL-FWM

FW06	MAX		MED		MIN	
	Power input (W)	Current (A)	Power input (W)	Current (A)	Power input (W)	Current (A)
0	98	0.430	68	0.310	47	0.220
10	96	0.421	67	0.305	45	0.211
20	94	0.412	64	0.292	44	0.206
30	91	0.399	62	0.283	43	0.201
40	90	0.395	61	0.278	42	0.197
50	89	0.391	59	0.269		
60	86	0.377	56	0.255		
70	82	0.360				

4TW60011-2B (5/14)

FWV-FWL-FWM

FW08	MAX		MED		MIN	
	Power input (W)	Current (A)	Power input (W)	Current (A)	Power input (W)	Current (A)
0	137	0.600	104	0.457	76	0.338
10	133	0.585	103	0.452	75	0.333
20	129	0.569	102	0.446	73	0.328
30	126	0.550	98	0.430	72	0.319
40	122	0.531	95	0.414	70	0.310
50	117	0.511	92	0.400	67	0.297
60	113	0.491	88	0.386		
70	108	0.471	83	0.364		
80	103	0.450				
90	96	0.418				
100	88	0.385				

4TW60011-2B (6/14)

5 Capacity tables

5 - 6 Power consumption - 2-pipe

FWV-FWL-FWM

FW10 AP (Pa)	MAX		MED		MIN	
	Power input (W)	Current (A)	Power input (W)	Current (A)	Power input (W)	Current (A)
0	175	0.764	130	0.578	90	0.414
10	170	0.742	128	0.567	88	0.405
20	165	0.720	125	0.556	86	0.396
30	161	0.701	121	0.536	84	0.386
40	156	0.681	116	0.516	82	0.377
50	150	0.655	112	0.496	79	0.363
60	144	0.629	107	0.476		
70	139	0.605	102	0.451		
80	133	0.581	96			
90	127	0.552	92			
100	120	0.524				

4TW60011-2B (7/14)

5 Capacity tables

5 - 7 Power consumption - 4-pipe

FWV-FWL-FWM

FW01	MAX		MED		MIN	
	Power input (W)	Current (A)	Power input (W)	Current (A)	Power input (W)	Current (A)
0	37	0.170	28	0.130	21	0.100
10	37	0.160	26	0.120	21	0.090
20	35	0.150	25	0.110	20	0.088
30	35	0.150	24	0.110		
45	34	0.140				
50	33	0.140				

4TW60011-2B (8/14)

FWV-FWL-FWM

FW02	MAX		MED		MIN	
	Power input (W)	Current (A)	Power input (W)	Current (A)	Power input (W)	Current (A)
0	53	0.240	36	0.160	24	0.110
10	52	0.235	32	0.142	21	0.096
20	48	0.217	31	0.138	21	0.096
30	46	0.208	31	0.138	20	0.092
40	46	0.208	30	0.133		

4TW60011-2B (9/14)

5 Capacity tables

5 - 7 Power consumption - 4-pipe

FWV-FWL-FWM

FW03 AP (Pa)	MAX		MED		MIN	
	Power input (W)	Current (A)	Power input (W)	Current (A)	Power input (W)	Current (A)
0	56	0.252	43	0.200	29	0.138
10	55	0.248	42	0.195	29	0.134
20	53	0.239	41	0.191	29	0.131
30	53	0.239	41	0.191	28	0.130
40	52	0.234	40	0.186		
50	51	0.230				

4TW60011-2B (10/14)

FWV-FWL-FWM

FW04 AP (Pa)	MAX		MED		MIN	
	Power input (W)	Current (A)	Power input (W)	Current (A)	Power input (W)	Current (A)
0	98	0.440	61	0.287	38	0.192
10	94	0.422	59	0.276	37	0.187
20	92	0.413	57	0.259	36	0.182
30	90	0.404	55	0.254	34	0.172
40	88	0.395	53	0.242	31	0.157
50	85	0.382	50	0.228		
60	81	0.364	45	0.211		
70	76	0.341				
75	74	0.332				

4TW60011-2B (11/14)

5 Capacity tables

5 - 7 Power consumption - 4-pipe

FWV-FWL-FWM

FW06 AP (Pa)	MAX		MED		MIN	
	Power input (W)	Current (A)	Power input (W)	Current (A)	Power input (W)	Current (A)
0	98	0.430	68	0.310	47	0.220
10	96	0.421	67	0.305	45	0.211
20	94	0.412	64	0.292	44	0.206
30	91	0.399	62	0.283	43	0.201
40	90	0.395	61	0.278	42	0.197
50	89	0.391	59	0.269		
60	86	0.377	56	0.255		
70	82	0.360				

4TW60011-2B (12/14)

FWV-FWL-FWM

FW08 AP (Pa)	MAX		MED		MIN	
	Power input (W)	Current (A)	Power input (W)	Current (A)	Power input (W)	Current (A)
0	137	0.600	104	0.457	76	0.338
10	133	0.585	103	0.452	75	0.333
20	129	0.569	102	0.446	73	0.328
30	126	0.550	98	0.430	72	0.319
40	122	0.531	95	0.414	70	0.310
50	117	0.511	92	0.400	67	0.297
60	113	0.491	88	0.386		
70	108	0.471	83	0.364		
80	103	0.450				
90	96	0.418				
100	88	0.385				

4TW60011-2B (13/14)

5 Capacity tables

5 - 7 Power consumption - 4-pipe

FWV-FWL-FWM

FW10 AP (Pa)	MAX		MED		MIN	
	Power input (W)	Current (A)	Power input (W)	Current (A)	Power input (W)	Current (A)
0	175	0.764	130	0.578	90	0.414
10	170	0.742	128	0.567	88	0.405
20	165	0.720	125	0.556	86	0.396
30	161	0.701	121	0.536	84	0.386
40	156	0.681	116	0.516	82	0.377
50	150	0.655	112	0.496	79	0.363
60	144	0.629	107	0.476		
70	139	0.605	102	0.451		
80	133	0.581	96			
90	127	0.552	92			
100	120	0.524				

4TW60011-2B (14/14)

6 Dimensional drawings

6 - 1 Dimensional Drawings

FWV - FWL

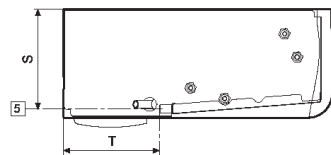
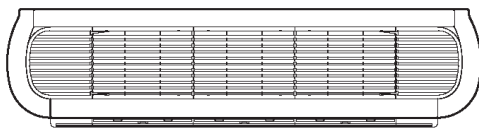
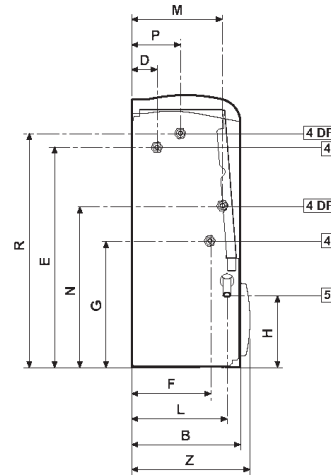
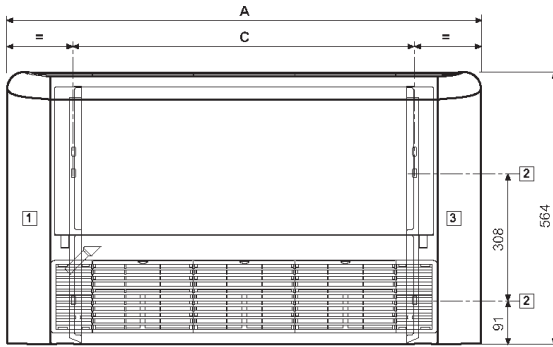
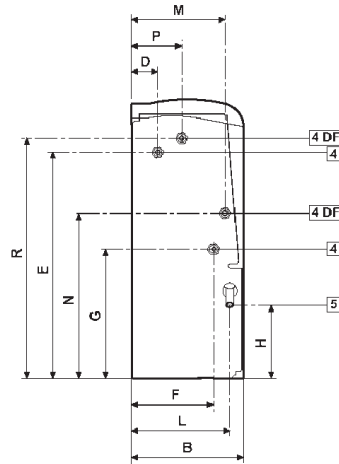
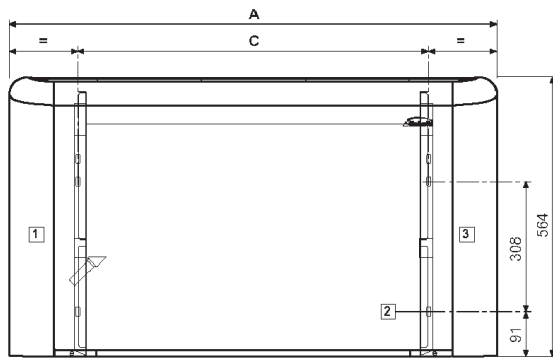

	A	B	C	D	E	F	G	H	L	M	N	P	R	S	T	Z
FWV+FWL 01+02	774	226	498	51	458	163	263	149	198	187	335	99	486	208	198	246
FWV+FWL 03	984	226	708	51	458	163	263	149	198	187	335	99	486	208	198	246
FWV+FWL 04+06	1194	226	918	51	458	163	263	149	198	187	335	99	486	208	198	246
FWV+FWL 08+10	1404	251	1128	48	497	185	259	155	220	195	348	120	478	234	208	271

Legend

- 1 Clear space for hydraulic connections (*)
- 2 Slots for wall / ceiling mounting 9x20mm
- 3 Clear space for electric connections (*)
- 4 Hydraulic connections (4DF = 4 pipe system)
- 5 Condensate drainage for vertical installation
- 6 Air outlet for concealed models
- 7 Air suction for concealed models
- 8 Condensate drainage for horizontal installation
- 9 Air outlet
- 10 Air inlet

Hydraulic connections

Standard heat exchanger: connection female

FW01	FW02	FW03	FW04	FW06	FW08	FW10
1/2"	1/2"	1/2"	1/2"	1/2"	3/4"	3/4"

Additional heat exchanger: connection female

FW01	FW02	FW03	FW04	FW06	FW08	FW10
1/2"	1/2"	1/2"	1/2"	1/2"	1/2"	1/2"

(*) Indications applicable to fan coils with hydraulic connections on the left side; in case of right side connections the indications for "clear space" are reversed.

7 Wiring diagrams

7 - 1 Wiring Diagrams - Single Phase

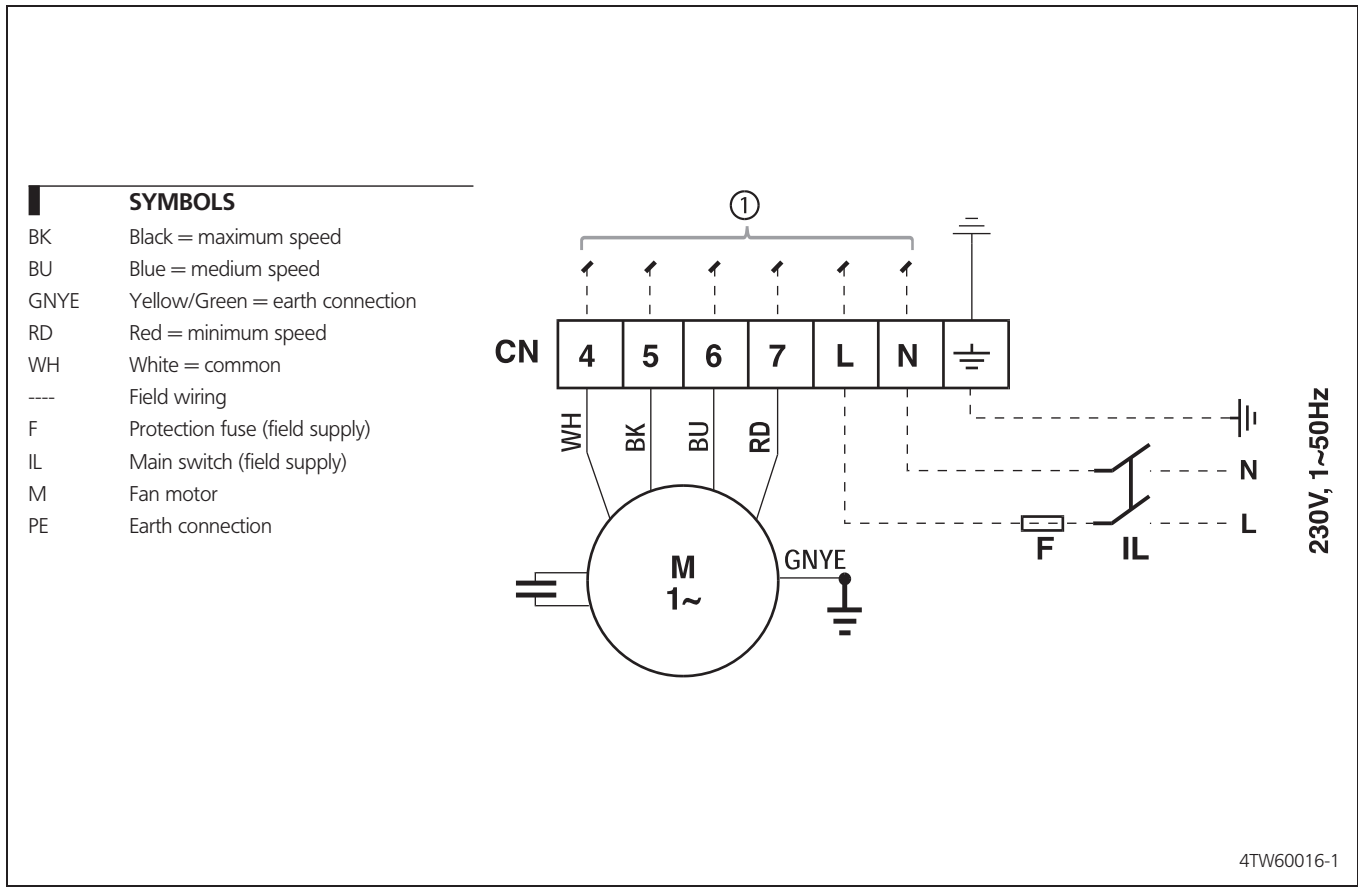

8 Sound data

8 - 1 Sound Level Data - 2-pipe

FWV-FWL-FWM

Sound power level and spectrum								
FW01 TN/TV								
Sound power levels dBA	125 Hz	250 Hz	500 Hz	1000 Hz	2000 Hz	4000 Hz	8000 Hz	Global Lw
max	24.8	39.1	41.7	38.4	33.7	21.6	15.6	45
med	19.4	34.1	35.9	30.3	24.3	15.8	15.4	39
min	13.6	29.7	29.0	22.0	16.2	15.2	15.2	33
FW02 TN/TV								
Sound power levels dBA	125 Hz	250 Hz	500 Hz	1000 Hz	2000 Hz	4000 Hz	8000 Hz	Global Lw
max	28.8	42.7	45.8	43.6	39.3	29.9	17.2	50
med	22.9	37.8	40.7	36.2	30.3	19.6	15.4	44
min	18.0	33.1	35.4	29.1	22.7	15.5	15.3	38
FW03 TN/TV								
Sound power levels dBA	125 Hz	250 Hz	500 Hz	1000 Hz	2000 Hz	4000 Hz	8000 Hz	Global Lw
max	27.8	40.9	43.5	40.4	34.0	23.4	18.0	47
med	23.0	36.0	37.9	33.0	25.7	18.4	16.6	41
min	15.6	28.8	28.8	22.0	17.2	16.0	15.6	33
FW04 TN/TV								
Sound power levels dBA	125 Hz	250 Hz	500 Hz	1000 Hz	2000 Hz	4000 Hz	8000 Hz	Global Lw
max	31.7	45.4	47.7	45.4	41.7	32.0	19.2	52
med	23.6	37.6	39.8	34.2	28.7	21.6	16.5	43
min	17.8	31.8	31.5	24.4	17.2	16.5	15.4	35
FW06 TN/TV								
Sound power levels dBA	125 Hz	250 Hz	500 Hz	1000 Hz	2000 Hz	4000 Hz	8000 Hz	Global Lw
max	36.1	49.3	51.4	50.6	47.4	39.1	24.7	56
med	28.9	43.0	45.2	42.3	36.1	28.1	17.9	49
min	23.7	37.4	39.8	34.4	28.6	21.9	16.8	43
FW08 TN/TV								
Sound power levels dBA	125 Hz	250 Hz	500 Hz	1000 Hz	2000 Hz	4000 Hz	8000 Hz	Global Lw
max	37.1	51.3	52.8	51.6	49.8	43.5	32.3	58
med	30.6	44.9	46.4	44.7	42.1	33.2	20.9	51
min	24.8	38.8	39.1	37.4	32.6	22.8	18.2	44
FW10 TN/TV								
Sound power levels dBA	125 Hz	250 Hz	500 Hz	1000 Hz	2000 Hz	4000 Hz	8000 Hz	Global Lw
max	42.6	56.0	58.2	58.4	56.5	51.7	44.4	64
med	36.6	49.6	52.9	51.6	49.5	43.2	32.7	57
min	27.8	42.3	43.8	41.7	38.3	28.6	20.7	48

NOTES

To calculate the sound pressure you must define some conditions and use this formula

$$L_p = L_w - 10 \times \log_{10} \left(\frac{4\pi \times d^2}{Q} \right)$$

Where: **Q** = direction factor: is Q=4 if the FCU is installed near 2 walls (vertical or floor-ceiling). Q=2 if the FCU is installed near 1 wall (at floor or ceiling but faraway the 2° wall)

d = distance (mt) from the sound source and the measure point

Lp = sound pressure (dBA)

Lw = sound power (dBA)

Conditions of measurements:

ISO3741 : In case of (M) models, the sound power is calculated WITHOUT any additional inlet or outlet grill or plenum!

8 Sound data

8 - 2 Sound Level Data - 4-pipe

FWV-FWL-FWM

Sound power level and spectrum								
FW01 FN/FV								
Sound power levels dBA	125 Hz	250 Hz	500 Hz	1000 Hz	2000 Hz	4000 Hz	8000 Hz	Global Lw
max	24.8	39.1	41.7	38.4	33.7	21.6	15.6	45
med	19.4	34.1	35.9	30.3	24.3	15.8	15.4	39
min	13.6	29.7	29.0	22.0	16.2	15.2	15.2	33
FW02 FN/FV								
Sound power levels dBA	125 Hz	250 Hz	500 Hz	1000 Hz	2000 Hz	4000 Hz	8000 Hz	Global Lw
max	28.8	42.7	45.8	43.6	39.3	29.9	17.2	50
med	22.9	37.8	40.7	36.2	30.3	19.6	15.4	44
min	18.0	33.1	35.4	29.1	22.7	15.5	15.3	38
FW03 FN/FV								
Sound power levels dBA	125 Hz	250 Hz	500 Hz	1000 Hz	2000 Hz	4000 Hz	8000 Hz	Global Lw
max	27.8	40.9	43.5	40.4	34.0	23.4	18.0	47
med	23.0	36.0	37.9	33.0	25.7	18.4	16.6	41
min	15.6	28.8	28.8	22.0	17.2	16.0	15.6	33
FW04 FN/FV								
Sound power levels dBA	125 Hz	250 Hz	500 Hz	1000 Hz	2000 Hz	4000 Hz	8000 Hz	Global Lw
max	31.7	45.4	47.7	45.4	41.7	32.0	19.2	52
med	23.6	37.6	39.8	34.2	28.7	21.6	16.5	43
min	17.8	31.8	31.5	24.4	17.2	16.5	15.4	35
FW06 FN/FV								
Sound power levels dBA	125 Hz	250 Hz	500 Hz	1000 Hz	2000 Hz	4000 Hz	8000 Hz	Global Lw
max	36.1	49.3	51.4	50.6	47.4	39.1	24.7	56
med	28.9	43.0	45.2	42.3	38.1	28.1	17.9	49
min	23.7	37.4	39.8	34.4	28.6	21.9	16.8	43
FW08 FN/FV								
Sound power levels dBA	125 Hz	250 Hz	500 Hz	1000 Hz	2000 Hz	4000 Hz	8000 Hz	Global Lw
max	37.1	51.3	52.8	51.6	49.8	43.5	32.3	58
med	30.6	44.9	46.4	44.7	42.1	33.2	20.9	51
min	24.8	38.8	39.1	37.4	32.6	22.8	18.2	44
FW10 FN/FV								
Sound power levels dBA	125 Hz	250 Hz	500 Hz	1000 Hz	2000 Hz	4000 Hz	8000 Hz	Global Lw
max	42.6	56.0	58.2	58.4	56.5	51.7	44.4	64
med	36.6	49.6	52.9	51.6	49.5	43.2	32.7	57
min	27.8	42.3	43.8	41.7	38.3	28.6	20.7	48

NOTES

To calculate the sound pressure you must define some conditions and use this formula

$$L_p = L_w - 10 \times \log_{10} \left(\frac{4\pi \times d^2}{Q} \right)$$

- Where: **Q** = direction factor: is Q=4 if the FCU is installed near 2 walls (vertical or floor-ceiling). Q=2 if the FCU is installed near 1 wall (at floor or ceiling but faraway the 2° wall)
d = distance (mt) from the sound source and the measure point
Lp = sound pressure (dBA)
Lw = sound power (dBA)

Conditions of measurements:

ISO3741 : In case of (M) models, the sound power is calculated WITHOUT any additional inlet or outlet grill or plenum

9 Installation

9 - 1 Installation Method

Fan coil units should be installed in a position where they heat and cool the room evenly, on walls or ceilings that can bear their weight. Fit any accessories on the standard unit before installing it. Read the relevant technical sheets for the installation and use of the accessories. Keep free space around the fan coil to allow proper operation and ordinary and extraordinary maintenance (see the "9. Dimensional drawings") Provide a panel to reach the unit in case of recessed mounting (Concealed models). Install the remote control panel, if any, in a position that can easily be reached by the user to set the functions and that is suitable for the proper detection of the temperature, if provided.

Therefore avoid:

- positions directly exposed to sunlight;
- positions exposed to hot or cold draughts;
- obstacles preventing the proper temperature detection

If the system is shut down during the winter months, drain off the water from the system to prevent damage due to freezing; if antifreeze solutions are used, check the freezing point using the table shown on technical manual.

Keep at least 100 mm of free space at air inlet for a proper air suction and an easy removal of the filter.

For ducted units the outlet/inlet grill surface must be at least equal to the outlet/inlet surface of the unit to avoid extra noise and strong performance reduction.

BEFORE THE INSTALLATION

Installation and maintenance should be carried out by technical personnel qualified for this type of machine, in compliance with current safety regulations.

For installation and use of possible accessories please refer to the pertinent technical sheets.

In choosing where to install the unit, comply with the following points:

- the heating unit should not be placed immediately under a socket
- do not install the unit in rooms where inflammable gases are present
- do not let water is sprayed directly on the unit
- install the unit on ceilings or walls that bear its weight. Leave enough space all around for proper operation and maintenance of the unit.

Keep the unit in its packaging until it is ready to be installed, to prevent dust getting inside it.

INSTALLATION WARNING:

On the fan coil install a switch (IL) and/or all remote controls in a position out of the reach of persons who are in a bathtub or shower.

In case of ceiling-mounted models, check that the installation height does not exceed the maximum height shown in 7. Dimensional drawings in order to avoid excessive hot air stratification in the upper part of the room; in case of greater installation heights we suggest to proceed with the back suction from the lower part of the room. The installation heights shown in the figure refer to the maximum running speed.

Carry out the hydraulic connections to the heat exchanger and in case of cooling operation, to the water drainage system. We suggest to provide for the water inlet from the bottom side of the heat exchanger and the outlet on the upper side. Bleed the air from the heat exchanger operating on the air-vent valves (10 hexagon wrench) located beside the water connections of the heat exchanger. For a better water drainage lean the drain pipe downwards at least 3 cm/m avoiding loops or narrowing on its way.

INSTALLATION FOR THE CONCEALED CEILING MODEL

The air outlets should not be placed immediately under a socket. For the concealed ceiling model, perform the connection between the fan coil and the ducts, and place damping material between the duct and the unit. The ducts, in particular the outlet ones, must be insulated. In order to avoid air back suction on the fan coil, keep a minimum distance between the air outlet and recovered air flow as shown in installation manual of the unit. The minimum installation height should not be lower than 1.8 metres from floor level. Provide for an inspection port to the unit.

9 Installation

9 - 1 Installation Method

ELECTRICAL CONNECTIONS

Carry out the electrical wiring after having turned the power off in compliance with the relevant local and national regulations following the relevant wiring diagram.

Check that the power supply corresponds to the rated power reported on the unit nameplate.

Each fan coil requires a switch (IL) on the feeder line with a distance of at least 3 mm between the opening contacts, and a suitable safety fuse (F).

USE

To use the fan coil unit, refer to the instructions of the control panel, available as accessory.

Air outlet grids on the cover cabinet (wall mounted and floor/ceiling mounted) can be turned 180° to direct the flow into the room or towards the wall on which the unit is mounted. The grids and the side doors are snapped into the cabinet. Before removing them in order to change their position, cut the power off and wear protective gloves.

MAINTENANCE

For safety reasons before carrying out any maintenance or cleaning operation, switch off the unit turning the selection switch to "Stop" and the power supply switch on position 0 (OFF).

Be careful during any maintenance operation; you could get injured by some metal parts; use protective work gloves. The fan coils do not require any particular maintenance operation: only the periodical cleaning of the air filter should be carried out. It is necessary to carry out a running in period of 100 hours in order to eliminate all mechanical friction. The starting up must be carried out at the maximum speed.

For good operation of the fan coils follow the instructions below:

- keep the air filter clean;
- do not pour liquids into the unit;
- do not introduce metal parts through the air outlet grid;
- keep the air inlet and outlet free at all times.

Each time the machine is turned on after being idle for a long period, ensure there is no air in the heat exchanger. Before using the unit for air conditions, check that:

- condensate drainage is performed correctly;
- the heat exchanger fins are not obstructed by deposits of dirt.

If necessary clean the fins with low pressure compressed air or steam without damaging them.

CLEANING

For safety reasons before carrying out any maintenance or cleaning operation switch off the unit turning the selection switch to "Stop" and the power supply switch on 0 (OFF).

Clean the filter at least once a month and in any case before using the unit (before the heating or the air conditioning season).

For cleaning the air filter proceed as follows (pictures see manual of units):

- Floor models: turn the screws 90°, which secure the filter to the cover cabinet, to 1/4 turn and remove the filter;
- Concealed models: reach the fan coil through the inspection panel and remove the filter, turning the locking brackets 90°;
- Floor ceiling: remove the air filters that are inside the intake grids located on the front panel of the cover cabinet;
- clean the filter with lukewarm water, or in case of dry dust, with compressed air;
- reassemble the filter after having dried it up

It is recommended to replace the air filter yearly, and to use original spare parts; the fan coil model is reported on the nameplate located on the internal part of the side panel of the unit.

To clean the unit cabinet proceed as follows

- use a soft cloth;
- do not pour any liquid on the unit, as this could cause electrical shocks or damage the components inside it;
- do not use any aggressive chemical solvents; do not use very hot water to clean the air outlet grid

Note: this is only based text and should be combined with manuals for relative pictures and additional information.

10 Operation range

10 - 1 Operation Range

Minimum water temperature	+5°C
Maximum water temperature	+95°C
Maximum operating pressure	10 bar
Minimum air inlet temperature	5°C
Maximum air inlet temperature	+43°C
Power supply	230V +-10% / 1~ / 50Hz

4TW60013-1

11 Hydraulic performance

11 - 1 Water Pressure Drop Curve Evaporator - Cooling 2-pipe

FWV / FWL / FWM							
Water flow l/h	Water pressure drop						
	FW..01	FW..02	FW..03	FW..04	FW..06	FW..08	FW..10
	kPa	kPa	kPa	kPa	kPa	kPa	kPa
50	0.71	0.41	0.19	0.11	0.1	0.05	0.05
100	2.44	1.42	0.66	0.36	0.35	0.16	0.20
200	8.25	4.81	2.25	1.23	1.21	0.56	0.67
300	16.84	9.81	4.6	2.51	2.46	1.14	1.37
400	27.92	16.27	7.63	4.17	4.09	1.9	2.29
500	41.33	24.09	11.3	6.18	6.06	2.82	3.39
600	56.93	33.19	15.57	8.51	8.35	3.89	4.68
800	94.32	55.02	25.82	14.12	13.84	6.44	7.75
1000	139.51	81.4	38.2	20.9	20.5	9.54	11.48
1500	-	165.77	77.83	42.61	41.8	19.46	23.42
2000	-	-	128.9	70.59	69.27	32.27	38.85
2500	-	-	-	104.41	102.47	47.75	57.50
3000	-	-	-	143.74	141.09	65.76	79.22
4000	-	-	-	-	-	108.92	131.28
5000	-	-	-	-	-	161.06	194.20

4TW60019-1A (Sheet 1/3)

11 - 2 Water Pressure Drop Curve Evaporator - Heating 2-pipe

FWV / FWL / FWM							
Water flow l/h	Water pressure drop						
	FW..01	FW..02	FW..03	FW..04	FW..06	FW..08	FW..10
	kPa	kPa	kPa	kPa	kPa	kPa	kPa
50	0.61	0.36	0.17	0.09	0.09	0.04	0.04
100	2.02	1.19	0.56	0.31	0.31	0.14	0.17
200	6.72	3.94	1.86	1.02	1.01	0.47	0.58
300	13.6	7.97	3.75	2.07	2.04	0.96	1.16
400	22.45	13.14	6.18	3.41	3.36	1.57	1.91
500	33.14	19.39	9.12	5.02	4.95	2.32	2.81
600	45.55	26.64	12.53	6.89	6.79	3.18	3.86
800	75.27	44.01	20.69	11.38	11.2	5.24	6.36
1000	111.15	64.97	30.54	16.79	16.52	7.72	9.37
1500	-	-	62.01	34.06	33.49	15.64	18.96
2000	-	-	102.52	56.28	55.34	25.84	31.29
2500	-	-	-	83.12	81.71	38.15	46.17
3000	-	-	-	-	112.36	52.45	63.45
4000	-	-	-	-	-	86.7	104.85
5000	-	-	-	-	-	-	154.82

4TW60019-1A (Sheet 2/3)

11 Hydraulic performance

11 - 3 Water Pressure Drop Curve Evaporator - Heating 4-pipe

FWV / FWL / FWM							
Water flow l/h	Water pressure drop						
	FW..01	FW..02	FW..03	FW..04	FW..06	FW..08	FW..10
	kPa	kPa	kPa	kPa	kPa	kPa	kPa
50	0.68	0.68	0.26	0.23	0.21	0.28	0.28
100	2.27	2.78	0.94	0.93	0.7	1.05	0.95
200	7.56	9.25	3.12	3.1	2.33	3.46	3.14
300	15.3	18.74	6.32	6.26	4.7	6.97	6.32
400	25.27	30.94	10.42	10.32	7.75	11.46	10.39
500	37.29	45.66	15.37	15.21	11.42	16.86	15.29
600	51.26	62.76	21.12	20.89	15.67	23.14	20.98
800	84.72	103.72	34.88	34.47	25.86	38.14	34.56
1000	-	-	51.49	50.87	38.16	56.23	50.94
1500	-	-	-	103.2	77.4	113.95	103.2

4TW60019-1A (Sheet 3/3)



Daikin's unique position as a manufacturer of air conditioning equipment, compressors and refrigerants has led to its close involvement in environmental issues. For several years Daikin has had the intention to become a leader in the provision of products that have limited impact on the environment. This challenge demands the eco design and development of a wide range of products and an energy management system, resulting in energy conservation and a reduction of waste.



The present publication is drawn up by way of information only and does not constitute an offer binding upon Daikin Europe N.V. Daikin Europe N.V. has compiled the content of this publication to the best of its knowledge. No express or implied warranty is given for the completeness, accuracy, reliability or fitness for particular purpose of its content and the products and services presented therein. Specifications are subject to change without prior notice. Daikin Europe N.V. explicitly rejects any liability for any direct or indirect damage, in the broadest sense, arising from or related to the use and/or interpretation of this publication. All content is copyrighted by Daikin Europe N.V.

Daikin products are distributed by:

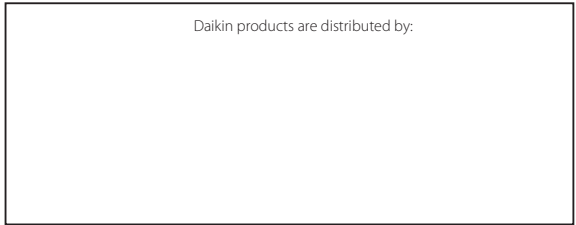

Daikin Europe N.V. is participating in the EUROVENT Certification Programme. Products are as listed in the EUROVENT Directory of Certified Products.