



Air Conditioners

Technical Data



Round Flow Cassette

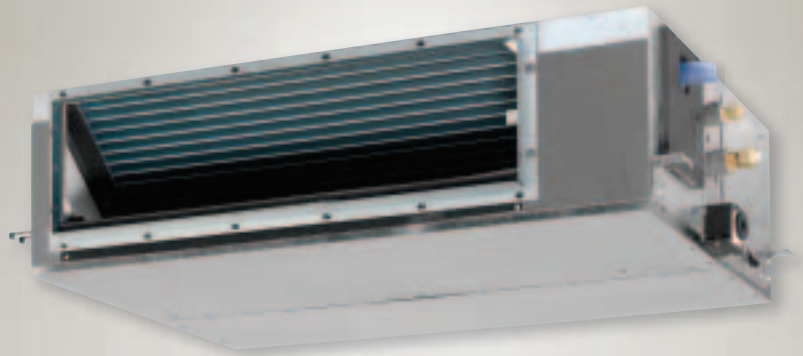

EEDEN10-200

FXSQ-P



Air Conditioners

Technical Data



Round Flow Cassette

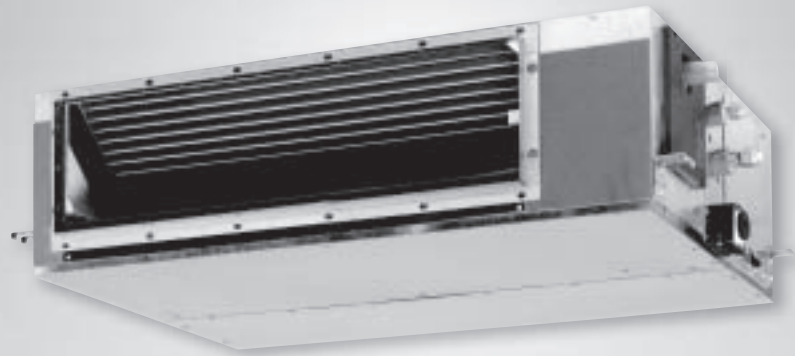

EEDEN10-200

FXSQ-P

TABLE OF CONTENTS

FXSQ-P

1	Specifications	2
	Technical Specifications	2
	Electrical Specifications	5
2	Electrical data	6
3	Safety device settings	7
4	Options	8
5	Capacity tables	9
	Cooling Capacity Tables	9
	Heating Capacity Tables	11
6	Dimensional drawings	13
7	Centre of gravity	15
8	Piping diagrams	16
9	Wiring diagrams	17
	Wiring Diagrams - Single Phase	17
10	Sound data	18
	Sound Power Spectrum	18
	Sound Pressure Spectrum	20
11	Fan characteristics	22
	Fan Characteristics	22
12	Installation	26
	Installation Method	26
	Filter Installation Method	27
	Switch Box Connection	28

1 Specifications

1-1 Technical Specifications				FXSQ20P7VEB	FXSQ25P7VEB	FXSQ32P7VEB	FXSQ40P7VEB	FXSQ50P7VEB	
Cooling capacity	Nom.		kW	2.2 (1)	2.8 (1)	3.6 (1)	4.5 (1)	5.6 (1)	
Heating capacity	Nom.		kW	2.5 (2)	3.2 (2)	4.0 (2)	5.0 (2)	6.3 (2)	
Power input - 50Hz	Cooling	Nom.	kW	0.041 (1)		0.044 (1)	0.097 (1)		
	Heating	Nom.	kW	0.029 (2)		0.032 (2)	0.085 (2)		
Power input - 60Hz	Cooling	Nom.	kW	0.041 (1)		0.044 (1)	0.097 (1)		
	Heating	Nom.	kW	0.029 (2)		0.032 (2)	0.085 (2)		
Casing	Colour			Unpainted					
	Material			Galvanised steel					
Dimensions	Unit	Height	mm	300					
		Width	mm	550			700		
		Depth	mm	700					
	Packed unit	Height	mm	355					
		Width	mm	770			920		
		Depth	mm	900					
Weight	Unit		kg	23			26		
	Packed unit		kg	28			32		
Decoration panel	Model			BYBS32DJW1			BYBS45DJW1		
	Colour			White (10Y9/0.5)					
	Dimensions	Height	mm	550d					
		Width	mm	650			800		
		Depth	mm	500					
	Weight			kg	3.0			3.5	
Required ceiling void >			mm	350					
Heat exchanger	Fin pitch		mm	1.75					
	Passes	Quantity		3			4		
	Face area		m ²	0.097			0.148		
	Stages	Quantity		16					
	Empty tubeplate hole	Quantity		12	0				
	Tube type			ø7 Hi-XSS					
	Fin	Type	Symmetric waffle louvre						
Treatment		Hydrophilic							
Fan	Type			Sirocco fan					
	Quantity			1					
	Air flow rate - 50Hz	Cooling	High	m ³ /min	9		9.5	16	
			Low	m ³ /min	6.5		7	11	
		Heating	High	m ³ /min	9		9.5	16	
			Low	m ³ /min	6.5		7	11	
	Air flow rate - 60Hz	Cooling	High	m ³ /min	9		9.5	16	
			Low	m ³ /min	6.5		7	11	
		Heating	High	m ³ /min	9		9.5	16	
			Low	m ³ /min	6.5		7	11	
	External static pressure - 50Hz	High	Pa	70			100		
		Nom.	Pa	30					
	External static pressure - 60Hz	High	Pa	70			100		
Nom.		Pa	30						
Fan motor	Quantity			1					
	Model			Brushless DC motor					
	Speed	Steps		9			10		
		Cooling	High	rpm	1031		1061	1186	
			Low	rpm	802		827	875	
		Heating	High	rpm	1031		1061	1186	
			Low	rpm	802		827	875	
		Output	High	W	90			140	
Drive			Direct drive						

1 Specifications

1-1 Technical Specifications				FXSQ20P7VEB	FXSQ25P7VEB	FXSQ32P7VEB	FXSQ40P7VEB	FXSQ50P7VEB
Sound pressure level	Cooling	High	dBA	32		33		37
		Low	dBA	26		27		29
	Heating	Super high	dBA			-		
		High	dBA	32		33		37
		Low	dBA	26		27		29
Refrigerant	Type			R-410A				
	Control			Electronic expansion valve				
Piping connections	Liquid	Type		Flare connection				
		OD	mm	6.35				
	Gas	Type		Flare connection				
		OD	mm	12.7				
	Drain			VP25 (O.D. 32 / I.D. 25)				
	Heat insulation			Both liquid and gas pipes				
Sound absorbing insulation			-					
Drain-up height			mm	625				
Air filter			Resin net with mold resistance					
Notes			Cooling: indoor temp. 27×CDB, 19×CWB; outdoor temp. 35×CDB; equivalent piping length: 7.5m; level difference: 0m					

1-1 Technical Specifications				FXSQ63P7VEB	FXSQ80P7VEB	FXSQ100P7VEB	FXSQ125P7VEB	FXSQ140P7VEB
Cooling capacity	Nom.		kW	7.1 (1)	9.0 (1)	11.2 (1)	14.0 (1)	16.0 (1)
Heating capacity	Nom.		kW	8.0 (2)	10.0 (2)	12.5 (2)	16.0 (2)	18.0 (2)
Power input - 50Hz	Cooling	Nom.	kW	0.074 (1)	0.118 (1)	0.117 (1)	0.185 (1)	0.261 (1)
	Heating	Nom.	kW	0.062 (2)	0.106 (2)	0.105 (2)	0.173 (2)	0.249 (2)
Power input - 60Hz	Cooling	Nom.	kW	0.074 (1)	0.118 (1)	0.117 (1)	0.185 (1)	0.261 (1)
	Heating	Nom.	kW	0.062 (2)	0.106 (2)	0.105 (2)	0.173 (2)	0.249 (2)
Casing	Colour			Unpainted				
	Material			Galvanised steel				
Dimensions	Unit	Height	mm	300				
		Width	mm	1000		1400		
		Depth	mm	700				
	Packed unit	Height	mm	355				
		Width	mm	1220		1620		
		Depth	mm	900				
Weight	Unit		kg	35		46		47
	Packed unit		kg	42		54		55
Decoration panel	Model			BYBS71DJW1			BYBS125DJW1	
	Colour			White (10Y9/0.5)				
	Dimensions	Height	mm	55 0d				
		Width	mm	1100		1500		
		Depth	mm	500				
Weight			kg	4.5		6.5		
Required ceiling void \>			mm	350				
Heat exchanger	Fin pitch		mm	1.75				1.50
	Passes	Quantity		7		11		
	Face area		m ²	0.249		0.383		
	Stages	Quantity		16				
	Empty tubeplate hole	Quantity		0				
	Tube type			ø7 Hi-XSS				
	Fin	Type		Symmetric waffle louvre				
Treatment		Hydrophilic						

1 Specifications

1-1 Technical Specifications				FXSQ63P7VEB	FXSQ80P7VEB	FXSQ100P7VEB	FXSQ125P7VEB	FXSQ140P7VEB	
Fan	Type			Sirocco fan					
	Quantity			2		3			
	Air flow rate - 50Hz	Cooling	High	m ³ /min	19.5	25	32	39	46
			Low	m ³ /min	16	20	23	28	32
		Heating	High	m ³ /min	19.5	25	32	39	46
			Low	m ³ /min	16	20	23	28	32
	Air flow rate - 60Hz	Cooling	High	m ³ /min	19.5	25	32	39	46
			Low	m ³ /min	16	20	23	28	32
		Heating	High	m ³ /min	19.5	25	32	39	46
			Low	m ³ /min	16.0	20	23	28	32
	External static pressure - 50Hz	High	Pa	100		120		140	
		Nom.	Pa	30	40		50		
External static pressure - 60Hz	High	Pa	100		120		140		
	Nom.	Pa	30	40		50			
Fan motor	Quantity			1					
	Model			Brushless DC motor					
	Speed	Steps			8	9			11
		Cooling	High	rpm	975	1161	1060	1218	1325
			Low	rpm	840	960	813	920	948
		Heating	High	rpm	975	1161	1060	1218	1325
	Low		rpm	840	960	813	920	948	
	Output	High	W	350					
Drive			Direct drive						
Sound pressure level	Cooling	High	dBA	37	38		40	42	
		Low	dBA	30	32		33	34	
	Heating	Super high	dBA	-					
		High	dBA	37	38		40	42	
	Low	dBA	30	32		33	34		
Refrigerant	Type			R-410A					
	Control			Electronic expansion valve					
Piping connections	Liquid	Type		Flare connection					
		OD	mm	9.52					
	Gas	Type		Flare connection					
		OD	mm	15.9					
	Drain			VP25 (O.D. 32 / I.D. 25)					
	Heat insulation			Both liquid and gas pipes					
Sound absorbing insulation			-						
Drain-up height			mm	625					
Air filter			Resin net with mold resistance						
Notes			Cooling: indoor temp. 27×CDB, 19×CWB; outdoor temp. 35×CDB; equivalent piping length: 7.5m; level difference: 0m						

1 Specifications

1-2 Electrical Specifications			FXSQ20P7VEB	FXSQ25P7VEB	FXSQ32P7VEB	FXSQ40P7VEB	FXSQ50P7VEB
Power supply	Name		VE				
	Phase		1~				
	Frequency	Hz	50/60				
	Voltage	V	220-240/220				
Voltage range	Min.	%	-10 0d				
	Max.	%	10 0d				
Current - 50Hz	Minimum circuit amps (MCA)	A	0.5		1.2		
	Total overcurrent amps (TOCA)	A	-				
	Maximum fuse amps (MFA)	A	16				
Current - 60Hz	Minimum circuit amps (MCA)	A	0.5		1.2		
	Maximum fuse amps (MFA)	A	16				

1-2 Electrical Specifications			FXSQ63P7VEB	FXSQ80P7VEB	FXSQ100P7VEB	FXSQ125P7VEB	FXSQ140P7VEB
Power supply	Name		VE				
	Phase		1~				
	Frequency	Hz	50/60				
	Voltage	V	220-240/220				
Voltage range	Min.	%	-10 0d				
	Max.	%	10 0d				
Current - 50Hz	Minimum circuit amps (MCA)	A	1.1	1.3	1.4	1.9	3.1
	Total overcurrent amps (TOCA)	A	-				
	Maximum fuse amps (MFA)	A	16				
Current - 60Hz	Minimum circuit amps (MCA)	A	1.1	1.3	1.4	1.9	3.1
	Maximum fuse amps (MFA)	A	16				

2 Electrical data

FXSQ-P

Model	Type	Hz	Units			Power Supply	
			Volts	Min.	Max.	MCA	MFA
FXSQ20	VE	50/60	220~240V/220V	-10%	+10%	0.4	16
FXSQ25						0.4	16
FXSQ32						0.4	16
FXSQ40						1.2	16
FXSQ50						1.2	16
FXSQ63						1.1	16
FXSQ80						1.3	16
FXSQ100						1.6	16
FXSQ125						2.1	16
FXSQ140						3.1	16

SYMBOLS

MCA : Min.Circuit Amps. (A)
MFA : Max. Fuse Amps. (A) (see note 4)

NOTES

- 1 Voltage range
Units are suitable for use on electrical systems where voltage supplied to unit terminal is not below or above listed range limits.
- 2 Maximum allowable voltage variation between phases is 2%
- 3 Select wire size based on the MCA.
- 4 Instead of a fuse, use a circuit breaker.

4TW31181-2A

3 Safety device settings

FXSQ20-140P											
Safety devices		20	25	32	40	50	63	80	100	125	140
FXSQ	PC Board Fuse	250V 3.15A	250V 3.15A	250V 3.15A	250V 3.15A	250V 3.15A	250V 3.15A	250V 3.15A	250V 3.15A	250V 3.15A	250V 3.15A
	PC Board Fuse (Fan Driver)	250V 5A	250V 5A	250V 5A	250V 5A	250V 5A	250V 6.3A	250V 6.3A	250V 6.3A	250V 6.3A	250V 6.3A
	Fan Motor Thermal Protector	°C	—	—	—	—	—	—	—	—	—
	Drain Pump Fuse	°C	145	145	145	145	145	145	145	145	145

3TW31189-2A

4 Options

FXSQ20-140P

Options

Item	Type	FXSQ20,25,32	FXSQ40,50	FXSQ63,80	FXSQ100,125,140
Panel related	Decoration panel (*5)	BYBS32	BYBS45D	BYBS71D	BYBS125D
Air inlet and air discharge outlet related	Air discharge adapter for round duct	KDAJ25K36A	KDAJ25K56A	KDAJ25KA71A	KDAJ25KA140A
Panel related	Decoration panel option	EKBYBSD			

Operation Control

Item	Type	FXSQ20,25,32	FXSQ40,50	FXSQ63,80	FXSQ100,125,140
Remote Control	Wired Type	BRC1D528 / BRC1E51A			
	Infrared type	BRC4C65 BRC4C66 BRC2C51 BRC3A61			
Simplified remote control	HP	EKRP1B2A			
Remote control for hotel use	CO	KRP1C64 KRP2A51 KRP4A51			
Option BCB for external el. heater, humidifier and/or hour meter (*1), (*2), (*3), (*4)		KRC501-4B			
Adapter for wiring (interlock for fresh air intake fan) (*4)		DCS302CA51			
Wiring adapter for electrical appendices (1) (*2), (*4)		KJB311A			
Wiring adapter for electrical appendices (2) (*4)		DCS301BA51			
Remote sensor		KJB212A			
Central remote control		DST301BA51			
Electrical box with earth terminal (3 blocks)		DTA104A61			
Unified ON/OFF control		KRP4A96			
Electrical box with earth terminal (2 blocks)					
Schedule timer					
External adapter for outdoor unit (installation on indoor unit) (*4)					
Mounting plate for adapter PCB					

NOTES

- (*1): Electrical heater and humidifier are field supply. These parts should not be installed inside the equipment (refer to installation manual EKRP1B2A)
- (*2): If installing an electrical heater, an option PCB for external heater (EKRP1B2) for each indoor unit is required.
- (*3): An electrical heater can not be used for VRV system cooling only.
- (*4): Mounting plate KRP4A96 is required for these options. Maximum 2 option PCB's can be mounted.
- (*5): Decoration panel option EKBYBSD is required for direct mounting of the decoration panel on the unit.

Contents of accessory bag

Description	Quantity
	FXSQ 20,25,32,40,50,63,80,100,125,140
Hexagon tapping screw (M5x16)	16
Round plain washer for wood	8
Installation and operation manual	1
Hose band	1
Insulation for joint (GAS)	1
Insulation for joint (LIQUID)	1
Drain hose	1
Drain hose sealing material	1
Sealing material	2

3TW31189-3D

5 Capacity tables

5 - 1 Cooling Capacity Tables

FXSQ-P		TC: Total Capacity: kW ; SHC: Sensible heat capacity: kW													
Unit size	Outdoor air temp. (°CDB)	Indoor air temperature													
		14.0WB		16.0WB		18.0WB		19.0WB		20.0WB		22.0WB		24.0WB	
		20.0DB		23.0DB		26.0DB		27.0DB		28.0DB		30.0DB		32.0DB	
		TC	SHC	TC	SHC	TC	SHC	TC	SHC	TC	SHC	TC	SHC	TC	SHC
20	10.0	1.5	1.5	1.8	1.8	2.1	1.9	2.2	1.9	2.3	1.9	2.6	2.0	2.8	2.1
	12.0	1.5	1.5	1.8	1.8	2.1	1.9	2.2	1.9	2.3	1.9	2.6	2.0	2.7	2.0
	14.0	1.5	1.5	1.8	1.8	2.1	1.9	2.2	1.9	2.3	1.9	2.6	2.0	2.7	2.0
	16.0	1.5	1.5	1.8	1.8	2.1	1.9	2.2	1.9	2.3	1.9	2.6	2.0	2.7	2.0
	18.0	1.5	1.5	1.8	1.8	2.1	1.9	2.2	1.9	2.3	1.9	2.6	2.0	2.6	2.0
	20.0	1.5	1.5	1.8	1.8	2.1	1.9	2.2	1.9	2.3	1.9	2.5	1.9	2.6	2.0
	21.0	1.5	1.5	1.8	1.8	2.1	1.9	2.2	1.9	2.3	1.9	2.5	1.9	2.6	2.0
	23.0	1.5	1.5	1.8	1.8	2.1	1.9	2.2	1.9	2.3	1.9	2.5	1.9	2.5	1.9
	25.0	1.5	1.5	1.8	1.8	2.1	1.9	2.2	1.9	2.3	1.9	2.5	1.9	2.5	1.9
	27.0	1.5	1.5	1.8	1.8	2.1	1.9	2.2	1.9	2.3	1.9	2.4	1.9	2.5	1.9
	29.0	1.5	1.5	1.8	1.8	2.1	1.9	2.2	1.9	2.3	1.9	2.4	1.8	2.4	1.9
	31.0	1.5	1.5	1.8	1.8	2.1	1.9	2.2	1.9	2.3	1.9	2.4	1.8	2.4	1.8
	33.0	1.5	1.5	1.8	1.8	2.1	1.9	2.2	1.9	2.3	1.9	2.3	1.8	2.4	1.8
	35.0	1.5	1.5	1.8	1.8	2.1	1.9	2.2	1.9	2.2	1.9	2.3	1.8	2.3	1.8
37.0	1.5	1.5	1.8	1.8	2.1	1.9	2.2	1.9	2.2	1.8	2.2	1.7	2.3	1.8	
39.0	1.5	1.5	1.8	1.8	2.1	1.9	2.1	1.9	2.2	1.8	2.2	1.7	2.3	1.8	
25	10.0	1.9	1.8	2.3	2.0	2.6	2.3	2.8	2.3	3.0	2.3	3.3	2.4	3.5	2.4
	12.0	1.9	1.8	2.3	2.0	2.6	2.3	2.8	2.3	3.0	2.3	3.3	2.4	3.5	2.4
	14.0	1.9	1.8	2.3	2.0	2.6	2.3	2.8	2.3	3.0	2.3	3.3	2.4	3.4	2.4
	16.0	1.9	1.8	2.3	2.0	2.6	2.3	2.8	2.3	3.0	2.3	3.3	2.4	3.4	2.4
	18.0	1.9	1.8	2.3	2.0	2.6	2.3	2.8	2.3	3.0	2.3	3.3	2.4	3.4	2.4
	20.0	1.9	1.8	2.3	2.0	2.6	2.3	2.8	2.3	3.0	2.3	3.2	2.3	3.3	2.3
	21.0	1.9	1.8	2.3	2.0	2.6	2.3	2.8	2.3	3.0	2.3	3.2	2.3	3.3	2.3
	23.0	1.9	1.8	2.3	2.0	2.6	2.3	2.8	2.3	3.0	2.3	3.2	2.3	3.2	2.3
	25.0	1.9	1.8	2.3	2.0	2.6	2.3	2.8	2.3	3.0	2.3	3.1	2.3	3.2	2.3
	27.0	1.9	1.8	2.3	2.0	2.6	2.3	2.8	2.3	3.0	2.3	3.1	2.2	3.2	2.3
	29.0	1.9	1.8	2.3	2.0	2.6	2.3	2.8	2.3	3.0	2.3	3.0	2.2	3.1	2.2
	31.0	1.9	1.8	2.3	2.0	2.6	2.3	2.8	2.3	2.9	2.3	3.0	2.2	3.1	2.2
	33.0	1.9	1.8	2.3	2.0	2.6	2.3	2.8	2.3	2.9	2.3	2.9	2.2	3.0	2.2
	35.0	1.9	1.8	2.3	2.0	2.6	2.3	2.8	2.3	2.8	2.2	2.9	2.1	3.0	2.2
37.0	1.9	1.8	2.3	2.0	2.6	2.3	2.8	2.3	2.8	2.2	2.9	2.1	2.9	2.1	
39.0	1.9	1.8	2.3	2.0	2.6	2.3	2.7	2.2	2.7	2.2	2.8	2.1	2.9	2.1	
32	10.0	2.4	2.2	2.9	2.5	3.4	2.8	3.6	2.9	3.8	2.9	4.3	3.0	4.6	3.0
	12.0	2.4	2.2	2.9	2.5	3.4	2.8	3.6	2.9	3.8	2.9	4.3	3.0	4.5	3.0
	14.0	2.4	2.2	2.9	2.5	3.4	2.8	3.6	2.9	3.8	2.9	4.3	3.0	4.4	3.0
	16.0	2.4	2.2	2.9	2.5	3.4	2.8	3.6	2.9	3.8	2.9	4.3	3.0	4.4	3.0
	18.0	2.4	2.2	2.9	2.5	3.4	2.8	3.6	2.9	3.8	2.9	4.2	3.0	4.3	2.9
	20.0	2.4	2.2	2.9	2.5	3.4	2.8	3.6	2.9	3.8	2.9	4.2	2.9	4.3	2.9
	21.0	2.4	2.2	2.9	2.5	3.4	2.8	3.6	2.9	3.8	2.9	4.1	2.9	4.2	2.9
	23.0	2.4	2.2	2.9	2.5	3.4	2.8	3.6	2.9	3.8	2.9	4.1	2.9	4.2	2.9
	25.0	2.4	2.2	2.9	2.5	3.4	2.8	3.6	2.9	3.8	2.9	4.0	2.9	4.1	2.8
	27.0	2.4	2.2	2.9	2.5	3.4	2.8	3.6	2.9	3.8	2.9	4.0	2.8	4.1	2.8
	29.0	2.4	2.2	2.9	2.5	3.4	2.8	3.6	2.9	3.8	2.9	3.9	2.8	4.0	2.8
	31.0	2.4	2.2	2.9	2.5	3.4	2.8	3.6	2.9	3.8	2.9	3.8	2.8	3.9	2.7
	33.0	2.4	2.2	2.9	2.5	3.4	2.8	3.6	2.9	3.7	2.8	3.8	2.7	3.9	2.7
	35.0	2.4	2.2	2.9	2.5	3.4	2.8	3.6	2.9	3.6	2.8	3.7	2.7	3.8	2.7
37.0	2.4	2.2	2.9	2.5	3.4	2.8	3.5	2.8	3.6	2.8	3.7	2.7	3.8	2.7	
39.0	2.4	2.2	2.9	2.5	3.4	2.8	3.5	2.8	3.5	2.7	3.6	2.6	3.7	2.6	
40	10.0	3.0	2.9	3.6	3.4	4.2	3.8	4.5	3.8	4.8	3.8	5.4	3.9	5.7	4.0
	12.0	3.0	2.9	3.6	3.4	4.2	3.8	4.5	3.8	4.8	3.8	5.4	3.9	5.6	4.0
	14.0	3.0	2.9	3.6	3.4	4.2	3.8	4.5	3.8	4.8	3.8	5.4	3.9	5.5	4.0
	16.0	3.0	2.9	3.6	3.4	4.2	3.8	4.5	3.8	4.8	3.8	5.4	3.9	5.5	3.9
	18.0	3.0	2.9	3.6	3.4	4.2	3.8	4.5	3.8	4.8	3.8	5.3	3.9	5.4	3.9
	20.0	3.0	2.9	3.6	3.4	4.2	3.8	4.5	3.8	4.8	3.8	5.2	3.8	5.3	3.9
	21.0	3.0	2.9	3.6	3.4	4.2	3.8	4.5	3.8	4.8	3.8	5.2	3.8	5.3	3.8
	23.0	3.0	2.9	3.6	3.4	4.2	3.8	4.5	3.8	4.8	3.8	5.1	3.8	5.2	3.8
	25.0	3.0	2.9	3.6	3.4	4.2	3.8	4.5	3.8	4.8	3.8	5.0	3.7	5.1	3.8
	27.0	3.0	2.9	3.6	3.4	4.2	3.8	4.5	3.8	4.8	3.8	5.0	3.7	5.1	3.7
	29.0	3.0	2.9	3.6	3.4	4.2	3.8	4.5	3.8	4.8	3.8	4.9	3.7	5.0	3.7
	31.0	3.0	2.9	3.6	3.4	4.2	3.8	4.5	3.8	4.7	3.8	4.8	3.6	4.9	3.6
	33.0	3.0	2.9	3.6	3.4	4.2	3.8	4.5	3.8	4.6	3.7	4.7	3.6	4.8	3.6
	35.0	3.0	2.9	3.6	3.4	4.2	3.8	4.5	3.8	4.6	3.7	4.7	3.5	4.8	3.6
37.0	3.0	2.9	3.6	3.4	4.2	3.8	4.4	3.8	4.5	3.6	4.6	3.5	4.7	3.5	
39.0	3.0	2.9	3.6	3.4	4.2	3.8	4.4	3.7	4.4	3.6	4.5	3.4	4.6	3.5	
50	10.0	3.8	3.6	4.5	3.9	5.2	3.8	5.6	4.4	6.0	4.5	6.7	4.1	7.1	4.7
	12.0	3.8	3.6	4.5	3.9	5.2	3.8	5.6	4.4	6.0	4.5	6.7	4.1	7.0	4.7
	14.0	3.8	3.6	4.5	3.9	5.2	3.8	5.6	4.4	6.0	4.5	6.7	4.1	6.9	4.6
	16.0	3.8	3.6	4.5	3.9	5.2	3.8	5.6	4.4	6.0	4.5	6.7	4.1	6.8	4.6
	18.0	3.8	3.6	4.5	3.9	5.2	3.8	5.6	4.4	6.0	4.5	6.6	4.1	6.7	4.5
	20.0	3.8	3.6	4.5	3.9	5.2	3.8	5.6	4.4	6.0	4.5	6.5	4.0	6.6	4.5
	21.0	3.8	3.6	4.5	3.9	5.2	3.8	5.6	4.4	6.0	4.5	6.4	4.0	6.6	4.5
	23.0	3.8	3.6	4.5	3.9	5.2	3.8	5.6	4.4	6.0	4.5	6.4	4.0	6.5	4.4
	25.0	3.8	3.6	4.5	3.9	5.2	3.8	5.6	4.4	6.0	4.5	6.3	3.9	6.4	4.4
	27.0	3.8	3.6	4.5	3.9	5.2	3.8	5.6	4.4	6.0	4.5	6.2	3.9	6.3	4.3
	29.0	3.8	3.6	4.5	3.9	5.2	3.8	5.6	4.4	5.9	4.5	6.1	3.8	6.2	4.3
	31.0	3.8	3.6	4.5	3.9	5.2	3.8	5.6	4.4	5.9	4.4	6.0	3.8	6.1	4.3
	33.0	3.8	3.6	4.5	3.9	5.2	3.8	5.6	4.4	5.8	4.4	5.9	3.8	6.0	4.2
	35.0	3.8	3.6	4.5	3.9	5.2	3.8	5.6	4.4	5.7	4.3	5.8	3.7	5.9	4.2
37.0	3.8	3.6	4.5	3.9	5.2	3.8	5.5	4.4	5.6	4.3	5.7	3.7	5.9	4.1	
39.0	3.8	3.6	4.5	3.9	5.2	3.8	5.4	4.3	5.5	4.2	5.6	3.6	5.8	4.1	

3TW31182-1

5 Capacity tables

5 - 1 Cooling Capacity Tables

FXSQ-P		TC: Total Capacity: kW ; SHC: Sensible heat capacity: kW													
Unit size	Outdoor air temp. (°CDB)	Indoor air temperature													
		14.0WB		16.0WB		18.0WB		19.0WB		20.0WB		22.0WB		24.0WB	
		20.0DB		23.0DB		26.0DB		27.0DB		28.0DB		30.0DB		32.0DB	
		TC	SHC	TC	SHC	TC	SHC	TC	SHC	TC	SHC	TC	SHC	TC	SHC
63	10.0	4.8	4.2	5.7	4.9	6.6	5.4	7.1	5.5	7.6	5.6	8.5	5.8	9.0	6.4
	12.0	4.8	4.2	5.7	4.9	6.6	5.4	7.1	5.5	7.6	5.6	8.5	5.8	8.9	6.3
	14.0	4.8	4.2	5.7	4.9	6.6	5.4	7.1	5.5	7.6	5.6	8.5	5.8	8.7	6.3
	16.0	4.8	4.2	5.7	4.9	6.6	5.4	7.1	5.5	7.6	5.6	8.5	5.8	8.6	6.3
	18.0	4.8	4.2	5.7	4.9	6.6	5.4	7.1	5.5	7.6	5.6	8.3	5.8	8.5	6.2
	20.0	4.8	4.2	5.7	4.9	6.6	5.4	7.1	5.5	7.6	5.6	8.2	5.7	8.4	6.2
	21.0	4.8	4.2	5.7	4.9	6.6	5.4	7.1	5.5	7.6	5.6	8.2	5.7	8.3	6.2
	23.0	4.8	4.2	5.7	4.9	6.6	5.4	7.1	5.5	7.6	5.6	8.1	5.6	8.2	6.1
	25.0	4.8	4.2	5.7	4.9	6.6	5.4	7.1	5.5	7.6	5.6	7.9	5.6	8.1	6.1
	27.0	4.8	4.2	5.7	4.9	6.6	5.4	7.1	5.5	7.6	5.6	7.8	5.5	8.0	6.1
	29.0	4.8	4.2	5.7	4.9	6.6	5.4	7.1	5.5	7.5	5.6	7.7	5.4	7.9	6.0
	31.0	4.8	4.2	5.7	4.9	6.6	5.4	7.1	5.5	7.4	5.5	7.6	5.4	7.8	6.0
	33.0	4.8	4.2	5.7	4.9	6.6	5.4	7.1	5.5	7.3	5.5	7.5	5.3	7.6	5.9
	35.0	4.8	4.2	5.7	4.9	6.6	5.4	7.1	5.5	7.2	5.4	7.4	5.3	7.5	5.9
	37.0	4.8	4.2	5.7	4.9	6.6	5.4	7.0	5.5	7.1	5.4	7.2	5.2	7.4	5.9
	39.0	4.8	4.2	5.7	4.9	6.6	5.4	6.9	5.4	7.0	5.3	7.1	5.1	7.3	5.8
80	10.0	6.1	5.3	7.2	6.1	8.4	6.9	9.0	7.0	9.6	7.1	10.8	7.4	11.4	7.4
	12.0	6.1	5.3	7.2	6.1	8.4	6.9	9.0	7.0	9.6	7.1	10.8	7.4	11.2	7.4
	14.0	6.1	5.3	7.2	6.1	8.4	6.9	9.0	7.0	9.6	7.1	10.8	7.4	11.1	7.3
	16.0	6.1	5.3	7.2	6.1	8.4	6.9	9.0	7.0	9.6	7.1	10.7	7.4	10.9	7.2
	18.0	6.1	5.3	7.2	6.1	8.4	6.9	9.0	7.0	9.6	7.1	10.6	7.3	10.8	7.2
	20.0	6.1	5.3	7.2	6.1	8.4	6.9	9.0	7.0	9.6	7.1	10.4	7.2	10.6	7.1
	21.0	6.1	5.3	7.2	6.1	8.4	6.9	9.0	7.0	9.6	7.1	10.4	7.2	10.6	7.1
	23.0	6.1	5.3	7.2	6.1	8.4	6.9	9.0	7.0	9.6	7.1	10.2	7.1	10.4	7.0
	25.0	6.1	5.3	7.2	6.1	8.4	6.9	9.0	7.0	9.6	7.1	10.1	7.0	10.3	6.9
	27.0	6.1	5.3	7.2	6.1	8.4	6.9	9.0	7.0	9.6	7.1	9.9	7.0	10.1	6.9
	29.0	6.1	5.3	7.2	6.1	8.4	6.9	9.0	7.0	9.5	7.1	9.8	6.9	10.0	6.8
	31.0	6.1	5.3	7.2	6.1	8.4	6.9	9.0	7.0	9.4	7.0	9.6	6.8	9.8	6.7
	33.0	6.1	5.3	7.2	6.1	8.4	6.9	9.0	7.0	9.3	7.0	9.5	6.7	9.7	6.7
	35.0	6.1	5.3	7.2	6.1	8.4	6.9	9.0	7.0	9.1	6.9	9.3	6.6	9.5	6.6
	37.0	6.1	5.3	7.2	6.1	8.4	6.9	8.9	6.9	9.0	6.8	9.2	6.6	9.4	6.5
	39.0	6.1	5.3	7.2	6.1	8.4	6.9	8.7	6.8	8.8	6.7	9.0	6.5	9.3	6.5
100	10.0	7.6	6.4	9.0	7.3	10.5	8.3	11.2	8.5	11.9	8.7	13.4	9.0	14.2	8.9
	12.0	7.6	6.4	9.0	7.3	10.5	8.3	11.2	8.5	11.9	8.7	13.4	9.0	14.0	8.9
	14.0	7.6	6.4	9.0	7.3	10.5	8.3	11.2	8.5	11.9	8.7	13.4	9.0	13.8	8.8
	16.0	7.6	6.4	9.0	7.3	10.5	8.3	11.2	8.5	11.9	8.7	13.3	9.0	13.6	8.7
	18.0	7.6	6.4	9.0	7.3	10.5	8.3	11.2	8.5	11.9	8.7	13.2	8.9	13.4	8.6
	20.0	7.6	6.4	9.0	7.3	10.5	8.3	11.2	8.5	11.9	8.7	13.0	8.8	13.2	8.5
	21.0	7.6	6.4	9.0	7.3	10.5	8.3	11.2	8.5	11.9	8.7	12.9	8.8	13.2	8.5
	23.0	7.6	6.4	9.0	7.3	10.5	8.3	11.2	8.5	11.9	8.7	12.7	8.7	13.0	8.4
	25.0	7.6	6.4	9.0	7.3	10.5	8.3	11.2	8.5	11.9	8.7	12.5	8.6	12.8	8.3
	27.0	7.6	6.4	9.0	7.3	10.5	8.3	11.2	8.5	11.9	8.7	12.3	8.5	12.6	8.2
	29.0	7.6	6.4	9.0	7.3	10.5	8.3	11.2	8.5	11.9	8.6	12.2	8.4	12.4	8.1
	31.0	7.6	6.4	9.0	7.3	10.5	8.3	11.2	8.5	11.7	8.6	12.0	8.3	12.2	8.0
	33.0	7.6	6.4	9.0	7.3	10.5	8.3	11.2	8.5	11.5	8.5	11.8	8.2	12.1	7.9
	35.0	7.6	6.4	9.0	7.3	10.5	8.3	11.2	8.5	11.3	8.4	11.6	8.1	11.9	7.8
	37.0	7.6	6.4	9.0	7.3	10.5	8.3	11.0	8.4	11.2	8.3	11.4	8.0	11.7	7.7
	39.0	7.6	6.4	9.0	7.3	10.5	8.3	10.8	8.3	11.0	8.2	11.2	7.9	11.5	7.6
125	10.0	9.5	7.8	11.3	8.9	13.1	9.6	14.0	9.9	14.9	10.3	16.8	10.7	18.4	11.0
	12.0	9.5	7.8	11.3	8.9	13.1	9.6	14.0	9.9	14.9	10.3	16.8	10.7	18.2	10.9
	14.0	9.5	7.8	11.3	8.9	13.1	9.6	14.0	9.9	14.9	10.3	16.8	10.7	18.0	10.7
	16.0	9.5	7.8	11.3	8.9	13.1	9.6	14.0	9.9	14.9	10.3	16.8	10.7	17.7	10.6
	18.0	9.5	7.8	11.3	8.9	13.1	9.6	14.0	9.9	14.9	10.3	16.8	10.7	17.5	10.4
	20.0	9.5	7.8	11.3	8.9	13.1	9.6	14.0	9.9	14.9	10.3	16.8	10.7	17.2	10.3
	21.0	9.5	7.8	11.3	8.9	13.1	9.6	14.0	9.9	14.9	10.3	16.8	10.7	17.1	10.2
	23.0	9.5	7.8	11.3	8.9	13.1	9.6	14.0	9.9	14.9	10.3	16.5	10.6	16.9	10.1
	25.0	9.5	7.8	11.3	8.9	13.1	9.6	14.0	9.9	14.9	10.3	16.3	10.4	16.6	10.0
	27.0	9.5	7.8	11.3	8.9	13.1	9.6	14.0	9.9	14.9	10.3	16.1	10.3	16.4	9.9
	29.0	9.5	7.8	11.3	8.9	13.1	9.6	14.0	9.9	14.9	10.3	15.8	10.1	16.2	9.8
	31.0	9.5	7.8	11.3	8.9	13.1	9.6	14.0	9.9	14.9	10.3	15.6	10.0	15.9	9.6
	33.0	9.5	7.8	11.3	8.9	13.1	9.6	14.0	9.9	14.9	10.3	15.3	9.9	15.7	9.5
	35.0	9.5	7.8	11.3	8.9	13.1	9.6	14.0	9.9	14.8	10.2	15.1	9.8	15.4	9.4
	37.0	9.5	7.8	11.3	8.9	13.1	9.6	14.0	9.9	14.5	10.1	14.9	9.7	15.2	9.3
	39.0	9.5	7.8	11.3	8.9	13.1	9.6	14.0	10.0	14.3	9.9	14.6	9.6	15.0	9.2
140	10.0	10.8	9.0	12.9	10.4	15.0	11.7	16.0	12.0	17.0	12.3	19.1	12.7	20.2	12.6
	12.0	10.8	9.0	12.9	10.4	15.0	11.7	16.0	12.0	17.0	12.3	19.1	12.7	20.0	12.5
	14.0	10.8	9.0	12.9	10.4	15.0	11.7	16.0	12.0	17.0	12.3	19.1	12.7	19.7	12.4
	16.0	10.8	9.0	12.9	10.4	15.0	11.7	16.0	12.0	17.0	12.3	19.1	12.7	19.4	12.3
	18.0	10.8	9.0	12.9	10.4	15.0	11.7	16.0	12.0	17.0	12.3	18.8	12.6	19.2	12.2
	20.0	10.8	9.0	12.9	10.4	15.0	11.7	16.0	12.0	17.0	12.3	18.5	12.4	18.9	12.1
	21.0	10.8	9.0	12.9	10.4	15.0	11.7	16.0	12.0	17.0	12.3	18.4	12.4	18.8	12.1
	23.0	10.8	9.0	12.9	10.4	15.0	11.7	16.0	12.0	17.0	12.3	18.1	12.3	18.5	12.0
	25.0	10.8	9.0	12.9	10.4	15.0	11.7	16.0	12.0	17.0	12.3	17.9	12.1	18.3	11.9
	27.0	10.8	9.0	12.9	10.4	15.0	11.7	16.0	12.0	17.0	12.3	17.6	12.0	18.0	11.8
	29.0	10.8	9.0	12.9	10.4	15.0	11.7	16.0	12.0	17.0	12.3	17.4	11.9	17.8	11.7
	31.0	10.8	9.0	12.9	10.4	15.0	11.7	16.0	12.0	16.7	12.1	17.1	11.8	17.5	11.6
	33.0	10.8	9.0	12.9	10.4	15.0	11.7	16.0	12.0	16.5	12.0	16.8	11.7	17.2	11.5
	35.0	10.8	9.0	12.9	10.4	15.0	11.7	16.0	12.0	16.2	11.9	16.6	11.5	17.0	11.3
	37.0	10.8	9.0	12.9	10.4	15.0	11.7	15.7	11.9	15.9	11.7	16.3	11.4	16.7	11.2
	39.0	10.8	9.0	12.9	10.4	15.0	11.7	15.5	11.8	15.7	11.6	16.1	11.3	16.5	11.1

5 Capacity tables

5 - 2 Heating Capacity Tables

FXSQ-P								
Unit Size	Outdoor air temp.		Indoor air temperature: °CDB					
			16.0	18.0	20.0	21.0	22.0	24.0
	°CDB	°CWB	kW	kW	kW	kW	kW	kW
20	-19.8	-20.0	1.5	1.5	1.5	1.5	1.5	1.5
	-18.8	-19.0	1.5	1.5	1.5	1.5	1.5	1.5
	-16.7	-17.0	1.6	1.6	1.6	1.6	1.6	1.6
	-14.7	-15.0	1.7	1.7	1.7	1.7	1.7	1.7
	-12.6	-13.0	1.8	1.8	1.8	1.8	1.8	1.8
	-10.5	-11.0	1.9	1.9	1.9	1.9	1.9	1.9
	-9.5	-10.0	1.9	1.9	1.9	1.9	1.9	1.9
	-8.5	-9.1	2.0	2.0	2.0	2.0	2.0	2.0
	-7.0	-7.6	2.0	2.0	2.0	2.0	2.0	2.0
	-5.0	-5.6	2.1	2.1	2.1	2.1	2.1	2.1
	-3.0	-3.7	2.2	2.2	2.2	2.2	2.2	2.2
	0.0	-0.7	2.3	2.3	2.3	2.3	2.3	2.3
	3.0	2.2	2.5	2.5	2.4	2.4	2.3	2.2
	5.0	4.1	2.5	2.5	2.5	2.4	2.3	2.2
	7.0	6.0	2.6	2.6	2.5	2.4	2.3	2.2
	9.0	7.9	2.7	2.7	2.5	2.4	2.3	2.2
11.0	9.8	2.8	2.7	2.5	2.4	2.3	2.2	
13.0	11.8	2.8	2.7	2.5	2.4	2.3	2.2	
15.0	13.7	2.8	2.7	2.5	2.4	2.3	2.2	
25	-19.8	-20.0	1.9	1.9	1.9	1.9	1.9	1.9
	-18.8	-19.0	1.9	1.9	1.9	1.9	1.9	1.9
	-16.7	-17.0	2.1	2.1	2.0	2.0	2.0	2.0
	-14.7	-15.0	2.2	2.2	2.2	2.2	2.2	2.2
	-12.6	-13.0	2.3	2.3	2.3	2.3	2.3	2.3
	-10.5	-11.0	2.4	2.4	2.4	2.4	2.4	2.4
	-9.5	-10.0	2.5	2.5	2.4	2.4	2.4	2.4
	-8.5	-9.1	2.5	2.5	2.5	2.5	2.5	2.5
	-7.0	-7.6	2.6	2.6	2.6	2.6	2.6	2.6
	-5.0	-5.6	2.7	2.7	2.7	2.7	2.7	2.7
	-3.0	-3.7	2.8	2.8	2.8	2.8	2.8	2.8
	0.0	-0.7	3.0	3.0	3.0	3.0	3.0	2.8
	3.0	2.2	3.1	3.1	3.1	3.1	3.0	2.8
	5.0	4.1	3.3	3.2	3.2	3.1	3.0	2.8
	7.0	6.0	3.4	3.4	3.2	3.1	3.0	2.8
	9.0	7.9	3.5	3.4	3.2	3.1	3.0	2.8
11.0	9.8	3.6	3.4	3.2	3.1	3.0	2.8	
13.0	11.8	3.6	3.4	3.2	3.1	3.0	2.8	
15.0	13.7	3.6	3.4	3.2	3.1	3.0	2.8	
32	-19.8	-20.0	2.4	2.4	2.3	2.3	2.3	2.3
	-18.8	-19.0	2.4	2.4	2.4	2.4	2.4	2.4
	-16.7	-17.0	2.6	2.6	2.6	2.6	2.6	2.5
	-14.7	-15.0	2.7	2.7	2.7	2.7	2.7	2.7
	-12.6	-13.0	2.9	2.9	2.8	2.8	2.8	2.8
	-10.5	-11.0	3.0	3.0	3.0	3.0	3.0	3.0
	-9.5	-10.0	3.1	3.1	3.1	3.1	3.0	3.0
	-8.5	-9.1	3.1	3.1	3.1	3.1	3.1	3.1
	-7.0	-7.6	3.2	3.2	3.2	3.2	3.2	3.2
	-5.0	-5.6	3.4	3.4	3.4	3.4	3.4	3.4
	-3.0	-3.7	3.5	3.5	3.5	3.5	3.5	3.5
	0.0	-0.7	3.7	3.7	3.7	3.7	3.7	3.5
	3.0	2.2	3.9	3.9	3.9	3.9	3.7	3.5
	5.0	4.1	4.1	4.1	4.0	3.9	3.7	3.5
	7.0	6.0	4.2	4.2	4.0	3.9	3.7	3.5
	9.0	7.9	4.3	4.3	4.0	3.9	3.7	3.5
11.0	9.8	4.5	4.3	4.0	3.9	3.7	3.5	
13.0	11.8	4.5	4.3	4.0	3.9	3.7	3.5	
15.0	13.7	4.5	4.3	4.0	3.9	3.7	3.5	
40	-19.8	-20.0	3.0	2.9	2.9	2.9	2.9	2.9
	-18.8	-19.0	3.0	3.0	3.0	3.0	3.0	3.0
	-16.7	-17.0	3.2	3.2	3.2	3.2	3.2	3.2
	-14.7	-15.0	3.4	3.4	3.4	3.4	3.4	3.4
	-12.6	-13.0	3.6	3.6	3.6	3.5	3.5	3.5
	-10.5	-11.0	3.7	3.7	3.7	3.7	3.7	3.7
	-9.5	-10.0	3.8	3.8	3.8	3.8	3.8	3.8
	-8.5	-9.1	3.9	3.9	3.9	3.9	3.9	3.9
	-7.0	-7.6	4.0	4.0	4.0	4.0	4.0	4.0
	-5.0	-5.6	4.2	4.2	4.2	4.2	4.2	4.2
	-3.0	-3.7	4.4	4.4	4.4	4.4	4.4	4.4
	0.0	-0.7	4.7	4.6	4.6	4.6	4.6	4.4
	3.0	2.2	4.9	4.9	4.9	4.8	4.7	4.4
	5.0	4.1	5.1	5.1	5.0	4.8	4.7	4.4
	7.0	6.0	5.3	5.2	5.0	4.8	4.7	4.4
	9.0	7.9	5.4	5.3	5.0	4.8	4.7	4.4
11.0	9.8	5.6	5.3	5.0	4.8	4.7	4.4	
13.0	11.8	5.6	5.3	5.0	4.8	4.7	4.4	
15.0	13.7	5.6	5.3	5.0	4.8	4.7	4.4	
50	-19.8	-20.0	3.7	3.7	3.7	3.7	3.7	3.7
	-18.8	-19.0	3.8	3.8	3.8	3.8	3.8	3.8
	-16.7	-17.0	4.1	4.0	4.0	4.0	4.0	4.0
	-14.7	-15.0	4.3	4.3	4.3	4.3	4.2	4.2
	-12.6	-13.0	4.5	4.5	4.5	4.5	4.5	4.5
	-10.5	-11.0	4.7	4.7	4.7	4.7	4.7	4.7
	-9.5	-10.0	4.8	4.8	4.8	4.8	4.8	4.8
	-8.5	-9.1	4.9	4.9	4.9	4.9	4.9	4.9
	-7.0	-7.6	5.1	5.1	5.1	5.1	5.1	5.1
	-5.0	-5.6	5.3	5.3	5.3	5.3	5.3	5.3
	-3.0	-3.7	5.5	5.5	5.5	5.5	5.5	5.5
	0.0	-0.7	5.9	5.9	5.8	5.8	5.8	5.5
	3.0	2.2	6.2	6.2	6.2	6.1	5.9	5.5
	5.0	4.1	6.4	6.4	6.3	6.1	5.9	5.5
	7.0	6.0	6.6	6.6	6.3	6.1	5.9	5.5
	9.0	7.9	6.8	6.7	6.3	6.1	5.9	5.5
11.0	9.8	7.0	6.7	6.3	6.1	5.9	5.5	
13.0	11.8	7.1	6.7	6.3	6.1	5.9	5.5	
15.0	13.7	7.1	6.7	6.3	6.1	5.9	5.5	

3TW25512-2A

5 Capacity tables

5 - 2 Heating Capacity Tables

FXSQ-P									
Unit size	Outdoor air temp.		Indoor air temperature: °CDB						
			16.0	18.0	20.0	21.0	22.0	24.0	
	°CDB	°CWB	kW	kW	kW	kW	kW	kW	
63	-19.8	-20.0	4.7	4.7	4.7	4.7	4.7	4.7	4.7
	-18.8	-19.0	4.9	4.9	4.8	4.8	4.8	4.8	4.8
	-16.7	-17.0	5.1	5.1	5.1	5.1	5.1	5.1	5.1
	-14.7	-15.0	5.4	5.4	5.4	5.4	5.4	5.4	5.4
	-12.6	-13.0	5.7	5.7	5.7	5.7	5.7	5.7	5.7
	-10.5	-11.0	6.0	6.0	6.0	6.0	6.0	6.0	5.9
	-9.5	-10.0	6.1	6.1	6.1	6.1	6.1	6.1	6.1
	-8.5	-9.1	6.3	6.3	6.2	6.2	6.2	6.2	6.2
	-7.0	-7.6	6.5	6.5	6.4	6.4	6.4	6.4	6.4
	-5.0	-5.6	6.8	6.7	6.7	6.7	6.7	6.7	6.7
	-3.0	-3.7	7.0	7.0	7.0	7.0	7.0	7.0	7.0
	0.0	-0.7	7.5	7.4	7.4	7.4	7.4	7.4	7.0
	3.0	2.2	7.9	7.8	7.8	7.7	7.5	7.5	7.0
	5.0	4.1	8.1	8.1	8.0	7.7	7.5	7.5	7.0
	7.0	6.0	8.4	8.4	8.0	7.7	7.5	7.5	7.0
	9.0	7.9	8.7	8.5	8.0	7.7	7.5	7.5	7.0
	11.0	9.8	8.9	8.5	8.0	7.7	7.5	7.5	7.0
13.0	11.8	9.0	8.5	8.0	7.7	7.5	7.5	7.0	
15.0	13.7	9.0	8.5	8.0	7.7	7.5	7.5	7.0	
80	-19.8	-20.0	5.9	5.9	5.9	5.9	5.9	5.9	5.8
	-18.8	-19.0	6.1	6.1	6.0	6.0	6.0	6.0	6.0
	-16.7	-17.0	6.4	6.4	6.4	6.4	6.4	6.4	6.4
	-14.7	-15.0	6.8	6.8	6.8	6.7	6.7	6.7	6.7
	-12.6	-13.0	7.1	7.1	7.1	7.1	7.1	7.1	7.1
	-10.5	-11.0	7.5	7.5	7.5	7.5	7.4	7.4	7.4
	-9.5	-10.0	7.7	7.7	7.6	7.6	7.6	7.6	7.6
	-8.5	-9.1	7.8	7.8	7.8	7.8	7.8	7.8	7.8
	-7.0	-7.6	8.1	8.1	8.1	8.1	8.1	8.0	8.0
	-5.0	-5.6	8.5	8.4	8.4	8.4	8.4	8.4	8.4
	-3.0	-3.7	8.8	8.8	8.8	8.7	8.7	8.7	8.7
	0.0	-0.7	9.3	9.3	9.3	9.3	9.3	9.3	8.7
	3.0	2.2	9.8	9.8	9.8	9.7	9.4	9.4	8.7
	5.0	4.1	10.2	10.1	10.0	9.7	9.4	9.4	8.7
	7.0	6.0	10.5	10.5	10.0	9.7	9.4	9.4	8.7
	9.0	7.9	10.8	10.6	10.0	9.7	9.4	9.4	8.7
	11.0	9.8	11.2	10.6	10.0	9.7	9.4	9.4	8.7
13.0	11.8	11.3	10.6	10.0	9.7	9.4	9.4	8.7	
15.0	13.7	11.3	10.6	10.0	9.7	9.4	9.4	8.7	
100	-19.8	-20.0	7.4	7.4	7.3	7.3	7.3	7.3	7.3
	-18.8	-19.0	7.6	7.6	7.6	7.5	7.5	7.5	7.5
	-16.7	-17.0	8.0	8.0	8.0	8.0	8.0	8.0	8.0
	-14.7	-15.0	8.5	8.5	8.4	8.4	8.4	8.4	8.4
	-12.6	-13.0	8.9	8.9	8.9	8.9	8.9	8.9	8.8
	-10.5	-11.0	9.4	9.3	9.3	9.3	9.3	9.3	9.3
	-9.5	-10.0	9.6	9.6	9.5	9.5	9.5	9.5	9.5
	-8.5	-9.1	9.8	9.8	9.7	9.7	9.7	9.7	9.7
	-7.0	-7.6	10.1	10.1	10.1	10.1	10.1	10.1	10.0
	-5.0	-5.6	10.6	10.5	10.5	10.5	10.5	10.5	10.5
	-3.0	-3.7	11.0	11.0	10.9	10.9	10.9	10.9	10.9
	0.0	-0.7	11.6	11.6	11.6	11.6	11.6	11.6	10.9
	3.0	2.2	12.3	12.3	12.2	12.1	11.7	11.7	10.9
	5.0	4.1	12.7	12.7	12.5	12.1	11.7	11.7	10.9
	7.0	6.0	13.1	13.1	12.5	12.1	11.7	11.7	10.9
	9.0	7.9	13.5	13.3	12.5	12.1	11.7	11.7	10.9
	11.0	9.8	14.0	13.3	12.5	12.1	11.7	11.7	10.9
13.0	11.8	14.1	13.3	12.5	12.1	11.7	11.7	10.9	
15.0	13.7	14.1	13.3	12.5	12.1	11.7	11.7	10.9	
125	-19.8	-20.0	9.4	9.4	9.4	9.4	9.4	9.4	9.3
	-18.8	-19.0	9.7	9.7	9.7	9.7	9.6	9.6	9.6
	-16.7	-17.0	10.3	10.3	10.2	10.2	10.2	10.2	10.2
	-14.7	-15.0	10.9	10.8	10.8	10.8	10.8	10.8	10.8
	-12.6	-13.0	11.4	11.4	11.4	11.4	11.3	11.3	11.3
	-10.5	-11.0	12.0	12.0	11.9	11.9	11.9	11.9	11.9
	-9.5	-10.0	12.3	12.2	12.2	12.2	12.2	12.2	12.2
	-8.5	-9.1	12.5	12.5	12.5	12.5	12.4	12.4	12.4
	-7.0	-7.6	13.0	12.9	12.9	12.9	12.9	12.9	12.8
	-5.0	-5.6	13.5	13.5	13.5	13.4	13.4	13.4	13.4
	-3.0	-3.7	14.1	14.0	14.0	14.0	14.0	14.0	13.9
	0.0	-0.7	14.9	14.9	14.8	14.8	14.8	14.8	13.9
	3.0	2.2	15.7	15.7	15.7	15.5	15.0	15.0	13.9
	5.0	4.1	16.3	16.2	16.0	15.5	15.0	15.0	13.9
	7.0	6.0	16.8	16.8	16.0	15.5	15.0	15.0	13.9
	9.0	7.9	17.3	17.0	16.0	15.5	15.0	15.0	13.9
	11.0	9.8	17.9	17.0	16.0	15.5	15.0	15.0	13.9
13.0	11.8	18.1	17.0	16.0	15.5	15.0	15.0	13.9	
15.0	13.7	18.1	17.0	16.0	15.5	15.0	15.0	13.9	
140	-19.8	-20.0	10.6	10.6	10.6	10.6	10.5	10.5	10.5
	-18.8	-19.0	10.9	10.9	10.9	10.9	10.9	10.9	10.8
	-16.7	-17.0	11.6	11.6	11.5	11.5	11.5	11.5	11.5
	-13.7	-15.0	12.2	12.2	12.2	12.1	12.1	12.1	12.1
	-11.8	-13.0	12.9	12.8	12.8	12.8	12.8	12.8	12.7
	-9.8	-11.0	13.5	13.5	13.4	13.4	13.4	13.4	13.4
	-9.5	-10.0	13.8	13.8	13.7	13.7	13.7	13.7	13.7
	-8.5	-9.1	14.1	14.1	14.0	14.0	14.0	14.0	14.0
	-7.0	-7.6	14.6	14.5	14.5	14.5	14.5	14.5	14.4
	-5.0	-5.6	15.2	15.2	15.1	15.1	15.1	15.1	15.1
	-3.0	-3.7	15.8	15.8	15.8	15.7	15.7	15.7	15.7
	0.0	-0.7	16.8	16.7	16.7	16.7	16.7	16.7	15.7
	3.0	2.2	17.7	17.7	17.6	17.4	16.8	16.8	15.7
	5.0	4.1	18.3	18.3	18.0	17.4	16.8	16.8	15.7
	7.0	6.0	18.9	18.9	18.0	17.4	16.8	16.8	15.7
	9.0	7.9	19.5	19.2	18.0	17.4	16.8	16.8	15.7
	11.0	9.8	20.1	19.2	18.0	17.4	16.8	16.8	15.7
13.0	11.8	20.3	19.2	18.0	17.4	16.8	16.8	15.7	
15.0	13.7	20.3	19.2	18.0	17.4	16.8	16.8	15.7	

3TW25512-2A

6 Dimensional drawings

FXSQ20-32P

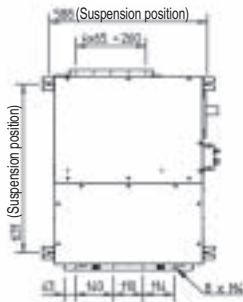
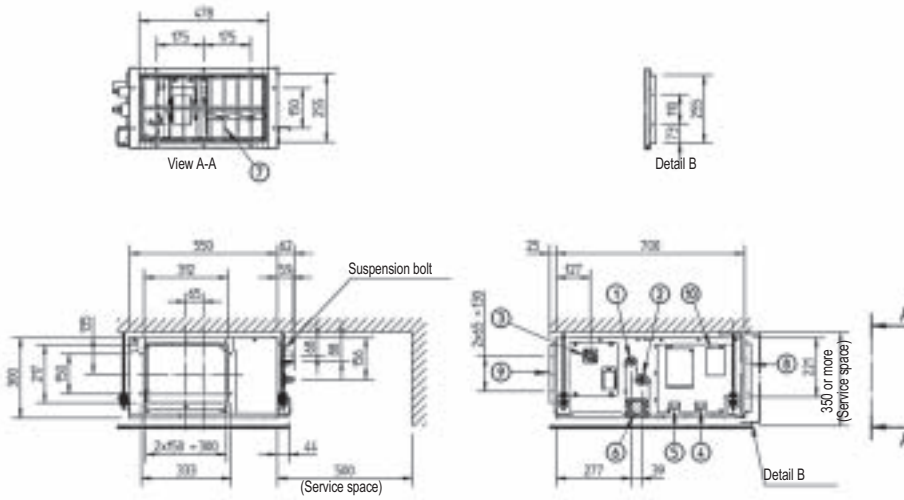

Nr	Name	Description
1	Liquid pipe connection	ø 6.35 flare (connection)
2	Gas pipe connection	ø 12.70 (flare connection)
3	Drain pipe connection	VP20 (O.D. ø 32 /I.D. ø 25)
4	Remote control wiring connection	
5	Power supply connection	
6	Drain hole	VP25 (OD ø 32 /I.D. ø 25)
7	Air filter	
8	Air suction side	
9	Air discharge side	
10	Nameplate	

NOTE

- 1 Refer to 'outlook drawing for installing optional accessories' when installing optional accessories.
- 2 The required ceiling depth varies according to the configuration of the specific system.
- 3 For maintenance of the air filter, it is necessary to provide a service access panel. Refer to the 'filter installation method' drawing.

3TW31184-1A

FXSQ40-50P

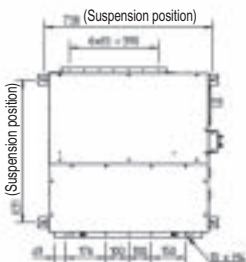
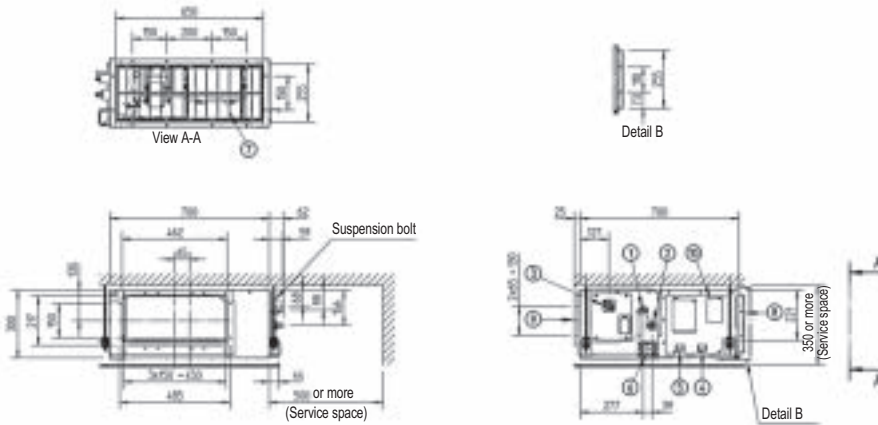

Nr	Name	Description
1	Liquid pipe connection	ø 6.35 flare (connection)
2	Gas pipe connection	ø 12.70 (flare connection)
3	Drain pipe connection	VP25 (O.D. ø 32 /I.D. ø 25)
4	Remote control wiring connection	
5	Power supply connection	
6	Drain hole	VP25 (OD ø 32 /I.D. ø 25)
7	Air filter	
8	Air suction side	
9	Air discharge side	
10	Nameplate	

NOTE

- 1 Refer to 'outlook drawing for installing optional accessories' when installing optional accessories.
- 2 The required ceiling depth varies according to the configuration of the specific system.
- 3 For maintenance of the air filter, it is necessary to provide a service access panel. Refer to the 'filter installation method' drawing.

3TW31214-1A

6 Dimensional drawings

FXSQ63-80P

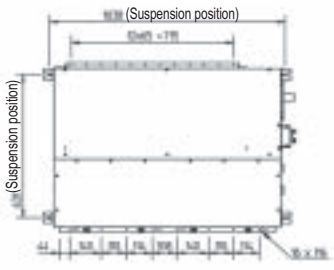
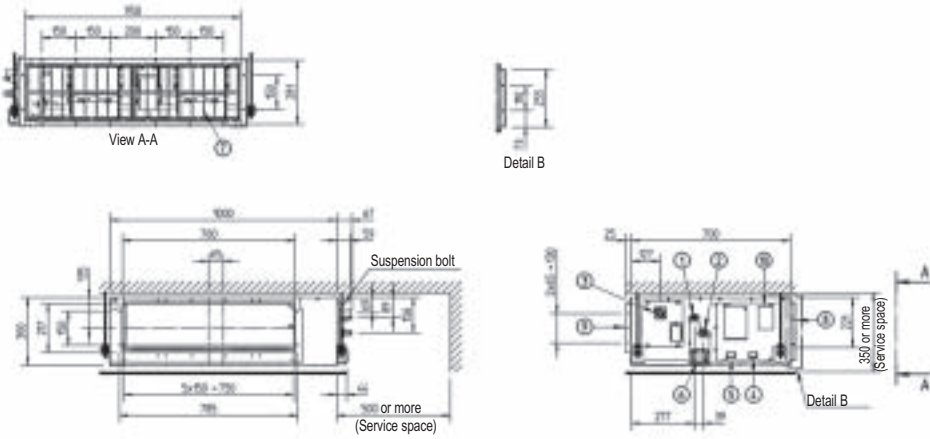

Nr	Name	Description
1	Liquid pipe connection	ø 9.52 flare (connection)
2	Gas pipe connection	ø 15.90 (flare connection)
3	Drain pipe connection	VP25 (O.D. ø 32 / I.D. ø 25)
4	Remote control wiring connection	
5	Power supply connection	
6	Drain hole	VP25 (OD ø 32 / I.D. ø 25)
7	Air filter	
8	Air suction side	
9	Air discharge side	
10	Nameplate	

- NOTE**
- 1 Refer to 'outlook drawing for installing optional accessories' when installing optional accessories.
 - 2 The required ceiling depth varies according to the configuration of the specific system.
 - 3 For maintenance of the air filter, it is necessary to provide a service access panel. Refer to the 'filter installation method' drawing.

3TW31234-1A

FXSQ100-140P

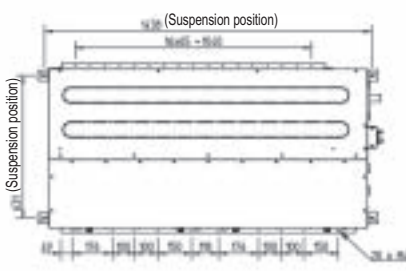
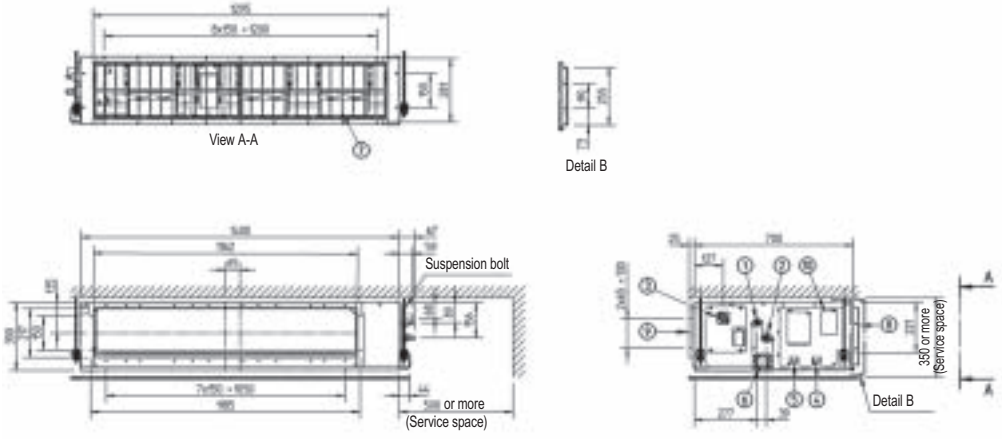

Nr	Name	Description
1	Liquid pipe connection	ø 9.52 flare (connection)
2	Gas pipe connection	ø 15.90 (flare connection)
3	Drain pipe connection	VP25 (O.D. ø 32 / I.D. ø 25)
4	Remote control wiring connection	
5	Power supply connection	
6	Drain hole	VP25 (OD ø 32 / I.D. ø 25)
7	Air filter	
8	Air suction side	
9	Air discharge side	
10	Nameplate	

- NOTE**
- 1 Refer to 'outlook drawing for installing optional accessories' when installing optional accessories.
 - 2 The required ceiling depth varies according to the configuration of the specific system.
 - 3 For maintenance of the air filter, it is necessary to provide a service access panel. Refer to the 'filter installation method' drawing.

3TW31254-1A

7 Centre of gravity

FXSQ-P

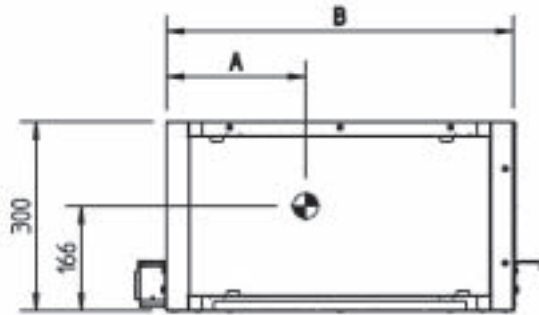
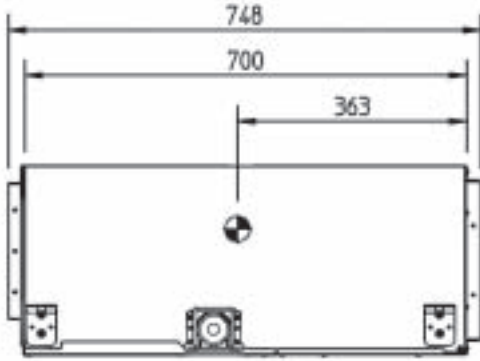

Model	A	B
FXSQ20~32	220	550
FXSQ40,50	283	700
FXSQ63,80	441	1000
FXSQ100,125,140	619	1400

4TW31189-1B

8 Piping diagrams

FXSQ20-140P

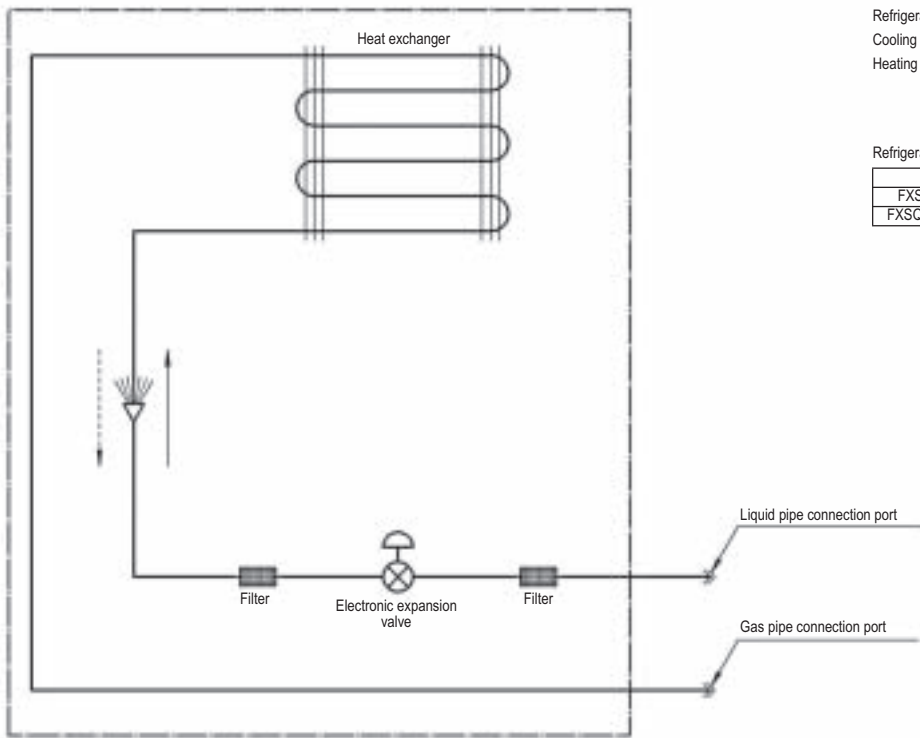

Refrigerant flow
 Cooling ———→
 Heating - - - →

Refrigerant pipe connection port diameters

Model	Gas	Liquid
FXSQ20,25,32,40,50	Ø12.70	Ø6.35
FXSQ63,80,100,125,140	Ø15.90	Ø9.52

3TW31185-1A

9 Wiring diagrams

9 - 1 Wiring Diagrams - Single Phase

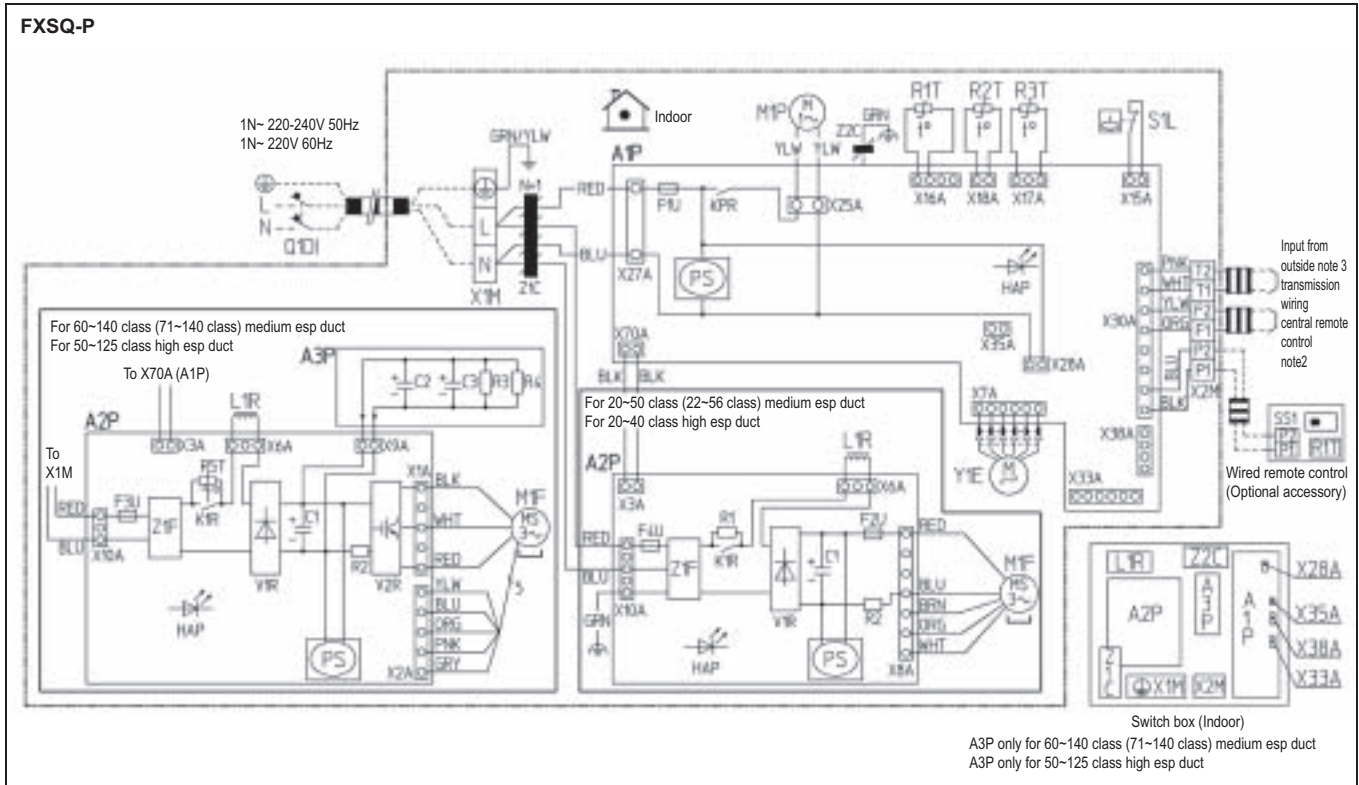

Indoor Unit		R2T	Thermistor (Liquid)
A1P	Printed circuit board	R3T	Thermistor (Gas)
A2P	Printed circuit board (Fan)	R5T	Thermistor NTC (Current limiting)
A3P	Printed circuit board (Capacitor)	S1L	Float switch
C1,C2,C3	Capacitor	V1R	Diode bridge
F1U	Fuse (T, 3.15A, 250V)	V2R	Power module
F2U	Fuse (T, 5A, 250V)	X1M	Terminal strip (Power supply)
F3U	Fuse (T, 6.3A, 250V)	X2M	Terminal strip (Control)
F4U	Fuse (T, 6.3A, 250V)	Y1E	Electronic expansion valve
HAP	Light emitting diode (Service monitor-green)	Z1C, Z2C	Noise filter (Ferrite core)
KPR, K1R	Magnetic relay	Z1F	Noise filter
L1R	Reactor	Connector optional accessory	
M1F	Motor fan	X28A	Connector (Power supply for wiring)
M1P	Motor (Drain pump)	X33A	Connector (For wiring)
PS	Switching power supply	X35A	Connector (Adapter)
Q1DI	Earth leak detector	X38A	Connector (For wiring)
R1	Resistor (Current limiting)	Wired remote control	
R2	Current sensing device	R1T	Thermistor (Air)
R3, R4	Resistor (Electric discharge)	SS1	Selector switch (Main/sub)
R1T	Thermistor (Suction air)		

- : Field wiring
- L : Live
- N : Neutral
- : Connector
- : Wire clamp
- : Protective earth (screw)

- Colors:
- | | | | |
|-----|--------|-----|--------|
| BLK | Black | PNK | Pink |
| BLU | Blue | RED | Red |
| BRN | Brown | WHT | White |
| GRY | Grey | YLW | Yellow |
| ORG | Orange | GRN | Green |

2TW32656-1

NOTES

- Use copper conductors only.
- When using the central remote control, see manual for connection to the unit.
- When connecting the input wires from outside, forced 'off' or 'on/off' operation can be selected by the remote control. See installation manual for more details.

10 Sound data

10 - 1 Sound Power Spectrum

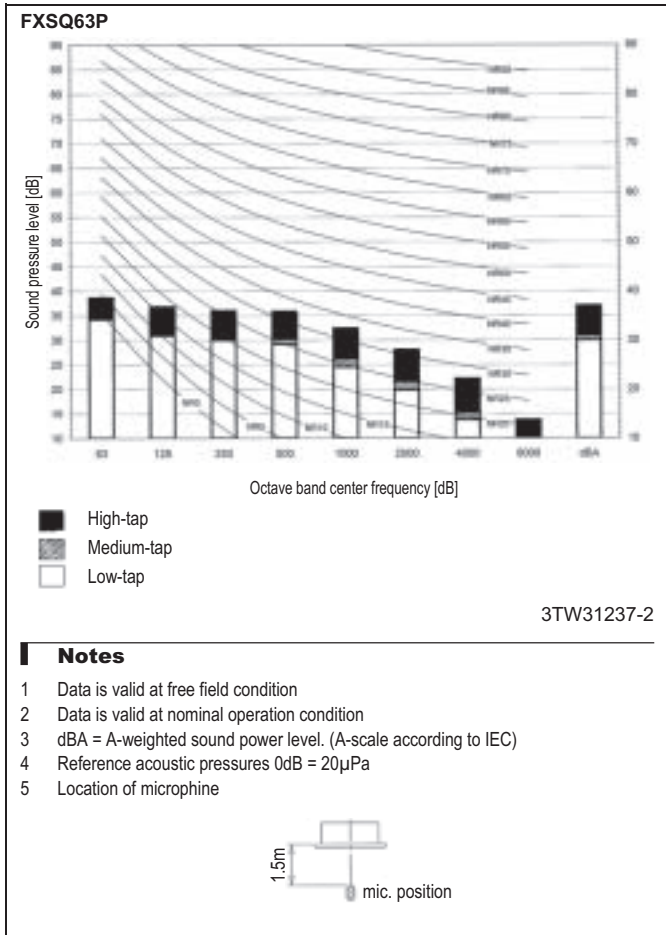
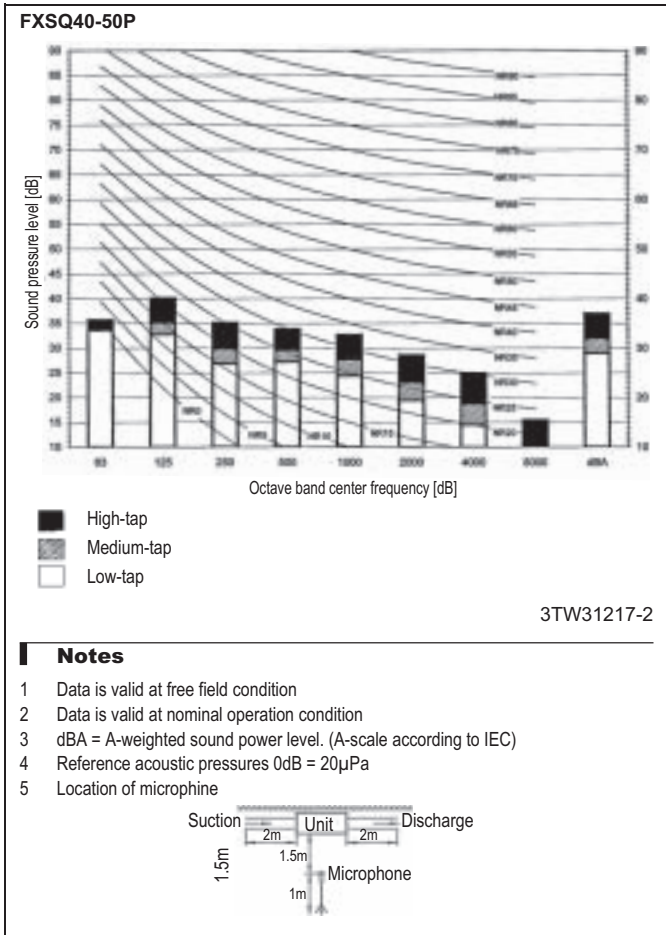
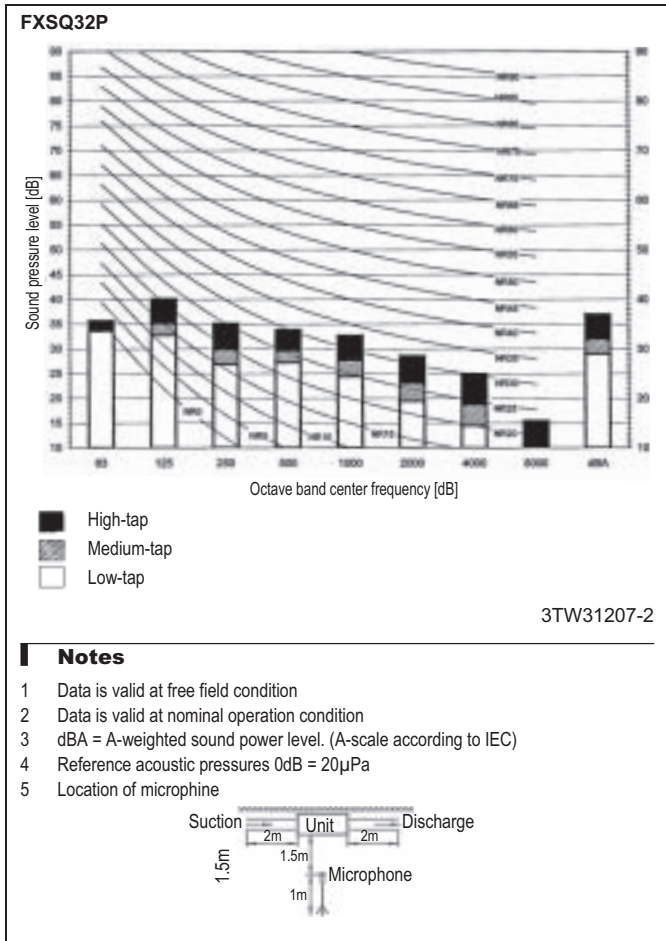
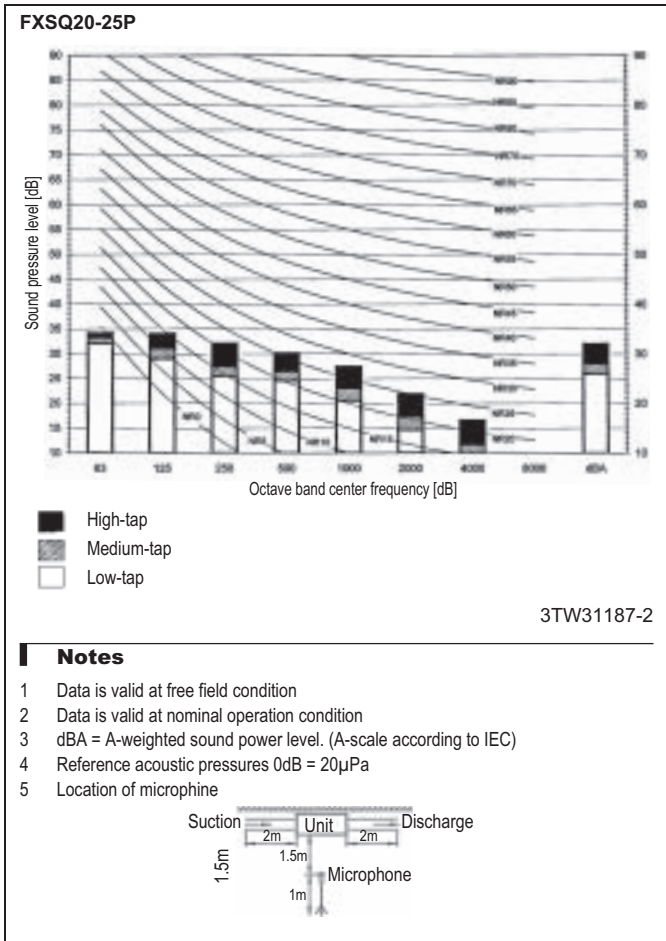

10 Sound data

10 - 1 Sound Power Spectrum

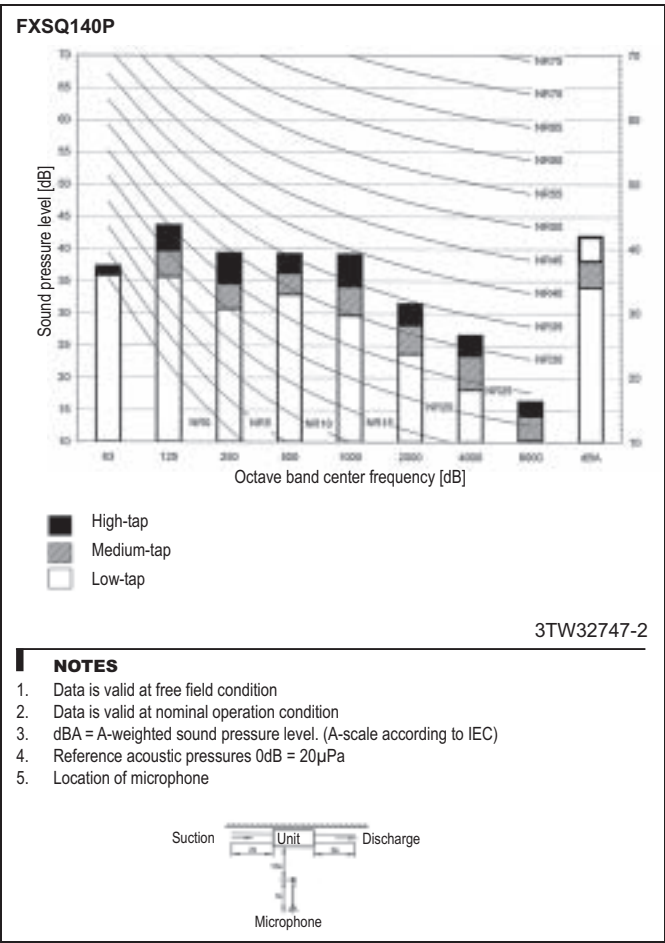
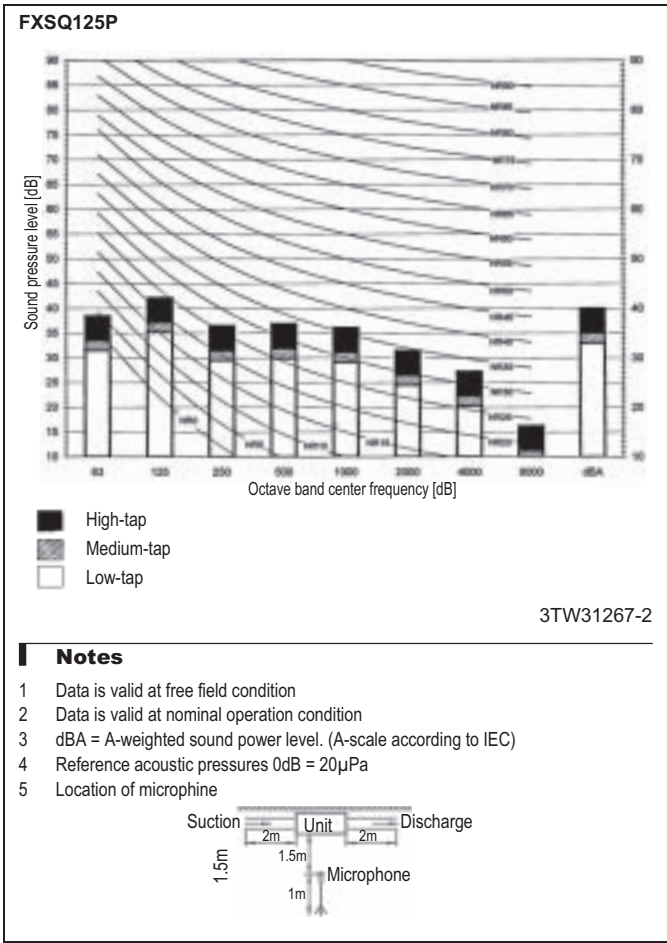
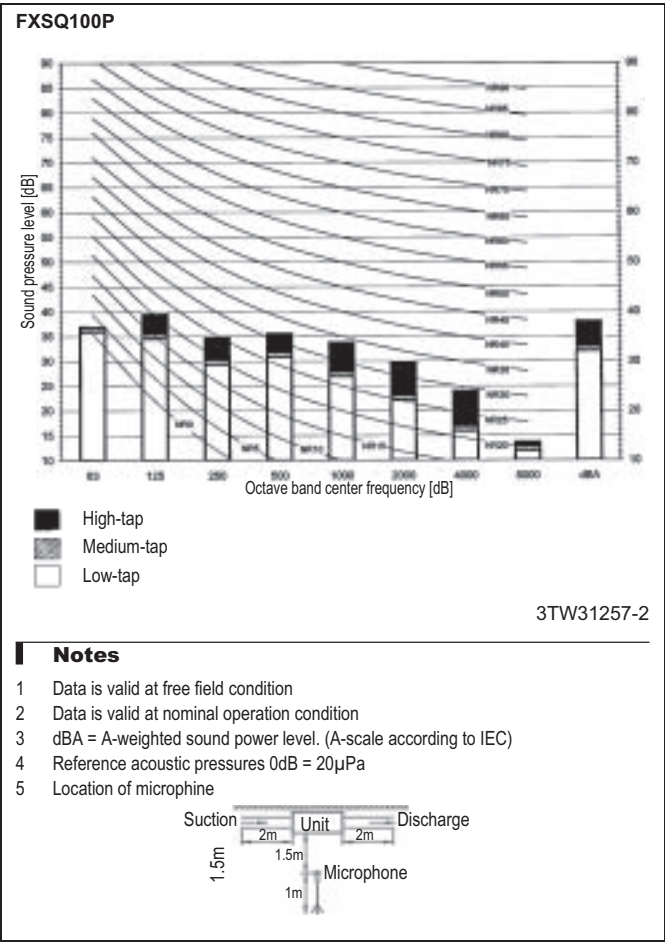
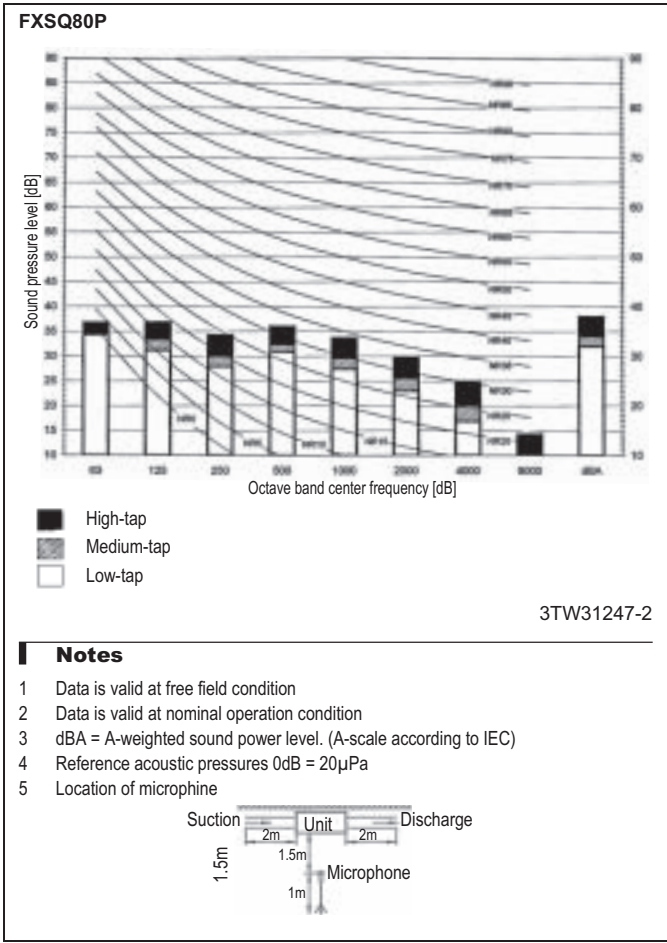

10 Sound data

10 - 2 Sound Pressure Spectrum

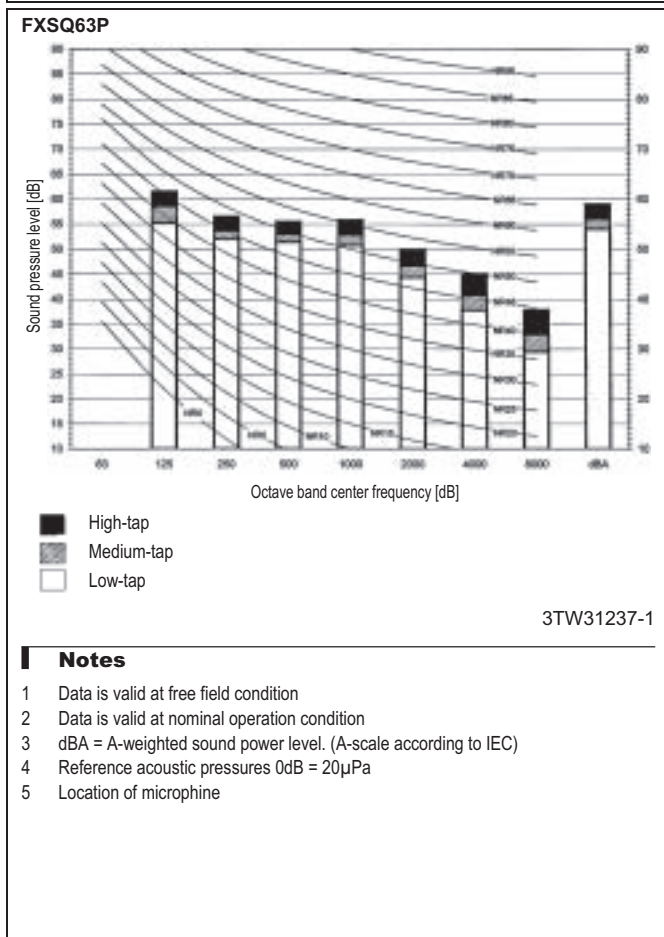
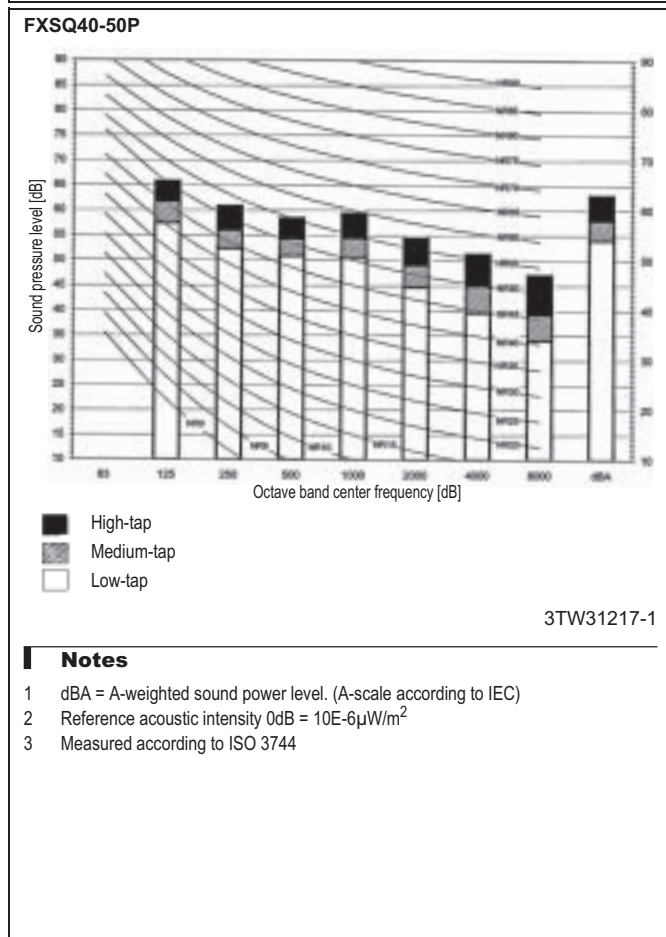
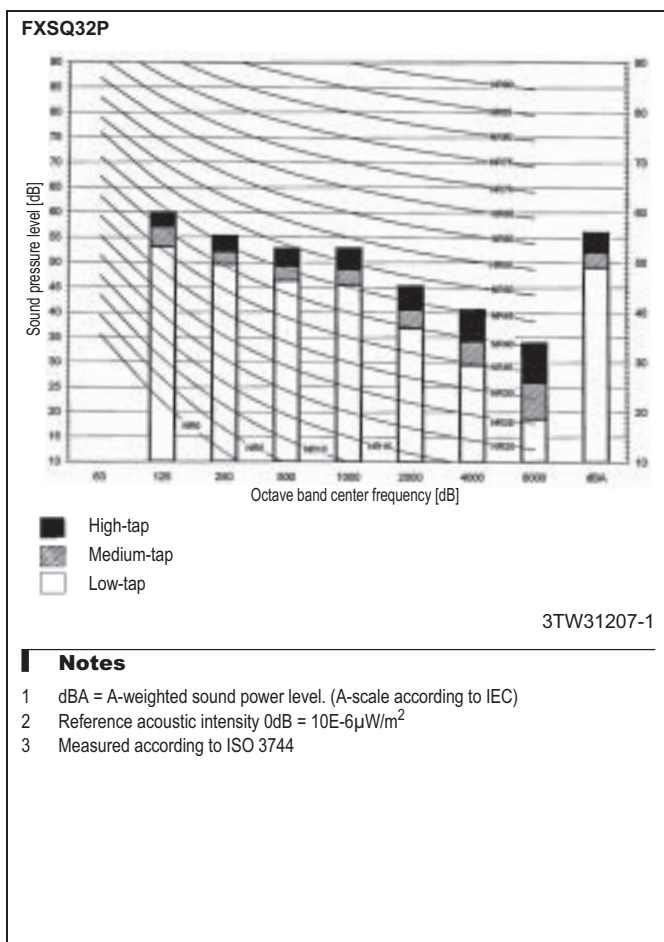
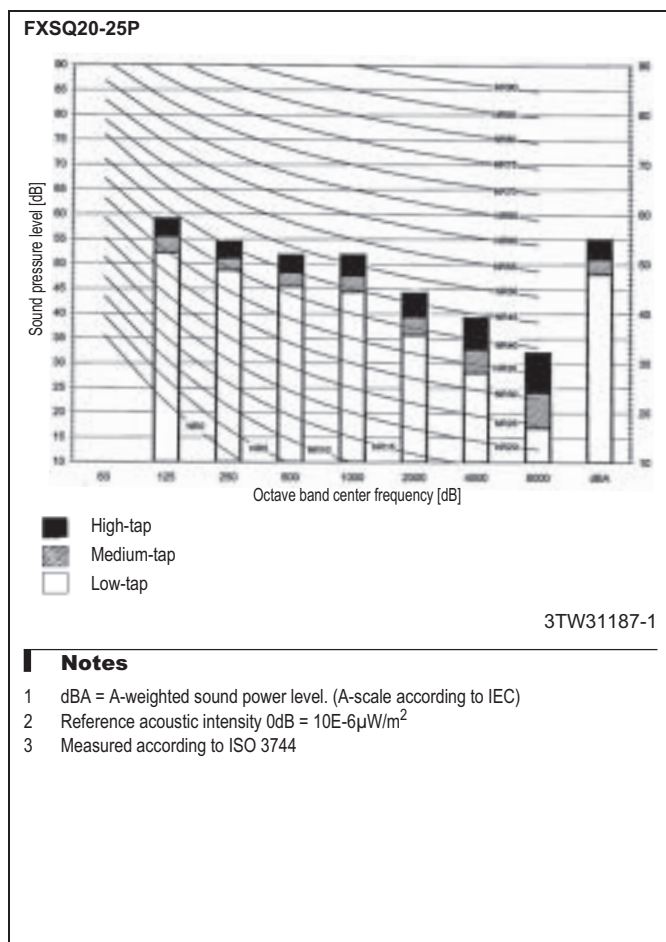

10 Sound data

10 - 2 Sound Pressure Spectrum

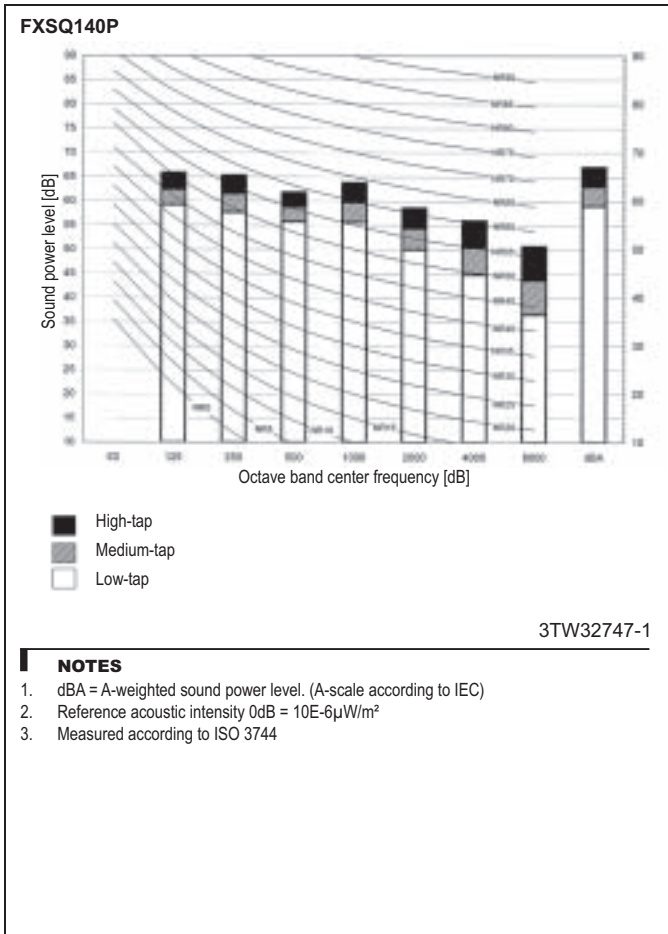
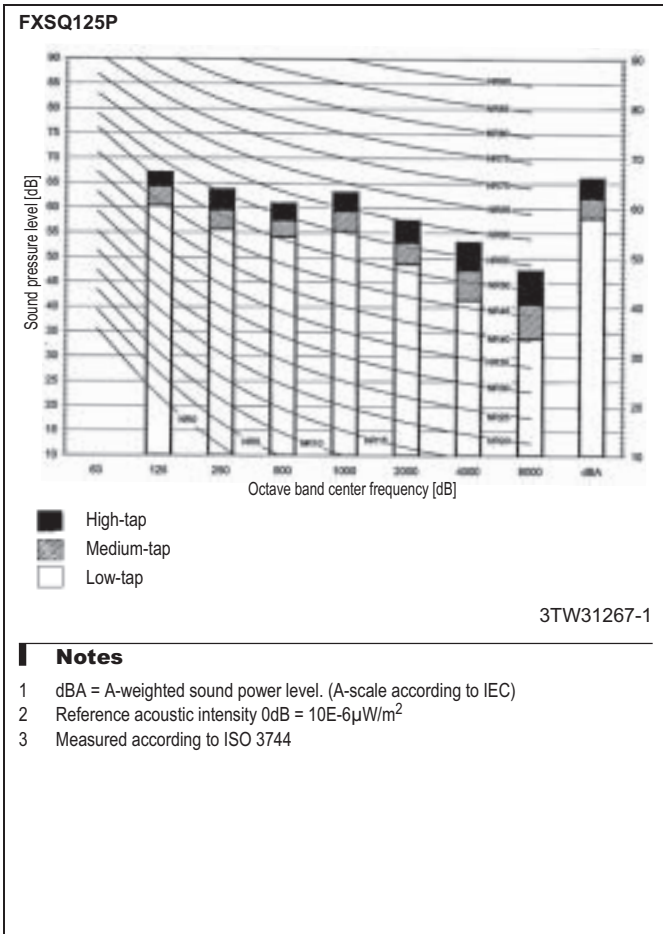
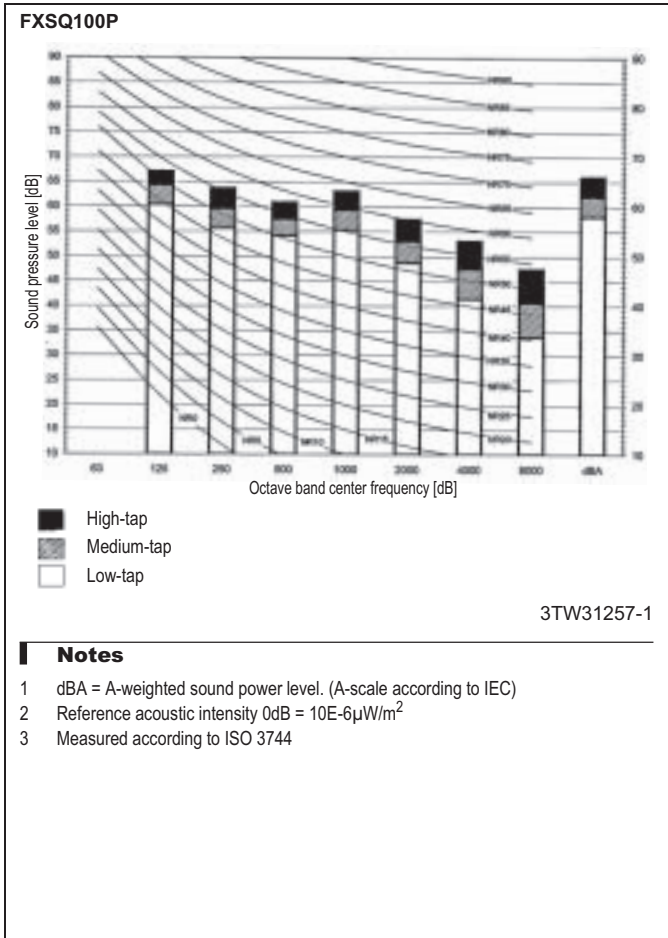
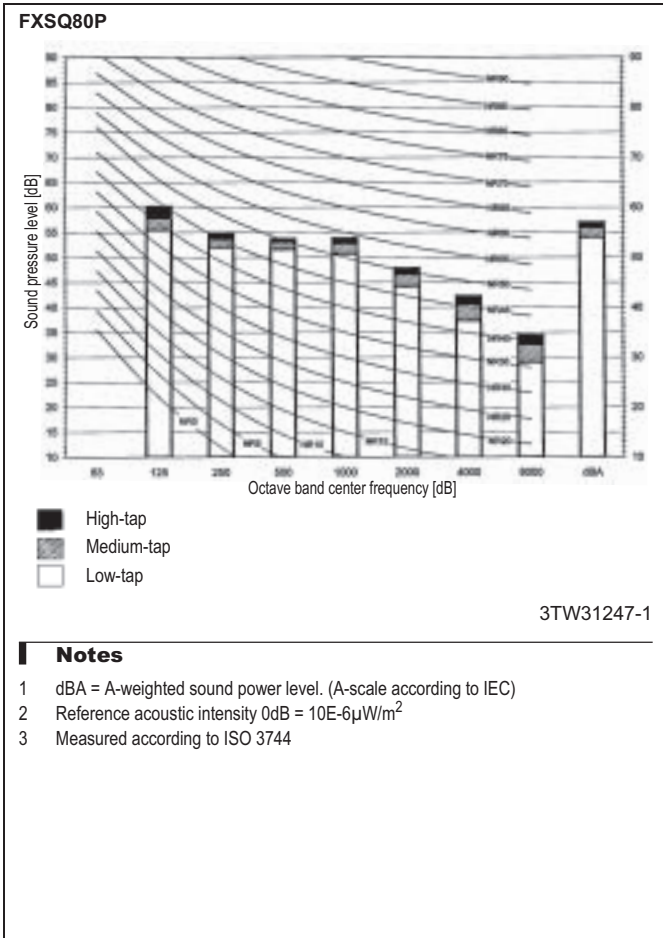

11 Fan characteristics

11 - 1 Fan Characteristics

FXSQ20-25P

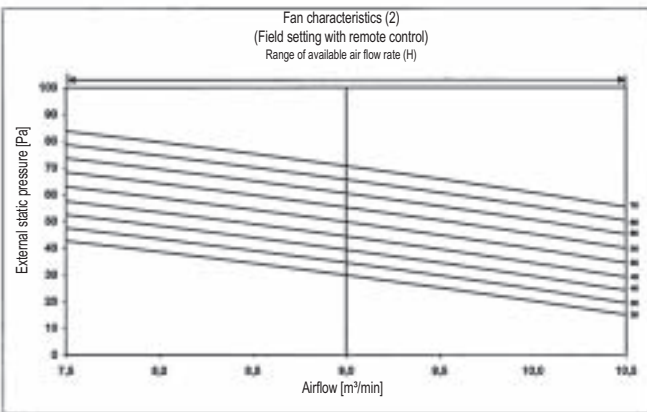
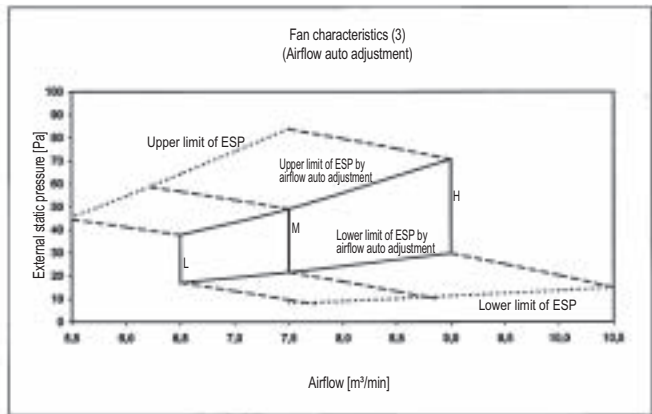
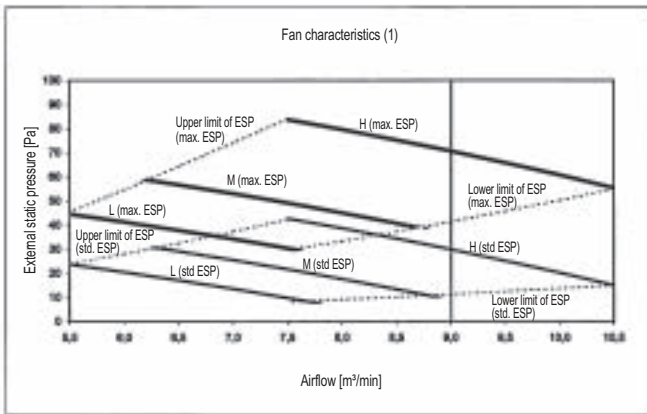

NOTES

- 1 Fan characteristics as shown ar in "fan only" mode.
- 2 ESP: External static pressure

3TW31188-1

FXSQ32P

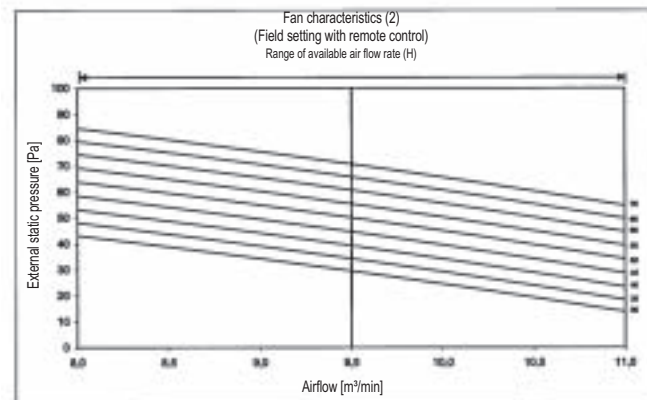
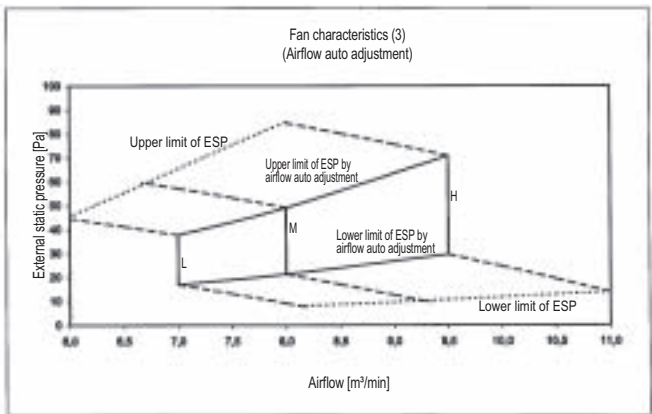
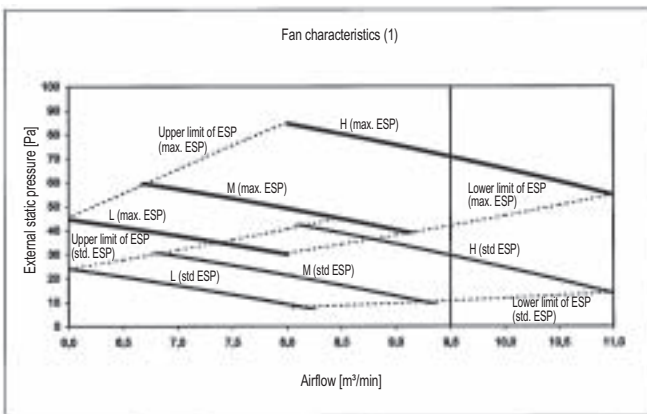

NOTES

- 1 Fan characteristics as shown ar in "fan only" mode.
- 2 ESP: External static pressure

3TW31208-1

11 Fan characteristics

11 - 1 Fan Characteristics

FXSQ40-50

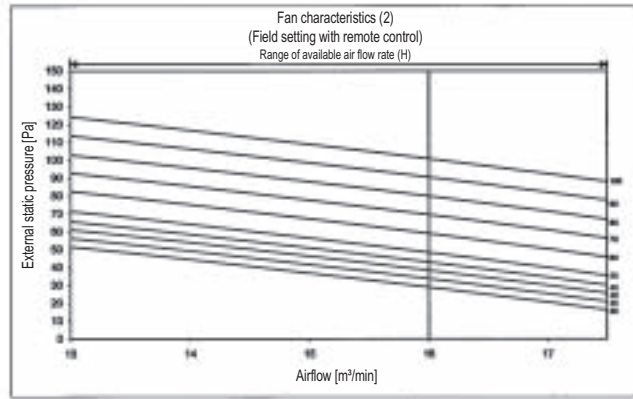
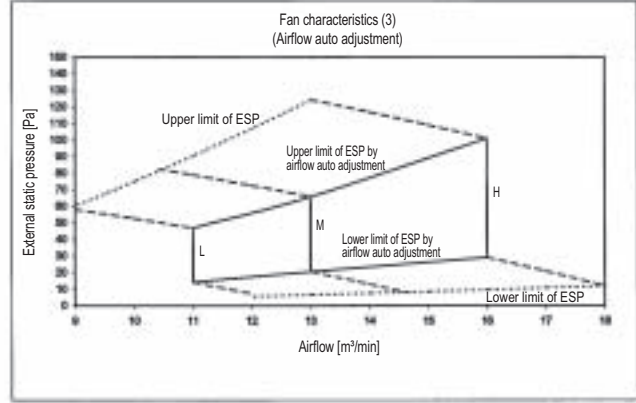
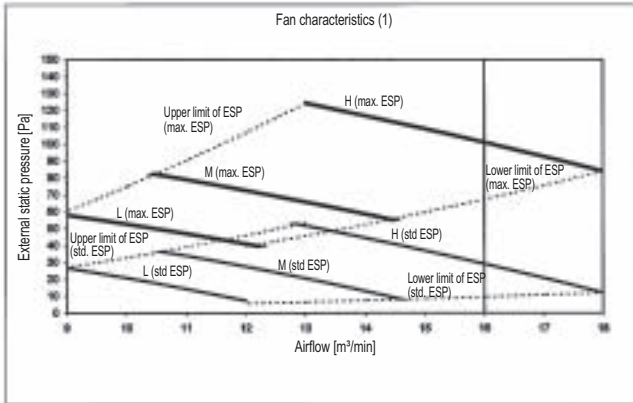

NOTES

- 1 Fan characteristics as shown ar in "fan only" mode.
- 2 ESP: External static pressure

3TW31218-1

FXSQ63P

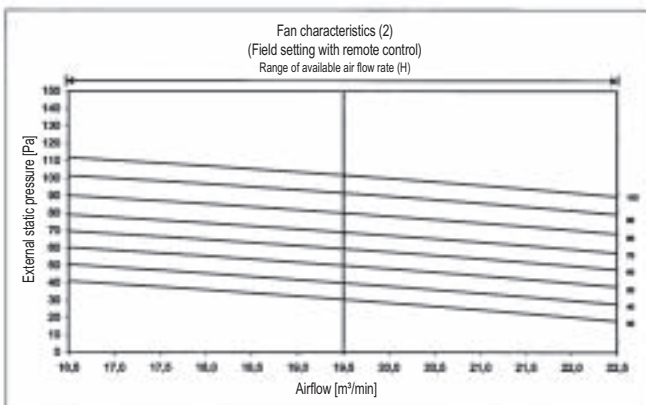
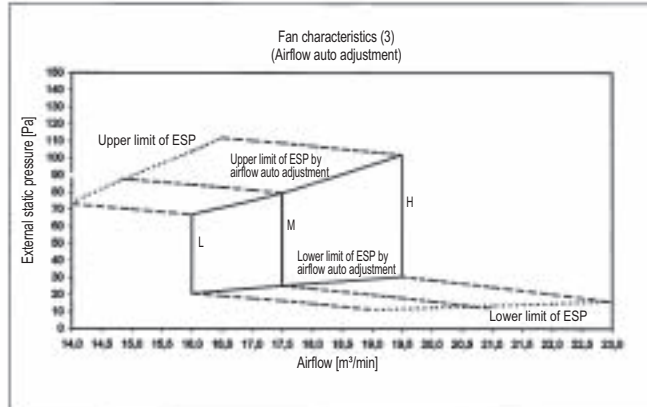
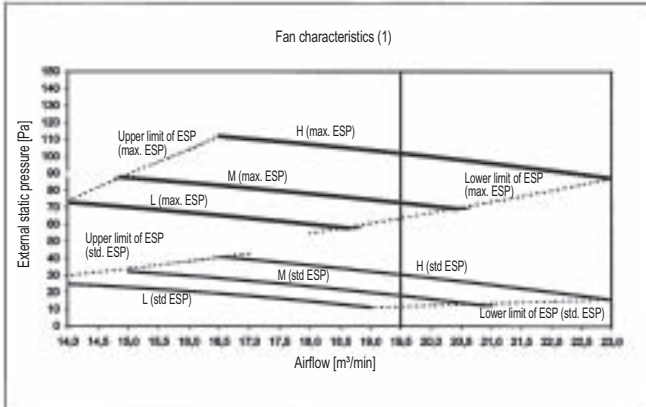

NOTES

- 1 Fan characteristics as shown ar in "fan only" mode.
- 2 ESP: External static pressure

3TW31238-1

11 Fan characteristics

11 - 1 Fan Characteristics

FXSQ80P7

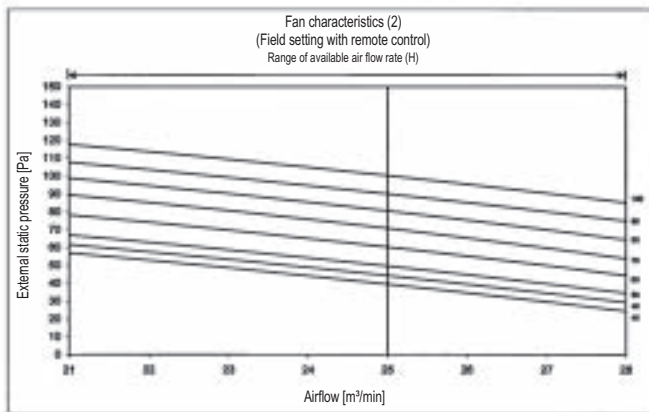
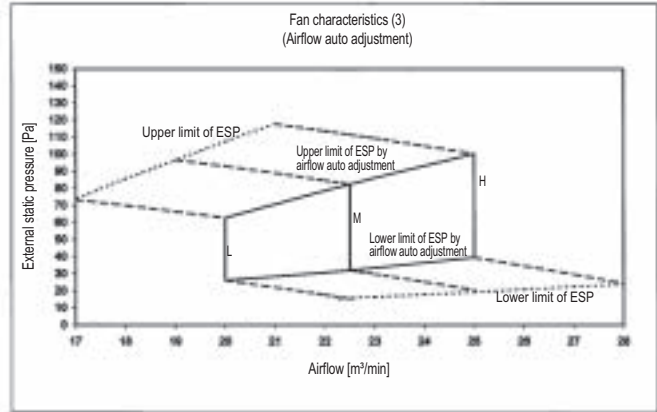
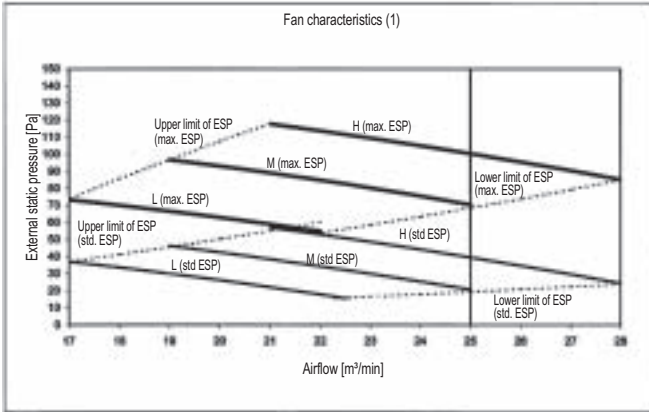

NOTES

- 1 Fan characteristics as shown ar in "fan only" mode.
- 2 ESP: External static pressure

3TW31248-1

FXSQ100P

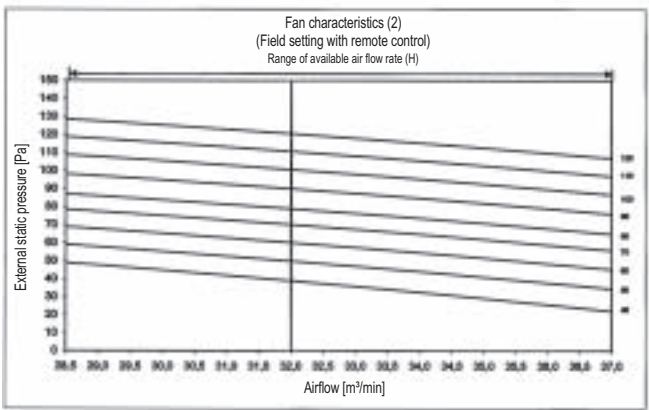
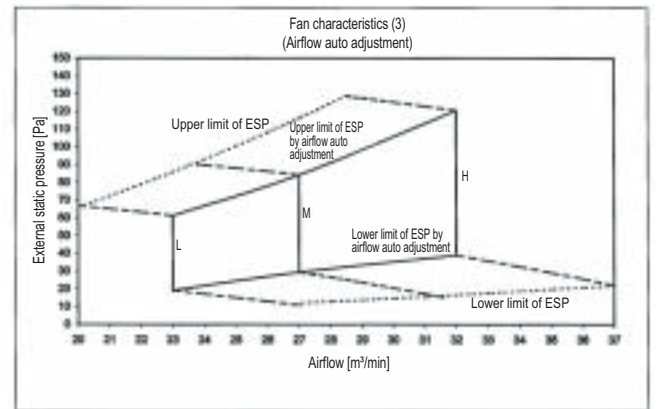
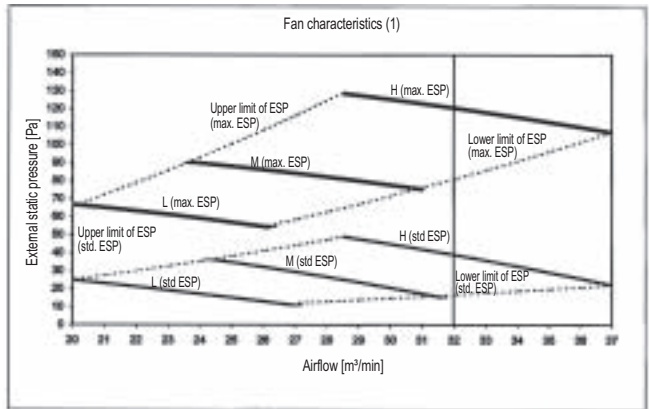

NOTES

- 1 Fan characteristics as shown ar in "fan only" mode.
- 2 ESP: External static pressure

3TW31258-1

11 Fan characteristics

11 - 1 Fan Characteristics

FXSQ125P

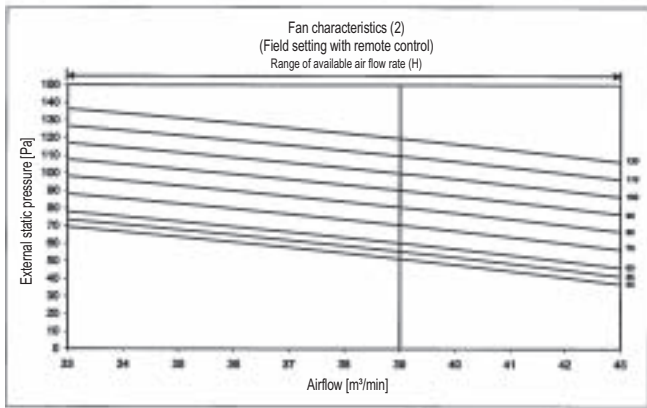
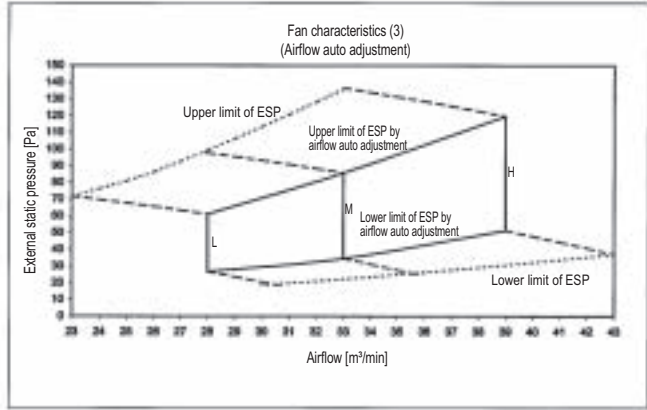
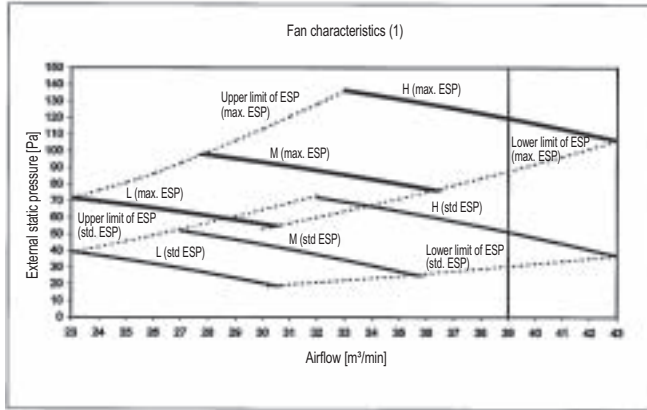

NOTES

- 1 Fan characteristics as shown are in "fan only" mode.
- 2 ESP: External static pressure

3TW31268-1

FXSQ140P

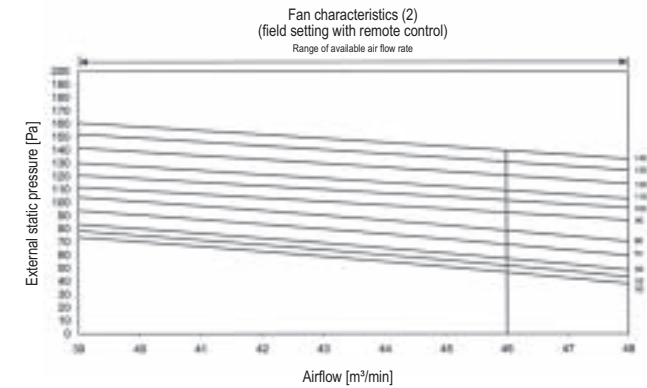
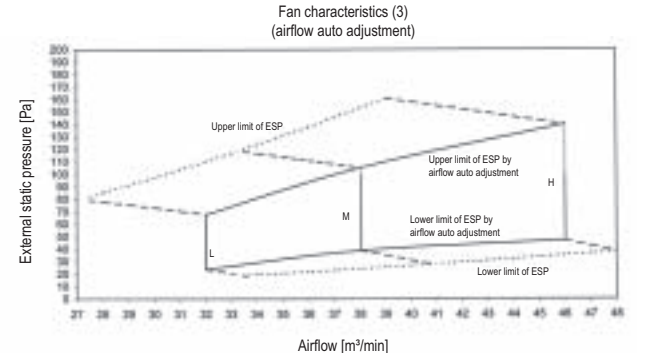
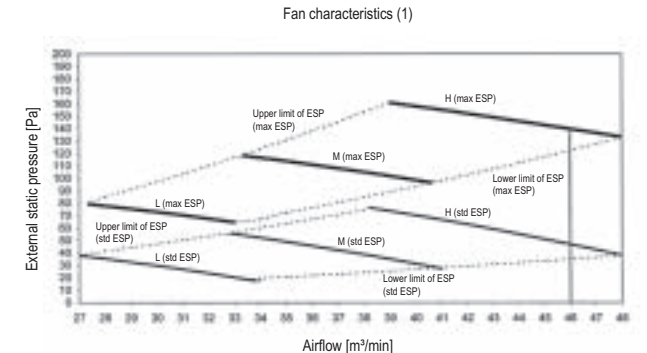

3TW32748-1

NOTES

- 1 Fan characteristics as shown are in "fan only" mode.
- 2 ESP: External static pressure.
- 3 — If the ESP is higher than 100 Pa, do not use airflow auto adjustment function: select the fan step manually, by field setting with remote control.

12 Installation

12 - 1 Installation Method

FXSQ-P

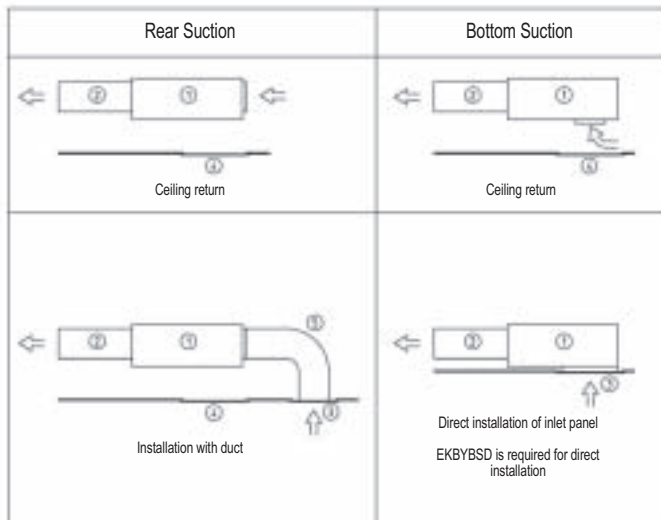

Wide variety of installation methods

Number	Description	
1	Main body	
2	Air outlet duct	Field supply
3	Inlet panel	Optional accessory
4	Access panel	optional accessory
5	Air inlet duct	Field supply

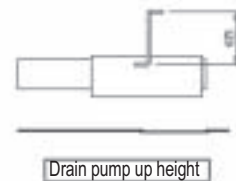

Easy modification from rear to bottom suction

3TW31183-1A

12 Installation

12 - 2 Filter Installation Method

FXSQ-P

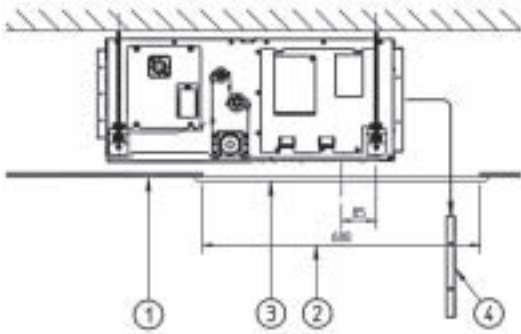

Installation without air inlet duct

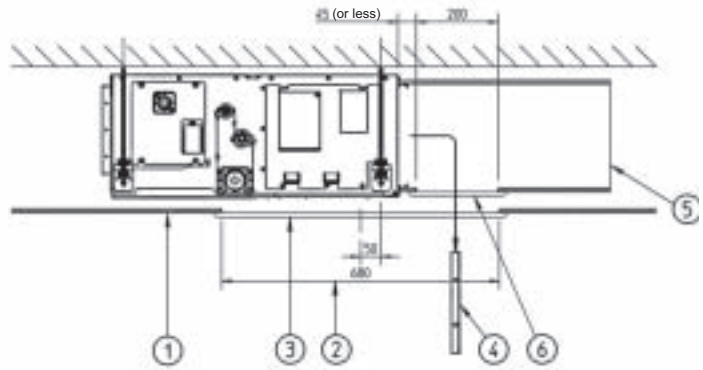

Installation with air inlet duct

Nr.	Description
1	Suspended Ceiling
2	Ceiling opening
3	Service access panel (optional)
4	Air filter
5	Air inlet duct
6	Duct service opening

NOTES

- 1 When installing the unit with rear suction, a service opening is necessary for the maintenance of the air filters.
- 2 When installing the unit with a suction duct. A service opening must be provided in the duct.

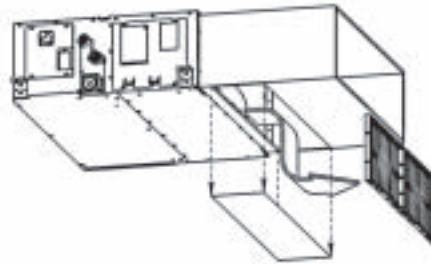

3TW31184-4

12 Installation

12 - 3 Switch Box Connection

FXSQ20-140P

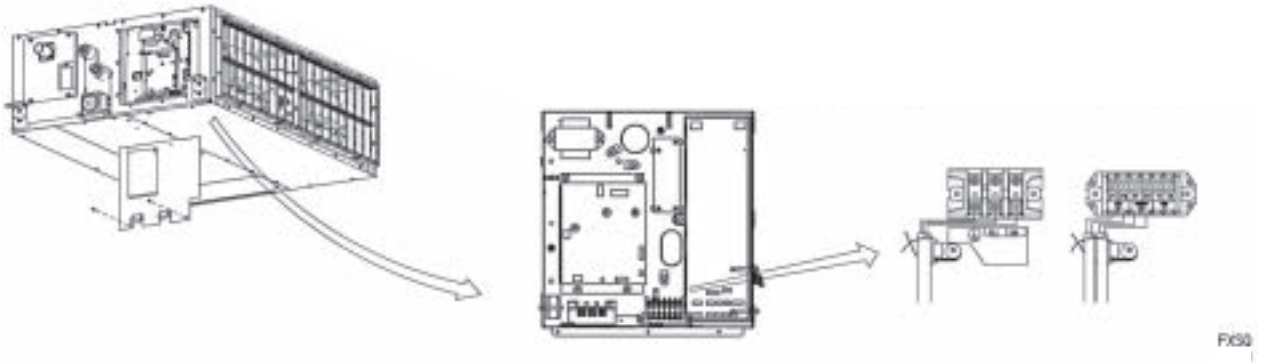

3TW31184-5A



Daikin's unique position as a manufacturer of air conditioning equipment, compressors and refrigerants has led to its close involvement in environmental issues. For several years Daikin has had the intention to become a leader in the provision of products that have limited impact on the environment. This challenge demands the eco design and development of a wide range of products and an energy management system, resulting in energy conservation and a reduction of waste.

VRV® products are not within the scope of the Eurovent certification programme.



The present publication is drawn up by way of information only and does not constitute an offer binding upon Daikin Europe N.V. Daikin Europe N.V. has compiled the content of this publication to the best of its knowledge. No express or implied warranty is given for the completeness, accuracy, reliability or fitness for particular purpose of its content and the products and services presented therein. Specifications are subject to change without prior notice. Daikin Europe N.V. explicitly rejects any liability for any direct or indirect damage, in the broadest sense, arising from or related to the use and/or interpretation of this publication. All content is copyrighted by Daikin Europe N.V.

Daikin products are distributed by: