



Fan Coil Units

Technical Data

Round flow cassette



ECDEN11-400

FWC-BT/BF



Fan Coil Units

Technical Data

Round flow cassette



ECDEN11-400

FWC-BT/BF

FWC-BT/BF

I	Roundflow cassette	
	FWC-BT.....	3
	FWC-BF.....	21

1

2

TABLE OF CONTENTS

FWC-BT

1	Features	4
2	Specifications	5
	Technical Specifications	5
	Electrical Specifications	5
3	Electrical data	6
	Electrical Data	6
4	Safety device settings	7
	Safety Device Settings	7
5	Options	8
	Options	8
6	Capacity tables	10
	Cooling Capacity Tables	10
	Heating Capacity Tables	11
7	Dimensional drawings	12
	Dimensional Drawings	12
	Dimensional Drawings with Accessories	13
8	Centre of gravity	14
	Centre of Gravity	14
9	Piping diagrams	15
	Piping Diagrams	15
10	Sound data	16
	Sound Power Spectrum	16
	Sound Pressure Spectrum	18
11	Hydraulic performance	20
	Water Pressure Drop Curve Evaporator	20

1 Features

- 360° air discharge ensures uniform air flow and temperature distribution
- Modern style decoration panel in white (RAL9010)
- Fresh air intake for healthy living
- Comfortable horizontal air discharge ensures draughtfree operation and prevents ceiling soiling
- Possibility to shut 1 or 2 flaps for easy installation in corners
- Standard drain pump with 850mm lift

1

1



2 Specifications

2-1 Technical Specifications				FWC06BT	FWC07BT	FWC08BT	FWC09BT
Cooling capacity	Total capacity	High	kW	5.8 (1)	6.8 (1)	7.7 (1)	8.7 (1)
		Nom.	kW	5.0 (1)	5.6 (1)	6.3 (1)	7.2 (1)
		Low	kW	4.1 (1)	4.7 (1)	4.9 (1)	5.7 (1)
	Sensible capacity	High	kW	4.1 (1)	4.7 (1)	5.6 (1)	6.5 (1)
		Nom.	kW	3.4 (1)	4.0 (1)	4.5 (1)	5.3 (1)
		Low	kW	2.8 (1)	3.3 (1)	3.5 (1)	4.1 (1)
Heating capacity	2-Pipe	High	kW	8.0 (2)	8.9 (2)	10.6 (2)	12.1 (2)
		Nom.	kW	6.3 (2)	7.1 (2)	8.3 (2)	9.5 (2)
		Low	kW	5.5 (2)	5.9 (2)	6.9 (2)	7.8 (2)
Power input	High		W	45	54	77	107
	Nom.		W	40	46	58	76
	Low		W	34	37	39	45
Dimensions	Unit	Height	mm	288			
		Width	mm	840			
		Depth	mm	840			
Weight	Unit		kg	26			
Heat exchanger	Rows	Quantity		2			
	Fin pitch		mm	1.5			
Water pressure drop	Cooling	kPa		15	19	26	34
	Heating	kPa		15	19	26	34
Fan	Type		Turbo fan				
	Quantity		1				
	Air flow rate	High	m ³ /h	1,062	1,236	1,518	1,776
		Medium	m ³ /h	894	1,038	1,200	1,410
Low		m ³ /h	720	840	888	1,044	
Fan motor	Speed	Steps		3			
	Model		QTS48C15M				
Sound power level	Super high	dBA		46	49	55	59
	High	dBA		42	44	48	53
	Low	dBA		39	40	41	45
Sound pressure level	Super high	dBA		30	34	39	44
	High	dBA		27	30	34	39
	Low	dBA		25	26	27	30

Standard Accessories : O ring;

Standard Accessories : Insulation;

Standard Accessories : Installation guide;

Standard Accessories : Screws;

Standard Accessories : Washer for hanger bracket;

Standard Accessories : Clamp for drain hose;

Standard Accessories : Drain hose;

Standard Accessories : Installation and operation manual;

2-2 Electrical Specifications				FWC06BT	FWC07BT	FWC08BT	FWC09BT
Power supply	Phase		1~				
	Frequency	Hz	50				
	Voltage		V	220-240			

Notes

(1) Cooling: air 27°CDB, 19°CWB; entering water 7°C; leaving water 12°C

(2) Heating: 2 pipe: air 20°CDB; entering water 50°C

(3) Do not let water of less than 5°C or more than 50°/70°C enter the unit, this may damage the unit

(4) Height includes switch box

3 Electrical data

3 - 1 Electrical Data

FWC-BT/BF

Model	Type	Units			Power supply		IFM		Input (W)	
		Hz	Voltage range	Voltage limits	MCA	MFA	kW	FLA	Cooling	Heating
FWC06BT	V1	50	220-240	Max. 264 Min. 198	0.3	16	0.120	0.2	45	45
FWC07BT					0.4	16	0.120	0.3	54	54
FWC08BT					0.6	16	0.120	0.5	77	77
FWC09BT					0.9	16	0.120	0.7	107	107
FWC06BF					0.3	16	0.120	0.2	46	46
FWC07BF					0.4	16	0.120	0.3	55	55
FWC08BF					0.6	16	0.120	0.5	77	77
FWC09BF					0.9	16	0.120	0.7	107	107

SYMBOLS

MCA : Min. Circuit Amps. (A)
MFA : Max. Fuse Amps. (See note 5)
kW : Fan Motor Rated Output (kW)
FLA : Full Load Amps. (A)
IFM : Indoor Fan Motor

NOTES

- Voltage limits:
Units are suitable for use on electrical systems where voltage supplied to unit terminals is not below or above listed range limits.
- Maximum allowable voltage unbalance between phases is 2%
- MCA/MFA:
 $MCA = 1.25 \times FLA$
 $MFA \leq 4 \times FLA$
(Next lower standard fuse rating min. 16A)
- Select wire size based on the MCA
- Instead of fuse, use Circuit Breaker.

4TW33121-2

1

3

4 Safety device settings

4 - 1 Safety Device Settings

FWC-BT/BF		6	7	8	9	
FWC-BT/BF	PC board fuse	250V 5A	250V 5A	250V 5A	250V 5A	
	Fan motor thermal fuse	°C	-	-	-	
	Fan motor thermal protector	°C	OFF: 108 ^{±5} (ON: 96 ^{±15})	OFF: 108 ^{±5} (ON: 96 ^{±15})	OFF: 108 ^{±5} (ON: 96 ^{±15})	OFF: 108 ^{±5} (ON: 96 ^{±15})
	Drain pump fuse	°C	145	145	145	

3TW33129-4

1
4

5 Options

5 - 1 Options

1
5

FWC-BT/BF

Options

	Item	Model	FWC06-09BT/BF
1	Decoration Panel - Standard (RAL 9010 - grey sealings)	Round flow	BYCQ140CW1
2	Decoration Panel - White (RAL 9010 - white sealings)	Round flow	BYCQ140CW1W
3	Sealing member of air discharge outlet		KDBHQ55C140
4	Long-life filter		KAFP551K160
5	Fresh air intake kit (20% fresh air)	Direct installation type	KDDQ55C140

Control systems

	Item	Model	FWC06-09B	
1	Remote control	Infrared	H/P	BRC7F532F (*12)
			C/O	BRC7F533F (*12)
		Wired		BRC315D7 (*1)
2	Central remote control		DCS302CA51 (*2)	
2.1	Electrical box with earth terminal (3 blocks)		KJB311A	
3	Unified on/off control		DCS301BA51 (*4)(*6)	
3.1	Electrical box with earth terminal (2 blocks)		KJB212A	
3.2	Noise filter (for electromagnetic interface use only)		KEK26-1A	
4	Schedule timer		DST301BA51 (*6)(*9)	
5	Wiring adapter for electrical appendices (1)		KRP2A52 (*5)(*9)	
6	Wiring adapter for electrical appendices (2)		KRP4AA53 (*5)(*9)	
7	Installation box for adapter PCB		KRP1H98 (*10)	
8	Remote sensor		KRCS01-4	
10	Intelligent touch controller		DCS601C51C (*3)(*8)	
10.1	Electrical installation box		KJB411A	
11	Optional PCB for MOD-bus connection		EKFCMBCB7 (*5)(*9)	
12	2-way valve - On/Off		EKMV2C09B7 (*5)(*7)(*11)	
13	3-way valve - On/Off		EKMV3C09B7 (*5)(*7)(*11)	
14	Valve control PCB		EKRP1C11	

NOTES

- Optional, electrical installation box with earth terminal KJB212A is required, if controller wires need to be installed in the wall.
- Requires electrical installation box with earth terminal KJB311A.
- Requires electrical installation box KJB411A.
- Requires noise filter (for electromagnetic interface use only) KEK26-1A
- Requires installation box KRP1H98.
- Requires electrical installation box with earth terminal KJB212A, if built in the wall.
- Requires valve control PCB EKRP1C11.
- I-touch:
 - Not allowed to use the i-touch for an installation with both fan coils and VRV units.
 - Can not be used in combination with fan coil units, that use MOD bus communication.
 - No Airmet or telephone connection possible.
- Only 1 of these 4 options can be installed on 1 indoor unit.
- Max. 1 KRP1H98 box can be mounted on the unit. Max. 2 PCB's can be mounted in 1 KRP1H98 box.
- 2-pipe unit: 1 x valve kit + 1 x installation box for PCB KRP1H98 + 1 x valve control PCB EKRP1C11
4-pipe unit: 2 x valve kit + 1 x installation box for PCB KRP1H98 + 1 x valve control PCB EKRP1C 11
- It is possible to change the operation mode, but this will not have an impact on the water temperature .
(No feed back to water source)
It is not possible to select the "auto air flow" setting.
Dry operation can be selected with this remote control, but this function is not available on the FWC model.
- All options are supplied as kit.

3TW33129-1A

5 Options

5 - 1 Options

FWC-BT/BF					
Brief description of purpose of the available options:					
	Item	Model	FWC06-09BT/BF	Description	
1	Decoration Panel - Standard (RAL 9010 - grey sealings)	Round flow	BYCQ140CW1	Decoration panel for the fan coil unit that is built in the false sealing. Mandatory when installing the fan coil unit.	
2	Decoration Panel - White (RAL 9010 - white sealings)	Round flow	BYCQ140CW1W	Decoration panel for the fan coil unit that is built in the false sealing. Mandatory when installing the fan coil unit.	
3	Sealing member of air discharge outlet		KDBHQ55C140	This option can be used in case the fan coil unit is installed close to a wall on one or more sides (closer than 1500 mm). With the blocking parts one or more air outlets of the fan coil unit can be closed --> Fan coil unit can be installed closer to a wall (but further then 200mm).	
4	Long-life filter		KAFP551K160	High quality filter that can be used if supplied filter is damaged.	
5	Fresh air intake kit (20% fresh air)		KDDQ55C140	Kit that can be connected to the ventilation system to supply fresh air to the fan coil unit.	
6	Remote control	Infrared	H/P	BRC7E532F	Infrared remote control to control each fan coil unit independently with cooling and heating functionality. It's not possible to select auto air flow with this remote control. Also there is no feedback regarding the operation mode to the "water supply unit". --> Changing the operation mode will not have an effect on the supplied water temperature. Dry operation can be selected, but the FWF unit does not have this function.
			C/O	BRC7E533F	Infrared remote control to control each fan coil unit independently with cooling functionality. It's not possible to select auto air flow with this remote control. Also there is no feedback regarding the operation mode to the water supply unit. --> Changing the operation mode will not have an effect on the supplied water temperature. Dry operation can be selected, but the FWF unit does not have this function.
		Wired	BRC315D7	Wired remote control to control each fan coil unit independently with cooling and heating functionality. There is no weekly timer function in this remote control. Only a limited on/off timer function is available. In case wires need to be installed inside the wall, the KJB212A installation box is required.	
7	Central remote control		DCS302CA51	Remote control for centralized control of all connected fan coil units (only FWF and FWC type).	
7.1	Electrical box with earth terminal (3 blocks)		KJB311A	Requires the KJB311A electrical installation box for the installation.	
8	Unified on/off control		DCS301BA51	Remote control to switch all connected fan coil units (only FWC and FWF type) ON or OFF.	
8.1	Electrical box with earth terminal (2 blocks)		KJB212A	In case unified on/off controller is built in the wall, the electrical box KJB212A kit is required.	
8.2	Noise filter (for electromagnetic interface use only)		KEK26-1A	For compliance reasons, the noise filter KEK26-1A is required in case a unified on/off controller is installed.	
9	Schedule timer		DST301BA51	Controller with schedule timer functionality for the fan coil units (only FWC and FWF). It's not possible to combine this option with neither KRP2A52 nor KRP4AA53 nor EKFCMBCB7 on the same fan coil unit. In case the schedule timer is built in the wall, the electrical box KJB212A is required.	
10	Intelligent touch control		DCS601C51C	Advanced remote control for centralized control of all connected fan coil units (but only FWF and FWC type and up to 128 fan coil units). More functions are possible than with the central remote control. Compared to VRV systems, it's not possible to use AIRNET and telephone connection. The I-touch can not be used for installations with both DX units and fan coil units. The I-touch can not be used for installations with fan coil units that use Mod Bus communication.	
10.1	Electrical installation box		KJB411A	Electrical installation box KJB411A is needed for the installation of the I-touch remote control.	
11	Remote sensor		KRCS01-1	Sensor to measure the room temperature remotely from a location other than the fan coil unit or the remote control.	
12	2-way valve - On/Off		EKMV2C09B7	2-way valve to control the water supply to the fan coil unit. The option kit EKRP1C11 is needed to control the valve.	
13	3-way valve - On/Off		EKMV3C09B7	3-way valve to control the water supply to the fan coil unit. The option kit EKRP1C11 is needed to control the valve.	
14	Valve control PCB		EKRP1C11	PCB to control the 2-way and 3 way valves. Only 1 option kit is needed per fan coil unit. It is possible to connect 2 valves on 1 PCB. For the installation of the PCB, the installation box KRP1H98 is required.	
15	Optional PCB for MOD-bus connection		EKFCMBCB7	PCB to transform the Dill communication of the FWC and FWF fan coil units to Mod Bus communication. For the installation of the PCB, the installation box KRP1 H98 is required. It's not possible to combine this option with KRP2A52 or KRP4AA53 or DST301BA51 on the same fan coil unit.	
16	Wiring adapter for electrical appendices (1)		KRP2A52	PCB with additional connection for external input/output signals. For the installation of the PCB, the installation box KRP1 H98 is required. It's not possible to combine this option with KRP4AA53 or EKFCMBCB7 or DST301 BA51 on the same fan coil unit. Example of input signals: set point, on/off contact. Example of outputs: error stats of fan coil unit, operation status of fan coil unit (on/off). This PCB can control all FWC and FWF fan coil units connected on the same F1/F2 communication wire.	
17	Wiring adapter for electrical appendices (2)		KRP4AA53	PCB with additional connection for external input/output signals. For the installation of the PCB, the installation box KRP1H98 is required. It's not possible to combine this option with KRP2A52 or EKFCMBCB7 or DST301BA51 on the same fan coil unit. Example of input signals: set point, on/off contact. Example of outputs: error stats of fan coil unit, operation status of fan coil unit (on/off). This PCB can control only FWC and FWF fan coil units connected on the same P1/P2 remote control communication wire.	
18	Installation box for adapter PCB		KRP1H98	Installation box for some option kits. Max. 1 box can be installed on a single FWC unit. 2 PCB's can be installed in 1 box.	

3TW33129-2

6 Capacity tables

6 - 1 Cooling Capacity Tables

1
6

FWC-BT		22-16															
Air temperature (°CDB -°CWB)		6-11				7-12				6-13				9-14			
Water temperature (Entering °C - Leaving °C)		Total cooling capacity (kW)	Sensible cooling capacity (kW)	Water flow (l/min)	Water pressure drop (kPa)	Total cooling capacity (kW)	Sensible cooling capacity (kW)	Water flow (l/min)	Water pressure drop (kPa)	Total cooling capacity (kW)	Sensible cooling capacity (kW)	Water flow (l/min)	Water pressure drop (kPa)	Total cooling capacity (kW)	Sensible cooling capacity (kW)	Water flow (l/min)	Water pressure drop (kPa)
FWC06BT	HH	3.9	2.9	11.3	8	3.3	2.6	9.7	6	2.7	2.3	8.6	5	2.1	2.0	7.7	5
	H	3.4	2.4	10.0	7	2.9	2.2	8.5	5	2.4	2.0	8.0	5	1.9	1.7	7.1	5
	L	2.8	2.0	8.1	5	2.4	1.9	7.8	5	2.0	1.7	7.0	5	1.7	1.5	6.6	5
FWC07BT	HH	4.8	3.4	14.0	11	4.1	3.1	11.7	8	3.3	2.7	10.3	7	2.5	2.4	8.7	5
	H	3.8	2.8	11.0	8	3.2	2.6	9.4	6	2.6	2.2	8.3	5	2.0	1.9	7.3	5
	L	3.2	2.4	9.4	6	2.7	2.2	8.1	5	2.3	2.0	7.4	4	1.8	1.7	6.3	5
FWC08BT	HH	5.1	3.8	14.5	12	4.3	3.5	12.5	9	3.4	2.9	10.9	7	2.6	2.4	9.5	6
	H	4.4	3.2	12.7	10	3.8	2.9	11.0	8	2.8	2.4	9.2	6	2.2	2.1	8.2	5
	L	3.4	2.5	9.7	6	2.9	2.3	8.5	5	2.4	2.1	7.8	5	2.0	1.8	6.8	5
FWC09BT	HH	5.7	4.4	16.5	15	4.8	3.8	13.7	11	4.0	3.4	12	9	2.9	2.8	11.0	8
	H	5.0	3.8	14.4	12	4.2	3.4	12.3	9	3.3	2.8	10.2	7	2.4	2.3	9.4	6
	L	4.0	3.0	11.7	8	3.4	2.7	10.0	7	2.7	2.3	8.5	5	2.1	2.0	6.3	5

FWC-BT		25-18															
Air temperature (°CDB -°CWB)		6-11				7-12				6-13				9-14			
Water temperature (Entering °C - Leaving °C)		Total cooling capacity (kW)	Sensible cooling capacity (kW)	Water flow (l/min)	Water pressure drop (kPa)	Total cooling capacity (kW)	Sensible cooling capacity (kW)	Water flow (l/min)	Water pressure drop (kPa)	Total cooling capacity (kW)	Sensible cooling capacity (kW)	Water flow (l/min)	Water pressure drop (kPa)	Total cooling capacity (kW)	Sensible cooling capacity (kW)	Water flow (l/min)	Water pressure drop (kPa)
FWC06BT	HH	5.5	3.8	15.8	14	5.0	3.6	14.5	12	4.3	3.2	12.5	9	3.6	2.9	10.5	7
	H	4.8	3.1	13.6	11	4.3	2.9	12.5	9	3.8	2.7	11.0	8	3.3	2.5	9.5	6
	L	3.9	2.6	11.2	8	3.6	2.4	10.3	7	3.1	2.2	8.8	5	2.6	2.1	7.8	5
FWC07BT	HH	6.6	4.4	19.0	19	5.9	4.1	17.0	15	5.2	3.8	15.5	13	4.4	3.4	12.5	9
	H	5.3	3.7	15.5	13	4.9	3.4	13.8	11	4.2	3.2	12.0	9	3.7	2.9	10.4	7
	L	4.4	3.0	12.6	9	4.0	2.8	11.5	8	3.5	2.6	10.0	7	2.9	2.4	8.7	5
FWC08BT	HH	7.3	5.1	21.0	22	6.6	4.8	19.0	19	5.8	4.3	16.5	15	4.6	3.8	13.2	10
	H	6.0	4.2	17.4	16	5.4	3.9	15.5	13	4.7	3.5	13.5	11	4.1	3.2	14.6	8
	L	4.7	3.2	13.5	11	4.3	3.0	12.4	9	3.8	2.8	11.0	8	3.1	2.6	9.0	6
FWC09BT	HH	8.0	5.9	23.0	26	7.2	5.5	21.0	22	6.3	4.9	18.0	17	5.0	4.0	14.2	11
	H	6.9	4.9	20.0	20	6.2	4.6	17.9	17	5.5	4.2	15.5	13	4.6	3.8	13.0	10
	L	5.4	3.8	15.6	13	5.0	3.6	14.3	12	4.4	3.3	12.5	9	3.7	3.0	10.5	7

NOTES

1. The capacity is only guaranteed at the nominal conditions

3TW33162-2

FWC-BT		27-19															
Air temperature (°CDB -°CWB)		6-11				7-12				6-13				9-14			
Water temperature (Entering °C - Leaving °C)		Total cooling capacity (kW)	Sensible cooling capacity (kW)	Water flow (l/min)	Water pressure drop (kPa)	Total cooling capacity (kW)	Sensible cooling capacity (kW)	Water flow (l/min)	Water pressure drop (kPa)	Total cooling capacity (kW)	Sensible cooling capacity (kW)	Water flow (l/min)	Water pressure drop (kPa)	Total cooling capacity (kW)	Sensible cooling capacity (kW)	Water flow (l/min)	Water pressure drop (kPa)
FWC06BT	HH	6.3	4.3	18.0	17	5.8	4.1	17.2	15	5.3	3.9	15.2	13	4.5	3.5	13.0	10
	H	5.5	3.6	15.8	14	5.0	3.4	14.2	11	4.5	3.2	13.0	10	4.0	2.9	11.5	8
	L	4.5	3.0	12.8	10	4.1	2.8	11.8	8	3.8	2.6	10.8	7	3.2	2.4	9.2	6
FWC07BT	HH	7.5	5.0	21.5	23	6.8	4.7	19.0	19	6.3	4.5	18.0	17	5.5	4.1	16.0	14
	H	6.1	4.2	17.5	15	5.6	4.0	16.2	14	5.1	3.7	14.7	12	4.4	3.4	12.8	10
	L	5.1	3.5	14.5	12	4.7	3.3	13.5	11	4.2	3.1	12.0	9	3.6	2.8	10.2	7
FWC08BT	HH	8.3	5.9	24.0	28	7.7	5.6	23.0	26	7.0	5.2	20.2	21	6.0	4.7	17.5	16
	H	7.0	4.8	20.0	20	6.3	4.5	18.0	17	5.8	4.2	16.5	15	5.0	3.8	14.5	12
	L	5.4	3.7	15.5	13	4.9	3.5	14.0	11	4.5	3.3	13.0	10	3.9	3.0	11.0	8
FWC09BT	HH	9.3	6.7	26.5	34	8.7	6.5	27.2	34	7.7	6.0	22.0	24	6.5	5.3	18.5	18
	H	7.9	5.6	22.5	25	7.2	5.3	20.5	21	6.6	5.0	19.0	19	5.7	4.5	16.5	15
	L	6.2	4.3	17.8	17	5.7	4.1	16.5	15	5.3	3.9	15.0	13	4.6	3.5	13.0	10

FWC-BT		30-32															
Air temperature (°CDB -°CWB)		6-11				7-12				6-13				9-14			
Water temperature (Entering °C - Leaving °C)		Total cooling capacity (kW)	Sensible cooling capacity (kW)	Water flow (l/min)	Water pressure drop (kPa)	Total cooling capacity (kW)	Sensible cooling capacity (kW)	Water flow (l/min)	Water pressure drop (kPa)	Total cooling capacity (kW)	Sensible cooling capacity (kW)	Water flow (l/min)	Water pressure drop (kPa)	Total cooling capacity (kW)	Sensible cooling capacity (kW)	Water flow (l/min)	Water pressure drop (kPa)
FWC06BT	HH	8.9	5.1	25.5	31	8.4	4.8	24.0	28	7.7	4.6	22.0	24	7.2	4.4	20.5	21
	H	7.7	4.2	22.0	24	7.3	4.0	21.0	22	6.8	3.8	19.5	20	6.3	3.6	18.0	17
	L	6.3	3.5	18.0	17	5.9	3.3	17.0	15	5.5	3.2	15.8	14	5.1	3.0	14.5	12
FWC07BT	HH	10.6	5.9	30.5	43	10.0	5.6	28.5	38	9.3	5.3	26.5	34	8.6	5.1	24.5	29
	H	8.7	5.0	25.0	30	8.1	4.7	23.5	27	7.5	4.5	21.5	23	7.0	4.3	20.0	20
	L	7.1	4.1	20.5	21	6.7	3.9	19.0	19	6.2	3.7	18.0	17	5.7	3.5	16.5	15
FWC08BT	HH	11.9	6.9	34.0	53	11.1	6.6	32	47	10.3	6.2	29.5	41	9.5	5.9	27.5	36
	H	9.8	5.6	28.0	37	9.2	5.3	26.5	34	8.6	5.1	24.5	29	7.9	4.8	22.5	25
	L	7.6	4.4	22.0	24	7.2	4.2	20.5	21	6.7	4.0	19.0	19	6.1	3.7	17.5	16
FWC09BT	HH	13.2	7.9	37.5	64	12.3	7.5	35.0	56	11.5	7.2	33.0	50	10.6	6.8	30.5	43
	H	11.3	6.6	32.0	47	10.6	6.3	30.0	42	9.8	6.0	28.0	37	9.1	5.7	26.0	33
	L	8.8	5.1	25.5	31	8.3	4.9	23.5	27	7.7	4.6	22.0	24	7.1	4.4	20.5	21

NOTES

1. The capacity is only guaranteed at the nominal conditions

3TW33162-2

6 Capacity tables

6 - 2 Heating Capacity Tables

FWC-BT

Air temperature (°CDB)		20		
Water temperature (Entering °C)		50		
Model	Airflow	Heating capacity (kW)	Water flow (l/min)	Water pressure drop (kPa)
FWC06BT	HH	8.0	17.2	15
	H	6.3	14.2	11
	L	5.5	11.8	8
FWC07BT	HH	8.9	19.0	19
	H	7.1	16.2	14
	L	5.9	13.5	11
FWC08BT	HH	10.6	23.0	26
	H	8.3	18.0	17
	L	6.9	14.0	11
FWC09BT	HH	12.1	27.2	34
	H	9.5	20.5	21
	L	7.8	16.5	15

Air temperature (°CDB)		20		
Water temperature (Entering °C)		50		
Model	Airflow	Heating capacity (kW)	Water flow (l/min)	Water pressure drop (kPa)
FWC06BT	HH	7.4	17.2	15
	H	5.8	14.2	11
	L	5.1	11.8	8
FWC07BT	HH	8.3	19.0	19
	H	6.6	16.2	14
	L	5.5	13.5	11
FWC08BT	HH	9.8	23.0	26
	H	7.7	18.0	17
	L	6.4	14.0	11
FWC09BT	HH	11.2	27.2	34
	H	8.8	20.5	21
	L	7.2	16.5	15

3TW33162-1

NOTE

- The water flow is the same as for cooling mode in the nominal point. Delta T is not fixed.

7 Dimensional drawings

7 - 1 Dimensional Drawings

FWC06-09BT/BF

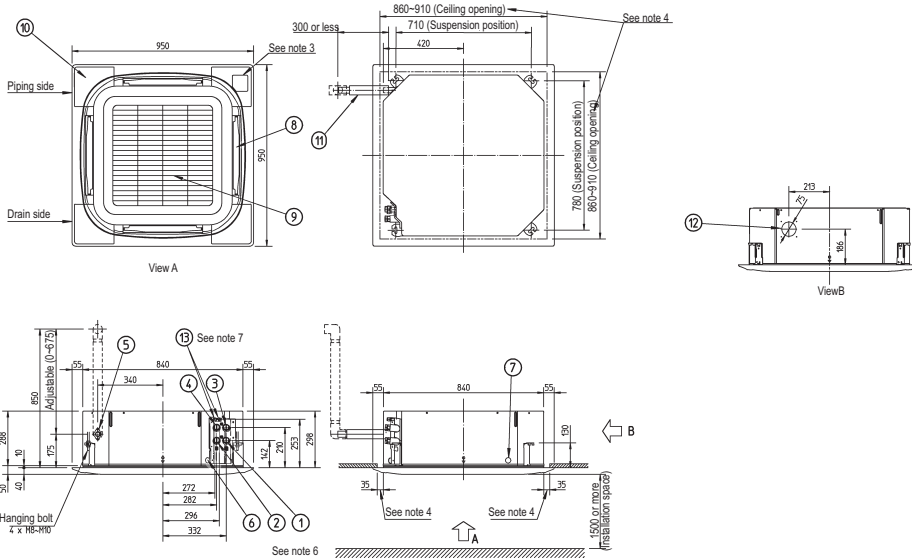

NOTES

- Location of the nameplates:
 - Unit body: on the control box cover.
 - Decoration panel: on the panel frame at the motor side under the corner cover
- When installing an optional accessory, refer to the installation drawings.
 - For the fresh air intake kit an inspection part is necessary
- In case of using an infrared remote control, this position will be a signal receiver. Refer to the drawing of the infrared remote control for more detail.
- Make sure the spacing between the ceiling and the cassette is no more than 35mm. Max. ceiling opening: 910 mm.
- When the conditions exceed 30°C and RH 80% in the ceiling or fresh air is inducted into the ceiling, an additional insulation is required (polythylene foam, thickness 10mm or more)
- Only models FWC06-09BFV1B have heating pipe connections item 3 and item 4. For models FWC06-09BTW1B water pipe connections, item 1 and item 2, are used for heating and cooling.
- Models FWC06 = 09BTV1B have only one air purge (they have no separate heating circuit).
- Please respect the distances as shown on figure below:

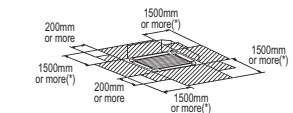
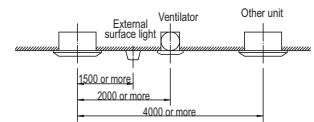

(*) In case a discharge opening is closed with the 'sealing member' option, the distance of 1500mm can be reduced to 500mm on the closed side.

Item	Name	Description
1	Water pipe connection cooling in	3/4" BSP female
2	Water pipe connection cooling out	3/4" BSP female
3	Water pipe connection heating in	3/4" BSP female
4	Water pipe connection heating out	3/4" BSP female
5	Drain pipe connection	3/4" BSP female
6	Power supply entry hole	VP25 (O.D. ø32, I.D. ø25)
7	Transmission wiring entry hole	
8	Air discharge opening	
9	Air suction grille	
10	Corner decoration cover	
11	Drain hose	O.D. ø32, I.D. ø26
12	Knock out hole	
13	Air purge	

3TW33124-1

FWC06-09BT/BF

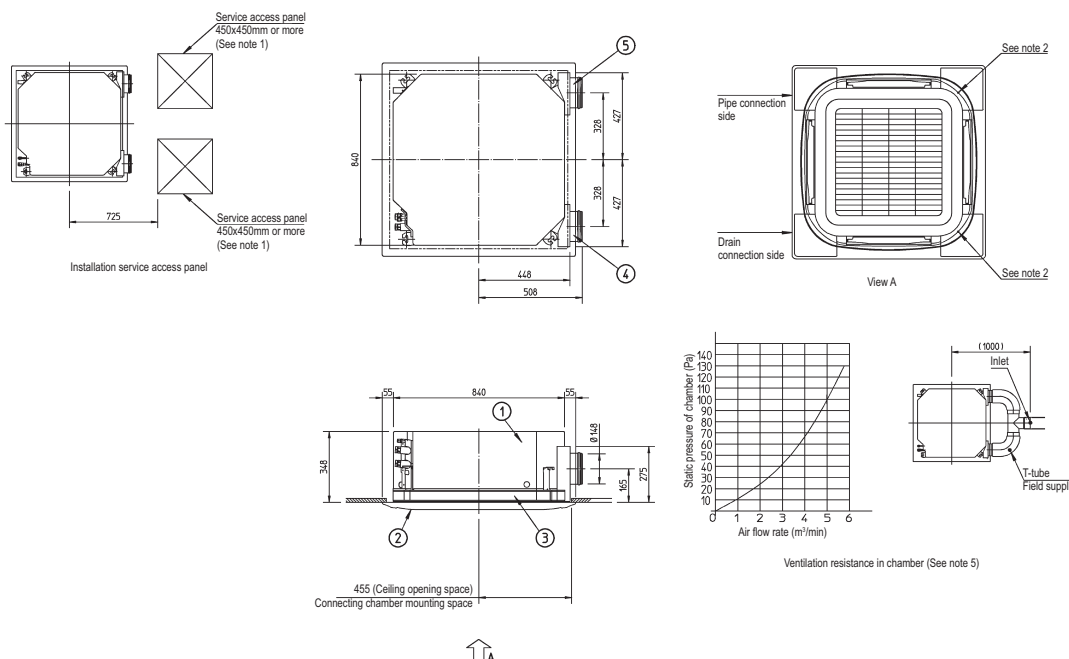

3TW33124-2

Item	Name	Remark
1	Indoor unit	-
2	Decoration panel	-
3	Suction chamber	-
4	Connecting chamber (right)	-
5	Connecting chamber (left)	-

NOTES

- When installing this kit, inspection hatch is necessary. (It is necessary for servicing) Either one of inspection hatches must be installed.
- The corner air outlet of this part must be shut.
- In case of mounting a duct fan, make sure to use a wiring adapter for electrical appendices and link with the indoor unit fan.
- The intake air flow rate is recommended to be 20% or less of the H speed air flow rate. If the intake air flow rate is too large, the operating sound may rise or detection of the indoor unit suction temperature may be affected.
- This indicates the distance between the T-tube inlet and the indoor unit inlet, when the T-tube is connected.

7 Dimensional drawings

7 - 2 Dimensional Drawings with Accessories

FWC-BT/BF

• Remote control dimensions

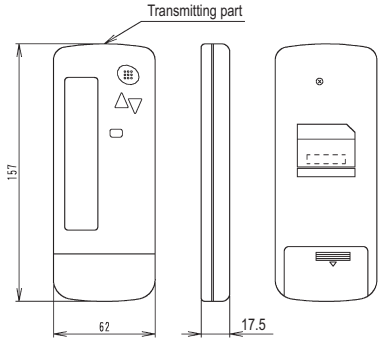

Transmitting part

157

62

17.5

• Remote control holder installation procedure (Installation to wall surface)

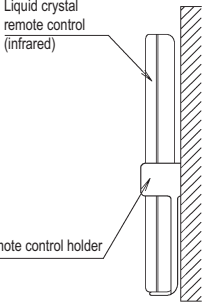

Liquid crystal remote control (infrared)

Remote control holder

• Receiver installation procedure

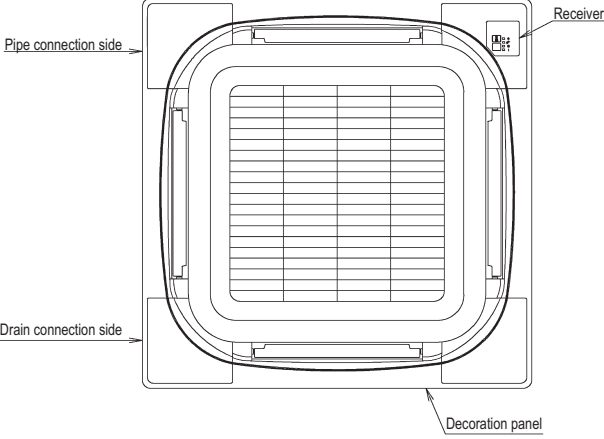

Pipe connection side

Receiver

Drain connection side

Decoration panel

• Receiver detail

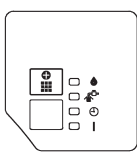

• Infrared remote control kit for each decoration panel

Infrared remote control kit	Decoration panel
BRC7F532F / BRC7F533F	BYCQ140CW1

3D056851

8 Centre of gravity

8 - 1 Centre of Gravity

FWC-BT/BF

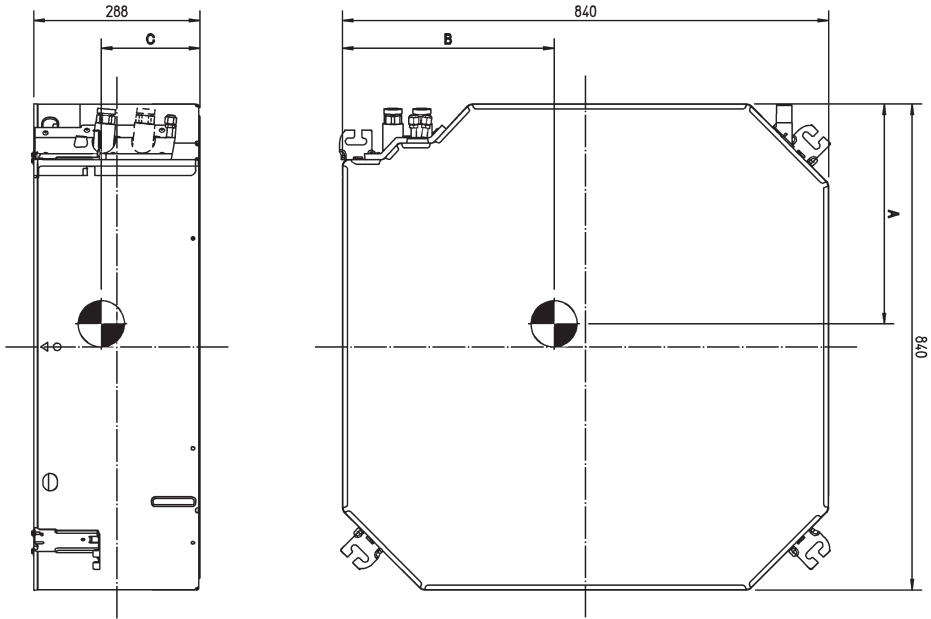

Model	A	B	C
FWC06-09BT	412	404	167
FWC06-09BF	420	406	189

4TW33124-3

1
8

9 Piping diagrams

9 - 1 Piping Diagrams

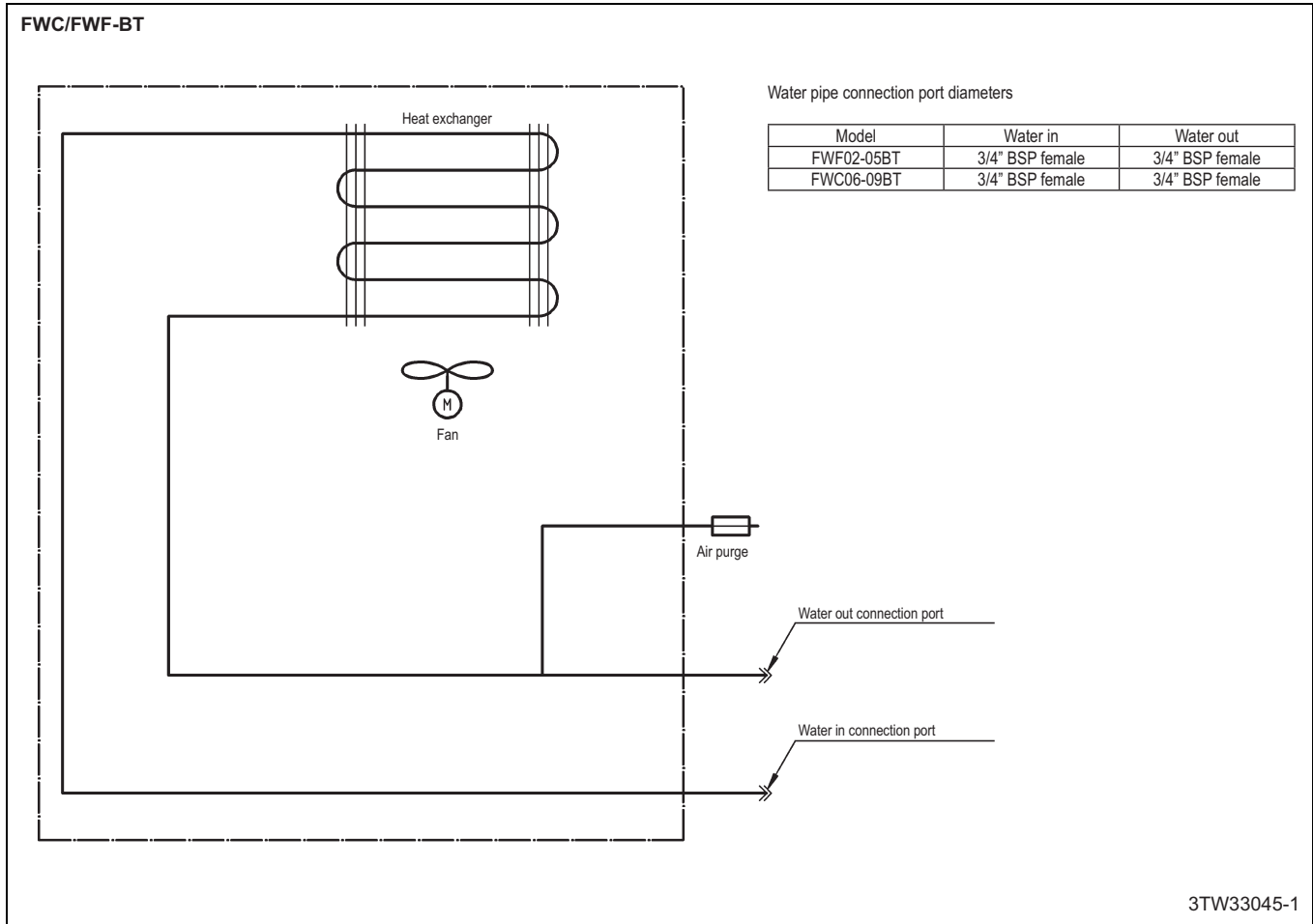

10 Sound data

10 - 1 Sound Power Spectrum

1
10

FWC06BT

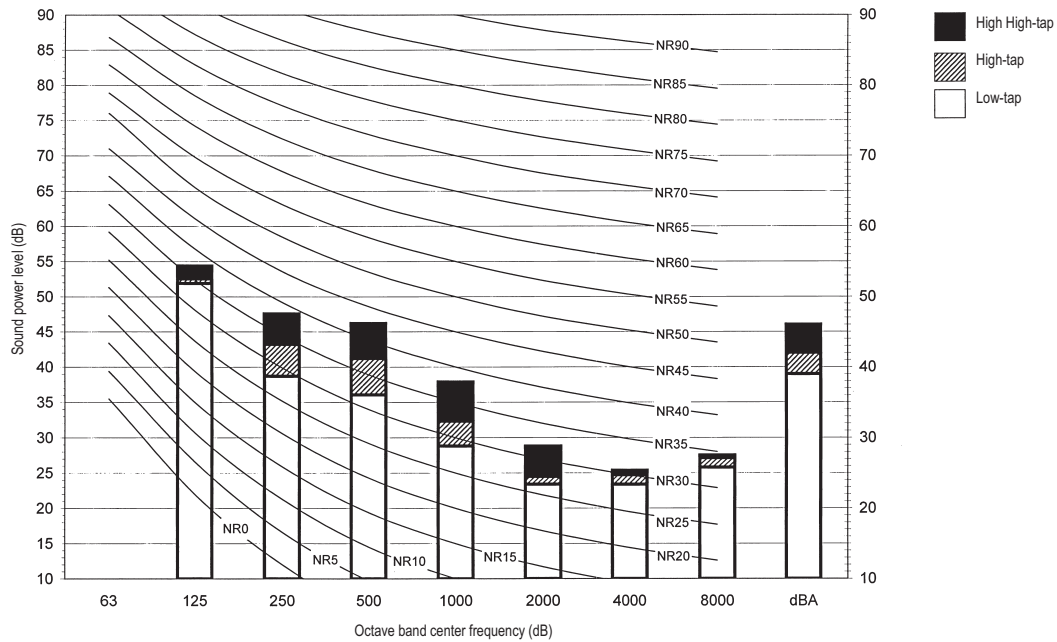

3TW33167-1

NOTES

1. dBA = A-weighted sound power level. (A-scale according to IEC)
2. Reference acoustic intensity $0\text{dB} = 10\text{E-}6\mu\text{W/m}^2$
3. Measured according to ISO 3744

FWC07BT

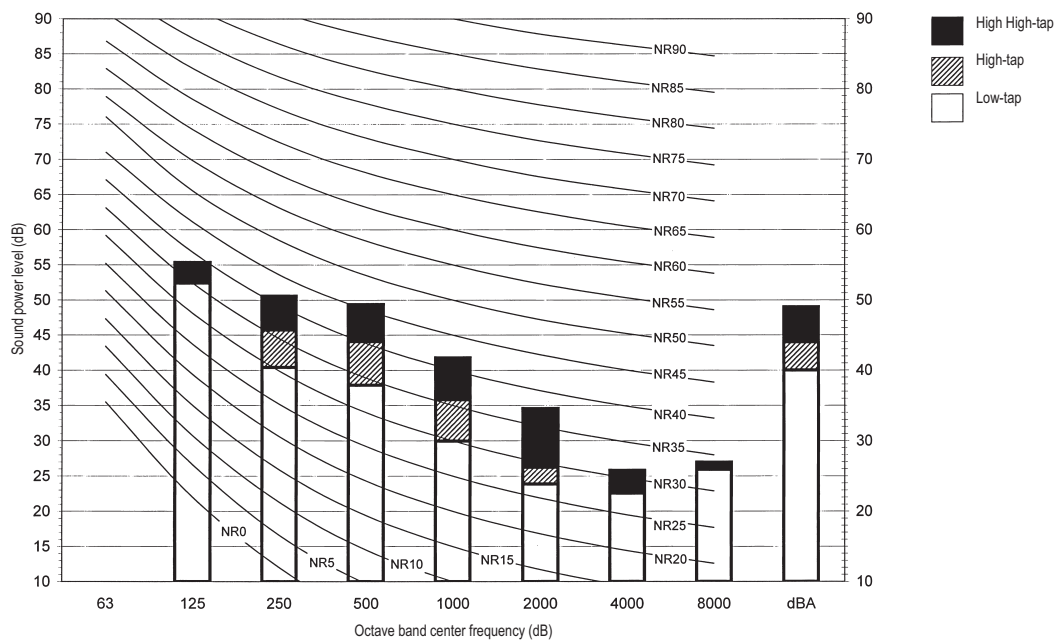

3TW33177-1

NOTES

1. dBA = A-weighted sound power level. (A-scale according to IEC)
2. Reference acoustic intensity $0\text{dB} = 10\text{E-}6\mu\text{W/m}^2$
3. Measured according to ISO 3744

10 Sound data

10 - 1 Sound Power Spectrum

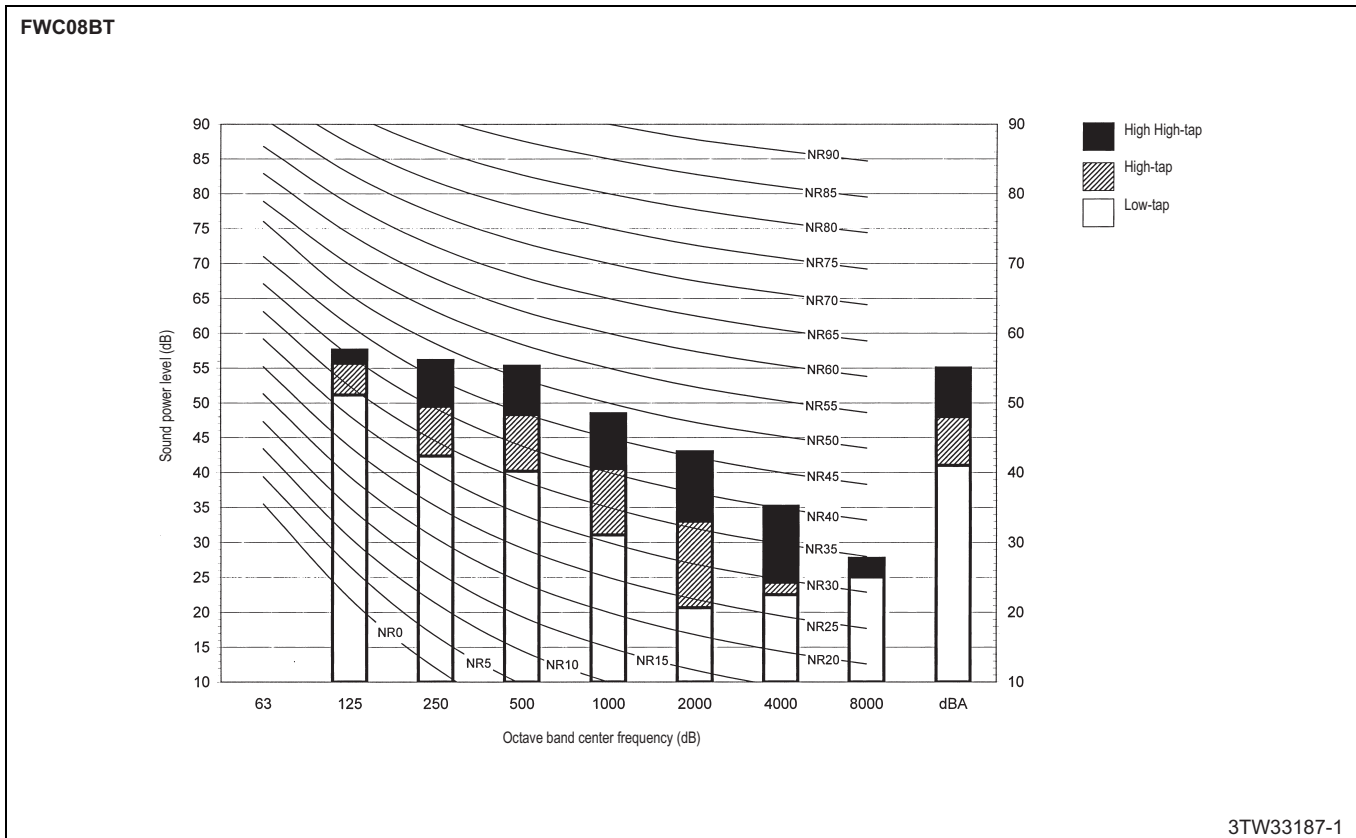

NOTES

1. dBA = A-weighted sound power level. (A-scale according to IEC)
2. Reference acoustic intensity $0\text{dB} = 10\text{E-}6\mu\text{W/m}^2$
3. Measured according to ISO 3744

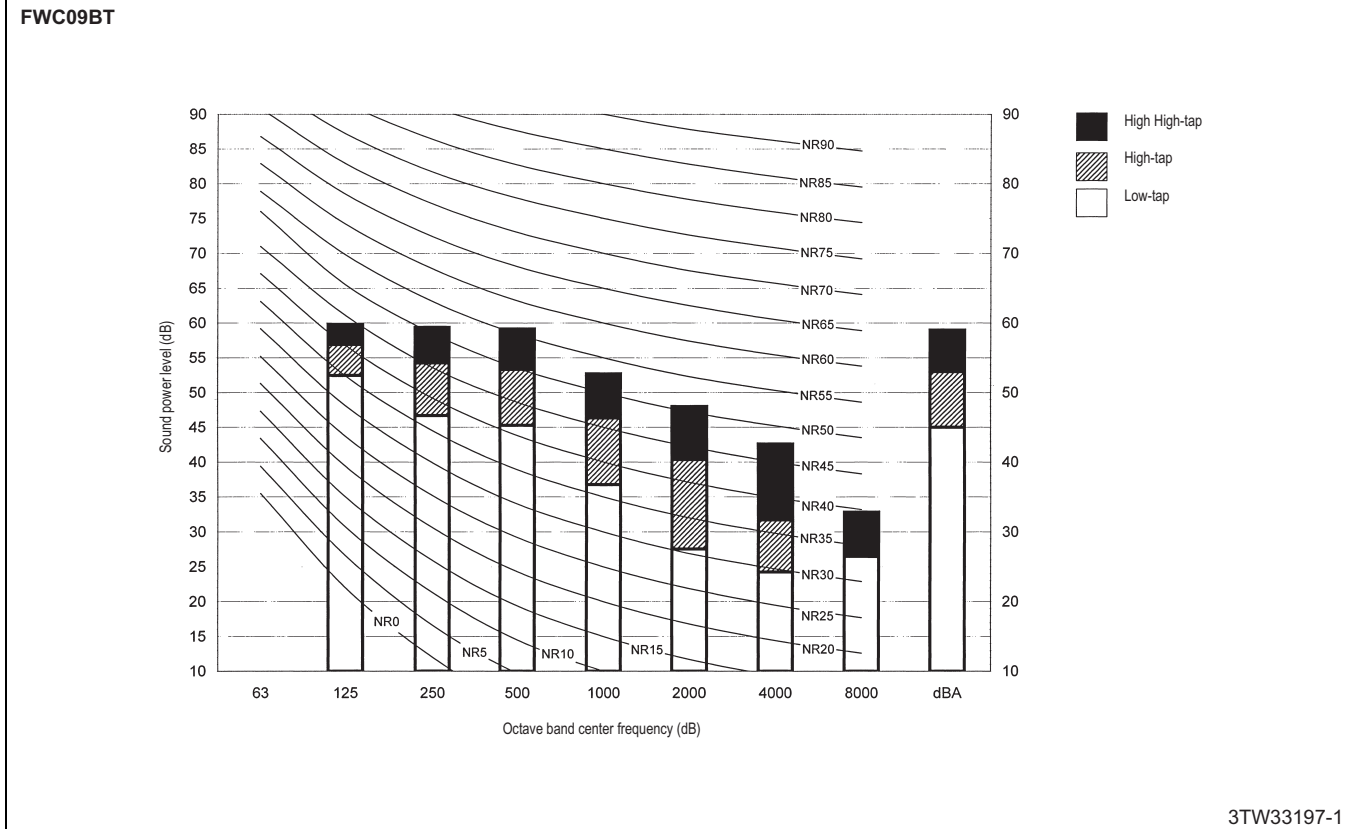

NOTES

1. dBA = A-weighted sound power level. (A-scale according to IEC)
2. Reference acoustic intensity $0\text{dB} = 10\text{E-}6\mu\text{W/m}^2$
3. Measured according to ISO 3744

10 Sound data

10 - 2 Sound Pressure Spectrum

1
10

FWC06BT

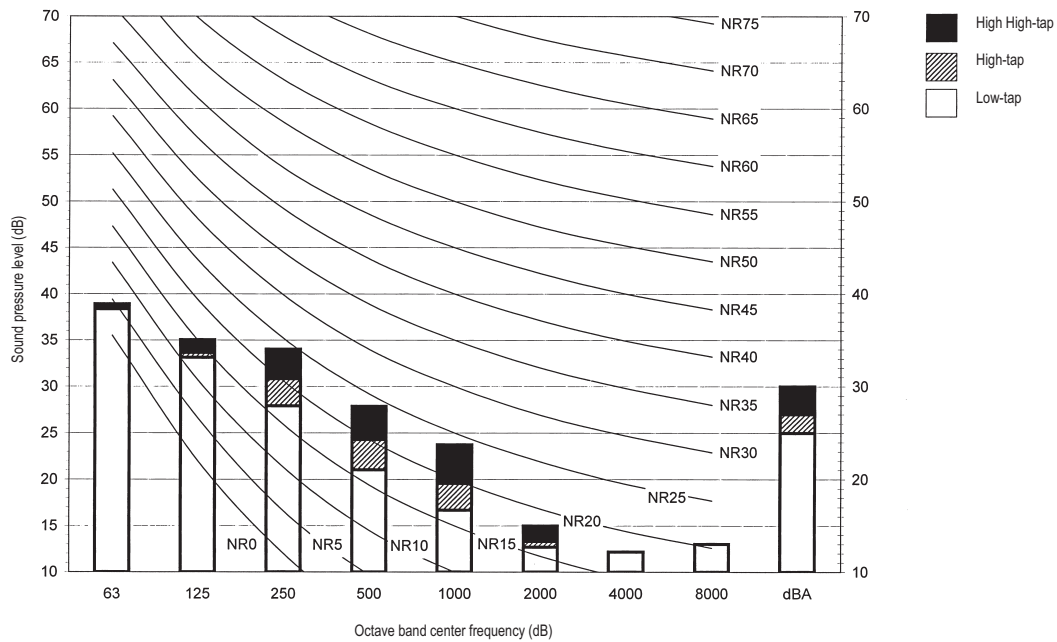

3TW33167-2

NOTES

1. Data is valid at free field condition
2. Data is valid at nominal operation condition
3. dBA =A-weighted sound pressure level. (A-scale according to IEC)
4. Reference acoustic pressures 0dB =20μPa

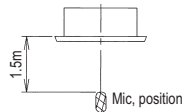

FWC07BT

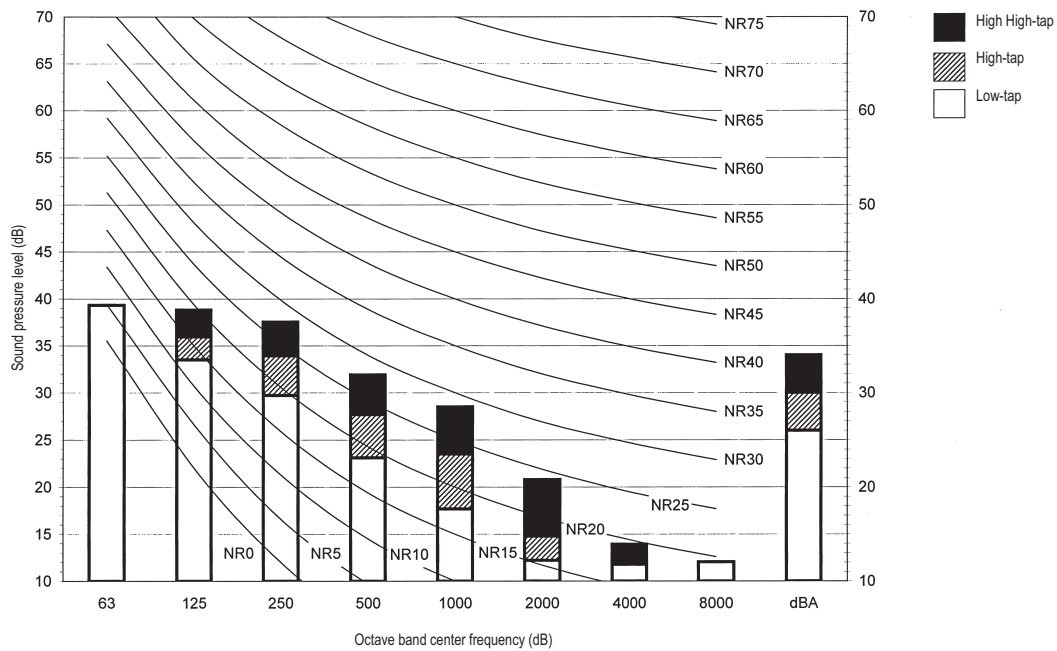

3TW33177-2

NOTES

1. Data is valid at free field condition
2. Data is valid at nominal operation condition
3. dBA =A-weighted sound pressure level. (A-scale according to IEC)
4. Reference acoustic pressures 0dB =20μPa

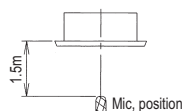

10 Sound data

10 - 2 Sound Pressure Spectrum

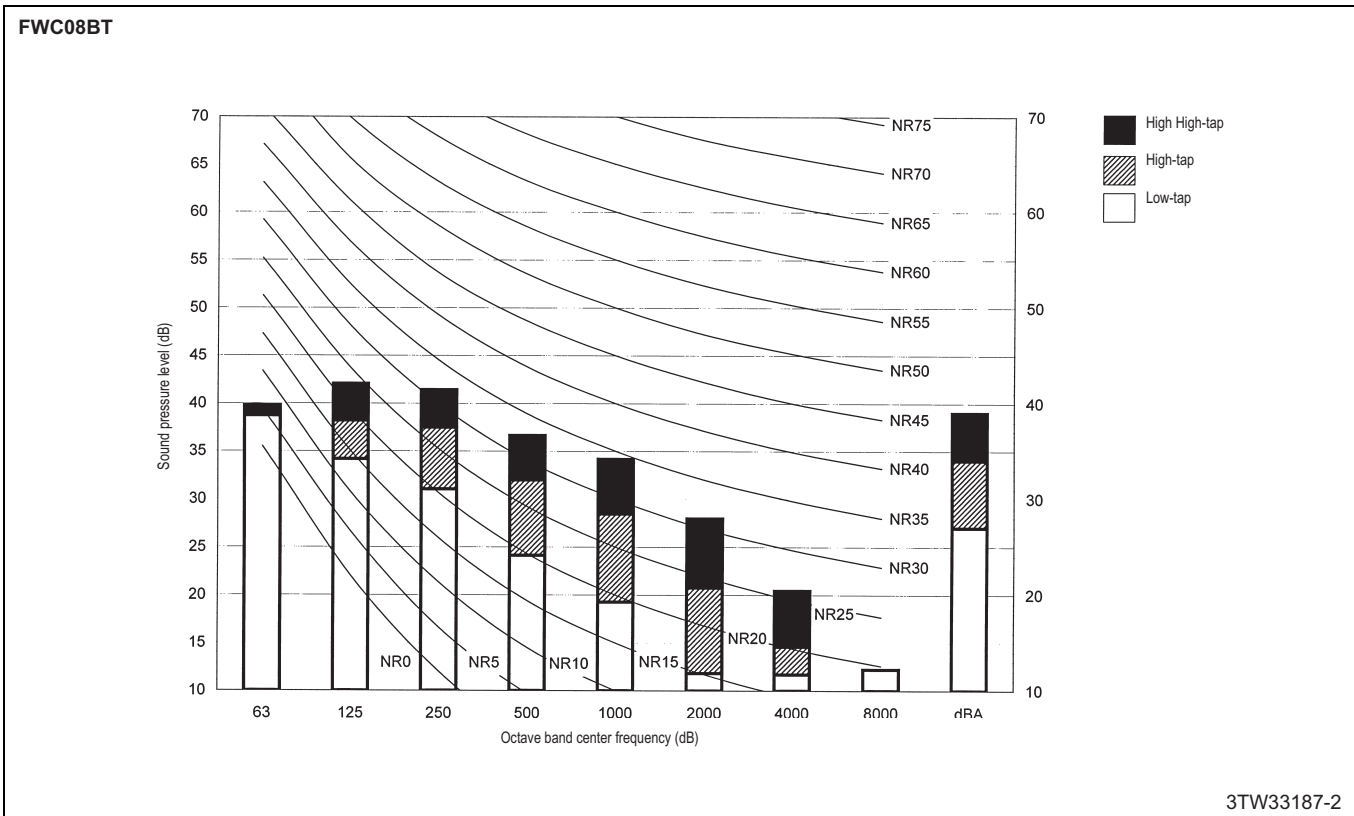

NOTES

1. Data is valid at free field condition
2. Data is valid at nominal operation condition
3. dBA =A-weighted sound pressure level. (A-scale according to IEC)
4. Reference acoustic pressures 0dB =20μPa

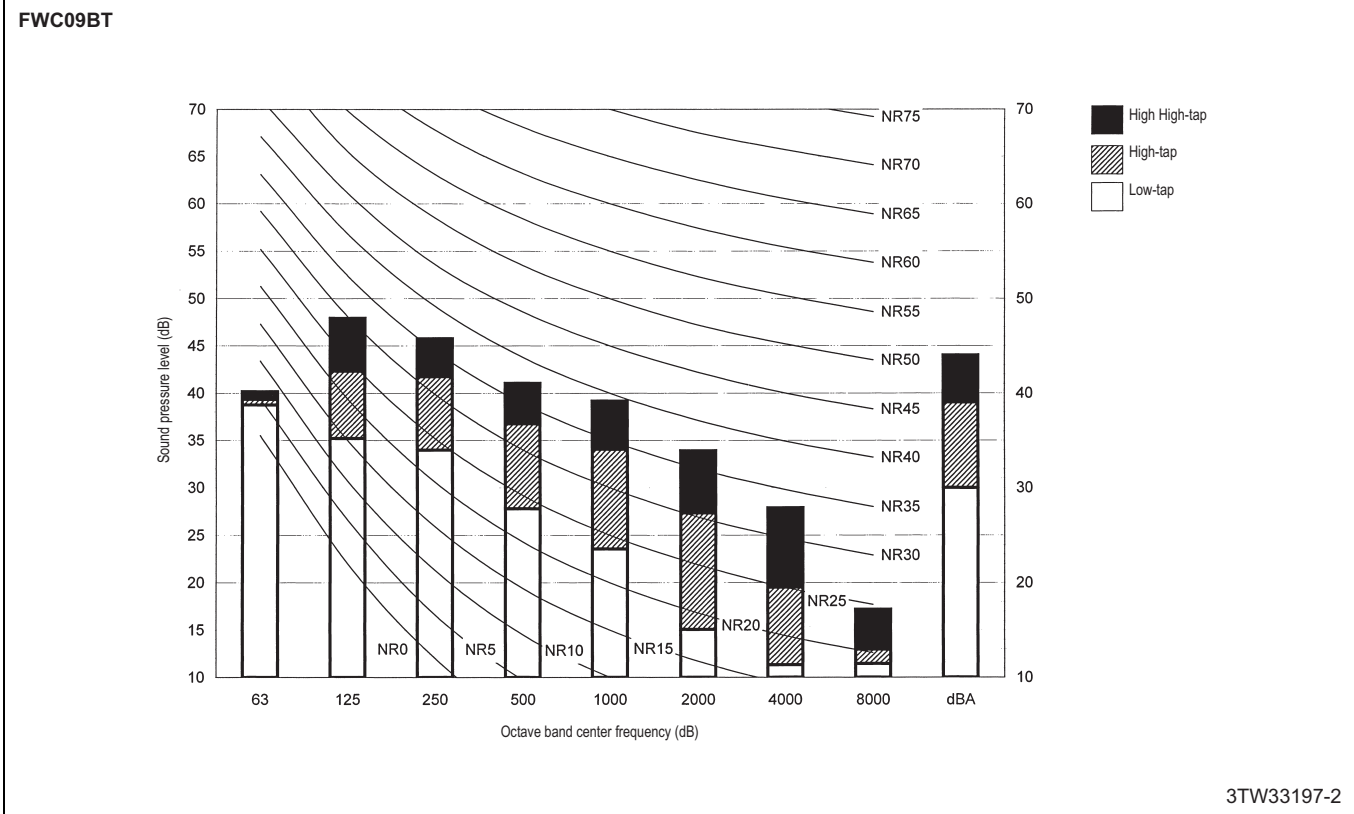
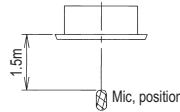

NOTES

1. Data is valid at free field condition
2. Data is valid at nominal operation condition
3. dBA =A-weighted sound pressure level. (A-scale according to IEC)
4. Reference acoustic pressures 0dB =20μPa

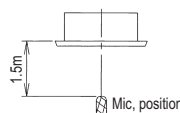

11 Hydraulic performance

11 - 1 Water Pressure Drop Curve Evaporator

FWC06-09BT

Pressure drop over FWC06-09B7TV1B

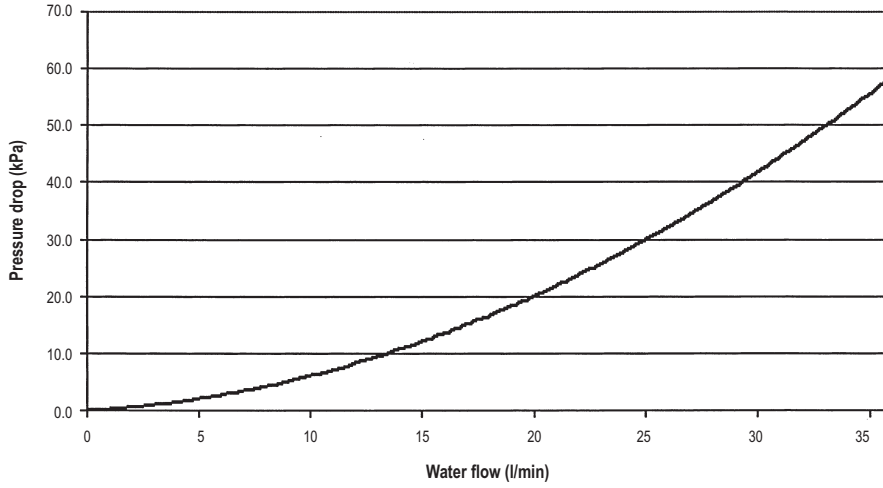

4TW33169-5

NOTES

1. This graph can be used to calculate the pressure drop over the fan coil unit. The pressure drop over the valve is not included.

TABLE OF CONTENTS

FWC-BF

1	Features	24
2	Specifications	25
	Technical Specifications	25
	Electrical Specifications	25
3	Electrical data	26
	Electrical Data	26
4	Safety device settings	27
	Safety Device Settings	27
5	Options	28
	Options	28
6	Capacity tables	30
	Cooling Capacity Tables	30
	Heating Capacity Tables	31
7	Dimensional drawings	32
	Dimensional Drawings	32
	Dimensional Drawings with Accessories	33
8	Centre of gravity	34
	Centre of Gravity	34
9	Piping diagrams	35
	Piping Diagrams	35
10	Sound data	36
	Sound Power Spectrum	36
	Sound Pressure Spectrum	38
11	Hydraulic performance	40
	Water Pressure Drop Curve Evaporator	40

1 Features

- 360° air discharge ensures uniform air flow and temperature distribution
- Modern style decoration panel in white (RAL9010)
- Fresh air intake for healthy living
- Comfortable horizontal air discharge ensures draughtfree operation and prevents ceiling soiling
- Possibility to shut 1 or 2 flaps for easy installation in corners
- Standard drain pump with 850mm lift



2

1

2 Specifications

2-1 Technical Specifications				FWC06BF	FWC07BF	FWC08BF	FWC09BF
Cooling capacity	Total capacity	High	kW	5.8 (1)	6.6 (1)	7.6 (1)	8.7 (1)
		Nom.	kW	4.9 (1)	5.6 (1)	6.3 (1)	7.2 (1)
		Low	kW	4.0 (1)	4.6 (1)	4.8 (1)	5.7 (1)
	Sensible capacity	High	kW	4.1 (1)	4.7 (1)	5.6 (1)	6.5 (1)
		Nom.	kW	3.4 (1)	3.9 (1)	4.4 (1)	5.2 (1)
		Low	kW	2.7 (1)	3.2 (1)	3.4 (1)	4.0 (1)
Heating capacity	4-Pipe	High	kW	7.5 (2)	8.4 (2)	9.7 (2)	11.0 (2)
		Nom.	kW	6.2 (2)	6.8 (2)	7.8 (2)	8.8 (2)
		Low	kW	5.5 (2)	5.9 (2)	6.7 (2)	7.8 (2)
Power input	High		W	46	55	77	107
	Nom.		W	41	47	59	77
	Low		W	35	38	40	46
Dimensions	Unit	Height	mm	288			
		Width	mm	840			
		Depth	mm	840			
Weight	Unit		kg	29			
Heat exchanger	Rows	Quantity		3			
	Fin pitch		mm	1.5			
Water pressure drop	Cooling		kPa	15	19	25	32
	Heating		kPa	24	30	38	47
Fan	Type		Turbo fan				
	Quantity		1				
	Air flow rate	High	m ³ /h	1,032	1,200	1,476	1,746
		Medium	m ³ /h	864	1,002	1,164	1,374
Low		m ³ /h	684	804	852	1,014	
Fan motor	Speed	Steps		3			
	Model		QTS48C15M				
Sound power level	Super high		dBA	43	47	53	57
	High		dBA	40	42	46	51
	Low		dBA	37	38	39	43
Sound pressure level	Super high		dBA	29	33	39	43
	High		dBA	27	29	33	38
	Low		dBA	24	25	26	30

Standard Accessories : O ring;

Standard Accessories : Installation guide;

Standard Accessories : Screws;

Standard Accessories : Insulation;

Standard Accessories : Washer for hanger bracket;

Standard Accessories : Clamp for drain hose;

Standard Accessories : Drain hose;

Standard Accessories : Installation and operation manual;

2-2 Electrical Specifications				FWC06BF	FWC07BF	FWC08BF	FWC09BF
Power supply	Phase		1~				
	Frequency		Hz	50			
	Voltage		V	220-240			

Notes

(1) Cooling: air 27°CDB, 19°CWB; entering water 7°C; leaving water 12°C

(2) Heating: 4 pipe: air 20°CDB; entering water 70°C; leaving water 60°C

(3) Do not let water of less than 5°C or more than 50°/70°C enter the unit, this may damage the unit

(4) Height includes switch box

3 Electrical data

3 - 1 Electrical Data

FWC-BT/BF

Model	Type	Units			Power supply		IFM		Input (W)	
		Hz	Voltage range	Voltage limits	MCA	MFA	kW	FLA	Cooling	Heating
FWC06BT	V1	50	220-240	Max. 264 Min. 198	0.3	16	0.120	0.2	45	45
FWC07BT					0.4	16	0.120	0.3	54	54
FWC08BT					0.6	16	0.120	0.5	77	77
FWC09BT					0.9	16	0.120	0.7	107	107
FWC06BF					0.3	16	0.120	0.2	46	46
FWC07BF					0.4	16	0.120	0.3	55	55
FWC08BF					0.6	16	0.120	0.5	77	77
FWC09BF					0.9	16	0.120	0.7	107	107

SYMBOLS

MCA : Min. Circuit Amps. (A)
MFA : Max. Fuse Amps. (See note 5)
kW : Fan Motor Rated Output (kW)
FLA : Full Load Amps. (A)
IFM : Indoor Fan Motor

NOTES

- Voltage limits:
Units are suitable for use on electrical systems where voltage supplied to unit terminals is not below or above listed range limits.
- Maximum allowable voltage unbalance between phases is 2%
- MCA/MFA:
 $MCA = 1.25 \times FLA$
 $MFA \leq 4 \times FLA$
(Next lower standard fuse rating min. 16A)
- Select wire size based on the MCA
- Instead of fuse, use Circuit Breaker.

4TW33121-2

2

3

4 Safety device settings

4 - 1 Safety Device Settings

FWC-BT/BF		6	7	8	9	
FWC-BT/BF	PC board fuse	250V 5A	250V 5A	250V 5A	250V 5A	
	Fan motor thermal fuse	°C	-	-	-	
	Fan motor thermal protector	°C	OFF: 108 ^{±5} (ON: 96 ^{±15})	OFF: 108 ^{±5} (ON: 96 ^{±15})	OFF: 108 ^{±5} (ON: 96 ^{±15})	OFF: 108 ^{±5} (ON: 96 ^{±15})
	Drain pump fuse	°C	145	145	145	

3TW33129-4

5 Options

5 - 1 Options

FWC-BT/BF

Options

	Item	Model	FWC06-09BT/BF
1	Decoration Panel - Standard (RAL 9010 - grey sealings)	Round flow	BYCQ140CW1
2	Decoration Panel - White (RAL 9010 - white sealings)	Round flow	BYCQ140CW1W
3	Sealing member of air discharge outlet		KDBHQ55C140
4	Long-life filter		KAFP551K160
5	Fresh air intake kit (20% fresh air)	Direct installation type	KDDQ55C140

Control systems

	Item	Model	FWC06-09B	
1	Remote control	Infrared	H/P	BRC7F532F (*12)
			C/O	BRC7F533F (*12)
		Wired		BRC315D7 (*1)
2	Central remote control		DCS302CA51 (*2)	
2.1	Electrical box with earth terminal (3 blocks)		KJB311A	
3	Unified on/off control		DCS301BA51 (*4)(*6)	
3.1	Electrical box with earth terminal (2 blocks)		KJB212A	
3.2	Noise filter (for electromagnetic interface use only)		KEK26-1A	
4	Schedule timer		DST301BA51 (*6)(*9)	
5	Wiring adapter for electrical appendices (1)		KRP2A52 (*5)(*9)	
6	Wiring adapter for electrical appendices (2)		KRP4AA53 (*5)(*9)	
7	Installation box for adapter PCB		KRP1H98 (*10)	
8	Remote sensor		KRCS01-4	
10	Intelligent touch controller		DCS601C51C (*3)(*8)	
10.1	Electrical installation box		KJB411A	
11	Optional PCB for MOD-bus connection		EKFCMBCB7 (*5)(*9)	
12	2-way valve - On/Off		EKMV2C09B7 (*5)(*7)(*11)	
13	3-way valve - On/Off		EKMV3C09B7 (*5)(*7)(*11)	
14	Valve control PCB		EKRP1C11	

NOTES

- Optional, electrical installation box with earth terminal KJB212A is required, if controller wires need to be installed in the wall.
- Requires electrical installation box with earth terminal KJB311A.
- Requires electrical installation box KJB411A.
- Requires noise filter (for electromagnetic interface use only) KEK26-1A
- Requires installation box KRP1H98.
- Requires electrical installation box with earth terminal KJB212A, if built in the wall.
- Requires valve control PCB EKRP1C11.
- I-touch:
 - Not allowed to use the i-touch for an installation with both fan coils and VRV units.
 - Can not be used in combination with fan coil units, that use MOD bus communication.
 - No Airmet or telephone connection possible.
- Only 1 of these 4 options can be installed on 1 indoor unit.
- Max. 1 KRP1H98 box can be mounted on the unit. Max. 2 PCB's can be mounted in 1 KRP1H98 box.
- 2-pipe unit: 1 x valve kit + 1 x installation box for PCB KRP1H98 + 1 x valve control PCB EKRP1C11
4-pipe unit: 2 x valve kit + 1 x installation box for PCB KRP1H98 + 1 x valve control PCB EKRP1C 11
- It is possible to change the operation mode, but this will not have an impact on the water temperature .
(No feed back to water source)
It is not possible to select the "auto air flow" setting.
Dry operation can be selected with this remote control, but this function is not available on the FWC model.
- All options are supplied as kit.

3TW33129-1A

5 Options

5 - 1 Options

FWC-BT/BF				
Brief description of purpose of the available options:				
	Item	Model	FWC06-09BT/BF	Description
1	Decoration Panel - Standard (RAL 9010 - grey sealings)	Round flow	BYCQ140CW1	Decoration panel for the fan coil unit that is built in the false sealing. Mandatory when installing the fan coil unit.
2	Decoration Panel - White (RAL 9010 - white sealings)	Round flow	BYCQ140CW1W	Decoration panel for the fan coil unit that is built in the false sealing. Mandatory when installing the fan coil unit.
3	Sealing member of air discharge outlet		KDBHQ55C140	This option can be used in case the fan coil unit is installed close to a wall on one or more sides (closer than 1500 mm). With the blocking parts one or more air outlets of the fan coil unit can be closed --> Fan coil unit can be installed closer to a wall (but further then 200mm).
4	Long-life filter		KAFP551K160	High quality filter that can be used if supplied filter is damaged.
5	Fresh air intake kit (20% fresh air)		Direct installation type KDDQ55C140	Kit that can be connected to the ventilation system to supply fresh air to the fan coil unit.
6	Remote control	Infrared	H/P BRC7E532F	Infrared remote control to control each fan coil unit independently with cooling and heating functionality. It's not possible to select auto air flow with this remote control. Also there is no feedback regarding the operation mode to the "water supply unit". --> Changing the operation mode will not have an effect on the supplied water temperature. Dry operation can be selected, but the FWF unit does not have this function.
			C/O BRC7E533F	Infrared remote control to control each fan coil unit independently with cooling functionality. It's not possible to select auto air flow with this remote control. Also there is no feedback regarding the operation mode to the water supply unit. --> Changing the operation mode will not have an effect on the supplied water temperature. Dry operation can be selected, but the FWF unit does not have this function.
		Wired BRC315D7	Wired remote control to control each fan coil unit independently with cooling and heating functionality. There is no weekly timer function in this remote control. Only a limited on/off timer function is available. In case wires need to be installed inside the wall, the KJB212A installation box is required.	
7	Central remote control		DCS302CA51	Remote control for centralized control of all connected fan coil units (only FWF and FWC type).
7.1	Electrical box with earth terminal (3 blocks)		KJB311A	Requires the KJB311A electrical installation box for the installation.
8	Unified on/off control		DCS301BA51	Remote control to switch all connected fan coil units (only FWC and FWF type) ON or OFF.
8.1	Electrical box with earth terminal (2 blocks)		KJB212A	In case unified on/off controller is built in the wall, the electrical box KJB212A kit is required.
8.2	Noise filter (for electromagnetic interface use only)		KEK26-1A	For compliance reasons, the noise filter KEK26-1A is required in case a unified on/off controller is installed.
9	Schedule timer		DST301BA51	Controller with schedule timer functionality for the fan coil units (only FWC and FWF). It's not possible to combine this option with neither KRP2A52 nor KRP4AA53 nor EKFCMBCB7 on the same fan coil unit. In case the schedule timer is built in the wall, the electrical box KJB212A is required.
10	Intelligent touch control		DCS601C51C	Advanced remote control for centralized control of all connected fan coil units (but only FWF and FWC type and up to 128 fan coil units). More functions are possible than with the central remote control. Compared to VRV systems, it's not possible to use AIRNET and telephone connection. The I-touch can not be used for installations with both DX units and fan coil units. The I-touch can not be used for installations with fan coil units that use Mod Bus communication.
10.1	Electrical installation box		KJB411A	Electrical installation box KJB411A is needed for the installation of the I-touch remote control.
11	Remote sensor		KRCS01-1	Sensor to measure the room temperature remotely from a location other than the fan coil unit or the remote control.
12	2-way valve - On/Off		EKMV2C09B7	2-way valve to control the water supply to the fan coil unit. The option kit EKRP1C11 is needed to control the valve.
13	3-way valve - On/Off		EKMV3C09B7	3-way valve to control the water supply to the fan coil unit. The option kit EKRP1C11 is needed to control the valve.
14	Valve control PCB		EKRP1C11	PCB to control the 2-way and 3 way valves. Only 1 option kit is needed per fan coil unit. It is possible to connect 2 valves on 1 PCB. For the installation of the PCB, the installation box KRP1H98 is required.
15	Optional PCB for MOD-bus connection		EKFCMBCB7	PCB to transform the Dill communication of the FWC and FWF fan coil units to Mod Bus communication. For the installation of the PCB, the installation box KRP1 H98 is required. It's not possible to combine this option with KRP2A52 or KRP4AA53 or DST301BA51 on the same fan coil unit.
16	Wiring adapter for electrical appendices (1)		KRP2A52	PCB with additional connection for external input/output signals. For the installation of the PCB, the installation box KRP1 H98 is required. It's not possible to combine this option with KRP4AA53 or EKFCMBCB7 or DST301 BA51 on the same fan coil unit. Example of input signals: set point, on/off contact. Example of outputs: error stats of fan coil unit, operation status of fan coil unit (on/off). This PCB can control all FWC and FWF fan coil units connected on the same F1/F2 communication wire.
17	Wiring adapter for electrical appendices (2)		KRP4AA53	PCB with additional connection for external input/output signals. For the installation of the PCB, the installation box KRP1H98 is required. It's not possible to combine this option with KRP2A52 or EKFCMBCB7 or DST301BA51 on the same fan coil unit. Example of input signals: set point, on/off contact. Example of outputs: error stats of fan coil unit, operation status of fan coil unit (on/off). This PCB can control only FWC and FWF fan coil units connected on the same P1/P2 remote control communication wire.
18	Installation box for adapter PCB		KRP1H98	Installation box for some option kits. Max. 1 box can be installed on a single FWC unit. 2 PCB's can be installed in 1 box.

3TW33129-2

6 Capacity tables

6 - 1 Cooling Capacity Tables

2
6

FWC-BF		22-16															
Air temperature (°CDB -°CWB)		6-11				7-12				6-13				9-14			
Water temperature (Entering °C - Leaving °C)		Total cooling capacity (kW)	Sensible cooling capacity (kW)	Water flow (l/min)	Water pressure drop (kPa)	Total cooling capacity (kW)	Sensible cooling capacity (kW)	Water flow (l/min)	Water pressure drop (kPa)	Total cooling capacity (kW)	Sensible cooling capacity (kW)	Water flow (l/min)	Water pressure drop (kPa)	Total cooling capacity (kW)	Sensible cooling capacity (kW)	Water flow (l/min)	Water pressure drop (kPa)
FWC06BF	HH	3.9	2.9	11.5	8	3.3	2.6	10.1	7	2.7	2.4	9.0	6	2.2	2.1	7.7	5
	H	3.4	2.4	9.8	6	2.9	2.2	8.7	5	2.4	2.0	8.1	5	2.0	1.8	7.5	5
	L	2.8	2.0	8.1	5	2.4	1.9	7.8	5	2.1	1.8	7.0	4	1.6	1.6	6.5	5
FWC07BF	HH	4.5	3.4	13.0	10	4.0	3.1	11.5	8	3.3	2.8	10.1	7	2.6	2.5	8.6	5
	H	3.9	2.8	11.0	8	3.2	2.6	9.9	6	2.6	2.3	8.7	5	2.1	2.0	7.9	5
	L	3.2	2.4	9.3	6	2.7	2.2	8.1	5	2.3	2.1	7.4	4	1.8	1.8	6.8	5
FWC08BF	HH	5.1	3.8	15.0	13	4.3	3.5	13.1	10	3.5	2.9	11.4	8	2.8	2.6	9.7	6
	H	4.3	3.2	12.4	9	3.8	2.9	11.1	8	3.3	2.6	9.4	6	2.4	2.3	8.3	5
	L	3.4	2.5	9.7	6	2.9	2.3	8.6	5	2.7	2.2	7.8	5	1.9	1.9	7.0	5
FWC09BF	HH	5.7	4.4	17.0	15	4.8	3.8	15.1	13	4.2	3.3	12.8	10	3.2	2.8	11.0	7
	H	4.9	3.8	14.0	11	4.2	3.4	12.5	9	3.4	2.9	10.8	7	2.7	2.5	9.4	6
	L	4.0	3.0	11.4	8	3.4	2.7	10.0	7	2.8	2.4	8.8	5	2.1	2.1	7.7	5

FWC-BF		25-18															
Air temperature (°CDB -°CWB)		6-11				7-12				6-13				9-14			
Water temperature (Entering °C - Leaving °C)		Total cooling capacity (kW)	Sensible cooling capacity (kW)	Water flow (l/min)	Water pressure drop (kPa)	Total cooling capacity (kW)	Sensible cooling capacity (kW)	Water flow (l/min)	Water pressure drop (kPa)	Total cooling capacity (kW)	Sensible cooling capacity (kW)	Water flow (l/min)	Water pressure drop (kPa)	Total cooling capacity (kW)	Sensible cooling capacity (kW)	Water flow (l/min)	Water pressure drop (kPa)
FWC06BF	HH	5.5	3.8	16.0	14	5.0	3.6	14.4	12	4.4	3.2	12.6	9	3.8	2.9	11.0	8
	H	4.7	3.1	13.6	11	4.2	2.9	12.0	9	3.7	2.7	10.6	7	3.2	2.5	9.4	6
	L	3.8	2.5	11.0	8	3.5	2.4	10.0	7	3.2	2.2	8.7	5	2.8	2.1	7.8	5
FWC07BF	HH	6.3	4.4	18.0	17	5.7	4.1	16.4	15	5.1	3.7	14.0	11	4.5	3.4	12.3	9
	H	5.3	3.7	15.4	13	4.8	3.4	13.9	11	4.2	3.1	12.0	9	3.6	2.9	10.7	7
	L	4.4	3.0	12.7	10	4.0	2.8	11.3	8	3.7	2.6	10.0	7	3.1	2.5	9.0	6
FWC08BF	HH	7.2	5.2	20.7	22	6.5	4.8	18.7	18	5.8	4.3	16.0	14	5.0	3.8	14.1	11
	H	6.0	4.1	17.4	16	5.4	3.9	15.7	14	4.8	3.5	13.5	11	4.1	3.3	12.0	9
	L	4.7	3.2	13.4	10	4.2	3.0	12.0	9	3.8	2.8	10.4	7	3.2	2.5	9.2	6
FWC09BF	HH	8.0	5.9	24.0	28	7.2	5.5	21.3	23	6.3	4.9	18.0	17	5.3	4.3	16.1	14
	H	6.9	4.9	20.0	20	6.2	4.5	17.7	17	5.4	4.1	15.2	13	4.6	3.9	13.6	11
	L	5.4	3.8	15.7	14	5.0	3.5	14.3	12	4.4	3.2	12.4	9	3.7	3.0	11.0	8

NOTES

1. The capacity is only guaranteed at the nominal conditions

3TW33122-2

FWC-BF		27-19															
Air temperature (°CDB -°CWB)		6-11				7-12				6-13				9-14			
Water temperature (Entering °C - Leaving °C)		Total cooling capacity (kW)	Sensible cooling capacity (kW)	Water flow (l/min)	Water pressure drop (kPa)	Total cooling capacity (kW)	Sensible cooling capacity (kW)	Water flow (l/min)	Water pressure drop (kPa)	Total cooling capacity (kW)	Sensible cooling capacity (kW)	Water flow (l/min)	Water pressure drop (kPa)	Total cooling capacity (kW)	Sensible cooling capacity (kW)	Water flow (l/min)	Water pressure drop (kPa)
FWC06BF	HH	6.3	4.3	18.0	17	5.8	4.1	16.7	15	5.3	3.8	15.0	15	4.5	3.5	13.0	10
	H	5.3	3.6	15.2	13	4.9	3.4	14.0	11	4.4	3.2	12.7	10	3.9	2.9	11.0	8
	L	4.3	2.9	12.5	9	4.0	2.7	11.5	8	3.6	2.5	10.3	7	3.2	2.4	9.2	6
FWC07BF	HH	7.1	5.0	20.5	21	6.6	4.7	18.9	19	5.9	4.4	17.0	15	5.1	4.0	14.7	12
	H	6.0	4.1	17.3	16	5.6	3.9	16.0	14	5.0	3.6	14.4	12	4.4	3.4	12.4	9
	L	5.0	3.4	14.2	11	4.6	3.2	13.2	10	4.1	3.0	11.8	8	3.6	2.8	10.5	7
FWC08BF	HH	8.2	5.9	23.5	27	7.6	5.6	21.6	23	6.8	5.2	19.6	20	5.8	4.7	16.6	15
	H	6.8	4.6	19.7	20	6.3	4.4	18.0	17	5.6	4.1	16.0	14	4.9	3.8	14.0	11
	L	5.2	3.6	15.0	13	4.8	3.4	13.8	11	4.3	3.2	12.3	9	3.8	3.0	11.0	8
FWC09BF	HH	9.3	6.7	27.0	35	8.7	6.5	24.8	30	7.8	6.0	22.3	25	6.5	5.3	19.2	19
	H	7.8	5.5	22.4	25	7.2	5.2	20.5	21	6.4	4.8	18.3	18	5.6	4.5	16.0	14
	L	6.2	4.2	18.0	17	5.7	4.0	16.2	14	5.2	3.8	15.0	13	4.5	3.5	12.7	10

FWC-BF		30-32															
Air temperature (°CDB -°CWB)		6-11				7-12				6-13				9-14			
Water temperature (Entering °C - Leaving °C)		Total cooling capacity (kW)	Sensible cooling capacity (kW)	Water flow (l/min)	Water pressure drop (kPa)	Total cooling capacity (kW)	Sensible cooling capacity (kW)	Water flow (l/min)	Water pressure drop (kPa)	Total cooling capacity (kW)	Sensible cooling capacity (kW)	Water flow (l/min)	Water pressure drop (kPa)	Total cooling capacity (kW)	Sensible cooling capacity (kW)	Water flow (l/min)	Water pressure drop (kPa)
FWC06BF	HH	8.8	5.1	25.0	30	8.2	4.8	23.7	28	7.7	4.6	22.0	24	7.1	4.4	20.4	21
	H	7.4	4.2	21.0	22	7.0	4.0	20.0	20	6.5	3.8	18.5	18	6.0	3.6	17.0	15
	L	6.0	3.4	17.4	16	5.7	3.2	16.3	14	5.3	3.0	15.0	13	4.9	2.9	14.0	11
FWC07BF	HH	10.0	5.8	28.5	38	9.4	5.6	27.0	35	8.7	5.3	25.0	30	8.1	5.0	23.2	27
	H	8.5	4.8	24.5	29	8.0	4.6	23.0	26	7.4	4.4	21.0	22	6.8	4.1	19.4	19
	L	6.9	4.0	20.0	20	6.5	3.8	18.5	18	6.1	3.6	17.5	16	5.6	3.4	16.0	14
FWC08BF	HH	11.6	6.9	33.0	50	10.9	6.6	31.5	46	10.1	6.2	29.0	40	9.3	5.9	26.5	34
	H	9.6	5.5	27.5	36	9.0	5.2	26.0	32	8.4	5.0	24.0	28	7.7	4.7	22.0	24
	L	7.3	4.2	21.0	22	6.8	4.0	19.5	20	6.4	3.8	18.4	18	5.9	3.6	17.0	15
FWC09BF	HH	13.2	7.9	38.5	67	12.3	7.5	36.0	59	11.5	7.2	33.5	52	10.6	6.8	30.5	43
	H	11.0	6.5	31.5	46	10.3	6.2	29.5	41	9.6	5.9	27.5	36	8.8	5.5	25.0	30
	L	8.7	5.0	25.0	30	8.1	4.7	23.5	27	7.6	4.5	21.5	23	7.0	4.3	20.0	20

NOTES

1. The capacity is only guaranteed at the nominal conditions

3TW33122-2

6 Capacity tables

6 - 2 Heating Capacity Tables

FWC-BF										
Air temperature (°CDB -°CWB)		20								
Water temperature (Entering °C - Leaving °C)		50-45			60-50			70-60		
Model	Airflow	Heating capacity (kW)	Water flow (l/min)	Water pressure drop (kPa)	Heating capacity (kW)	Water flow (l/min)	Water pressure drop (kPa)	Heating capacity (kW)	Water flow (l/min)	Water pressure drop (kPa)
FWC06BF	HH	4.5	13.0	27	5.5	7.9	12	7.5	12.2	24
	H	3.8	11.0	20	4.6	6.7	9	6.2	8.9	14
	L	3.4	9.7	16	4.1	6.0	8	5.5	7.9	12
FWC07BF	HH	5.0	14.7	33	6.1	8.8	14	8.4	14.0	30
	H	4.2	12.1	24	5.1	7.4	11	6.8	9.7	16
	L	3.6	10.5	19	4.4	6.4	8	5.9	8.5	13
FWC08BF	HH	5.8	17.0	43	7.0	10.1	18	9.7	15.9	38
	H	4.8	14.0	30	5.8	8.4	13	7.8	11.2	21
	L	4.1	12.0	23	5.0	7.3	10	6.7	9.6	16
FWC09BF	HH	6.6	19.0	52	8.0	11.5	22	11.0	18.0	47
	H	5.4	15.8	38	6.6	9.5	16	8.8	12.6	25
	L	4.8	14.0	30	5.9	8.5	13	7.8	11.2	21

FWC-BF										
Air temperature (°CDB -°CWB)		22								
Water temperature (Entering °C - Leaving °C)		50-45			60-50			70-60		
Model	Airflow	Heating capacity (kW)	Water flow (l/min)	Water pressure drop (kPa)	Heating capacity (kW)	Water flow (l/min)	Water pressure drop (kPa)	Heating capacity (kW)	Water flow (l/min)	Water pressure drop (kPa)
FWC06BF	HH	4.1	12.0	23	5.1	7.4	11	6.9	10.0	17
	H	3.5	10.2	18	4.3	6.2	8	5.9	8.4	13
	L	3.1	9.0	15	3.9	5.6	7	5.2	7.5	11
FWC07BF	HH	4.6	13.5	29	5.7	8.2	12	7.7	11.1	20
	H	3.9	11.2	21	4.8	6.9	9	6.5	9.3	15
	L	3.3	9.8	17	4.1	6.0	8	5.6	8.1	12
FWC08BF	HH	5.4	15.5	36	6.6	9.5	16	8.9	12.9	26
	H	4.4	12.8	26	5.4	7.8	11	7.4	10.7	19
	L	3.8	11.0	20	4.75	6.8	9	6.3	9.1	15
FWC09BF	HH	6.1	17.5	45	7.5	10.8	20	10.1	14.6	33
	H	5.0	14.5	32	6.1	8.8	14	8.3	12.0	23
	L	4.4	12.8	26	5.5	7.9	12	7.4	10.6	19

3TW33122-1

2
6

7 Dimensional drawings

7 - 1 Dimensional Drawings

FWC-BT/BF

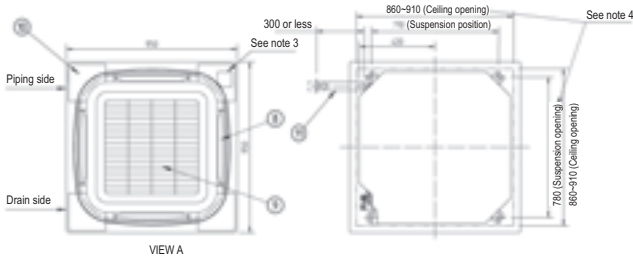

nr	name	description
1	water pipe connection cooling in	3/4" BSP female
2	water pipe connection cooling out	3/4" BSP female
3	water pipe connection heating in	3/4" BSP female
4	water pipe connection heating out	3/4" BSP female
5	drain pipe connection	VP25 (O.D. Ø32, I.D. Ø25)
6	power supply entry hole	
7	transmission wiring entry hole	
8	air discharge opening	
9	air suction grille	
10	corner decoration cover	
11	drain house	O.D. Ø32 I.D.Ø26
12	knock out hole	
13	air purge	

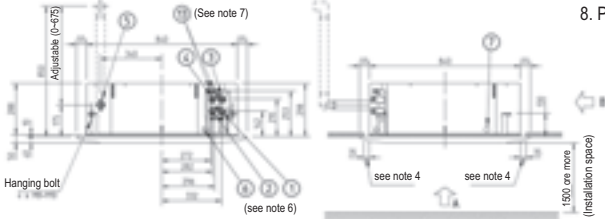

8. Please respect the distances as shown on figure below:

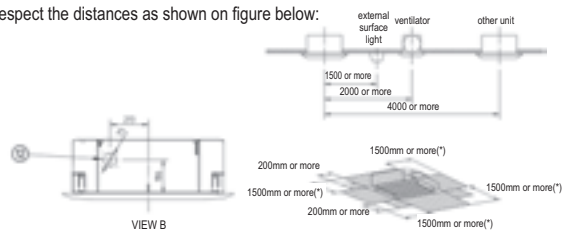

(*) In case a discharge opening is closed with the 'sealing member' option, the distance of 1500mm can be reduced to 500 mm on the closed side. 3TW33124-1

NOTES

- Location of the nameplates:
 - Unit body: on the control box cover.
 - Decoration panel: on the panel frame at the motor side under the corner cover
- When installing an optional accessory, refer to the installation drawings.
 - For the fresh air intake kit an inspection port is necessary
- In case of using a Infrared remote control, this position will be a signal receiver. Refer to the drawing of the Infrared remote control for more detail.
- Make sure the spacing between the ceiling and the cassette is no more than 35mm. Max. ceiling opening : 910mm.
- When the conditions exceed 30°C and RH 80% in the ceiling or fresh air is inducted into the ceiling, an additional insulation is required (polyethylene foam, thickness 10mm or more).
- Only models FWC06-09B7FV1B have heating pipe connections item 3 and item 4. For models FWC06-09B7TW1B water pipe connections, item 1 and item 2, are used for heating and cooling.
- Models FWC 06-09B7TV1B have only one air purge (they have no separate heating circuit).

FWC-BT/BF (with fresh air inlet)

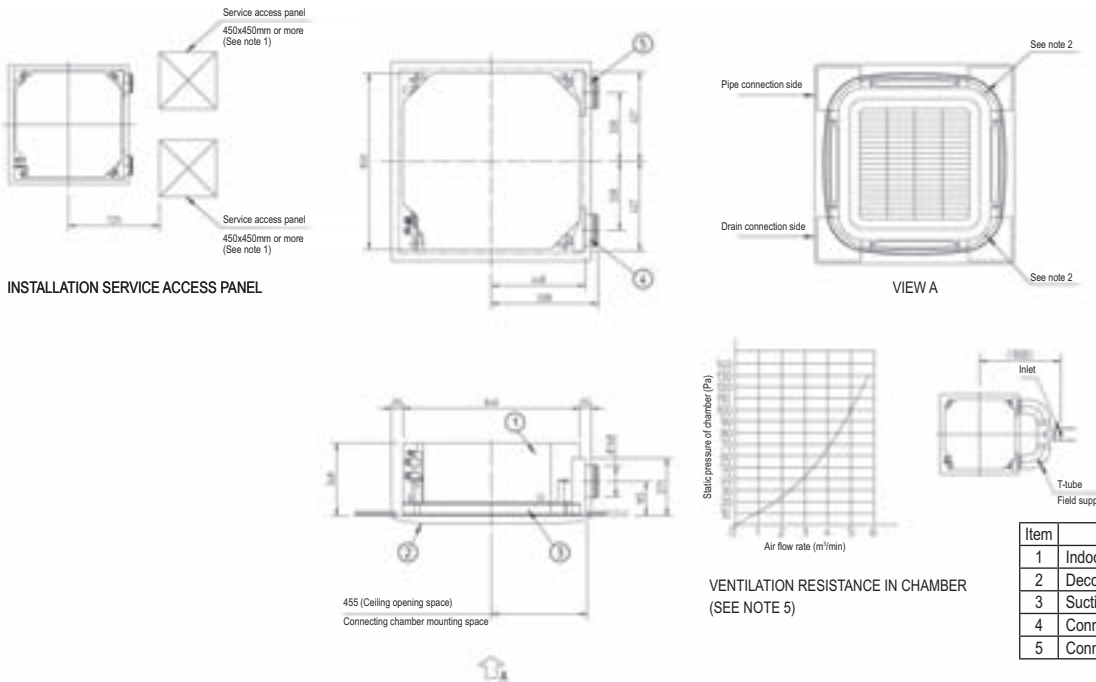

Item	Name	Remark
1	Indoor unit	.
2	Decoration panel	.
3	Suction chamber	.
4	Connecting chamber (right)	.
5	Connecting chamber (Left)	.

3TW33124-2

NOTES

- When installing this kit, inspection hatch is necessary. (It is necessary for servicing). Either one of inspection hatches must be installed.
- The corner air outlet of this part must be shut.
- In case of mounting a duct fan, make sure to use a wiring adapter for electrical appendices and link with the indoor unit fan.
- The intake air flow rate is recommended to be 20% or less of the H speed air flow rate.
 - If the intake air flow rate is too large, the operating sound may rise or detection of the indoor unit suction temperature may be affected.
- This indicates the distance between the T-tube inlet and the indoor unit inlet, when the T-tube is connected.

7 Dimensional drawings

7 - 2 Dimensional Drawings with Accessories

FWC-BT/BF

• Remote control dimensions

Transmitting part

157

62

17.5

• Remote control holder installation procedure (Installation to wall surface)

Liquid crystal remote control (infrared)

Remote control holder

• Receiver installation procedure

Pipe connection side

Receiver

Drain connection side

Decoration panel

• Receiver detail

• Infrared remote control kit for each decoration panel

Infrared remote control kit	Decoration panel
BRC7F532F / BRC7F533F	BYCQ140CW1

3D056851

8 Centre of gravity

8 - 1 Centre of Gravity

FWC-BT/BF

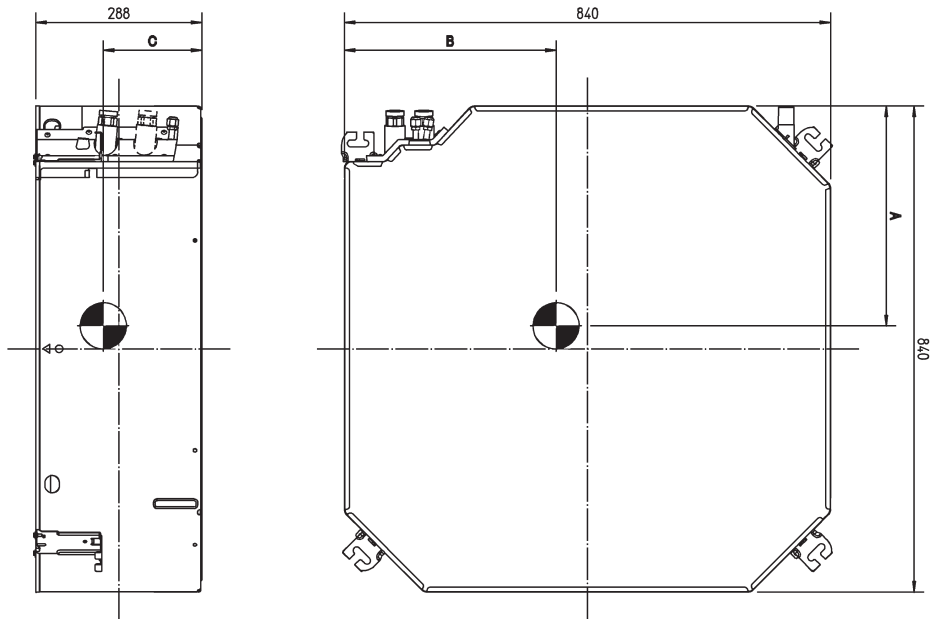

Model	A	B	C
FWC06-09BT	412	404	167
FWC06-09BF	420	406	189

4TW33124-3

9 Piping diagrams

9 - 1 Piping Diagrams

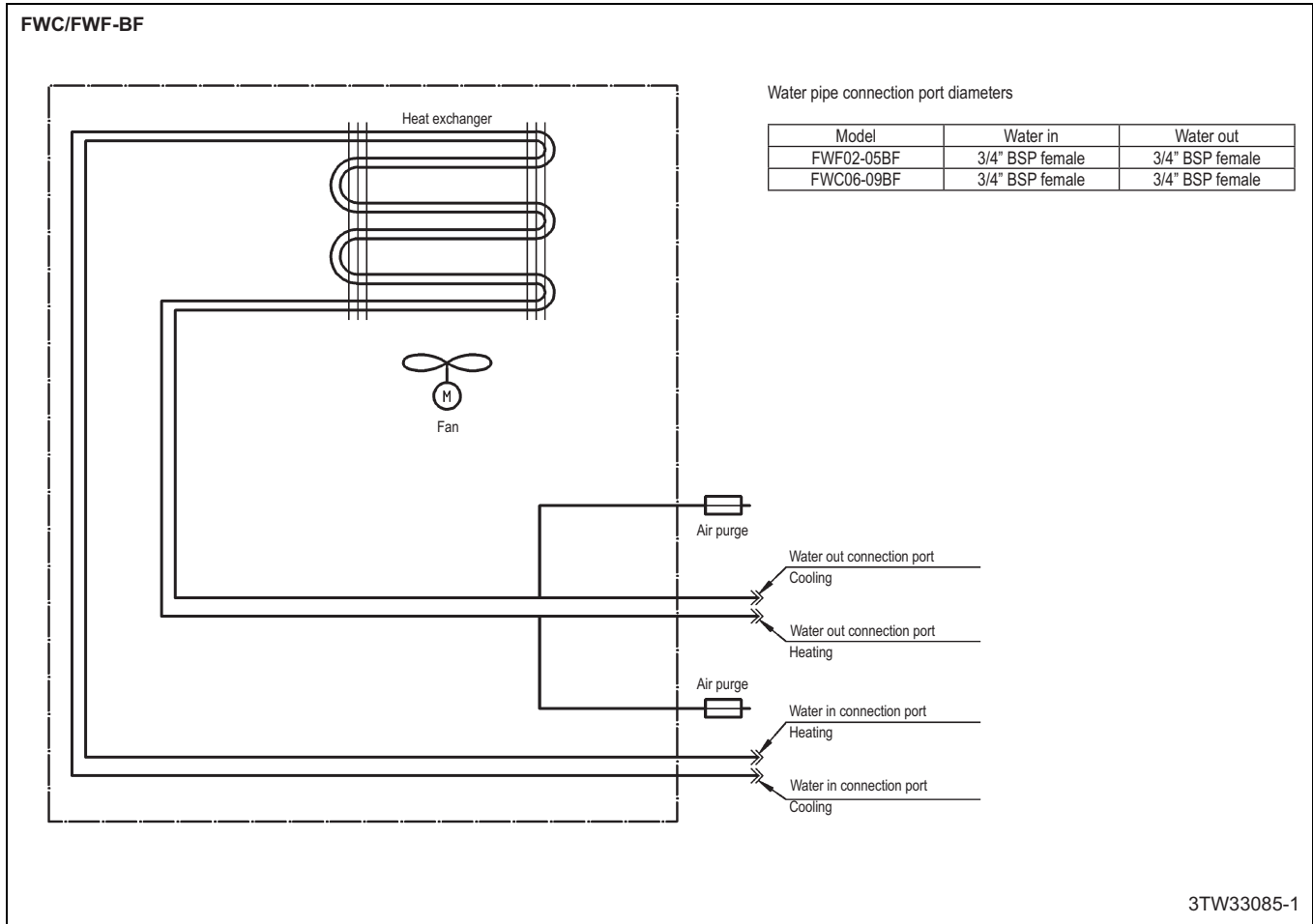

10 Sound data

10 - 1 Sound Power Spectrum

2
10

FWC06BF

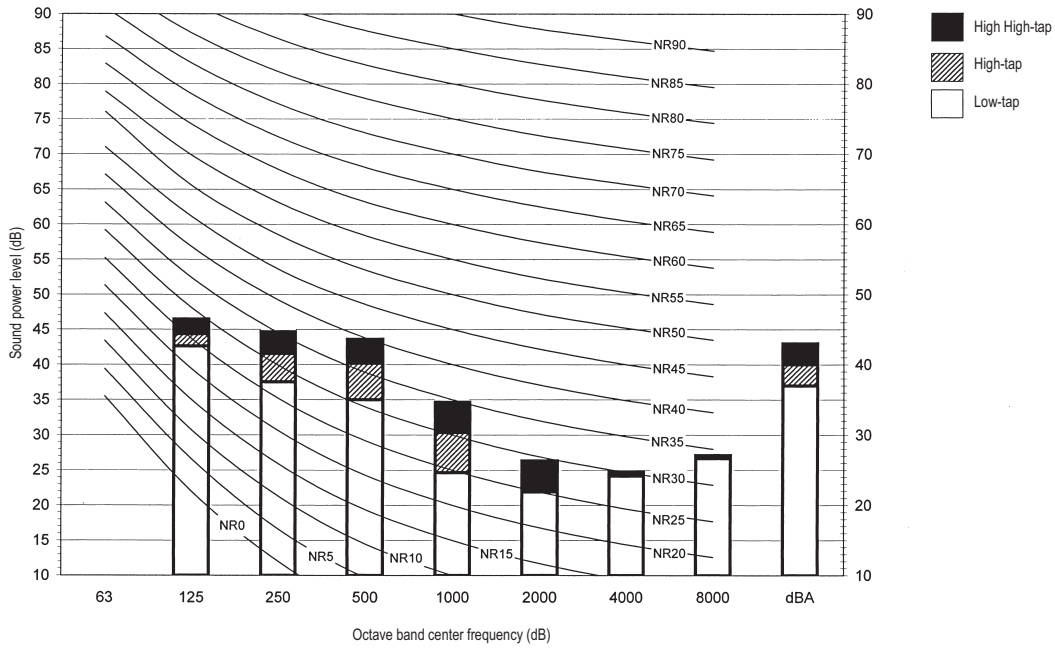

3TW33127-1

NOTES

1. dBA = A-weighted sound power level. (A-scale according to IEC)
2. Reference acoustic intensity 0dB = 10E-6μW/m²
3. Measured according to ISO 3744

FWC07BF

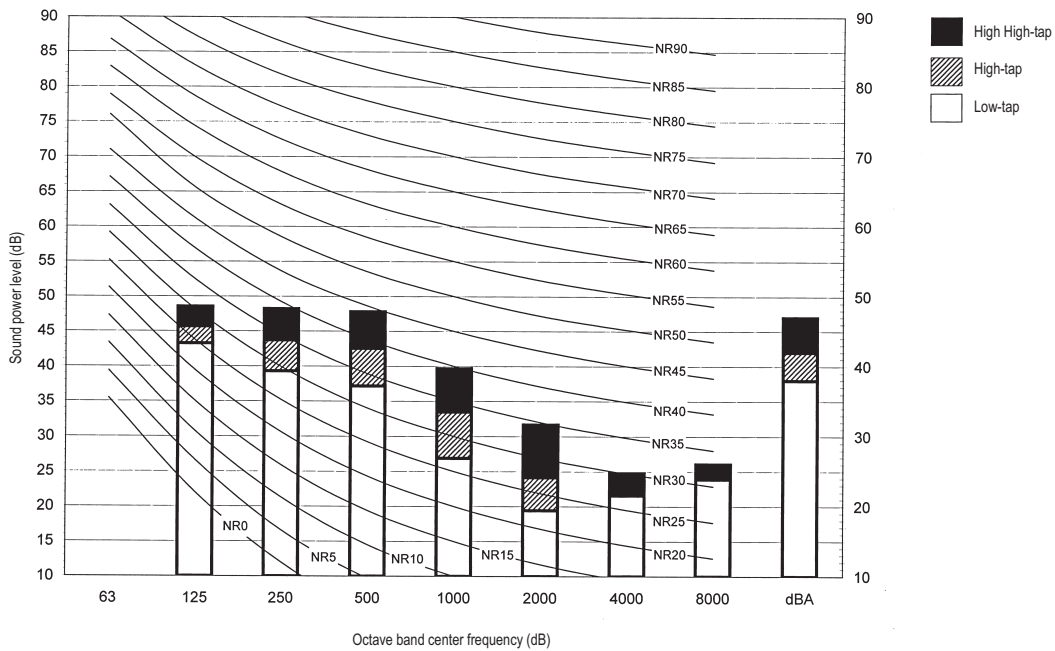

3TW33137-1

NOTES

1. dBA = A-weighted sound power level. (A-scale according to IEC)
2. Reference acoustic intensity 0dB = 10E-6μW/m²
3. Measured according to ISO 3744

10 Sound data

10 - 1 Sound Power Spectrum

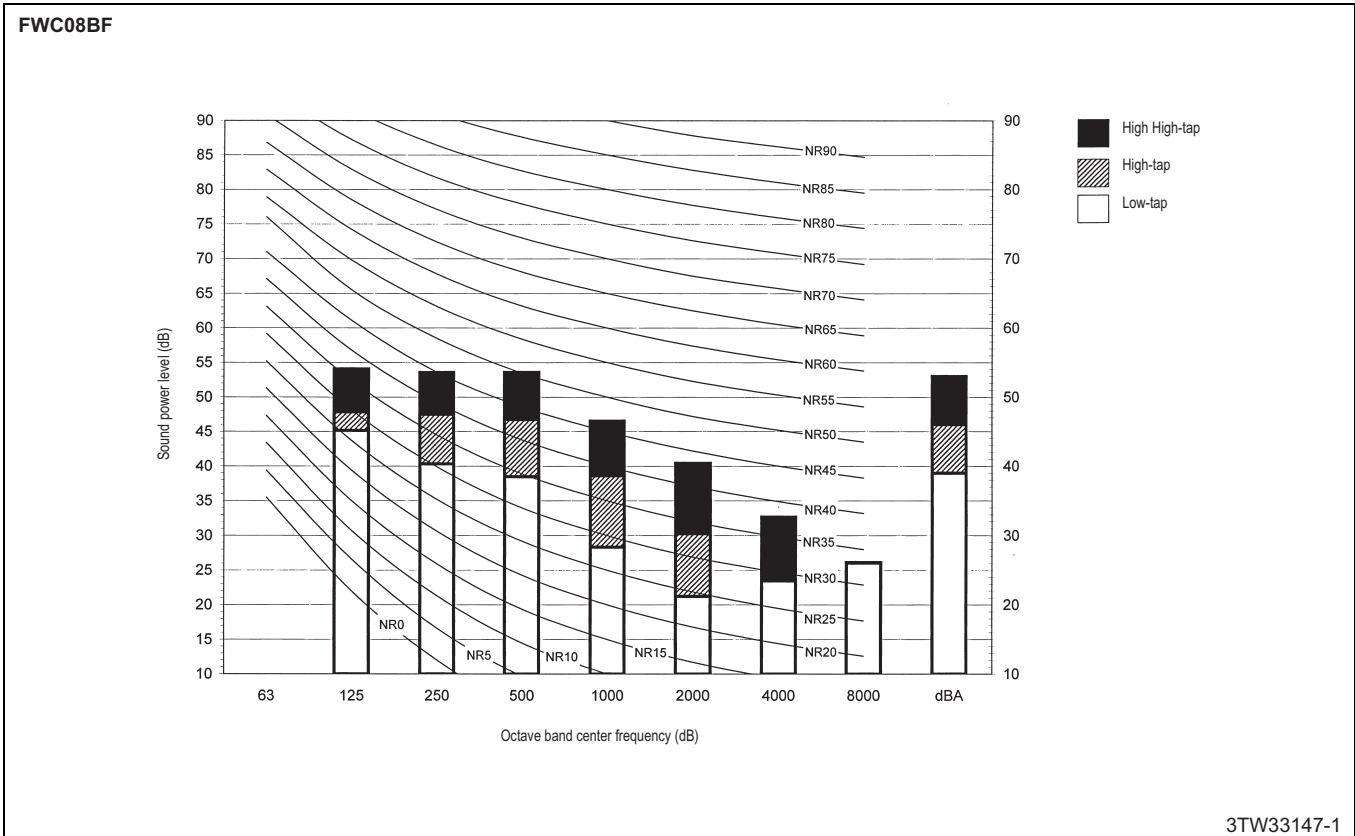

NOTES

1. dBA = A-weighted sound power level. (A-scale according to IEC)
2. Reference acoustic intensity $0\text{dB} = 10\text{E-}6\mu\text{W/m}^2$
3. Measured according to ISO 3744

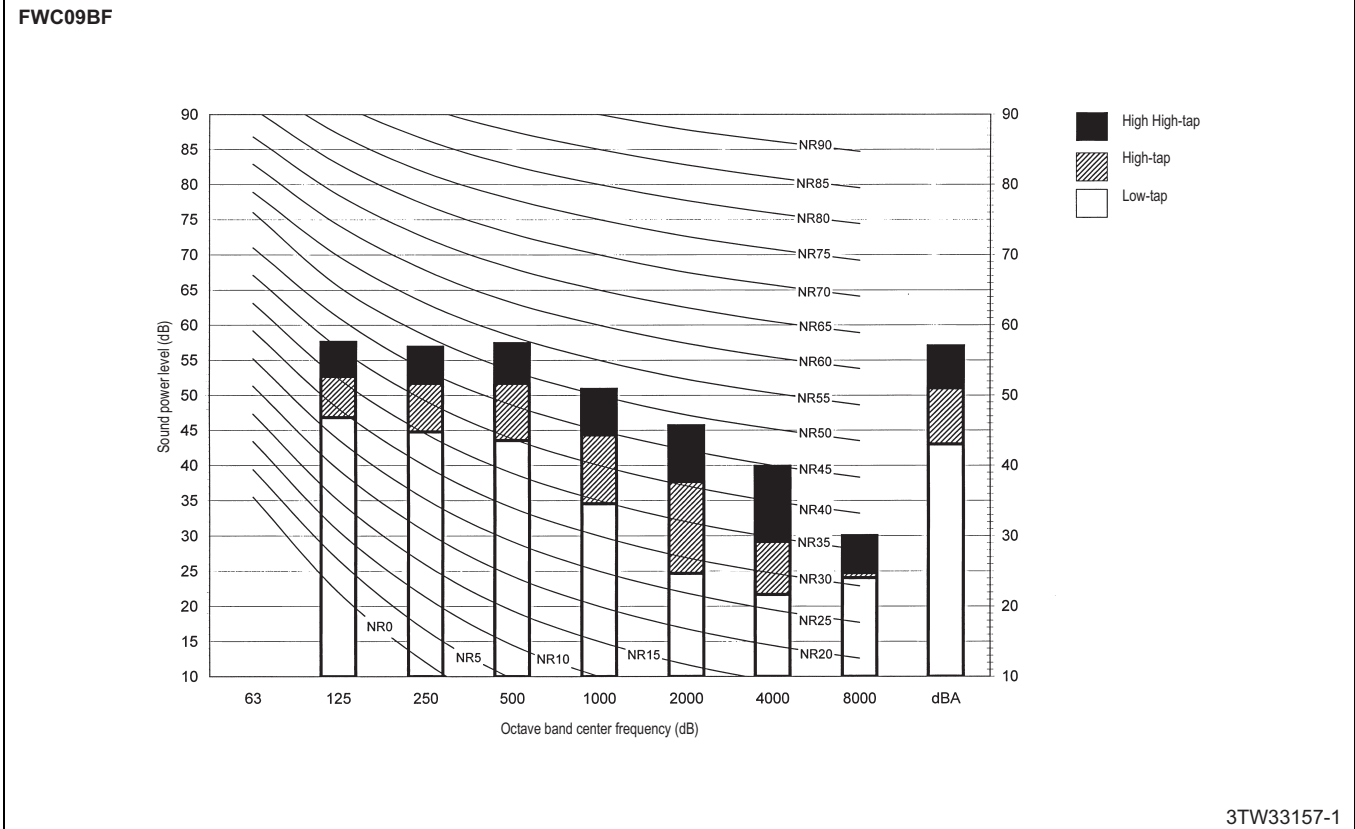

NOTES

1. dBA = A-weighted sound power level. (A-scale according to IEC)
2. Reference acoustic intensity $0\text{dB} = 10\text{E-}6\mu\text{W/m}^2$
3. Measured according to ISO 3744

10 Sound data

10 - 2 Sound Pressure Spectrum

2
10

FWC06BF

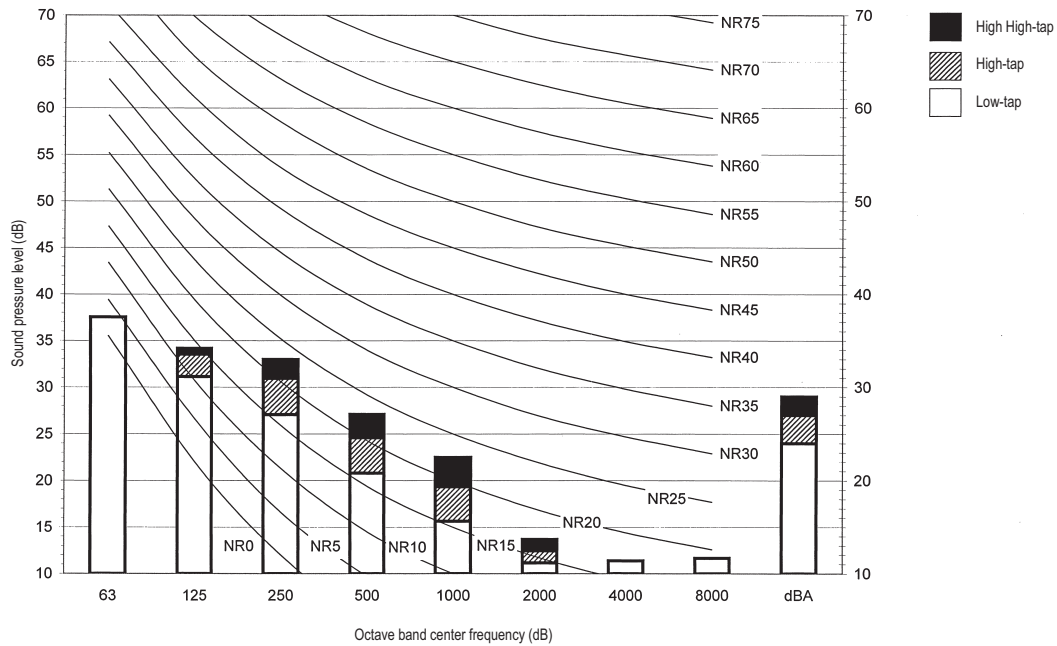

3TW33127-2

NOTES

1. Data is valid at free field condition
2. Data is valid at nominal operation condition
3. dBA =A-weighted sound pressure level. (A-scale according to IEC)
4. Reference acoustic pressures 0dB =20μPa

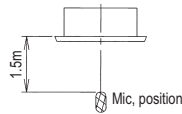

FWC07BF

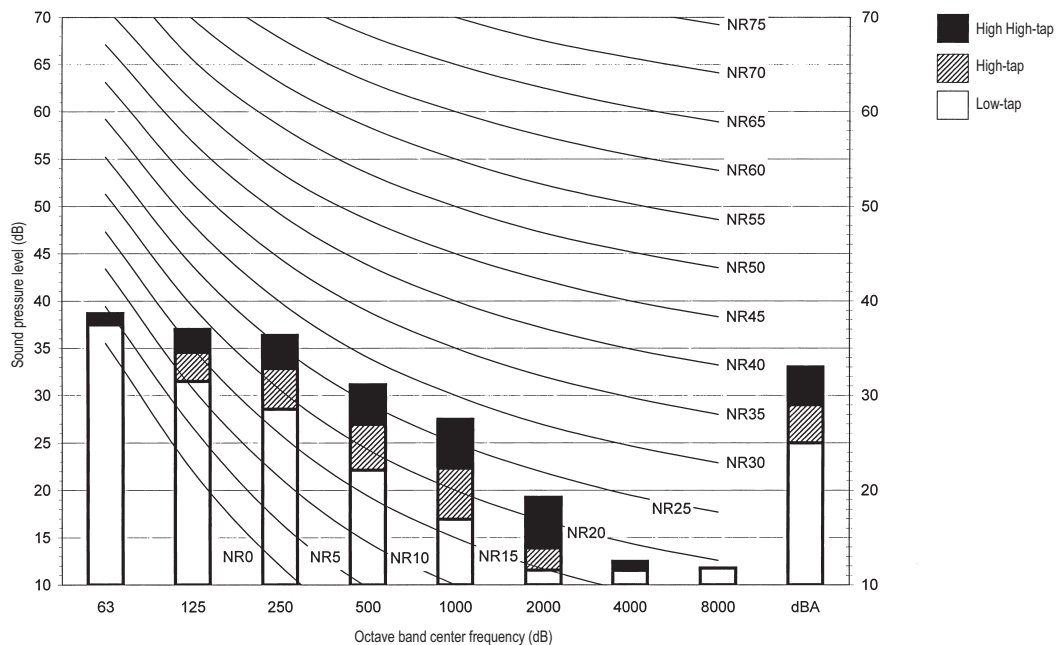

3TW33137-2

NOTES

1. Data is valid at free field condition
2. Data is valid at nominal operation condition
3. dBA =A-weighted sound pressure level. (A-scale according to IEC)
4. Reference acoustic pressures 0dB =20μPa

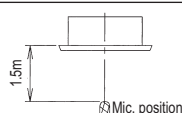

10 Sound data

10 - 2 Sound Pressure Spectrum

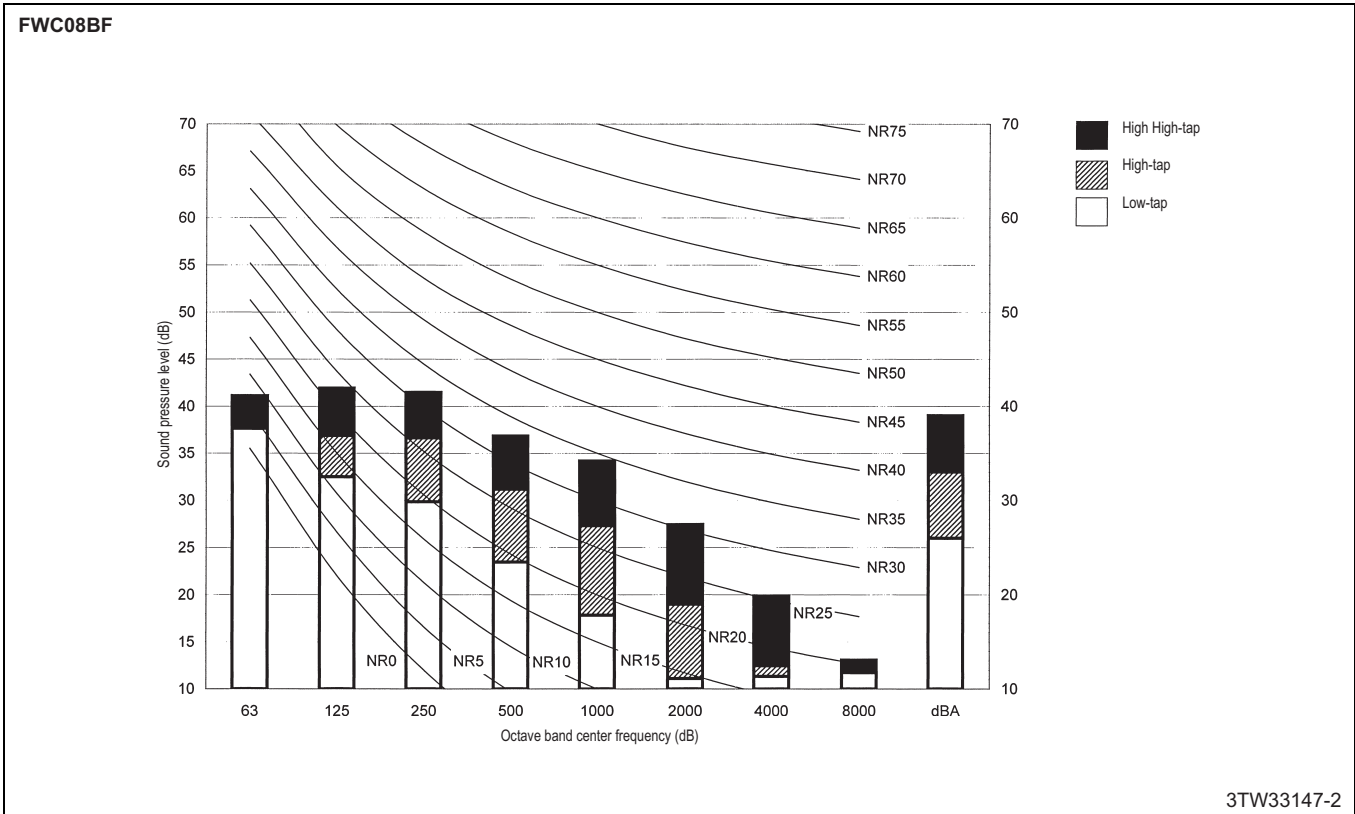

NOTES

1. Data is valid at free field condition
2. Data is valid at nominal operation condition
3. dBA =A-weighted sound pressure level. (A-scale according to IEC)
4. Reference acoustic pressures 0dB =20μPa

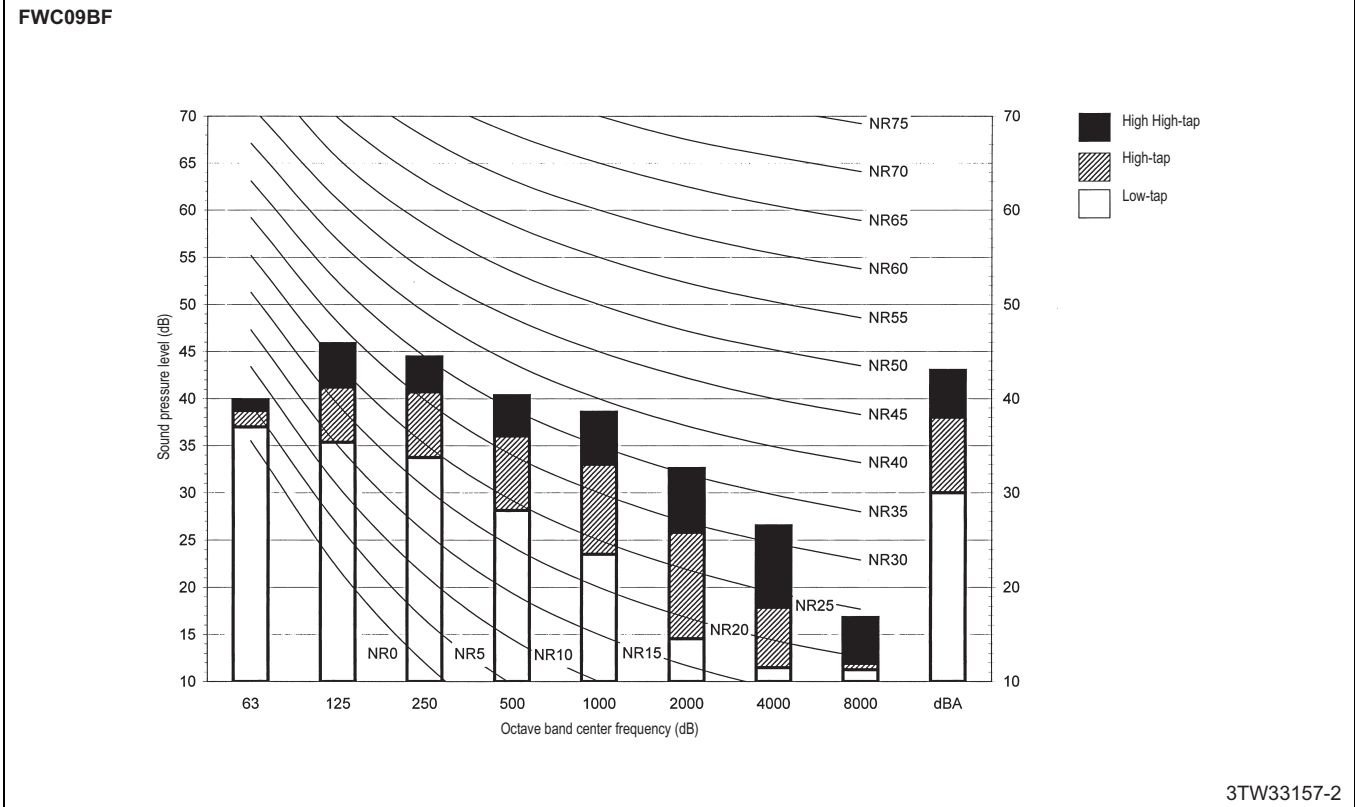
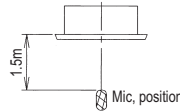

NOTES

1. Data is valid at free field condition
2. Data is valid at nominal operation condition
3. dBA =A-weighted sound pressure level. (A-scale according to IEC)
4. Reference acoustic pressures 0dB =20μPa

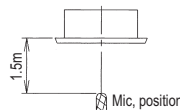

11 Hydraulic performance

11 - 1 Water Pressure Drop Curve Evaporator

2
11

FWC06-09BF

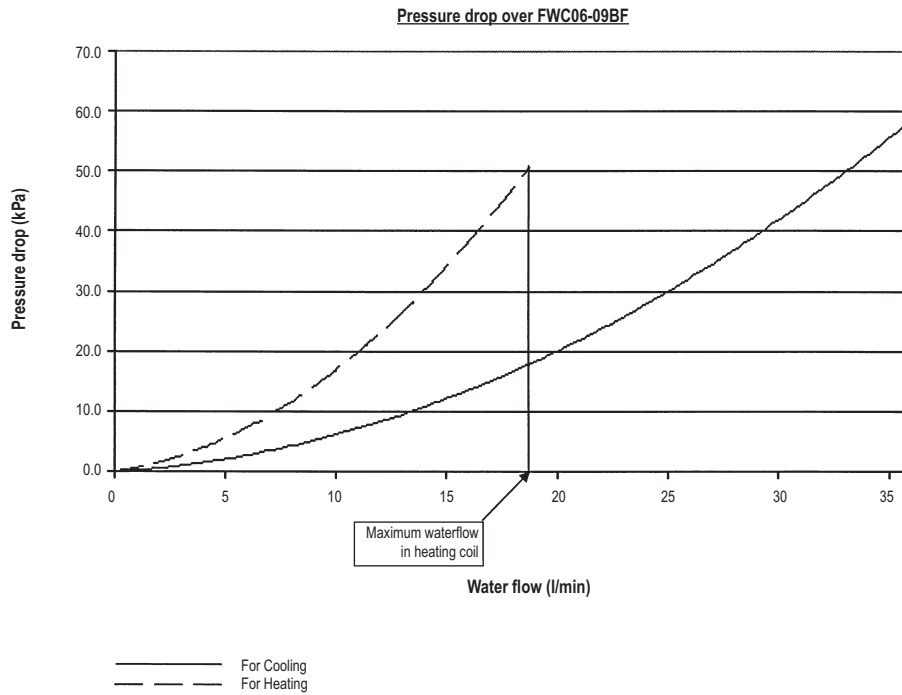

4TW33129-5

NOTES

1. This graph can be used to calculate the pressure drop over the fan coil unit. The pressure drop over the valve is not included.



Daikin's unique position as a manufacturer of air conditioning equipment, compressors and refrigerants has led to its close involvement in environmental issues. For several years Daikin has had the intention to become a leader in the provision of products that have limited impact on the environment. This challenge demands the eco design and development of a wide range of products and an energy management system, resulting in energy conservation and a reduction of waste.



The present publication is drawn up by way of information only and does not constitute an offer binding upon Daikin Europe N.V. Daikin Europe N.V. has compiled the content of this publication to the best of its knowledge. No express or implied warranty is given for the completeness, accuracy, reliability or fitness for particular purpose of its content and the products and services presented therein. Specifications are subject to change without prior notice. Daikin Europe N.V. explicitly rejects any liability for any direct or indirect damage, in the broadest sense, arising from or related to the use and/or interpretation of this publication. All content is copyrighted by Daikin Europe N.V.



Daikin Europe N.V. is participating in the EUROVENT Certification Programme. Products are as listed in the EUROVENT Directory of Certified Products.

